

The μA733M is obsolete and no longer supplied.

- 200-MHz Bandwidth
- 250-kΩ Input Resistance
- Selectable Nominal Amplification of 10, 100, or 400
- No Frequency Compensation Required

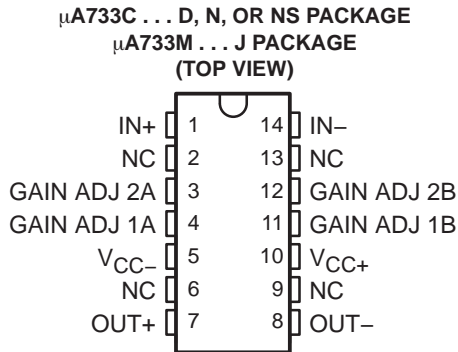

NC — No internal connection

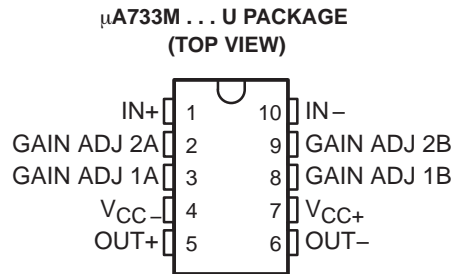

### description/ordering information

The μA733 is a monolithic two-stage video amplifier with differential inputs and differential outputs. Internal series-shunt feedback provides wide bandwidth, low phase distortion, and excellent gain stability. Emitter-follower outputs enable the device to drive capacitive loads, and all stages are current-source biased to obtain high common-mode and supply-voltage rejection ratios.

Fixed differential amplification of 10 V/V, 100 V/V, or 400 V/V may be selected without external components, or amplification may be adjusted from 10 V/V to 400 V/V by the use of a single external resistor connected between 1A and 1B. No external frequency-compensating components are required for any gain option.

The device is particularly useful in magnetic-tape or disc-file systems using phase or NRZ encoding and in high-speed thin-film or plated-wire memories. Other applications include general-purpose video and pulse amplifiers where wide bandwidth, low phase shift, and excellent gain stability are required.

The μA733C is characterized for operation from 0°C to 70°C; the μA733M is characterized for operation over the full military temperature range of –55°C to 125°C.

### ORDERING INFORMATION

TA	PACKAGE†		ORDERABLE PART NUMBER	TOP-SIDE MARKING
0°C to 70°C	P-DIP (N)	Tube of 25	UA733CN	UA733CN
		Tube of 50	UA733CD	UA733C
	SOIC (D)	Reel of 2500	UA733CDR	
		SOP (NS)	Reel of 2000	UA733CNSR

† Package drawings, standard packing quantities, thermal data, symbolization, and PCB design guidelines are available at [www.ti.com/sc/package](http://www.ti.com/sc/package).



Please be aware that an important notice concerning availability, standard warranty, and use in critical applications of Texas Instruments semiconductor products and disclaimers thereto appears at the end of this data sheet.

PRODUCTION DATA information is current as of publication date. Products conform to specifications per the terms of Texas Instruments standard warranty. Production processing does not necessarily include testing of all parameters.



POST OFFICE BOX 655303 • DALLAS, TEXAS 75265

Copyright © 2004, Texas Instruments Incorporated

# $\mu$ A733C, $\mu$ A733M DIFFERENTIAL VIDEO AMPLIFIERS

The  $\mu$ A733M is obsolete  
and no longer supplied.

SLFS027B – NOVEMBER 1970 – REVISED MAY 2004

## symbol

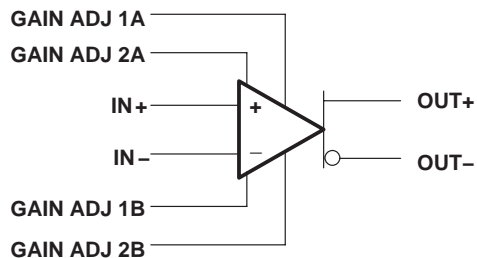

## schematic

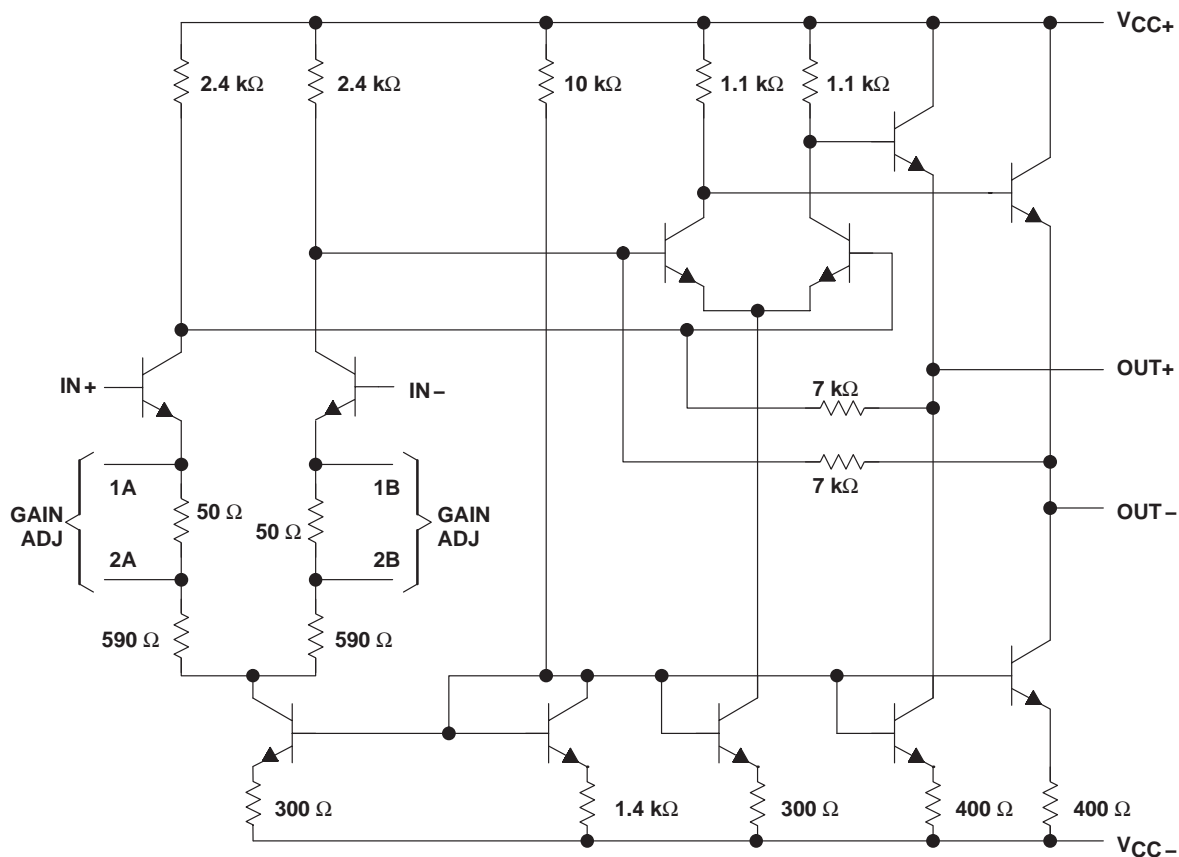

Component values shown are nominal.

The  $\mu$ A733M is obsolete and no longer supplied.

$\mu$ A733C,  $\mu$ A733M  
DIFFERENTIAL VIDEO AMPLIFIERS

SLFS027B – NOVEMBER 1970 – REVISED MAY 2004

absolute maximum ratings over operating free-air temperature range (unless otherwise noted)<sup>†</sup>

	$\mu$ A733C	$\mu$ A733M	UNIT	
Supply voltage $V_{CC+}$ (see Note 1)	8	8	V	
Supply voltage $V_{CC-}$ (see Note 1)	- 8	- 8	V	
Differential input voltage	$\pm 5$	$\pm 5$	V	
Common-mode input voltage	$\pm 6$	$\pm 6$	V	
Output current	10	10	mA	
Continuous total power dissipation	See Dissipation Rating Table			
Package thermal impedance, $\theta_{JA}$ (see Notes 2 and 3)	D package	86	°C/W	
	N package	80		
	NS package	76		
Maximum junction temperature, $T_J$	150		°C	
Lead temperature 1,6 mm (1/16 inch) from case for 60 seconds	J or U package		300	°C
Storage temperature range, $T_{stg}$	- 65 to 150	- 65 to 150	°C	

<sup>†</sup> Stresses beyond those listed under absolute maximum ratings may cause permanent damage to the device. This is a stress rating only, and functional operation of the device at these or any other conditions beyond those indicated in the recommended operating conditions section of this specification is not implied. Exposure to absolute-maximum-rated conditions for extended periods may affect device reliability.

- NOTES:
1. All voltage values, except differential input voltages, are with respect to the midpoint between  $V_{CC+}$  and  $V_{CC-}$ .
  2. Maximum power dissipation is a function of  $T_J(\max)$ ,  $\theta_{JA}$ , and  $T_A$ . The maximum allowable power dissipation at any allowable ambient temperature is  $PD = (T_J(\max) - T_A)/\theta_{JA}$ . Operating at the absolute maximum  $T_J$  of 150°C can affect reliability.
  3. The package thermal impedance is calculated in accordance with JESD 51-7.

DISSIPATION RATING TABLE

PACKAGE	$T_A \leq 25^\circ\text{C}$ POWER RATING	DERATING FACTOR	DERATE ABOVE $T_A$	$T_A = 70^\circ\text{C}$ POWER RATING	$T_A = 125^\circ\text{C}$ POWER RATING
J ( $\mu$ A733M)	500 mW	11.0 mW/°C	104°C	500 mW	269 mW

# μA733C, μA733M DIFFERENTIAL VIDEO AMPLIFIERS

The μA733M is obsolete  
and no longer supplied.

SLFS027B – NOVEMBER 1970 – REVISED MAY 2004

## electrical characteristics, $V_{CC\pm} = \pm 6\text{ V}$ , $T_A = 25^\circ\text{C}$

PARAMETER	FIGURE	TEST CONDITIONS	GAIN OPTION†	μA733C			μA733M			UNIT
				MIN	TYP	MAX	MIN	TYP	MAX	
A <sub>VD</sub>	1	V <sub>OD</sub> = 1 V	1	250	400	600	300	400	500	V/V
			2	80	100	120	90	100	110	
			3	8	10	12	9	10	11	
BW	2	R <sub>S</sub> = 50 Ω	1	50			50			MHz
			2	90			90			
			3	200			200			
I <sub>IO</sub>			Any	0.4		5	0.4		3	μA
I <sub>IB</sub>			Any	9		30	9		20	μA
V <sub>ICR</sub>	1		Any	±1			±1			V
V <sub>OC</sub>	1		Any	2.4	2.9	3.4	2.4	2.9	3.4	V
V <sub>OO</sub>	1		1	0.6		1.5	0.6		1.5	V
			2 & 3	0.35		1.5	0.35		1	
V <sub>OPP</sub>	1		Any	3		4.7	3		4.7	V
r <sub>i</sub>	3	V <sub>OD</sub> ≤ 1 V	1	4			4			kΩ
			2	10	24		20	24		
			3	250			250			
r <sub>o</sub>				20			20			Ω
C <sub>i</sub>	3	V <sub>OD</sub> ≤ 1 V	2	2			2			pF
CMRR	4	V <sub>IC</sub> = ±1 V, f ≤ 100 kHz	2	60	86		60	86		dB
		V <sub>IC</sub> = ±1 V, f = 5 MHz	2	70			70			
k <sub>SVR</sub>	1	ΔV <sub>CC±</sub> = ±0.5 V	2	50	70		50	70		dB
V <sub>n</sub>	5	BW = 1 kHz to 10 MHz	Any	12			12			μV
t <sub>pd</sub>	2	R <sub>S</sub> = 50 Ω, Output voltage step = 1 V	1	7.5			7.5			ns
			2	6.0	10		6.0	10		
			3	3.6			3.6			
t <sub>r</sub>	2	R <sub>S</sub> = 50 Ω, Output voltage step = 1 V	1	10.5			10.5			ns
			2	4.5	12		4.5	10		
			3	2.5			2.5			
I <sub>sink(max)</sub>			Any	2.5	3.6		2.5	3.6		mA
I <sub>CC</sub>		No load, No signal	Any	16		24	16		24	mA

† The gain option is selected as follows:

Gain Option 1: Gain-adjust pin 1A is connected to pin 1B, and pins 2A and 2B are open.

Gain Option 2: Gain-adjust pin 1A and pin 1B are open, pin 2A is connected to pin 2B.

Gain Option 3: All four gain-adjust pins are open.



The  $\mu$ A733M is obsolete  
and no longer supplied.

$\mu$ A733C,  $\mu$ A733M  
DIFFERENTIAL VIDEO AMPLIFIERS

SLFS027B – NOVEMBER 1970 – REVISED MAY 2004

electrical characteristics,  $V_{CC\pm} = \pm 6$  V,  $T_A = 0^\circ\text{C}$  to  $70^\circ\text{C}$  for  $\mu$ A733C,  $-55^\circ\text{C}$  to  $125^\circ\text{C}$  for  $\mu$ A733M

PARAMETER	FIGURE	TEST CONDITIONS	GAIN OPTION†	$\mu$ A733C		$\mu$ A733M		UNIT	
				MIN	MAX	MIN	MAX		
$A_{VD}$	Large-signal differential voltage amplification	1	$V_{OD} = 1$ V	1	250	600	200	600	V/V
				2	80	120	80	120	
				3	8	12	8	12	
$I_{IO}$	Input offset current			Any		6		5	$\mu$ A
$I_{IB}$	Input bias current			Any		40		40	$\mu$ A
$V_{ICR}$	Common-mode input voltage range	1		Any	$\pm 1$		$\pm 1$		V
$V_{OO}$	Output offset voltage	1		1		1.5		1.5	V
				2 & 3		1.5		1.2	
$V_{OPP}$	Maximum peak-to-peak output voltage swing	1		Any	2.8		2.5		V
$r_i$	Input resistance	3	$V_{OD} \leq 1$ V	2	8		8		k $\Omega$
CMRR	Common-mode rejection ratio	4	$V_{IC} = +1$ V, $f \leq 100$ kHz	2	50		50		dB
$k_{SVR}$	Supply voltage rejection ratio ( $\Delta V_{CC}/\Delta V_{IO}$ )	1	$\Delta V_{CC\pm} = \pm 0.5$ V	2	50		50		dB
$I_{sink(max)}$	Maximum output sink current			Any	2.5		2.2		mA
$I_{CC}$	Supply current		No load, No signal	Any		27		27	mA

† The gain option is selected as follows:

- Gain Option 1: Gain-adjust pin 1A is connected to pin 1B, and pins 2A and 2B are open.
- Gain Option 2: Gain-adjust pin 1A and pin 1B are open, pin 2A is connected to pin 2B.
- Gain Option 3: All four gain-adjust pins are open.

**PARAMETER MEASUREMENT INFORMATION**

**test circuits**

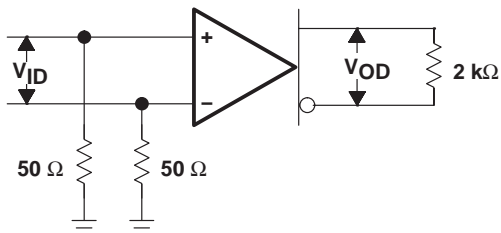

**Figure 1**

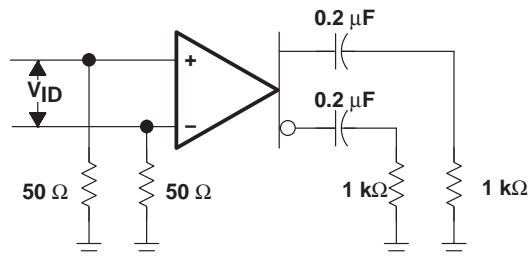

**Figure 2**

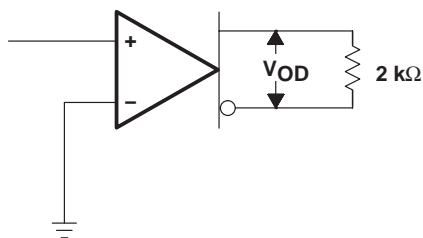

**Figure 3**

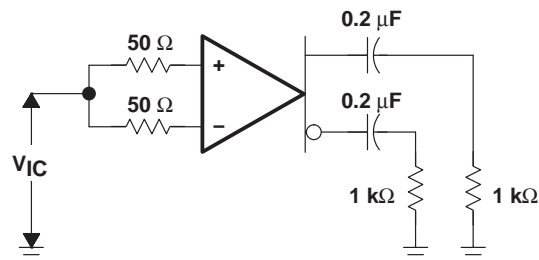

**Figure 4**

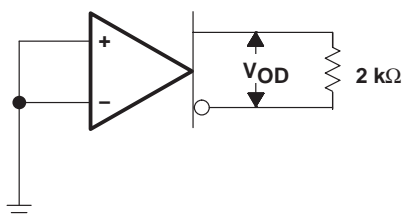

**Figure 5**

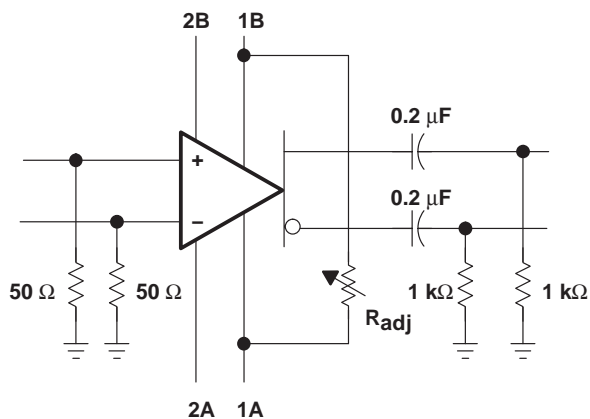

**VOLTAGE AMPLIFICATION ADJUSTMENT**

**Figure 6**

TYPICAL CHARACTERISTICS

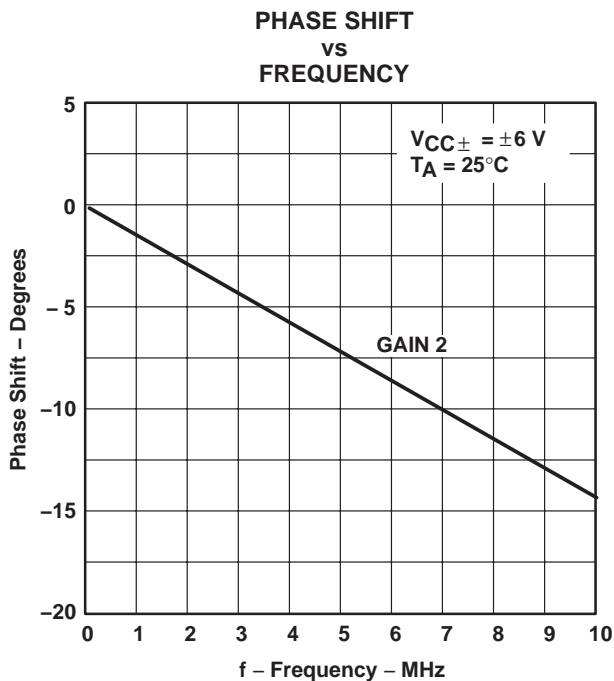

Figure 7

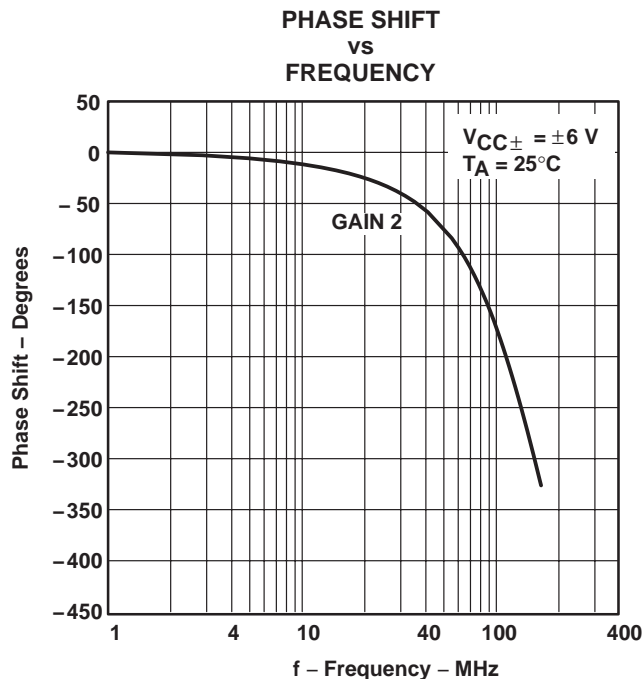

Figure 8

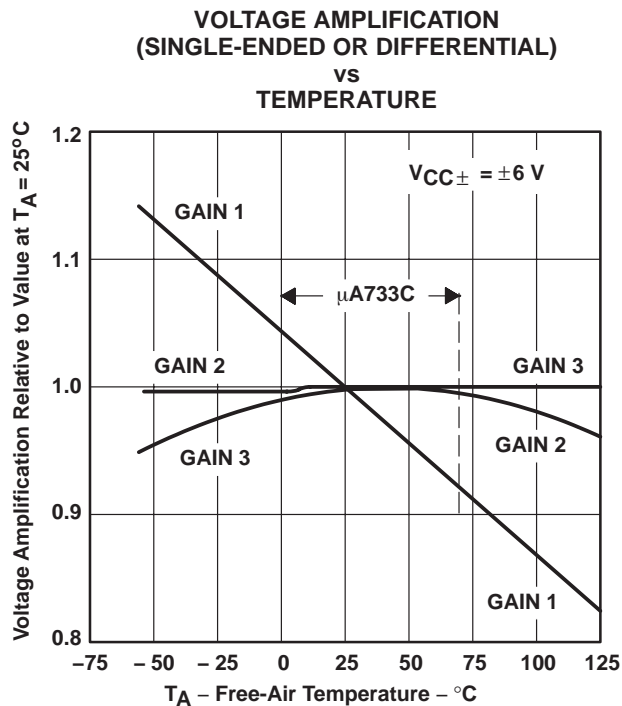

Figure 9

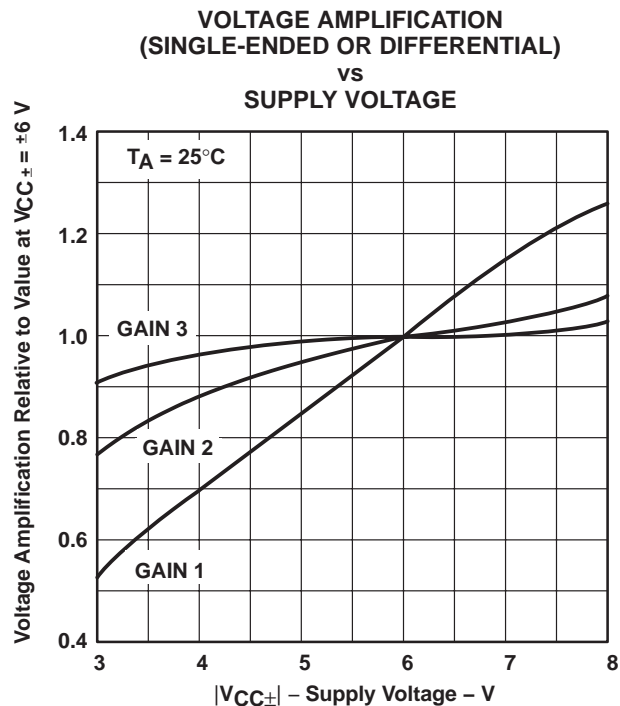
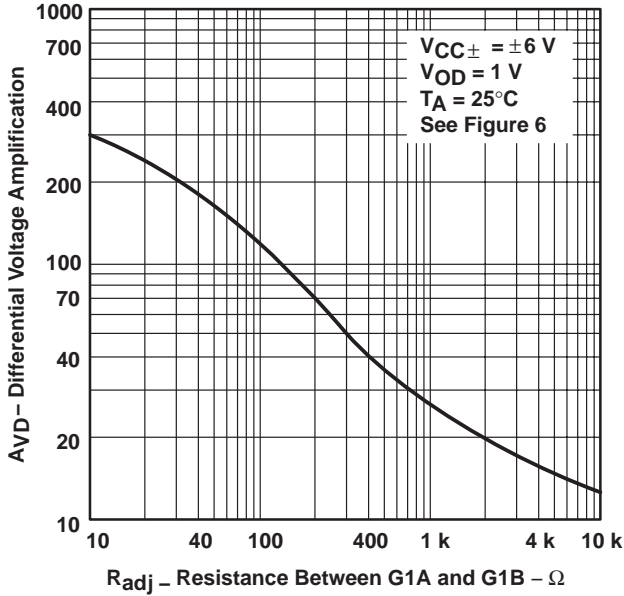

Figure 10

**TYPICAL CHARACTERISTICS**

**DIFFERENTIAL VOLTAGE AMPLIFICATION  
 vs  
 RESISTANCE BETWEEN G1A AND G1B**



**Figure 11**

**SINGLE-ENDED VOLTAGE AMPLIFICATION  
 vs  
 FREQUENCY**

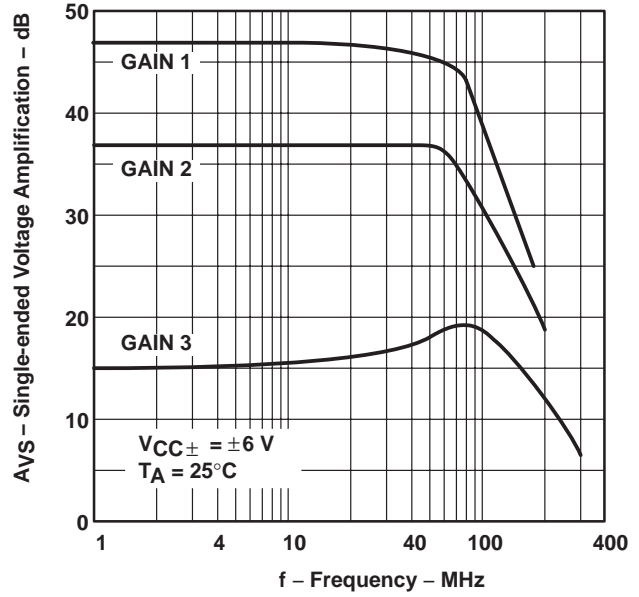

**Figure 12**

**SUPPLY CURRENT  
 vs  
 FREE-AIR TEMPERATURE**

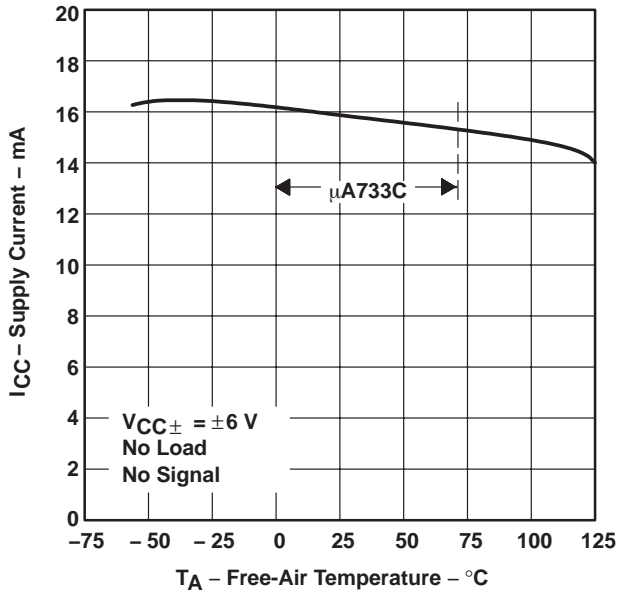

**Figure 13**

**SUPPLY CURRENT  
 vs  
 SUPPLY VOLTAGE**

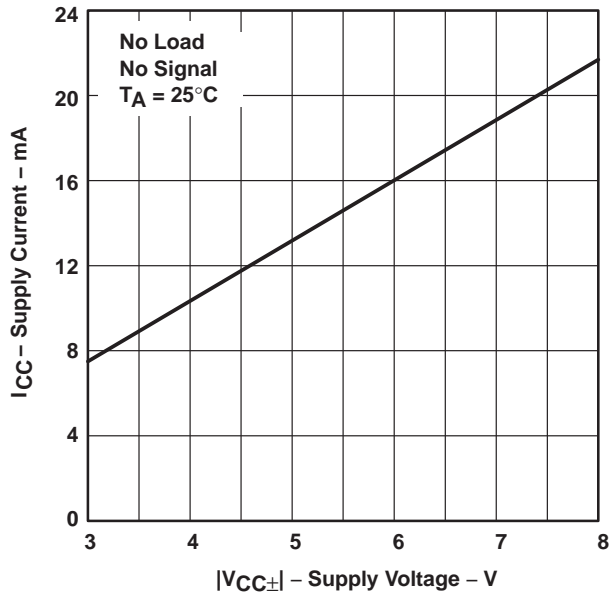

**Figure 14**



TYPICAL CHARACTERISTICS

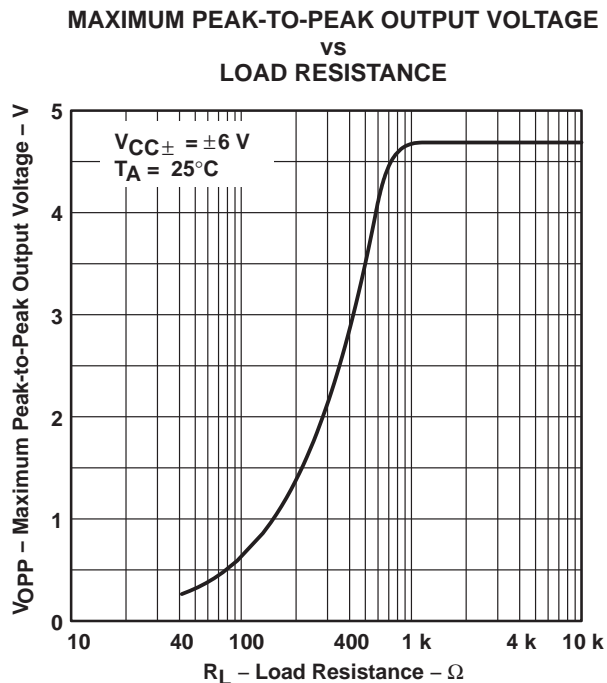

Figure 15

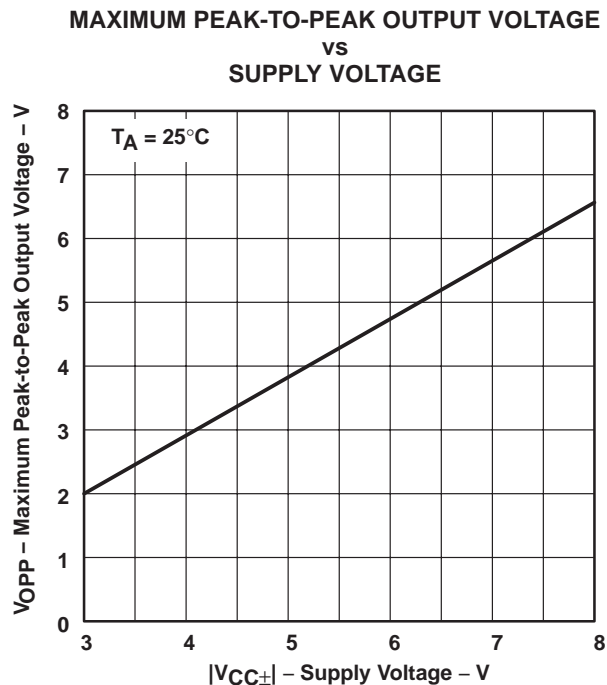

Figure 16

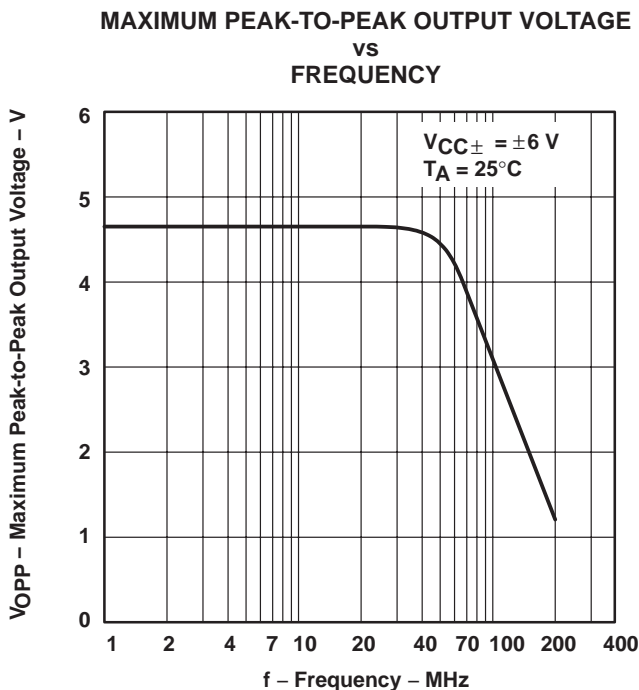

Figure 17

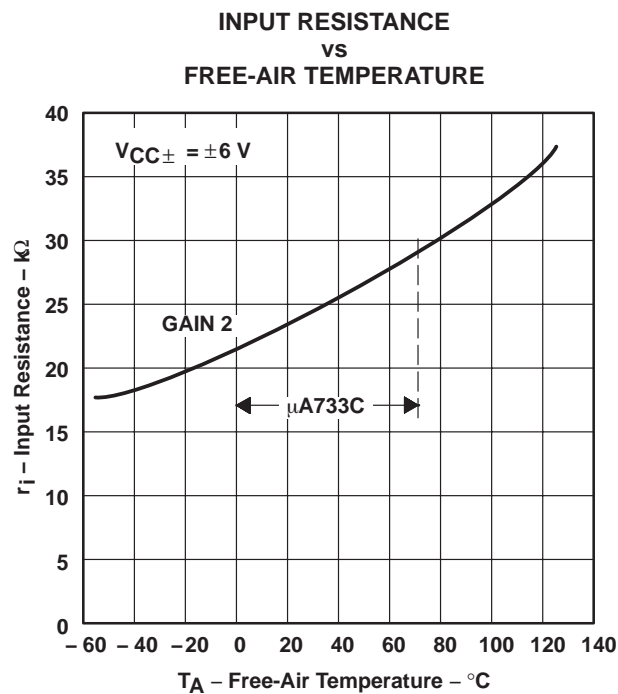

Figure 18

J (R-GDIP-T\*\*)

14 LEADS SHOWN

CERAMIC DUAL IN-LINE PACKAGE



DIM \ PINS **	14	16	18	20
A	0.300 (7,62) BSC	0.300 (7,62) BSC	0.300 (7,62) BSC	0.300 (7,62) BSC
B MAX	0.785 (19,94)	.840 (21,34)	0.960 (24,38)	1.060 (26,92)
B MIN	—	—	—	—
C MAX	0.300 (7,62)	0.300 (7,62)	0.310 (7,87)	0.300 (7,62)
C MIN	0.245 (6,22)	0.245 (6,22)	0.220 (5,59)	0.245 (6,22)



4040083/F 03/03

- NOTES:
- All linear dimensions are in inches (millimeters).
  - This drawing is subject to change without notice.
  - This package is hermetically sealed with a ceramic lid using glass frit.
  - Index point is provided on cap for terminal identification only on press ceramic glass frit seal only.
  - Falls within MIL STD 1835 GDIP1-T14, GDIP1-T16, GDIP1-T18 and GDIP1-T20.

U (S-GDFP-F10)

CERAMIC DUAL FLATPACK

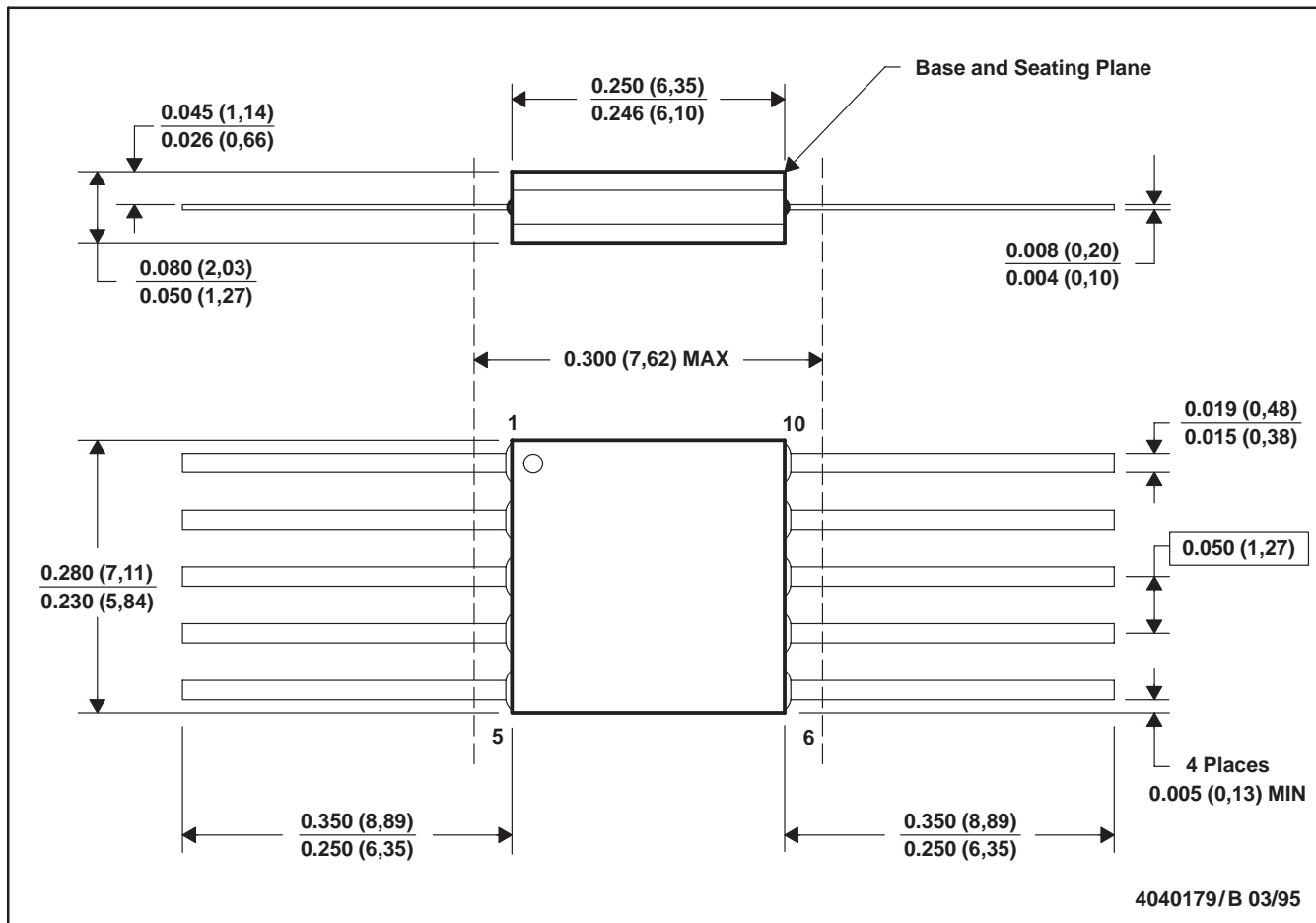

- NOTES: A. All linear dimensions are in inches (millimeters).  
 B. This drawing is subject to change without notice.  
 C. This package can be hermetically sealed with a ceramic lid using glass frit.  
 D. Index point is provided on cap for terminal identification only.  
 E. Falls within MIL STD 1835 GDFP1-F10 and JEDEC MO-092AA

FK (S-CQCC-N\*\*)

LEADLESS CERAMIC CHIP CARRIER

28 TERMINAL SHOWN



- NOTES:
- A. All linear dimensions are in inches (millimeters).
  - B. This drawing is subject to change without notice.
  - C. This package can be hermetically sealed with a metal lid.
  - D. The terminals are gold plated.
  - E. Falls within JEDEC MS-004

N (R-PDIP-T\*\*)

PLASTIC DUAL-IN-LINE PACKAGE

16 PINS SHOWN



4040049/E 12/2002

- NOTES:
- A. All linear dimensions are in inches (millimeters).
  - B. This drawing is subject to change without notice.
  - $\triangle C$  Falls within JEDEC MS-001, except 18 and 20 pin minimum body length (Dim A).
  - $\triangle D$  The 20 pin end lead shoulder width is a vendor option, either half or full width.

D (R-PDSO-G14)

PLASTIC SMALL-OUTLINE PACKAGE



- NOTES:
- A. All linear dimensions are in inches (millimeters).
  - B. This drawing is subject to change without notice.
  - C. Body dimensions do not include mold flash or protrusion not to exceed 0.006 (0,15).
  - D. Falls within JEDEC MS-012 variation AB.

# MECHANICAL DATA

NS (R-PDSO-G\*\*)

PLASTIC SMALL-OUTLINE PACKAGE

14-PINS SHOWN



- NOTES:
- A. All linear dimensions are in millimeters.
  - B. This drawing is subject to change without notice.
  - C. Body dimensions do not include mold flash or protrusion, not to exceed 0,15.

## IMPORTANT NOTICE

Texas Instruments Incorporated and its subsidiaries (TI) reserve the right to make corrections, modifications, enhancements, improvements, and other changes to its products and services at any time and to discontinue any product or service without notice. Customers should obtain the latest relevant information before placing orders and should verify that such information is current and complete. All products are sold subject to TI's terms and conditions of sale supplied at the time of order acknowledgment.

TI warrants performance of its hardware products to the specifications applicable at the time of sale in accordance with TI's standard warranty. Testing and other quality control techniques are used to the extent TI deems necessary to support this warranty. Except where mandated by government requirements, testing of all parameters of each product is not necessarily performed.

TI assumes no liability for applications assistance or customer product design. Customers are responsible for their products and applications using TI components. To minimize the risks associated with customer products and applications, customers should provide adequate design and operating safeguards.

TI does not warrant or represent that any license, either express or implied, is granted under any TI patent right, copyright, mask work right, or other TI intellectual property right relating to any combination, machine, or process in which TI products or services are used. Information published by TI regarding third-party products or services does not constitute a license from TI to use such products or services or a warranty or endorsement thereof. Use of such information may require a license from a third party under the patents or other intellectual property of the third party, or a license from TI under the patents or other intellectual property of TI.

Reproduction of information in TI data books or data sheets is permissible only if reproduction is without alteration and is accompanied by all associated warranties, conditions, limitations, and notices. Reproduction of this information with alteration is an unfair and deceptive business practice. TI is not responsible or liable for such altered documentation.

Resale of TI products or services with statements different from or beyond the parameters stated by TI for that product or service voids all express and any implied warranties for the associated TI product or service and is an unfair and deceptive business practice. TI is not responsible or liable for any such statements.

Following are URLs where you can obtain information on other Texas Instruments products and application solutions:

<b>Products</b>		<b>Applications</b>	
Amplifiers	<a href="http://amplifier.ti.com">amplifier.ti.com</a>	Audio	<a href="http://www.ti.com/audio">www.ti.com/audio</a>
Data Converters	<a href="http://dataconverter.ti.com">dataconverter.ti.com</a>	Automotive	<a href="http://www.ti.com/automotive">www.ti.com/automotive</a>
DSP	<a href="http://dsp.ti.com">dsp.ti.com</a>	Broadband	<a href="http://www.ti.com/broadband">www.ti.com/broadband</a>
Interface	<a href="http://interface.ti.com">interface.ti.com</a>	Digital Control	<a href="http://www.ti.com/digitalcontrol">www.ti.com/digitalcontrol</a>
Logic	<a href="http://logic.ti.com">logic.ti.com</a>	Military	<a href="http://www.ti.com/military">www.ti.com/military</a>
Power Mgmt	<a href="http://power.ti.com">power.ti.com</a>	Optical Networking	<a href="http://www.ti.com/opticalnetwork">www.ti.com/opticalnetwork</a>
Microcontrollers	<a href="http://microcontroller.ti.com">microcontroller.ti.com</a>	Security	<a href="http://www.ti.com/security">www.ti.com/security</a>
		Telephony	<a href="http://www.ti.com/telephony">www.ti.com/telephony</a>
		Video & Imaging	<a href="http://www.ti.com/video">www.ti.com/video</a>
		Wireless	<a href="http://www.ti.com/wireless">www.ti.com/wireless</a>

Mailing Address: Texas Instruments  
Post Office Box 655303 Dallas, Texas 75265