

PROGRAMMABLE PRECISION REFERENCE

DESCRIPTION

The UTC431 is three-terminal adjustable regulator with a guaranteed thermal stability over applicable temperature ranges. The output Voltage may be set to any value between V_{ref} (approximately 2.5V) and 26 V with two external resistors. These devices provide a very sharp turn-on characteristic, making these devices excellent replacement for zener diodes in many applications.

FEATURE

- *Programmable output Voltage to 36V
- *Low dynamic output impedance 0.2Ω
- *Sink current capability of 1.0 to 100mA
- *Equivalent full-range temperature coefficient of 50ppm/°C typical
- *Temperature compensated for operation over full rated operating temperature range
- *Low output noise voltage
- *Fast turn on response

BLOCK DIAGRAM

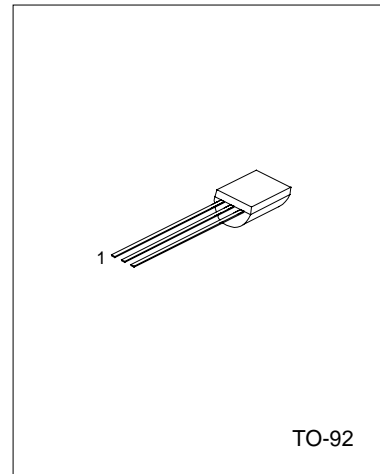
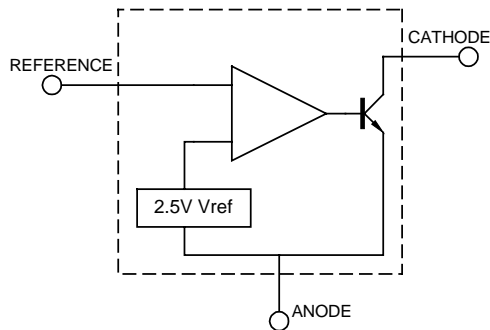

1:Ref; 2:Anode; 3:Cathode

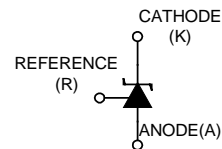

ABSOLUTE MAXIMUM RATINGS (Operating temperature range applies unless otherwise specified)

CHARACTERISTICS	SYMBOL	VALUE	UNITS
Cathode Voltage	V _{KA}	37	V
Cathode Current Range(Continuous)	I _{KA}	-100~+150	mA
Reference Input Current Range	I _{ref}	0.05~+10	mA
Power Dissipation	P _D		
D,Z Suffix Package		770	mW
N Suffix Package		1000	mW
Operating temperature	T _{opr}	0~70	°C
Storage temperature Temperature	T _{stg}	-65~+150 °C	°C

RECOMMENDED OPERATING CONDITIONS

Characteristic	Symbol	Min	Typ	Max	Unit
Cathode Voltage	V _{KA}	V _{REF}		36	V
Cathode Current	I _{KA}	1.0		100	mA

ELECTRICAL CHARACTERISTICS(T_a=25°C, unless otherwise specified)

Characteristic	Symbol	Test conditions	MIN	TYP	MAX	UNIT
Reference Input Voltage	V _{ref}	V _{KA} =V _{REF} , I _{KA} =10mA	2.440	2.495	2.550	V
Deviation of reference Input Voltage Over temperature(note 1)	ΔV _{ref} /ΔT	V _{KA} =V _{REF} , I _{KA} =10mA T _{MIN} ≤T _A ≤T _{MAX}		4.5	17	mV
Ratio of Change in Reference Input Voltage to the Change in Cathode Voltage	ΔV _{ref} /ΔV _{KA}	I _{KA} =10mA ΔV _{KA} =10V~V _{REF}		-1.0	-2.7	mV/V
		ΔV _{KA} =36V~10V		-0.5	-2.0	
Reference Input Current	I _{ref}	I _{KA} =10mA, R ₁ =10kΩ, R ₂ =∞		1.5	4	μA
Deviation of Reference Input Current Over Full Temperature Range	ΔI _{ref} /ΔT	I _{KA} =10mA, R ₁ =10kΩ, R ₂ =∞, T _A =full Temperature		0.4	1.2	μA
Minimum cathode current for regulation	I _{KA} (min)	V _{KA} =V _{REF}		0.45	1.0	mA
Off-state cathode Current	I _{KA} (OFF)	V _{KA} =36V, V _{REF} =0		0.05	1.0	μA
Dynamic Impedance	Z _{KA}	V _{KA} =V _{REF} , I _{KA} =1 to 100mA f≤1.0kHz		0.15	0.5	Ω

Note: T_{MIN}=0°C, T_{MAX}=+70°C

TEST CIRCUITS

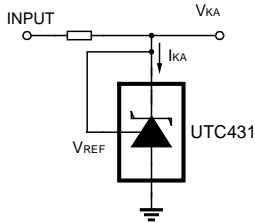

Fig 7 Test Circuit For $V_{KA}=V_{REF}$

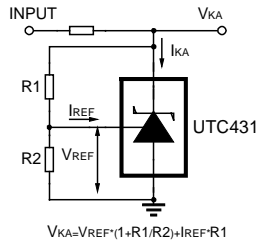

Fig 8 Test Circuit for $V_{KA} \geq V_{REF}$

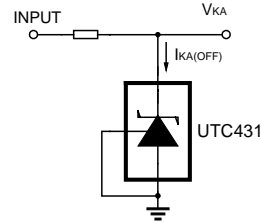

Fig 9 Test Circuit For $I_{KA(OFF)}$

TYPICAL APPLICATION

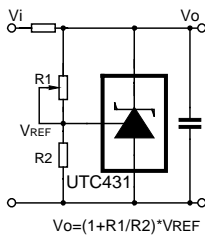

Fig 10 Shutdown Regulator

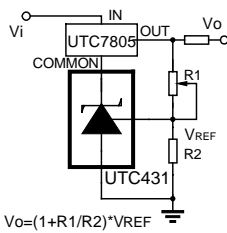

Fig 11 Output Control of a Three-Terminal Fixed Regulator

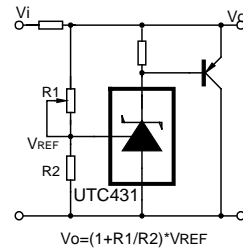

Fig 12 Higher-current Shunt Regulator

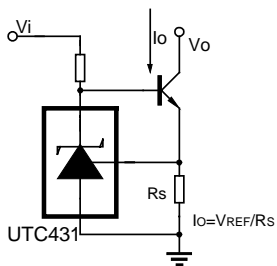

Fig 13 Constant-current Sink

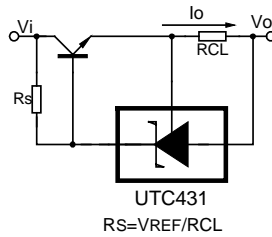
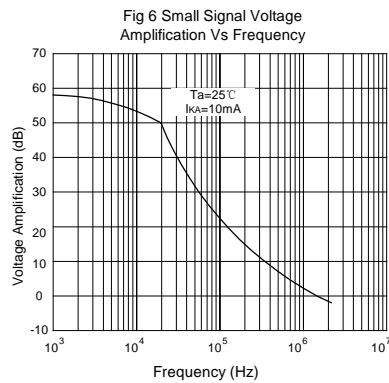
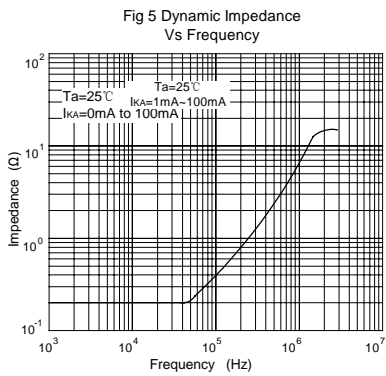
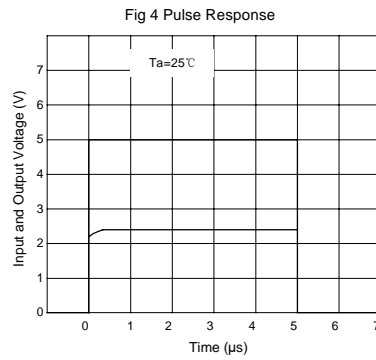
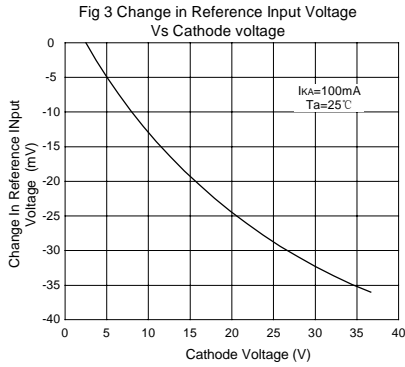
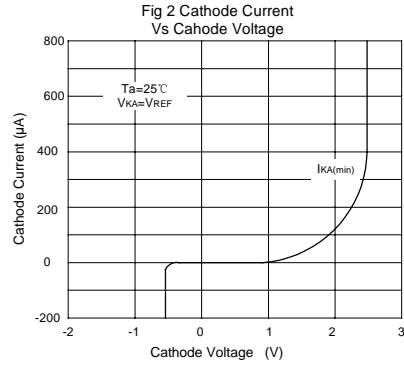
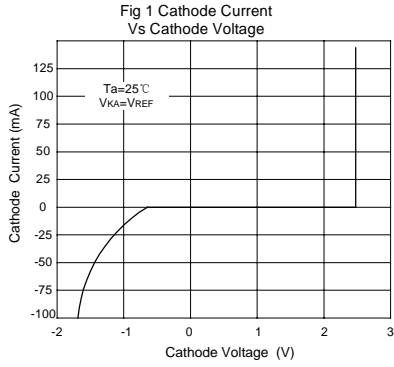

Fig 14 Current Limiting or Current Source

TYPICAL PERFORMANCE CHARACTERISTICS



This datasheet has been downloaded from:

www.DatasheetCatalog.com

Datasheets for electronic components.