

# Cree® XLamp® XM-L LEDs



## PRODUCT DESCRIPTION

The XLamp XM-L LED is the industry’s highest performance, single-die white lighting-class LED. The XLamp XM-L is 20% more efficient than the XLamp XP-G at the same current, and can deliver 1000 lumens with 100 lumens per watt efficacy. The XLamp XM-L LED offers Cree’s industry-leading features: wide viewing angle, symmetrical package, unlimited floor life and electrically neutral thermal path.

XLamp XM-L LEDs can enable LED light into new applications that require tens of thousands of lumens, such as high bay and high-output area lighting. The XM-L is also the ideal choice for lighting applications where high light output and maximum efficacy are required, such as LED light bulbs, outdoor lighting, portable lighting, indoor lighting and solar-powered lighting.

## FEATURES

- Maximum drive current: 3000 mA
- Low thermal resistance: 2.5°C/W
- Maximum junction temperature: 150 °C
- Viewing angle: 125°
- Available in 80 CRI minimum, warm, neutral and cool white
- ANSI-compatible chromaticity bins
- Unlimited floor life at ≤ 30 °C/85% RH
- Reflow solderable - JEDEC J-STD-020C
- Electrically neutral thermal path

## TABLE OF CONTENTS

Flux Characteristics.....	2
Characteristics .....	2
Relative Spectral Power Distribution.....	3
Relative Flux vs. Junction Temperature .....	3
Electrical Characteristics.....	4
Thermal Design .....	4
Relative Flux vs. Current .....	5
Relative Chromaticity vs. Current and Temperature (Cool White).....	5
Relative Chromaticity vs. Current and Temperature (Warm White)...	6
Typical Spatial Distribution.....	7
Reflow Soldering Characteristics ..	8
Notes.....	9
Mechanical Dimensions.....	10
Tape and Reel .....	11
Packaging.....	12

## FLUX CHARACTERISTICS (T<sub>J</sub> = 25 °C)

The following table provides several base order codes for XLamp XM-L LEDs. It is important to note that the base order codes listed here are a subset of the total available order codes for the product family. For more order codes, as well as a complete description of the order-code nomenclature, please consult the XLamp XM-L Binning and Labeling document.

Color	CCT Range		Base Order Codes Min. Luminous Flux @ 700 mA (lm)		Order Code
	Min.	Max.	Group	Flux (lm)	
Cool White	5,000 K	8,300 K	T5	260	XMLAWT-00-0000-0000T5051
			T6	280	XMLAWT-00-0000-0000T6051
Neutral White	3,700 K	5,000 K	T4	240	XMLAWT-00-0000-000LT40E4
			T5	260	XMLAWT-00-0000-000LT50F4
80-CRI White	2,600 K	4,300 K	T2	200	XMLAWT-00-0000-000HT20E7
			T3	220	XMLAWT-00-0000-000HT30F7
Warm White	2,600 K	3,700 K	T2	200	XMLAWT-00-0000-000LT20E7
			T3	220	XMLAWT-00-0000-000LT30F7

### Notes:

- Cree maintains a tolerance of  $\pm 7\%$  on flux and power measurements and  $\pm 2$  on CRI measurements .
- Typical CRI for Cool White (5,000 K – 8,300 K CCT) is 65.
- Typical CRI for Neutral White (3,700 K – 5,000 K CCT) is 75.
- Typical CRI for Warm White (2,600 K – 3,700 K CCT) is 80.
- Minimum CRI for 80-CRI White is 80.

## CHARACTERISTICS

Characteristics	Unit	Minimum	Typical	Maximum
Thermal Resistance, junction to solder point	°C/W		2.5	
Viewing Angle (FWHM)	degrees		125	
Temperature coefficient of voltage	mV/°C		-3.0	
ESD Classification (HBM per Mil-Std-883D)			Class 2	
DC Forward Current	mA			3000
Reverse Voltage	V			5
Forward voltage (@ 700 mA)	V		2.9	3.5
Forward voltage (@ 1500 mA)	V		3.1	
Forward voltage (@ 3000 mA)	V		3.35	
LED Junction Temperature	°C			150

**RELATIVE SPECTRAL POWER DISTRIBUTION**

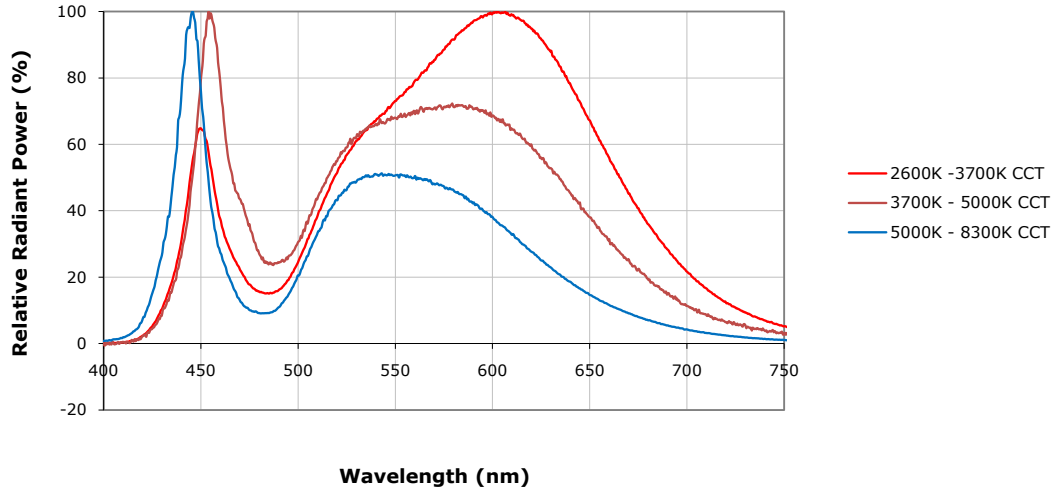

**RELATIVE FLUX VS. JUNCTION TEMPERATURE ( $I_F = 700$  MA)**

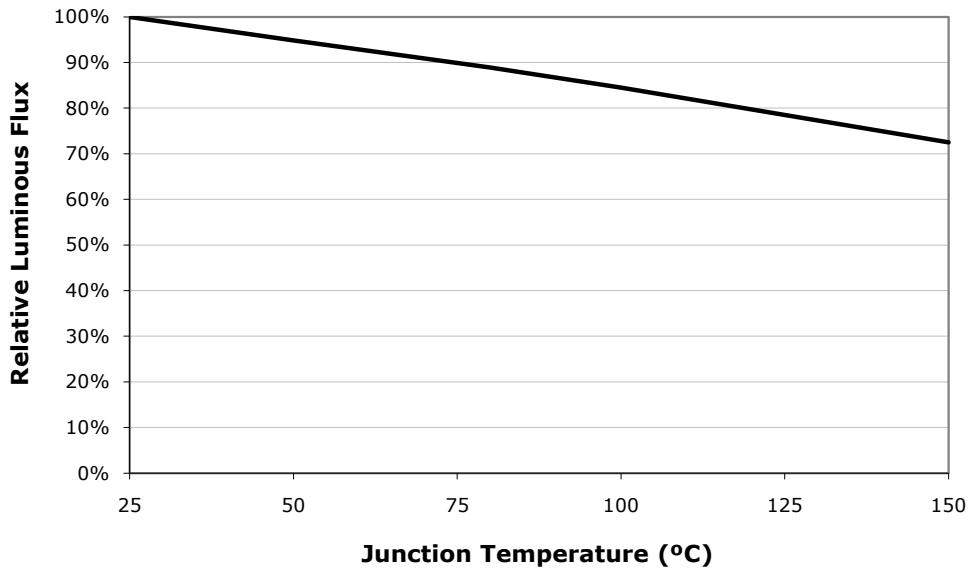

**ELECTRICAL CHARACTERISTICS ( $T_j = 25\text{ }^\circ\text{C}$ )**

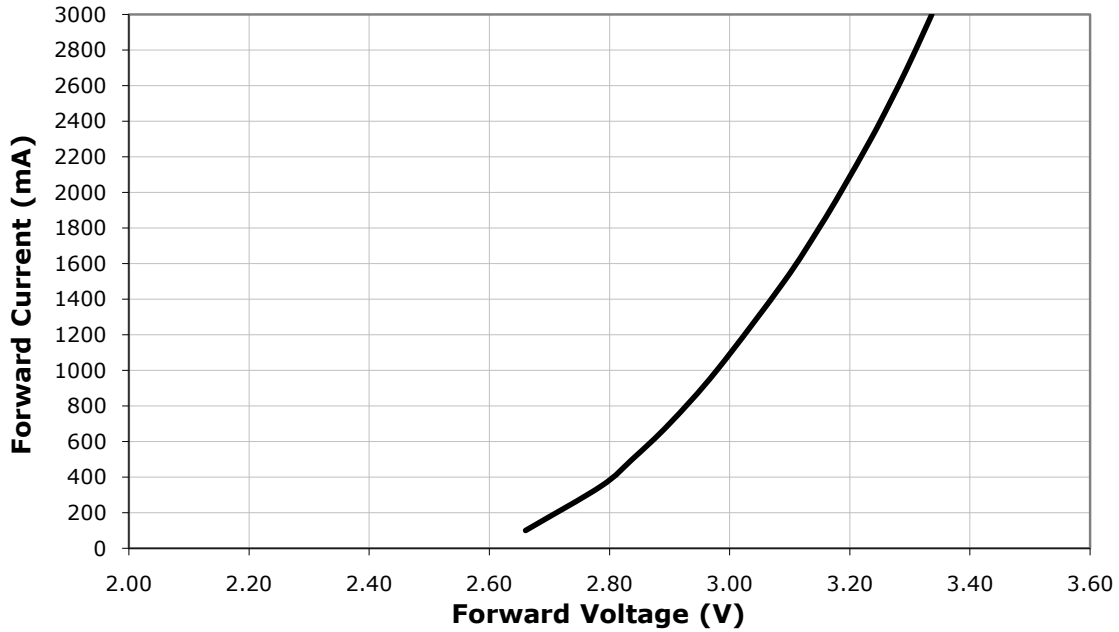

**THERMAL DESIGN**

The maximum forward current is determined by the thermal resistance between the LED junction and ambient. It is crucial for the end product to be designed in a manner that minimizes the thermal resistance from the solder point to ambient in order to optimize lamp life and optical characteristics.

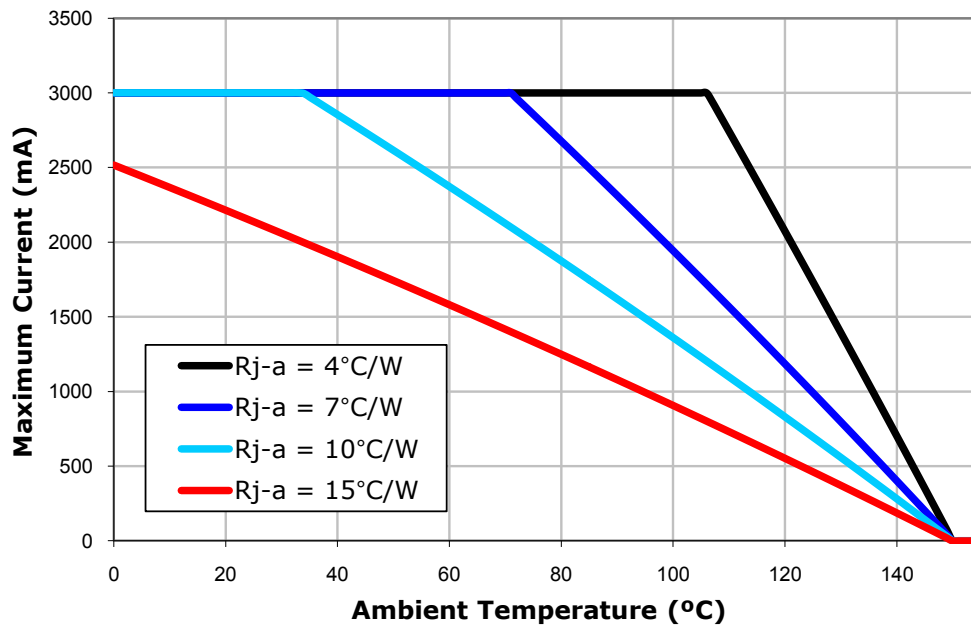

**RELATIVE FLUX VS. CURRENT ( $T_j = 25\text{ }^\circ\text{C}$ )**

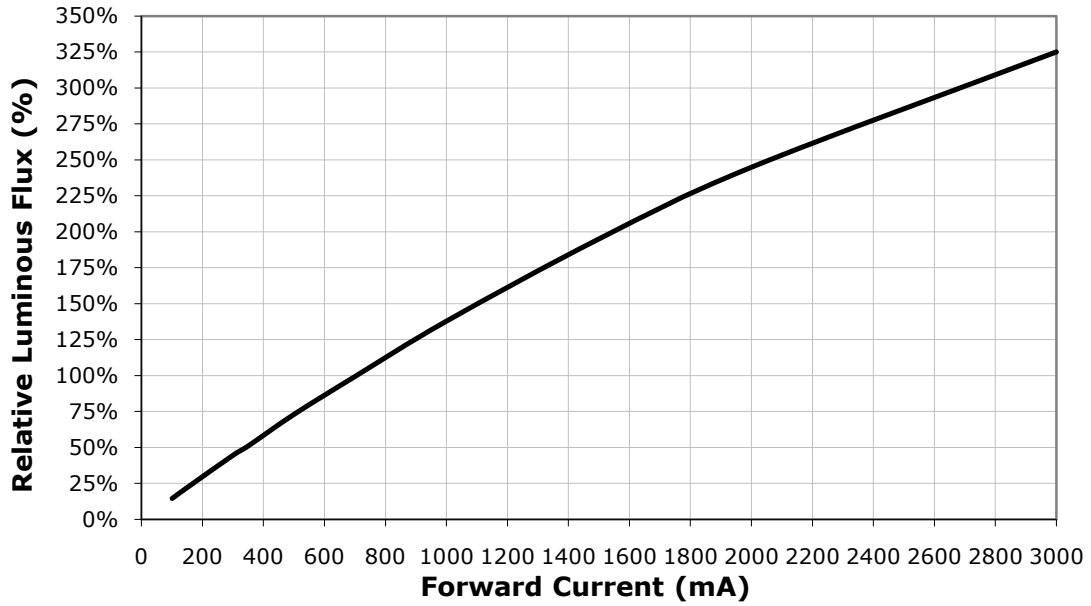

**RELATIVE CHROMATICITY VS. CURRENT AND TEMPERATURE (COOL WHITE)**

Cool White

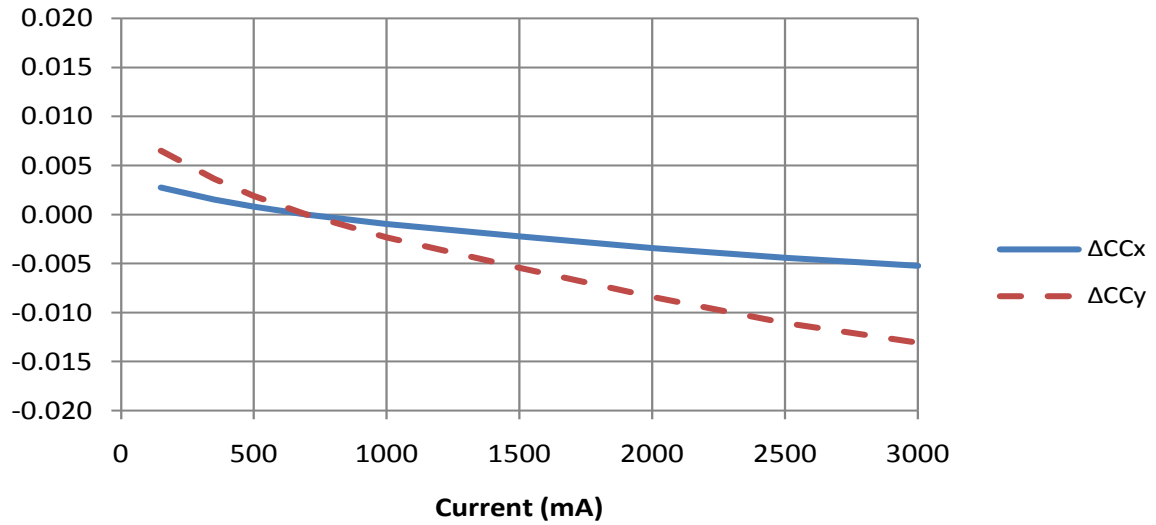

**RELATIVE CHROMATICITY VS. CURRENT AND TEMPERATURE (COOL WHITE)**

Cool White

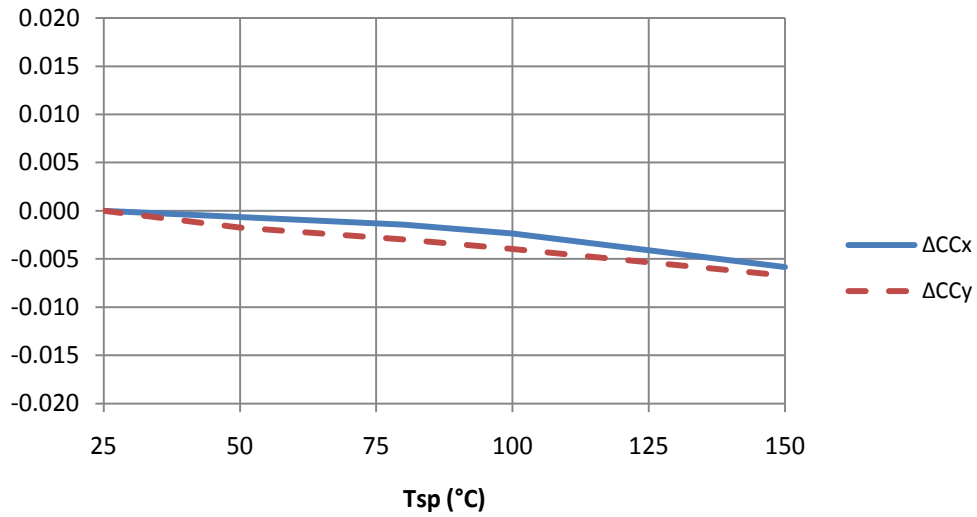

**RELATIVE CHROMATICITY VS. CURRENT AND TEMPERATURE (WARM WHITE)**

Warm White

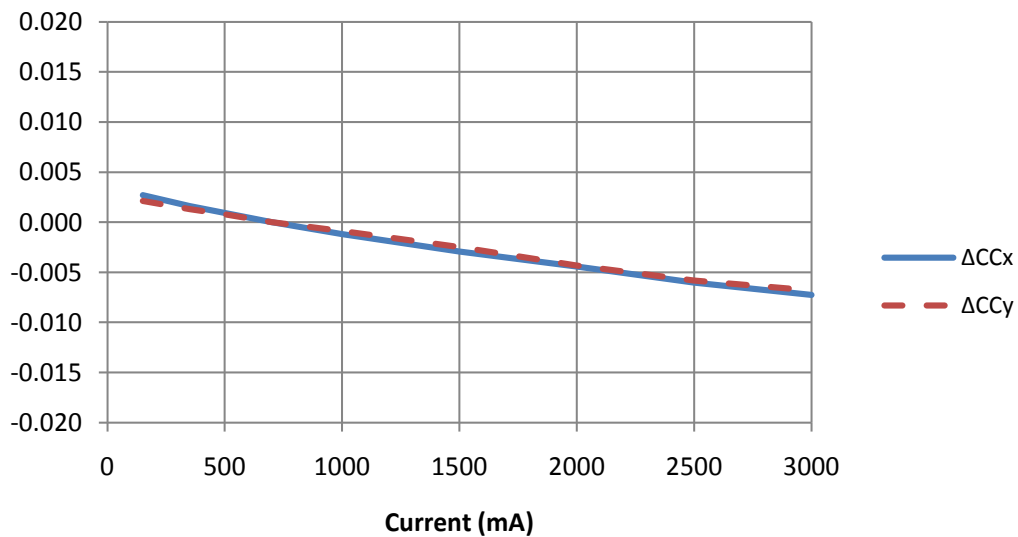

**RELATIVE CHROMATICITY VS. CURRENT AND TEMPERATURE (WARM WHITE)**

Warm White

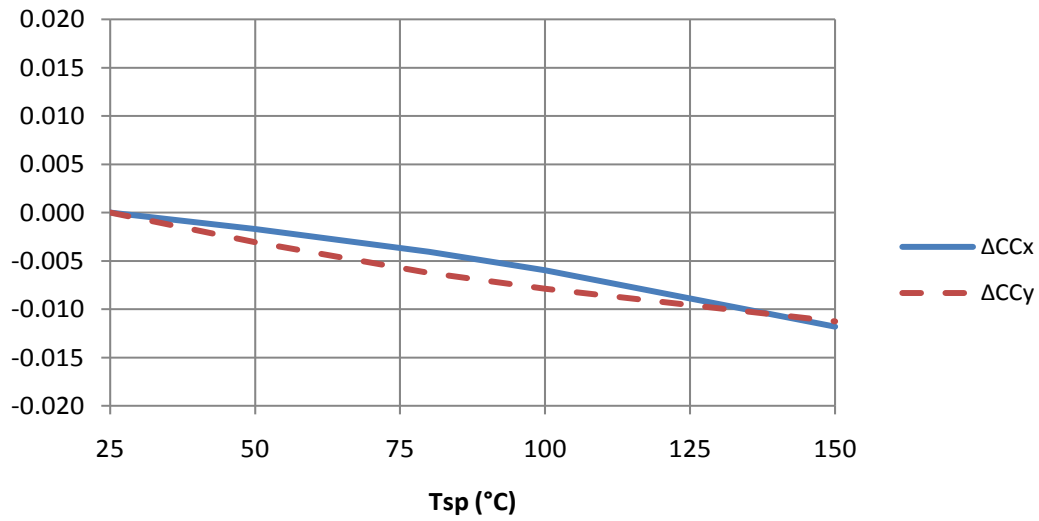

**TYPICAL SPATIAL DISTRIBUTION**

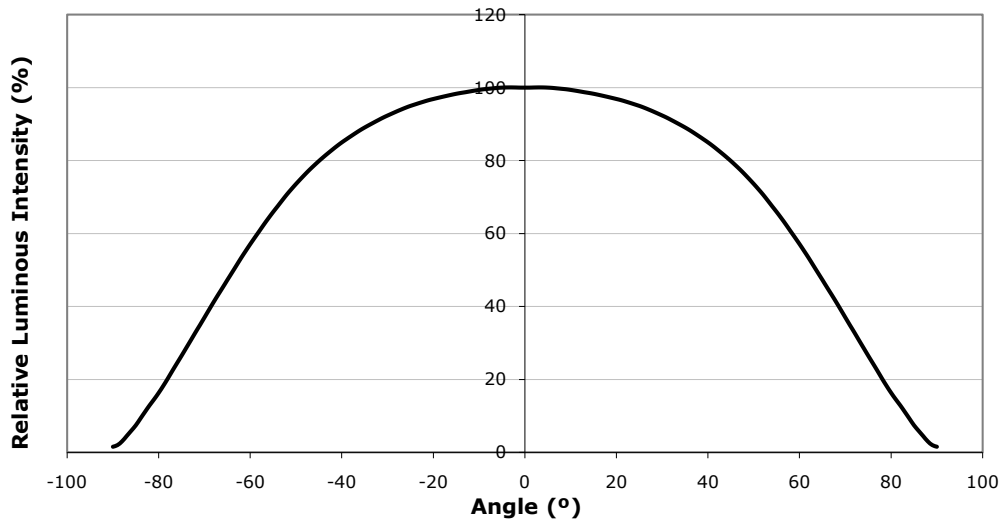

### REFLOW SOLDERING CHARACTERISTICS

In testing, Cree has found XLamp XM-L LEDs to be compatible with JEDEC J-STD-020C, using the parameters listed below. As a general guideline, Cree recommends that users follow the recommended soldering profile provided by the manufacturer of solder paste used.

Note that this general guideline may not apply to all PCB designs and configurations of reflow soldering equipment.

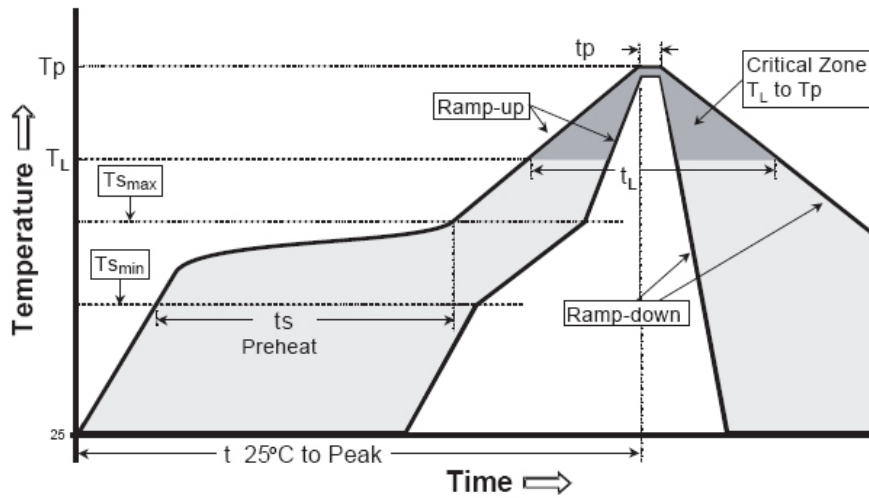

IPC/JEDEC J-STD-020C

Profile Feature	Lead-Based Solder	Lead-Free Solder
Average Ramp-Up Rate ( $T_{s_{max}}$ to $T_p$ )	3 °C/second max.	3 °C/second max.
Preheat: Temperature Min ( $T_{s_{min}}$ )	100 °C	150 °C
Preheat: Temperature Max ( $T_{s_{max}}$ )	150 °C	200 °C
Preheat: Time ( $t_{s_{min}}$ to $t_{s_{max}}$ )	60-120 seconds	60-180 seconds
Time Maintained Above: Temperature ( $T_L$ )	183 °C	217 °C
Time Maintained Above: Time ( $t_L$ )	60-150 seconds	60-150 seconds
Peak/Classification Temperature ( $T_p$ )	215 °C	260 °C
Time Within 5 °C of Actual Peak Temperature ( $t_p$ )	10-30 seconds	20-40 seconds
Ramp-Down Rate	6 °C/second max.	6 °C/second max.
Time 25 °C to Peak Temperature	6 minutes max.	8 minutes max.

Note: All temperatures refer to the topside of the package, measured on the package body surface.



## NOTES

---

### Lumen Maintenance Projections

Cree currently recommends a maximum drive current of 2000 mA for XLamp XM-L white in designs seeking the ENERGY STAR\* 35,000 hour lifetime rating ( $\geq 94.1\%$  luminous flux @ 6000 hours) or 25,000-hour lifetime rating ( $\geq 91.8\%$  luminous flux @ 6000 hours).

Please read the XLamp Long-Term Lumen Maintenance application note for more details on Cree's lumen maintenance testing and forecasting. Please read the XLamp Thermal Management application note for details on how thermal design, ambient temperature, and drive current affect the LED junction temperature.

\* These lifetime ratings are based on the current ENERGY STAR Solid State Lighting Luminaires V1.1 (December 12, 2008) and ENERGY STAR Integral LED Lamps V1.0 (December 3, 2009) lumen maintenance criteria.

### Moisture Sensitivity

In testing, Cree has found XLamp XM-L LEDs to have unlimited floor life in conditions  $\leq 30$  °C/85% relative humidity (RH). Moisture testing included a 168 hour soak at 85 °C/85% RH followed by 3 reflow cycles, with visual and electrical inspections at each stage.

Cree recommends keeping XLamp LEDs in their sealed moisture-barrier packaging until immediately prior to use. Cree also recommends returning any unused LEDs to the resealable moisture-barrier bag and closing the bag immediately after use.

### Vision Advisory Claim

WARNING: Do not look at exposed lamp in operation. Eye injury can result. See LED Eye Safety at [www.cree.com/products/pdf/XLamp\\_EyeSafety.pdf](http://www.cree.com/products/pdf/XLamp_EyeSafety.pdf).

**MECHANICAL DIMENSIONS**

All measurements are  $\pm 0.13$  mm unless otherwise indicated.

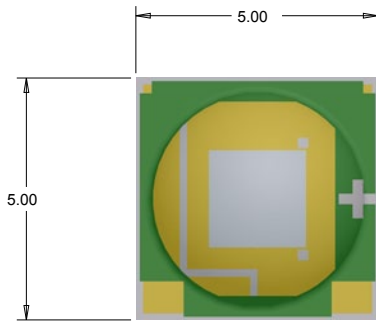

**Top View**

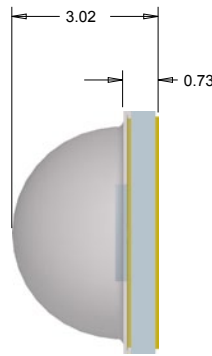

**Side View**

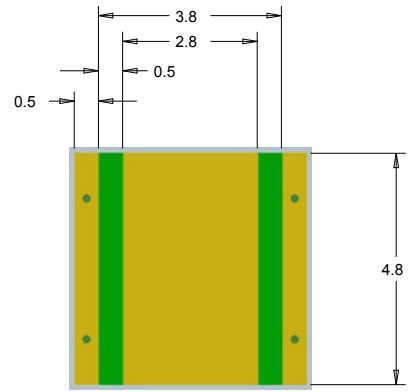

**Bottom View**

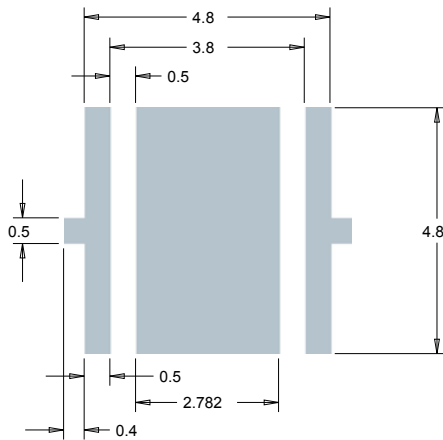

**Recommended PCB Solder Pad**

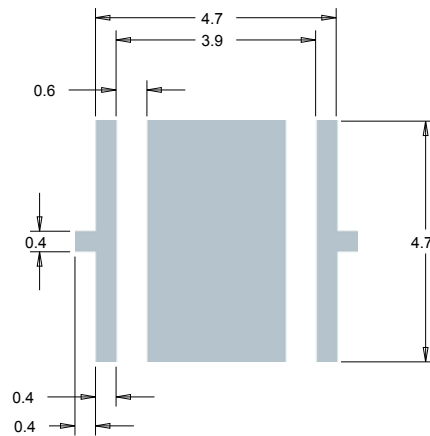

**Recommended Stencil Pattern  
(Shaded Area Is Open)**

**TAPE AND REEL**

All Cree carrier tapes conform to EIA-481D, Automated Component Handling Systems Standard.

All dimensions in mm.

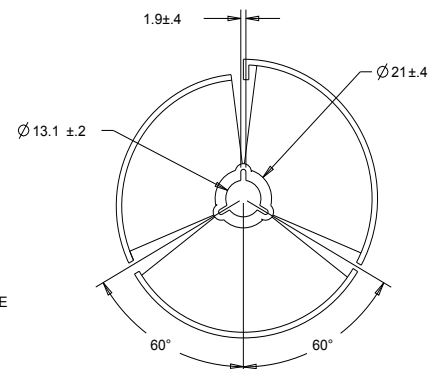
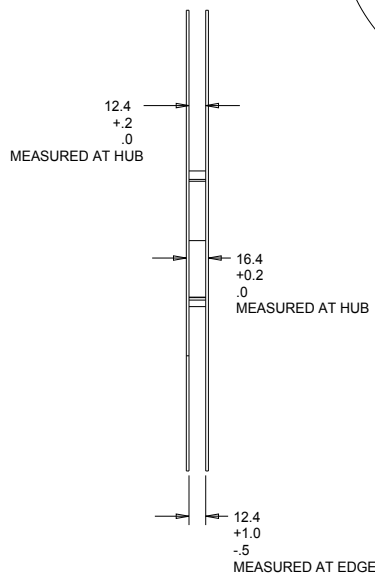
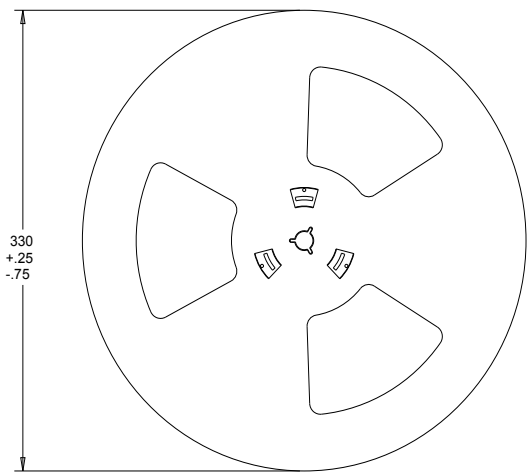
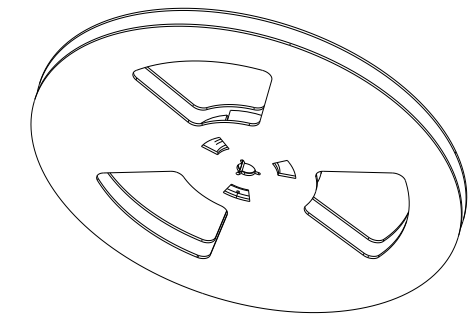
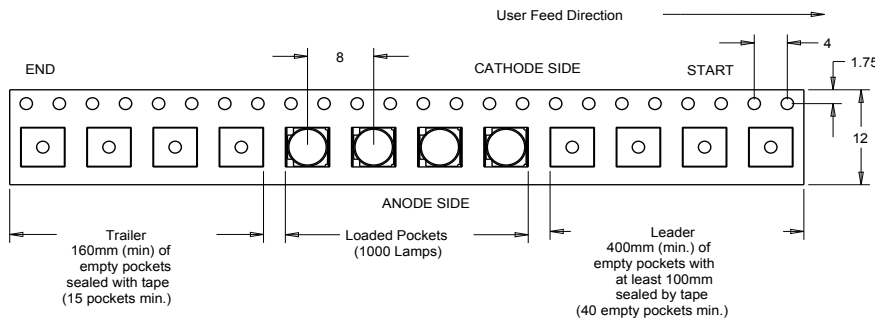
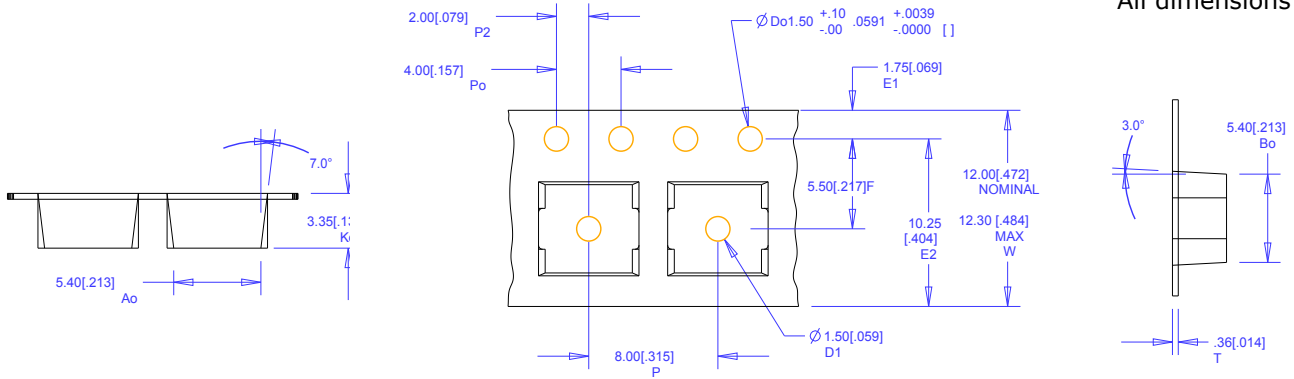

**PACKAGING**

