

2SC4466

Silicon NPN Triple Diffused Planar Transistor (Complement to type 2SA1693)

Application : Audio and General Purpose

■ Absolute maximum ratings (Ta=25°C)

| Symbol | Ratings | Unit |
|------------------|--------------------------|------|
| V _{CB0} | 120 | V |
| V _{CE0} | 80 | V |
| V _{EB0} | 6 | V |
| I _C | 6 | A |
| I _B | 3 | A |
| P _C | 60(T _C =25°C) | W |
| T _J | 150 | °C |
| T _{stg} | -55 to +150 | °C |

■ Electrical Characteristics (Ta=25°C)

| Symbol | Conditions | Ratings | Unit |
|----------------------|---|---------|------|
| I _{CB0} | V _{CB} =120V | 10max | μA |
| I _{EB0} | V _{EB} =6V | 10max | μA |
| V _{(BR)CEO} | I _C =50mA | 80min | V |
| h _{FE} | V _{CE} =4V, I _C =2A | 50min* | |
| V _{CE(sat)} | I _C =2A, I _B =0.2A | 1.5max | V |
| f _r | V _{CE} =12V, I _E =-0.5A | 20typ | MHz |
| COB | V _{CB} =10V, f=1MHz | 110typ | pF |

*h_{FE} Rank O(50to100), P(70to140), Y(90to180)

■ Typical Switching Characteristics (Common Emitter)

| V _{CC} (V) | R _L (Ω) | I _C (A) | V _{BB1} (V) | V _{BB2} (V) | I _{B1} (A) | I _{B2} (A) | t _{on} (μs) | t _{stg} (μs) | t _f (μs) |
|---------------------|--------------------|--------------------|----------------------|----------------------|---------------------|---------------------|----------------------|-----------------------|---------------------|
| 30 | 10 | 3 | 10 | -5 | 0.3 | -0.3 | 0.16typ | 2.60typ | 0.34typ |

External Dimensions MT-100(TO3P)

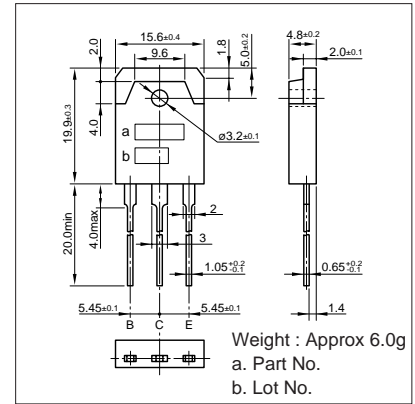

I_C-V_{CE} Characteristics (Typical)

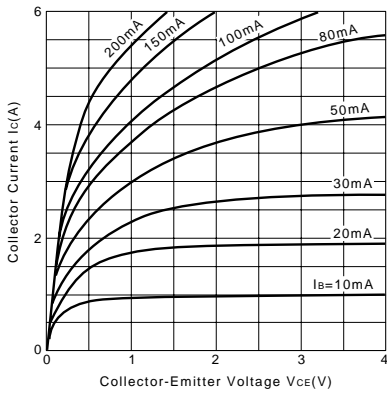

V_{CE(sat)}-I_B Characteristics (Typical)

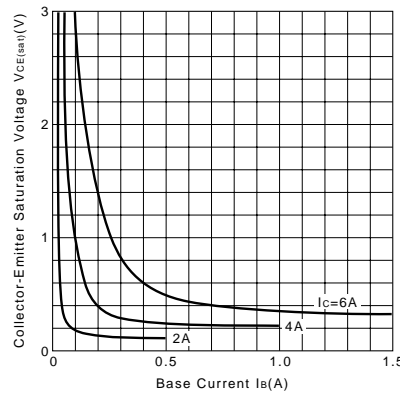

I_C-V_{BE} Temperature Characteristics (Typical)

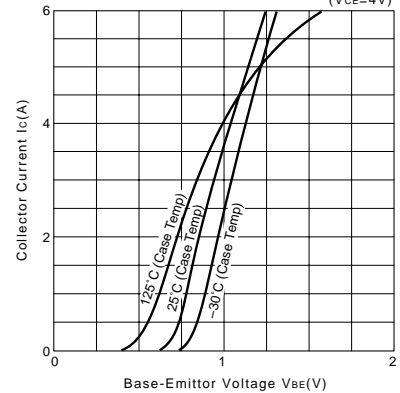

h_{FE}-I_C Characteristics (Typical)

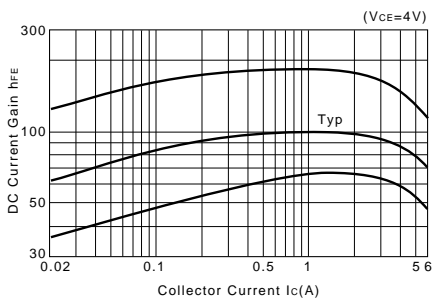

h_{FE}-I_C Temperature Characteristics (Typical)

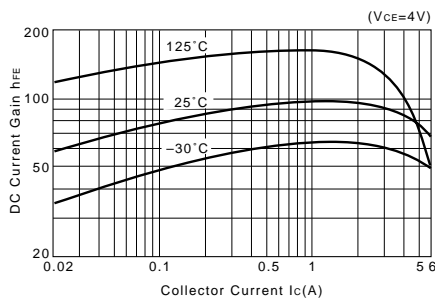

θ_{J-a}-t Characteristics

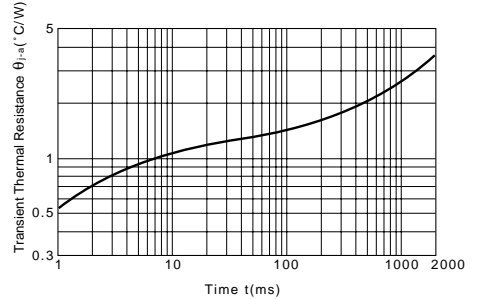

f_r-I_E Characteristics (Typical)

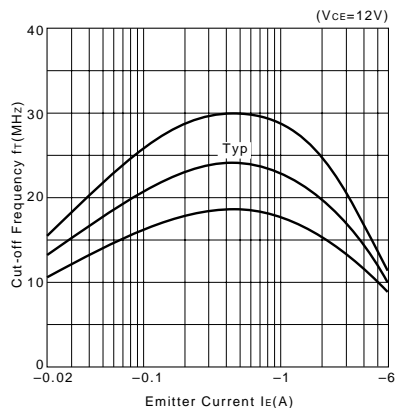

Safe Operating Area (Single Pulse)

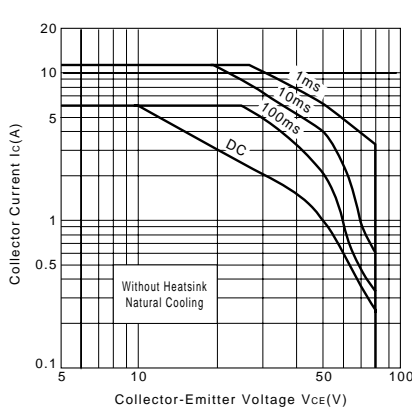

P_C-T_a Derating

