

## »» Features



- High rating miniature PCB Relay.
- UL/CUL、CSA、VDE approved.
- Low power consumption 400mW coil.
- 20A 277VAC/SPDT, 10A 277VAC/DPDT & TV-8 ratings are approved.
- Low profile 15.7mm and high insulation system Class F.
- High CTI 250 material & New Glow Wire Approved. (E version)
- Comply with RoHS-Directive 2002/95/EC.

## »» Type List

### ◆ Standard Type

Terminal style	Contact form	UL Insulation system approval	Designation (provided with)		
			Flux tight	Sealed type	Sealed type washable
PCB terminal	1A (SPNO)	-----	881-1AC-C	881-1AC-V	881-1AC-S
	1C (SPDT)	-----	881-1CC-C	881-1CC-V	881-1CC-S
	2A (DPNO)	-----	881-2AC-C	881-2AC-V	881-2AC-S
	2C (DPDT)	-----	881-2CC-C	881-2CC-V	881-2CC-S
	1A (SPNO)	F	881-1AC-F-C	881-1AC-F-V	881-1AC-F-S
	1C (SPDT)	F	881-1CC-F-C	881-1CC-F-V	881-1CC-F-S
	2A (DPNO)	F	881-2AC-F-C	881-2AC-F-V	881-2AC-F-S
	2C (DPDT)	F	881-2CC-F-C	881-2CC-F-V	881-2CC-F-S
	1A (SPNO)	-----	881-1AH-C	881-1AH-V	881-1AH-S
	1C (SPDT)	-----	881-1CH-C	881-1CH-V	881-1CH-S
	2A (DPNO)	-----	881-2AH-C	881-2AH-V	881-2AH-S
	2C (DPDT)	-----	881-2CH-C	881-2CH-V	881-2CH-S
	1A (SPNO)	F	881-1AH-F-C	881-1AH-F-V	881-1AH-F-S
	1C (SPDT)	F	881-1CH-F-C	881-1CH-F-V	881-1CH-F-S
	2A (DPNO)	F	881-2AH-F-C	881-2AH-F-V	881-2AH-F-S
	2C (DPDT)	F	881-2CH-F-C	881-2CH-F-V	881-2CH-F-S

Note : 881A—Special footprint 5.0mm pinning version can be selected

### ◆ High Power Type

PCB terminal	1A (SPNO)	-----	881H-1AC-C	881H-1AC-V	881H-1AC-S
	1C (SPDT)	-----	881H-1CC-C	881H-1CC-V	881H-1CC-S
	1A (SPNO)	F	881H-1AC-F-C	881H-1AC-F-V	881H-1AC-F-S
	1C (SPDT)	F	881H-1CC-F-C	881H-1CC-F-V	881H-1CC-F-S
	1A (SPNO)	-----	881H-1AH-C	881H-1AH-V	881H-1AH-S
	1C (SPDT)	-----	881H-1CH-C	881H-1CH-V	881H-1CH-S
	1A (SPNO)	F	881H-1AH-F-C	881H-1AH-F-V	881H-1AH-F-S
	1C (SPDT)	F	881H-1CH-F-C	881H-1CH-F-V	881H-1CH-F-S



### Ordering Information

881 H - 1C H - F - C E  
 1 2 3 4 5 6 7

- |          |  |          |                               |
|----------|--|----------|-------------------------------|
| 1. 881   | -- Basic series designation  | 4. C     | -- Contact material AgNi      |
| 2. Blank | -- Standard type<br>(1P - Terminal pitch 3.5mm)<br>(2P - Terminal pitch 5.0mm) | CA       | -- Contact material AgNi + Au |
| A        | -- Standard type and special terminal pitch<br>(1P - Terminal pitch 5.0mm)     | H        | -- Contact material AgSnO     |
| H        | -- High power type<br>(1P - Terminal pitch 5.0mm only)                         | HA       | -- Contact material AgSnO+ Au |
| 3. 1A    | -- Single pole normally open   | 5. Blank | -- Standard type              |
| 1B       | -- Single pole normally closed   | F        | -- Class F                    |
| 1C       | -- Single pole double throw  | 6. C     | -- Flux tight                 |
| 2A       | -- Double pole normally open   | V        | -- Sealed type                |
| 2B       | -- Double pole normally closed   | S        | -- Sealed type washable       |
| 2C       | -- Double pole double throw  | 7. Blank | -- Standard type              |
|          |  | E        | -- CTI 250V                   |

### Contact Rating

Type	881 1A - 1C	881 2A - 2C	881H 1A - 1C
Rated load (resistive)	12A 240VAC	8A 240VAC	16A 240VAC
Max. switching current	12A	8A	16A
Max. switching voltage	277VAC	277VAC	277VAC
Max. switching capacity	2880VA	1920VA	3840VA

### Coil Rating (DC)

Rated voltage (V)	Rated current $\pm 10\%$ at 23 °C (mA)	Coil resistance at 23 °C ( $\Omega$ )	Max. continuous voltage at 85 °C	Pick up voltage(Max) at 23 °C	Drop out voltage(Min) at 23 °C	Power consumption at rated voltage
5	80	62 $\pm 10\%$	160 % of rated voltage	70 % of rated voltage	10 % of rated voltage	approx. 0.4W
6	67	90 $\pm 10\%$				
9	44	203 $\pm 10\%$				
12	33	360 $\pm 10\%$				
18	23	771 $\pm 10\%$				
24	17	1440 $\pm 10\%$				
36	11.1	3240 $\pm 10\%$				
48	8.7	5520 $\pm 10\%$				
60	8	7340 $\pm 15\%$				
110	4	26600 $\pm 15\%$				

## »» Specification

Contact material	AgNi / AgSnO alloy	
Contact resistance <sup>(1)</sup>	100mΩ Max.	
Operate time <sup>(1)</sup>	20ms Max.	
Release time <sup>(1)</sup>	10ms Max.	
Insulation resistance <sup>(1)</sup>	1000MΩ Min. (DC 500V)	
Surge voltage withstand <sup>(1)</sup>	Between contact and coil : 10KV (1.2X50) μ S	
Dielectric strength	Between open contact	: AC 1000V, 50/60Hz 1 min.
	Between contact and coil	: AC 5000V, 50/60Hz 1 min.
	Between contact circuits	: AC 3000V, 50/60Hz 1 min. (for 2pole only)
Vibration resistance	Operating extremes	10~55Hz , amplitude 1.5 mm
	Damage limits	10~55Hz , amplitude 1.5 mm
Shock resistance	Operating extremes	10G
	Damage limits	100G
Life expectancy	Mechanical	30,000,000 operations (frequency 72,000 operations /hr)
	Electrical	100,000 operations (frequency 360 operations /hr)
Operating ambient temperature	-40~+85 °C (no freezing) <sup>(2)</sup>	
Weight	Approx. 10 g	

Note : (1) initial value.

(2) special version of high temperature 105 °C can be selected.

## »» Safety Approval

Certified	UL / CUL	VDE	CSA
File No.	E88991	132905	1435530

## »» Safety Approval Rating(UL/CUL - CSA)

881 1P (C · CA)		881 1P (H · HA)	
NO	NC	NO	NC
20A 277VAC 10FLA, 60LRA 250VAC 12A 30VDC 1HP 240/480VAC A300	20A 277VAC 10FLA, 60LRA 250VAC 12A 30VDC 1HP 240/480VAC	20A 277VAC 10FLA, 60LRA 250VAC 1HP 120/240/480VAC TV-8 A300	20A 277VAC 10FLA, 60LRA 250VAC 1HP 120/240/480VAC A300

881 2P (C · CA)		881 2P (H · HA)	
NO	NC	NO	NC
10A 277VAC 10A 30VDC 1/2HP 120/240VAC B300	10A 277VAC 10A 30VDC 1/3HP 120/240VAC B300	10A 277VAC 10A 30VDC 1/2HP 120/240VAC TV-5 B300	10A 277VAC 10A 30VDC 1/3HP 120/240VAC B300

## »» Safety Approval Rating(VDE)

881 1A · 1C	881H 1A · 1C	881 2A · 2C
12A 250VAC T85	20A 250VAC T85 12A 250VAC T105	10A 250VAC T85

## »» Outline Dimensions

### ◆ 881 1P

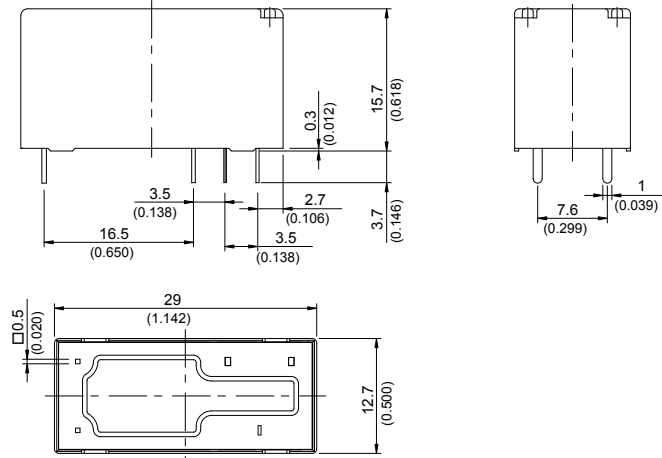

### ◆ 881 2P

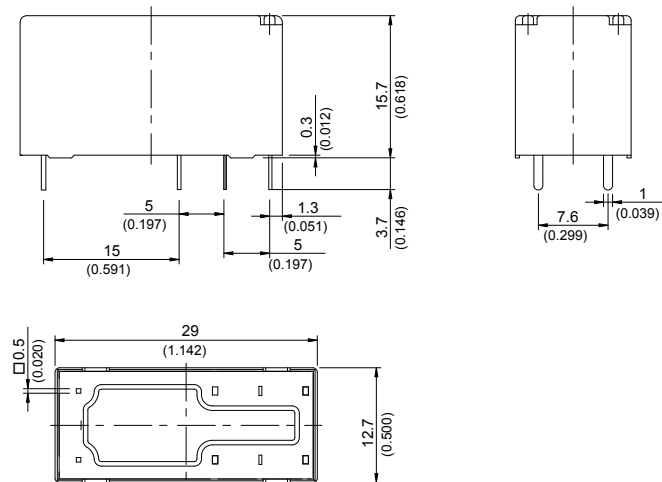

### ◆ 881H 1P

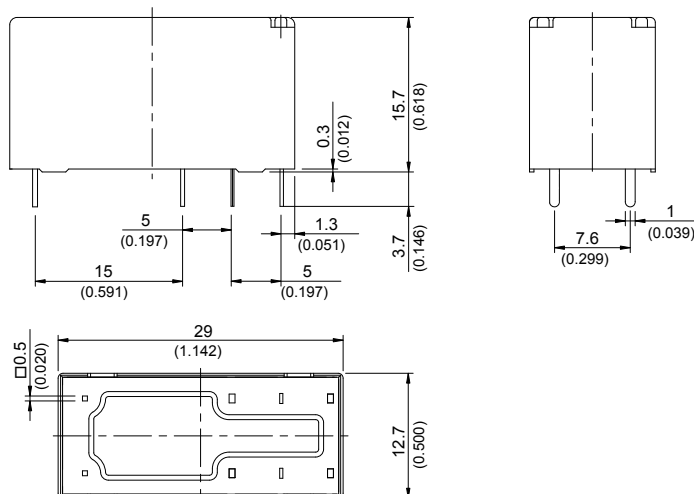

◆881A 1P

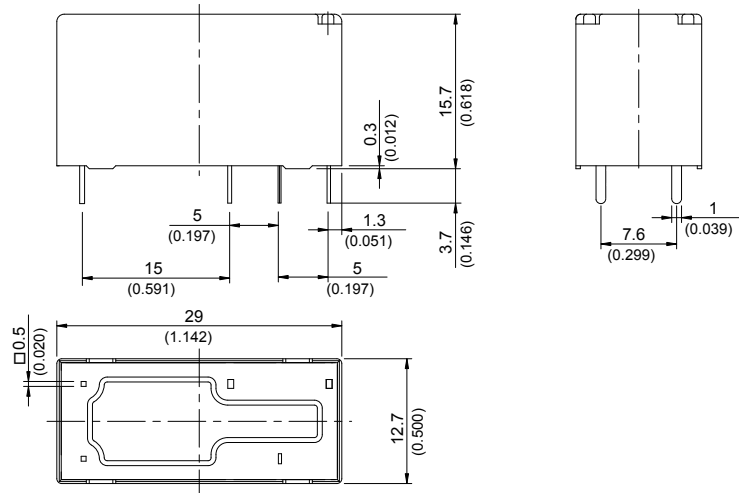

»» Wiring Diagram  
BOTTOM VIEW

◆881

1C

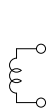

1A

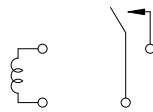

2C

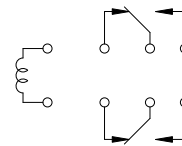

2A

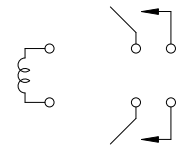

◆881H

1C

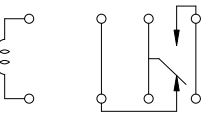

1A

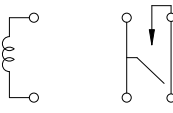

◆881A

1C

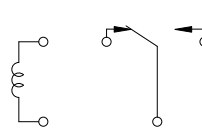

1A

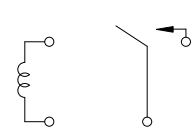

»» PC Board Layout  
BOTTOM VIEW

◆881

1C

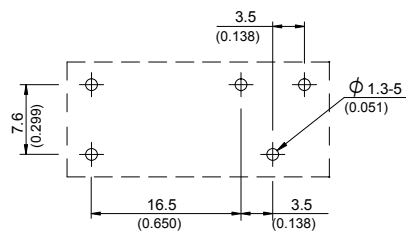

1A

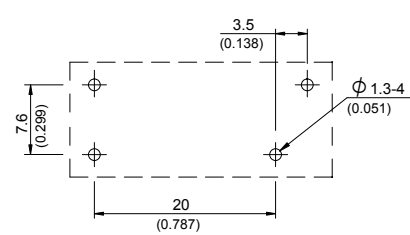

2C

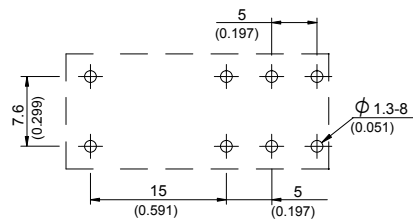

2A

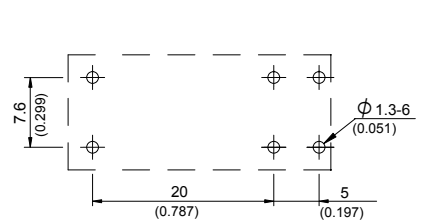

◆881H 1C

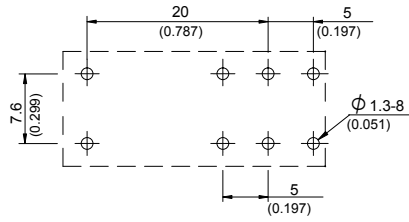

1A

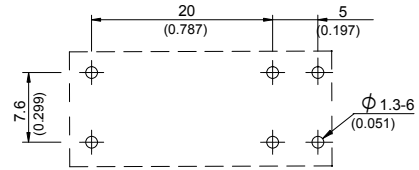

◆881A 1C

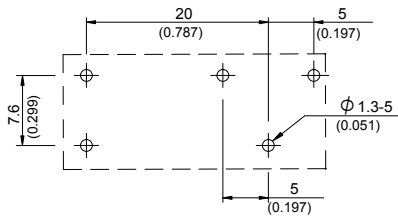

1A

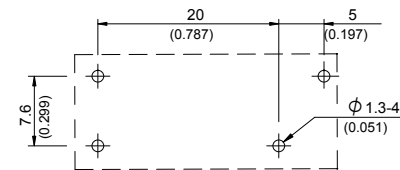

» Engineering Data

◆881(1P)

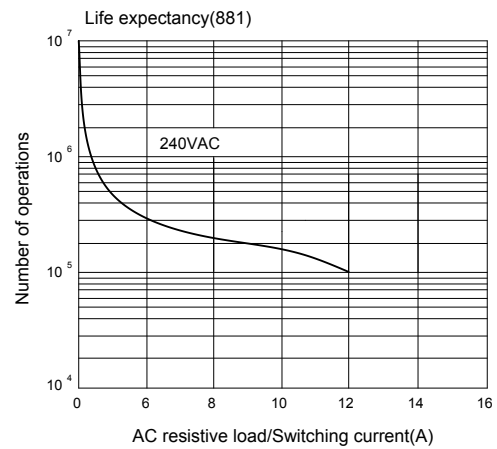
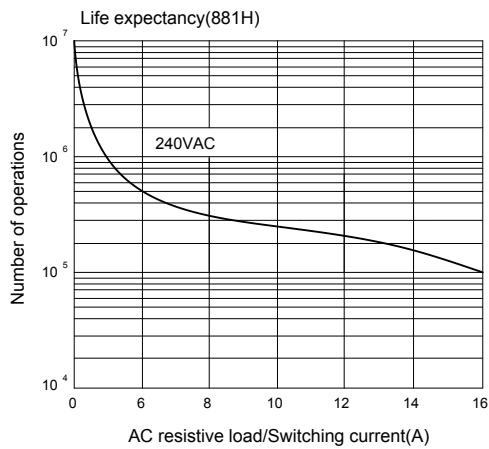
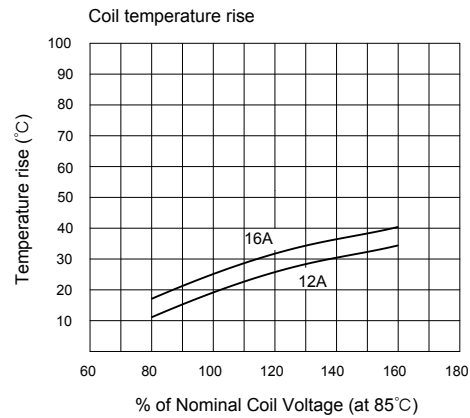
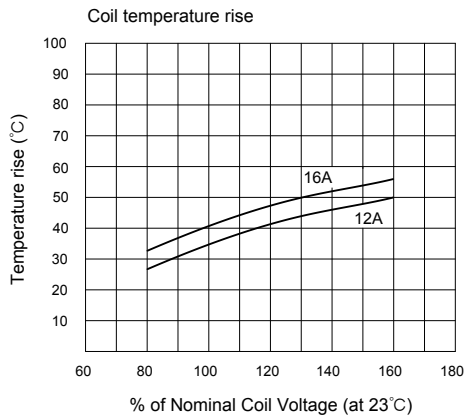

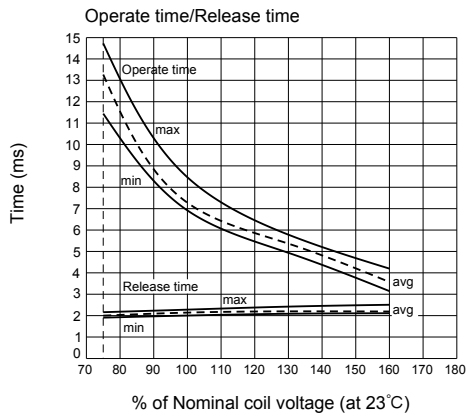

◆881(2P)

