

### FEATURES

**Single 3 V Supply Operation (2.7 V to 3.6 V)**  
**SNR = 70 dBc to Nyquist at 65 MSPS**  
**SFDR = 85 dBc to Nyquist at 65 MSPS**  
**Low Power: 300 mW at 65 MSPS**  
**Differential Input with 500 MHz Bandwidth**  
**On-Chip Reference and SHA**  
**DNL =  $\pm 0.4$  LSB**  
**Flexible Analog Input: 1 V p-p to 2 V p-p Range**  
**Offset Binary or Twos Complement Data Format**  
**Clock Duty Cycle Stabilizer**

### APPLICATIONS

**Ultrasound Equipment**  
**IF Sampling in Communications Receivers:**  
**IS-95, CDMA-One, IMT-2000**  
**Battery-Powered Instruments**  
**Hand-Held Scopemeters**  
**Low Cost Digital Oscilloscopes**

### PRODUCT DESCRIPTION

The AD9235 is a family of monolithic, single 3 V supply, 12-bit, 20/40/65 MSPS analog-to-digital converters. This family features a high performance sample-and-hold amplifier (SHA) and voltage reference. The AD9235 uses a multistage differential pipelined architecture with output error correction logic to provide 12-bit accuracy at 20/40/65 MSPS data rates and guarantee no missing codes over the full operating temperature range.

The wide bandwidth, truly differential SHA allows a variety of user-selectable input ranges and offsets including single-ended applications. It is suitable for multiplexed systems that switch full-scale voltage levels in successive channels and for sampling single-channel inputs at frequencies well beyond the Nyquist rate. Combined with power and cost savings over previously available analog-to-digital converters, the AD9235 is suitable for applications in communications, imaging, and medical ultrasound.

A single-ended clock input is used to control all internal conversion cycles. A duty cycle stabilizer (DCS) compensates for wide variations in the clock duty cycle while maintaining excellent overall ADC performance. The digital output data is presented in straight binary or twos complement formats. An out-of-range (OTR) signal indicates an overflow condition that can be used with the most significant bit to determine low or high overflow.

Fabricated on an advanced CMOS process, the AD9235 is available in a 28-lead thin shrink small outline package (TSSOP) and a 32-lead chip scale package (LFCSP) and is specified over the industrial temperature range ( $-40^{\circ}\text{C}$  to  $+85^{\circ}\text{C}$ ).

### REV. B

Information furnished by Analog Devices is believed to be accurate and reliable. However, no responsibility is assumed by Analog Devices for its use, nor for any infringements of patents or other rights of third parties that may result from its use. No license is granted by implication or otherwise under any patent or patent rights of Analog Devices. Trademarks and registered trademarks are the property of their respective companies.

### FUNCTIONAL BLOCK DIAGRAM

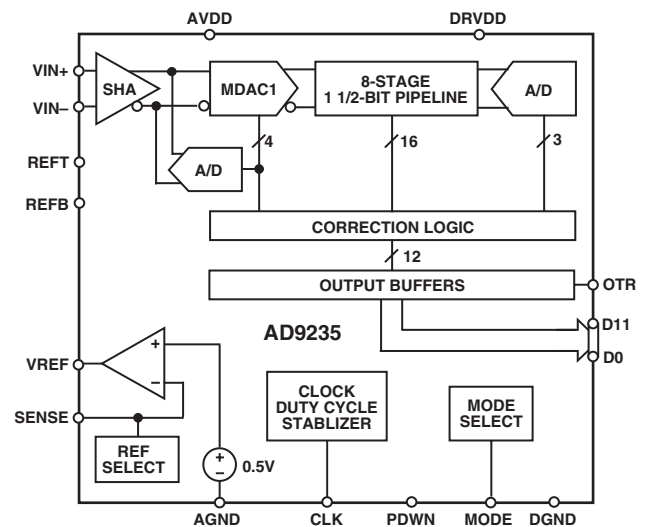

### PRODUCT HIGHLIGHTS

1. The AD9235 operates from a single 3 V power supply and features a separate digital output driver supply to accommodate 2.5 V and 3.3 V logic families.
2. Operating at 65 MSPS, the AD9235 consumes a low 300 mW.
3. The patented SHA input maintains excellent performance for input frequencies up to 100 MHz and can be configured for single-ended or differential operation.
4. The AD9235 pinout is similar to the AD9214-65, a 10-bit, 65 MSPS ADC. This allows a simplified upgrade path from 10 bits to 12 bits for 65 MSPS systems.
5. The clock DCS maintains overall ADC performance over a wide range of clock pulsewidths.
6. The OTR output bit indicates when the signal is beyond the selected input range.

# AD9235—SPECIFICATIONS

## DC SPECIFICATIONS (AVDD = 3 V, DRVDD = 2.5 V, Maximum Sample Rate, 2 V p-p Differential Input, 1.0 V internal reference, T<sub>MIN</sub> to T<sub>MAX</sub>, unless otherwise noted.)

| Parameter                                    | Temp | Test Level | AD9235BRU-20 |       |       | AD9235BRU-40 |       |       | AD9235BRU/BCP-65 |       |       | Unit    |
|--|------|------------|--------------|-------|-------|--------------|-------|-------|------------------|-------|-------|---------|
|  |      |            | Min          | Typ   | Max   | Min          | Typ   | Max   | Min              | Typ   | Max   |         |
| RESOLUTION                                   | Full | VI         | 12           |       |       | 12           |       |       | 12               |       |       | Bits    |
| ACCURACY                                     |      |            |              |       |       |              |       |       |                  |       |       |         |
| No Missing Codes Guaranteed                  | Full | VI         | 12           |       |       | 12           |       |       | 12               |       |       | Bits    |
| Offset Error                                 | Full | VI         |              | ±0.30 | ±1.20 |              | ±0.50 | ±1.20 |                  | ±0.50 | ±1.20 | % FSR   |
| Gain Error <sup>1</sup>                      | Full | VI         |              | ±0.30 | ±2.40 |              | ±0.50 | ±2.50 |                  | ±0.50 | ±2.60 | % FSR   |
| Differential Nonlinearity (DNL) <sup>2</sup> | Full | IV         |              | ±0.35 | ±0.65 |              | ±0.35 | ±0.75 |                  | ±0.40 | ±0.80 | LSB     |
|  | 25°C | I          |              | ±0.35 |       |              | ±0.35 |       |                  | ±0.35 |       | LSB     |
| Integral Nonlinearity (INL) <sup>2</sup>     | Full | IV         |              | ±0.45 | ±0.80 |              | ±0.50 | ±0.90 |                  | ±0.70 | ±1.30 | LSB     |
|  | 25°C | I          |              | ±0.40 |       |              | ±0.40 |       |                  | ±0.45 |       | LSB     |
| TEMPERATURE DRIFT                            |      |            |              |       |       |              |       |       |                  |       |       |         |
| Offset Error                                 | Full | V          |              | ±2    |       |              | ±2    |       |                  | ±3    |       | ppm/°C  |
| Gain Error <sup>1</sup>                      | Full | V          |              | ±12   |       |              | ±12   |       |                  | ±12   |       | ppm/°C  |
| INTERNAL VOLTAGE REFERENCE                   |      |            |              |       |       |              |       |       |                  |       |       |         |
| Output Voltage Error (1 V Mode)              | Full | VI         |              | ±5    | ±35   |              | ±5    | ±35   |                  | ±5    | ±35   | mV      |
| Load Regulation @ 1.0 mA                     | Full | V          |              | 0.8   |       |              | 0.8   |       |                  | 0.8   |       | mV      |
| Output Voltage Error (0.5 V Mode)            | Full | V          |              | ±2.5  |       |              | ±2.5  |       |                  | ±2.5  |       | mV      |
| Load Regulation @ 0.5 mA                     | Full | V          |              | 0.1   |       |              | 0.1   |       |                  | 0.1   |       | mV      |
| INPUT REFERRED NOISE                         |      |            |              |       |       |              |       |       |                  |       |       |         |
| VREF = 0.5 V                                 | 25°C | V          |              | 0.54  |       |              | 0.54  |       |                  | 0.54  |       | LSB rms |
| VREF = 1.0 V                                 | 25°C | V          |              | 0.27  |       |              | 0.27  |       |                  | 0.27  |       | LSB rms |
| ANALOG INPUT                                 |      |            |              |       |       |              |       |       |                  |       |       |         |
| Input Span, VREF = 0.5 V                     | Full | IV         |              | 1     |       |              | 1     |       |                  | 1     |       | V p-p   |
| Input Span, VREF = 1.0 V                     | Full | IV         |              | 2     |       |              | 2     |       |                  | 2     |       | V p-p   |
| Input Capacitance <sup>3</sup>               | Full | V          |              | 7     |       |              | 7     |       |                  | 7     |       | pF      |
| REFERENCE INPUT RESISTANCE                   | Full | V          |              | 7     |       |              | 7     |       |                  | 7     |       | kΩ      |
| POWER SUPPLIES                               |      |            |              |       |       |              |       |       |                  |       |       |         |
| Supply Voltages                              |      |            |              |       |       |              |       |       |                  |       |       |         |
| AVDD   | Full | IV         | 2.7          | 3.0   | 3.6   | 2.7          | 3.0   | 3.6   | 2.7              | 3.0   | 3.6   | V       |
| DRVDD  | Full | IV         | 2.25         | 3.0   | 3.6   | 2.25         | 3.0   | 3.6   | 2.25             | 3.0   | 3.6   | V       |
| Supply Current                               |      |            |              |       |       |              |       |       |                  |       |       |         |
| IAVDD <sup>2</sup>                           | Full | V          |              | 30    |       |              | 55    |       |                  | 100   |       | mA      |
| IDRVDD <sup>2</sup>                          | Full | V          |              | 2     |       |              | 5     |       |                  | 7     |       | mA      |
| PSRR   | Full | V          |              | ±0.01 |       |              | ±0.01 |       |                  | ±0.01 |       | % FSR   |
| POWER CONSUMPTION                            |      |            |              |       |       |              |       |       |                  |       |       |         |
| DC Input <sup>4</sup>                        | Full | V          |              | 90    |       |              | 165   |       |                  | 300   |       | mW      |
| Sine Wave Input <sup>2</sup>                 | Full | VI         |              | 95    | 110   |              | 180   | 205   |                  | 320   | 350   | mW      |
| Standby Power <sup>5</sup>                   | Full | V          |              | 1.0   |       |              | 1.0   |       |                  | 1.0   |       | mW      |

### NOTES

<sup>1</sup>Gain error and gain temperature coefficient are based on the ADC only (with a fixed 1.0 V external reference).

<sup>2</sup>Measured at maximum clock rate, f<sub>IN</sub> = 2.4 MHz, full-scale sine wave, with approximately 5 pF loading on each output bit.

<sup>3</sup>Input capacitance refers to the effective capacitance between one differential input pin and AGND. Refer to Figure 2 for the equivalent analog input structure.

<sup>4</sup>Measured with dc input at maximum clock rate.

<sup>5</sup>Standby power is measured with a dc input, the CLK pin inactive (i.e., set to AVDD or AGND).

Specifications subject to change without notice.

## DIGITAL SPECIFICATIONS

| Parameter                                    | Temp | Test Level | AD9235BRU-20 |     |      | AD9235BRU-40 |     |      | AD9235BRU/BCP-65 |     |      | Unit    |
|--|------|------------|--------------|-----|------|--------------|-----|------|------------------|-----|------|---------|
|  |      |            | Min          | Typ | Max  | Min          | Typ | Max  | Min              | Typ | Max  |         |
| LOGIC INPUTS                                 |      |            |              |     |      |              |     |      |                  |     |      |         |
| High Level Input Voltage                     | Full | IV         | 2.0          |     |      | 2.0          |     |      | 2.0              |     |      | V       |
| Low Level Input Voltage                      | Full | IV         |              |     | 0.8  |              |     | 0.8  |                  |     | 0.8  | V       |
| High Level Input Current                     | Full | IV         | -10          |     | +10  | -10          |     | +10  | -10              |     | +10  | $\mu$ A |
| Low Level Input Current                      | Full | IV         | -10          |     | +10  | -10          |     | +10  | -10              |     | +10  | $\mu$ A |
| Input Capacitance                            | Full | V          |              | 2   |      |              | 2   |      |                  | 2   |      | pF      |
| LOGIC OUTPUTS*                               |      |            |              |     |      |              |     |      |                  |     |      |         |
| DRVDD = 3.3 V                                |      |            |              |     |      |              |     |      |                  |     |      |         |
| High-Level Output Voltage (IOH = 50 $\mu$ A) | Full | IV         | 3.29         |     |      | 3.29         |     |      | 3.29             |     |      | V       |
| High-Level Output Voltage (IOH = 0.5 mA)     | Full | IV         | 3.25         |     |      | 3.25         |     |      | 3.25             |     |      | V       |
| Low-Level Output Voltage (IOL = 1.6 mA)      | Full | IV         |              |     | 0.2  |              |     | 0.2  |                  |     | 0.2  | V       |
| Low-Level Output Voltage (IOL = 50 $\mu$ A)  | Full | IV         |              |     | 0.05 |              |     | 0.05 |                  |     | 0.05 | V       |
| DRVDD = 2.5 V                                |      |            |              |     |      |              |     |      |                  |     |      |         |
| High-Level Output Voltage (IOH = 50 $\mu$ A) | Full | IV         | 2.49         |     |      | 2.49         |     |      | 2.49             |     |      | V       |
| High-Level Output Voltage (IOH = 0.5 mA)     | Full | IV         | 2.45         |     |      | 2.45         |     |      | 2.45             |     |      | V       |
| Low-Level Output Voltage (IOL = 1.6 mA)      | Full | IV         |              |     | 0.2  |              |     | 0.2  |                  |     | 0.2  | V       |
| Low-Level Output Voltage (IOL = 50 $\mu$ A)  | Full | IV         |              |     | 0.05 |              |     | 0.05 |                  |     | 0.05 | V       |

\*Output voltage levels measured with 5 pF load on each output.

Specifications subject to change without notice.

## SWITCHING SPECIFICATIONS

| Parameter                              | Temp | Test Level | AD9235BRU-20 |     |     | AD9235BRU-40 |     |     | AD9235BRU/BCP-65 |     |     | Unit   |
|--|------|------------|--------------|-----|-----|--------------|-----|-----|------------------|-----|-----|--------|
|  |      |            | Min          | Typ | Max | Min          | Typ | Max | Min              | Typ | Max |        |
| CLOCK INPUT PARAMETERS                 |      |            |              |     |     |              |     |     |                  |     |     |        |
| Maximum Conversion Rate                | Full | VI         | 20           |     |     | 40           |     |     | 65               |     |     | MSPS   |
| Minimum Conversion Rate                | Full | V          |              |     | 1   |              |     | 1   |                  |     | 1   | MSPS   |
| CLK Period                             | Full | V          | 50.0         |     |     | 25.0         |     |     | 15.4             |     |     | ns     |
| CLK Pulsewidth High <sup>1</sup>       | Full | V          | 15.0         |     |     | 8.8          |     |     | 6.2              |     |     | ns     |
| CLK Pulsewidth Low <sup>1</sup>        | Full | V          | 15.0         |     |     | 8.8          |     |     | 6.2              |     |     | ns     |
| DATA OUTPUT PARAMETERS                 |      |            |              |     |     |              |     |     |                  |     |     |        |
| Output Delay <sup>2</sup> ( $t_{PD}$ ) | Full | V          |              | 3.5 |     |              | 3.5 |     |                  | 3.5 |     | ns     |
| Pipeline Delay (Latency)               | Full | V          |              | 7   |     |              | 7   |     |                  | 7   |     | Cycles |
| Aperture Delay ( $t_A$ )               | Full | V          |              | 1.0 |     |              | 1.0 |     |                  | 1.0 |     | ns     |
| Aperture Uncertainty Jitter ( $t_j$ )  | Full | V          |              | 0.5 |     |              | 0.5 |     |                  | 0.5 |     | ps rms |
| Wake-Up Time <sup>3</sup>              | Full | V          |              | 3.0 |     |              | 3.0 |     |                  | 3.0 |     | ms     |
| OUT-OF-RANGE RECOVERY TIME             |      |            |              |     |     |              |     |     |                  |     |     |        |
|  | Full | V          |              | 1   |     |              | 1   |     |                  | 2   |     | Cycles |

## NOTES

<sup>1</sup>For the AD9235-65 model only, with duty cycle stabilizer enabled. DCS function not applicable for -20 and -40 models.

<sup>2</sup>Output delay is measured from CLK 50% transition to DATA 50% transition, with 5 pF load on each output.

<sup>3</sup>Wake-up time is dependent on value of decoupling capacitors; typical values shown with 0.1  $\mu$ F and 10  $\mu$ F capacitors on REFT and REFB.

Specifications subject to change without notice.

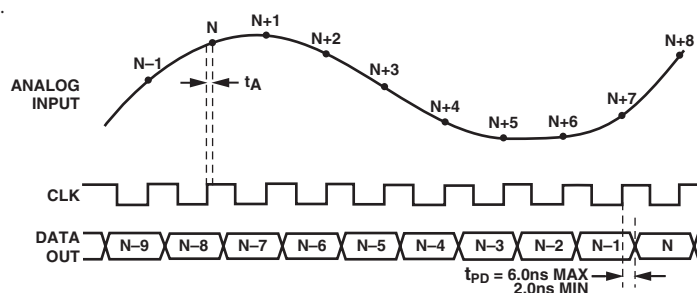

Figure 1. Timing Diagram

# AD9235—SPECIFICATIONS

**AC SPECIFICATIONS** (AVDD = 3 V, DRVDD = 2.5 V, Maximum Sample Rate, 2 V p-p Differential Input, AIN = -0.5 dBFS, 1.0 V internal reference, T<sub>MIN</sub> to T<sub>MAX</sub>, unless otherwise noted.)

| Parameter                                   | Temp | Test Level | AD9235BRU-20 |       |       | AD9235BRU-40 |       |       | AD9235BRU/BCP-65 |       |       | Unit |     |
|---|------|------------|--------------|-------|-------|--------------|-------|-------|------------------|-------|-------|------|-----|
|   |      |            | Min          | Typ   | Max   | Min          | Typ   | Max   | Min              | Typ   | Max   |      |     |
| <b>SIGNAL-TO-NOISE RATIO</b>                |      |            |              |       |       |              |       |       |                  |       |       |      |     |
| f <sub>INPUT</sub> = 2.4 MHz                | 25°C | V          |              | 70.8  |       |              | 70.6  |       |                  | 70.5  |       | dBc  |     |
| f <sub>INPUT</sub> = 9.7 MHz                | Full | IV         | 70.0         | 70.4  |       |              |       |       |                  |       |       | dBc  |     |
|   | 25°C | I          |              | 70.6  |       |              |       |       |                  |       |       | dBc  |     |
| f <sub>INPUT</sub> = 19.6 MHz               | Full | IV         |              |       |       | 69.9         | 70.3  |       |                  |       |       | dBc  |     |
|   | 25°C | I          |              |       |       |              | 70.4  |       |                  |       |       | dBc  |     |
| f <sub>INPUT</sub> = 32.5 MHz               | Full | IV         |              |       |       |              |       | 68.7  | 69.7             |       |       | dBc  |     |
|   | 25°C | I          |              |       |       |              |       |       | 70.1             |       |       | dBc  |     |
| f <sub>INPUT</sub> = 100 MHz                | 25°C | V          |              | 68.7  |       |              | 68.5  |       |                  | 68.3  |       | dBc  |     |
| <b>SIGNAL-TO-NOISE RATIO AND DISTORTION</b> |      |            |              |       |       |              |       |       |                  |       |       |      |     |
| f <sub>INPUT</sub> = 2.4 MHz                | 25°C | V          |              | 70.6  |       |              |       | 70.5  |                  |       | 70.4  |      | dBc |
| f <sub>INPUT</sub> = 9.7 MHz                | Full | IV         | 69.9         | 70.3  |       |              |       |       |                  |       |       | dBc  |     |
|   | 25°C | I          |              | 70.5  |       |              |       |       |                  |       |       | dBc  |     |
| f <sub>INPUT</sub> = 19.6 MHz               | Full | IV         |              |       |       | 69.7         | 70.2  |       |                  |       |       | dBc  |     |
|   | 25°C | I          |              |       |       |              | 70.3  |       |                  |       |       | dBc  |     |
| f <sub>INPUT</sub> = 32.5 MHz               | Full | IV         |              |       |       |              |       | 68.3  | 69.5             |       |       | dBc  |     |
|   | 25°C | I          |              |       |       |              |       |       | 69.9             |       |       | dBc  |     |
| f <sub>INPUT</sub> = 100 MHz                | 25°C | V          |              | 68.6  |       |              | 68.3  |       |                  | 67.8  |       | dBc  |     |
| <b>TOTAL HARMONIC DISTORTION</b>            |      |            |              |       |       |              |       |       |                  |       |       |      |     |
| f <sub>INPUT</sub> = 2.4 MHz                | 25°C | V          |              | -88.0 |       |              |       | -89.0 |                  |       | -87.5 |      | dBc |
| f <sub>INPUT</sub> = 9.7 MHz                | Full | IV         |              | -86.0 | -79.0 |              |       |       |                  |       |       |      | dBc |
|   | 25°C | I          |              | -87.4 |       |              |       |       |                  |       |       |      | dBc |
| f <sub>INPUT</sub> = 19.6 MHz               | Full | IV         |              |       |       |              | -85.5 | -79.0 |                  |       |       |      | dBc |
|   | 25°C | I          |              |       |       |              | -86.0 |       |                  |       |       |      | dBc |
| f <sub>INPUT</sub> = 32.5 MHz               | Full | IV         |              |       |       |              |       |       | -81.8            | -74.0 |       |      | dBc |
|   | 25°C | I          |              |       |       |              |       |       | -82.0            |       |       |      | dBc |
| f <sub>INPUT</sub> = 100 MHz                | 25°C | V          |              | -84.0 |       |              | -82.5 |       |                  | -78.0 |       |      | dBc |
| <b>WORST HARMONIC (Second or Third)</b>     |      |            |              |       |       |              |       |       |                  |       |       |      |     |
| f <sub>INPUT</sub> = 9.7 MHz                | Full | IV         |              | -90.0 | -80.0 |              |       |       |                  |       |       |      | dBc |
| f <sub>INPUT</sub> = 19.6 MHz               | Full | IV         |              |       |       |              | -90.0 | -80.0 |                  |       |       |      | dBc |
| f <sub>INPUT</sub> = 32.5 MHz               | Full | IV         |              |       |       |              |       |       | -83.5            | -74.0 |       |      | dBc |
| <b>SPURIOUS FREE DYNAMIC RANGE</b>          |      |            |              |       |       |              |       |       |                  |       |       |      |     |
| f <sub>INPUT</sub> = 2.4 MHz                | 25°C | V          |              | 92.0  |       |              |       | 92.0  |                  |       | 92.0  |      | dBc |
| f <sub>INPUT</sub> = 9.7 MHz                | Full | IV         | 80.0         | 88.5  |       |              |       |       |                  |       |       |      | dBc |
|   | 25°C | I          |              | 91.0  |       |              |       |       |                  |       |       |      | dBc |
| f <sub>INPUT</sub> = 19.6 MHz               | Full | IV         |              |       |       | 80.0         | 89.0  |       |                  |       |       |      | dBc |
|   | 25°C | I          |              |       |       |              | 90.0  |       |                  |       |       |      | dBc |
| f <sub>INPUT</sub> = 32.5 MHz               | Full | IV         |              |       |       |              |       | 74.0  | 83.0             |       |       |      | dBc |
|   | 25°C | I          |              |       |       |              |       |       | 85.0             |       |       |      | dBc |
| f <sub>INPUT</sub> = 100 MHz                | 25°C | V          |              | 84.0  |       |              | 85.0  |       |                  | 80.5  |       |      | dBc |

Specifications subject to change without notice.

ABSOLUTE MAXIMUM RATINGS<sup>1</sup>

| Pin Name                         | With Respect to | Min  | Max         | Unit |
|----------------------------------|-----------------|------|-------------|------|
| <b>ELECTRICAL</b>                |                 |      |             |      |
| AVDD                             | AGND            | -0.3 | +3.9        | V    |
| DRVDD                            | DGND            | -0.3 | +3.9        | V    |
| AGND                             | DGND            | -0.3 | +0.3        | V    |
| AVDD                             | DRVDD           | -3.9 | +3.9        | V    |
| Digital Outputs                  | DGND            | -0.3 | DRVDD + 0.3 | V    |
| CLK, MODE                        | AGND            | -0.3 | AVDD + 0.3  | V    |
| VIN+, VIN-                       | AGND            | -0.3 | AVDD + 0.3  | V    |
| VREF                             | AGND            | -0.3 | AVDD + 0.3  | V    |
| SENSE                            | AGND            | -0.3 | AVDD + 0.3  | V    |
| REFB, REFT                       | AGND            | -0.3 | AVDD + 0.3  | V    |
| PDWN                             | AGND            | -0.3 | AVDD + 0.3  | V    |
| <b>ENVIRONMENTAL<sup>2</sup></b> |                 |      |             |      |
| Operating Temperature            |                 | -40  | +85         | °C   |
| Junction Temperature             |                 |      | 150         | °C   |
| Lead Temperature (10 sec)        |                 |      | 300         | °C   |
| Storage Temperature              |                 | -65  | +150        | °C   |

## NOTES

<sup>1</sup>Absolute maximum ratings are limiting values to be applied individually and beyond which the serviceability of the circuit may be impaired. Functional operability is not necessarily implied. Exposure to absolute maximum rating conditions for an extended period of time may affect device reliability.

<sup>2</sup>Typical thermal impedances (28-lead TSSOP),  $\theta_{JA} = 67.7^{\circ}\text{C}/\text{W}$ ; (32-lead LFCSP),  $\theta_{JA} = 32.5^{\circ}\text{C}/\text{W}$ ,  $\theta_{JC} = 32.71^{\circ}\text{C}/\text{W}$ . These measurements were taken on a 4-layer board in still air, in accordance with EIA/JESD51-1.

## EXPLANATION OF TEST LEVELS

- I 100% production tested.
- II 100% production tested at 25°C and sample tested at specified temperatures.
- III Sample tested only.
- IV Parameter is guaranteed by design and characterization testing.
- V Parameter is a typical value only.
- VI 100% production tested at 25°C; guaranteed by design and characterization testing for industrial temperature range; 100% production tested at temperature extremes for military devices.

## ORDERING GUIDE

| Model          | Temperature Range | Package Description   | Package Option |
|----------------|-------------------|---|----------------|
| AD9235BRU-20   | -40°C to +85°C    | 28-Lead Thin Shrink Small Outline Package (TSSOP)               | RU-28          |
| AD9235BRU-40   | -40°C to +85°C    | 28-Lead Thin Shrink Small Outline Package (TSSOP)               | RU-28          |
| AD9235BRU-65   | -40°C to +85°C    | 28-Lead Thin Shrink Small Outline Package (TSSOP)               | RU-28          |
| AD9235BCP-20*  | -40°C to +85°C    | 32-Lead Lead Frame Chip Scale Package (LFCSP) (Contact Factory) | CP-32          |
| AD9235BCP-40*  | -40°C to +85°C    | 32-Lead Lead Frame Chip Scale Package (LFCSP) (Contact Factory) | CP-32          |
| AD9235BCP-65*  | -40°C to +85°C    | 32-Lead Lead Frame Chip Scale Package (LFCSP)                   | CP-32          |
| AD9235-20PCB   |                   | TSSOP Evaluation Board  |                |
| AD9235-40PCB   |                   | TSSOP Evaluation Board  |                |
| AD9235-65PCB   |                   | TSSOP Evaluation Board  |                |
| AD9235BCP-20EB |                   | LFCSP Evaluation Board (Contact Factory)                        |                |
| AD9235BCP-40EB |                   | LFCSP Evaluation Board (Contact Factory)                        |                |
| AD9235BCP-65EB |                   | LFCSP Evaluation Board  |                |

\*It is recommended that the exposed paddle be soldered to the ground plane. There is an increased reliability of the solder joints and maximum thermal capability of the package is achieved with exposed paddle soldered to the customer board.

## CAUTION

ESD (electrostatic discharge) sensitive device. Electrostatic charges as high as 4000 V readily accumulate on the human body and test equipment and can discharge without detection. Although the AD9235 features proprietary ESD protection circuitry, permanent damage may occur on devices subjected to high energy electrostatic discharges. Therefore, proper ESD precautions are recommended to avoid performance degradation or loss of functionality.



# AD9235

## PIN CONFIGURATION

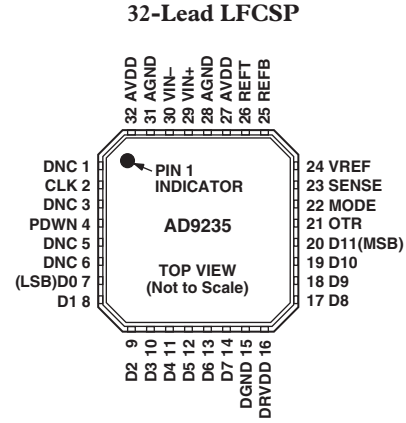
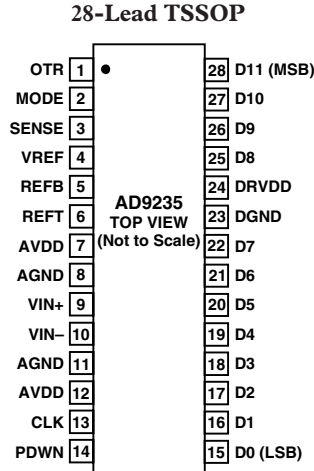

## PIN FUNCTION DESCRIPTIONS

| Pin Number    | Mnemonic      | Description        |  |
|---------------|---------------|--------------------|--|
| 28-Lead TSSOP | 32-Lead LFCSP |                    |  |
| 1             | 21            | OTR                | Out-of-Range Indicator.  |
| 2             | 22            | MODE               | Data Format and Clock Duty Cycle Stabilizer (DCS) Mode Selection.  |
| 3             | 23            | SENSE              | Reference Mode Selection.  |
| 4             | 24            | VREF               | Voltage Reference Input/Output.  |
| 5             | 25            | REFB               | Differential Reference (-).  |
| 6             | 26            | REFT               | Differential Reference (+).  |
| 7, 12         | 27, 32        | AVDD               | Analog Power Supply.   |
| 8, 11         | 28, 31        | AGND               | Analog Ground.   |
| 9             | 29            | VIN+               | Analog Input Pin (+).  |
| 10            | 30            | VIN-               | Analog Input Pin (-).  |
| 13            | 2             | CLK                | Clock Input Pin.   |
| 14            | 4             | PDWN               | Power-Down Function Selection (Active High).   |
| 15-22,        | 7-14,         | D0 (LSB)-D11 (MSB) | Data Output Bits.  |
| 25-28         | 17-20         |                    |  |
| 23            | 15            | DGND               | Digital Output Ground.   |
| 24            | 16            | DRVDD              | Digital Output Driver Supply. Must be decoupled to DGND with a minimum 0.1 $\mu$ F capacitor. Recommended decoupling is 0.1 $\mu$ F in parallel with 10 $\mu$ F. |
|               | 1, 3, 5, 6    | DNC                | Do Not Connect.  |

**DEFINITIONS OF SPECIFICATIONS****Analog Bandwidth (Full Power Bandwidth)**

The analog input frequency at which the spectral power of the fundamental frequency (as determined by the FFT analysis) is reduced by 3 dB.

**Aperture Delay ( $t_A$ )**

The delay between the 50% point of the rising edge of the clock and the instant at which the analog input is sampled.

**Aperture Jitter ( $t_j$ )**

The sample-to-sample variation in aperture delay.

**Integral Nonlinearity (INL)**

The deviation of each individual code from a line drawn from negative full scale through positive full scale. The point used as negative full scale occurs 1/2 LSB before the first code transition. Positive full scale is defined as a level 1 1/2 LSBs beyond the last code transition. The deviation is measured from the middle of each particular code to the true straight line.

**Differential Nonlinearity (DNL, No Missing Codes)**

An ideal ADC exhibits code transitions that are exactly 1 LSB apart. DNL is the deviation from this ideal value. Guaranteed no missing codes to 12-bit resolution indicates that all 4096 codes must be present over all operating ranges.

**Offset Error**

The major carry transition should occur for an analog value 1/2 LSB below  $V_{IN+} = V_{IN-}$ . Offset error is defined as the deviation of the actual transition from that point.

**Gain Error**

The first code transition should occur at an analog value 1/2 LSB above negative full scale. The last transition should occur at an analog value 1 1/2 LSB below the positive full scale. Gain error is the deviation of the actual difference between first and last code transitions and the ideal difference between first and last code transitions.

**Temperature Drift**

The temperature drift for offset error and gain error specifies the maximum change from the initial (25°C) value to the value at  $T_{MIN}$  or  $T_{MAX}$ .

**Power Supply Rejection Ratio**

The change in full scale from the value with the supply at the minimum limit to the value with the supply at its maximum limit.

**Total Harmonic Distortion (THD)\***

The ratio of the rms sum of the first six harmonic components to the rms value of the measured input signal.

**Signal-to-Noise and Distortion (SINAD)\***

The ratio of the rms signal amplitude (set 0.5 dB below full scale) to the rms value of the sum of all other spectral components below the Nyquist frequency, including harmonics but excluding dc.

**Effective Number of Bits (ENOB)**

The effective number of bits for a device for sine wave inputs at a given input frequency can be calculated directly from its measured *SINAD* using the following formula

$$N = (SINAD - 1.76) / 6.02$$

**Signal-to-Noise Ratio (SNR)\***

The ratio of the rms signal amplitude (set at 0.5 dB below full scale) to the rms value of the sum of all other spectral components below the Nyquist frequency, excluding the first six harmonics and dc.

**Spurious Free Dynamic Range (SFDR)\***

The difference in dB between the rms amplitude of the input signal and the peak spurious signal.

**Two-Tone SFDR\***

The ratio of the rms value of either input tone to the rms value of the peak spurious component. The peak spurious component may or may not be an IMD product.

**Clock Pulsewidth and Duty Cycle**

Pulsewidth high is the minimum amount of time that the clock pulse should be left in the Logic 1 state to achieve rated performance. Pulsewidth low is the minimum time the clock pulse should be left in the low state. At a given clock rate, these specifications define an acceptable clock duty cycle.

**Minimum Conversion Rate**

The clock rate at which the SNR of the lowest analog signal frequency drops by no more than 3 dB below the guaranteed limit.

**Maximum Conversion Rate**

The clock rate at which parametric testing is performed.

**Output Propagation Delay ( $t_{PD}$ )**

The delay between the clock logic threshold and the time when all bits are within valid logic levels.

**Out-of-Range Recovery Time**

The time it takes for the ADC to reacquire the analog input after a transition from 10% above positive full scale to 10% above negative full scale, or from 10% below negative full scale to 10% below positive full scale.

\*AC specifications may be reported in dBc (degrades as signal levels are lowered) or in dBFS (always related back to converter full scale).

# AD9235

## Equivalent Circuits

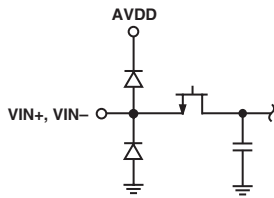

Figure 2. Equivalent Analog Input Circuit

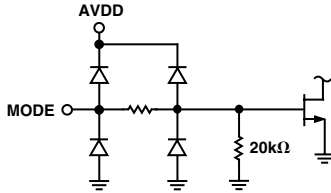

Figure 3. Equivalent MODE Input Circuit

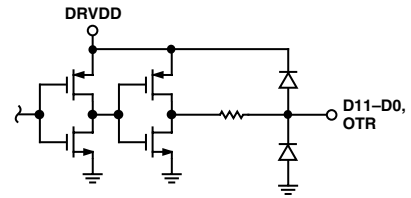

Figure 4. Equivalent Digital Output Circuit

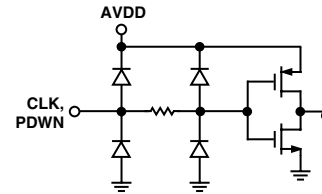

Figure 5. Equivalent Digital Input Circuit



# Typical Performance Characteristics

AD9235

(AVDD = 3.0 V, DRVDD = 2.5 V,  $f_{\text{SAMPLE}} = 65$  MSPS with DCS Disabled,  $T_A = 25^\circ\text{C}$ , 2 V Differential Input,  $A_{\text{IN}} = -0.5$  dBFS,  $V_{\text{REF}} = 1.0$  V, unless otherwise noted.)

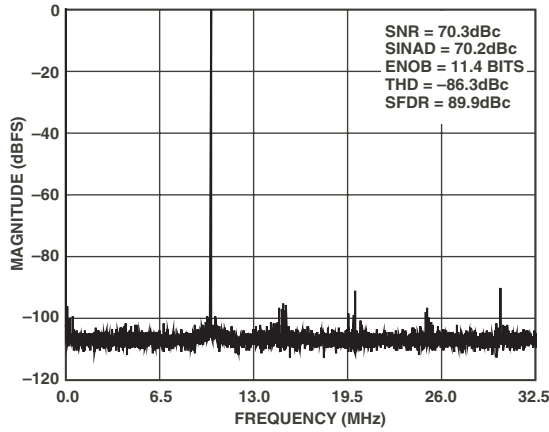

TPC 1. Single Tone 8K FFT with  $f_{\text{IN}} = 10$  MHz

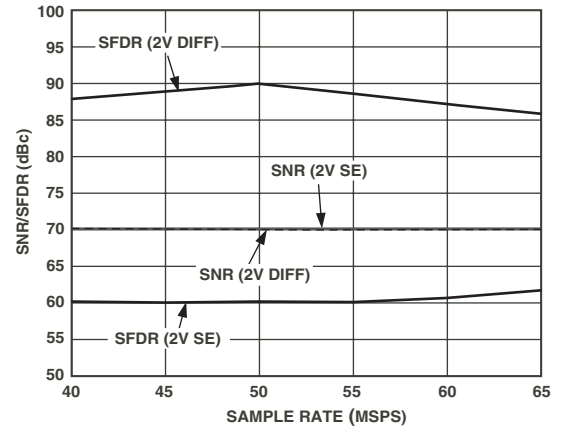

TPC 4. AD9235-65: Single Tone SNR/SFDR vs.  $f_{\text{CLK}}$  with  $f_{\text{IN}} = \text{Nyquist}$  (32.5 MHz)

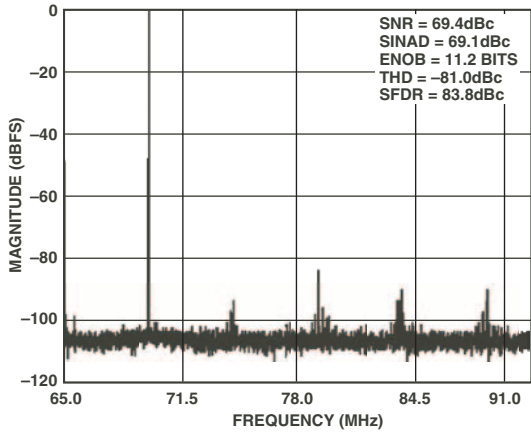

TPC 2. Single Tone 8K FFT with  $f_{\text{IN}} = 70$  MHz

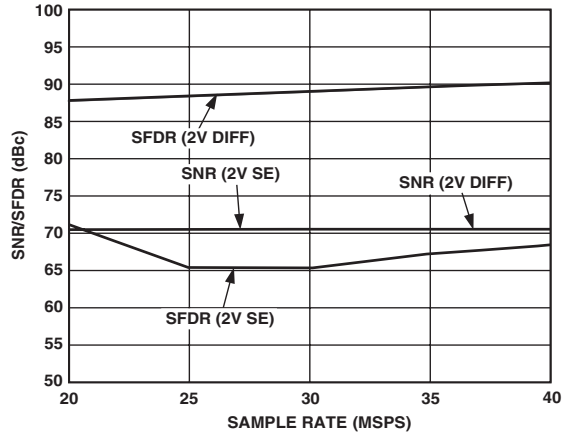

TPC 5. AD9235-40: Single Tone SNR/SFDR vs.  $f_{\text{CLK}}$  with  $f_{\text{IN}} = \text{Nyquist}$  (20 MHz)

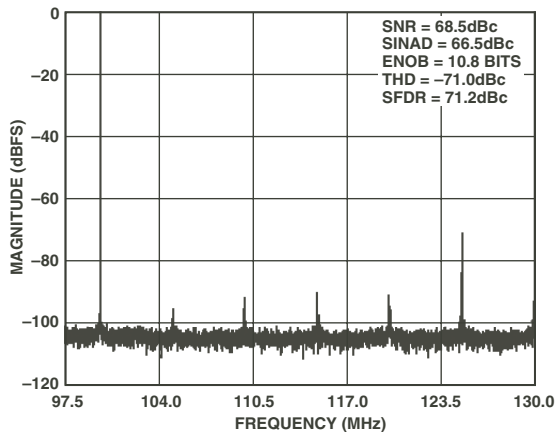

TPC 3. Single Tone 8K FFT with  $f_{\text{IN}} = 100$  MHz

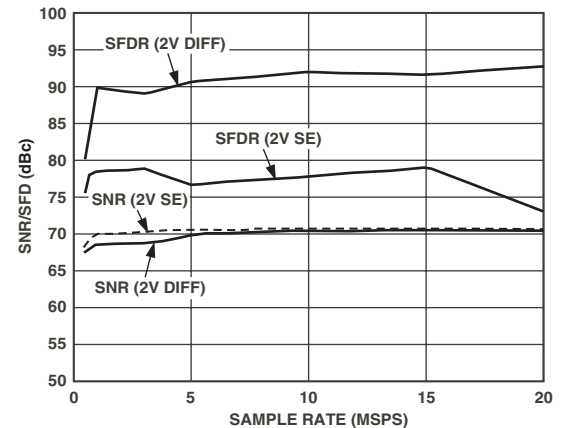

TPC 6. AD9235-20: Single Tone SNR/SFDR vs.  $f_{\text{CLK}}$  with  $f_{\text{IN}} = \text{Nyquist}$  (10 MHz)

# AD9235

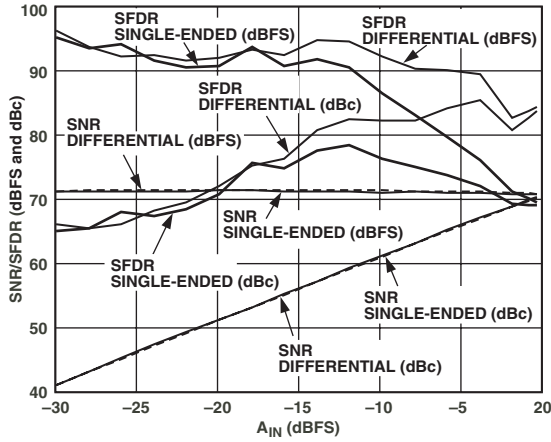

TPC 7. AD9235-65: Single Tone SNR/SFDR vs.  $A_{IN}$  with  $f_{IN} = \text{Nyquist}$  (32.5 MHz)

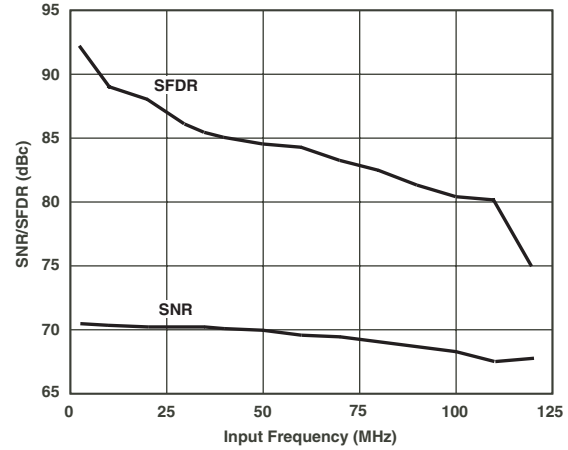

TPC 10. AD9235-65: SNR/SFDR vs.  $f_{IN}$

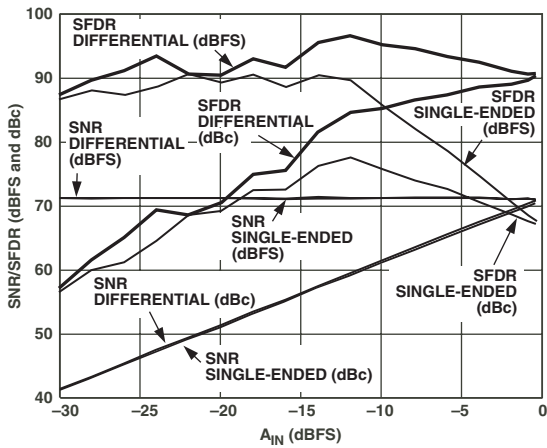

TPC 8. AD9235-40: Single Tone SNR/SFDR vs.  $A_{IN}$  with  $f_{IN} = \text{Nyquist}$  (20 MHz)

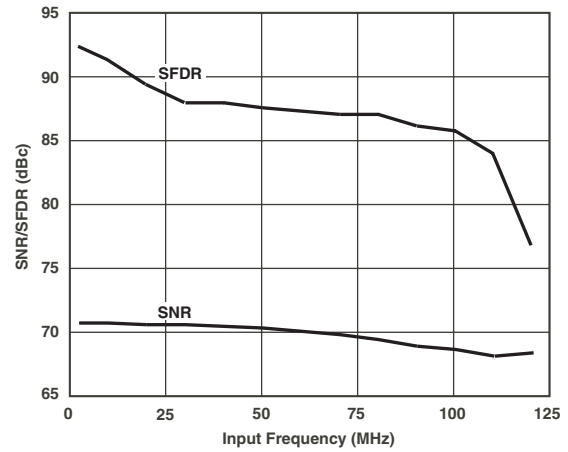

TPC 11. AD9235-40: SNR/SFDR vs.  $f_{IN}$

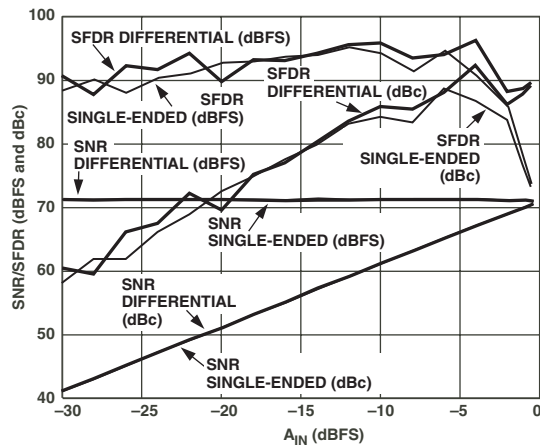

TPC 9. AD9235-20: Single Tone SNR/SFDR vs.  $A_{IN}$  with  $f_{IN} = \text{Nyquist}$  (10 MHz)

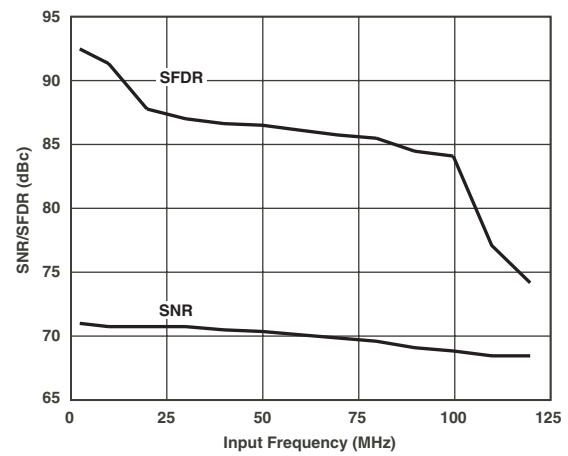

TPC 12. AD9235-20: SNR/SFDR vs.  $f_{IN}$

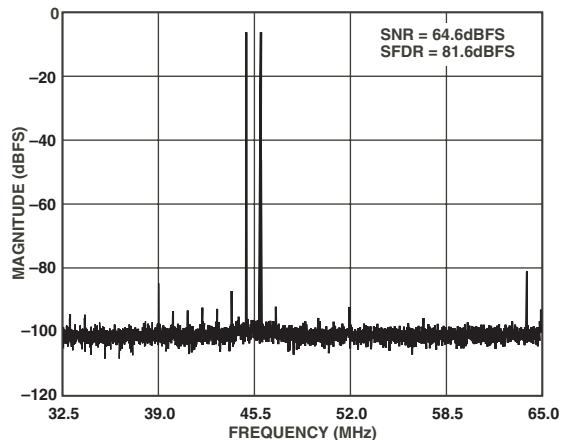

TPC 13. Dual Tone 8K FFT with  $f_{IN1} = 45$  MHz and  $f_{IN2} = 46$  MHz

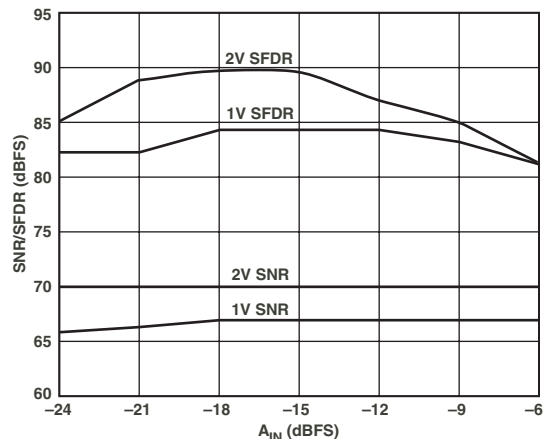

TPC 16. Dual Tone SNR/SFDR vs.  $A_{IN}$  with  $f_{IN1} = 45$  MHz and  $f_{IN2} = 46$  MHz

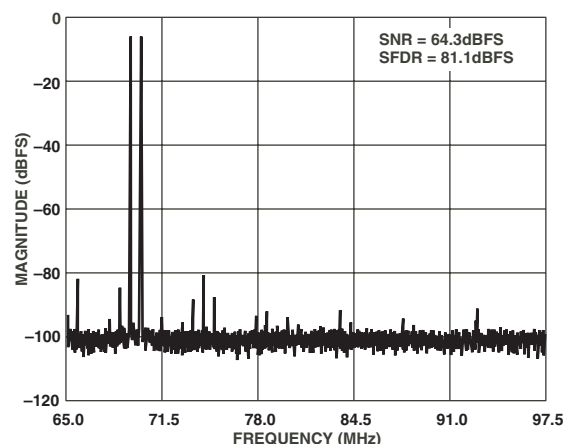

TPC 14. Dual Tone 8K FFT with  $f_{IN1} = 69$  MHz and  $f_{IN2} = 70$  MHz

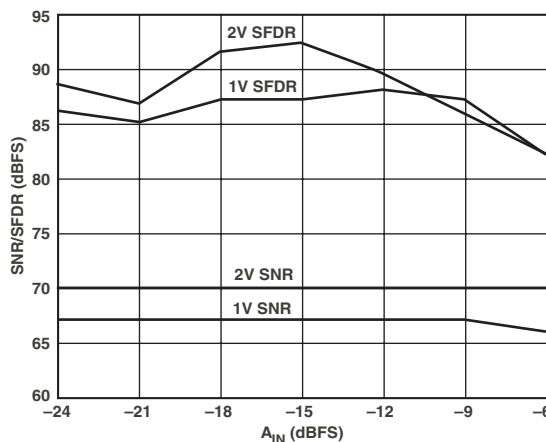

TPC 17. Dual Tone SNR/SFDR vs.  $A_{IN}$  with  $f_{IN1} = 69$  MHz and  $f_{IN2} = 70$  MHz

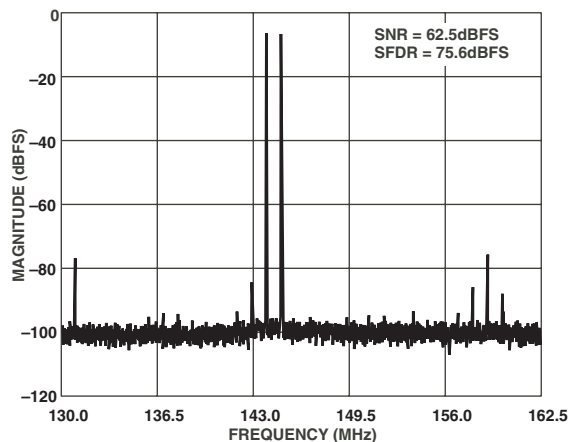

TPC 15. Dual Tone 8K FFT with  $f_{IN1} = 144$  MHz and  $f_{IN2} = 145$  MHz

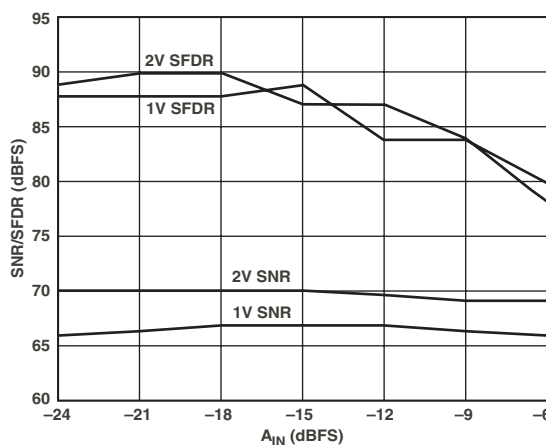

TPC 18. Dual Tone SNR/SFDR vs.  $A_{IN}$  with  $f_{IN1} = 144$  MHz and  $f_{IN2} = 145$  MHz

# AD9235

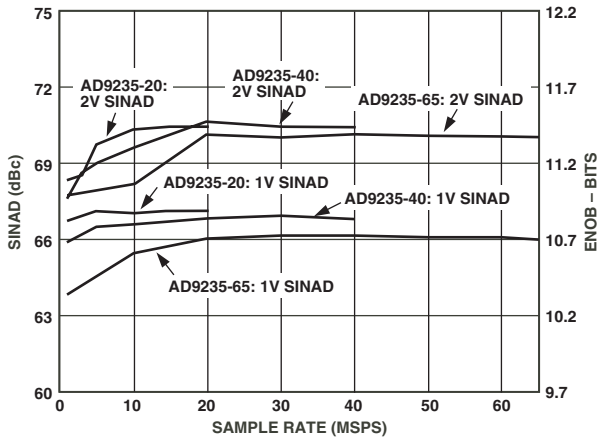

TPC 19. SINAD vs.  $f_{CLK}$  with  $f_{IN} = Nyquist$

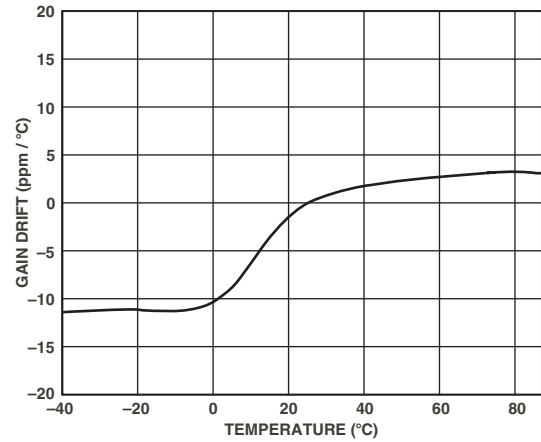

TPC 22. A/D Gain vs. Temperature Using an External Reference

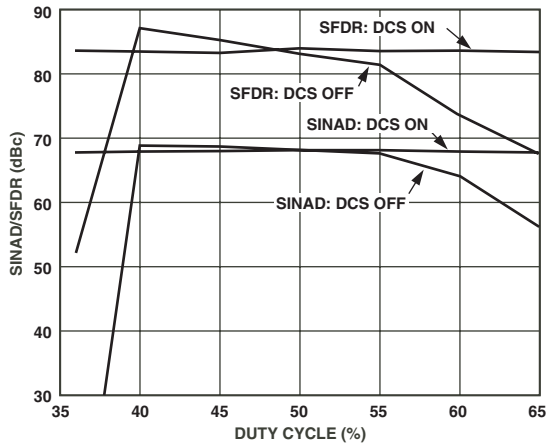

TPC 20. SINAD/SFDR vs. Clock Duty Cycle

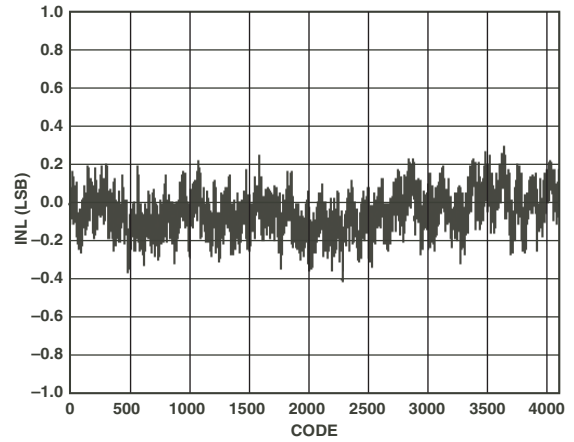

TPC 23. Typical INL

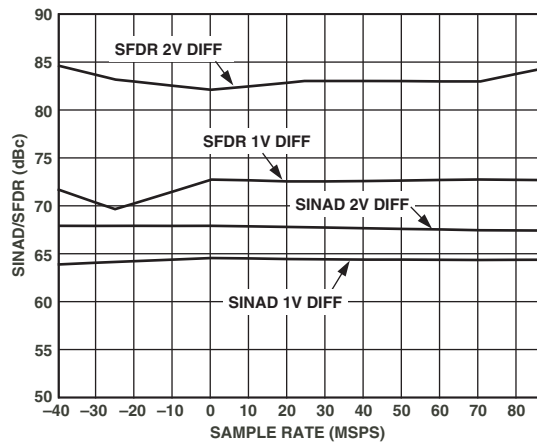

TPC 21. SINAD/SFDR vs. Temperature with  $f_{IN} = 32.5$  MHz

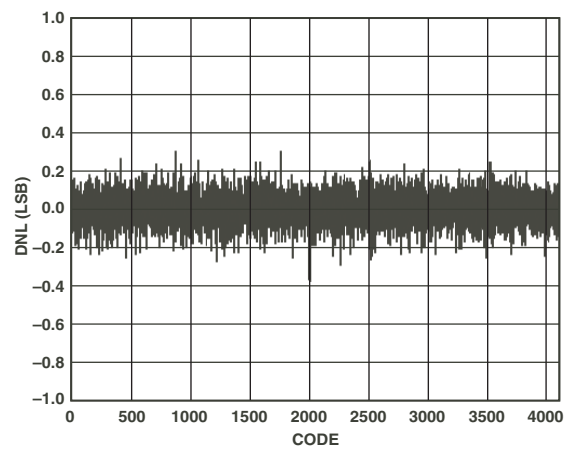

TPC 24. Typical DNL

## APPLYING THE AD9235

### THEORY OF OPERATION

The AD9235 architecture consists of a front-end sample and hold amplifier (SHA) followed by a pipelined switched capacitor ADC. The pipelined ADC is divided into three sections, consisting of a 4-bit first stage followed by eight 1.5-bit stages and a final 3-bit flash. Each stage provides sufficient overlap to correct for flash errors in the preceding stages. The quantized outputs from each stage are combined into a final 12-bit result in the digital correction logic. The pipelined architecture permits the first stage to operate on a new input sample while the remaining stages operate on preceding samples. Sampling occurs on the rising edge of the clock.

Each stage of the pipeline, excluding the last, consists of a low resolution flash ADC connected to a switched capacitor DAC and interstage residue amplifier (MDAC). The residue amplifier magnifies the difference between the reconstructed DAC output and the flash input for the next stage in the pipeline. One bit of redundancy is used in each stage to facilitate digital correction of flash errors. The last stage simply consists of a flash ADC.

The input stage contains a differential SHA that can be ac- or dc-coupled in differential or single-ended modes. The output-staging block aligns the data, carries out the error correction, and passes the data to the output buffers. The output buffers are powered from a separate supply, allowing adjustment of the output voltage swing. During power-down, the output buffers go into a high impedance state.

### ANALOG INPUT

The analog input to the AD9235 is a differential switched capacitor SHA that has been designed for optimum performance while processing a differential input signal. The SHA input can support a wide common-mode range and maintain excellent performance, as shown in Figure 7. An input common-mode voltage of midsupply will minimize signal-dependant errors and provide optimum performance.

Referring to Figure 6, the clock signal alternatively switches the SHA between sample mode and hold mode. When the SHA is switched into sample mode, the signal source must be capable of charging the sample capacitors and settling within one-half of a clock cycle. A small resistor in series with each input can help reduce the peak transient current required from the output stage of the driving source. Also, a small shunt capacitor can be placed across the inputs to provide dynamic charging currents. This passive network will create a low-pass filter at the ADC's input; therefore, the precise values are dependant upon the application. In IF undersampling applications, any shunt capacitors should be removed. In combination with the driving source impedance, they would limit the input bandwidth.

For best dynamic performance, the source impedances driving VIN+ and VIN- should be matched such that common-mode settling errors are symmetrical. These errors will be reduced by the common-mode rejection of the ADC.

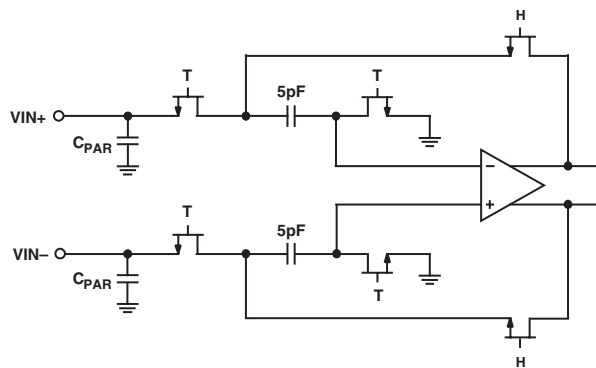

Figure 6. Switched-Capacitor SHA Input

An internal differential reference buffer creates positive and negative reference voltages, REFT and REFB, respectively, that define the span of the ADC core. The output common mode of the reference buffer is set to midsupply, and the REFT and REFB voltages and span are defined as follows:

$$REFT = 1/2 (AVDD + VREF)$$

$$REFB = 1/2 (AVDD - VREF)$$

$$Span = 2 \times (REFT - REFB) = 2 \times VREF$$

It can be seen from the equations above that the REFT and REFB voltages are symmetrical about the midsupply voltage and, by definition, the input span is twice the value of the VREF voltage.

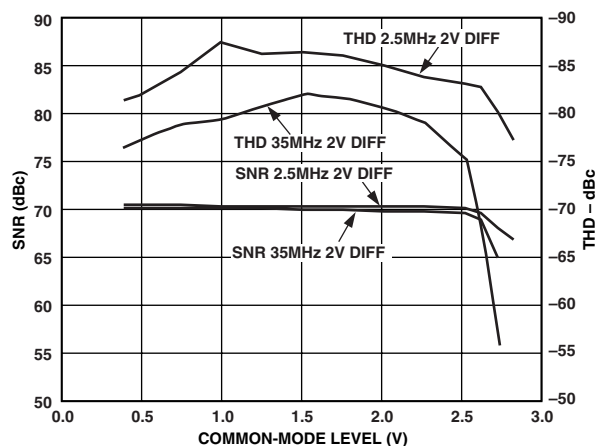

Figure 7. AD9235-65: SNR, THD vs. Common-Mode Level

The internal voltage reference can be pin-strapped to fixed values of 0.5 V or 1.0 V, or adjusted within the same range as discussed in the Internal Reference Connection section. Maximum SNR performance will be achieved with the AD9235 set to the largest input span of 2 V p-p. The relative SNR degradation will be 3 dB when changing from 2 V p-p mode to 1 V p-p mode.

# AD9235

The SHA may be driven from a source that keeps the signal peaks within the allowable range for the selected reference voltage. The minimum and maximum common-mode input levels are defined as follows:

$$VCM_{MIN} = VREF / 2$$

$$VCM_{MAX} = (AVDD + VREF) / 2$$

The minimum common-mode input level allows the AD9235 to accommodate ground-referenced inputs.

Although optimum performance is achieved with a differential input, a single-ended source may be driven into VIN+ or VIN-. In this configuration, one input will accept the signal, while the opposite input should be set to midscale by connecting it to an appropriate reference. For example, a 2 V p-p signal may be applied to VIN+ while a 1 V reference is applied to VIN-. The AD9235 will then accept an input signal varying between 2 V and 0 V. In the single-ended configuration, distortion performance may degrade significantly as compared to the differential case. However, the effect will be less noticeable at lower input frequencies and in the lower speed grade models (AD9235-40 and AD9235-20).

### Differential Input Configurations

As previously detailed, optimum performance will be achieved while driving the AD9235 in a differential input configuration. For baseband applications, the AD8138 differential driver provides excellent performance and a flexible interface to the ADC. The output common-mode voltage of the AD8138 is easily set to AVDD/2, and the driver can be configured in a Sallen Key filter topology to provide band limiting of the input signal.

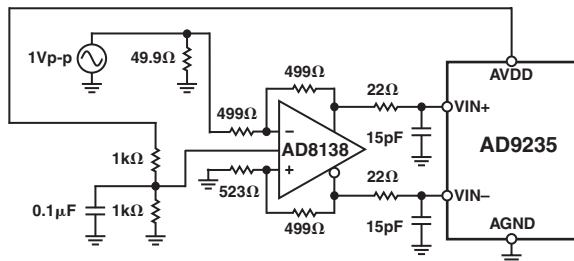

Figure 8. Differential Input Configuration Using the AD8138

At input frequencies in the second Nyquist zone and above, the performance of most amplifiers will not be adequate to achieve the true performance of the AD9235. This is especially true in IF undersampling applications where frequencies in the 70 MHz to 100 MHz range are being sampled. For these applications, differential transformer coupling is the recommended input configuration, as shown in Figure 9.

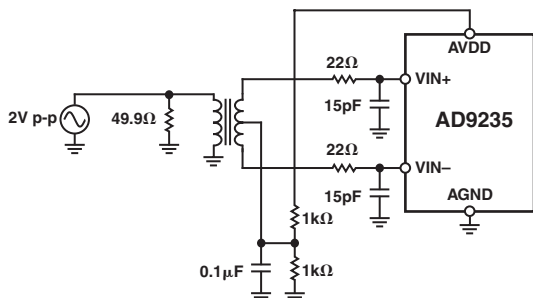

Figure 9. Differential Transformer-Coupled Configuration

The signal characteristics must be considered when selecting a transformer. Most RF transformers will saturate at frequencies below a few MHz, and excessive signal power can also cause core saturation, which leads to distortion.

### Single-Ended Input Configuration

A single-ended input may provide adequate performance in cost-sensitive applications. In this configuration, there will be a degradation in SFDR and in distortion performance due to the large input common-mode swing. However, if the source impedances on each input are matched, there should be little effect on SNR performance. Figure 10 details a typical single-ended input configuration.

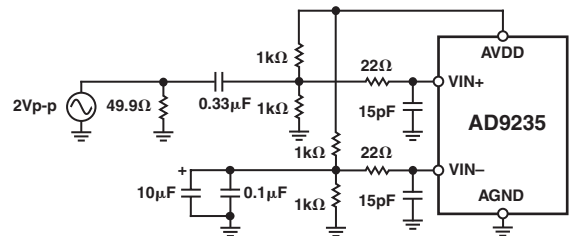

Figure 10. Single-Ended Input Configuration

### CLOCK INPUT CONSIDERATIONS

Typical high speed ADCs use both clock edges to generate a variety of internal timing signals, and as a result may be sensitive to clock duty cycle. Commonly a 5% tolerance is required on the clock duty cycle to maintain dynamic performance characteristics. The AD9235 contains a clock duty cycle stabilizer (DCS) that retimes the nonsampling edge, providing an internal clock signal with a nominal 50% duty cycle. This allows a wide range of clock input duty cycles without affecting the performance of the AD9235. As shown in TPC 20, noise and distortion performance are nearly flat over a 30% range of duty cycle.

The duty cycle stabilizer uses a delay-locked loop (DLL) to create the nonsampling edge. As a result, any changes to the sampling frequency will require approximately 100 clock cycles to allow the DLL to acquire and lock to the new rate.

High speed, high resolution ADCs are sensitive to the quality of the clock input. The degradation in SNR at a given full-scale input frequency ( $f_{INPUT}$ ) due only to aperture jitter ( $t_j$ ) can be calculated with the following equation.

$$SNR \text{ Degradation} = 20 \times \log_{10} \left[ \frac{1}{2} \times \pi \times f_{INPUT} \times t_j \right]$$

In the equation, the rms aperture jitter,  $t_j$ , represents the root-sum square of all jitter sources, which include the clock input, analog input signal, and ADC aperture jitter specification. Under-sampling applications are particularly sensitive to jitter.

The clock input should be treated as an analog signal in cases where aperture jitter may affect the dynamic range of the AD9235. Power supplies for clock drivers should be separated from the ADC output driver supplies to avoid modulating the clock signal with digital noise. Low jitter, crystal-controlled oscillators make the best clock sources. If the clock is generated from another type of source (by gating, dividing, or other methods), it should be retimed by the original clock at the last step.



## POWER DISSIPATION AND STANDBY MODE

As shown in Figure 11, the power dissipated by the AD9235 is proportional to its sample rate. The digital power dissipation does not vary substantially between the three speed grades because it is determined primarily by the strength of the digital drivers and the load on each output bit. The maximum DRVDD current can be calculated as

$$I_{DRVDD} = V_{DRVDD} \times C_{LOAD} \times f_{CLK} \times N$$

where  $N$  is the number of output bits, 12 in the case of the AD9235. This maximum current occurs when every output bit switches on every clock cycle, i.e., a full-scale square wave at the Nyquist frequency,  $f_{CLK}/2$ . In practice, the DRVDD current will be established by the average number of output bits switching, which will be determined by the encode rate and the characteristics of the analog input signal.

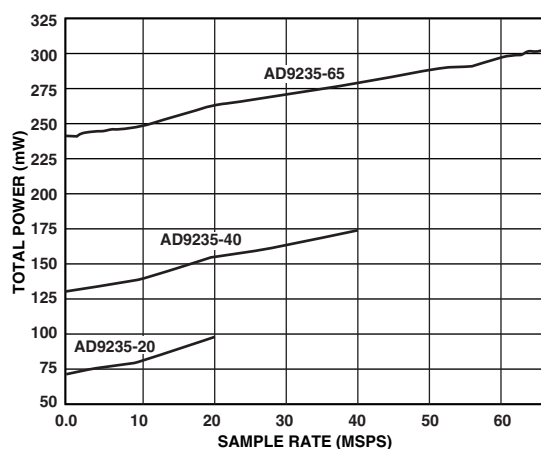

Figure 11. Total Power vs. Sample Rate with  $f_{IN} = 10$  MHz

For the AD9235-20 speed grade, the digital power consumption can represent as much as 10% of the total dissipation. Digital power consumption can be minimized by reducing the capacitive load presented to the output drivers. The data in Figure 11 was taken with a 5 pF load on each output driver.

The analog circuitry is optimally biased so that each speed grade provides excellent performance while affording reduced power consumption. Each speed grade dissipates a baseline power at low sample rates that increases linearly with the clock frequency.

By asserting the PDWN pin high, the AD9235 is placed in standby mode. In this state, the ADC will typically dissipate 1 mW if the CLK and analog inputs are static. During standby, the output drivers are placed in a high impedance state. Reasserting the PDWN pin low returns the AD9235 into its normal operational mode.

Low power dissipation in standby mode is achieved by shutting down the reference, reference buffer, and biasing networks. The decoupling capacitors on REFT and REFB are discharged when entering standby mode, and then must be recharged when returning to normal operation. As a result, the wake-up time is related to the time spent in standby mode and shorter standby cycles will result in proportionally shorter wake-up times. With the recommended 0.1  $\mu$ F and 10  $\mu$ F decoupling capacitors on REFT and REFB, it takes approximately 1 sec to fully discharge the reference buffer decoupling capacitors and 3 ms to restore full operation.

## DIGITAL OUTPUTS

The AD9235 output drivers can be configured to interface with 2.5 V or 3.3 V logic families by matching DRVDD to the digital supply of the interfaced logic. The output drivers are sized to provide sufficient output current to drive a wide variety of logic families. However, large drive currents tend to cause current glitches on the supplies that may affect converter performance. Applications requiring the ADC to drive large capacitive loads or large fan-outs may require external buffers or latches.

As detailed in Table II, the data format can be selected for either offset binary or twos complement.

## Timing

The AD9235 provides latched data outputs with a pipeline delay of seven clock cycles. Data outputs are available one propagation delay ( $t_{PD}$ ) after the rising edge of the clock signal. Refer to Figure 1 for a detailed timing diagram.

The length of the output data lines and loads placed on them should be minimized to reduce transients within the AD9235; these transients can detract from the converter's dynamic performance.

The lowest typical conversion rate of the AD9235 is 1 MSPS. At clock rates below 1 MSPS, dynamic performance may degrade.

## VOLTAGE REFERENCE

A stable and accurate 0.5 V voltage reference is built into the AD9235. The input range can be adjusted by varying the reference voltage applied to the AD9235, using either the internal reference or an externally applied reference voltage. The input span of the ADC tracks reference voltage changes linearly.

If the ADC is being driven differentially through a transformer, the reference voltage can be used to bias the center tap (common-mode voltage).

## Internal Reference Connection

A comparator within the AD9235 detects the potential at the SENSE pin and configures the reference into one of four possible states, which are summarized in Table I. If SENSE is grounded,

Table I. Reference Configuration Summary

| Selected Mode            | SENSE Voltage | Internal Switch Position | Resulting VREF (V)       | Resulting Differential Span (V p-p) |
|--------------------------|---------------|--------------------------|--------------------------|-------------------------------------|
| External Reference       | AVDD          | N/A                      | N/A                      | $2 \times$ External Reference       |
| Internal Fixed Reference | VREF          | SENSE                    | 0.5                      | 1.0                                 |
| Programmable Reference   | 0.2 V to VREF | SENSE                    | $0.5 \times (1 + R2/R1)$ | $2 \times$ VREF (See Figure 13)     |
| Internal Fixed Reference | AGND to 0.2 V | Internal Divider         | 1.0                      | 2.0                                 |

# AD9235

reference amplifier switch is connected to the internal resistor divider (see Figure 12), setting VREF to 1 V. Connecting the SENSE pin to VREF switches the reference amplifier output to the SENSE pin, completing the loop and providing a 0.5 V reference output. If a resistor divider is connected as shown in Figure 13, the switch will again be set to the SENSE pin. This will put the reference amplifier in a noninverting mode with the VREF output defined as follows.

$$V_{REF} = 0.5 \times (1 + R2/R1)$$

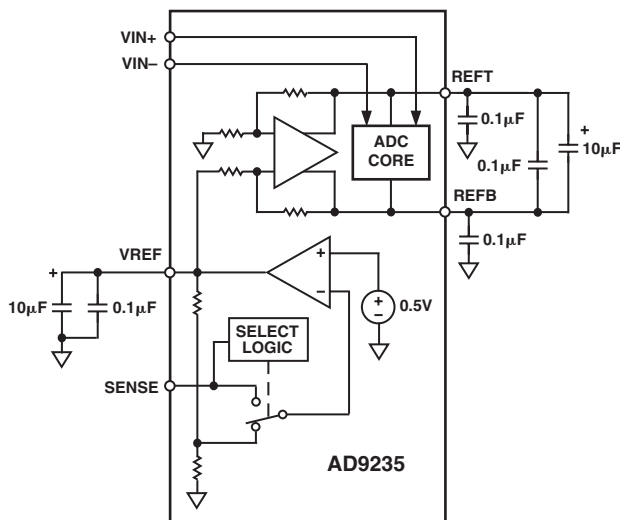

Figure 12. Internal Reference Configuration

In all reference configurations, REFT and REFB drive the A/D conversion core and establish its input span. The input range of the ADC always equals twice the voltage at the reference pin for either an internal or an external reference.

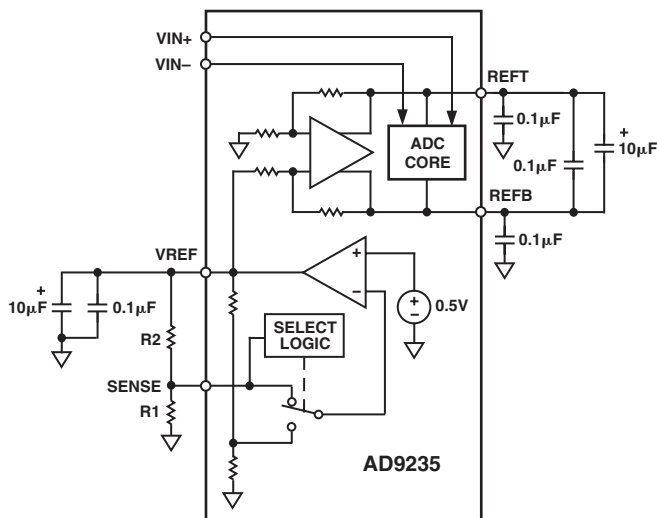

Figure 13. Programmable Reference Configuration

## External Reference Operation

The use of an external reference may be necessary to enhance the gain accuracy of the ADC or improve thermal drift characteristics. When multiple ADCs track one another, a single reference (internal or external) may be necessary to reduce gain matching errors to an acceptable level. A high precision external reference may also be selected to provide lower gain and offset temperature drift. Figure 14 shows the typical drift characteristics of the internal reference in both 1 V and 0.5 V modes.

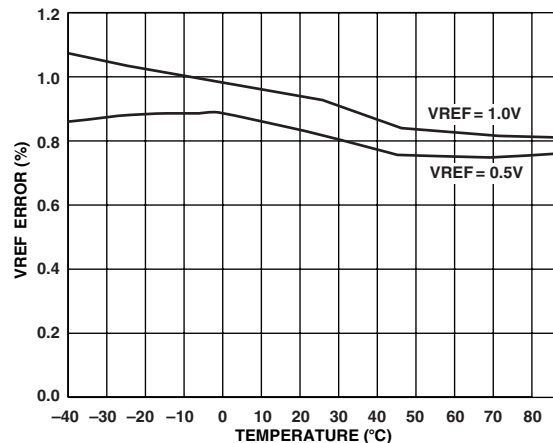

Figure 14. Typical VREF Drift

When the SENSE pin is tied to AVDD, the internal reference will be disabled, allowing the use of an external reference. An internal reference buffer will load the external reference with an equivalent 7 kΩ load. The internal buffer will still generate the positive and negative full-scale references, REFT and REFB, for the ADC core. The input span will always be twice the value of the reference voltage; therefore, the external reference must be limited to a maximum of 1 V.

If the internal reference of the AD9235 is used to drive multiple converters to improve gain matching, the loading of the reference by the other converters must be considered. Figure 15 depicts how the internal reference voltage is affected by loading.

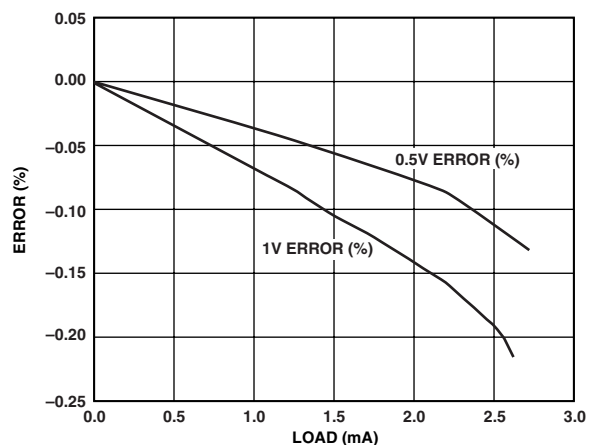

Figure 15. VREF Accuracy vs. Load



## OPERATIONAL MODE SELECTION

As discussed earlier, the AD9235 can output data in either offset binary or twos complement format. There is also a provision for enabling or disabling the clock duty cycle stabilizer (DCS). The MODE pin is a multilevel input that controls the data format and DCS state. The input threshold values and corresponding mode selections are outlined below.

**Table II. Mode Selection**

| MODE Voltage   | Data Format     | Duty Cycle Stabilizer |
|----------------|-----------------|-----------------------|
| AVDD           | Twos Complement | Disabled              |
| 2/3 AVDD       | Twos Complement | Enabled               |
| 1/3 AVDD       | Offset Binary   | Enabled               |
| AGND (Default) | Offset Binary   | Disabled              |

The MODE pin is internally pulled down to AGND by a 20 k $\Omega$  resistor.

## TSSOP EVALUATION BOARD

The AD9235 evaluation board provides all of the support circuitry required to operate the ADC in its various modes and configurations. The converter can be driven differentially, through an AD8138 driver or a transformer, or single-ended. Separate power pins are provided to isolate the DUT from the support circuitry. Each input configuration can be selected by proper connection of various jumpers (refer to the schematics). Figure 16 shows the typical bench characterization setup used to evaluate the ac performance of the AD9235. It is critical that signal sources with very low phase noise (<1 ps rms jitter) be used to realize the ultimate performance of the converter. Proper filtering of the input signal, to remove harmonics and lower the integrated noise at the input, is also necessary to achieve the specified noise performance.

The AUXCLK input should be selected in applications requiring the lowest jitter and SNR performance (i.e., IF undersampling characterization). It allows the user to apply a clock input signal that is 4 $\times$  the target sample rate of the AD9235. A low-jitter, differential divide-by-4 counter, the MC100LVEL33D, provides a 1 $\times$  clock output that is subsequently returned back to the CLK input via JP9. For example, a 260 MHz signal (sinusoid) will be divided down to a 65 MHz signal for clocking the ADC. Note that R1 must be removed with the AUXCLK interface. Lower jitter is often achieved with this interface since many RF signal generators display improved phase noise at higher output frequencies and the slew rate of the sinusoidal output signal is 4 $\times$  that of a 1 $\times$  signal of equal amplitude.

Complete schematics and layout plots follow and demonstrate the proper routing and grounding techniques that should be applied at the system level.

## LCSP EVALUATION BOARD

The typical bench setup used to evaluate the ac performance of the AD9235 is similar to the TSSOP Evaluation Board connections (refer to the schematics for connection details). The AD9235 can be driven single-ended or differentially through a transformer. Separate power pins are provided to isolate the DUT from the support circuitry. Each input configuration can be selected by proper connection of various jumpers (refer to the schematics).

An alternative differential analog input path using an AD8351 op amp is included in the layout but is not populated in production. Designers interested in evaluating the op amp with the ADC should remove C15, R12, and R3 and populate the op amp circuit. The passive network between the AD8351 outputs and the AD9235 allows the user to optimize the frequency response of the op amp for the application.

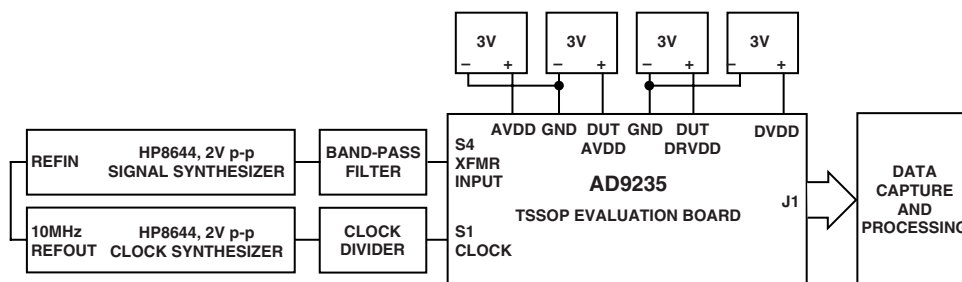

*Figure 16. TSSOP Evaluation Board Connections*

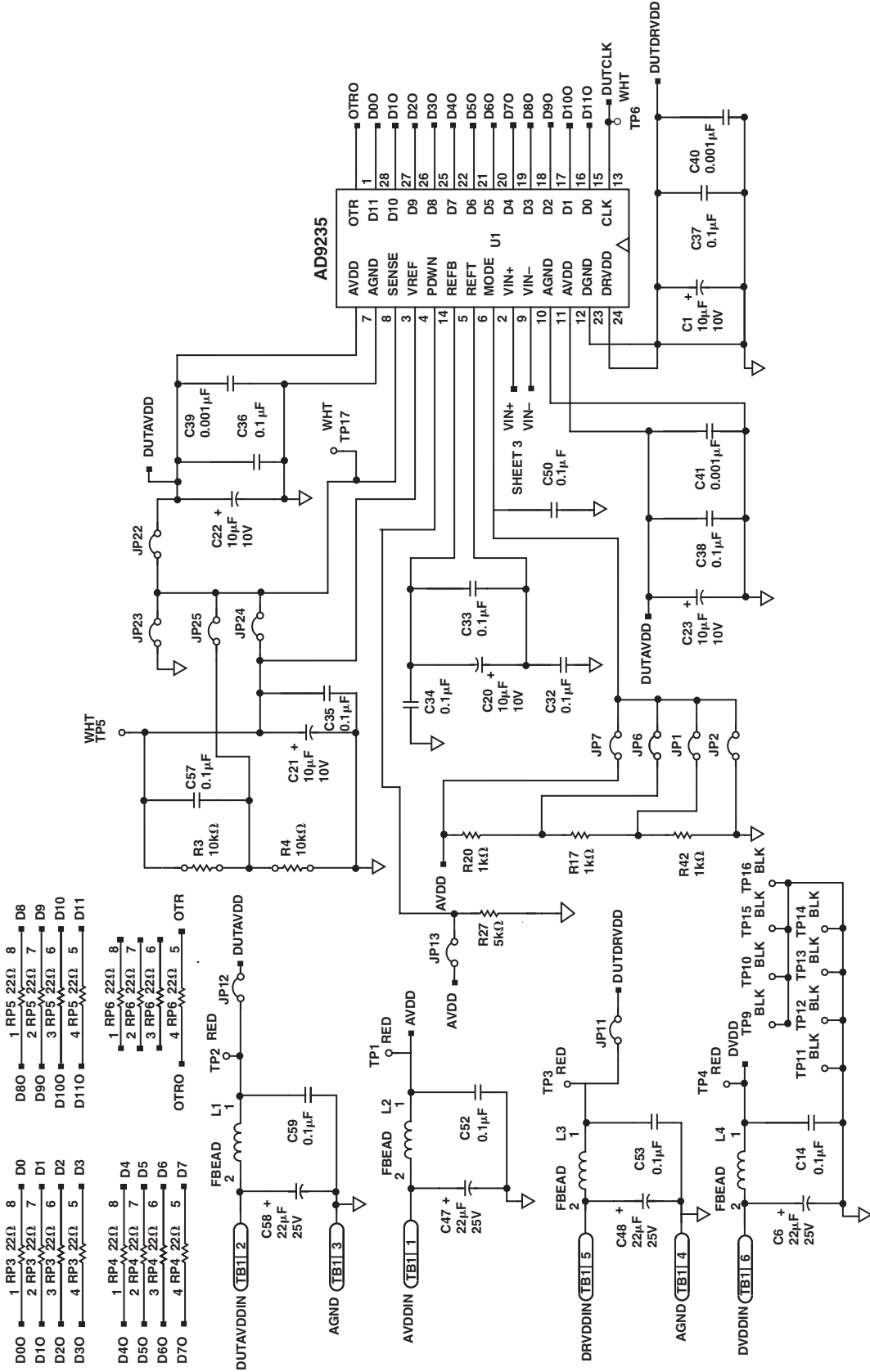

Figure 17. TSSOP Evaluation Board Schematic, DUT

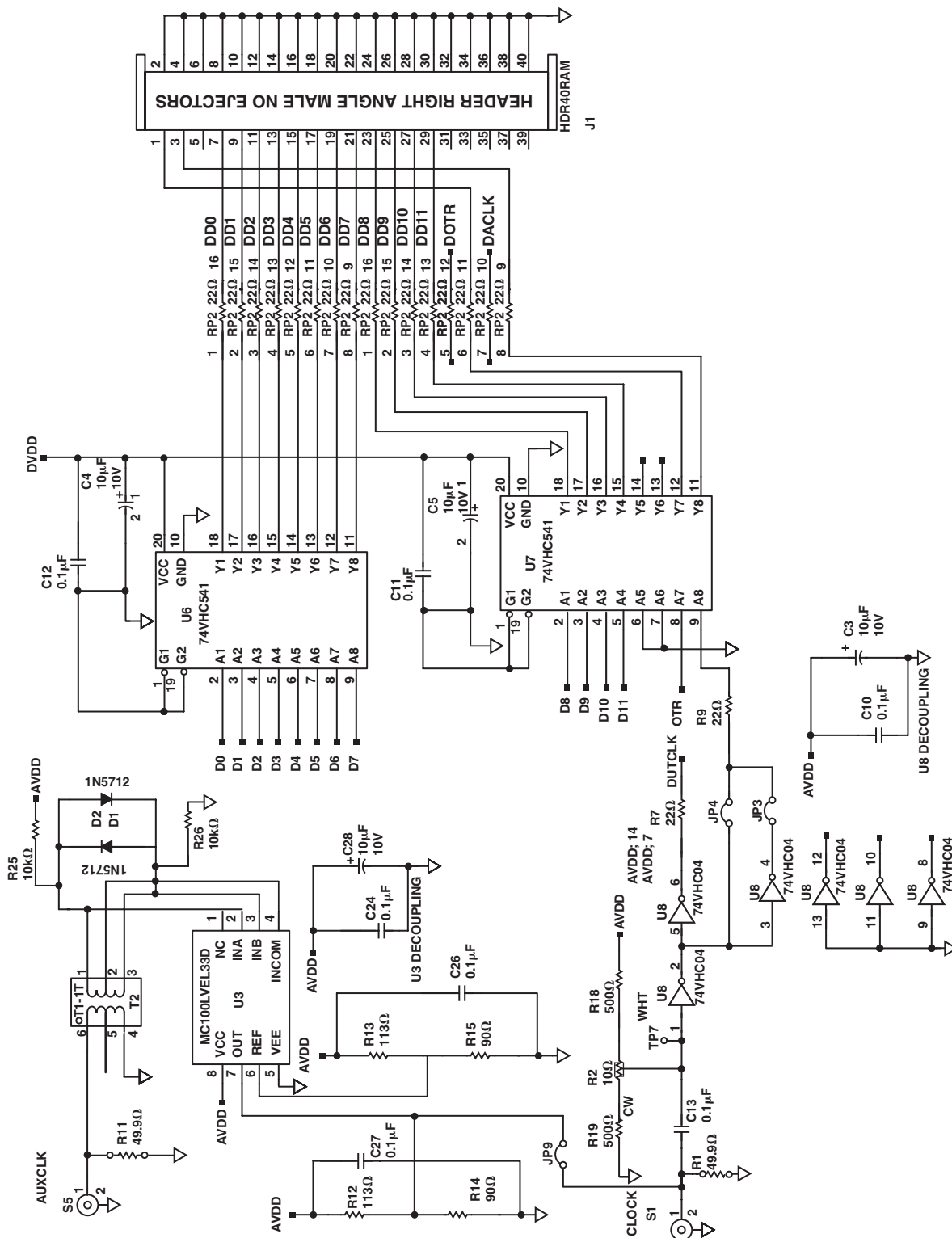

Figure 18. TSSOP Evaluation Board Schematic, Clock Inputs and Output Buffering

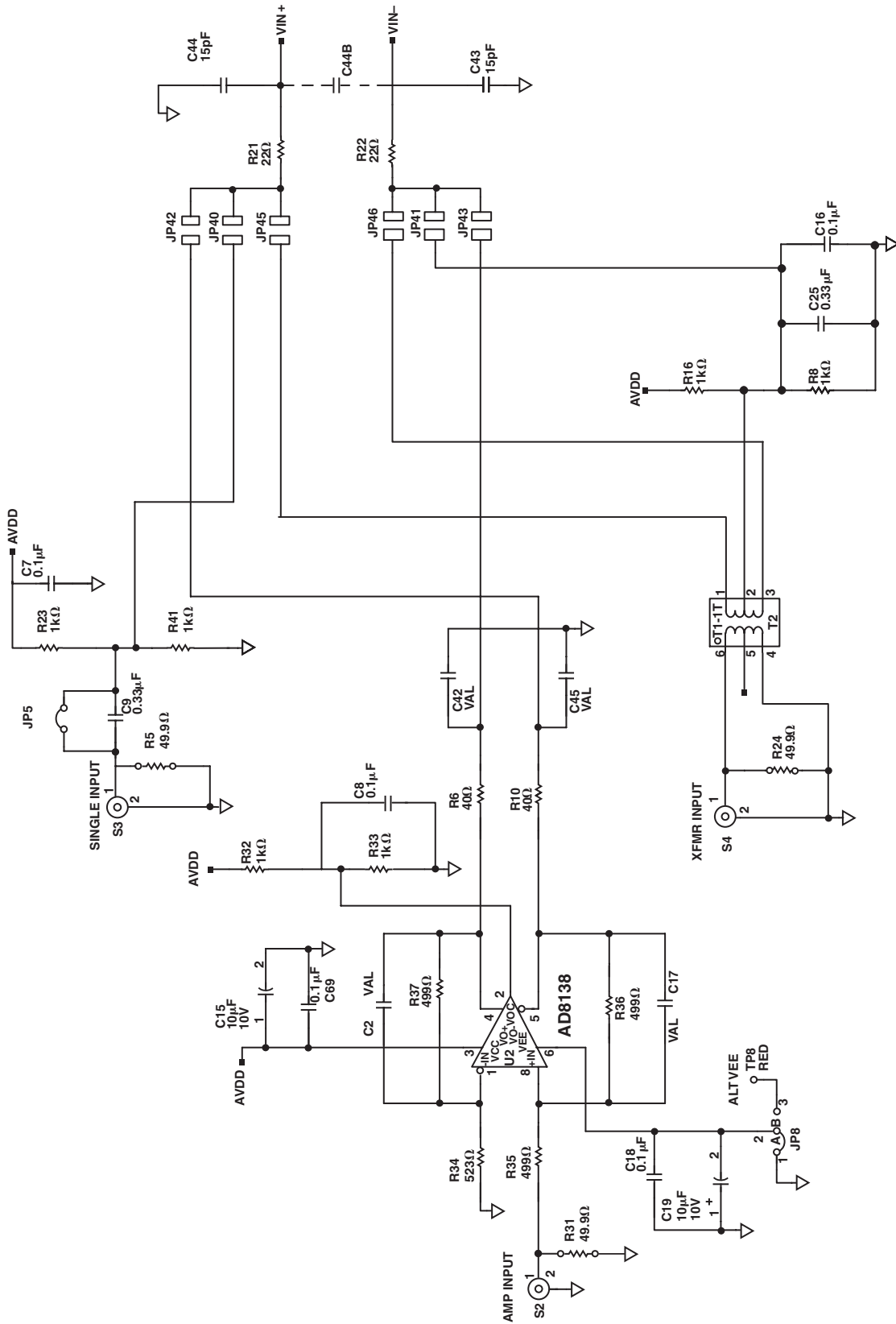

Figure 19. TSSOP Evaluation Board Schematic, Analog Inputs

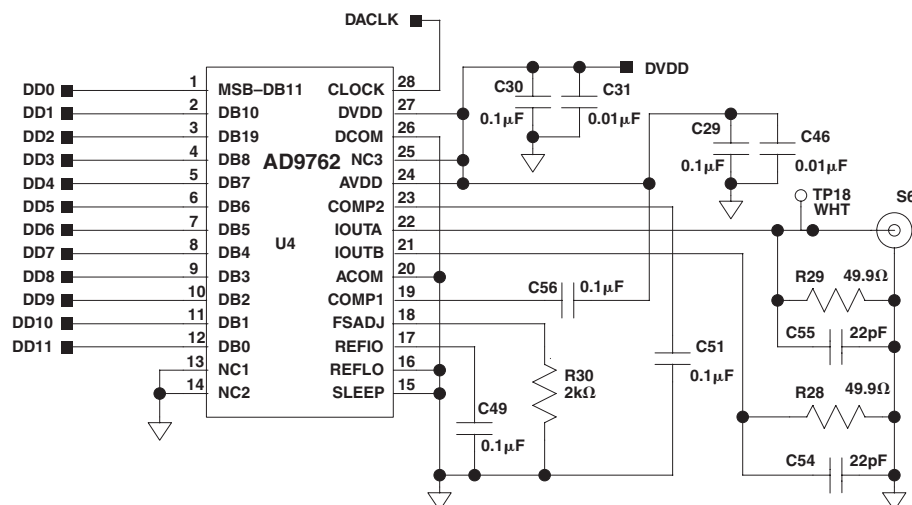

Figure 20. TSSOP Evaluation Board Schematic, Optional D/A Converter

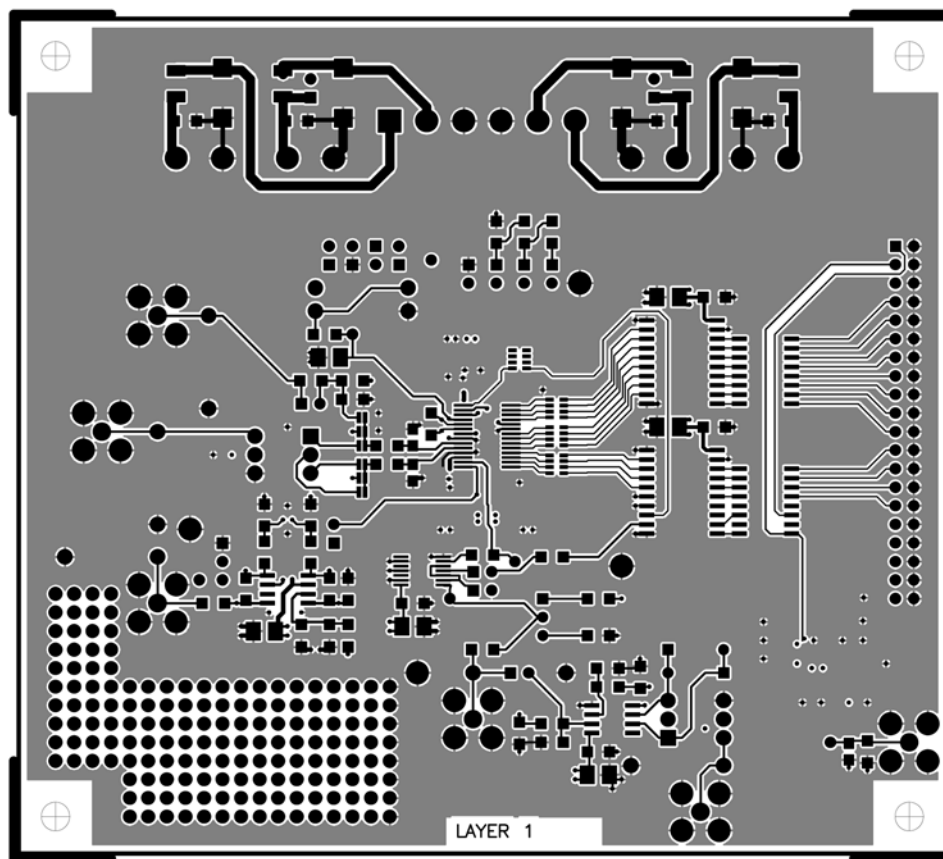

Figure 21. TSSOP Evaluation Board Layout, Primary Side

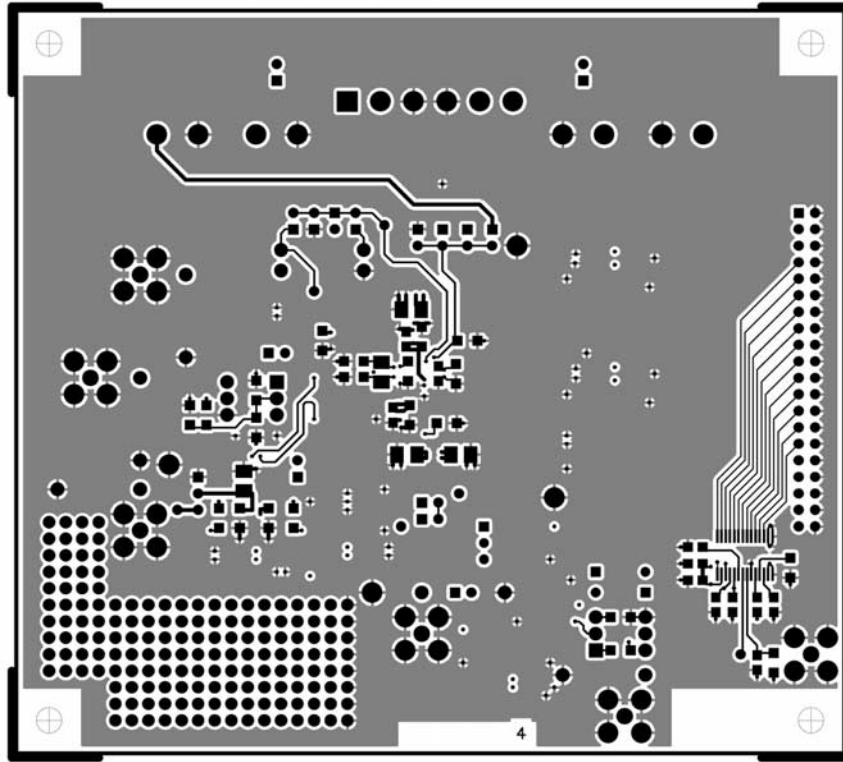

Figure 22. TSSOP Evaluation Board Layout, Secondary Side

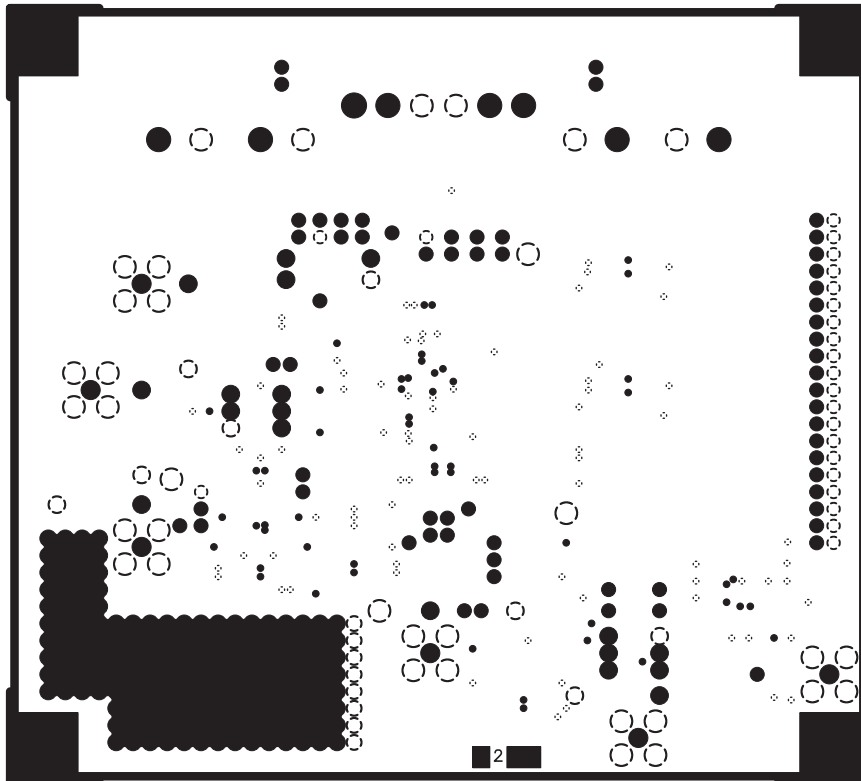

Figure 23. TSSOP Evaluation Board Layout, Ground Plane

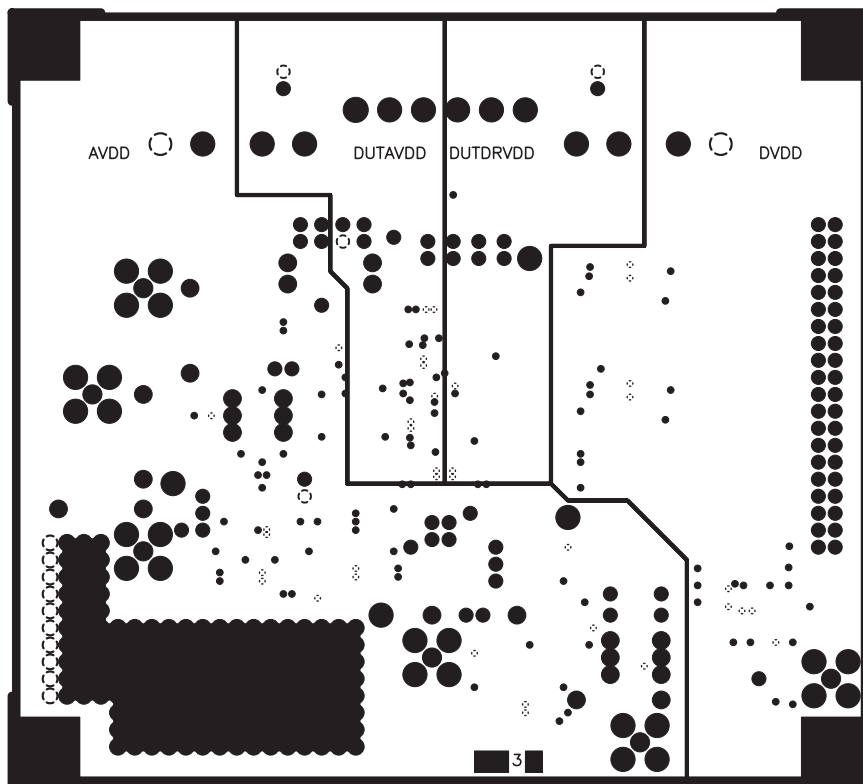

Figure 24. TSSOP Evaluation Board Power Plane

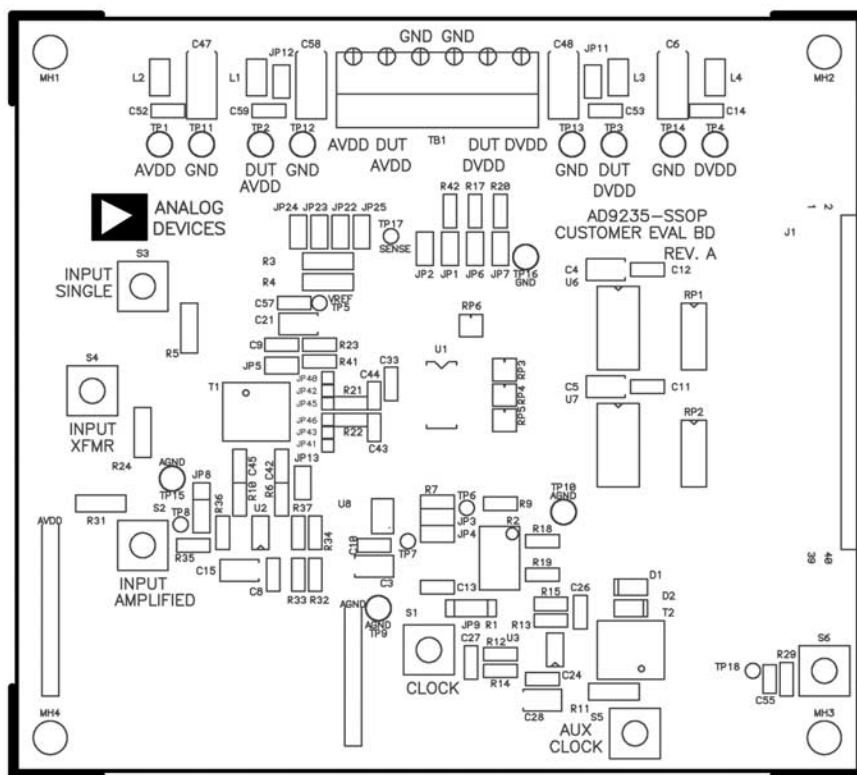

Figure 25. TSSOP Evaluation Board Layout, Primary Silkscreen

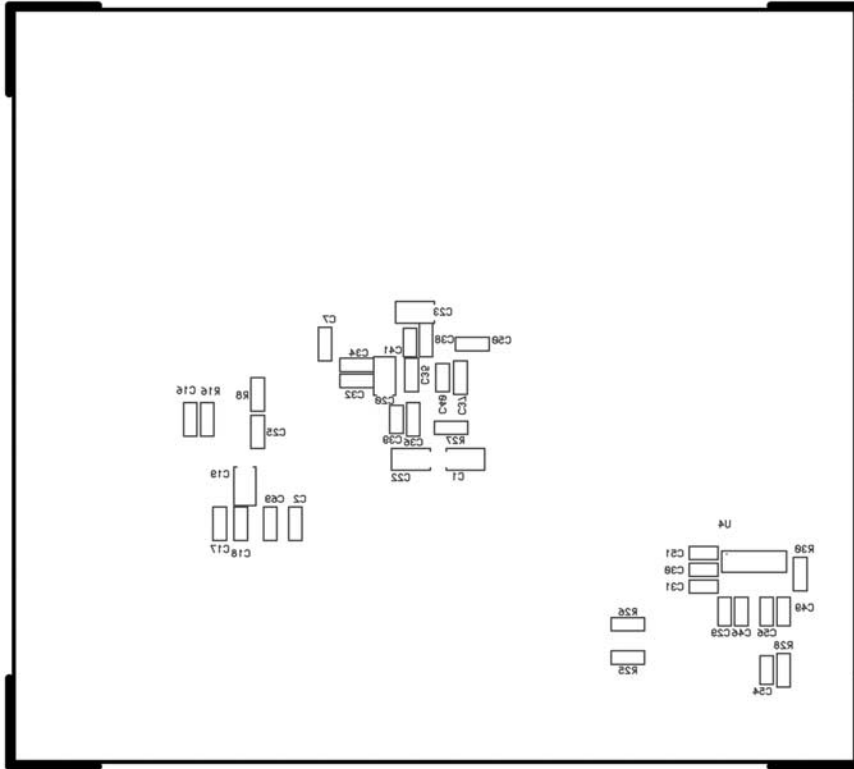

Figure 26. TSSOP Evaluation Board Layout, Secondary Silkscreen



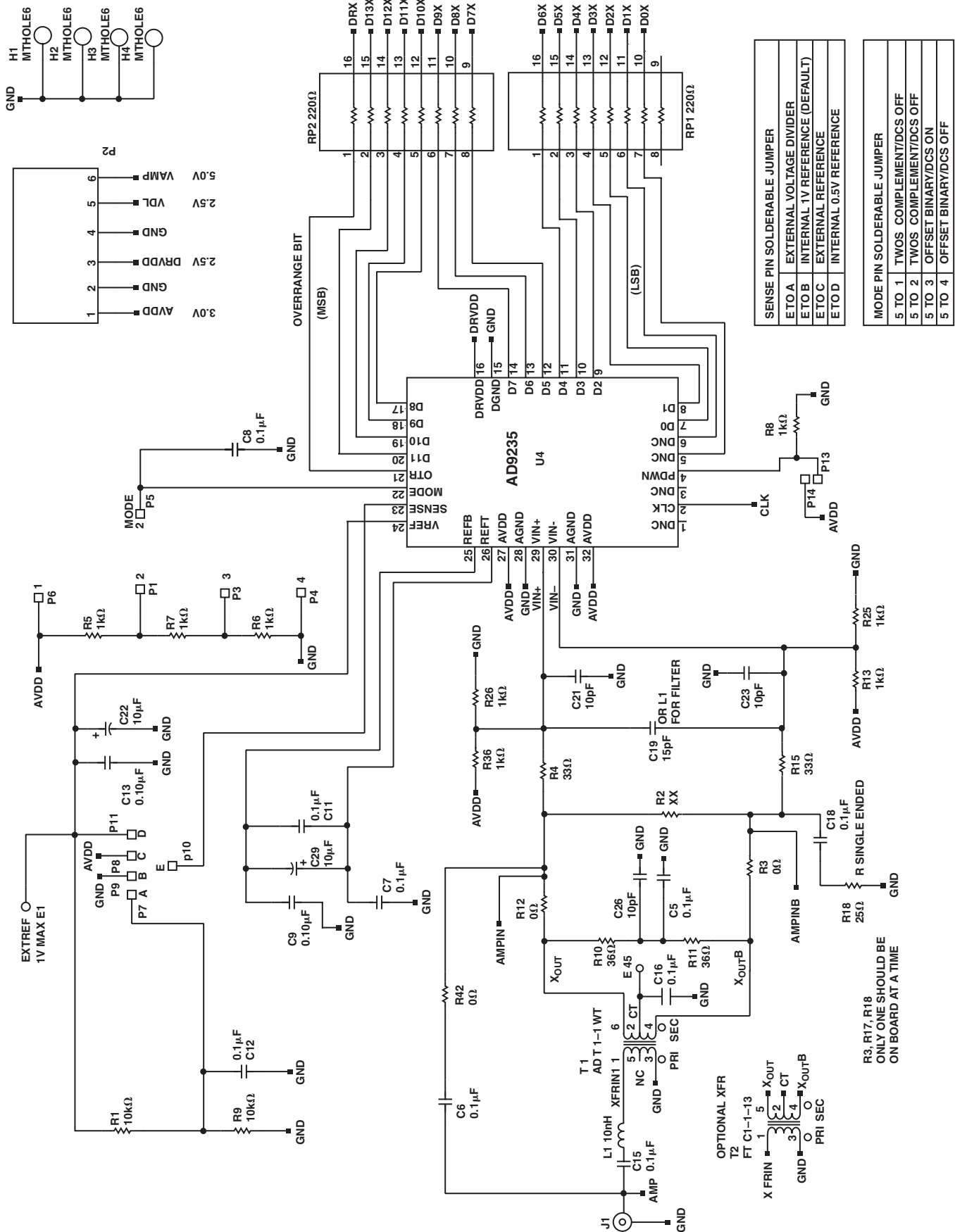

Figure 27. LFCSP Evaluation Board Schematic, Analog Inputs and DUT

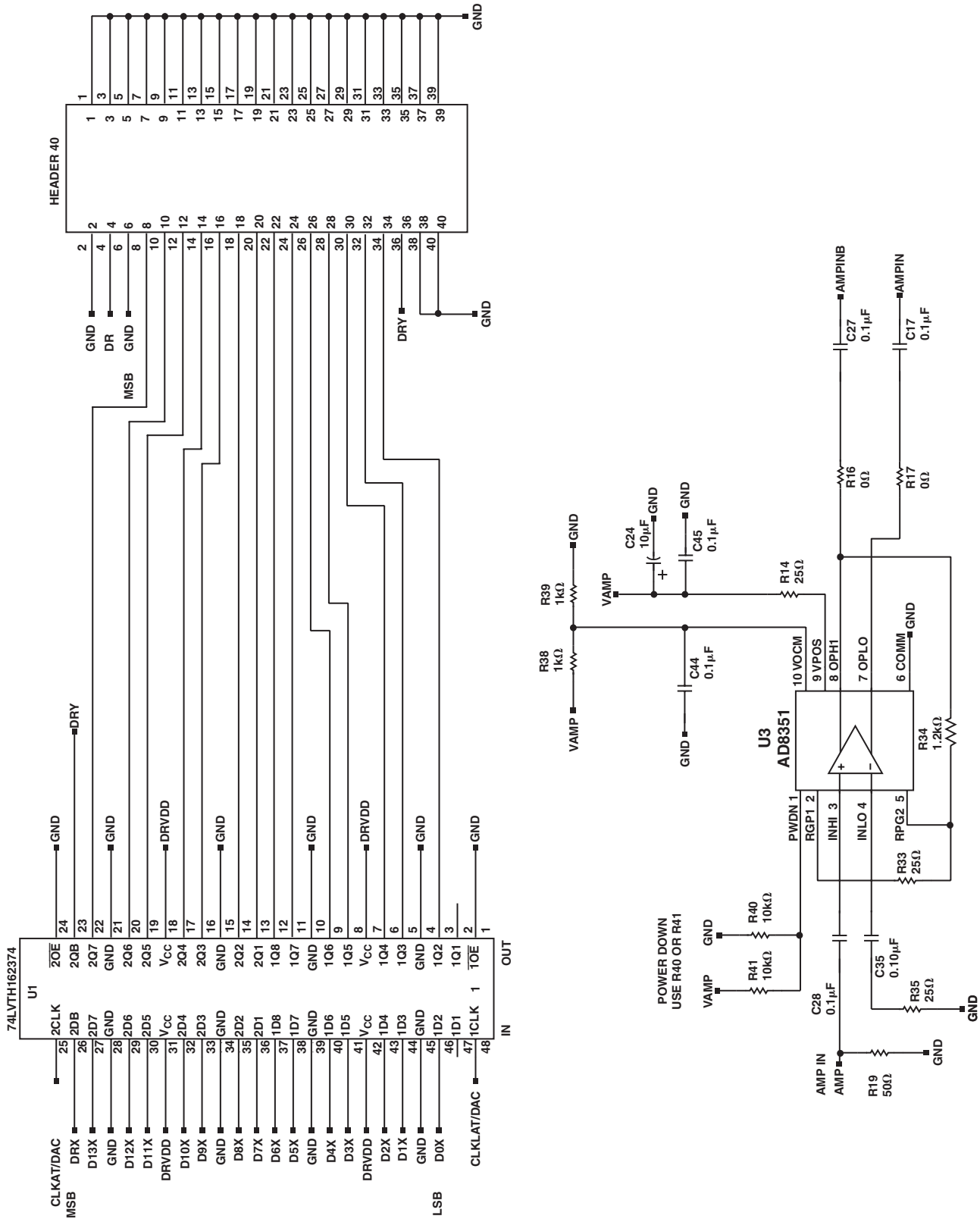

Figure 28. LFCSP Evaluation Board Schematic, Digital Path

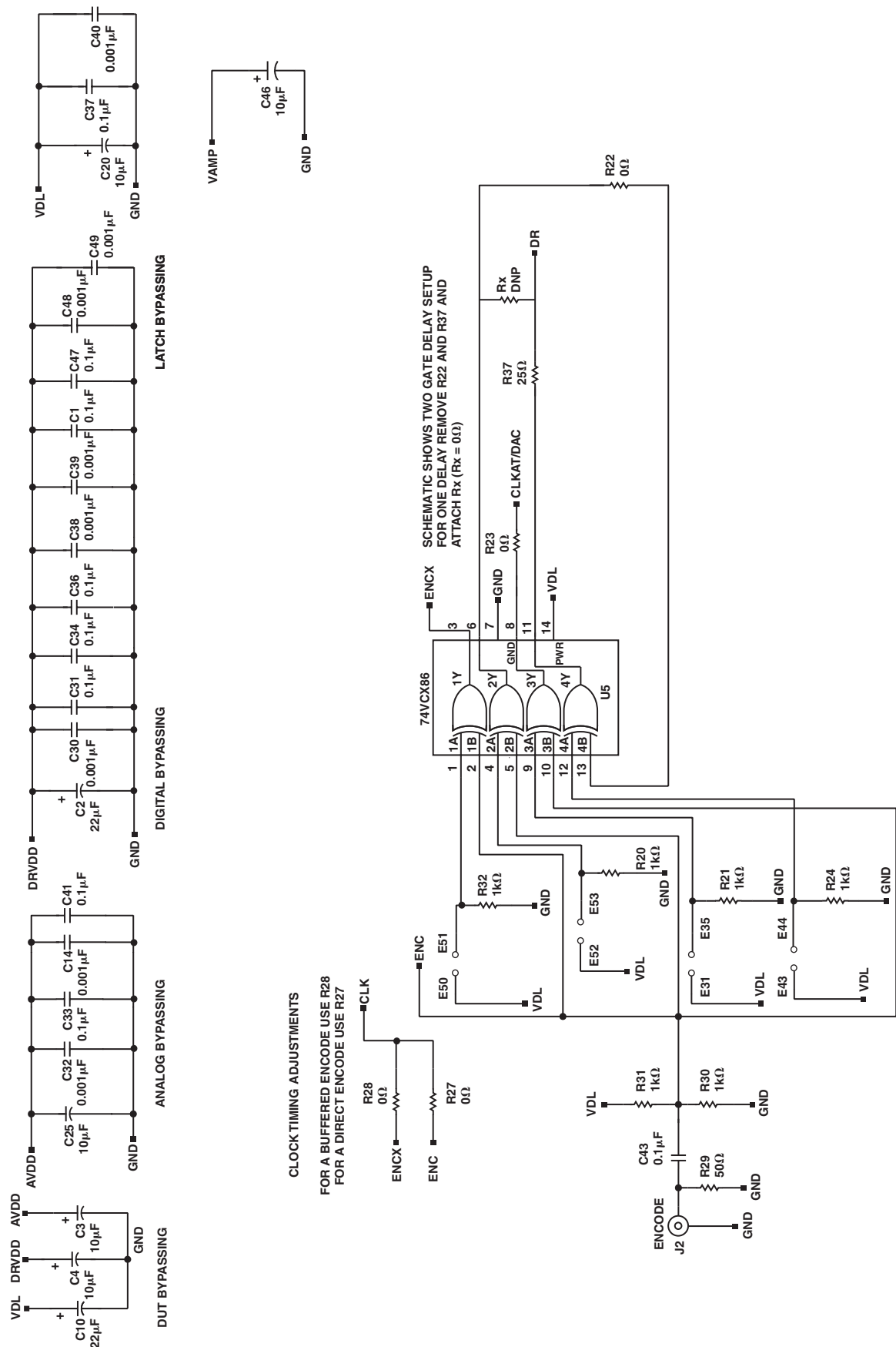

Figure 29. LFCSP Evaluation Board Schematic, Clock Input

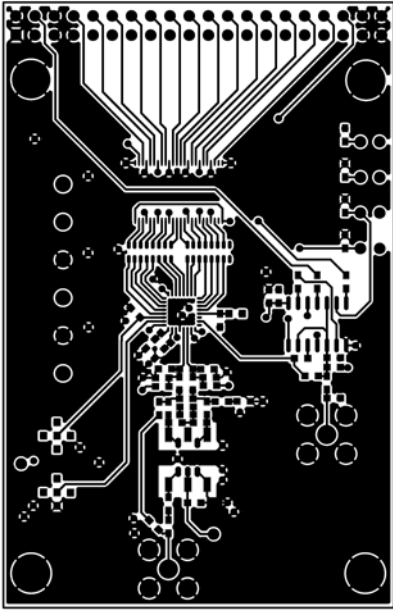

Figure 30. LFCSP Evaluation Board Layout, Primary Side

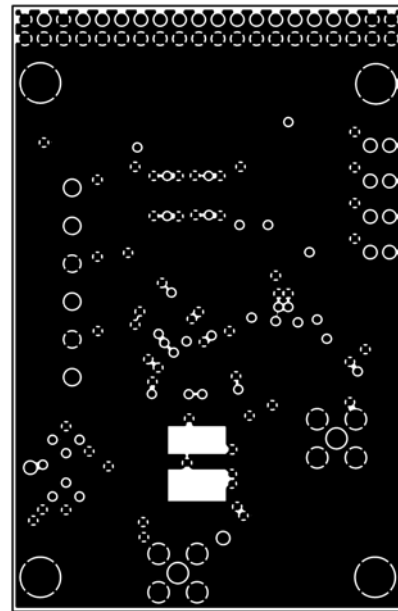

Figure 32. LFCSP Evaluation Board Layout, Ground Plane

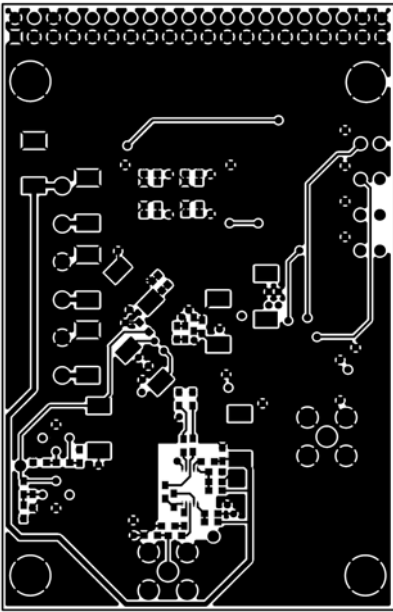

Figure 31. LFCSP Evaluation Board Layout, Secondary Side

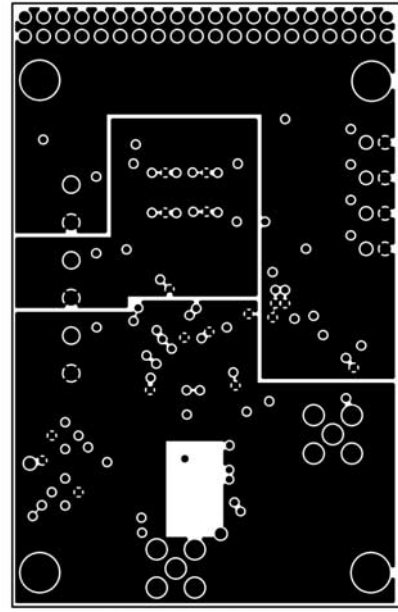

Figure 33. LFCSP Evaluation Board Layout, Power Plane

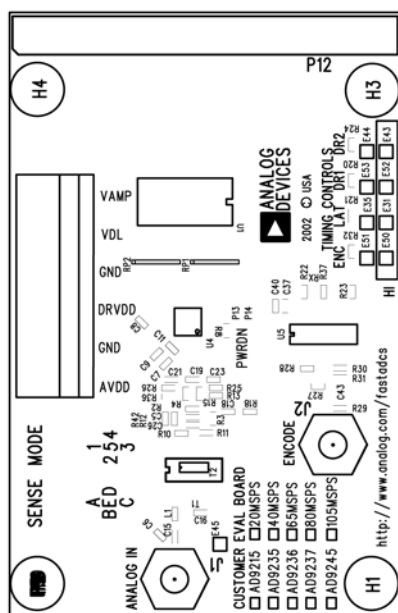

Figure 34. LFCSP Evaluation Board Layout, Primary Silkscreen

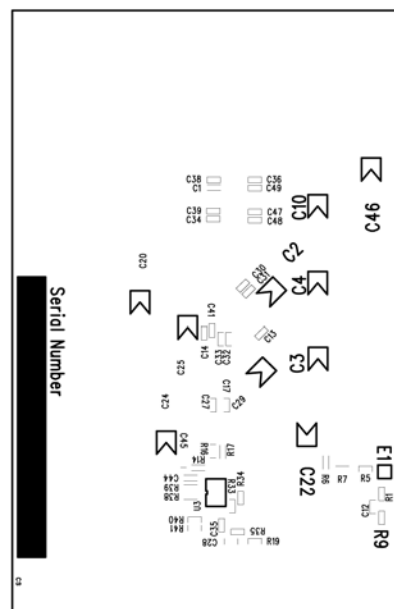

Figure 35. LFCSP Evaluation Board Layout, Secondary Silkscreen

Table III. LFCSP Evaluation Board Bill of Materials

| Item | Qty. | Omit <sup>1</sup> | Reference Designator  | Device                      | Package   | Value         | Recommended Vendor/Part Number       | Supplied by ADI |
|------|------|-------------------|---|-----------------------------|-----------|---------------|--------------------------------------|-----------------|
| 1    | 18   |                   | C1, C5, C7, C8, C9, C11, C12, C13, C15, C16, C31, C33, C34, C36, C37, C41, C43, C47 | Chip Capacitor              | 0603      | 0.1 $\mu$ F   |                                      |                 |
|      |      | 8                 | C6, C18, C27, C17, C28, C35, C45, C44   |                             |           |               |                                      |                 |
| 2    | 8    |                   | C2, C3, C4, C10, C20, C22, C25, C29   | Tantalum Capacitor          | TAJD      | 10 $\mu$ F    |                                      |                 |
|      |      | 2                 | C46, C24  |                             |           |               |                                      |                 |
| 3    | 8    |                   | C14, C30, C32, C38, C39, C40, C48, C49  | Chip Capacitor              | 0603      | 0.001 $\mu$ F |                                      |                 |
| 4    | 3    |                   | C19, C21, C23   | Chip Capacitor              | 0603      | 10 pF         |                                      |                 |
| 5    | 1    |                   | C26   | Chip Capacitor              | 0603      | 10 pF         |                                      |                 |
| 6    | 9    |                   | E31, E35, E43, E44, E50, E51, E52, E53  | Header                      | EHOLE     |               | Jumper Blocks                        |                 |
|      |      | 2                 | E1, E45   |                             |           |               |                                      |                 |
| 7    | 2    |                   | J1, J2  | SMA Connector/50 $\Omega$   | SMA       |               |                                      |                 |
| 8    |      | 1                 | L1  | Inductor                    | 0603      | 10 nH         | Coilcraft/0603CS-10NXGBU             |                 |
| 9    | 1    |                   | P2  | Terminal Block              | TB6       |               | Wieland/25.602.2653.0, z5-530-0625-0 |                 |
| 10   | 1    |                   | P12   | Header Dual 20-Pin RT Angle | HEADER40  |               | Digi-Key S2131-20-ND                 |                 |
| 11   | 5    |                   | R3, R12, R23, R28, RX   | Chip Resistor               | 0603      | 0 $\Omega$    |                                      |                 |
|      |      | 6                 | R37, R22, R42, R16, R17, R27  |                             |           |               |                                      |                 |
| 12   | 2    |                   | R4, R15   | Chip Resistor               | 0603      | 33 $\Omega$   |                                      |                 |
| 13   | 14   |                   | R5, R6, R7, R8, R13, R20, R21, R24, R25, R26, R30, R31, R32, R36                    | Chip Resistor               | 0603      | 1 k $\Omega$  |                                      |                 |
| 14   | 2    |                   | R10, R11  | Chip Resistor               | 0603      | 36 $\Omega$   |                                      |                 |
| 15   | 1    |                   | R29   | Chip Resistor               | 0603      | 50 $\Omega$   |                                      |                 |
|      |      | 1                 | R19   |                             |           |               |                                      |                 |
| 16   | 2    |                   | RP1, RP2  | Resistor Pack               | R_742     | 220 $\Omega$  | Digi-Key CTS/742C163220JTR           |                 |
| 17   | 1    |                   | T1  | ADT1-1WT                    | AWT1-1T   |               | Mini-Circuits                        |                 |
| 18   | 1    |                   | U1  | 74LVTH162374 CMOS Register  | TSSOP-48  |               |                                      |                 |
| 19   | 1    |                   | U4  | AD9235BCP ADC (DUT)         | CSP-32    |               | Analog Devices, Inc.                 | X               |
| 20   | 1    |                   | U5  | 74VCX86M                    | SOIC-14   |               | Fairchild                            |                 |
| 21   | 1    |                   | PCB   | AD92XXBCP/PCB               | PCB       |               | Analog Devices, Inc.                 | X               |
| 22   |      | 1                 | U3  | AD8351 Op Amp               | MSOP-8    |               | Analog Devices, Inc.                 | X               |
| 23   |      | 1                 | T2  | MACOM Transformer           | ETC1-1-13 | 1-1 TX        | MACOM/ETC1-1-13                      |                 |
| 24   |      | 5                 | R9, R1, R2, R38, R39  | Chip Resistor               | 0603      | SELECT        |                                      |                 |
| 25   |      | 3                 | R18, R14, R35   | Chip Resistor               | 0603      | 25 $\Omega$   |                                      |                 |

Table III. LFCSP Evaluation Board Bill of Materials (continued)

| Item         | Qty. | Omit <sup>1</sup> | Reference Designator | Device        | Package | Value  | Recommended Vendor/Part Number | Supplied by ADI |
|--------------|------|-------------------|----------------------|---------------|---------|--------|--------------------------------|-----------------|
| 26           |      | 2                 | R40, R41             | Chip Resistor | 0603    | 10 kΩ  |                                |                 |
| 27           |      | 1                 | R34                  | Chip Resistor |         | 1.2 kΩ |                                |                 |
| 28           |      | 1                 | R33                  | Chip Resistor |         | 100 Ω  |                                |                 |
| <b>Total</b> | 82   | 34                |                      |               |         |        |                                |                 |

<sup>1</sup>These items are included in the PCB design but are omitted at assembly.

OUTLINE DIMENSIONS

28-Lead Thin Shrink Small Outline Package [TSSOP]  
(RU-28)

Dimensions shown in millimeters

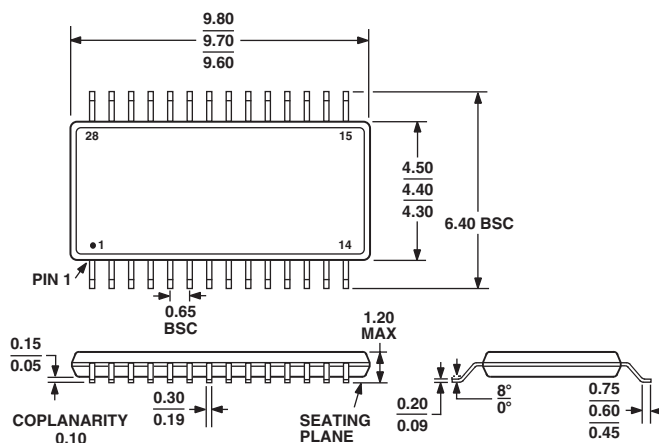

COMPLIANT TO JEDEC STANDARDS MO-153AE

32-Lead Lead Frame Chip Scale Package [LFCSP]  
(CP-32)

Dimensions shown in millimeters

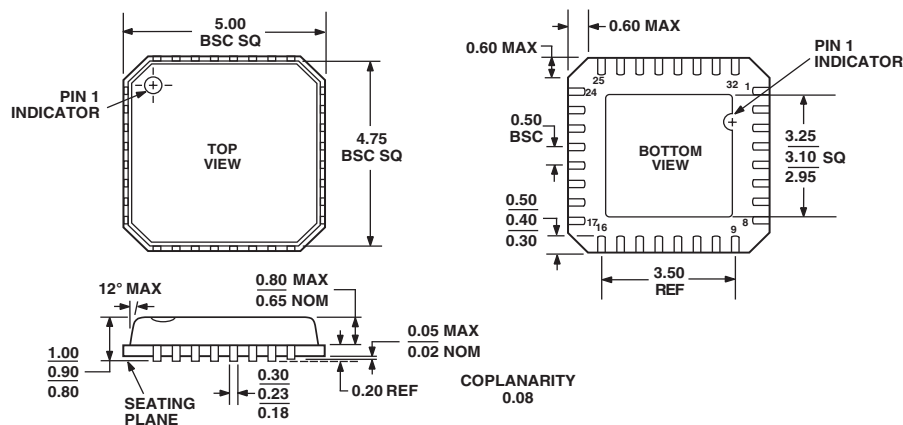

COMPLIANT TO JEDEC STANDARDS MO-220-VHDD-2

# AD9235

## Revision History

| Location  | Page      |
|---|-----------|
| <b>5/03—Data Sheet changed from REV. A to REV. B.</b>       |           |
| Added CP-32 Package (LFCSP) .....                           | UNIVERSAL |
| Changes to Several Pin Names .....                          | UNIVERSAL |
| Changes to FEATURES .....                                   | 1         |
| Changes to PRODUCT DESCRIPTION .....                        | 1         |
| Changes to PRODUCT HIGHLIGHTS .....                         | 1         |
| Changes to SPECIFICATIONS .....                             | 2         |
| Replaced Figure 1 .....                                     | 3         |
| Changes to ABSOLUTE MAXIMUM RATINGS .....                   | 5         |
| Changes to ORDERING GUIDE .....                             | 5         |
| Changes to PIN FUNCTION DESCRIPTIONS .....                  | 6         |
| New DEFINITIONS OF SPECIFICATIONS section .....             | 7         |
| Changes to TPCs 1–12 .....                                  | 9         |
| Changes to THEORY OF OPERATION section .....                | 13        |
| Changes to ANALOG INPUT section .....                       | 13        |
| Changes to Single-ended Input Configuration section .....   | 14        |
| Replaced Figure 8 .....                                     | 14        |
| Changes to CLOCK INPUT CONSIDERATIONS section .....         | 14        |
| Changes to Table I .....                                    | 15        |
| Changes to POWER DISSIPATION AND STANDBY MODE section ..... | 15        |
| Changes to DIGITAL OUTPUTS section .....                    | 15        |
| Changes to Timing section .....                             | 15        |
| Changes to Figure 13 .....                                  | 16        |
| Changes to Figures 16–26 .....                              | 17        |
| Added LFCSP Evaluation Board section .....                  | 17        |
| Inserted Figures 27–35 .....                                | 25        |
| Added Table III .....                                       | 30        |
| Updated OUTLINE DIMENSIONS .....                            | 31        |
| <b>8/02—Data Sheet changed from REV. 0 to REV. A.</b>       |           |
| Updated RU-28 Package .....                                 | 24        |

C02461–0–5/03(B)