

Long Sensing Distance Type

Long sensing distance type proximity sensor

■ Features

- Able to detect up to as 50mm
- Improved the noise resistance with dedicated IC
- Reverse power polarity, surge, overcurrent protection
- Wide range of power supply : 12–48VDC
(Voltage range:10–65VDC)
- Simultaneous output of Normal Open+Normal Close
- Built-in power indicator and operation indicator
- IP67 rated waterproof structure(IEC standard)

 Please read "Caution for your safety" in operation manual before using.



■ Type

◎DC 4-wire long sensing distance type

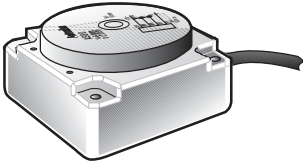
Appearance	Model
	AS80-50DN3
	AS80-50DP3

■ Specifications

Model	AS80-50DN3	AS80-50DP3
Sensing type	NPN Normal Open + Normal Close	PNP Normal Open + Normal Close
Sensing distance	50mm ±10%	
Hysteresis	Max. 15% of sensing distance	
Standard sensing target	150×150×1mm (Iron)	
Setting distance	0 ~ 35mm	
Power supply (Operating voltage)	12–48VDC (10–65VDC)	
Current consumption	Max. 10mA	
Response frequency(*1)	30Hz	
Residual voltage	Max. 1.8V	
Affection by Temp.	±10% Max. for sensing distance at +20℃ within temperature range of -25 ~ +70℃	
Control output	Max. 200mA	
Insulation resistance	Min. 50MΩ (at 500VDC mega)	
Dielectric strength	1500VAC 50/60Hz for 1 minute	
Vibration	1mm amplitude at frequency of 10 ~ 55Hz in each of X, Y, Z directions for 2 hours	
Shock	500m/s ² (50G) in X, Y, Z direction for 3 times	
Indicator	Operation indicator (Red LED)	
Ambient temperature	-25 ~ +70℃ (at non-freezing status)	
Storage temperature	-30 ~ +80℃ (at non-freezing status)	
Ambient humidity	35 ~ 95%RH	
Protection circuit	Surge, Reverse power polarity, Overcurrent protection circuit	
Cable	φ5×4P, 2m	
Protection	IP67 (IEC standard)	
Approval		
Unit weight	Approx. 470g	

※(*1) The response frequency is the average value. The standard sensing target is used and the width is set as 2 times of the standard sensing target, 1/2 of the sensing distance for the distance.

- (A) Counter
- (B) Timer
- (C) Temp. controller
- (D) Power controller
- (E) Panel meter
- (F) Tacho/Speed/Pulse meter
- (G) Display unit
- (H) Sensor controller
- (I) Switching power supply
- (J) Proximity sensor
- (K) Photo electric sensor
- (L) Pressure sensor
- (M) Rotary encoder
- (N) Stepping motor & Driver & Controller
- (O) Graphic panel
- (P) Field network device
- (Q) Production stoppage models & replacement

AS Series

Dimensions

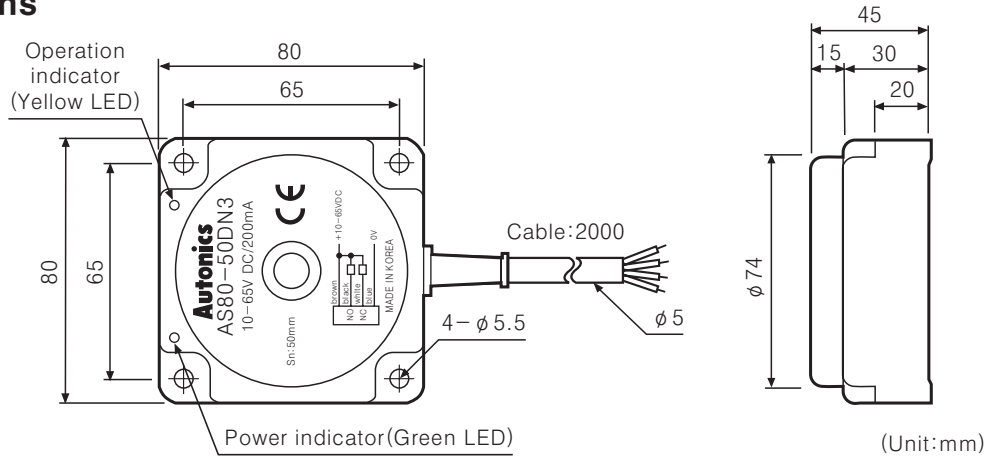

Control output diagram

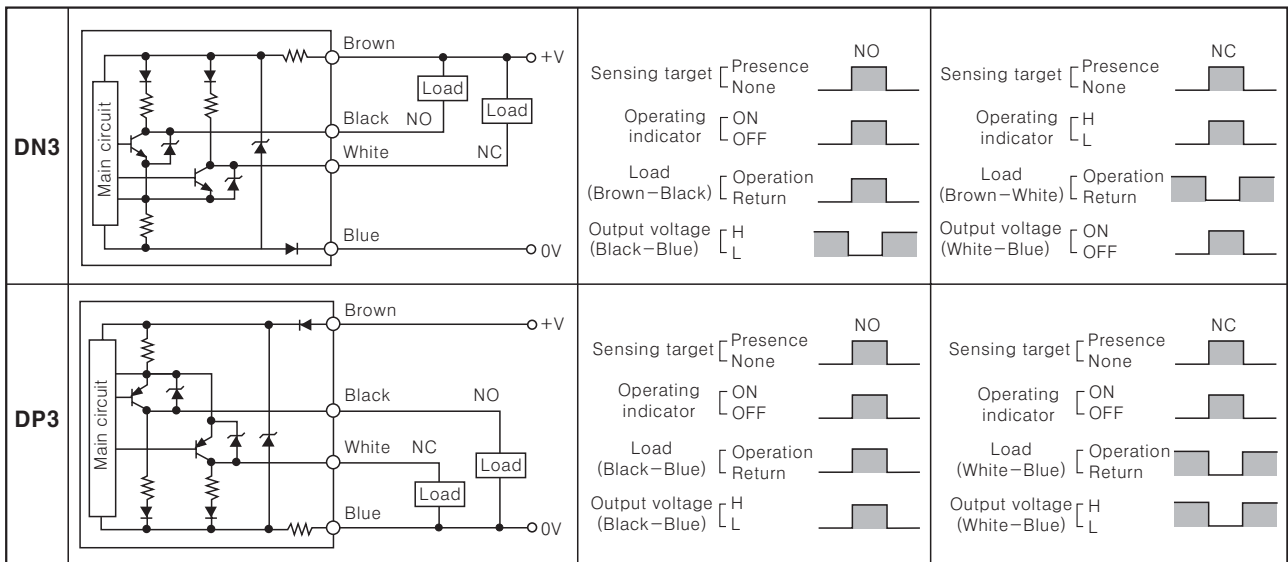

Mutual-interference & Influence by surrounding metals

◎Mutual-interference

When several proximity sensors are mounted closely, sensors may cause a malfunction due to mutual interference. Therefore, be sure to provide a minimum distance between the two sensors, as picture below.

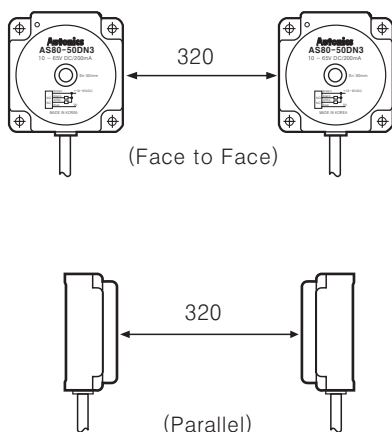

◎Influence by surrounding metals

When sensors are mounted on metallic panel, it may malfunction affected by any metallic object except target. Therefore, be sure to provide a minimum distance as shown in picture below.

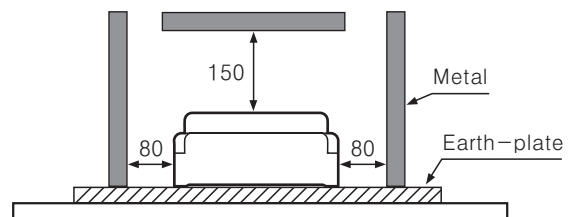

(Unit:mm)