

### Ultra-small-sized Tactile Switch with High Contact Reliability:

1.2 × 3 × 2.5 mm (H × W × D)

- Compact switch allows high-density mounting on PCBs for mobile equipment.
- Dust-proof construction provides high reliability in dusty environments.
- Surface mounted: Ideal for high-density mounting.
- Models with ground terminals are available for protection against static electricity.

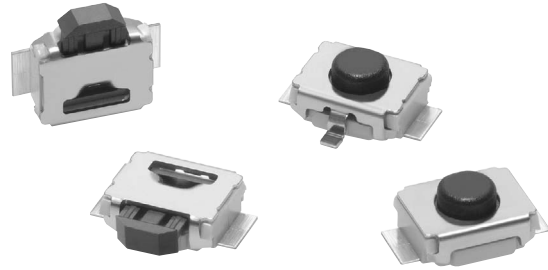

RoHS Compliant

### List of Models

Operation type	Locating pin	Plunger color	Embossed taping (standard quantity)			Embossed taping (small quantity)		
			Without ground terminal	With ground terminal	Quantity per reel	Without ground terminal	With ground terminal	Quantity
Top-actuated	Without boss	Black	B3U-1000P	B3U-1100P	3,500	B3U-1000PM	B3U-1100PM	1,000
	With boss		B3U-1000P-B	B3U-1100P-B		B3U-1000PM-B	B3U-1100PM-B	
Side-actuated	Without boss		B3U-3000P	B3U-3100P	4,000	B3U-3000PM	B3U-3100PM	1,000
	With boss		B3U-3000P-B	B3U-3100P-B		B3U-3000PM-B	B3U-3100PM-B	

Note: Orders must be made in multiples of the order unit specified above.

### Ratings/Characteristics

Item	Operation type	Top-actuated (B3U-1000 Series)	Side-actuated (B3U-3000 Series)
Ratings		1 to 50 mA, 5 to 12 VDC (resistive load)	
Ambient operating temperature		-25°C to +70°C at 60%RH max. (with no icing or condensation)	
Ambient operating humidity		35% to 85% (at +5 to +35°C)	
Contact form		SPST-NO	
Contact resistance		100 mΩ max. (initial value) (rated: 1 mA, 5 VDC)	
Insulation resistance		100 MΩ min. (at 100 VDC)	
Dielectric strength		250 VAC, 50/60 Hz for 1 min	
Bounce time		5 ms max.	
Vibration resistance		10 to 55 Hz, 1.5 mm double amplitude	
Shock resistance		1,000 m/s <sup>2</sup> max.	
Durability		200,000 operations min.	100,000 operations min.
Maximum operating force		30 N max.	
Weight		Approx. 0.022 g	

### Operating Characteristics

Item	Operation type	Top-actuated (B3U-1000 Series)	Side-actuated (B3U-3000 Series)
Operating force (OF)		1.50 ± 0.49 N {153 ± 50 gf}	1.59 ± 0.49 N {162 ± 50 gf}
Releasing force (RF)		0.2 N min. {20 gf}	
Pretravel (PT)		0.15 <sup>+0.2</sup> <sub>-0.1</sub> mm	0.2 <sup>+0.2</sup> <sub>-0.1</sub> mm

■ Dimensions (Unit: mm)

Top-actuated Models

Without Ground Terminal, without Boss  
B3U-1000P(M)

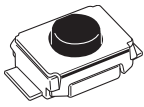

Terminal Arrangement /Internal Connections (Top View)

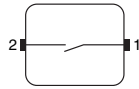

PCB Mounting (Top View)

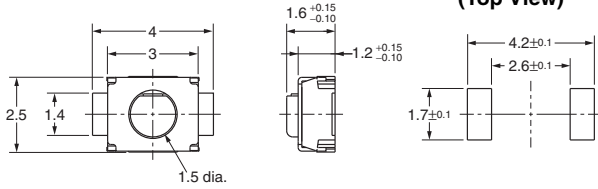

With Ground Terminal, without Boss  
B3U-1100P(M)

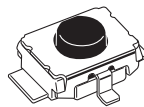

Terminal Arrangement /Internal Connections (Top View)

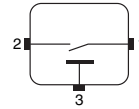

PCB Mounting (Top View)

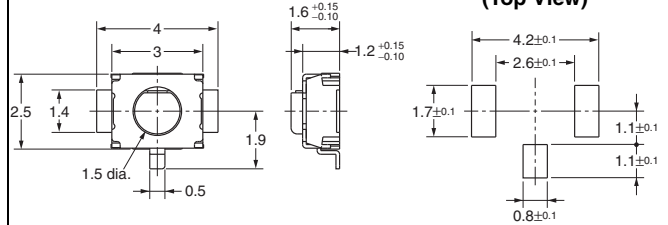

Without Ground Terminal, with Boss  
B3U-1000P(M)-B

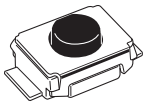

Terminal Arrangement /Internal Connections (Top View)

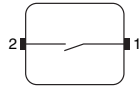

PCB Mounting (Top View)

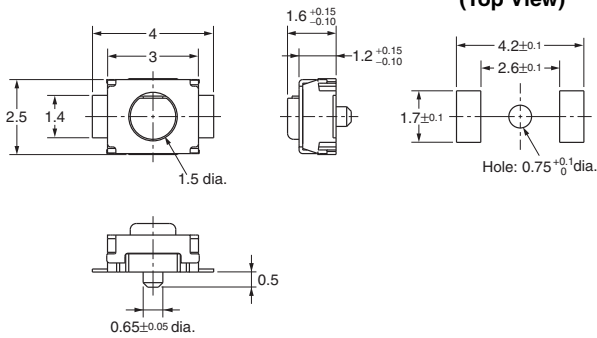

With Ground Terminal, with Boss  
B3U-1100P(M)-B

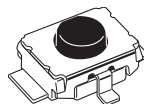

Terminal Arrangement /Internal Connections (Top View)

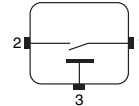

PCB Mounting (Top View)

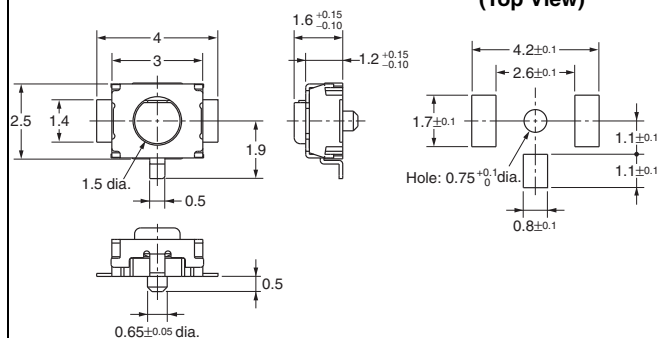

Note: Unless otherwise specified, a tolerance of  $\pm 0.2$  mm applies to all dimensions. No terminal numbers are indicated on the Switches.

Side-actuated Models

Without Ground Terminal, without Boss

B3U-3000P(M)

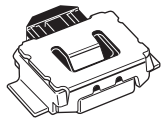

Terminal Arrangement / Internal Connections (Top View)

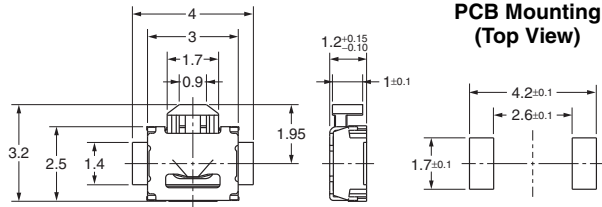
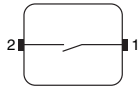

With Ground Terminal, without Boss

B3U-3100P(M)

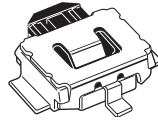

Terminal Arrangement / Internal Connections (Top View)

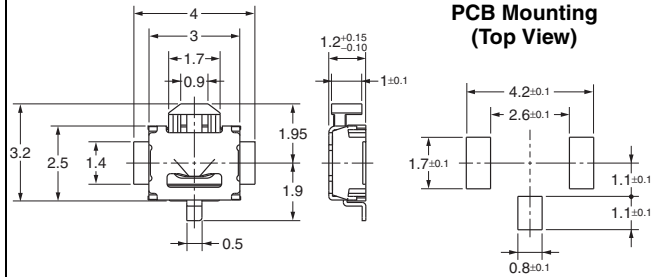
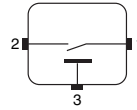

Without Ground Terminal, with Boss

B3U-3000P(M)-B

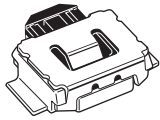

Terminal Arrangement / Internal Connections (Top View)

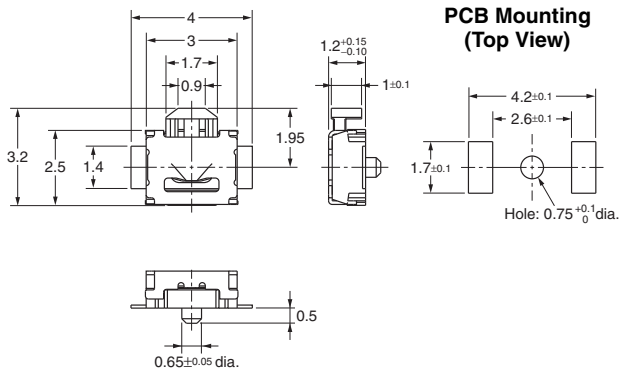
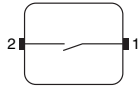

With Ground Terminal, with Boss

B3U-3100P(M)-B

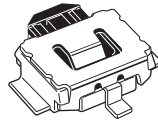

Terminal Arrangement / Internal Connections (Top View)

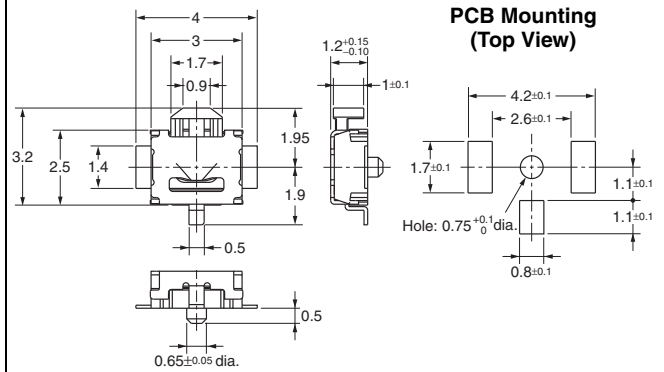
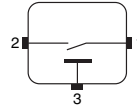

**Note:** Unless otherwise specified, a tolerance of  $\pm 0.2$  mm applies to all dimensions. No terminal numbers are indicated on the Switches.

■ Precautions

Be sure to read the precautions common to all Tactile Switches on pages for correct use.

- Application examples provided in this document are for reference only. In actual applications, confirm equipment functions and safety before using the product.
- Consult your OMRON representative before using the product under conditions which are not described in the manual or applying the product to nuclear control systems, railroad systems, aviation systems, vehicles, combustion systems, medical equipment, amusement machines, safety equipment, and other systems or equipment that may have a serious influence on lives and property if used improperly. Make sure that the ratings and performance characteristics of the product provide a margin of safety for the system or equipment, and be sure to provide the system or equipment with double safety mechanisms.

**Note: Do not use this document to operate the Unit.**

**OMRON Corporation**

**ELECTRONIC AND MECHANICAL COMPONENTS COMPANY**

**Contact: [www.omron.com/ecb](http://www.omron.com/ecb)**

**Cat. No. A162-E1-05  
0812(0207)(O)**