



# BTB04-600SL

## STANDARD 4A TRIAC

### MAIN FEATURES

Symbol	Value	Unit
$I_{T(RMS)}$	4	A
$V_{DRM} / V_{RRM}$	600	V
$I_{GT(Q1)}$	10	mA

### DESCRIPTION

The BTB04-600SL 4 quadrants TRIAC is intended for general purpose applications where high surge current capability is required, such as lighting, corded power tools, industrial. This TRIAC features a gate current capability sensitivity of 10mA.

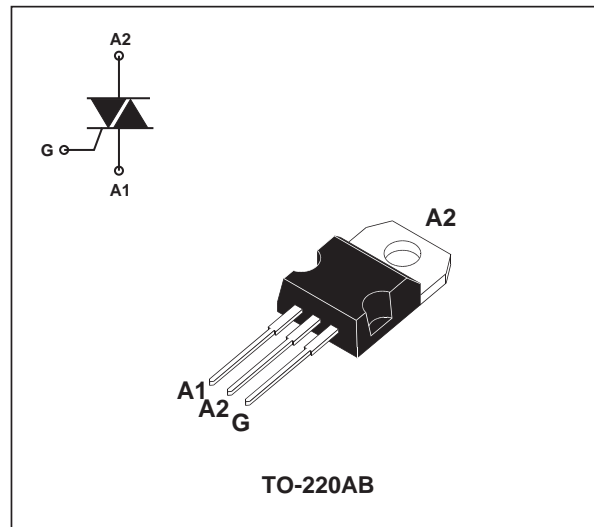

### ABSOLUTE MAXIMUM RATINGS

Symbol	Parameter			Value	Unit
$I_{T(RMS)}$	RMS on-state current (full sine wave)	TO-220AB	$T_c = 105^{\circ}\text{C}$	4	A
$I_{TSM}$	Non repetitive surge peak on-state current (full cycle, $T_j$ initial = $25^{\circ}\text{C}$ )	F = 50 Hz	t = 20 ms	35	A
		F = 60 Hz	t = 16.7 ms	38	
$I^2t$	$I^2t$ value for fusing		tp = 10ms	6	$\text{A}^2\text{s}$
dI/dt	Critical rate of rise of on-state current $I_G = 2 \times I_{GT}$ , tr ≤ 100 ns	Repetitive F = 100Hz		50	A/μs
$I_{GM}$	Peak gate	tp = 20μs	$T_j = 125^{\circ}\text{C}$	4	A
$P_{G(AV)}$	Average gate power dissipation		$T_j = 125^{\circ}\text{C}$	0.5	W
Tstg	Storage junction temperature range			-40 to +150	$^{\circ}\text{C}$
$T_j$	Operating junction temperature range			-40 to +125	

## BTB04-600SL

### ELECTRICAL CHARACTERISTICS (T<sub>j</sub> = 25°C, unless otherwise specified)

Symbol	Test conditions	Quadrant		Value	Unit
I <sub>GT</sub> <sup>(1)</sup>	V <sub>D</sub> = 12V R <sub>L</sub> = 30Ω	I - II - III	MAX.	10	mA
		IV	MAX.	25	
V <sub>GT</sub>	V <sub>D</sub> = 12V R <sub>L</sub> = 30Ω	ALL	MAX.	1.3	V
V <sub>GD</sub>	V <sub>D</sub> = V <sub>DRM</sub> R <sub>L</sub> = 3.3kΩ T <sub>j</sub> = 125°C	ALL	MIN.	0.2	V
I <sub>H</sub> <sup>(2)</sup>	I <sub>T</sub> = 100mA		MAX.	15	mA
I <sub>L</sub>	I <sub>G</sub> = 1.2I <sub>GT</sub>	I - III - IV	MAX.	15	mA
		II		25	
dV/dt <sup>(2)</sup>	V <sub>D</sub> = 67% V <sub>DRM</sub> gate open T <sub>j</sub> = 125°C		MIN.	75	V/μs
(dI/dt) <sub>c</sub> <sup>(2)</sup>	(dI/dt) <sub>c</sub> = 1.8A/ms T <sub>j</sub> = 125°C		MIN.	10	V/μs

### STATIC CHARACTERISTICS

Symbol	Test Conditions			Value	Unit
V <sub>TM</sub> <sup>(2)</sup>	I <sub>TM</sub> = 5A t <sub>p</sub> = 380μs	T <sub>j</sub> = 25°C	MAX.	1.5	V
V <sub>TO</sub> <sup>(2)</sup>	Threshold voltage	T <sub>j</sub> = 125°C	MAX.	0.85	V
R <sub>d</sub> <sup>(2)</sup>	Dynamic resistance	T <sub>j</sub> = 125°C	MAX.	100	mΩ
I <sub>DRM</sub> I <sub>RDM</sub>	V <sub>DRM</sub> = V <sub>RRM</sub>	T <sub>j</sub> = 25°C	MAX.	5	μA
		T <sub>j</sub> = 125°C		1	mA

**Note 1:** minimum IGT is guaranteed at 5% of IGT max.

**Note 2:** for both polarities of A2 referenced to A1.

### THERMAL RESISTANCE

Symbol	Parameter	Value	Unit
R <sub>th</sub> (j-c)	Junction to case (AC)	3	°C/W
R <sub>th</sub> (j-a)	Junction to ambient	60	°C/W

PRODUCT SELECTOR

Part Number	Voltage	Sensitivity	Type	Package
BTB04-600SL	600V	10 mA	Standard	TO-220AB

ORDERING INFORMATION

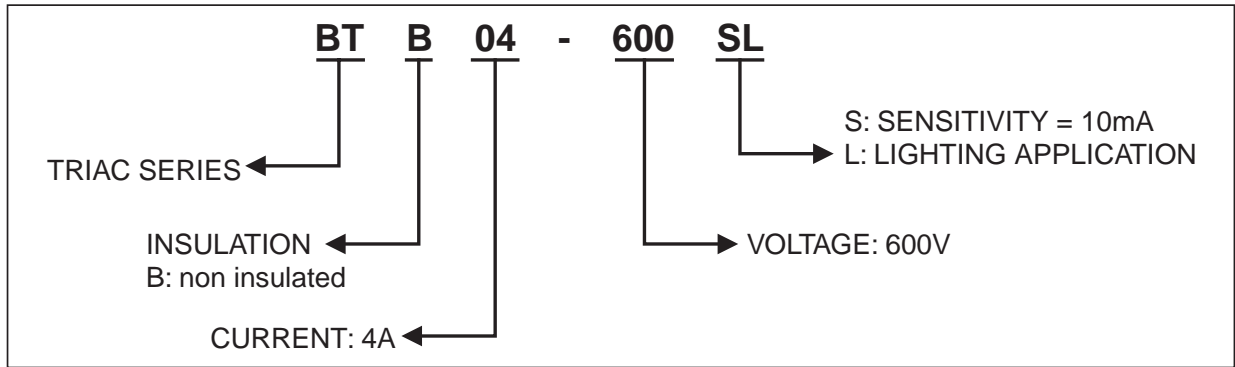

Fig. 1: Maximum power dissipation versus RMS on-state current

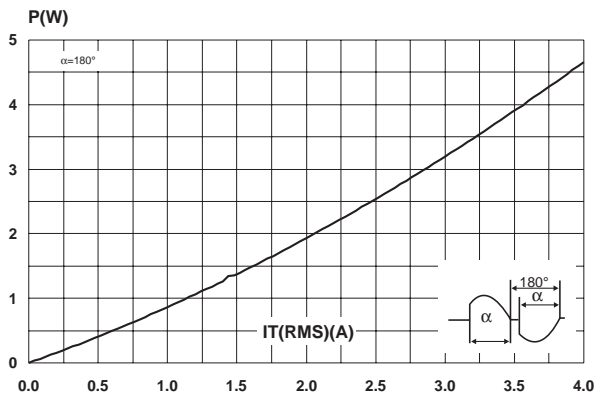

Fig. 3: Relative variation of thermal impedance versus pulse duration.

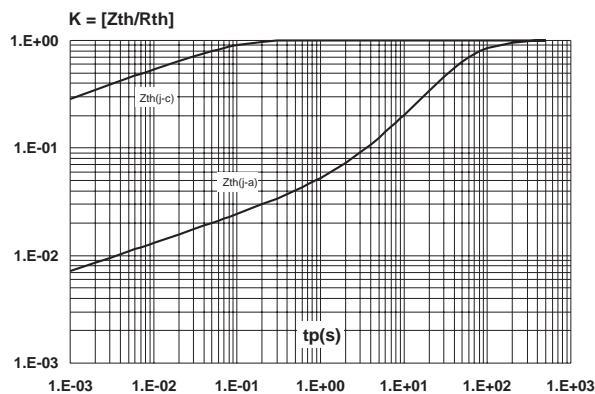

Fig. 2: RMS on-state current versus case temperature.

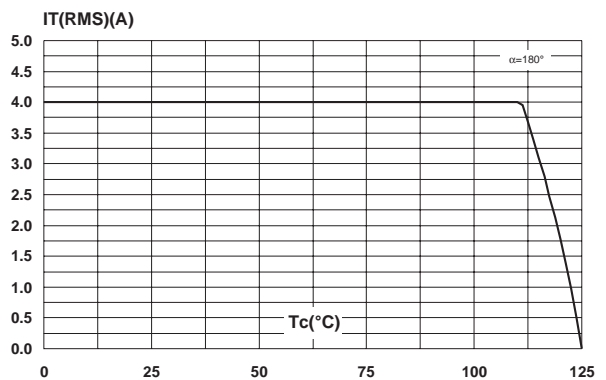
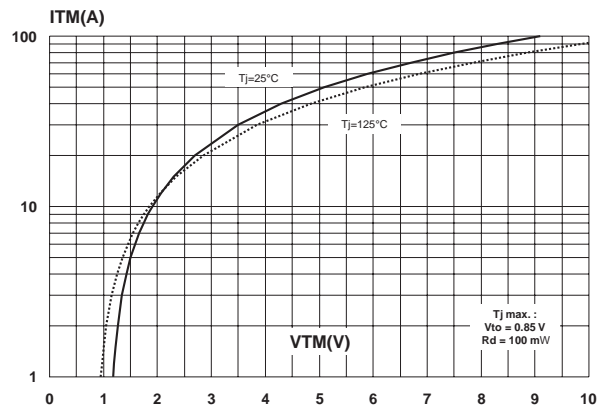
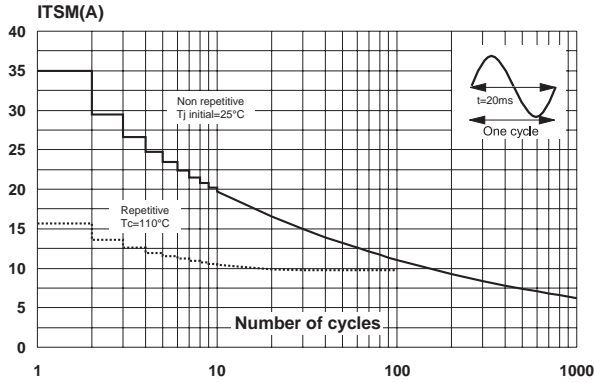

Fig. 4: On-state characteristics (maximum values)



**Fig. 5:** Surge peak on-state current versus number of cycles.



**Fig. 6:** Non repetitive surge peak on-state current for a sinusoidal pulse with width  $t_p < 10\text{ms}$ , and corresponding value of  $I^2t$ .

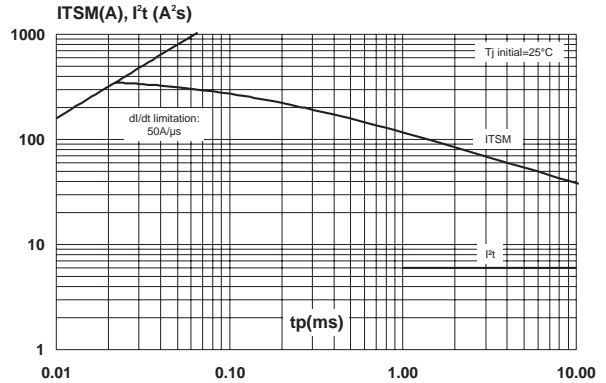

**Fig. 7:** Relative variation of gate trigger current, holding current and latching current versus junction temperature (typical values).

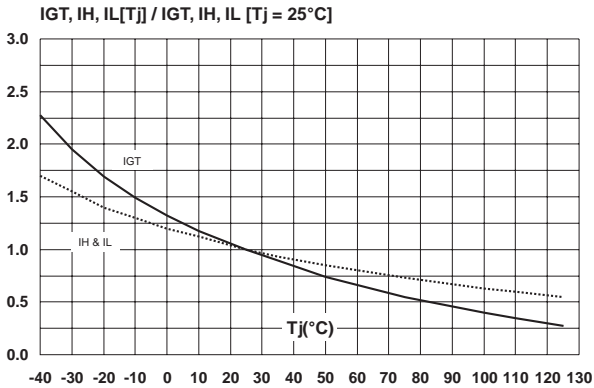

**Fig. 8:** Relative variation of critical rate of decrease of main current versus reapplied  $dV/dt$  (typical values).

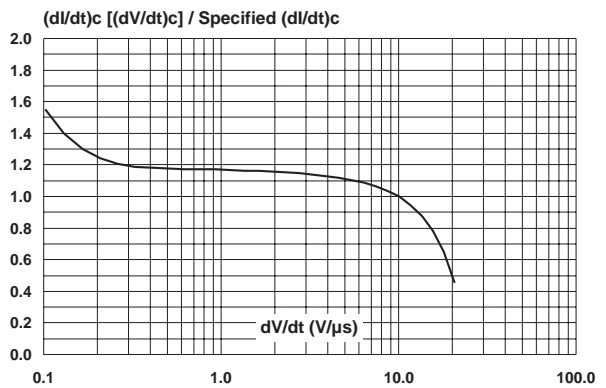

**Fig. 9:** Relative variation of critical rate of decrease of main current versus junction temperature.

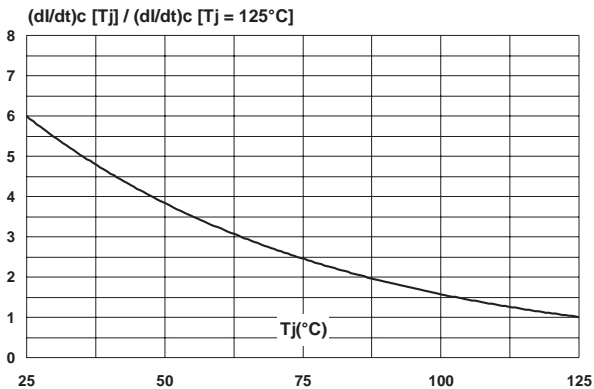

**Fig. 10:** Relative variation of static  $dV/dt$  immunity versus junction temperature.

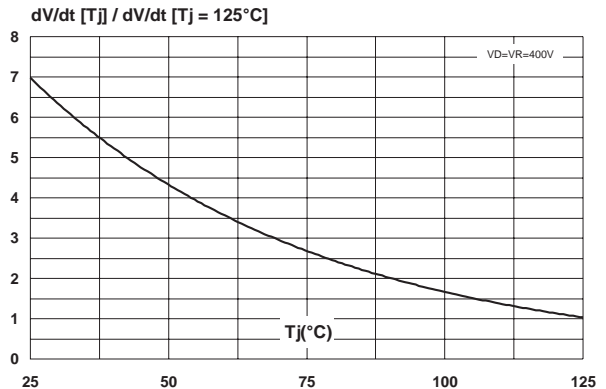

**PACKAGE MECHANICAL DATA**  
 TO-220AB (Plastic)

REF.	DIMENSIONS			
	Millimeters		Inches	
	Min.	Max.	Min.	Max.
A	4.40	4.60	0.173	0.181
C	1.23	1.32	0.048	0.051
D	2.40	2.72	0.094	0.107
E	0.49	0.70	0.019	0.027
F	0.61	0.88	0.024	0.034
F1	1.14	1.70	0.044	0.066
F2	1.14	1.70	0.044	0.066
G	4.95	5.15	0.194	0.202
G1	2.40	2.70	0.094	0.106
H2	10	10.40	0.393	0.409
L2	16.4 typ.		0.645 typ.	
L4	13	14	0.511	0.551
L5	2.65	2.95	0.104	0.116
L6	15.25	15.75	0.600	0.620
L7	6.20	6.60	0.244	0.259
L9	3.50	3.93	0.137	0.154
M	2.6 typ.		0.102 typ.	
Diam.	3.75	3.85	0.147	0.151

**OTHER INFORMATION**

Ordering type	Marking	Package	Weight	Base qty	Packing mode
BTB04-600SL	BTB04-600SL	TO-220AB	2.3 g	50	Tube

Information furnished is believed to be accurate and reliable. However, STMicroelectronics assumes no responsibility for the consequences of use of such information nor for any infringement of patents or other rights of third parties which may result from its use. No license is granted by implication or otherwise under any patent or patent rights of STMicroelectronics. Specifications mentioned in this publication are subject to change without notice. This publication supersedes and replaces all information previously supplied. STMicroelectronics products are not authorized for use as critical components in life support devices or systems without express written approval of STMicroelectronics.

The ST logo is a registered trademark of STMicroelectronics

© 2002 STMicroelectronics - Printed in Italy - All rights reserved.

STMicroelectronics GROUP OF COMPANIES

Australia - Brazil - Canada - China - Finland - France - Germany  
 Hong Kong - India - Israel - Italy - Japan - Malaysia - Malta - Morocco - Singapore  
 Spain - Sweden - Switzerland - United Kingdom - United States.

<http://www.st.com>