

## 200-MHz GENERAL-PURPOSE CLOCK BUFFER, PCI-X COMPLIANT

### FEATURES

- General-Purpose and PCI-X 1:4 Clock Buffer
- Operating Frequency
  - 0 MHz to 200 MHz General-Purpose
- Low Output Skew: <100 ps
- Distributes One Clock Input to One Bank of Four Outputs
- Output Enable Control that Drives Outputs Low when OE is Low
- Operates from Single 3.3-V Supply or 2.5-V Supply
- PCI-X Compliant
- 8-Pin TSSOP Package

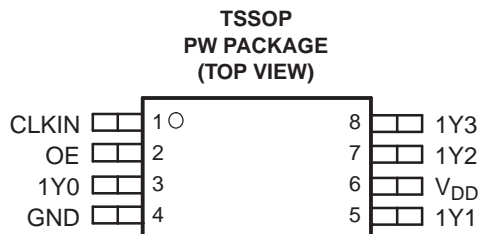

### DESCRIPTION

The CDCV304 is a high-performance, low-skew, general-purpose PCI-X compliant clock buffer. It distributes one input clock signal (CLKIN) to the output clocks (1Y[0:3]). It is specifically designed for use with PCI-X applications. The CDCV304 operates at 3.3 V and 2.5 V and is therefore compliant to the 3.3-V PCI-X specifications.

The CDCV304 is characterized for operation from –40°C to 85°C for automotive and industrial applications.

### FUNCTIONAL BLOCK DIAGRAM

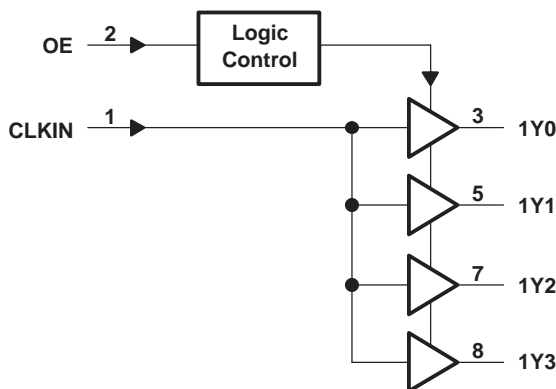

### FUNCTION TABLE

| INPUTS |    | OUTPUTS |
|--------|----|---------|
| CLKIN  | OE | 1Y[0:3] |
| L      | L  | L       |
| H      | L  | L       |
| L      | H  | L       |
| H      | H  | H       |



Please be aware that an important notice concerning availability, standard warranty, and use in critical applications of Texas Instruments semiconductor products and disclaimers thereto appears at the end of this data sheet.



These devices have limited built-in ESD protection. The leads should be shorted together or the device placed in conductive foam during storage or handling to prevent electrostatic damage to the MOS gates.

### TERMINAL FUNCTIONS

| TERMINAL        |            | I/O   | DESCRIPTION               |
|-----------------|------------|-------|---------------------------|
| NAME            | NO.        |       |                           |
| 1Y[0:3]         | 3, 5, 7, 8 | O     | Buffered output clocks    |
| CLKIN           | 1          | I     | Input reference frequency |
| GND             | 4          | Power | Ground                    |
| OE              | 2          | I     | Output enable control     |
| V <sub>DD</sub> | 6          | Power | Supply                    |

### THERMAL INFORMATION

| CDCV304PW 8-PIN TSSOP |        |  |    | THERMAL AIR FLOW (CFM) |     |     |     | UNIT |
|-----------------------|--------|--|----|------------------------|-----|-----|-----|------|
|                       |        |  |    | 0                      | 150 | 250 | 500 |      |
| R <sub>θJA</sub>      | High K |  |    | 149                    | 142 | 138 | 132 | °C/W |
| R <sub>θJA</sub>      | Low K  |  |    | 230                    | 185 | 170 | 150 | °C/W |
| R <sub>θJC</sub>      | High K |  | 65 |                        |     |     |     | °C/W |
| R <sub>θJC</sub>      | High K |  | 69 |                        |     |     |     | °C/W |

### ABSOLUTE MAXIMUM RATINGS

over operating free-air temperature range (unless otherwise noted) <sup>(1)</sup>

|   | UNIT                              |
|---|-----------------------------------|
| Supply voltage range, V <sub>DD</sub>   | −0.5 V to 4.3 V                   |
| Input voltage range, V <sub>I</sub> <sup>(2)(3)</sup>   | −0.5 V to V <sub>DD</sub> + 0.5 V |
| Output voltage range, V <sub>O</sub> <sup>(2)(3)</sup>  | −0.5 V to V <sub>DD</sub> + 0.5 V |
| Input clamp current, I <sub>IK</sub> (V <sub>I</sub> < 0 or V <sub>I</sub> > V <sub>DD</sub> )  | ±50 mA                            |
| Output clamp current, I <sub>OK</sub> (V <sub>O</sub> < 0 or V <sub>O</sub> > V <sub>DD</sub> ) | ±50 mA                            |
| Continuous total output current, I <sub>O</sub> (V <sub>O</sub> = 0 to V <sub>DD</sub> )        | ±50 mA                            |
| Package thermal impedance, θ <sub>JA</sub> : PW package   | 230.5°C/W                         |
| Storage temperature range T <sub>stg</sub>  | −65°C to 150°C                    |

(1) Stresses beyond those listed under “absolute maximum ratings” may cause permanent damage to the device. These are stress ratings only, and functional operation of the device at these or any other conditions beyond those indicated under “recommended operating conditions” is not implied. Exposure to absolute-maximum-rated conditions for extended periods may affect device reliability.

(2) The input and output negative voltage ratings may be exceeded if the input and output clamp-current ratings are observed.

(3) This value is limited to 4.6 V maximum.

### RECOMMENDED OPERATING CONDITIONS

|  | MIN                     | NOM | MAX                   | UNIT |
|--|-------------------------|-----|-----------------------|------|
| Supply voltage, V <sub>DD</sub>                | 2.3                     |     | 3.6                   | V    |
| Low-level input voltage, V <sub>IL</sub>       |                         |     | 0.3 x V <sub>DD</sub> | V    |
| High-level input voltage, V <sub>IH</sub>      | 0.7 x V <sub>DD</sub>   |     |                       | V    |
| Input voltage, V <sub>I</sub>                  | 0                       |     | V <sub>DD</sub>       | V    |
| High-level output current, I <sub>OH</sub>     | V <sub>DD</sub> = 2.5 V |     | −12                   | mA   |
|  | V <sub>DD</sub> = 3.3 V |     | −24                   |      |
| Low-level output current, I <sub>OL</sub>      | V <sub>DD</sub> = 2.5 V |     | 12                    | mA   |
|  | V <sub>DD</sub> = 3.3 V |     | 24                    |      |
| Operating free-air temperature, T <sub>A</sub> | −40                     |     | 85                    | °C   |

## TIMING REQUIREMENTS

over operating free-air temperature range (unless otherwise noted)

| PARAMETER        |                 | TEST CONDITIONS | MIN | TYP | MAX | UNIT |
|------------------|-----------------|-----------------|-----|-----|-----|------|
| $f_{\text{clk}}$ | Clock frequency |                 | 0   |     | 200 | MHz  |

## ELECTRICAL CHARACTERISTICS

over recommended operating free-air temperature range (unless otherwise noted)

| PARAMETER       |   | TEST CONDITIONS  | MIN | TYP <sup>(1)</sup>    | MAX     | UNIT          |
|-----------------|---|--|-----|-----------------------|---------|---------------|
| $V_{\text{IK}}$ | Input voltage                                 | $V_{\text{DD}} = 3 \text{ V}$ ,<br>$I_{\text{I}} = -18 \text{ mA}$                   |     |                       | -1.2    | V             |
| $V_{\text{OH}}$ | High-level output voltage                     | $V_{\text{DD}} = 2.3 \text{ V}$ ,<br>$I_{\text{OH}} = -8 \text{ mA}$                 |     | 1.8                   |         | V             |
|                 |   | $V_{\text{DD}} = 2.3 \text{ V}$ ,<br>$I_{\text{OH}} = -16 \text{ mA}$                |     | 1.5                   |         |               |
|                 |   | $V_{\text{DD}} = \text{min to max}$ ,<br>$I_{\text{OH}} = -1 \text{ mA}$             |     | $V_{\text{DD}} - 0.2$ |         |               |
|                 |   | $V_{\text{DD}} = 3 \text{ V}$ ,<br>$I_{\text{OH}} = -24 \text{ mA}$                  |     | 2                     |         |               |
|                 |   | $V_{\text{DD}} = 3 \text{ V}$ ,<br>$I_{\text{OH}} = -12 \text{ mA}$                  |     | 2.4                   |         |               |
| $V_{\text{OL}}$ | Low-level output voltage                      | $V_{\text{DD}} = 2.3 \text{ V}$ ,<br>$I_{\text{OL}} = 8 \text{ mA}$                  |     |                       | 0.5     | V             |
|                 |   | $V_{\text{DD}} = 2.3 \text{ V}$ ,<br>$I_{\text{OL}} = 16 \text{ mA}$                 |     |                       | 0.7     |               |
|                 |   | $V_{\text{DD}} = \text{min to max}$ ,<br>$I_{\text{OL}} = 1 \text{ mA}$              |     |                       | 0.2     |               |
|                 |   | $V_{\text{DD}} = 3 \text{ V}$ ,<br>$I_{\text{OL}} = 24 \text{ mA}$                   |     |                       | 0.8     |               |
|                 |   | $V_{\text{DD}} = 3 \text{ V}$ ,<br>$I_{\text{OL}} = 12 \text{ mA}$                   |     |                       | 0.55    |               |
| $I_{\text{OH}}$ | High-level output current                     | $V_{\text{DD}} = 3 \text{ V}$ ,<br>$V_{\text{O}} = 1 \text{ V}$                      |     | -50                   |         | mA            |
|                 |   | $V_{\text{DD}} = 3.3 \text{ V}$ ,<br>$V_{\text{O}} = 1.65 \text{ V}$                 |     |                       | -55     |               |
| $I_{\text{OL}}$ | Low-level output current                      | $V_{\text{DD}} = 3 \text{ V}$ ,<br>$V_{\text{O}} = 2 \text{ V}$                      |     | 60                    |         | mA            |
|                 |   | $V_{\text{DD}} = 3.3 \text{ V}$ ,<br>$V_{\text{O}} = 1.65 \text{ V}$                 |     |                       | 70      |               |
| $I_{\text{I}}$  | Input current                                 | $V_{\text{I}} = V_{\text{O}}$ or $V_{\text{DD}}$                                     |     |                       | $\pm 5$ | $\mu\text{A}$ |
| $I_{\text{DD}}$ | Dynamic current, see <a href="#">Figure 5</a> | $f = 67 \text{ MHz}$ ,<br>$V_{\text{DD}} = 2.7 \text{ V}$                            |     |                       | 28      | mA            |
|                 |   | $f = 67 \text{ MHz}$ ,<br>$V_{\text{DD}} = 3.6 \text{ V}$                            |     |                       | 37      |               |
| $C_{\text{I}}$  | Input capacitance                             | $V_{\text{DD}} = 3.3 \text{ V}$ ,<br>$V_{\text{I}} = 0 \text{ V}$ or $V_{\text{DD}}$ |     | 3                     |         | pF            |
| $C_{\text{O}}$  | Output capacitance                            | $V_{\text{DD}} = 3.3 \text{ V}$ ,<br>$V_{\text{I}} = 0 \text{ V}$ or $V_{\text{DD}}$ |     | 3.2                   |         | pF            |

 (1) All typical values are with respect to nominal  $V_{\text{DD}}$  and  $T_{\text{A}} = 25^{\circ}\text{C}$ .

## SWITCHING CHARACTERISTICS

 $V_{\text{DD}} = 2.5 \text{ V} \pm 10\%$ ,  $C_{\text{L}} = 10 \text{ pF}$  (unless otherwise noted)

| PARAMETER          |                               | TEST CONDITIONS   | MIN | TYP <sup>(1)</sup> | MAX | UNIT |
|--------------------|-------------------------------|---|-----|--------------------|-----|------|
| $t_{\text{PLH}}$   | Low-to-high propagation delay | See <a href="#">Figure 1</a> and <a href="#">Figure 2</a> | 2   | 2.9                | 4.5 | ns   |
| $t_{\text{PHL}}$   | High-to-low propagation delay |   | 2   | 3                  | 4.5 |      |
| $t_{\text{sk(o)}}$ | Output skew <sup>(2)</sup>    | See <a href="#">Figure 3</a>                              |     | 50                 | 150 | ps   |
| $t_{\text{r}}$     | Output rise slew rate         |   | 1.5 | 2.2                | 4   | V/ns |
| $t_{\text{f}}$     | Output fall slew rate         |   | 1.5 | 2.2                | 4   | V/ns |

 (1) All typical values are with respect to nominal  $V_{\text{DD}}$ .

 (2) The  $t_{\text{sk(o)}}$  specification is only valid for equal loading of all outputs.

## SWITCHING CHARACTERISTICS

$V_{DD} = 3.3\text{ V} \pm 10\%$ ,  $C_L = 10\text{ pF}$  (unless otherwise noted)

| PARAMETER    |  | TEST CONDITIONS   | MIN | TYP <sup>(1)</sup> | MAX | UNIT   |
|--------------|--|---|-----|--------------------|-----|--------|
| $t_{PLH}$    | Low-to-high propagation delay                  | See <a href="#">Figure 1</a> and <a href="#">Figure 2</a> | 1.8 | 2.4                | 3   | ns     |
| $t_{PHL}$    | High-to-low propagation delay                  |   | 1.8 | 2.5                | 3   |        |
| $t_{sk(o)}$  | Output skew <sup>(2)</sup>                     |   |     | 50                 | 100 | ps     |
| $t_{jitter}$ | Additive phase jitter from input to output 1Y0 | 12 kHz to 5 MHz, $f_{out} = 30.72\text{ MHz}$             |     | 63                 |     | fs rms |
|              |  | 12 kHz to 20 MHz, $f_{out} = 125\text{ MHz}$              |     | 56                 |     |        |
| $t_{sk(p)}$  | Pulse skew                                     | $V_{IH} = V_{DD}$ , $V_{IL} = 0\text{ V}$                 |     |                    | 150 | ps     |
| $t_{sk(pr)}$ | Process skew                                   |   |     | 0.2                | 0.3 | ns     |
| $t_{sk(pp)}$ | Part-to-part skew                              |   |     | 0.25               | 0.4 | ns     |
| $t_{high}$   | Clock high time, see <a href="#">Figure 4</a>  | 66 MHz  | 6   |                    |     | ns     |
|              |  | 140 MHz   | 3   |                    |     |        |
| $t_{low}$    | Clock low time, see <a href="#">Figure 4</a>   | 66 MHz  | 6   |                    |     | ns     |
|              |  | 140 MHz   | 3   |                    |     |        |
| $t_r$        | Output rise slew rate <sup>(3)</sup>           | $V_O = 0.4\text{ V to }2\text{ V}$                        | 1.5 | 2.7                | 4   | V/ns   |
| $t_f$        | Output fall slew rate <sup>(3)</sup>           | $V_O = 2\text{ V to }0.4\text{ V}$                        | 1.5 | 2.7                | 4   | V/ns   |

(1) All typical values are with respect to nominal  $V_{DD}$ .

(2) The  $t_{sk(o)}$  specification is only valid for equal loading of all outputs.

(3) This symbol is according to PCI-X terminology.

PARAMETER MEASUREMENT INFORMATION

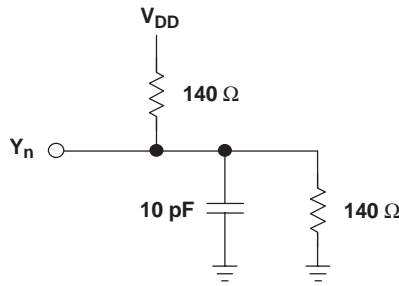

Figure 1. Test Load Circuit

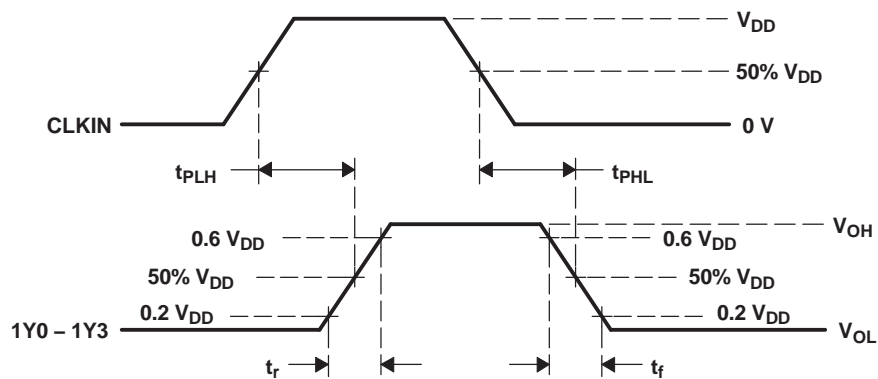

Figure 2. Voltage Waveforms Propagation Delay ( $t_{pd}$ ) Measurements

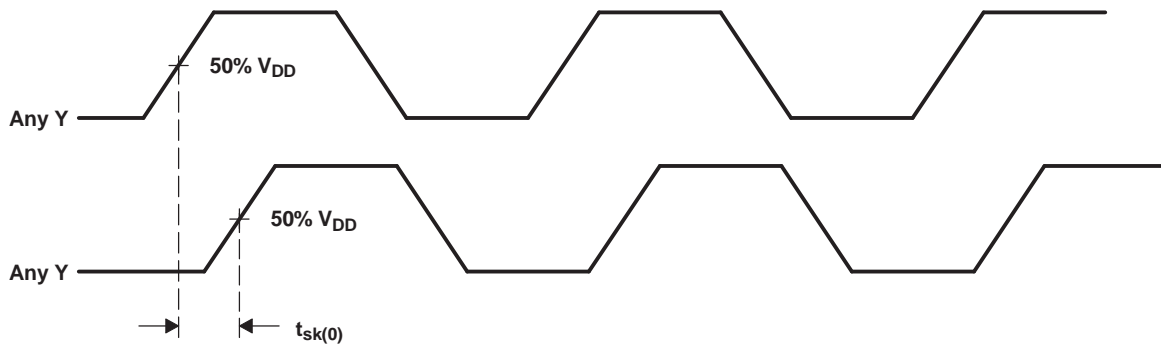
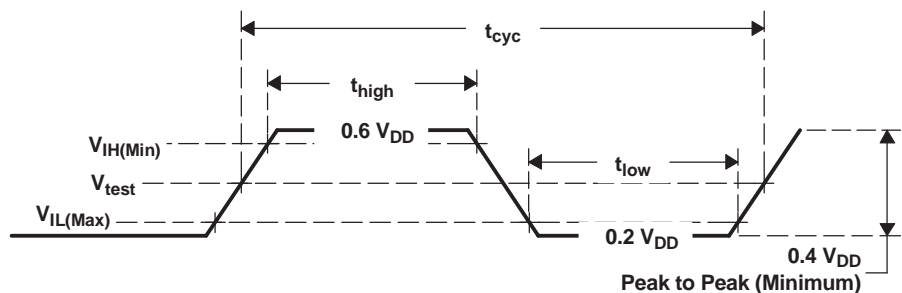

Figure 3. Output Skew

| PARAMETER            | VALUE         | UNIT |
|----------------------|---------------|------|
| $V_{IH}(\text{Min})$ | $0.5 V_{DD}$  | V    |
| $V_{IL}(\text{Max})$ | $0.35 V_{DD}$ | V    |
| $V_{\text{test}}$    | $0.4 V_{DD}$  | V    |



A. All parameters in Figure 4 are according to PCI-X 1.0 specifications.

Figure 4. Clock Waveform

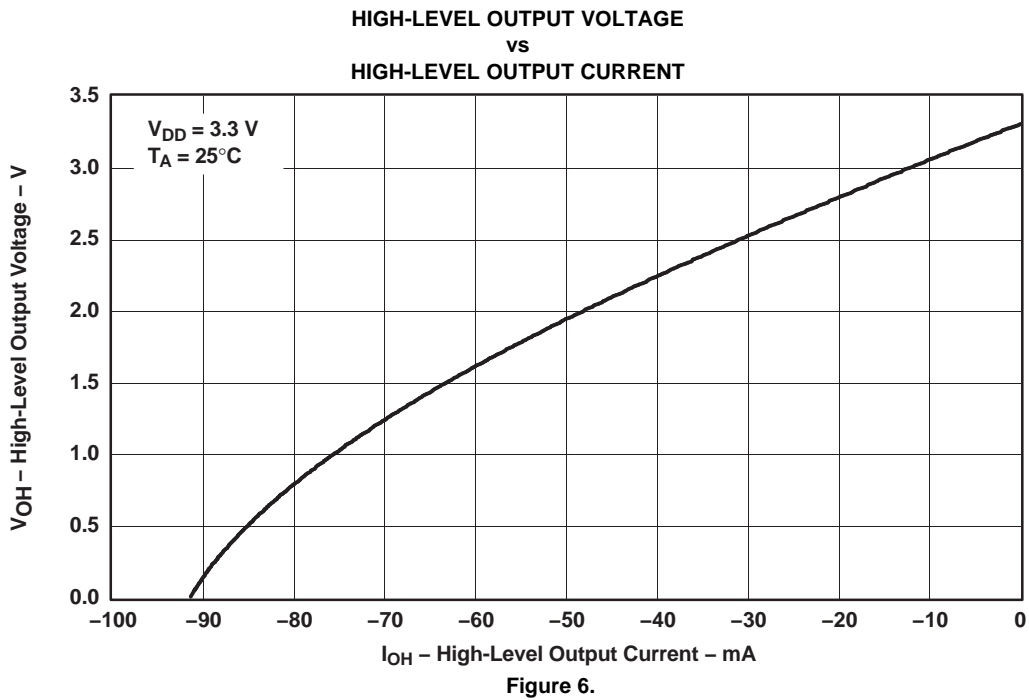
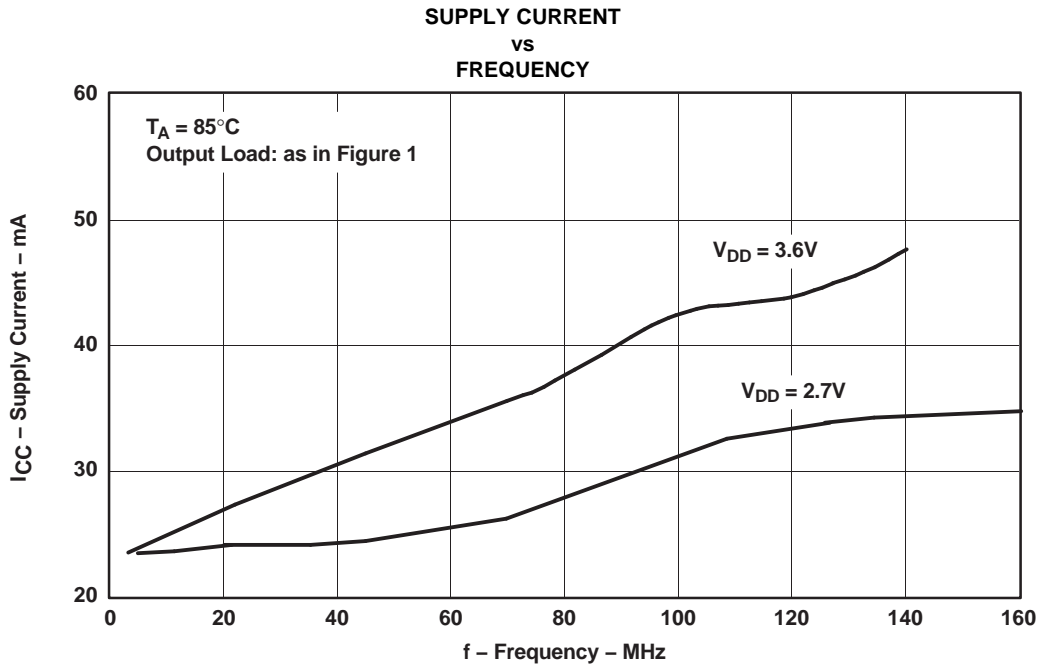

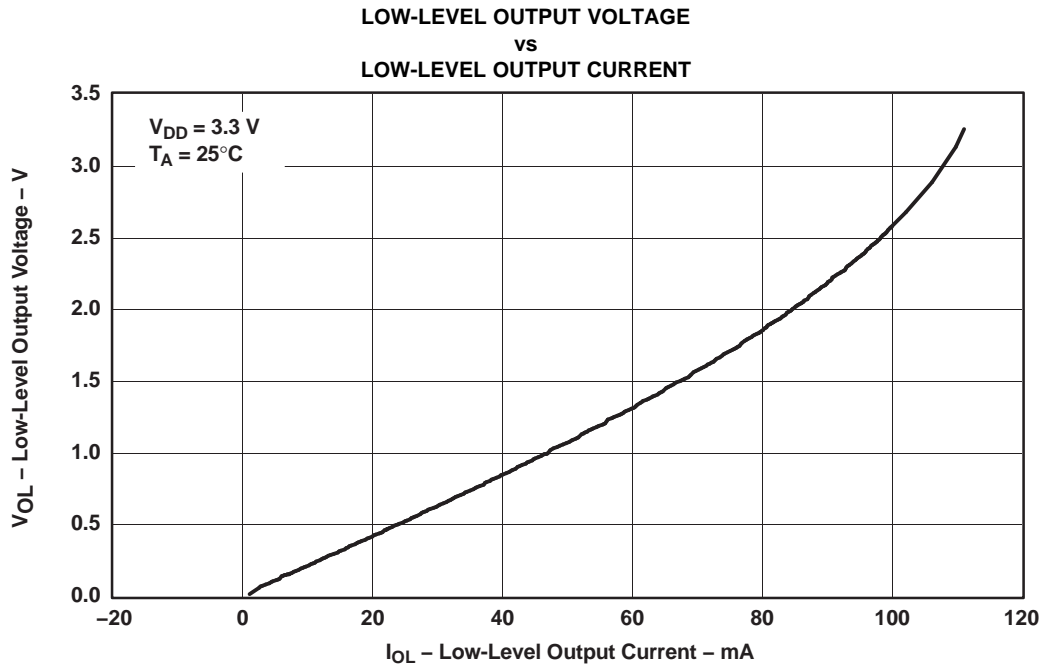

**PACKAGING INFORMATION**

| Orderable Device | Status <sup>(1)</sup> | Package Type | Package Drawing | Pins | Package Qty | Eco Plan <sup>(2)</sup> | Lead/Ball Finish | MSL Peak Temp <sup>(3)</sup> |
|------------------|-----------------------|--------------|-----------------|------|-------------|-------------------------|------------------|------------------------------|
| CDCV304PW        | ACTIVE                | TSSOP        | PW              | 8    | 150         | Green (RoHS & no Sb/Br) | CU NIPDAU        | Level-1-260C-UNLIM           |
| CDCV304PWG4      | ACTIVE                | TSSOP        | PW              | 8    | 150         | Green (RoHS & no Sb/Br) | CU NIPDAU        | Level-1-260C-UNLIM           |
| CDCV304PWR       | ACTIVE                | TSSOP        | PW              | 8    | 2000        | Green (RoHS & no Sb/Br) | CU NIPDAU        | Level-1-260C-UNLIM           |
| CDCV304PWRG4     | ACTIVE                | TSSOP        | PW              | 8    | 2000        | Green (RoHS & no Sb/Br) | CU NIPDAU        | Level-1-260C-UNLIM           |

<sup>(1)</sup> The marketing status values are defined as follows:

**ACTIVE:** Product device recommended for new designs.

**LIFEBUY:** TI has announced that the device will be discontinued, and a lifetime-buy period is in effect.

**NRND:** Not recommended for new designs. Device is in production to support existing customers, but TI does not recommend using this part in a new design.

**PREVIEW:** Device has been announced but is not in production. Samples may or may not be available.

**OBSOLETE:** TI has discontinued the production of the device.

<sup>(2)</sup> Eco Plan - The planned eco-friendly classification: Pb-Free (RoHS), Pb-Free (RoHS Exempt), or Green (RoHS & no Sb/Br) - please check <http://www.ti.com/productcontent> for the latest availability information and additional product content details.

**TBD:** The Pb-Free/Green conversion plan has not been defined.

**Pb-Free (RoHS):** TI's terms "Lead-Free" or "Pb-Free" mean semiconductor products that are compatible with the current RoHS requirements for all 6 substances, including the requirement that lead not exceed 0.1% by weight in homogeneous materials. Where designed to be soldered at high temperatures, TI Pb-Free products are suitable for use in specified lead-free processes.

**Pb-Free (RoHS Exempt):** This component has a RoHS exemption for either 1) lead-based flip-chip solder bumps used between the die and package, or 2) lead-based die adhesive used between the die and leadframe. The component is otherwise considered Pb-Free (RoHS compatible) as defined above.

**Green (RoHS & no Sb/Br):** TI defines "Green" to mean Pb-Free (RoHS compatible), and free of Bromine (Br) and Antimony (Sb) based flame retardants (Br or Sb do not exceed 0.1% by weight in homogeneous material)

<sup>(3)</sup> MSL, Peak Temp. -- The Moisture Sensitivity Level rating according to the JEDEC industry standard classifications, and peak solder temperature.

**Important Information and Disclaimer:** The information provided on this page represents TI's knowledge and belief as of the date that it is provided. TI bases its knowledge and belief on information provided by third parties, and makes no representation or warranty as to the accuracy of such information. Efforts are underway to better integrate information from third parties. TI has taken and continues to take reasonable steps to provide representative and accurate information but may not have conducted destructive testing or chemical analysis on incoming materials and chemicals. TI and TI suppliers consider certain information to be proprietary, and thus CAS numbers and other limited information may not be available for release.

In no event shall TI's liability arising out of such information exceed the total purchase price of the TI part(s) at issue in this document sold by TI to Customer on an annual basis.



## TAPE AND REEL INFORMATION



### QUADRANT ASSIGNMENTS FOR PIN 1 ORIENTATION IN TAPE



\*All dimensions are nominal

| Device     | Package Type | Package Drawing | Pins | SPQ  | Reel Diameter (mm) | Reel Width W1 (mm) | A0 (mm) | B0 (mm) | K0 (mm) | P1 (mm) | W (mm) | Pin1 Quadrant |
|------------|--------------|-----------------|------|------|--------------------|--------------------|---------|---------|---------|---------|--------|---------------|
| CDCV304PWR | TSSOP        | PW              | 8    | 2000 | 330.0              | 12.4               | 7.0     | 3.6     | 1.6     | 8.0     | 12.0   | Q1            |

TAPE AND REEL BOX DIMENSIONS



\*All dimensions are nominal

| Device     | Package Type | Package Drawing | Pins | SPQ  | Length (mm) | Width (mm) | Height (mm) |
|------------|--------------|-----------------|------|------|-------------|------------|-------------|
| CDCV304PWR | TSSOP        | PW              | 8    | 2000 | 346.0       | 346.0      | 29.0        |

PW (R-PDSO-G\*\*)

PLASTIC SMALL-OUTLINE PACKAGE

14 PINS SHOWN



4040064/F 01/97

- NOTES: A. All linear dimensions are in millimeters.  
 B. This drawing is subject to change without notice.  
 C. Body dimensions do not include mold flash or protrusion not to exceed 0,15.  
 D. Falls within JEDEC MO-153

## IMPORTANT NOTICE

Texas Instruments Incorporated and its subsidiaries (TI) reserve the right to make corrections, modifications, enhancements, improvements, and other changes to its products and services at any time and to discontinue any product or service without notice. Customers should obtain the latest relevant information before placing orders and should verify that such information is current and complete. All products are sold subject to TI's terms and conditions of sale supplied at the time of order acknowledgment.

TI warrants performance of its hardware products to the specifications applicable at the time of sale in accordance with TI's standard warranty. Testing and other quality control techniques are used to the extent TI deems necessary to support this warranty. Except where mandated by government requirements, testing of all parameters of each product is not necessarily performed.

TI assumes no liability for applications assistance or customer product design. Customers are responsible for their products and applications using TI components. To minimize the risks associated with customer products and applications, customers should provide adequate design and operating safeguards.

TI does not warrant or represent that any license, either express or implied, is granted under any TI patent right, copyright, mask work right, or other TI intellectual property right relating to any combination, machine, or process in which TI products or services are used. Information published by TI regarding third-party products or services does not constitute a license from TI to use such products or services or a warranty or endorsement thereof. Use of such information may require a license from a third party under the patents or other intellectual property of the third party, or a license from TI under the patents or other intellectual property of TI.

Reproduction of TI information in TI data books or data sheets is permissible only if reproduction is without alteration and is accompanied by all associated warranties, conditions, limitations, and notices. Reproduction of this information with alteration is an unfair and deceptive business practice. TI is not responsible or liable for such altered documentation. Information of third parties may be subject to additional restrictions.

Resale of TI products or services with statements different from or beyond the parameters stated by TI for that product or service voids all express and any implied warranties for the associated TI product or service and is an unfair and deceptive business practice. TI is not responsible or liable for any such statements.

TI products are not authorized for use in safety-critical applications (such as life support) where a failure of the TI product would reasonably be expected to cause severe personal injury or death, unless officers of the parties have executed an agreement specifically governing such use. Buyers represent that they have all necessary expertise in the safety and regulatory ramifications of their applications, and acknowledge and agree that they are solely responsible for all legal, regulatory and safety-related requirements concerning their products and any use of TI products in such safety-critical applications, notwithstanding any applications-related information or support that may be provided by TI. Further, Buyers must fully indemnify TI and its representatives against any damages arising out of the use of TI products in such safety-critical applications.

TI products are neither designed nor intended for use in military/aerospace applications or environments unless the TI products are specifically designated by TI as military-grade or "enhanced plastic." Only products designated by TI as military-grade meet military specifications. Buyers acknowledge and agree that any such use of TI products which TI has not designated as military-grade is solely at the Buyer's risk, and that they are solely responsible for compliance with all legal and regulatory requirements in connection with such use.

TI products are neither designed nor intended for use in automotive applications or environments unless the specific TI products are designated by TI as compliant with ISO/TS 16949 requirements. Buyers acknowledge and agree that, if they use any non-designated products in automotive applications, TI will not be responsible for any failure to meet such requirements.

Following are URLs where you can obtain information on other Texas Instruments products and application solutions:

| <b>Products</b>             |  | <b>Applications</b>        |  |
|-----------------------------|--|----------------------------|--|
| Amplifiers                  | <a href="http://amplifier.ti.com">amplifier.ti.com</a>             | Audio                      | <a href="http://www.ti.com/audio">www.ti.com/audio</a>                                   |
| Data Converters             | <a href="http://dataconverter.ti.com">dataconverter.ti.com</a>     | Automotive                 | <a href="http://www.ti.com/automotive">www.ti.com/automotive</a>                         |
| DLP® Products               | <a href="http://www.dlp.com">www.dlp.com</a>                       | Communications and Telecom | <a href="http://www.ti.com/communications">www.ti.com/communications</a>                 |
| DSP                         | <a href="http://dsp.ti.com">dsp.ti.com</a>                         | Computers and Peripherals  | <a href="http://www.ti.com/computers">www.ti.com/computers</a>                           |
| Clocks and Timers           | <a href="http://www.ti.com/clocks">www.ti.com/clocks</a>           | Consumer Electronics       | <a href="http://www.ti.com/consumer-apps">www.ti.com/consumer-apps</a>                   |
| Interface                   | <a href="http://interface.ti.com">interface.ti.com</a>             | Energy                     | <a href="http://www.ti.com/energy">www.ti.com/energy</a>                                 |
| Logic                       | <a href="http://logic.ti.com">logic.ti.com</a>                     | Industrial                 | <a href="http://www.ti.com/industrial">www.ti.com/industrial</a>                         |
| Power Mgmt                  | <a href="http://power.ti.com">power.ti.com</a>                     | Medical                    | <a href="http://www.ti.com/medical">www.ti.com/medical</a>                               |
| Microcontrollers            | <a href="http://microcontroller.ti.com">microcontroller.ti.com</a> | Security                   | <a href="http://www.ti.com/security">www.ti.com/security</a>                             |
| RFID                        | <a href="http://www.ti-rfid.com">www.ti-rfid.com</a>               | Space, Avionics & Defense  | <a href="http://www.ti.com/space-avionics-defense">www.ti.com/space-avionics-defense</a> |
| RF/IF and ZigBee® Solutions | <a href="http://www.ti.com/lprf">www.ti.com/lprf</a>               | Video and Imaging          | <a href="http://www.ti.com/video">www.ti.com/video</a>                                   |
|                             |  | Wireless                   | <a href="http://www.ti.com/wireless-apps">www.ti.com/wireless-apps</a>                   |