

4-Mbit (256K x 16) Static RAM

Features

- Pin-and function-compatible with CY7C1041B
- High speed
 - $t_{AA} = 10 \text{ ns}$
- Low active power
 - $I_{CC} = 90 \text{ mA @ } 10 \text{ ns (Industrial)}$
- Low CMOS standby power
 - $I_{SB2} = 10 \text{ mA}$
- 2.0 V Data Retention
- Automatic power-down when deselected
- TTL-compatible inputs and outputs
- Easy memory expansion with \overline{CE} and \overline{OE} features
- Available in lead-free 44-Lead (400-Mil) Molded SOJ and 44-Pin TSOP II packages

Functional Description^[1]

The CY7C1041D is a high-performance CMOS static RAM organized as 256K words by 16 bits. Writing to the device is accomplished by taking Chip Enable (\overline{CE}) and Write Enable (\overline{WE}) inputs LOW. If Byte Low Enable (\overline{BLE}) is LOW, then data from I/O pins (I/O_0 through I/O_7), is written into the location specified on the address pins (A_0 through A_{17}). If Byte High Enable (\overline{BHE}) is LOW, then data from I/O pins (I/O_8 through I/O_{15}) is written into the location specified on the address pins (A_0 through A_{17}).

Reading from the device is accomplished by taking Chip Enable (\overline{CE}) and Output Enable (\overline{OE}) LOW while forcing the Write Enable (\overline{WE}) HIGH. If Byte Low Enable (\overline{BLE}) is LOW, then data from the memory location specified by the address pins will appear on I/O_0 to I/O_7 . If Byte High Enable (\overline{BHE}) is LOW, then data from memory will appear on I/O_8 to I/O_{15} . See the truth table at the back of this data sheet for a complete description of read and write modes.

The input/output pins (I/O_0 through I/O_{15}) are placed in a high-impedance state when the device is deselected (\overline{CE} HIGH), the outputs are disabled (\overline{OE} HIGH), the \overline{BHE} and \overline{BLE} are disabled (\overline{BHE} , \overline{BLE} HIGH), or during a write operation (\overline{CE} LOW, and \overline{WE} LOW).

The CY7C1041D is available in a standard 44-pin 400-mil-wide body width SOJ and 44-pin TSOP II package with center power and ground (revolutionary) pinout.

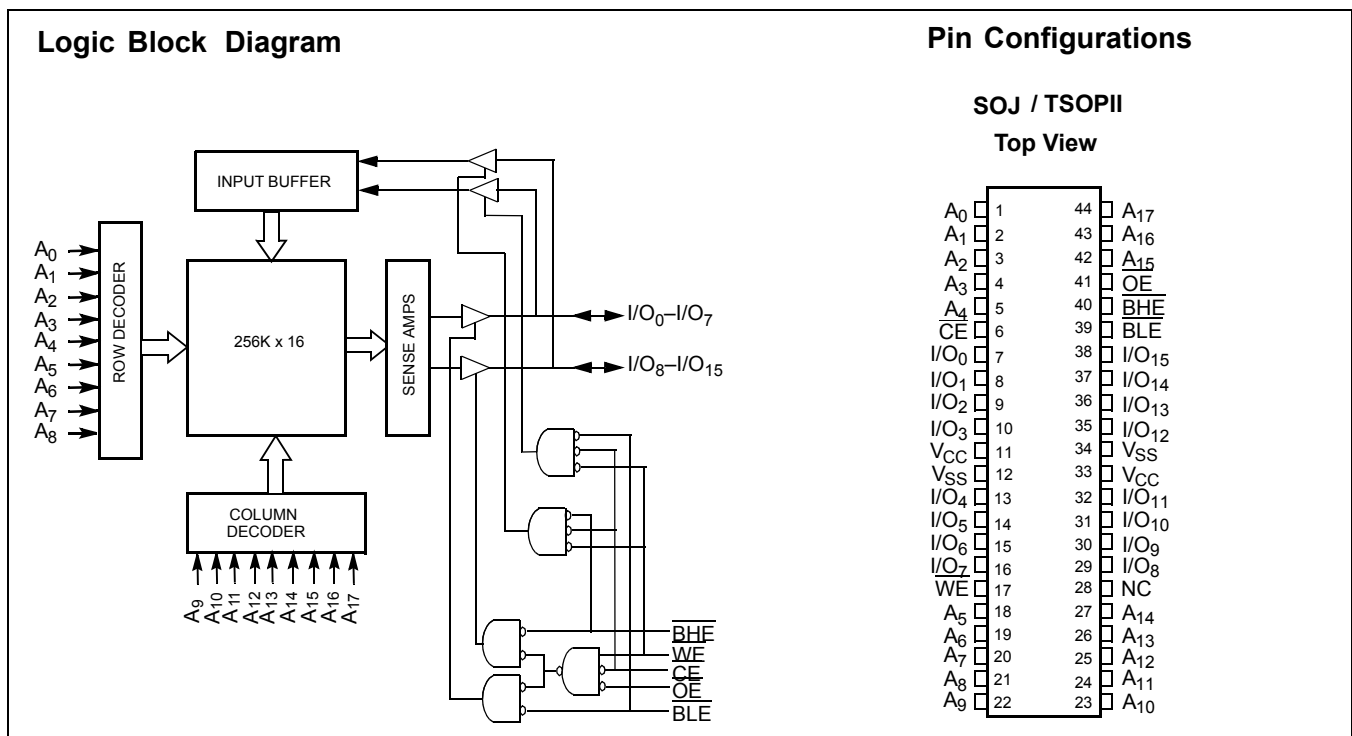

Note:

1. For guidelines on SRAM system design, please refer to the "System Design Guidelines" Cypress application note, available on the internet at www.cypress.com.

Selection Guide

	-10 (Industrial)	-12 (Automotive) ^[2]	Unit
Maximum Access Time	10	12	ns
Maximum Operating Current	90	95	mA
Maximum CMOS Standby Current	10	15	mA

Maximum Ratings

(Above which the useful life may be impaired. For user guidelines, not tested.)

Storage Temperature -65°C to +150°C

Ambient Temperature with Power Applied -55°C to +125°C

Supply Voltage on V_{CC} to Relative GND^[3] -0.5V to +6.0V

DC Voltage Applied to Outputs in High Z State^[3] -0.5V to V_{CC} + 0.5V

DC Input Voltage^[3] -0.5V to V_{CC} + 0.5V

Current into Outputs (LOW) 20 mA

Static Discharge Voltage >2001V

(per MIL-STD-883, Method 3015)

Latch-up Current >200 mA

Operating Range

Range	Ambient Temperature	V _{CC}	Speed
Industrial	-40°C to +85°C	5V ± 0.5	10 ns
Automotive	-40°C to +125°C	5V ± 0.5	12 ns

Electrical Characteristics Over the Operating Range

Parameter	Description	Test Conditions	-10 (Industrial)		-12 (Automotive)		Unit
			Min.	Max.	Min.	Max.	
V _{OH}	Output HIGH Voltage	V _{CC} = Min., I _{OH} = -4.0 mA V _{CC} = Min., I _{OL} = 8.0 mA	2.4		2.4		V
V _{OL}	Output LOW Voltage			0.4		0.4	V
V _{IH}	Input HIGH Voltage		2.0	V _{CC} + 0.5	2.0	V _{CC} + 0.5	V
V _{IL}	Input LOW Voltage ^[3]		-0.5	0.8	-0.5	0.8	V
I _{IX}	Input Leakage Current	GND ≤ V _I ≤ V _{CC}	-1	+1	-1	+1	μA
I _{OZ}	Output Leakage Current	GND ≤ V _{OUT} ≤ V _{CC} , Output Disabled	-1	+1	-1	+1	μA
I _{CC}	V _{CC} Operating Supply Current	V _{CC} = Max., f = f _{MAX} = 1/t _{RC}	100 MHz	90		-	mA
			83 MHz	80		95	mA
			66 MHz	70		85	mA
			40 MHz	60		75	mA
I _{SB1}	Automatic CE Power-Down Current —TTL Inputs	Max. V _{CC} , CE ≥ V _{IH} , V _{IN} ≥ V _{IH} or V _{IN} ≤ V _{IL} , f = f _{MAX}		20		25	mA
I _{SB2}	Automatic CE Power-Down Current —CMOS Inputs	Max. V _{CC} , CE ≥ V _{CC} - 0.3V, V _{IN} ≥ V _{CC} - 0.3V, or V _{IN} ≤ 0.3V, f = 0		10		15	mA

Capacitance^[4]

Parameter	Description	Test Conditions	Max.	Unit
C _{IN}	Input Capacitance	T _A = 25°C, f = 1 MHz, V _{CC} = 5.0V	8	pF
C _{OUT}	I/O Capacitance		8	pF

Notes:

- Automotive product information is Preliminary.
- V_{IL} (min.) = -2.0V and V_{IH} (max) = V_{CC} + 2V for pulse durations of less than 20 ns.
- Tested initially and after any design or process changes that may affect these parameters.

Thermal Resistance^[4]

Parameter	Description	Test Conditions	SOJ Package	TSOP II Package	Unit
Θ_{JA}	Thermal Resistance (Junction to Ambient) ^[4]	Still Air, soldered on a 3 × 4.5 inch, four-layer printed circuit board	57.91	50.66	°C/W
Θ_{JC}	Thermal Resistance (Junction to Case) ^[4]		36.73	17.17	°C/W

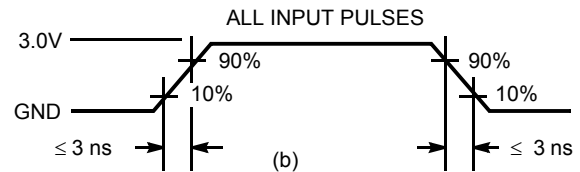
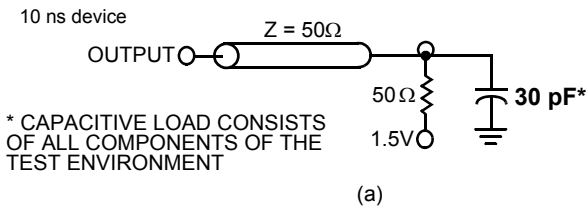
AC Test Loads and Waveforms^[5]

High-Z Characteristics:

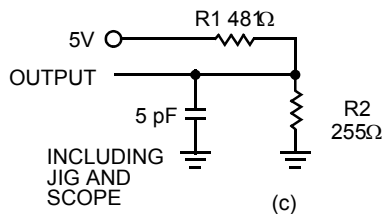
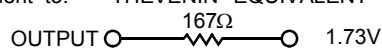
 Equivalent to: THÉVENIN EQUIVALENT

Switching Characteristics^[6] Over the Operating Range

Parameter	Description	-10 (Industrial)		-12 (Automotive)		Unit
		Min.	Max.	Min.	Max.	
Read Cycle						
t_{power}	V_{CC} (typical) to the First Access ^[7]	100		100		μs
t_{RC}	Read Cycle Time	10		12		ns
t_{AA}	Address to Data Valid		10		12	ns
t_{OHA}	Data Hold from Address Change	3		3		ns
t_{ACE}	\overline{CE} LOW to Data Valid		10		12	ns
t_{DOE}	\overline{OE} LOW to Data Valid		5		6	ns
t_{LZOE}	\overline{OE} LOW to Low Z	0		0		ns
t_{HZOE}	\overline{OE} HIGH to High Z ^[8, 9]		5		6	ns
t_{LZCE}	\overline{CE} LOW to Low Z ^[9]	3		3		ns
t_{HZCE}	\overline{CE} HIGH to High Z ^[8, 9]		5		6	ns
t_{PU}	\overline{CE} LOW to Power-Up	0		0		ns
t_{PD}	\overline{CE} HIGH to Power-Down		10		12	ns
t_{DBE}	Byte Enable to Data Valid		5		6	ns
t_{LZBE}	Byte Enable to Low Z	0		0		ns
t_{HZBE}	Byte Disable to High Z		5		6	ns

Notes:

- AC characteristics (except High-Z) are tested using the load conditions shown in Figure (a). High-Z characteristics are tested for all speeds using the test load shown in Figure (c)
- Test conditions assume signal transition time of 3 ns or less, timing reference levels of 1.5V, input pulse levels of 0 to 3.0V, and output loading of the specified I_{OL}/I_{OH} and 30-pF load capacitance.
- t_{POWER} gives the minimum amount of time that the power supply should be at typical V_{CC} values until the first memory access can be performed.
- t_{HZOE} , t_{HZCE} , t_{HZBE} , and t_{HZWE} are specified with a load capacitance of 5 pF as in part (c) of AC Test Loads. Transition is measured when the outputs enter a high impedance state.
- At any given temperature and voltage condition, t_{HZCE} is less than t_{LZCE} , t_{HZOE} is less than t_{LZOE} , t_{HZBE} is less than t_{LZBE} , and t_{HZWE} is less than t_{LZWE} for any given device.

Switching Characteristics^[6] Over the Operating Range(continued)

Parameter	Description	-10 (Industrial)		-12 (Automotive)		Unit
		Min.	Max.	Min.	Max.	
Write Cycle^[10, 11]						
t_{WC}	Write Cycle Time	10		12		ns
t_{SCE}	\overline{CE} LOW to Write End	7		10		ns
t_{AW}	Address Set-Up to Write End	7		10		ns
t_{HA}	Address Hold from Write End	0		0		ns
t_{SA}	Address Set-Up to Write Start	0		0		ns
t_{PWE}	\overline{WE} Pulse Width	7		10		ns
t_{SD}	Data Set-Up to Write End	6		7		ns
t_{HD}	Data Hold from Write End	0		0		ns
t_{LZWE}	\overline{WE} HIGH to Low Z ^[9]	3		3		ns
t_{HZWE}	\overline{WE} LOW to High Z ^[8, 9]		5		6	ns
t_{BW}	Byte Enable to End of Write	7		10		ns

Data Retention Characteristics Over the Operating Range

Parameter	Description	Conditions ^[13]	Min.	Max.	Unit
V_{DR}	V_{CC} for Data Retention		2.0		V
I_{CCDR}	Data Retention Current	$V_{CC} = V_{DR} = 2.0V$, $CE \geq V_{CC} - 0.3V$, $V_{IN} \geq V_{CC} - 0.3V$ or $V_{IN} \leq 0.3V$	Ind'l	10	mA
I_{CCDR}	Data Retention Current		Auto	15	mA
t_{CDR} ^[4]	Chip Deselect to Data Retention Time		0		ns
t_R ^[12]	Operation Recovery Time		t_{RC}		ns

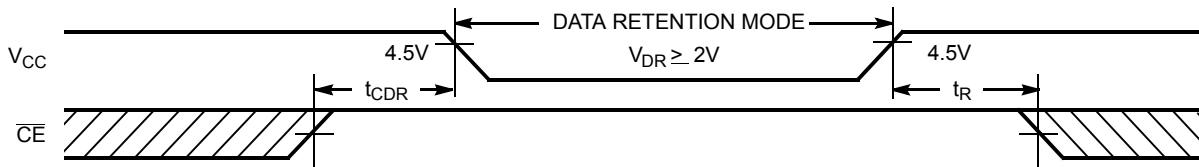
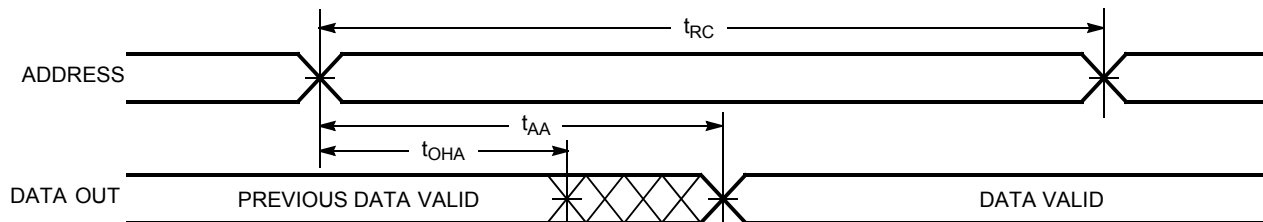
Data Retention Waveform

Switching Waveforms
Read Cycle No. 1^[13, 14]

Notes:

- The internal Write time of the memory is defined by the overlap of \overline{CE} LOW, and \overline{WE} LOW. \overline{CE} and \overline{WE} must be LOW to initiate a Write, and the transition of either of these signals can terminate the Write. The input data set-up and hold timing should be referenced to the leading edge of the signal that terminates the Write.
- The minimum Write cycle time for Write Cycle No. 3 (\overline{WE} controlled, \overline{OE} LOW) is the sum of t_{HZWE} and t_{SD} .
- Full device operation requires linear V_{CC} ramp from V_{DR} to $V_{CC(min.)} \geq 50 \mu s$ or stable at $V_{CC(min.)} \geq 50 \mu s$
- No input may exceed $V_{CC} + 0.5V$.
- Device is continuously selected. \overline{OE} , \overline{CE} , \overline{BHE} , and/or $\overline{BHE} = V_{IL}$.

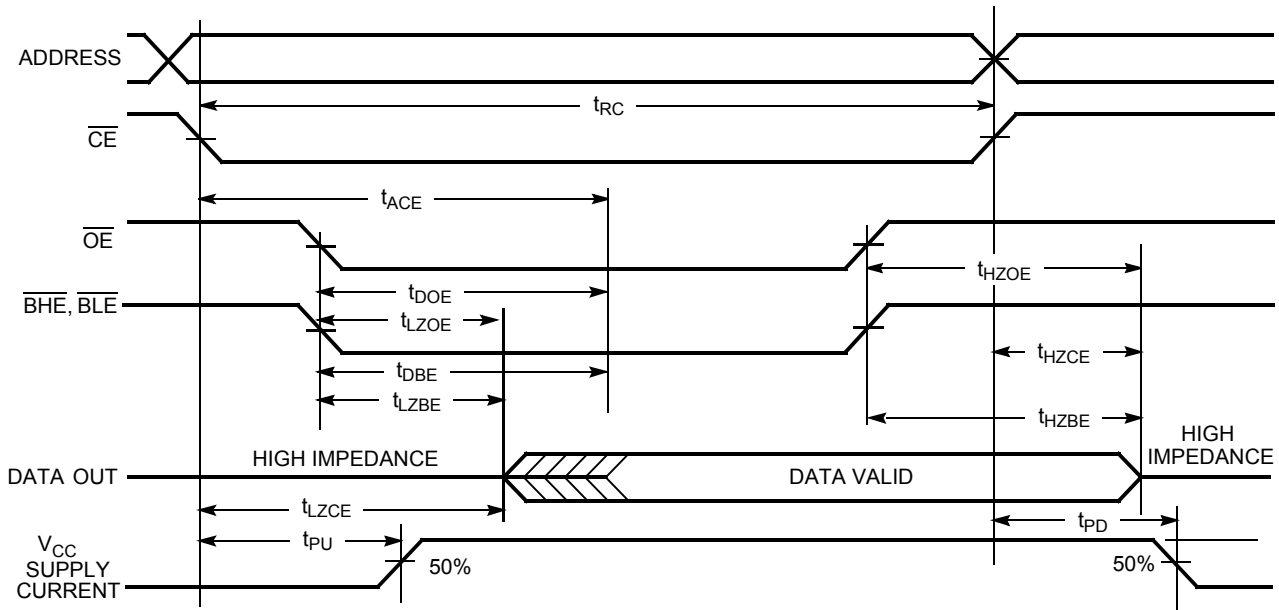
Switching Waveforms (continued)

Read Cycle No. 2 (\overline{OE} Controlled) [15,16]



Write Cycle No. 1 (\overline{CE} Controlled) [17, 18]

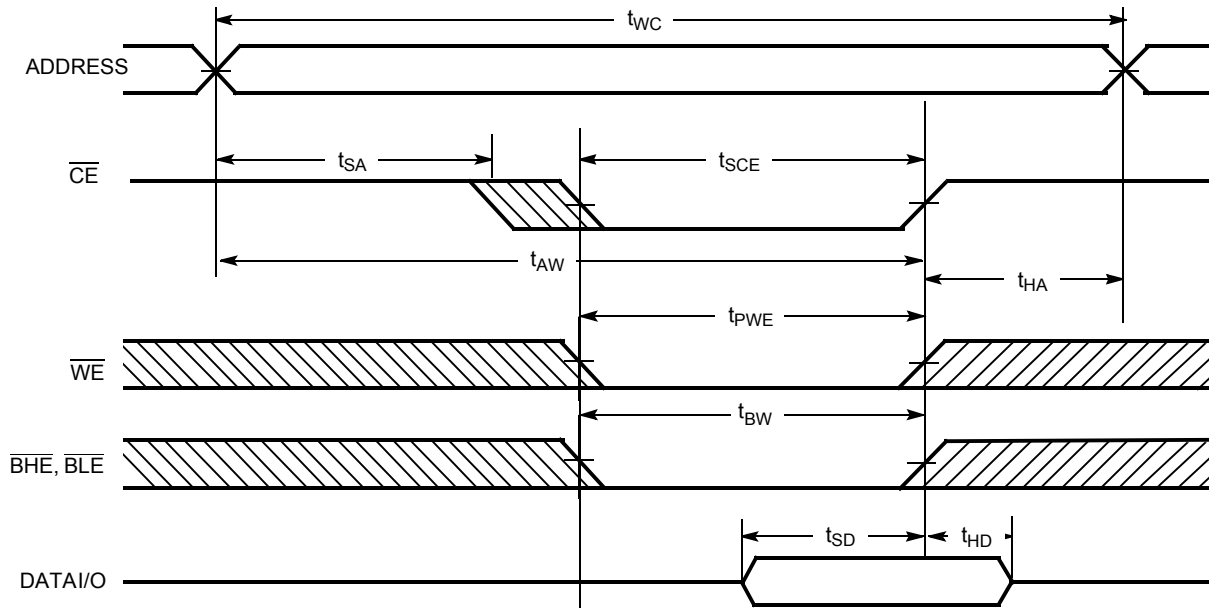

Notes:

- 15. WE is HIGH for read cycle.
- 16. Address valid prior to or coincident with \overline{CE} transition LOW
- 17. Data I/O is high impedance if OE or BHE and/or BLE = V_{IH} .
- 18. If \overline{CE} goes HIGH simultaneously with WE going HIGH, the output remains in a high-impedance state.

Switching Waveforms (continued)

Write Cycle No. 2 ($\overline{\text{BLE}}$ or $\overline{\text{BHE}}$ Controlled)

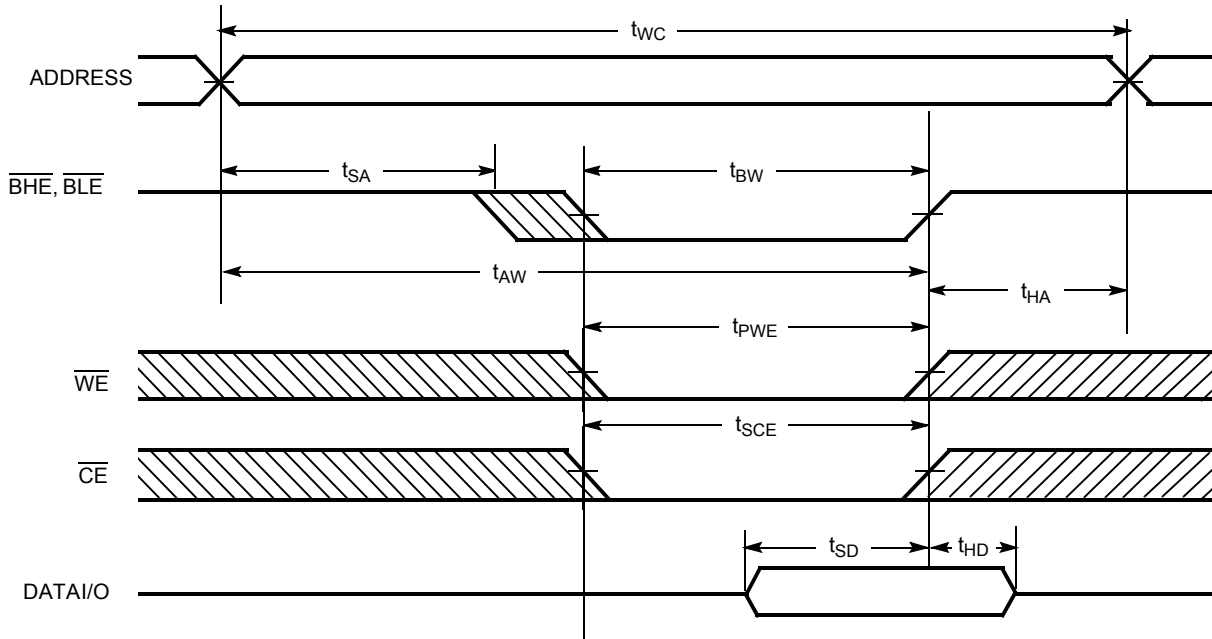

Write Cycle No. 3 ($\overline{\text{WE}}$ Controlled, $\overline{\text{OE}}$ HIGH During Write)^[16, 17]

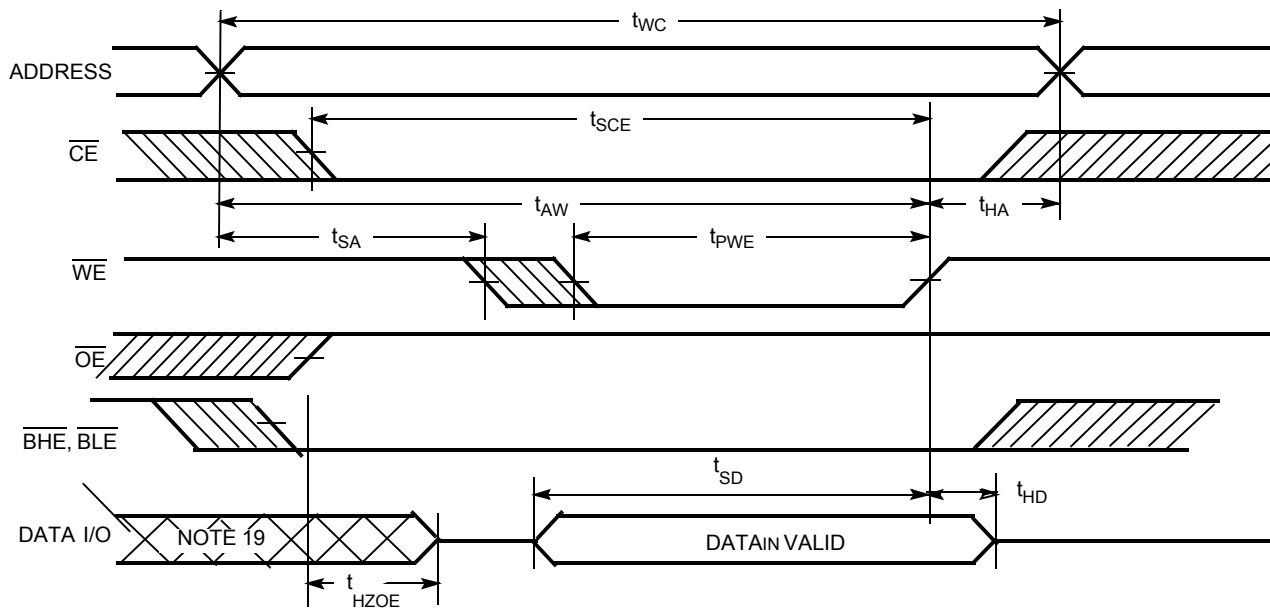

Note:
19. During this period the I/Os are in the output state and input signals should not be applied.

Switching Waveforms (continued)

Write Cycle No. 4 (\overline{WE} Controlled, \overline{OE} LOW)

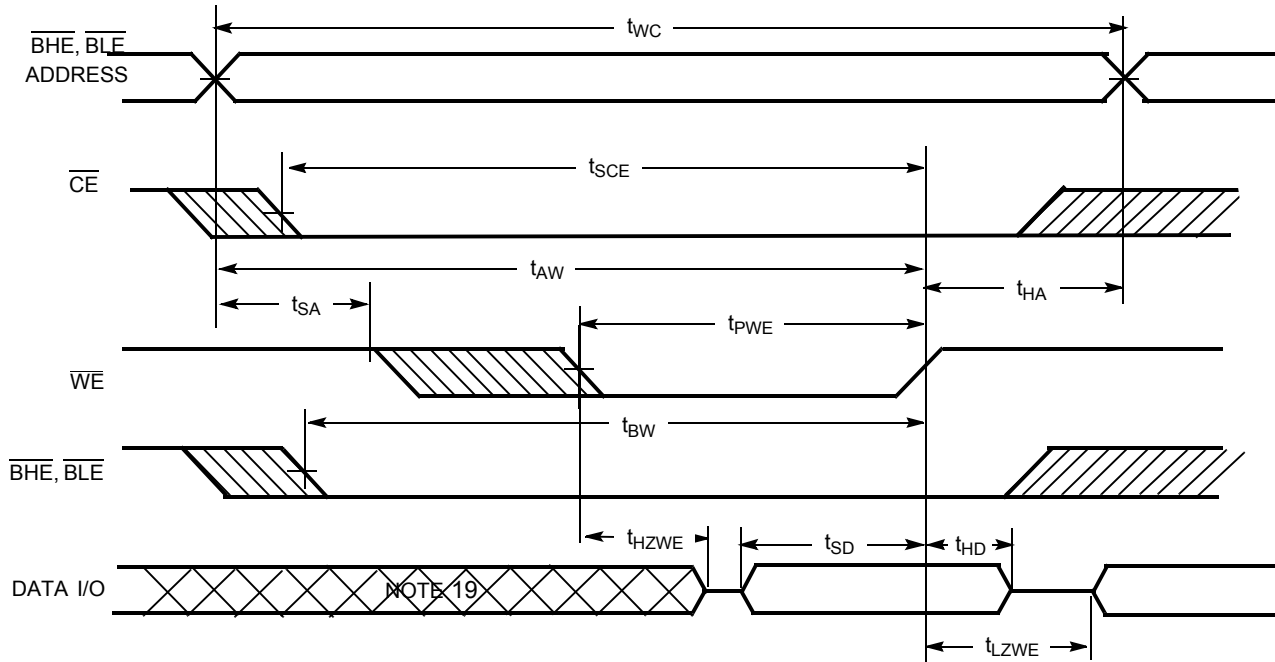

Truth Table

\overline{CE}	\overline{OE}	\overline{WE}	\overline{BLE}	\overline{BHE}	I/O ₀ -I/O ₇	I/O ₈ -I/O ₁₅	Mode	Power
H	X	X	X	X	High Z	High Z	Power Down	Standby (I_{SB})
L	L	H	L	L	Data Out	Data Out	Read All bits	Active (I_{CC})
L	L	H	L	H	Data Out	High Z	Read Lower bits only	Active (I_{CC})
L	L	H	H	L	High Z	Data Out	Read Upper bits only	Active (I_{CC})
L	X	L	L	L	Data In	Data In	Write All bits	Active (I_{CC})
L	X	L	L	H	Data In	High Z	Write Lower bits only	Active (I_{CC})
L	X	L	H	L	High Z	Data In	Write Upper bits only	Active (I_{CC})
L	H	H	X	X	High Z	High Z	Selected, Outputs Disabled	Active (I_{CC})

Ordering Information

Speed (ns)	Ordering Code	Package Diagram	Package Type	Operating Range
10	CY7C1041D-10VXI	51-85082	44-Lead (400-Mil) Molded SOJ (Pb-Free)	Industrial
	CY7C1041D-10ZSXI	51-85087	44-Lead TSOP Type II (Pb-Free)	
12	CY7C1041D-12VXE	51-85082	44-Lead (400-Mil) Molded SOJ (Pb-Free)	Automotive
	CY7C1041D-12ZSXE	51-85087	44-Lead TSOP Type II (Pb-Free)	

Please contact your local Cypress sales representative for availability of these parts.

Package Diagrams

44-Lead (400-Mil) Molded SOJ (51-85082)

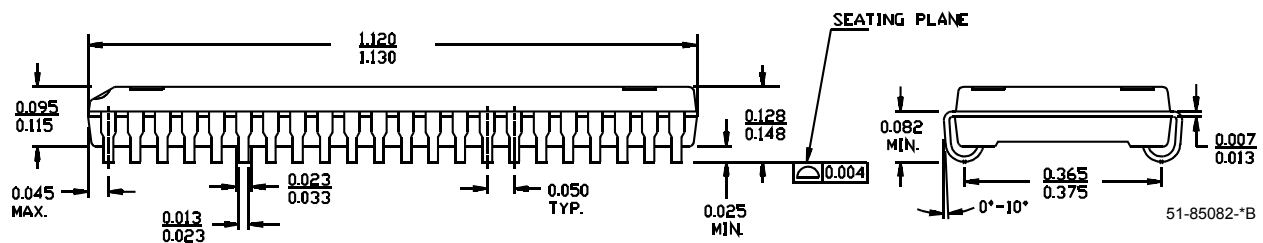
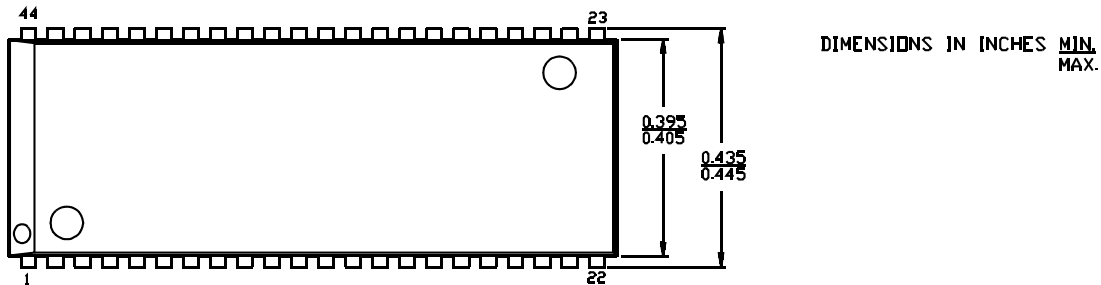

44-Pin TSOP II (51-85087)

DIMENSION IN MM (INCH)
MAX
MIN.

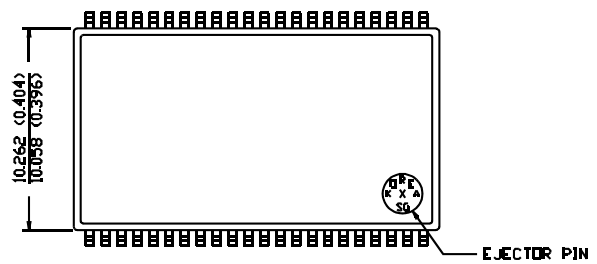
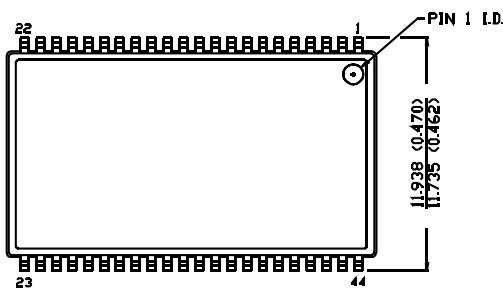

TOP VIEW

BOTTOM VIEW

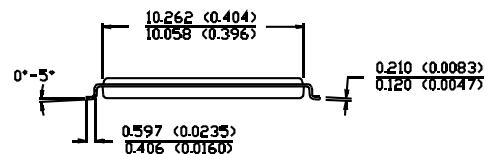
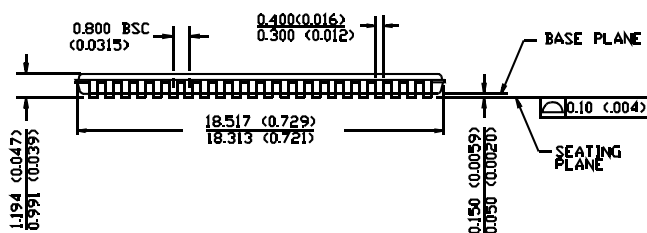

All products and company names mentioned in this document may be the trademarks of their respective holders.

Document History Page

Document Title: CY7C1041D 4-Mbit (256K x 16) Static RAM Document Number: 38-05472				
REV.	ECN NO.	Issue Date	Orig. of Change	Description of Change
**	201560	See ECN	SWI	Advance Datasheet for C9 IPP
*A	233729	See ECN	RKF	1.AC, DC parameters are modified as per EROS (Spec #01-2165) 2.Pb-free offering in the 'ordering information'
*B	351117	See ECN	PCI	Changed from Advance to Preliminary Removed 17 and 20 ns Speed bin Added footnote # 4 Redefined I _{CC} values for Com'l and Ind'l temperature ranges I _{CC} (Com'l): Changed from 67 and 54 mA to 75 and 70 mA for 12 and 15 ns speed bins respectively I _{CC} (Ind'l): Changed from 80, 67 and 54 mA to 90, 85 and 80 mA for 10, 12 and 15 ns speed bins respectively Changed footnote # 10 on t _R Changed t _{SCE} from 8 to 7 ns for 10 ns speed bin Added Static Discharge Voltage and latch-up current spec Added V _{IH(max)} spec in footnote # 2 Changed reference voltage level for measurement of Hi-Z parameters from ±500 mV to ±200 mV Added Write Cycle (\overline{WE} Controlled, \overline{OE} HIGH During Write) Timing Diagram Changed part names from Z to ZS in the Ordering Information Table Removed L-Version Added 10 ns parts in the Ordering Information Table Added Lead-Free Ordering Information Shaded Ordering Information Table
*C	446328	See ECN	NXR	Converted Preliminary to Final Removed -15 speed bin Removed Commercial Operating Range product information Added Automotive Operating Range product information Changed Maximum Rating for supply voltage from 7V to 6V Updated Thermal Resistance table Changed t _{HZWE} from 6 ns to 5 ns Updated footnote #8 on High-Z parameter measurement Updated the Ordering Information and replaced Package Name column with Package Diagram in the Ordering Information table