

PIC32MX Starter Kit User's Guide

Note the following details of the code protection feature on Microchip devices:

- Microchip products meet the specification contained in their particular Microchip Data Sheet.
- Microchip believes that its family of products is one of the most secure families of its kind on the market today, when used in the intended manner and under normal conditions.
- There are dishonest and possibly illegal methods used to breach the code protection feature. All of these methods, to our knowledge, require using the Microchip products in a manner outside the operating specifications contained in Microchip's Data Sheets. Most likely, the person doing so is engaged in theft of intellectual property.
- Microchip is willing to work with the customer who is concerned about the integrity of their code.
- Neither Microchip nor any other semiconductor manufacturer can guarantee the security of their code. Code protection does not mean that we are guaranteeing the product as "unbreakable."

Code protection is constantly evolving. We at Microchip are committed to continuously improving the code protection features of our products. Attempts to break Microchip's code protection feature may be a violation of the Digital Millennium Copyright Act. If such acts allow unauthorized access to your software or other copyrighted work, you may have a right to sue for relief under that Act.

Information contained in this publication regarding device applications and the like is provided only for your convenience and may be superseded by updates. It is your responsibility to ensure that your application meets with your specifications. MICROCHIP MAKES NO REPRESENTATIONS OR WARRANTIES OF ANY KIND WHETHER EXPRESS OR IMPLIED, WRITTEN OR ORAL, STATUTORY OR OTHERWISE, RELATED TO THE INFORMATION, INCLUDING BUT NOT LIMITED TO ITS CONDITION, QUALITY, PERFORMANCE, MERCHANTABILITY OR FITNESS FOR PURPOSE. Microchip disclaims all liability arising from this information and its use. Use of Microchip devices in life support and/or safety applications is entirely at the buyer's risk, and the buyer agrees to defend, indemnify and hold harmless Microchip from any and all damages, claims, suits, or expenses resulting from such use. No licenses are conveyed, implicitly or otherwise, under any Microchip intellectual property rights.

Trademarks

The Microchip name and logo, the Microchip logo, Accuron, dsPIC, KEELOQ, KEELOQ logo, microID, MPLAB, PIC, PICmicro, PICSTART, PRO MATE, rPIC and SmartShunt are registered trademarks of Microchip Technology Incorporated in the U.S.A. and other countries.

AmPLab, FilterLab, Linear Active Thermistor, Migratable Memory, MXDEV, MXLAB, SEEVAL, SmartSensor and The Embedded Control Solutions Company are registered trademarks of Microchip Technology Incorporated in the U.S.A.

Analog-for-the-Digital Age, Application Maestro, CodeGuard, dsPICDEM, dsPICDEM.net, dsPICworks, dsSPEAK, ECAN, ECONOMONITOR, FanSense, FlexROM, fuzzyLAB, In-Circuit Serial Programming, ICSP, ICEPIC, Mindi, MiWi, MPASM, MPLAB Certified logo, MPLIB, MPLINK, PICkit, PICDEM, PICDEM.net, PICLAB, PICtail, PowerCal, PowerInfo, PowerMate, PowerTool, REAL ICE, rLAB, Select Mode, Smart Serial, SmartTel, Total Endurance, UNI/O, WiperLock and ZENA are trademarks of Microchip Technology Incorporated in the U.S.A. and other countries.

SQTP is a service mark of Microchip Technology Incorporated in the U.S.A.

All other trademarks mentioned herein are property of their respective companies.

© 2007, Microchip Technology Incorporated, Printed in the U.S.A., All Rights Reserved.

 Printed on recycled paper.

QUALITY MANAGEMENT SYSTEM
CERTIFIED BY DNV
== ISO/TS 16949:2002 ==

Microchip received ISO/TS-16949:2002 certification for its worldwide headquarters, design and wafer fabrication facilities in Chandler and Tempe, Arizona; Gresham, Oregon and design centers in California and India. The Company's quality system processes and procedures are for its PIC® MCUs and dsPIC® DSCs, KEELOQ® code hopping devices, Serial EEPROMs, microperipherals, nonvolatile memory and analog products. In addition, Microchip's quality system for the design and manufacture of development systems is ISO 9001:2000 certified.

Table of Contents

Preface	1
Chapter 1. Introducing the PIC32MX Starter Kit	
1.1 Introduction	5
1.2 Highlights	5
1.3 Kit Contents	5
1.4 PIC32MX Functionality and Features	6
1.5 Using the PIC32MX Starter Kit Out of the Box	7
1.6 Installing the PIC32MX Starter Kit CD	7
1.7 PIC32MX Demonstration Program	7
Chapter 2. PIC32MX Starter Kit Tutorial	
2.1 Introduction	9
2.2 Highlights	9
2.3 Host Computer Requirements	9
2.4 Installing the Starter Kit Board	10
2.5 Starting the Tutorial Project	14
2.6 Building the Project	15
2.7 Programming the Device	16
2.8 Running the Program	17
2.9 Tutorial Program Operation	17
Chapter 3. Create a New Project	
3.1 Introduction	21
3.2 Highlights	21
3.3 Creating a New Project	21
Chapter 4. PIC32MX Starter Kit Hardware	
4.1 Introduction	31
4.2 Hardware Features	31
Appendix A. PIC32MX Starter Kit Schematics	
A.1 Introduction	33
A.2 Development Board Block Diagram	33
A.3 Starter Kit Board Schematics	33
Index	39
Worldwide Sales and Service	40

PIC32MX Starter Kit User's Guide

NOTES:

Preface

NOTICE TO CUSTOMERS

All documentation becomes dated, and this manual is no exception. Microchip tools and documentation are constantly evolving to meet customer needs, so some actual dialogs and/or tool descriptions may differ from those in this document. Please refer to our web site (www.microchip.com) to obtain the latest documentation available.

Documents are identified with a “DS” number. This number is located on the bottom of each page, in front of the page number. The numbering convention for the DS number is “DSXXXXA”, where “XXXX” is the document number and “A” is the revision level of the document.

For the most up-to-date information on development tools, see the MPLAB® IDE online help. Select the Help menu, and then Topics to open a list of available online help files.

INTRODUCTION

This chapter contains general information that will be useful to know before using the PIC32MX. Items discussed in this chapter include:

- Document Layout
- Conventions Used in this Guide
- Recommended Reading
- The Microchip Web Site
- Development Systems Customer Change Notification Service
- Customer Support
- Document Revision History

DOCUMENT LAYOUT

This document describes how to use the PIC32MX Starter Kit as a development tool to emulate and debug firmware on a target board. The manual is composed of the following chapters:

- **Chapter 1. “Introducing the PIC32MX Starter Kit”** provides a brief overview of the PIC32MX Starter Kit, highlighting its features and uses.
- **Chapter 2. “PIC32MX Starter Kit Tutorial”** provides step-by-step instructions for installing the PIC32MX and using the Microchip MPLAB IDE to build and run the tutorial program on the PIC32MX Starter Kit.
- **Chapter 3. “Create a New Project”** provides step-by-step instructions for creating a new project using the MPLAB IDE and loading it onto the PIC32MX Starter Kit.
- **Chapter 4. “PIC32MX Starter Kit Hardware”** provides a more detailed description of the features of the hardware included in the PIC32MX Starter Kit.
- **Appendix A. “PIC32MX Starter Kit Schematics”** provides a block diagram and detailed schematics of the PIC32MX Starter Kit.

PIC32MX Starter Kit User's Guide

CONVENTIONS USED IN THIS GUIDE

This manual uses the following documentation conventions:

DOCUMENTATION CONVENTIONS

Description	Represents	Examples
Arial font:		
Italic characters	Referenced books	<i>MPLAB[®] IDE User's Guide</i>
	Emphasized text	...is the <i>only</i> compiler...
Initial caps	A window	the Output window
	A dialog	the Settings dialog
	A menu selection	select Enable Programmer
Quotes	A field name in a window or dialog	"Save project before build"
Underlined, italic text with right angle bracket	A menu path	<u><i>File>Save</i></u>
Bold characters	A dialog button	Click OK
	A tab	Click the Power tab
Text in angle brackets < >	A key on the keyboard	Press <Enter>, <F1>
Courier New font:		
Plain Courier New	Sample source code	<code>#define START</code>
	Filenames	<code>autoexec.bat</code>
	File paths	<code>c:\mcc18\h</code>
	Keywords	<code>_asm, _endasm, static</code>
	Command-line options	<code>-Opa+, -Opa-</code>
	Bit values	<code>0, 1</code>
	Constants (in source code)	<code>0xFF, 'A'</code>
Italic Courier New	A variable argument	<i>file.o</i> , where <i>file</i> can be any valid filename
Square brackets []	Optional arguments	<code>mcc18 [options] file [options]</code>
Curly brackets and pipe character: { }	Choice of mutually exclusive arguments; an OR selection	<code>errorlevel {0 1}</code>
Ellipses...	Replaces repeated text	<code>var_name [, var_name...]</code>
	Represents code supplied by user	<code>void main (void) { ... }</code>

RECOMMENDED READING

This user's guide describes how to use the PIC32MX Starter Kit.

The following Microchip documents are available and recommended as supplemental reference resources.

Readme for the PIC32MX

For the latest information on using PIC32MX microcontrollers, read the `PIC32MX.txt` file (an ASCII text file) at the root level of the CD included in the PIC32MX Starter Kit. The file generally contains the most current update information, as well as any issues that may not have been available when this user's guide was published.

Readme Files

For the latest information on using other tools, read the tool-specific readme files in the `Readmes` subdirectory of the PIC32MX Starter Kit installation directory. The files contain update information, as well as any issues that may not have been available when this user's guide was published.

PIC32MX Data Sheet (DS61143)

Consult this document for detailed information on the PIC32MX general purpose, 32-bit devices. Reference information found in this data sheet includes:

- Device memory map
- Device pinout and packaging details
- Device electrical specifications
- List of peripherals included on the device

MPLAB[®] C32 C Compiler User's Guide (DS51686)

This document details the use of Microchip's MPLAB C32 C Compiler for PIC32MX devices to develop an application. MPLAB C32 is a GNU-based language tool, based on source code from the Free Software Foundation (FSF). For more information about FSF, see their web site at www.fsf.org.

MPLAB[®] IDE User's Guide (DS51519)

Consult this document for more information pertaining to the installation and implementation of the MPLAB IDE software, as well as the MPLAB Editor and MPLAB SIM Simulator software that are included with it.

THE MICROCHIP WEB SITE

Microchip provides online support via our web site at www.microchip.com. This web site makes files and information easily available to customers. Accessible by most Internet browsers, the web site contains the following information:

- **Product Support** – Data sheets and errata, application notes and sample programs, design resources, user's guides and hardware support documents, latest software releases and archived software
- **General Technical Support** – Frequently Asked Questions (FAQs), technical support requests, online discussion groups, Microchip consultant program member listings
- **Business of Microchip** – Product selector and ordering guides, latest Microchip press releases, listings of seminars and events; and listings of Microchip sales offices, distributors and factory representatives

PIC32MX Starter Kit User's Guide

DEVELOPMENT SYSTEMS CUSTOMER CHANGE NOTIFICATION SERVICE

Microchip's customer notification service helps keep customers current on Microchip products. Subscribers will receive e-mail notification whenever there are changes, updates, revisions or errata related to a specified product family or development tool of interest.

To register, access the Microchip web site at www.microchip.com, click on Customer Change Notification and follow the registration instructions.

The Development Systems product group categories are:

- **Compilers** – The latest information on Microchip C compilers and other language tools. These include the MPLAB C18, MPLAB C30, and MPLAB C32 C compilers; ASM32, MPASM™ and MPLAB ASM30 assemblers; MPLINK™, and MPLAB LINK30, MPLAB LINK32 object linkers; and MPLIB™ and MPLAB LIB30 object librarians.
- **Emulators** – The latest information on Microchip in-circuit emulators. This includes the MPLAB REAL ICE™ and MPLAB ICE 2000 in-circuit emulators.
- **In-Circuit Debuggers** – The latest information on the Microchip in-circuit debuggers. This includes the MPLAB ICD 2 and PICKit™ 2.
- **MPLAB® IDE** – The latest information on Microchip MPLAB IDE, the Windows® Integrated Development Environment for development systems tools. This list is focused on the MPLAB IDE, MPLAB IDE Project Manager, MPLAB Editor and MPLAB SIM simulator, as well as general editing and debugging features.
- **Programmers** – The latest information on Microchip programmers. These include the MPLAB PM3 device programmer and the PICSTART® Plus, PICKit™ 1 and PICKit 2 development programmers.

CUSTOMER SUPPORT

Several channels are available to assist the users of Microchip products:

- Distributor or Representative
- Local Sales Office
- Field Application Engineer (FAE)
- Technical Support
- Development Systems Information Line

Customers should contact their distributor, representative or FAE for support. Local sales offices are also available to help customers. A list of sales offices and locations is included in the back of this document.

Technical support is available through the web site <http://support.microchip.com>

DOCUMENT REVISION HISTORY

Revision A (October 2007)

This is the initial release of the PIC32MX Starter Kit User's Guide.

Revision B (October 2007)

Removed confidential status.

Chapter 1. Introducing the PIC32MX Starter Kit

1.1 INTRODUCTION

Thank you for purchasing the Microchip Technology PIC32MX Starter Kit. This kit provides a low-cost, modular development system for Microchip's new line of 32-bit microcontrollers.

The Starter Kit comes pre-loaded with demonstration software for the user to explore the new features of the PIC32MX. It is also expandable through a modular expansion interface, which allows the user to extend its functionality. The PIC32MX Starter Kit also supplies on-board circuitry for full debug and programming capabilities.

1.2 HIGHLIGHTS

This chapter covers the following topics:

- Kit Contents
- PIC32MX Functionality and Features
- Using the PIC32MX Starter Kit Out of the Box
- PIC32MX Demonstration Program

The preprogrammed example code on the PIC32MX MCU has been included on the PIC32MX Starter Kit CD-ROM for future reference. All project files have been included, so that the code may be used directly to restore the PIC32MX MCU on the Starter Kit to its original state (i.e., if the sample device has been reprogrammed with another program), or so you can use the tutorial code as a platform for further experimentation.

1.3 KIT CONTENTS

The PIC32MX Starter Kit contains the following items:

- PIC32MX Starter Kit Board
- USB MINI-B cable
- PIC32 Starter Kit Installation CD-ROM, containing:
 - User's Guide
 - Data Sheet for the PIC32MX family
 - PIC32MX Family Reference Manual
 - PIC32MX Peripheral Library Manual
 - Schematics and PCB drawing files
 - Code examples for use with the PIC32MX devices

If you are missing any part of the kit, contact a Microchip sales office for assistance (refer to the list on the last page of this manual).

PIC32MX Starter Kit User's Guide

1.4 PIC32MX FUNCTIONALITY AND FEATURES

A representation of the layout of the PIC32MX Starter Kit is shown in Figure 1-1. The board includes these key features, as indicated in the diagram:

1. PIC32MX360F512L 32-bit microcontroller
2. Green power-indicator LED
3. Regulated +3.3V power supply for powering the Starter Kit board via USB or expansion board
4. On-board crystal for precision microcontroller clocking (8 MHz)
5. USB connectivity for on-board debugger communications
6. PIC18LF4550 USB microcontroller for on-board debugging
7. Orange Debug indicator LED
8. Three push-button switches for user-defined inputs
9. Three user-defined indicator LEDs
10. Connector for connecting various expansion boards (on the underside of board)

For additional details on these features, refer to **Chapter 4. "PIC32MX Starter Kit Hardware"**.

FIGURE 1-1: PIC32MX STARTER KIT DEMO BOARD LAYOUT

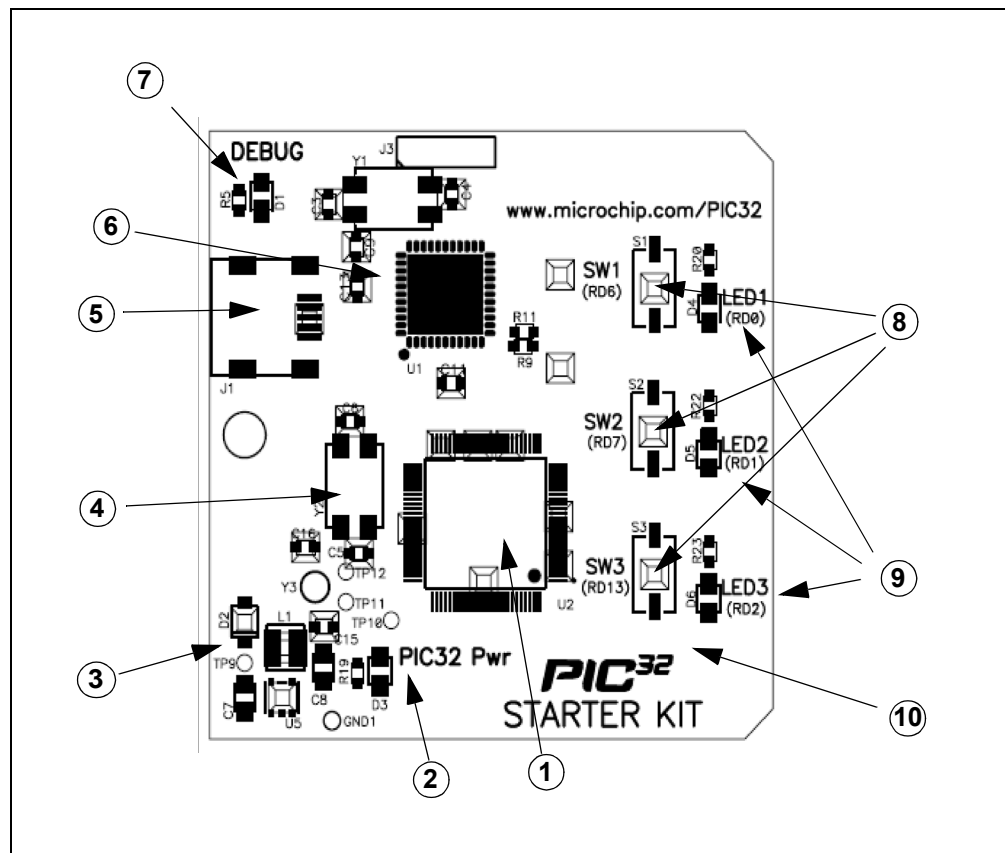

1.5 USING THE PIC32MX STARTER KIT OUT OF THE BOX

The PIC32MX Starter Kit may be used directly from the box as a demonstration board for the PIC32MX device. The PIC32MX is preprogrammed with the classic “Simon Says” game in the PIC32MX360F512L device (i.e., `simon_says_demo.hex`) and is ready for immediate use.

1.5.1 How to Play the Game

When the USB cable is plugged into the Starter Kit, the three LEDs start blinking to indicate the start of a new game. Begin the game by pressing one of the switches to choose the level of game difficulty, SW1-SW3 (SW3 is the easiest, SW1 is the hardest). The goal is to imitate the light patterns as long as you can, without getting frazzled. Ultimately, you will make a mistake and all of the LEDs will light up to signal the end of a game. After a brief pause, you can press a switch again to start a new game.

If the Starter Kit is connected to the MPLAB IDE, the game stops. It will be replaced by the MPLAB IDE project that you select when the program button is pressed. The Simon game can be reloaded onto the Starter kit by opening the `simon_says_demo.mcw` file from the `c:\Program Files\Microchip\pic32_solutions\simon_says_demo` directory.

1.6 INSTALLING THE PIC32MX STARTER KIT CD

The Starter Kit CD-ROM contains the MPLAB IDE, MPLAB C32 C Compiler tools, code examples, sample projects, technical documentation, a getting started tutorial and this *PIC32MX Starter Kit User's Guide*. When the CD is placed into your CD drive, an automatic installation application will guide you to install the tools and necessary documents.

1.7 PIC32MX DEMONSTRATION PROGRAM

The preprogrammed example code on the PIC32MX has been included on the PIC32MX Starter Kit CD-ROM for future reference. All project files have been included, so that the code may be used directly to restore a PIC32MX to its original state (i.e., if the sample device has been reprogrammed with another program), or so you can use the tutorial code as a platform for further experimentation.

PIC32MX Starter Kit User's Guide

NOTES:

Chapter 2. PIC32MX Starter Kit Tutorial

2.1 INTRODUCTION

This chapter is a self-paced tutorial to get you started using the PIC32MX Starter Kit.

2.2 HIGHLIGHTS

Items discussed in this chapter include:

- Host Computer Requirements
- Installing the Starter Kit Board
- Starting with the Tutorial Project
- Building the Project
- Programming the Device
- Running the Program
- Operation of the Tutorial Program

2.3 HOST COMPUTER REQUIREMENTS

To communicate with and program the Starter Kit board, the following hardware and software requirements must be met:

- PC-compatible system
- An available USB port on PC or powered USB hub
- CD-ROM drive
- Windows XP®

(The PIC32MX Starter Kit has not been tested on Microsoft® Windows NT®, Windows 2000® or Microsoft Vista™ operating systems)

PIC32MX Starter Kit User's Guide

2.4 INSTALLING THE STARTER KIT BOARD

As a USB device, the Starter Kit board requires very little effort to install; most of the work is done by the operating system. Begin by closing all applications.

2.4.1 Install the Tools and Projects

1. Insert the PIC32 Starter Kit CD into your CD-ROM drive and click the install from CD menu option. If the installation application does not automatically start, navigate to the files on the CD and open `setup.exe`.

The following window is displayed:

FIGURE 2-1: INSTALLING THE PIC32 STARTER KIT BOARD

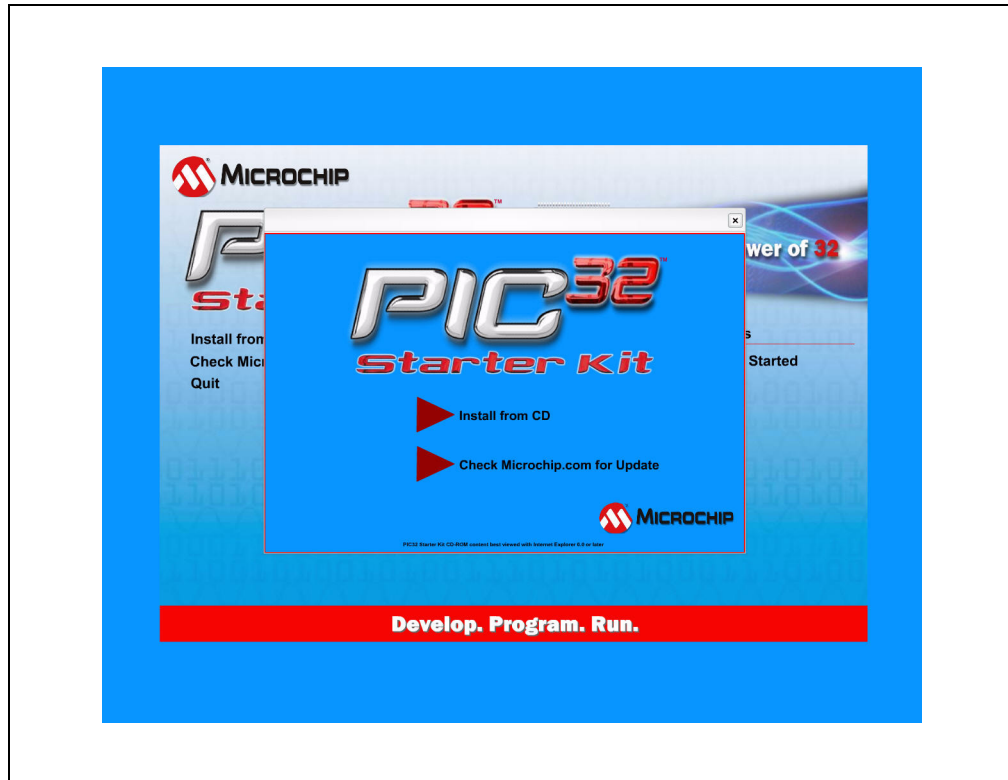

2. Reboot your system when prompted to do so.

Note: The dialog also provides an option to check the Microchip web site for newer versions of the Starter Kit software.

2.4.2 View the Getting Started Tutorial

Perform the following steps to view the tutorial:

1. After your computer has rebooted, the Getting Started Tutorial menu opens.
2. View the tutorial instructions for connecting to the Starter Kit board and running the tutorial project.

If you performed the installation steps as you followed along in the Getting Started tutorial, skip to **Section 2.5 “Starting the Tutorial Project”** on page 14.

If you did not, continue to the next page for instructions about how to connect the board and install the device driver.

2.4.3 Connect the Starter Kit Board

Using the supplied USB cable, connect the board to an open USB port on your computer. (A USB hub that is *not bus-powered* can also be used.) Connect the other end of the cable into the USB connector on the Starter Kit board.

Check the board: the green power LED D3 should be lit. If it is not, check the connections at the port, hub, and board.

2.4.4 Install the USB Device Driver

Note: The USB driver installation steps described here refer specifically to installing the driver on a Microsoft Windows XP operating system.

Perform the following steps to install the USB device driver:

1. When the USB cable is connected, the “Found New Hardware Wizard” dialog box opens, as shown in Figure 2-2. When asked whether to install the software automatically or install from a list or specific location, select “Install software automatically” and click **Next**.

FIGURE 2-2: FOUND NEW HARDWARE WIZARD

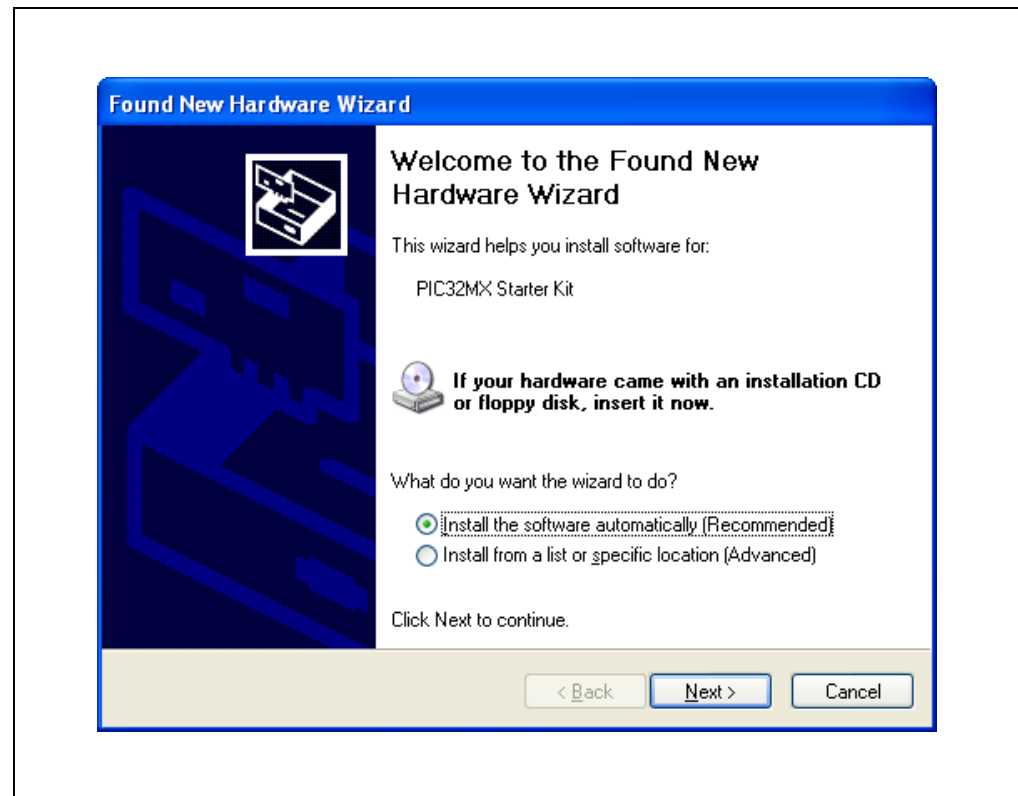

PIC32MX Starter Kit User's Guide

- As shown in Figure 2-3, the next dialog box tracks the wizard as it searches for the device. (This activity may take several seconds.) When it is done, click **Next**.

FIGURE 2-3: HARDWARE WIZARD

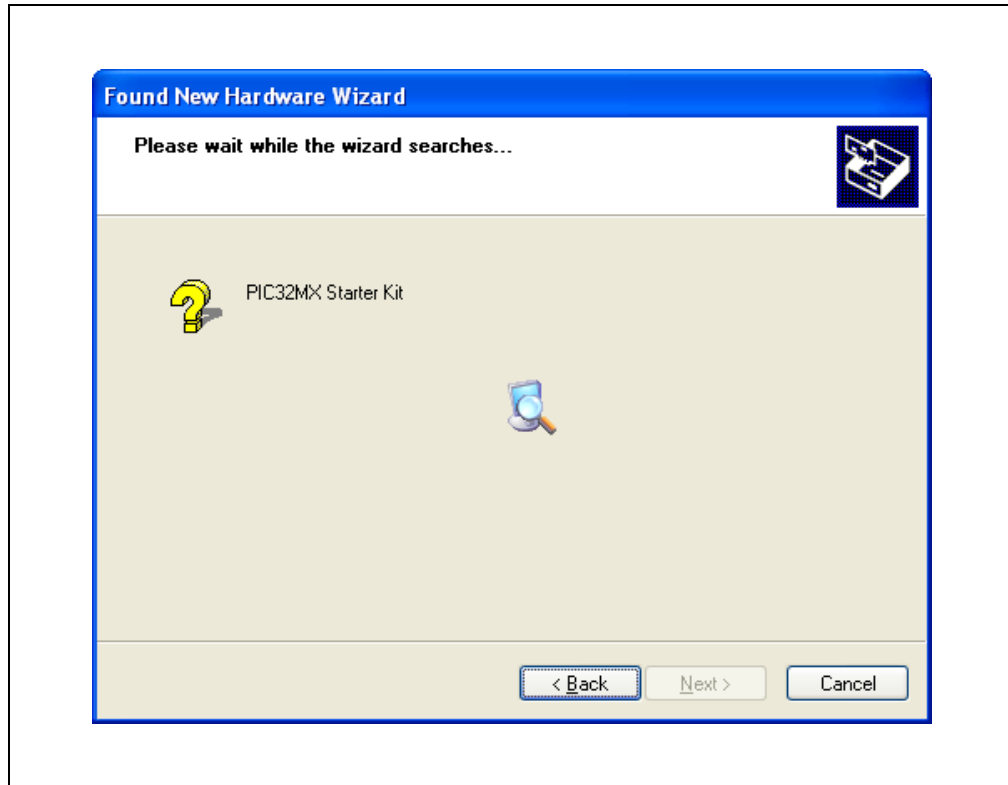

- When the wizard finds the driver, a dialog box regarding Windows Logo testing opens, as shown in Figure 2-4. Click **Continue Anyway**.

FIGURE 2-4: WINDOWS LOGO TESTING

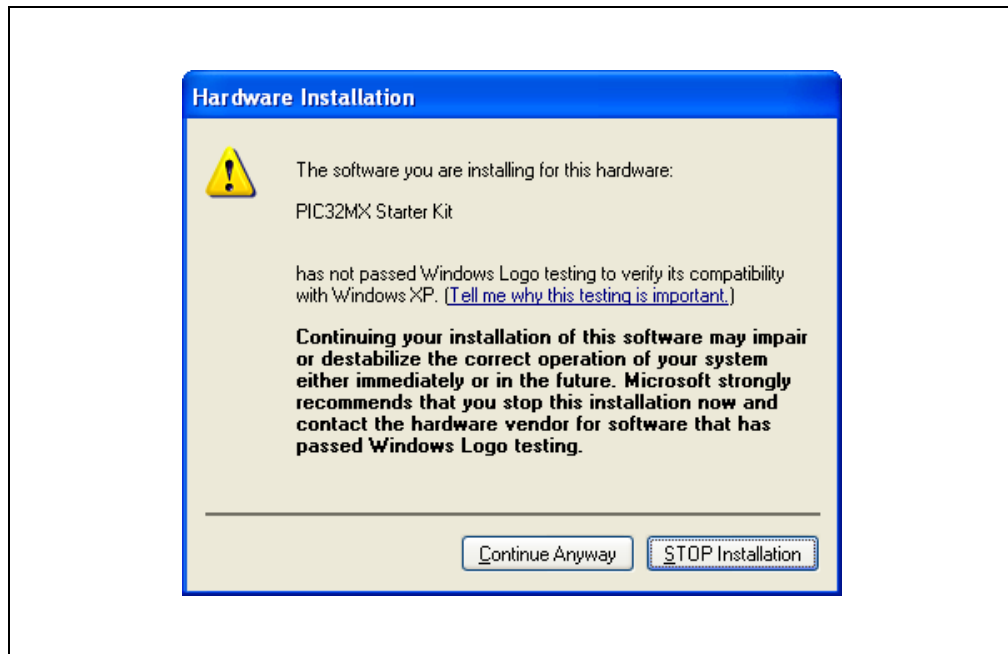

4. The next window (Figure 2-5) indicates that the installation of the software for the Starter Kit is complete. Click **Finish**.

FIGURE 2-5: COMPLETING DEVICE DRIVER INSTALLATION

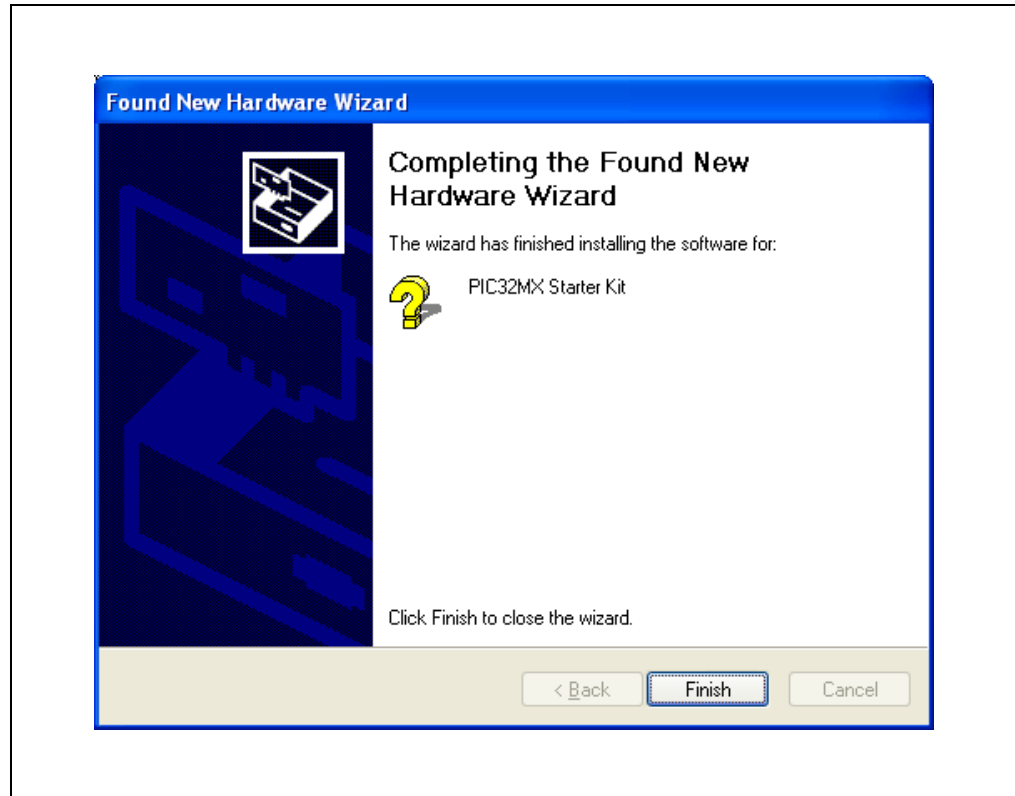

PIC32MX Starter Kit User's Guide

2.5 STARTING THE TUTORIAL PROJECT

Click the MPLAB IDE icon on your computer desktop. The MPLAB IDE opens with the Starter Kit Tutorial project loaded, as shown in Figure 2-6. If the MPLAB IDE does not have the Starter Kit tutorial project loaded, select *File>Open Workspace...* from the menu bar and browse to the tutorial project file: `c:\Program Files\Microchip\pic32_solutions\PIC32MX_Starter_Kit\sample_code\StarterKitTutorial\StarterKitTutorial.mcw` (or browse to file path you used when you installed the MPLAB IDE).

The pane on the left of the MPLAB IDE interface displays project files, the '.c', '.h' and '.lib' files that are used to build an application. The project files are organized by type into folders.

"Starter Kit Found" should be displayed in the "Output" pane of the MPLAB IDE interface. If you do not see this message, select *Debugger>Select Tool>PIC32MX Starter Kit* from the menu bar. If that sequence fails to find the project, check the driver installation, as well as the connections between the hardware and the PC.

FIGURE 2-6: MPLAB® IDE WORKSPACE

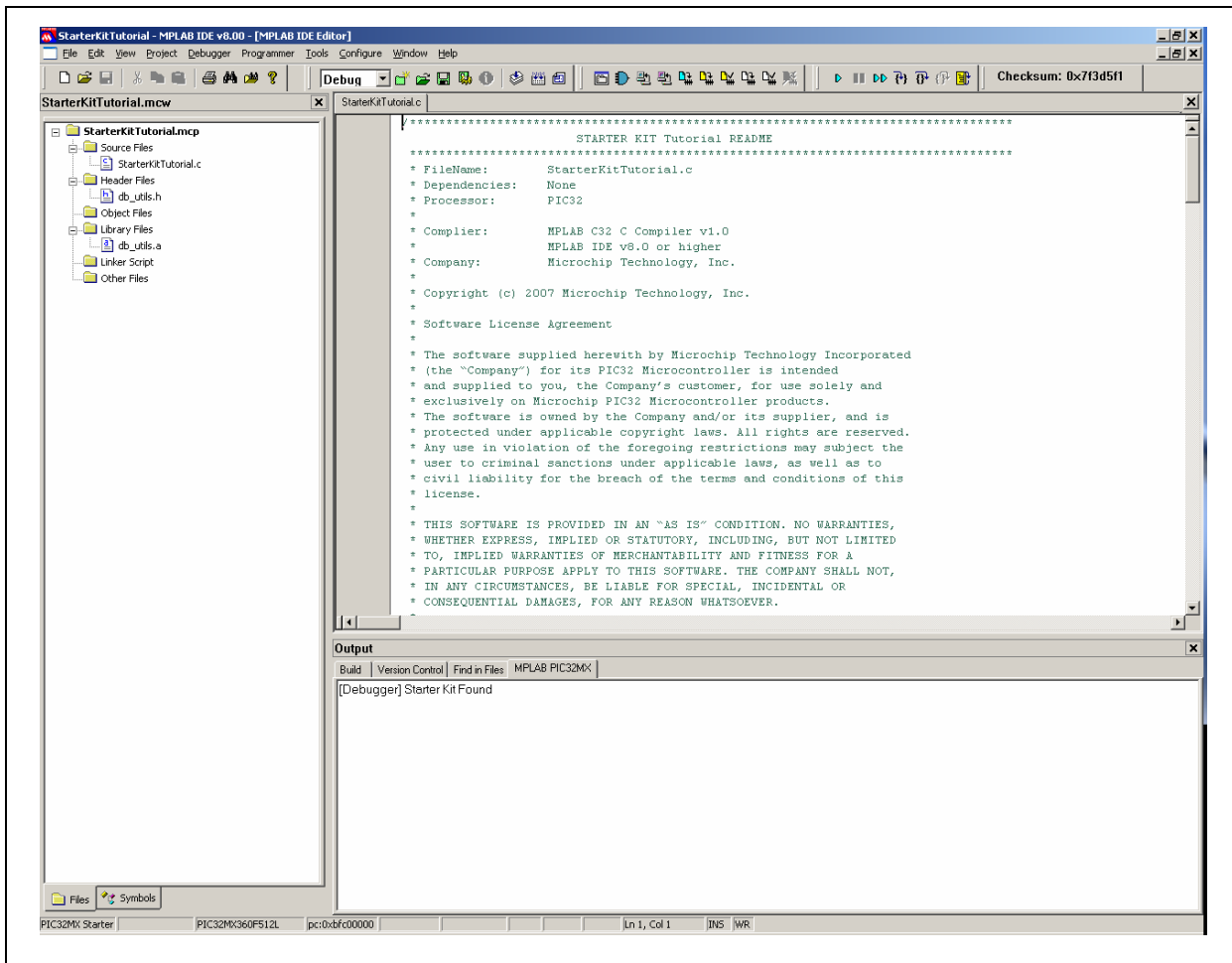

2.6 BUILDING THE PROJECT

From the menu bar of the main MPLAB IDE window, click *Project>Make*. The build Output window displays, as shown in Figure 2-7.

Observe the progress of the build. When the “BUILD SUCCEEDED” message displays, you are ready to program the device.

FIGURE 2-7: BUILD OUTPUT WINDOW

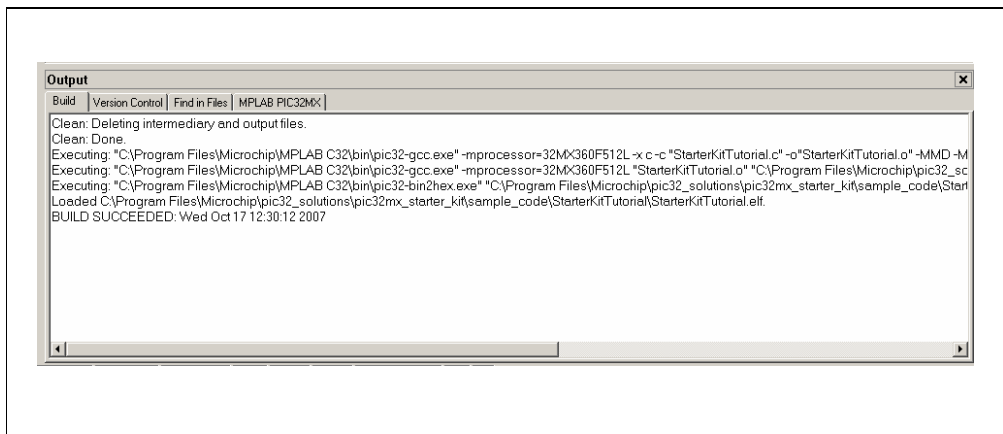

PIC32MX Starter Kit User's Guide

2.7 PROGRAMMING THE DEVICE

2.7.1 Program the Device

Click on the Program All Memories icon on the Program Device Tool Bar, as shown in Figure 2-8).

FIGURE 2-8: PROGRAM DEVICE TOOL BAR

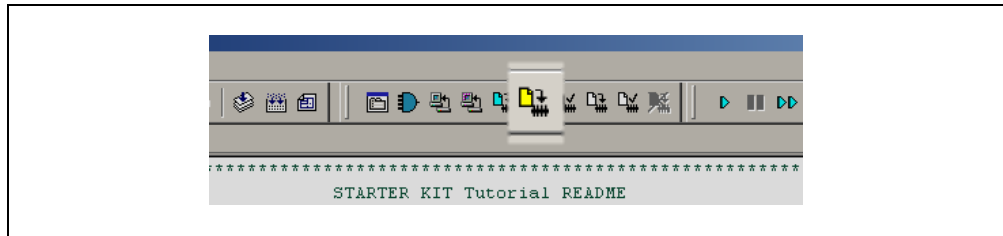

A Programming Warning window (Figure 2-9) opens to warn you about overwriting the memory. Click **Yes**.

FIGURE 2-9: PROGRAMMING WARNING WINDOW

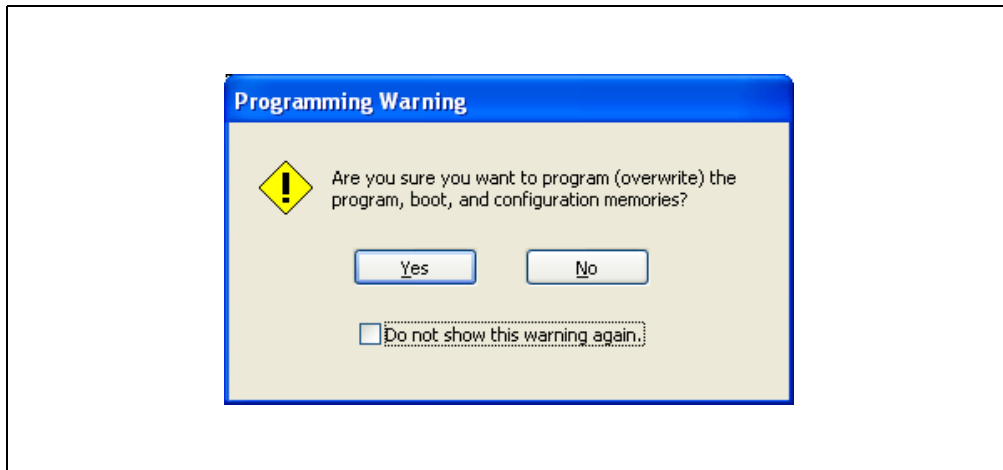

The Output window (Figure 2-10) tracks the progress of the output. A "Done" entry indicates that the programming of the device is complete.

FIGURE 2-10: OUTPUT WINDOW

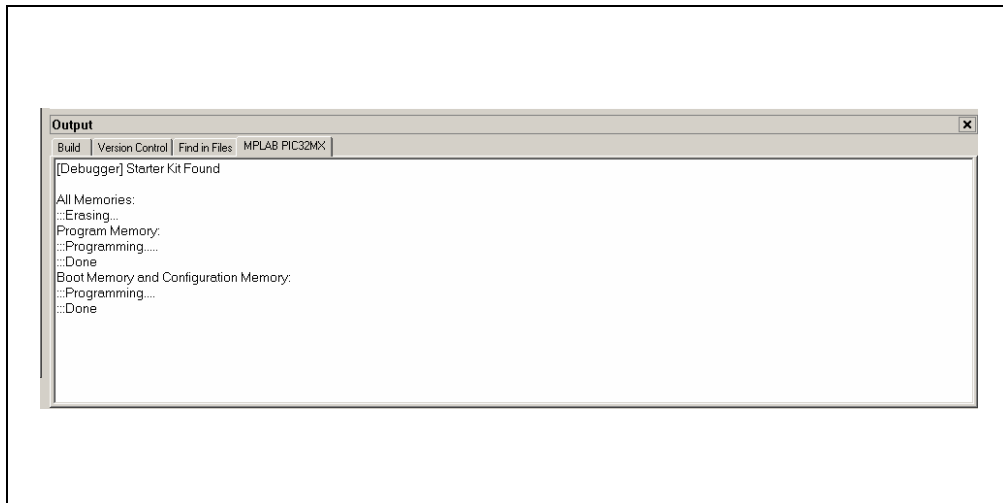

2.8 RUNNING THE PROGRAM

Either click *Debugger>Run* from the menu bar of the MPLAB IDE or click the Run icon (the turquoise triangle) on the Debug Tool Bar (Figure 2-11) to run the new program.

FIGURE 2-11: DEBUG WINDOW

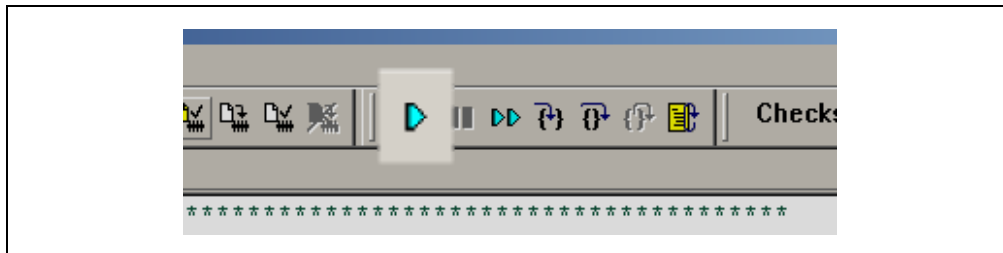

2.9 TUTORIAL PROGRAM OPERATION

The Starter Kit tutorial demonstrates a simple application. The program responds according to the user input menu. The program prints the available menu choices to the Starter Kit Output window in the MPLAB IDE. The program flow is shown in Figure 2-12.

PIC32MX Starter Kit User's Guide

FIGURE 2-12: PIC32MX TUTORIAL PROGRAM FLOWCHART

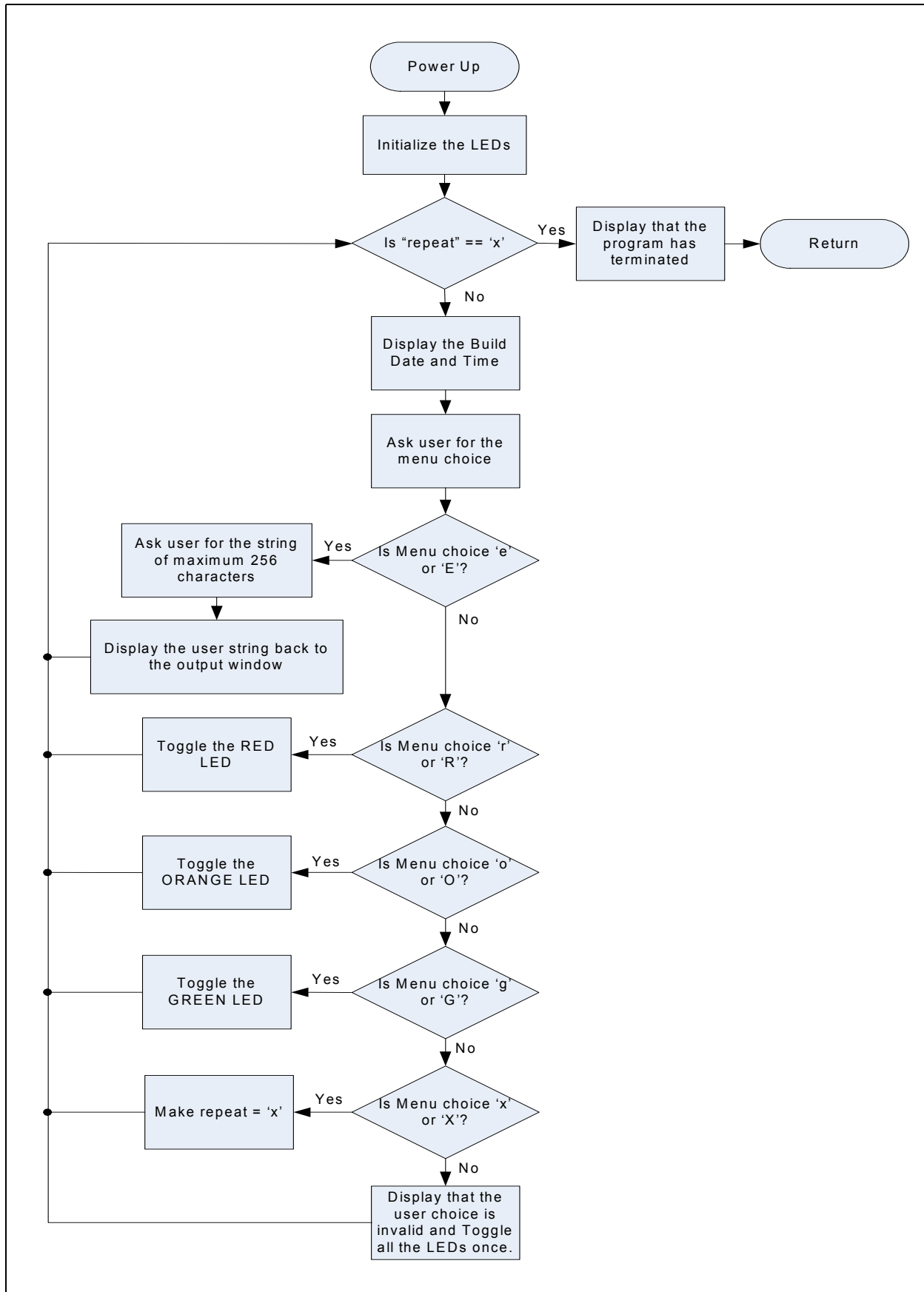

The tutorial program includes the Debug Print Library, which facilitates print functionality. A peripheral library header file for flashing the LEDs is also included. The header file for print functionality is `db_utils.h`.

Depending on the macro definition given in the print header file, the debug print macros will be expanded. The print functionality in the tutorial is routed to the Output window on the **MPLAB PIC32MX** tab in the interface window. In order to achieve this, the macro definition "PIC32_STARTER_KIT" is added to the C32 compiler options.

As the program runs, the Output window (Figure 2-13) tracks the progress.

FIGURE 2-13: OUTPUT WINDOW

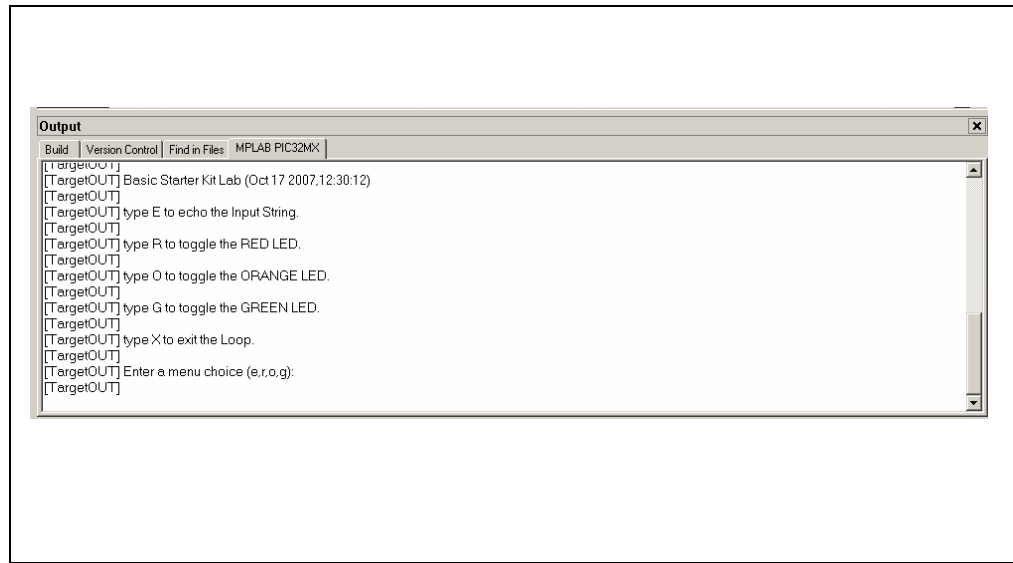

After printing the menu, the application displays a prompt that requests your input, see Figure 2-14.

FIGURE 2-14: TARGET IN WINDOW

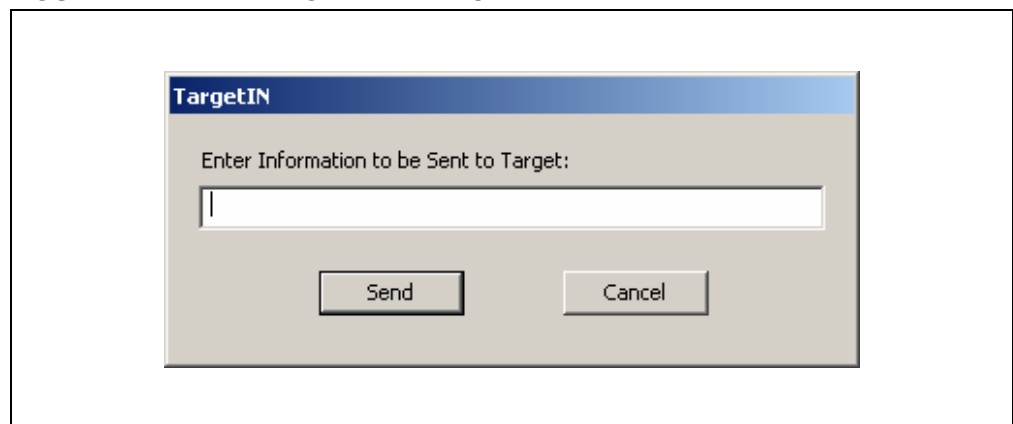

Type your choice into the Enter Information to be Returned box, and click **Send**.

The program responds according to the menu entry. Watch the LEDs on the Starter Kit board. If your entry is incorrect, the LEDs will toggle once.

PIC32MX Starter Kit User's Guide

NOTES:

Chapter 3. Create a New Project

3.1 INTRODUCTION

This chapter explains how to create a new project.

3.2 HIGHLIGHTS

Items discussed in this chapter include:

- Creating a New Project
- Building the Project
- Programming the Device
- Running the Program

After completing this chapter, you should be able to accomplish the following tasks:

- Create a project using the Project Wizard
- Assemble and link the code, and set the Configuration bits
- Set up the MPLAB IDE to use the PIC32MX Starter Kit
- Program the chip, and run the program

3.3 CREATING A NEW PROJECT

The first step is to create a project and a workspace in the MPLAB IDE. Typically, there is a single project per workspace.

A project contains the files needed to build an application (i.e., source code, header files, library, etc.), and their corresponding build options.

A workspace contains one or more projects, information on the selected device, debug/programmer tool, and MPLAB IDE configuration settings.

MPLAB IDE contains a Project Wizard to help create a new project. It is important, before you start the tasks, to create a folder named “MyProject” as the intended location for the project files (C:\MyProject is assumed in the following instructions).

You will perform the following tasks as you create a new project:

Task 1, Select a Device on page 22.

Task 2, Select the Language Toolsuite on page 23.

Task 3, Name Your Project on page 24.

Task 4, Add Files to Your Project on page 25.

Task 5, Confirm the Configuration Settings on page 27.

Task 6, Build the Project on page 28.

Task 7, Program the Device on page 29.

Task 8, Run the Program on page 30.

PIC32MX Starter Kit User's Guide

3.3.1 Task 1, Select a Device

- 1.1. Start MPLAB IDE.
- 1.2. Click *File>Close Workspace* on the menu bar, to close any workspace that is open.
- 1.3. Click *Project>Project Wizard...* to start the wizard.
- 1.4. In the Welcome window, click **Next**.

The Project Wizard Step One: window is displayed, as shown in Figure 3-1.

FIGURE 3-1: SELECTING THE DEVICE

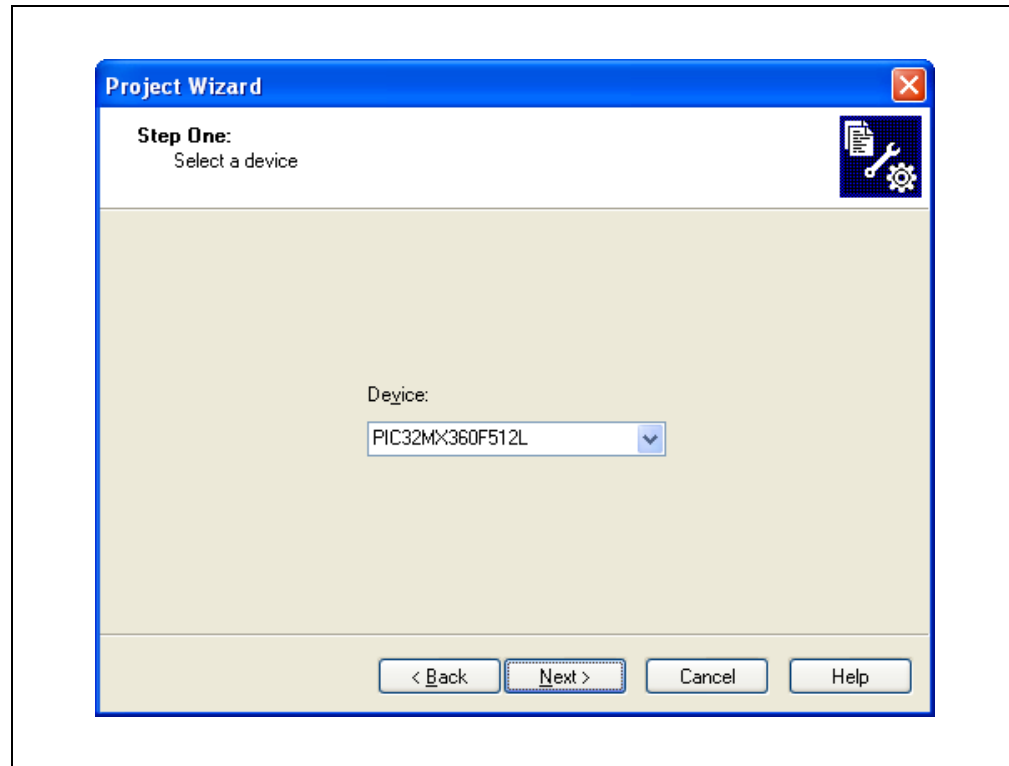

- 1.5. From the "Device" drop-down list, select "PIC32MX360F512L".
- 1.6. Click **Next**.
The Project Wizard Step Two: dialog box opens, as shown in Figure 3-2.

FIGURE 3-2: SELECTING THE TOOLSUITE

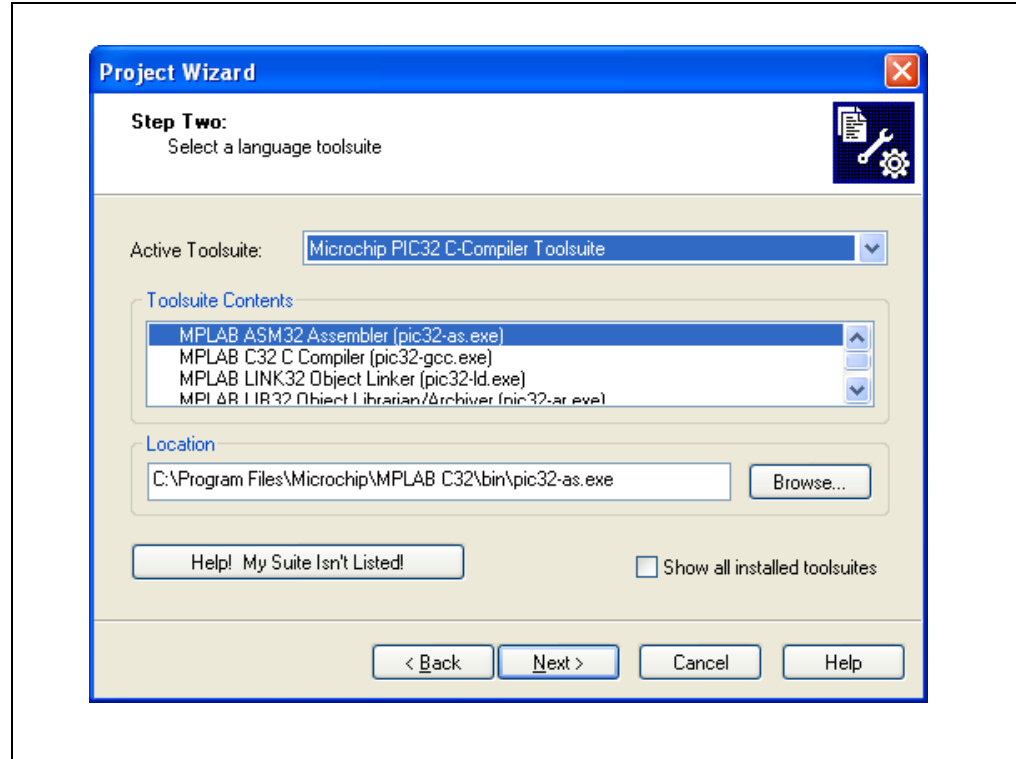

3.3.2 Task 2, Select the Language Toolsuite

- 2.1. From the “Active Toolsuite” drop-down list, click “Microchip PIC32 C Compiler Toolsuite”. The toolsuite includes the assembler and linker that will be used. If the PIC32 compiler option is not available, check the “show all installed toolsuits” box.
- 2.2. In the “Toolsuite Contents” box, select “MPLAB C32 C Compiler (pic32-gcc.exe)”.
- 2.3. In the “Location” box, click **Browse...** and navigate to: “c:\Program Files\Microchip\MPLAB C32\bin\pic32-as.exe”.
- 2.4. With “MPLAB 32 LINK Object Linker (pic30-ld.exe)” selected in the “Toolsuite Contents” box, click **Browse...** and navigate to: “c:\Program Files\Microchip\MPLAB C32\bin\pic32-ld.exe”.
- 2.5. Click **Next** to continue.
The Project Wizard Step Three: dialog opens, as shown in Figure 3-3.

FIGURE 3-3: NAMING YOUR PROJECT

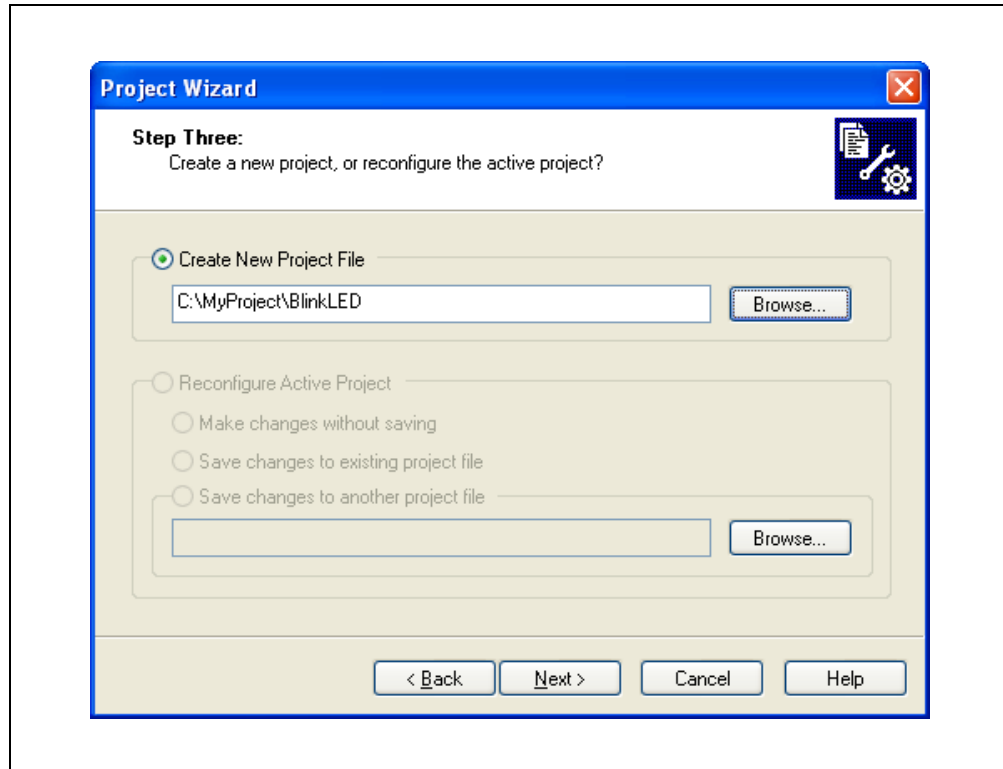

3.3.3 Task 3, Name Your Project

- 3.1. In the “Create New Project File” field, click **Browse...** and navigate to “C:\MyProject\BlinkLED” to place your project in the `MyProject` folder that you created before starting these instructions.
- 3.2. Click **Next** to continue.
The Project Wizard Step Four: dialog opens, as shown in Figure 3-4.

FIGURE 3-4: ADDING FILES TO THE PROJECT

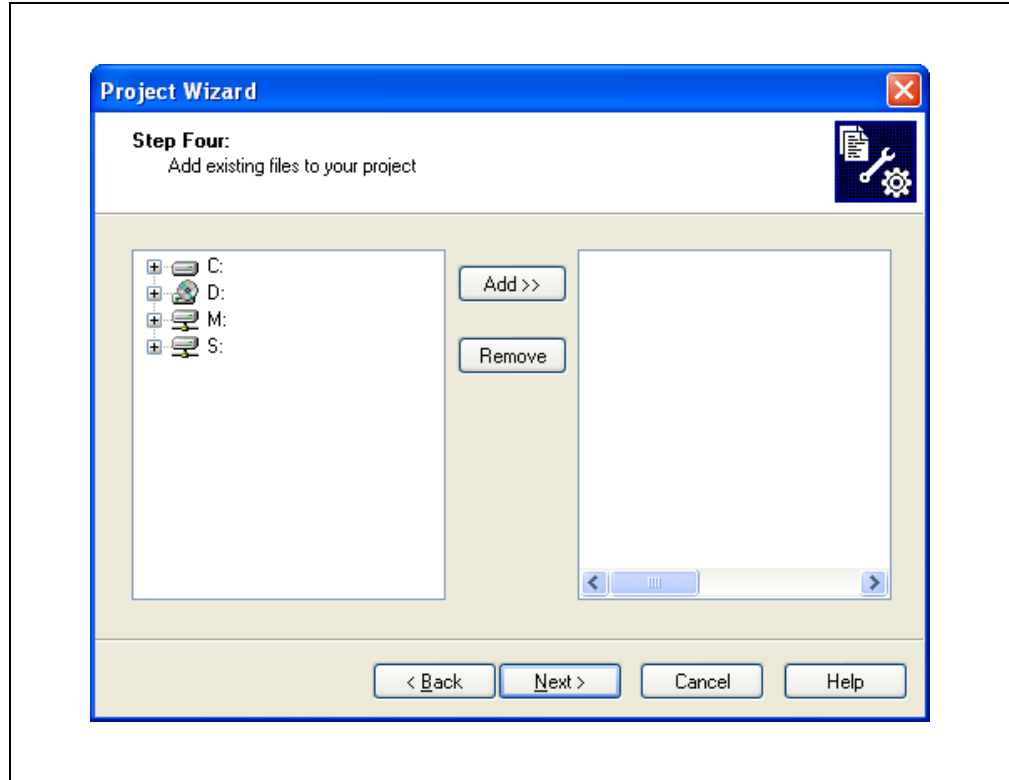

3.3.4 Task 4, Add Files to Your Project

This window can be skipped, since no '.c' files have been created.

- 4.1. Click **Next** to continue.
- 4.2. Click **Finish** on the summary screen.
A project and workspace have been created in the MPLAB IDE.
`BlinkLED.mcw` is the workspace file and `BlinkLED.mcp` is the project file.
- 4.3. Click **File>New** from the menu bar to create a new file.
You can see a new empty file.
- 4.4. Click **File>Save As...** and save this file as 'blinkLED.c' in the same folder (in this case, the `C:\MyProject` folder).
- 4.5. Now copy the source code provided in Example 3-1 to the `blinkLED.c` file.

PIC32MX Starter Kit User's Guide

EXAMPLE 3-1: PROJECT SOURCE CODE

```
#include <plib.h>          /* PIC32 peripheral library */
int main(void)
{
    int i;
    /* setup LED */
    mPORTDClearBits(BIT_0); /* Turn off LED0 on startup */
    mPORTDSetPinsDigitalOut(BIT_0); /* Make RD0 (LED0) as output */
    mPORTDClearBits(BIT_1); /* Turn off LED1 on startup */
    mPORTDSetPinsDigitalOut(BIT_1); /* Make RD0 (LED1) as output */
    mPORTDClearBits(BIT_2); /* Turn off LED2 on startup */
    mPORTDSetPinsDigitalOut(BIT_2); /* Make RD0 (LED2) as output */
    while(1) // go for ever
    {
        for(i=0; i<200000; i++); // put a delay
        mPORTDToggleBits(BIT_0); /* turn ON LED0 */
        for(i=0; i<200000; i++); // put a delay
        mPORTDToggleBits(BIT_1); /* turn ON LED1 */
        for(i=0; i<200000; i++); // put a delay
        mPORTDToggleBits(BIT_2); /* turn ON LED2 */
    };
    return 0;
}
```

- 4.6. In the Project window, add the `blinkLED.c` file to the source directory, as shown in Figure 3-5.

FIGURE 3-5: ADDING SOURCE FILES

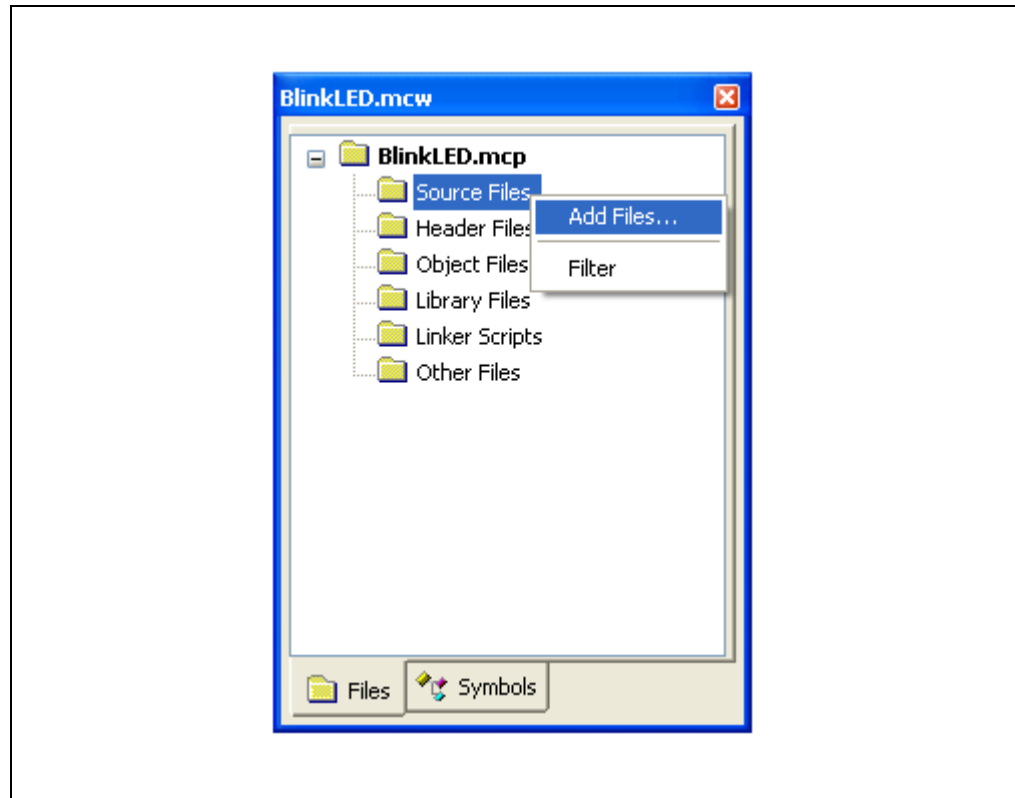

- 4.7. Click *Debugger>Select Tool>PIC32MX Starter Kit* from the menu bar, for the Target board.

Note: Make sure that the Starter Kit demo board is connected to your PC.

3.3.5 Task 5, Confirm the Configuration Settings

- 5.1. Click *Configure>Configuration Bits* to confirm that the configuration settings are correct.

Typical configuration settings for the Starter Kit are shown in Figure 3-6.

Note: The Configuration settings can also be embedded in the source file. See the MPLAB C32 C Compiler User's Guide for more information.

PIC32MX Starter Kit User's Guide

FIGURE 3-6: CONFIGURATION BIT SETTINGS

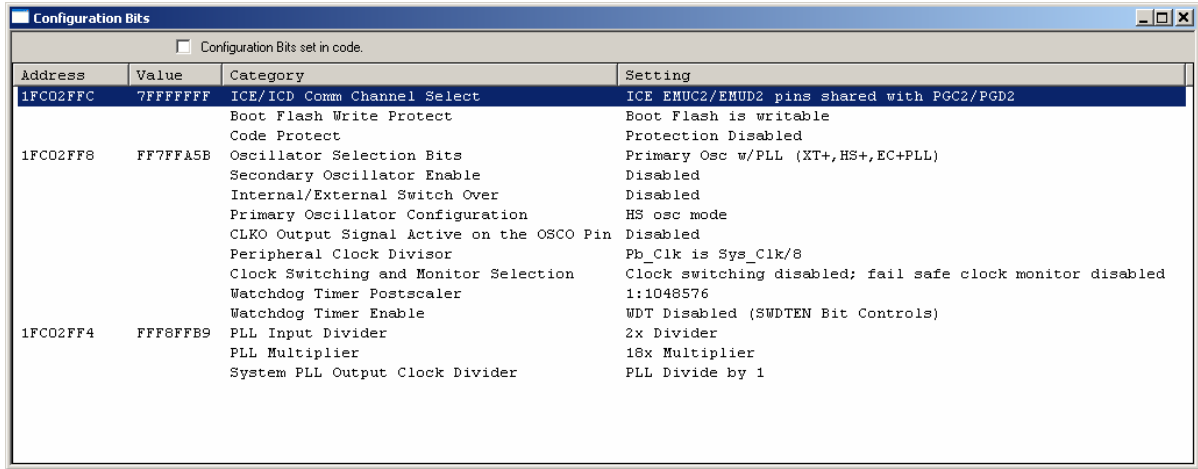

Address	Value	Category	Setting
1FC02FFC	7FFFFFFF	ICE/ICD Comm Channel Select	ICE EHUC2/EMUD2 pins shared with PGC2/PGD2
		Boot Flash Write Protect	Boot Flash is writable
		Code Protect	Protection Disabled
1FC02FF8	FF7FFA5B	Oscillator Selection Bits	Primary Osc w/PLL (XT+,HS+,EC+PLL)
		Secondary Oscillator Enable	Disabled
		Internal/External Switch Over	Disabled
		Primary Oscillator Configuration	HS osc mode
		CLKO Output Signal Active on the OSCO Pin	Disabled
		Peripheral Clock Divisor	Pb_Clk is Sys_Clk/8
		Clock Switching and Monitor Selection	Clock switching disabled; fail safe clock monitor disabled
		Watchdog Timer Postscaler	1:1048576
		Watchdog Timer Enable	WDT Disabled (SWDTEN Bit Controls)
1FC02FF4	FFF8FFB9	PLL Input Divider	2x Divider
		PLL Multiplier	18x Multiplier
		System PLL Output Clock Divider	PLL Divide by 1

Note that the “Configuration Bits set in code” check box is unchecked.

3.3.6 Task 6, Build the Project

- 6.1. Click *Project>Make* from the menu bar of the main MPLAB IDE window. The build Output window displays (Figure 3-7).
- 6.2. Observe the progress of the build. When the “BUILD SUCCEEDED” message displays, you are ready to program the device.

FIGURE 3-7: BUILD OUTPUT WINDOW

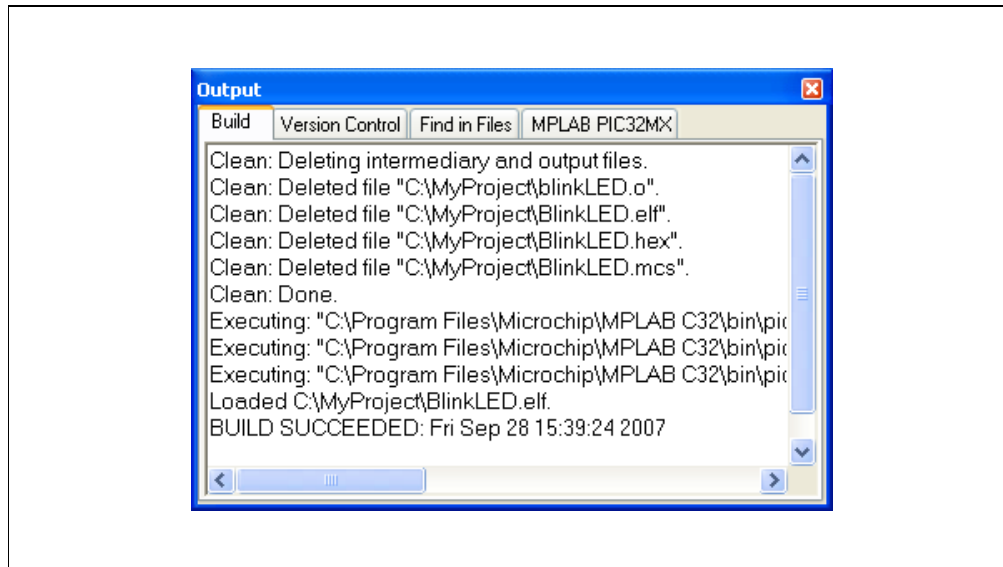

3.3.7 Task 7, Program the Device

- 7.1. Click the Program All Memories icon on the Program Device Tool Bar, as shown in Figure 3-8.

FIGURE 3-8: PROGRAM DEVICE WINDOW

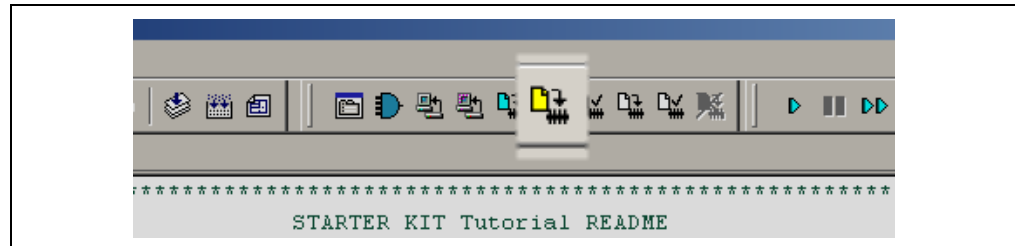

A Programming Warning window (Figure 3-9) opens to warn you about overwriting the memory.

- 7.2. Click **Yes**.

FIGURE 3-9: PROGRAMMING WARNING WINDOW



The Output window (Figure 3-10) tracks the progress of the output. "Done" signals that the programming of the device is complete.

FIGURE 3-10: OUTPUT WINDOW

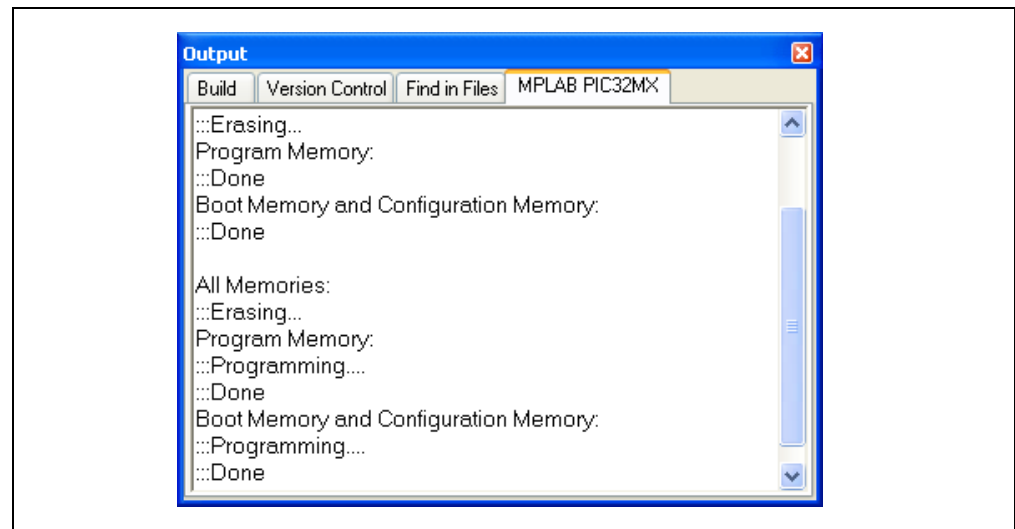

3.3.8 Task 8, Run the Program

- 8.1. Click *Debugger>Run* from the menu bar of the MPLAB IDE or click the Run icon (the turquoise triangle) on the Debug Tool Bar, as indicated in Figure 3-11, to run the new program.

FIGURE 3-11: RUN THE PROGRAM



The Starter Kit LEDs blink to indicate that the program is running successfully.

Chapter 4. PIC32MX Starter Kit Hardware

4.1 INTRODUCTION

This chapter describes the hardware features of the PIC32MX Starter Kit.

4.2 HARDWARE FEATURES

The key features of the PIC32MX Starter Kit are listed below. They are presented in the order given in **Section 1.4 “PIC32MX Functionality and Features”**. You can refer to Figure 1-1 on page 6 for their locations on the board.

4.2.1 Processor Support

The PIC32MX Starter Kit is designed with a permanently mounted (i.e., soldered) PIC32MX360F512L processor.

4.2.2 Power Supply

There are two ways to supply power to the PIC32MX Starter Kit:

- USB bus power connected to J1.
- An external application board with a regulated DC power supply that provides +5V can be connected to the J2 application board connector that is provided on the bottom side of the board.

<p>Note: The basic PIC32MX Starter Kit does not include an application board and is intended to be USB-bus powered.</p>
--

One green LED (D3) is provided to show that the PIC32 microcontroller is powered up.

4.2.3 USB Connectivity

The PIC32MX Starter Kit includes a PIC18LF4550 USB microcontroller, which provides both USB connectivity and support for protocol translation. The PIC18LF4550 is hard-wired to the PIC32MX device to provide two types of connectivity:

- I/O pins of PIC18LF4550 to ICSP™ pins of PIC32MX
- I/O pins of PIC18LF4550 to JTAG pins of PIC32MX

The PIC32MX Starter Kit currently uses the JTAG pins of the PIC32MX device for programming and debugging. At the time of initial release, the PIC18LF4550 is loaded with USB bootloader firmware, which permits easy upgrades of connectivity firmware over the USB connection.

4.2.4 Switches

Push-button switches provide the following functionality:

- SW1: Active-low switch connected to RD6
- SW2: Active-low switch connected to RD7
- SW3: Active-low switch connected to RD13

The switches do not have any debounce circuitry and require the use of internal pull-up resistors; this allows you to investigate debounce techniques. When Idle, the switches are pulled high (+3.3V). When pressed, they are grounded.

4.2.5 LEDs

The LEDs, RD0 through RD2, are connected to PORTD of the processor. The PORTD pins are set high to light the LEDs.

4.2.6 Oscillator Options

The installed microcontroller has an oscillator circuit connected to it. The main oscillator uses an 8 MHz crystal (Y2) and functions as the controller's primary oscillator. Use of an external crystal is not required for PIC32 designs. Your design may use the internal oscillator, if desired.

The PIC18LF4550, at the heart of the USB subsystem, is independently clocked and has its own 8 MHz crystal (Y1).

4.2.7 120-Pin Modular Expansion Connector

The PIC32MX Starter Kit demo board has been designed with a 120-pin modular expansion interface, which allows the board to provide basic generic functionality now, as well as easy extendability to new technologies as they become available.

Appendix A. PIC32MX Starter Kit Schematics

A.1 INTRODUCTION

This section provides detailed technical information about the PIC32MX Starter Kit.

A.2 DEVELOPMENT BOARD BLOCK DIAGRAM

FIGURE A-1: HIGH-LEVEL BLOCK DIAGRAM OF THE PIC32MX STARTER KIT

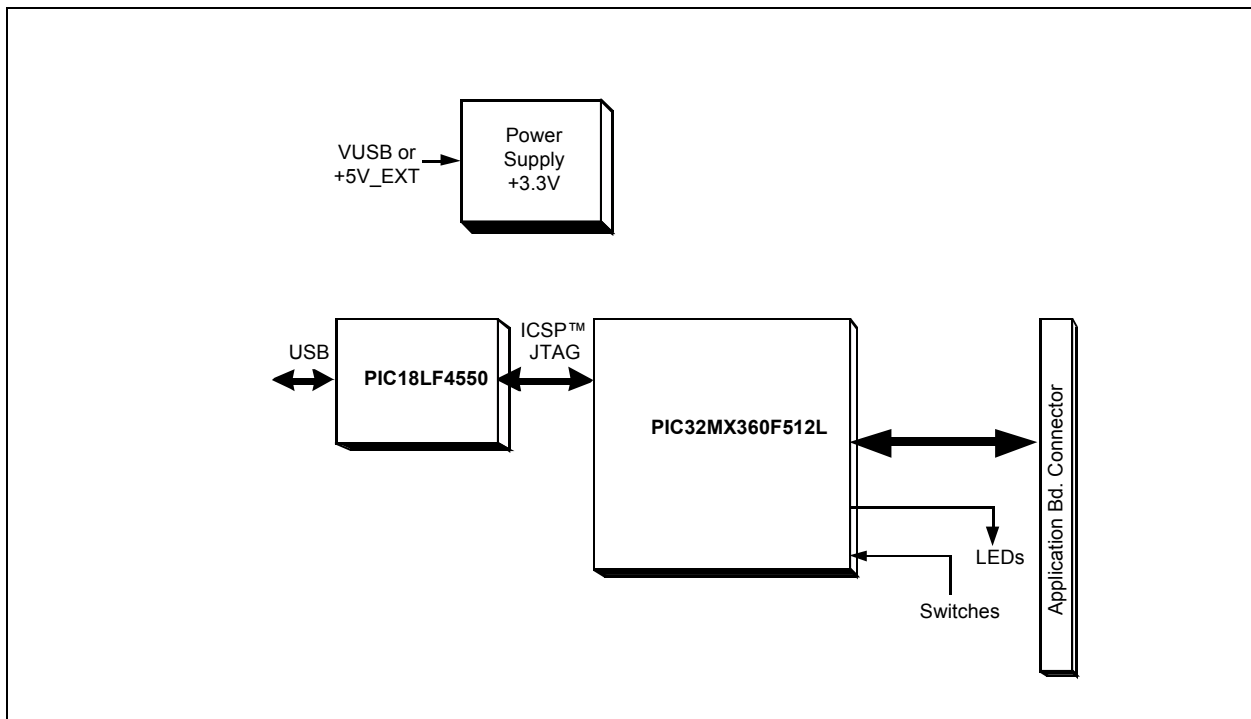

A.3 STARTER KIT BOARD SCHEMATICS

- Figure A-2. PIC32MX CPU
- Figure A-3. PIC18LF4550 Debug CPU
- Figure A-4. Application Board Connector
- Figure A-5. Switches and LEDs
- Figure A-6. Power Supply

PIC32MX Starter Kit User's Guide

FIGURE A-2: PIC32MX SCHEMATIC, SHEET 1 OF 6 (PIC32MX CPU)

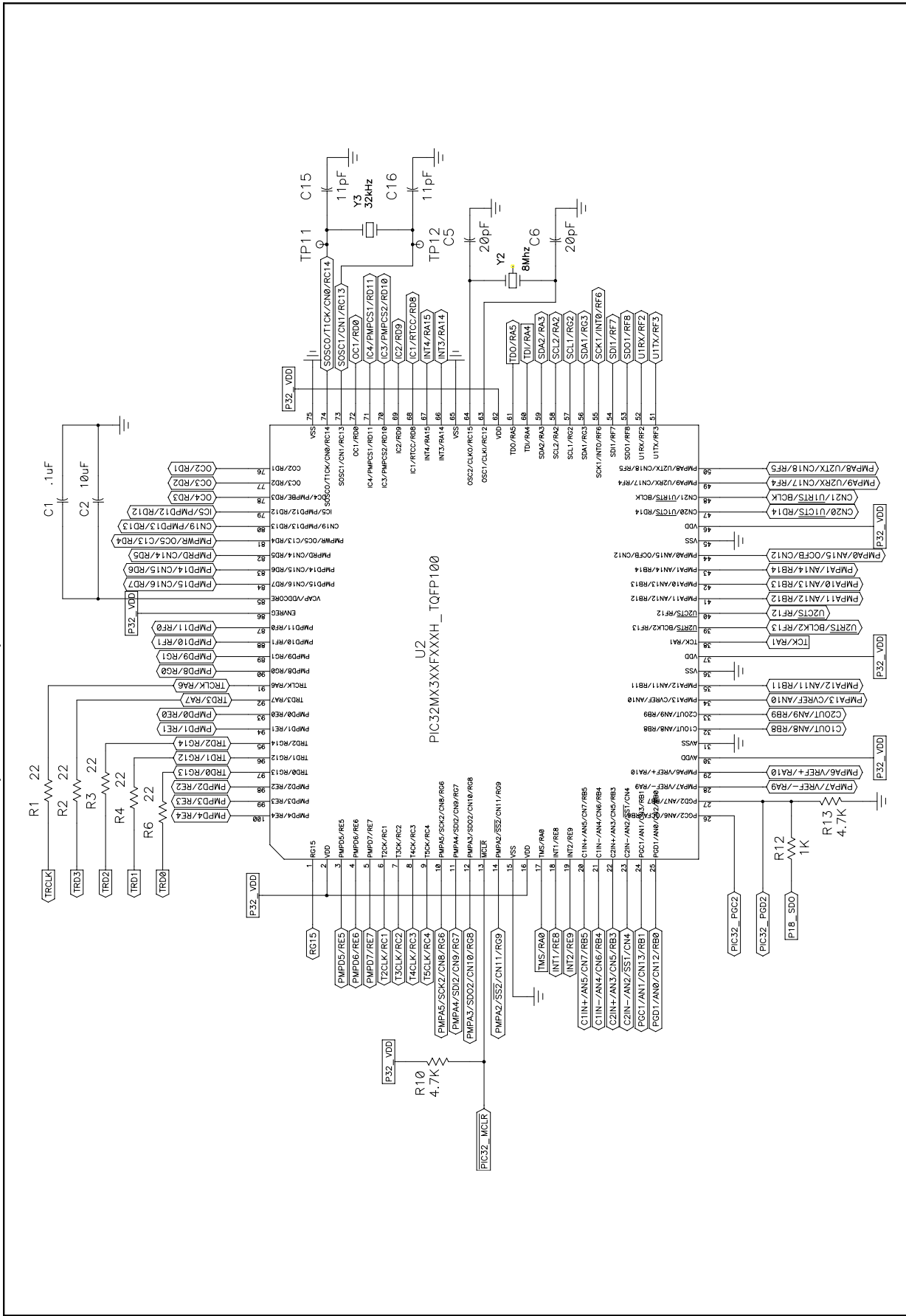
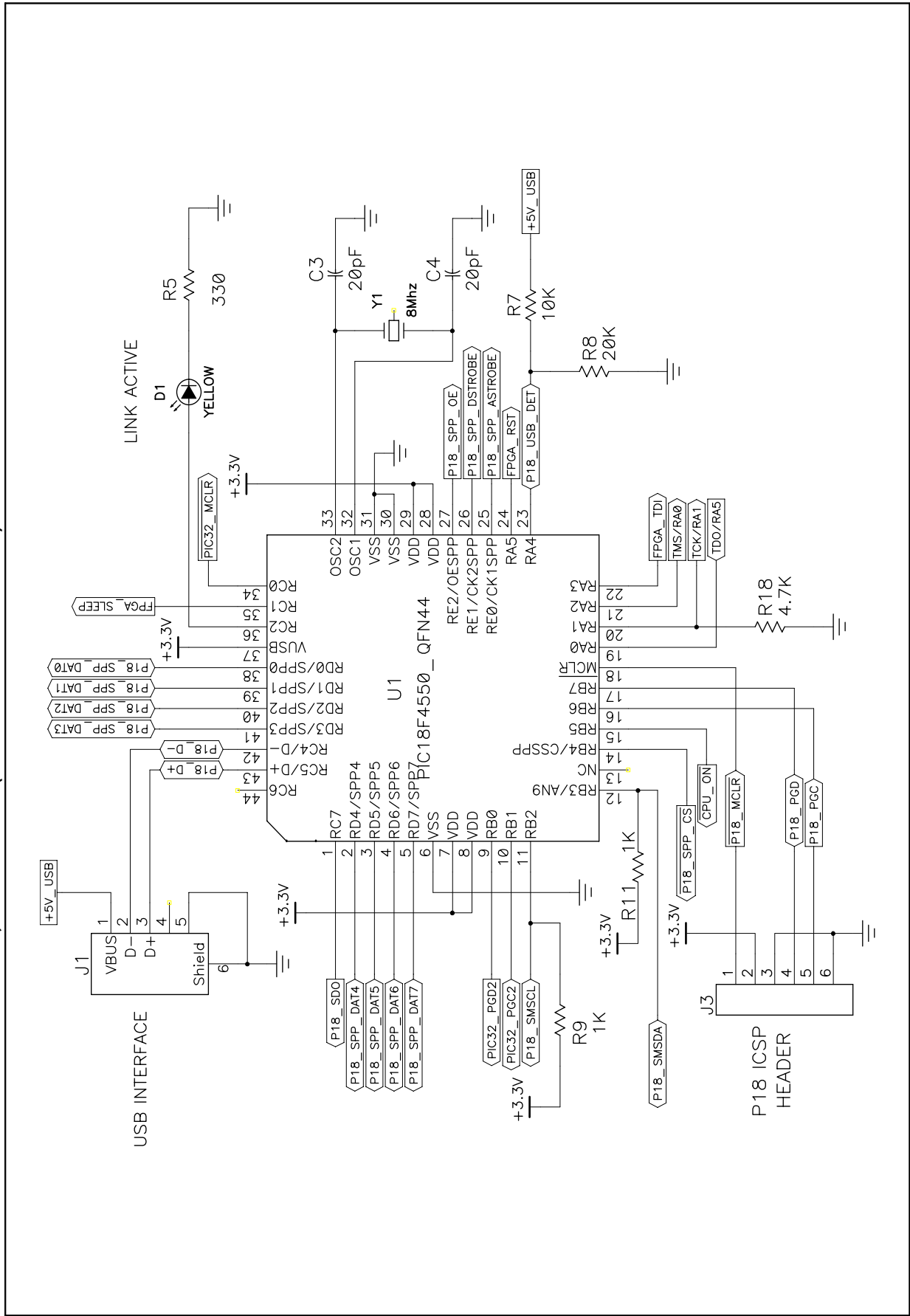
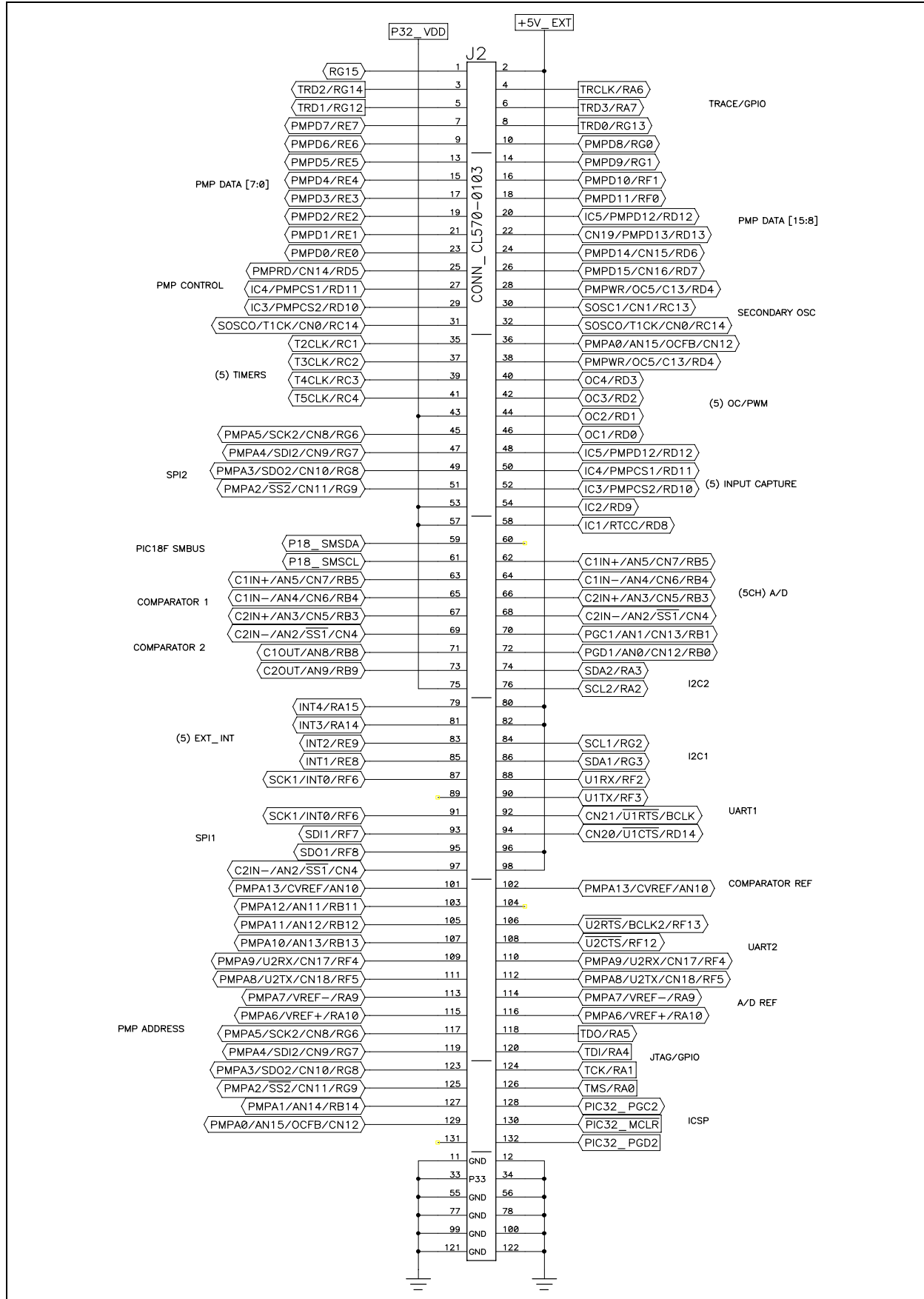

FIGURE A-3: PIC32MX SCHEMATIC, SHEET 2 OF 6 (PIC18LF4550 DEBUG CPU)



PIC32MX Starter Kit User's Guide

FIGURE A-4: PIC32MX SCHEMATIC, SHEET 3 OF 6 (APPLICATION BOARD CONNECTOR)



Appendix A. "PIC32MX Schematics"

FIGURE A-5: PIC32MX SCHEMATIC, SHEET 5 OF 6 (SWITCHES AND LEDES)

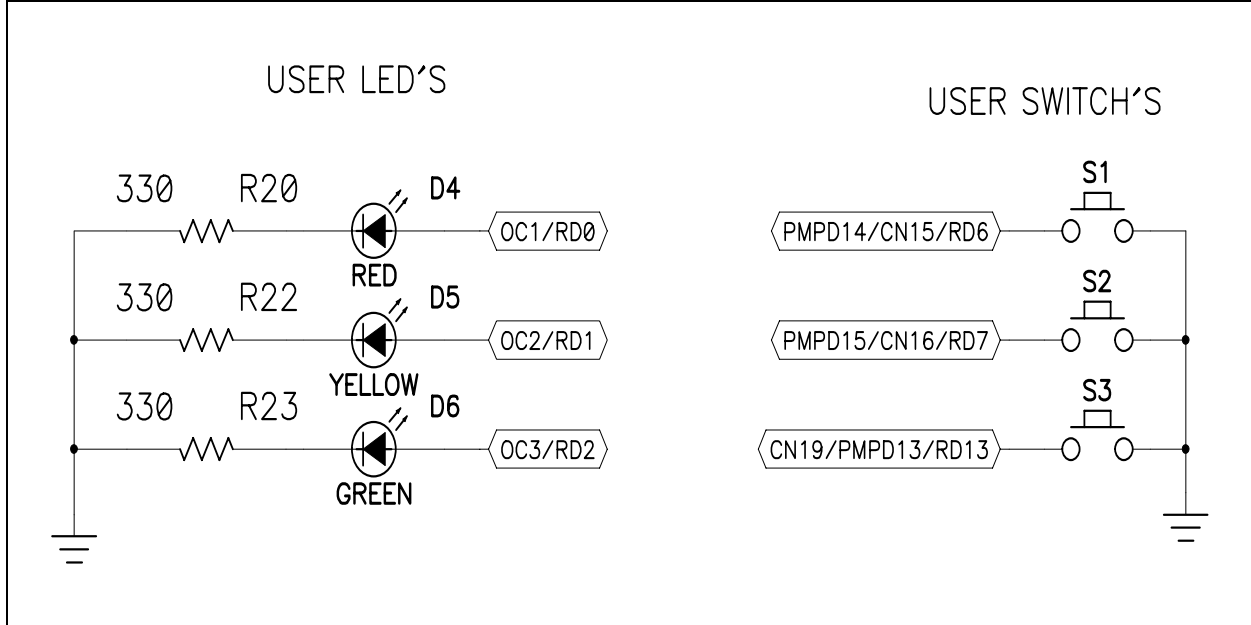

PIC32MX Starter Kit User's Guide

FIGURE A-6: PIC32MX SCHEMATIC, SHEET 6 OF 6 (POWER SUPPLY)

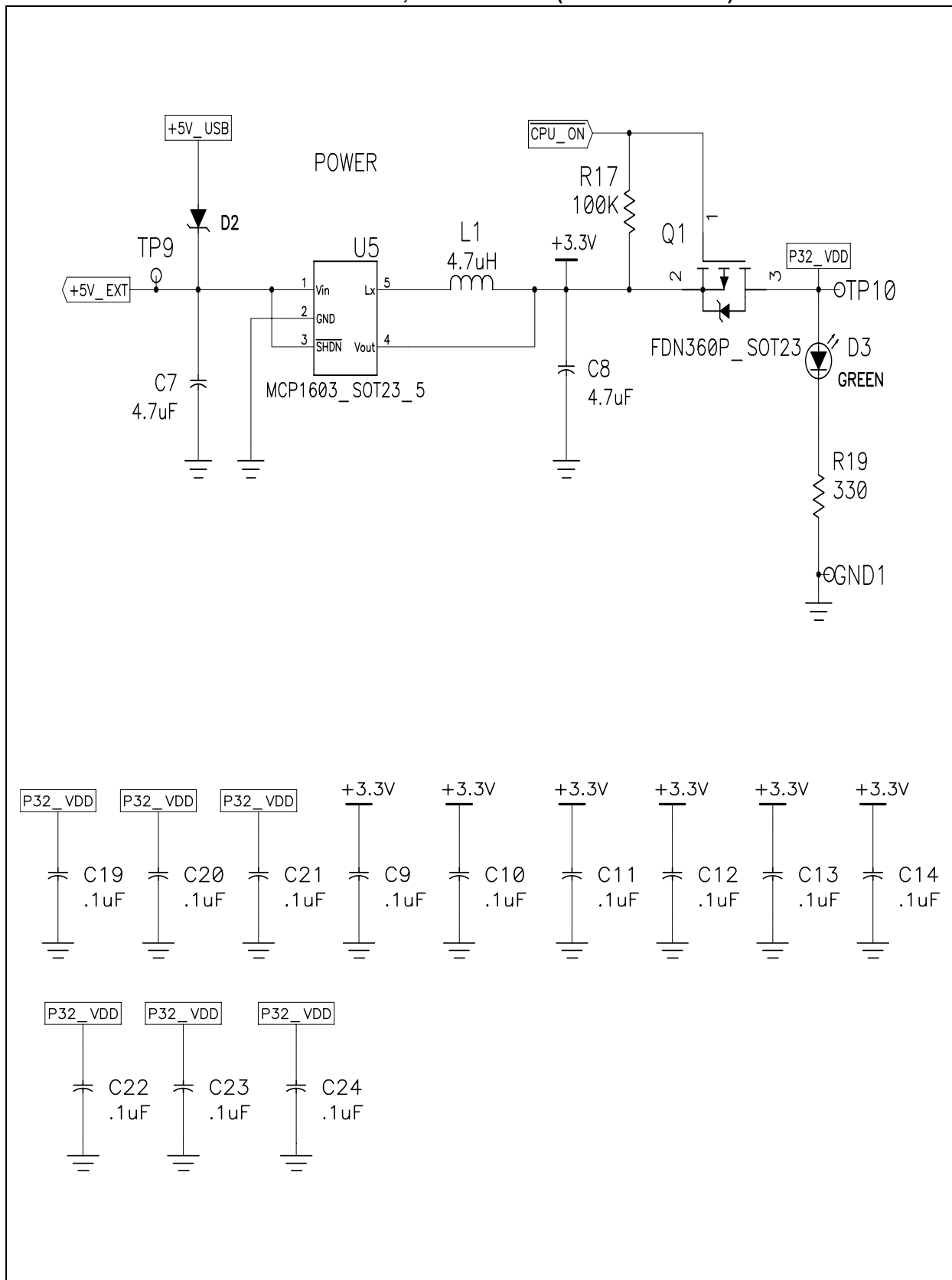

Index

A		P	
Active Toolsuite.....	23	PIC32MX	
B		Layout	
Building the tutorial project.....	15	32-bit microcontroller.....	6
C		Connector for expansion boards.....	6
Connect the Starter Kit Board	11	Debug indicator LED.....	6
Create a Project		On-board crystal	6
Build the Project.....	28	PIC18LF4550 USB microcontroller.....	6
Configuration settings	27	Power supply	6
Customer Change Notification Service	4	Power-indicator LED.....	6
Customer Support.....	4	Switches	6
D		USB connectivity.....	6
Debug print library.....	19	User-defined LEDs	6
Documentation		PIC32MX Out of the box	7
Conventions.....	2	Preprogrammed game	7
F		Preprogrammed example code.....	7
Free Software Foundation	3	print functionality	19
G		Project Wizard	21
GNU Language Tools	3	R	
H		Readme.....	3
Hardware Features		Restore PIC32MX original programming	7
LEDs	32	S	
Oscillator Options	32	Schematics	
PICtail Plus Card Edge Connectors.....	32	Application Board Connector	36
Power Supply.....	31	PIC18LF4550 Debug CPU.....	35
Processor Support.....	31	PIC32MX CPU	34
Switches	32	Power Supply.....	38
USB Connectivity.....	31	Switches and LEDs.....	37
Host Computer Requirements.....	9	Starter Kit Board	
I		Block Diagram.....	33
Installing The Starter Kit Board	10	Connecting	11
Installing the USB Device Driver.....	11	Installing.....	10
Internet Address.....	3	Installing device driver	11
L		Starting the tutorial project	14
Language Toolsuite	23	T	
Last Schematic	38	Tutorial Program Operation.....	17
LEDs		Tutorial Project	
Power.....	11	Building the project	15
M		Program operation	17
Microchip Internet Web Site.....	3	Programming the device	16
MPLAB.....	7	Starting.....	14
MPLAB IDE Simulator, Editor User's Guide.....	3	U	
		USB	
		Connectivity	31
		W	
		WWW Address.....	3



WORLDWIDE SALES AND SERVICE

AMERICAS

Corporate Office
2355 West Chandler Blvd.
Chandler, AZ 85224-6199
Tel: 480-792-7200
Fax: 480-792-7277
Technical Support:
<http://support.microchip.com>
Web Address:
www.microchip.com

Atlanta
Duluth, GA
Tel: 678-957-9614
Fax: 678-957-1455

Boston
Westborough, MA
Tel: 774-760-0087
Fax: 774-760-0088

Chicago
Itasca, IL
Tel: 630-285-0071
Fax: 630-285-0075

Dallas
Addison, TX
Tel: 972-818-7423
Fax: 972-818-2924

Detroit
Farmington Hills, MI
Tel: 248-538-2250
Fax: 248-538-2260

Kokomo
Kokomo, IN
Tel: 765-864-8360
Fax: 765-864-8387

Los Angeles
Mission Viejo, CA
Tel: 949-462-9523
Fax: 949-462-9608

Santa Clara
Santa Clara, CA
Tel: 408-961-6444
Fax: 408-961-6445

Toronto
Mississauga, Ontario,
Canada
Tel: 905-673-0699
Fax: 905-673-6509

ASIA/PACIFIC

Asia Pacific Office
Suites 3707-14, 37th Floor
Tower 6, The Gateway
Harbour City, Kowloon
Hong Kong
Tel: 852-2401-1200
Fax: 852-2401-3431

Australia - Sydney
Tel: 61-2-9868-6733
Fax: 61-2-9868-6755

China - Beijing
Tel: 86-10-8528-2100
Fax: 86-10-8528-2104

China - Chengdu
Tel: 86-28-8665-5511
Fax: 86-28-8665-7889

China - Fuzhou
Tel: 86-591-8750-3506
Fax: 86-591-8750-3521

China - Hong Kong SAR
Tel: 852-2401-1200
Fax: 852-2401-3431

China - Nanjing
Tel: 86-25-8473-2460
Fax: 86-25-8473-2470

China - Qingdao
Tel: 86-532-8502-7355
Fax: 86-532-8502-7205

China - Shanghai
Tel: 86-21-5407-5533
Fax: 86-21-5407-5066

China - Shenyang
Tel: 86-24-2334-2829
Fax: 86-24-2334-2393

China - Shenzhen
Tel: 86-755-8203-2660
Fax: 86-755-8203-1760

China - Shunde
Tel: 86-757-2839-5507
Fax: 86-757-2839-5571

China - Wuhan
Tel: 86-27-5980-5300
Fax: 86-27-5980-5118

China - Xian
Tel: 86-29-8833-7252
Fax: 86-29-8833-7256

ASIA/PACIFIC

India - Bangalore
Tel: 91-80-4182-8400
Fax: 91-80-4182-8422

India - New Delhi
Tel: 91-11-4160-8631
Fax: 91-11-4160-8632

India - Pune
Tel: 91-20-2566-1512
Fax: 91-20-2566-1513

Japan - Yokohama
Tel: 81-45-471- 6166
Fax: 81-45-471-6122

Korea - Daegu
Tel: 82-53-744-4301
Fax: 82-53-744-4302

Korea - Seoul
Tel: 82-2-554-7200
Fax: 82-2-558-5932 or
82-2-558-5934

Malaysia - Kuala Lumpur
Tel: 60-3-6201-9857
Fax: 60-3-6201-9859

Malaysia - Penang
Tel: 60-4-227-8870
Fax: 60-4-227-4068

Philippines - Manila
Tel: 63-2-634-9065
Fax: 63-2-634-9069

Singapore
Tel: 65-6334-8870
Fax: 65-6334-8850

Taiwan - Hsin Chu
Tel: 886-3-572-9526
Fax: 886-3-572-6459

Taiwan - Kaohsiung
Tel: 886-7-536-4818
Fax: 886-7-536-4803

Taiwan - Taipei
Tel: 886-2-2500-6610
Fax: 886-2-2508-0102

Thailand - Bangkok
Tel: 66-2-694-1351
Fax: 66-2-694-1350

EUROPE

Austria - Wels
Tel: 43-7242-2244-39
Fax: 43-7242-2244-393

Denmark - Copenhagen
Tel: 45-4450-2828
Fax: 45-4485-2829

France - Paris
Tel: 33-1-69-53-63-20
Fax: 33-1-69-30-90-79

Germany - Munich
Tel: 49-89-627-144-0
Fax: 49-89-627-144-44

Italy - Milan
Tel: 39-0331-742611
Fax: 39-0331-466781

Netherlands - Drunen
Tel: 31-416-690399
Fax: 31-416-690340

Spain - Madrid
Tel: 34-91-708-08-90
Fax: 34-91-708-08-91

UK - Wokingham
Tel: 44-118-921-5869
Fax: 44-118-921-5820

10/05/07