

power light source

Luxeon™ Star

Technical Datasheet DS23

Luxeon is a revolutionary, energy efficient and ultra compact new light source, combining the lifetime and reliability advantages of Light Emitting Diodes with the brightness of conventional lighting.

Luxeon features one or more power light sources mounted onto an aluminum-core printed circuit board, allowing for ease of assembly, optimum cooling and accurate light center positioning.

For tight beams, optional and highly efficient collimating optics are available.

Luxeon Power Light Sources give you total design freedom and unmatched brightness, creating a new world of light.

For high volume applications, custom Luxeon power light source designs are available upon request, to meet your specific needs.



Luxeon Star is available in white, green, blue, royal blue, cyan, red, red-orange and amber.

Features

- Highest Flux per LED family in the world
- Very long operating life (up to 100k hours)
- Available in White, Green, Blue, Royal Blue, Cyan, Red, Red-Orange and Amber
- Lambertian, Batwing, Side Emitting or Collimated Radiation Pattern
- More Energy Efficient than Incandescent and most Halogen lamps
- Low voltage DC operated
- Cool beam, safe to the touch
- Instant light (less than 100 ns)
- Fully dimmable
- No UV
- Superior ESD protection

Typical Applications

- Reading lights (car, bus, aircraft)
- Portable (flashlight, bicycle)
- Orientation
- Mini-accent
- Decorative
- Fiber Optic Alternative
- Appliance
- Sign and Channel Letter
- Architectural Detail
- Cove Lighting
- Automotive Exterior (Stop-Tail-Turn, CHMSL, Mirror Side Repeat)
- Edge-Lit Signs (Exit, Point Of Sale)

Mechanical Dimensions

Luxeon Star

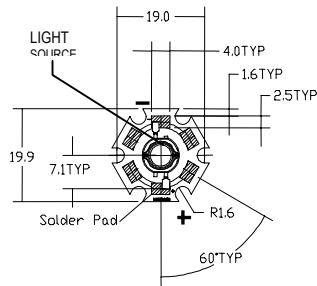

Side Emitting

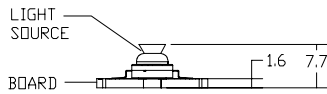

Lambertian (High Dome)

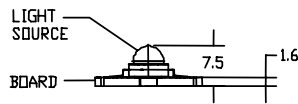

Batwing (Low Dome)

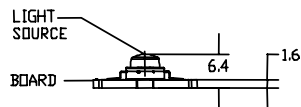

Luxeon Star/C

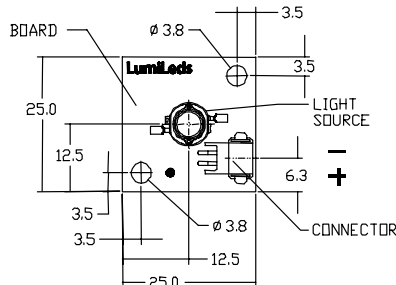

Batwing (Low Dome)

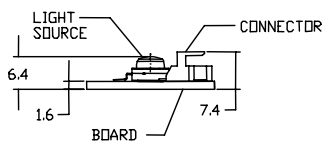

Lambertian (High Dome)

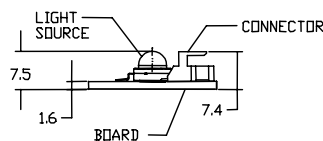

Notes:

1. Slots in aluminum-core PCB for M3 or #4 mounting screw.
2. Electrical interconnection pads labeled on the aluminum-core PCB with "+" and "-" to denote positive and negative, respectively. All positive pads are interconnected, as are all negative pads, allowing for flexibility in array interconnection.
3. Drawings not to scale.
4. All dimensions are in millimeters.

Notes:

1. Holes in aluminum-core PCB for M3 or #4 mounting screw.
2. Connector on board AMP type, code 2-179123-2 ; Mating connector – AMP receptacle housing assembly, code 173977-2.
3. Positive and negative pins in connector are as indicated on the drawing.
4. Drawings not to scale.
5. All dimensions are in millimeters.

Mechanical Dimensions

Luxeon Star/IDC

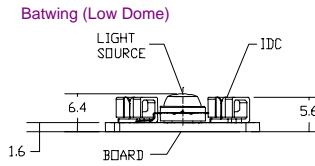
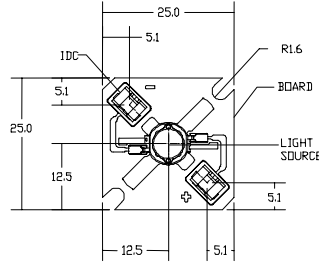

Notes:

1. Slots in aluminum-core PCB for M3 or #4 mounting screw.
2. Connectors on board Zierick type, code 1245T; accepts #26-18 AWG wire. Compatible with Zierick manual wire insertion tool WTP-4ALL and pneumatic production tool WTPPS-1208-1.
3. Positive and negative IDC connectors are indicated with a "+" and a "-" on the aluminum-core PCB, respectively.
4. Drawings not to scale.
5. All dimensions are in millimeters.

Luxeon Star/O

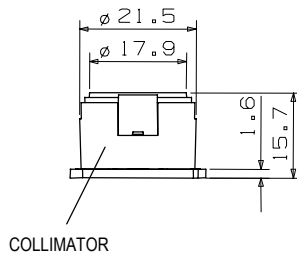
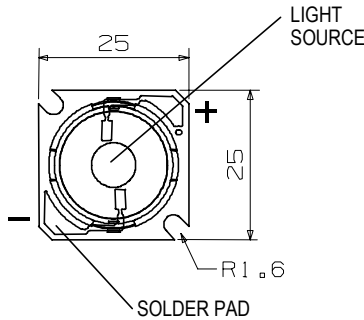

Notes:

1. Slots in aluminum-core PCB for M3 or #4 mounting screw.
2. Positive solder pad is indicated by a copper dot next to the pad on the aluminum-core PCB.
3. The collimator is molded from optical grade acrylic. Do not subject to temperatures greater than 75°C, as plastic deformation may occur. Protect optic against exposure to solvents and adhesives that are not compatible with acrylic.
4. Drawings not to scale.
5. All dimensions are in millimeters.

Part Number Matrix

COLOR	STAR	STAR/C	STAR/O ⁽¹⁾	STAR/IDC ⁽²⁾	BEAM PATTERN
WHITE ⁽³⁾	LXHL-MW I C	LXHL-MW I A	LXHL-NW98	LXHL-MW I E	BATWING (LOW DOME)
WHITE ⁽³⁾	LXHL-MWEC	LXHL-MWEA	LXHL-NWE8	N/A	
GREEN	LXHL-MM I C	LXHL-MM I A	LXHL-NM98	LXHL-MM I E	
CYAN	LXHL-ME I C	LXHL-ME I A	LXHL-NE98	LXHL-ME I E	
BLUE	LXHL-MB I C	LXHL-MB I A	LXHL-NB98	LXHL-MB I E	
ROYAL BLUE	LXHL-MRRC	LXHL-MRRA	LXHL-NRR8	LXHL-MR I E	
RED	LXHL-MD I C	LXHL-MD I A	LXHL-ND98	LXHL-MD I E	
AMBER	LXHL-ML I C	LXHL-ML I A	LXHL-NL98	LXHL-ML I E	
WHITE	LXHL-MW I D	LXHL-MW I B	N/A	N/A	LAMBERTIAN (HIGH DOME)
GREEN	LXHL-MM I D	LXHL-MM I B	N/A	N/A	
CYAN	LXHL-ME I D	LXHL-ME I B	N/A	N/A	
BLUE	LXHL-MB I D	LXHL-MB I B	N/A	N/A	
ROYAL BLUE	LXHL-MRRD	LXHL-MRRB	N/A	N/A	
Red	LXHL-MD I D	LXHL-MD I B	LXHL-ND94	N/A	
RED-ORANGE	LXHL-MH I D	LXHL-MH I B	LXHL-NH94	N/A	
AMBER	LXHL-ML I D	LXHL-ML I B	LXHL-NL94	N/A	
WHITE	LXHL-FW I C	N/A	N/A	N/A	SIDE EMITTING
GREEN	LXHL-FM I C	N/A	N/A	N/A	
CYAN	LXHL-FE I C	N/A	N/A	N/A	
BLUE	LXHL-FB I C	N/A	N/A	N/A	
ROYAL BLUE	LXHL-FR I C	N/A	N/A	N/A	
RED	LXHL-FD I C	N/A	N/A	N/A	
RED-ORANGE	LXHL-FH I C	N/A	N/A	N/A	
AMBER	LXHL-FL I C	N/A	N/A	N/A	

Flux Characteristics at 350mA, Junction Temperature, T_J = 25°C

COLOR	MINIMUM LUMINOUS FLUX (lm) OR RADIOMETRIC POWER (mW) Φ _v ^[1,2]	TYPICAL LUMINOUS FLUX (lm) OR RADIOMETRIC POWER (mW) Φ _v ^[2]	RADIATION PATTERN
WHITE (LXHL-MW I C, MW I A, NW98 & MW I E)	13.9	25	BATWING (LOW DOME)
WHITE (LXHL-MWEC, MWEA & NWE8)	18.1	25	
GREEN	13.9	30	
CYAN	13.9	30	
BLUE ⁽³⁾	3.8	10	
ROYAL BLUE ⁽⁴⁾	55 mW	150 mW	
Red	13.9	27	
AMBER	10.7	25	
WHITE	13.9	25	LAMBERTIAN (HIGH DOME)
GREEN	13.9	30	
CYAN	13.9	30	
BLUE ⁽³⁾	3.8	10	
ROYAL BLUE ⁽⁴⁾	55 mW	150 mW	
Red	30.6	44	
RED-ORANGE	39.8	55	
AMBER	23.5	36	
WHITE	13.9	22	SIDE EMITTING
GREEN	13.9	27	
CYAN	13.9	27	
BLUE ⁽³⁾	3.8	9	
ROYAL BLUE ⁽⁴⁾	55 mW	135 mW	
Red	30.6	40	
RED-ORANGE	39.8	50	
AMBER	23.5	32	

Notes:

- Star/O produces a narrow collimated beam due to the inclusion of the collimating optic. In red, red-orange, and amber the Star/O listed under lambertian radiation pattern is higher in luminous output, although the collimated beam pattern is similar to the Star/O products based on the batwing emitter.
- Star/IDC available in the batwing radiation pattern only. The wide angle of optical output from a lambertian or side emitting device results in significant light loss due to the IDC connectors in the optical path.
- In July 2003 Lumileds announced a second line of white batwing products using a new phosphor deposition process resulting in improved color uniformity. These new batwing emitters (LXHL-BW02) are incorporated into Luxeon Star part numbers LXHL-MWEC, LXHL-MWEA and LXHL-NWE8. Other white Luxeon Star products are based on the LXHL-BW01 Luxeon Emitter.

Notes:

- Minimum luminous flux or radiometric power performance guaranteed within published operating conditions. Lumileds maintains a tolerance of ± 10% on flux and power measurements.
- Flux and power values for Luxeon Star without secondary optics. The efficiency of collimating optics is approximately 85%. Luxeon types with even higher luminous flux levels will become available in the future. Please consult your Lumileds Authorized Distributor or Lumileds sales representative for more information.
- Minimum flux value for 470 nm devices. Due to the CIE eye response curve in the short blue wavelength range, the minimum luminous flux will vary over the Lumileds' blue color range. Luminous flux will vary from a minimum of 2.9 lm at 460 nm to a typical of 16 lm at 480 nm due to this effect. Although the luminous power efficiency is lower in the short blue wavelength range, radiometric power efficiency increases as wavelength decreases. For more information, consult the Luxeon Design Guide, available upon request.
- Royal Blue product is binned by radiometric power and peak wavelength rather than photometric lumens and dominant wavelength.

Optical Characteristics at 350mA, Junction Temperature, T_J = 25°C

COLOR	DOMINANT WAVELENGTH ⁽¹⁾ λ _D , PEAK WAVELENGTH ⁽²⁾ λ _P , OR COLOR TEMPERATURE ⁽³⁾ CCT			SPECTRAL HALF-WIDTH ⁽⁴⁾ (nm) Δλ _{1/2}	TEMPERATURE COEFFICIENT OF DOMINANT WAVELENGTH (nm/°C) Δλ _D /ΔT _J
	MIN.	TYP.	MAX.		
WHITE (LXHL-MW1C, MW1A, NW98 & MW1E)	4500 K	5500 K	8000 K	----	----
WHITE (LXHL-MWEC, MWEA & NWE8)	4500 K	5500 K	10000 K	----	----
GREEN	520 nm	530 nm	550 nm	35	0.04
CYAN	490 nm	505 nm	520 nm	30	0.04
BLUE	460 nm	470 nm	490 nm	25	0.04
ROYAL BLUE ⁽²⁾	440 nm	455 nm	460 nm	20	0.04
RED	620.5 nm	625 nm	645.0 nm	20	0.05
RED-ORANGE	612.5 nm	617 nm	620.5 nm	20	0.06
AMBER	587.5 nm	590 nm	597.0 nm	14	0.09

Optical Characteristics at 350mA, Junction Temperature, T_J = 25°C, Continued

RADIATION PATTERN	COLOR	LUXEON STAR & LUXEON STAR/C		LUXEON STAR/O (WITH OPTICS)		
		TOTAL INCLUDED ANGLE ⁽⁵⁾ (DEGREE) θ _{0.90V}	VIEWING ANGLE ⁽⁶⁾ (DEGREE) 20 1/2	TOTAL INCLUDED ANGLE ⁽⁵⁾ (DEGREE) θ _{0.90V}	VIEWING ANGLE ⁽⁶⁾ (DEGREE) 20 1/2	TYPICAL CANDELA ON AXIS ⁽⁷⁾ (cd)
		WHITE (ALL EXCEPT LXHL-NWE8)	WHITE (LXHL-NWE8)	110	110	25
BATWING (LOW DOME)	GREEN	110	110	25	10	600
	CYAN	110	110	25	10	600
	BLUE	110	110	25	10	200 ⁽⁷⁾
	ROYAL BLUE	110	110	25	10	120
	RED	110	110	25	10	810
	AMBER	110	110	25	10	750
LAMBERTIAN (HIGH DOME)	WHITE	160	140	N/A	N/A	N/A
	GREEN	160	140	N/A	N/A	N/A
	CYAN	160	140	N/A	N/A	N/A
	BLUE	160	140	N/A	N/A	N/A
	ROYAL BLUE	160	140	N/A	N/A	N/A
	RED	160	140	25	10	660
	RED-ORANGE	160	140	25	10	825
	AMBER	160	140	25	10	540

Optical Characteristics at 350mA, Junction Temperature, T_J = 25°C, Continued

RADIATION PATTERN	COLOR	TYPICAL TOTAL FLUX PERCENT WITHIN FIRST 45° ⁽⁸⁾ CUM Φ _{45°}	TYPICAL ANGLE OF PEAK INTENSITY ⁽⁹⁾ θ _{PEAK}
		SIDE EMITTING	WHITE
	GREEN	< 15%	75° - 85°
	CYAN	< 15%	75° - 85°
	BLUE	< 15%	75° - 85°
	ROYAL BLUE	< 15%	75° - 85°
	RED	< 15%	75° - 85°
	RED-ORANGE	< 15%	75° - 85°
	AMBER	< 15%	75° - 85°

Notes: (for three optical tables)

- Dominant wavelength is derived from the CIE 1931 Chromaticity diagram and represents the perceived color. Lumileds maintains a tolerance of ± 0.5nm for dominant wavelength measurements.
- Royal Blue product is binned by radiometric power and peak wavelength rather than photometric lumens and dominant wavelength. Lumileds maintains a tolerance of ± 2nm for peak wavelength measurements.
- CRI (Color Rendering Index) for White product types is 70. CCT ± 5% tester tolerance.
- Spectral width at 1/2 of the peak intensity.
- Total angle at which 90% of total luminous flux is captured.
- θ_{1/2} is the off axis angle from lamp centerline where the luminous intensity is 1/2 of the peak value.
- Typical candela on axis for 470 nm devices. Due to the CIE eye response curve in the short blue wavelength range, candela values will vary over Lumileds' blue color range.
- Cumulative flux percent within ± 45° from optical axis.
- Off axis angle from lamp centerline where the luminous intensity reaches the peak value.
- All red, red-orange and amber products built with Aluminum Indium Gallium Phosphide (AlInGaP).
- All white, green, cyan, blue and royal blue products built with Indium Gallium Nitride (InGaN).
- Blue and Royal Blue power light sources represented here are IEC825 Class 2 for eye safety.

Electrical Characteristics at 350mA, Junction Temperature, $T_J = 25^\circ\text{C}$

RADIATION PATTERN	COLOR	FORWARD VOLTAGE V_F (V) ^[1]			DYNAMIC RESISTANCE ^[2] (Ω) R_D	TEMPERATURE COEFFICIENT OF FORWARD VOLTAGE ^[3] (mV/ $^\circ\text{C}$) $\Delta V_F / \Delta T_J$	THERMAL RESISTANCE, JUNCTION TO BOARD ($^\circ\text{C}/\text{W}$) $R_{\theta JB}$
		MIN.	TYP.	MAX.			
BATWING (LOW DOME)	WHITE	2.79	3.42	3.99	1.0	-2.0	17
	GREEN	2.79	3.42	3.99	1.0	-2.0	17
	CYAN	2.79	3.42	3.99	1.0	-2.0	17
	BLUE	2.79	3.42	3.99	1.0	-2.0	17
	ROYAL BLUE	2.79	3.42	3.99	1.0	-2.0	17
	RED	2.31	2.85	3.27	2.4	-2.0	17
	AMBER	2.31	2.85	3.27	2.4	-2.0	17
LAMBERTIAN (HIGH DOME)	WHITE	2.79	3.42	3.99	1.0	-2.0	17
	GREEN	2.79	3.42	3.99	1.0	-2.0	17
	CYAN	2.79	3.42	3.99	1.0	-2.0	17
	BLUE	2.79	3.42	3.99	1.0	-2.0	17
	ROYAL BLUE	2.79	3.42	3.99	1.0	-2.0	17
	RED	2.31	2.95	3.51	2.4	-2.0	20
	RED-ORANGE	2.31	2.95	3.51	2.4	-2.0	20
	AMBER	2.31	2.95	3.51	2.4	-2.0	20
SIDE EMITTING	WHITE	2.79	3.42	3.99	1.0	-2.0	17
	GREEN	2.79	3.42	3.99	1.0	-2.0	17
	CYAN	2.79	3.42	3.99	1.0	-2.0	17
	BLUE	2.79	3.42	3.99	1.0	-2.0	17
	ROYAL BLUE	2.79	3.42	3.99	1.0	-2.0	17
	RED	2.31	2.95	3.51	2.4	-2.0	20
	RED-ORANGE	2.31	2.95	3.51	2.4	-2.0	20
	AMBER	2.31	2.95	3.51	2.4	-2.0	20

Notes:

1. Lumileds maintains a tolerance of $\pm 0.06\text{V}$ on forward voltage measurements.
2. Dynamic resistance is the inverse of the slope in linear forward voltage model for LEDs. See Figures 3a and 3b.
3. Measured between $25^\circ\text{C} \leq T_J \leq 110^\circ\text{C}$ at $I_F = 350\text{mA}$.

Absolute Maximum Ratings

PARAMETER	WHITE/GREEN/CYAN/ BLUE/ROYAL BLUE	RED/AMBER/ RED-ORANGE
DC FORWARD CURRENT (mA) ^[1]	350	385
PEAK PULSED FORWARD CURRENT (mA)	500	550
AVERAGE FORWARD CURRENT (mA)	350	350
REVERSE VOLTAGE (V) ^[2]	> 5	> 5
LED JUNCTION TEMPERATURE ($^\circ\text{C}$)	120	120
ALUMINUM-CORE PCB TEMPERATURE ($^\circ\text{C}$)	105	105
STORAGE & OPERATING TEMPERATURE ($^\circ\text{C}$)	LUXEON STAR LUXEON STAR/o ^[3]	-40 to +105 -40 to +75

Notes:

1. Proper current derating must be observed to maintain junction temperature below the maximum. For more information, consult the Luxeon Design Guide, available upon request.
2. Measured at $I_F = 100 \mu\text{A}$. Lumileds maintains a tolerance of $\pm 0.06\text{V}$ on reverse voltage measurements. LEDs are not designed to be driven in reverse bias. All products are not sensitive to ESD damage ($\pm 16,000$ Volts by HBM condition).
3. A reduction in maximum storage and operating temperature is required due to the acrylic optic.

Wavelength Characteristics, $T_J = 25^\circ\text{C}$

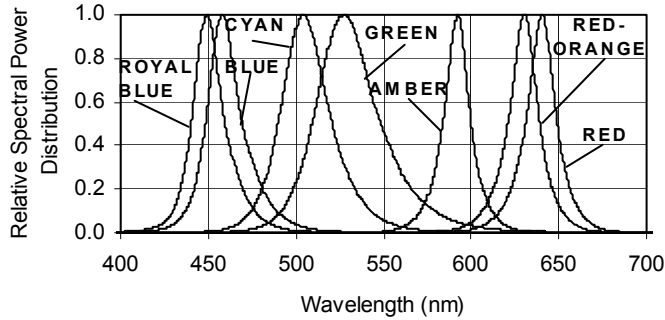

Figure 1a.
Relative Intensity vs. Wavelength.

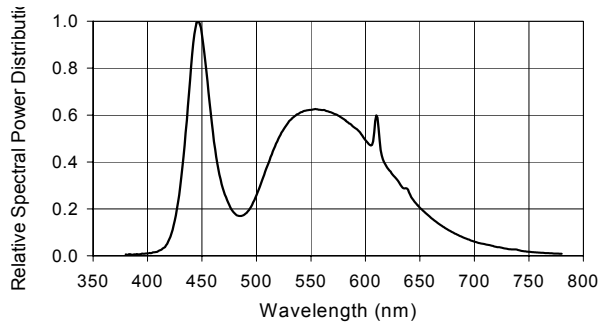

Figure 1b.
White Color Spectrum of Typical CCT Part, Integrated Measurement.

Light Output Characteristics

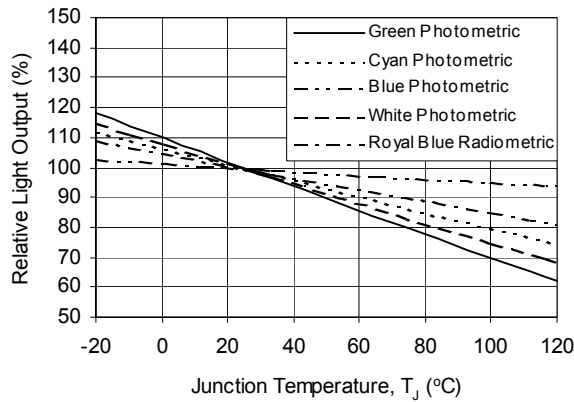

Figure 2a.
Relative Light Output vs. Junction Temperature for White, Green, Cyan, Blue and Royal Blue.

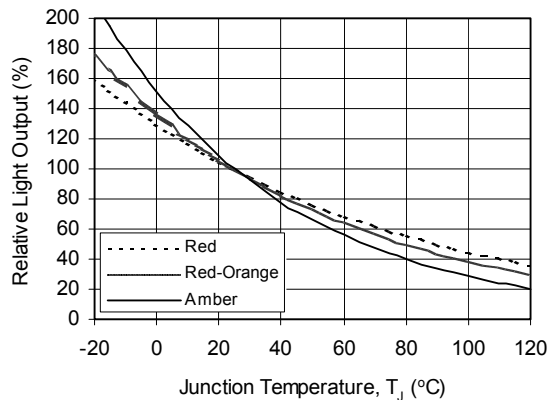

Figure 2b.
Relative Light Output vs. Junction Temperature for Red, Red-Orange and Amber.

Forward Current Characteristics, $T_J = 25^\circ\text{C}$

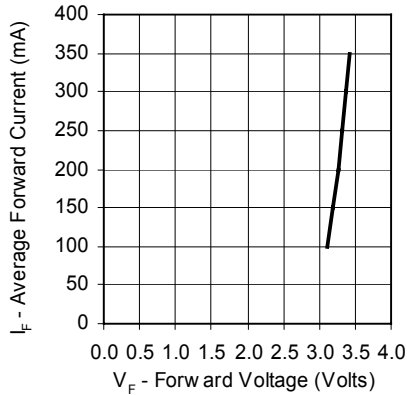

Figure 3a.
Forward Current vs. Forward Voltage for White, Green, Cyan, Blue, and Royal Blue.

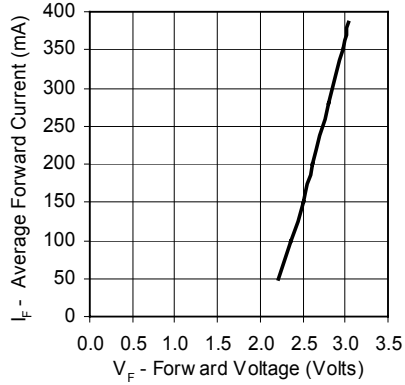

Figure 3b.
Forward Current vs. Forward Voltage for Red, Red-Orange and Amber.

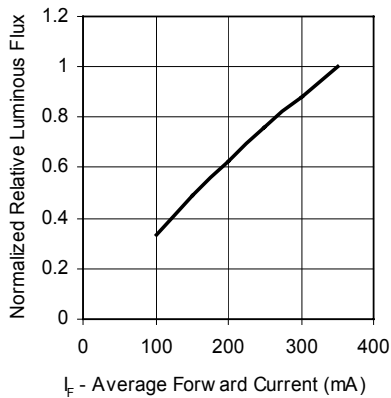

Figure 4a.
Relative Luminous Flux vs. Forward Current for White, Green, Cyan, Blue, and Royal Blue at $T_J = 25^\circ\text{C}$ maintained.

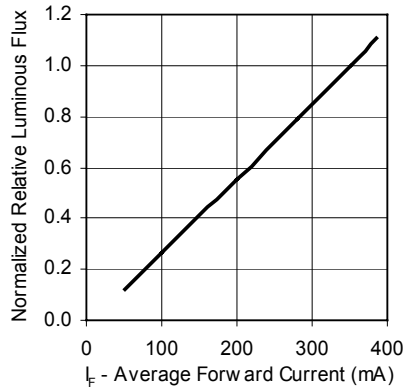

Figure 4b.
Relative Luminous Flux vs. Forward Current for Red, Red-Orange and Amber at $T_J = 25^\circ\text{C}$ maintained.

Note:

Driving these high power devices at currents less than the test conditions may produce unpredictable results and may be subject to variation in performance. Pulse width modulation (PWM) is recommended for dimming effects.

Current Derating Curves Star, Star/C, Star/IDC

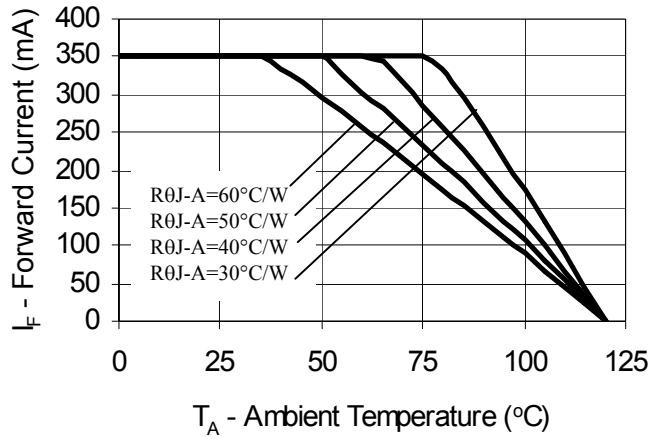

Figure 5a.
Maximum Forward Current vs. Ambient Temperature. Derating based on $T_{JMAX} = 120^\circ\text{C}$ and $T_{BOARD MAX} = 105^\circ\text{C}$ for White, Green, Cyan, Blue, and Royal Blue.

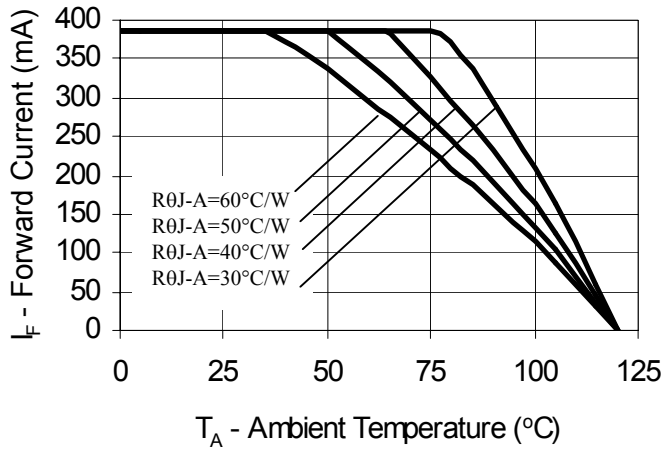

Figure 5b.
Maximum Forward Current vs. Ambient Temperature. Derating based on $T_{JMAX} = 120^\circ\text{C}$ and $T_{BOARD MAX} = 105^\circ\text{C}$ for Red, Red-Orange and Amber.

Current Derating Curves Star/O

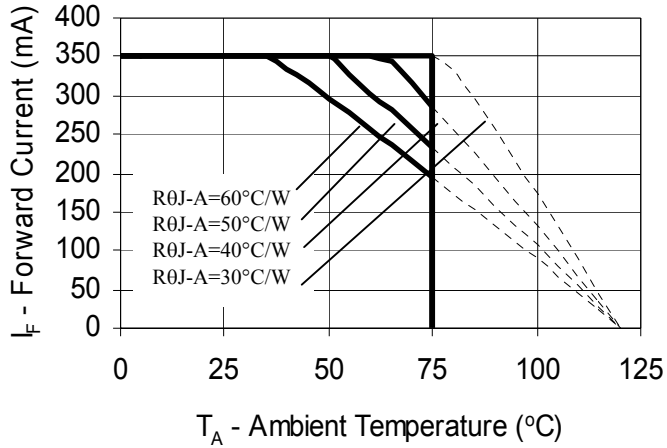

Figure 5c.
Maximum Forward Current vs. Ambient Temperature. Derating based on $T_{JMAX} = 120^{\circ}\text{C}$ and $T_{AMBIENT MAX} = 75^{\circ}\text{C}$ for White, Green, Cyan, Blue, and Royal Blue.

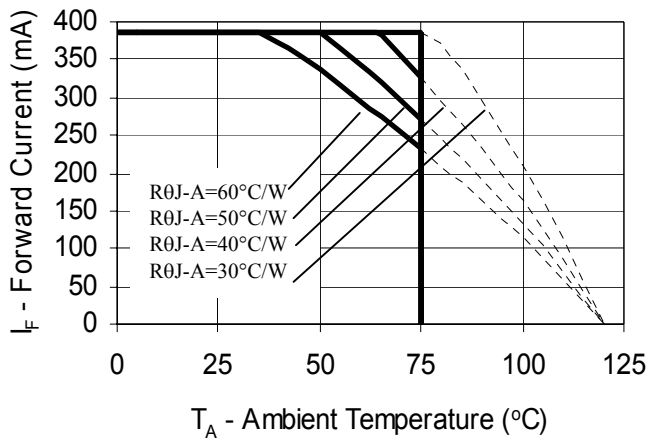

Figure 5d.
Maximum Forward Current vs. Ambient Temperature. Derating based on $T_{JMAX} = 120^{\circ}\text{C}$ and $T_{AMBIENT MAX} = 75^{\circ}\text{C}$ for Red, Red-Orange and Amber.

Typical Representative Spatial Radiation Pattern

Batwing Radiation Pattern (without optics)

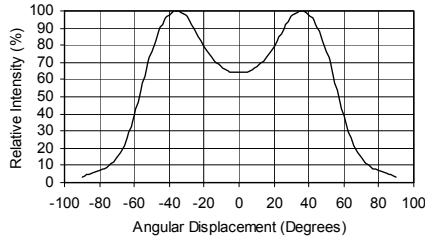

Figure 6a.
Typical Representative Spatial Radiation Pattern for Luxeon Star White (LXHL-MW1C, LXHL-MW1A, LXHL-MW1E).

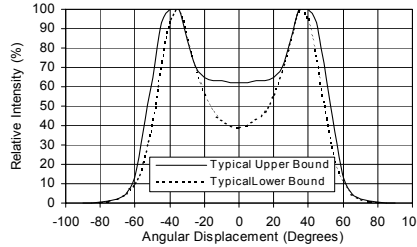

Figure 6b.
Typical Representative Spatial Radiation Pattern for Luxeon Star Red, Amber, Green, Cyan, Blue, Royal Blue and White (LXHL-MWEC and LXHL-MWEA).

Lambertian Radiation Pattern (without optics)

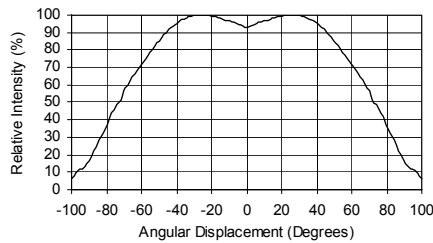

Figure 7a.
Typical Representative Spatial Radiation Pattern for Luxeon Star Red, Red-Orange and Amber.

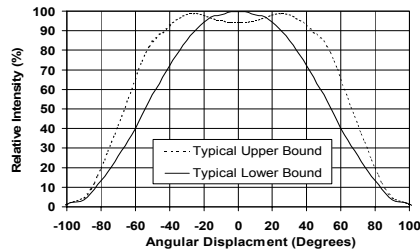

Figure 7b.
Typical Representative Spatial Radiation Pattern for Luxeon Star White Green, Cyan, Blue and Royal Blue.

Side Emitting Radiation Pattern (without optics)

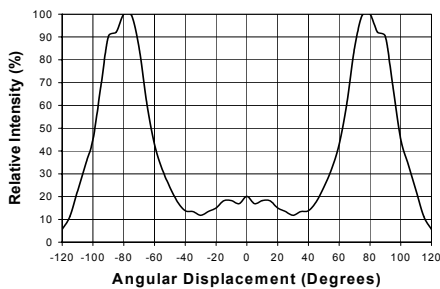

Figure 8a.
Typical Representative Spatial Radiation Pattern for Luxeon Star Red, Red-Orange and Amber.

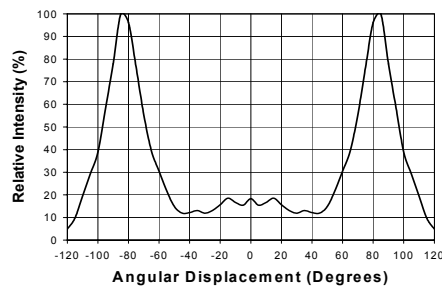

Figure 8b.
Typical Representative Spatial Radiation Pattern for Luxeon Star White, Green, Cyan, Blue and Royal Blue.

Note:

For more detailed technical information regarding Luxeon radiation patterns, please consult your Lumileds Authorized Distributor or Lumileds sales representative.

Typical Representative Spatial Radiation Pattern

Radiation Pattern (with optics)

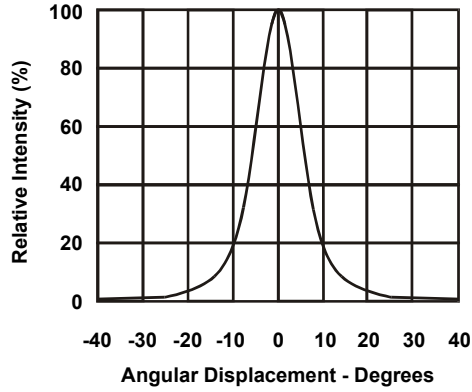

Figure 9.
Typical Representative Spatial Radiation Pattern for Luxeon Star/O (with optics), for all colors.

Average Lumen Maintenance Characteristics

Lifetime for solid-state lighting devices (LEDs) is typically defined in terms of lumen maintenance—the percentage of initial light output remaining after a specified period of time. Lumileds projects that Luxeon products will deliver on average 70% lumen maintenance at 50,000 hours of operation. This performance is based on independent test data, Lumileds historical data from tests run on similar material systems, and internal Luxeon reliability testing. This projection is based on constant current 350 mA operation with junction temperature maintained at or below 90°C. Observation of design limits included in this data sheet is required in order to achieve this projected lumen maintenance.

About Luxeon



Luxeon is the new world of solid-state lighting (LED) technology. Luxeon Power Light Source Solutions offer huge advantages over conventional lighting and huge advantages over other LED solutions. Luxeon enables partners to create and market products that, until now, were impossible to create. This means the opportunity to create products with a clear competitive advantage in the market. Products that are smaller, lighter, sleeker, cooler, and brighter. Products that are more fun to use, more efficient, and more environmentally conscious than ever before possible!



Company Information

Luxeon is developed, manufactured and marketed by Lumileds Lighting, U.S., LLC. Lumileds is a world-class supplier of Light Emitting Diodes (LEDs) producing billions of LEDs annually. Lumileds is a fully integrated supplier, producing core LED material in all three base colors (Red, Green, Blue) and White. Lumileds has R&D development centers in San Jose, California and Best, The Netherlands. Production capabilities in San Jose, California and Malaysia.

Lumileds is pioneering the high-flux LED technology and bridging the gap between solid-state LED technology and the lighting world. Lumileds is absolutely dedicated to bringing the best and brightest LED technology to enable new applications and markets in the Lighting world.



©2003 Lumileds Lighting. All rights reserved. Luxeon is a trademark of Lumileds Lighting, U.S., LLC. Product specifications are subject to change without notice.

Lumileds may make process or materials changes affecting the performance or other characteristics of Luxeon. These products supplied after such change will continue to meet published specifications, but may not be identical to products supplied as samples or under prior orders.

LUMILEDS

www.luxeon.com
www.lumileds.com

For technical assistance or the location of your nearest Lumileds sales office, call:

Worldwide:
+1 408-435-6044
US Toll free: 877-298-9455
Europe: +31 499 339 439
Asia: +65 6248 4759
Fax: 408-435-6855
Email us at info@lumileds.com

Lumileds Lighting, U.S., LLC
370 West Trimble Road
San Jose, CA 95131