

SMD Choke Coils

Singapore
Indonesia

Series: **V**
Type: **ELLATV**

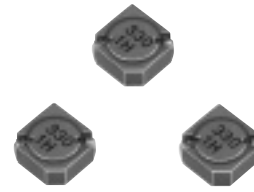

Type ELLATV

■ Features

- Magnetically shielded structure
- Low DC resistance and large current capability
- Available on tape and reel for automatic insertion

■ Recommended Applications

- DC-DC converter circuitry for computer peripherals and cellular phones.
- Chopper circuit decoupling chokes for DC-DC converter circuitry

■ Standard Packing Quantity

- 500 pcs./Reel

■ Explanation of Part Numbers

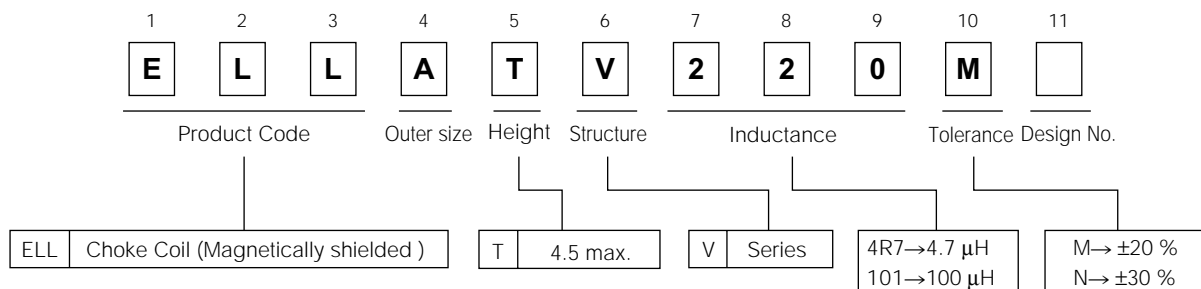

■ Dimensions in mm (not to scale)

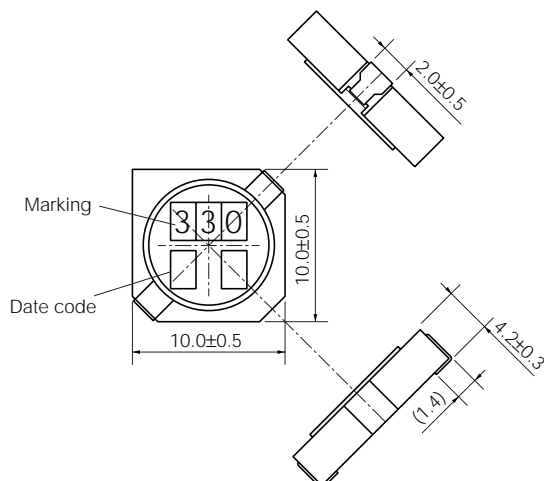

■ Recommended Land Pattern in mm (not to scale)

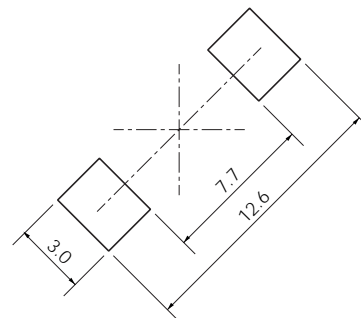

Standard Parts

Part No.	Inductance (100 kHz)		R _{DC} (at 20 °C)		* Rated Current (mA) max.	Marking
	(μH)	Tolerance	(mΩ)	Tolerance		
ELLATV1R5N	1.5	±30 %	5.3	±20 %	6700	1R5
ELLATV2R2N	2.2		6.3		6200	2R2
ELLATV3R3N	3.3		8.8		5350	3R3
ELLATV4R3N	4.3		10		5000	4R3
ELLATV5R1N	5.1		14		4350	5R1
ELLATV6R8N	6.8		16		4000	6R8
ELLATV8R2N	8.2		18		3700	8R2
ELLATV100M	10.0		23		3300	100
ELLATV120M	12.0	25	2900	120		
ELLATV150M	15.0	32	2800	150		
ELLATV180M	18.0	38	2500	180		
ELLATV220M	22.0	45	2200	220		
ELLATV270M	27.0	56	2000	270		
ELLATV330M	33.0	62	1800	330		
ELLATV390M	39.0	74	1600	390		
ELLATV470M	47.0	94	1550	470		
ELLATV560M	56.0	100	1350	560		
ELLATV680M	68.0	130	1200	680		
ELLATV820M	82.0	150	1100	820		
ELLATV101M	100.0	180	1000	101		
ELLATV121M	120.0	190	840	121		
ELLATV151M	150.0	250	780	151		
ELLATV181M	180.0	320	750	181		
ELLATV221M	220.0	360	700	221		
ELLATV271M	270.0	460	600	271		
ELLATV331M	330.0	550	550	331		
ELLATV391M	390.0	690	520	391		
ELLATV471M	470.0	780	470	471		
ELLATV561M	560.0	820	390	561		
ELLATV681M	680.0	1150	370	681		
ELLATV821M	820.0	1270	340	821		
ELLATV102M	1000.0	1750	320	102		

* Current: This indicates the value of current when the inductance is 70 % of nominal value or when the case temperature has risen 45 °C (at 20 °C)

Embossed Carrier Tape Dimensions in mm (not to scale)

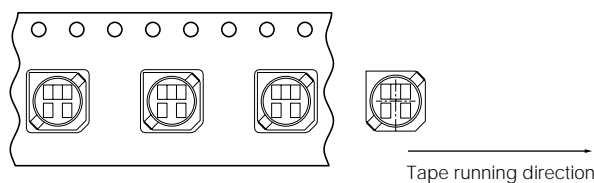
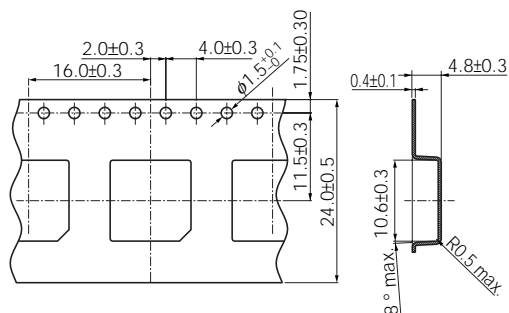

Quantity 500 pcs./reel

Date code

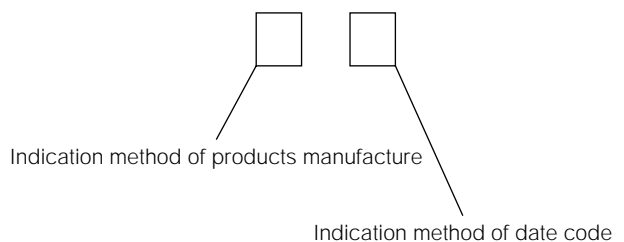

Month	1	2	3	4	5	6	7	8	9	10	11	12
Year												
Odd year	A	B	C	D	E	F	H	I	J	K	L	M
Even year	N	O	P	R	S	T	U	V	W	X	Y	Z