

**Bi-directional Ultra Low Capacitance TVS Diode**

- ESD / transient protection of RF signal lines according to:  
IEC61000-4-2 (ESD):  $\pm 20\text{kV}$  (contact)  
IEC61000-4-4 (EFT): 40 A (5 / 50 ns)  
IEC61000-4-5 (Surge): 3 A (8 / 20  $\mu\text{s}$ )
- Extremely small form factor down to 0.62 x 0.32 x 0.31 mm<sup>3</sup>
- Very low dynamic resistance
- Max. working voltage:  $\pm 5.3\text{ V}$
- Extremely low capacitance: 0.2 pF typ.
- Very low reverse current < 1 nA typ.
- Very low series inductance down to 0.2 nH typ.
- Pb-free (RoHS compliant) package
- Qualified according AEC Q101

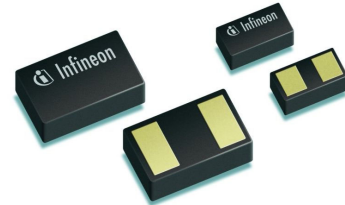

**Applications**

- ESD protection of sensitive RF signal lines
- RF antenna protection, frontend module
- GPS, mobile TV, FM radio, RKE, UWB



**ESD0P2RF-02LRH**  
**ESD0P2RF-02LS**

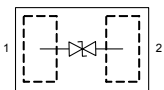

Type	Package	Configuration	Marking
ESD0P2RF-02LRH	TSLP-2-17	1 line, bi-directional	T
ESD0P2RF-02LS	TSSLP-2-1	1 line, bi-directional	T

**Maximum Ratings** at  $T_A = 25^\circ\text{C}$ , unless otherwise specified

Parameter	Symbol	Value	Unit
ESD contact discharge <sup>1)</sup> , contact	$V_{\text{ESD}}$	20	kV
Peak pulse current ( $t_p = 8 / 20 \mu\text{s}$ ) <sup>2)</sup>	$I_{\text{pp}}$	3	A
Operating temperature range	$T_{\text{op}}$	-55...125	°C
Storage temperature	$T_{\text{stg}}$	-55...150	

<sup>1)</sup> $V_{\text{ESD}}$  according to IEC61000-4-2

<sup>2)</sup> $I_{\text{pp}}$  according to IEC61000-4-5

**Electrical Characteristics** at  $T_A = 25^\circ\text{C}$ , unless otherwise specified

Parameter	Symbol	Values			Unit
		min.	typ.	max.	
<b>Characteristics -</b>					
Reverse working voltage	$V_{\text{RWM}}$	-5.3	-	5.3	V
Breakdown voltage	$V_{(\text{BR})}$				
$I_{(\text{BR})} = 1 \text{ mA}$ , from pin 2 to 1		7	-	-	
$I_{(\text{BR})} = 1 \text{ mA}$ , from pin 1 to 2		7	-	-	
Reverse current $V_R = 5.3 \text{ V}$	$I_R$	-	<1	50	nA
Clamping voltage	$V_{\text{CL}}$				V
$I_{\text{PP}} = 1 \text{ A}$ , $t_p = 8/20 \mu\text{s}$ <sup>1)</sup>		-	11	17	
$I_{\text{PP}} = 3 \text{ A}$ , $t_p = 8/20 \mu\text{s}$ <sup>1)</sup>		-	15	21	
Diode capacitance	$C_T$				pF
$V_R = 0 \text{ V}$ , $f = 1 \text{ MHz}$		-	0.23	0.4	
$V_R = 0 \text{ V}$ , $f = 1 \text{ GHz}$		-	0.2	0.4	
Dynamic resistance ( $t_p=30\text{ns}$ )	$R_D$	-	1	-	$\Omega$
Series inductance	$L_S$				nH
ESD0P2RF-02LS		-	0.2	-	
ESD0P2RF-02LRH		-	0.4	-	

<sup>1)</sup> $I_{\text{pp}}$  according to IEC61000-4-5

**Clamping voltage,  $V_{cl} = f(I_{pp})$**

$t_p = 8 / 20 \mu s$

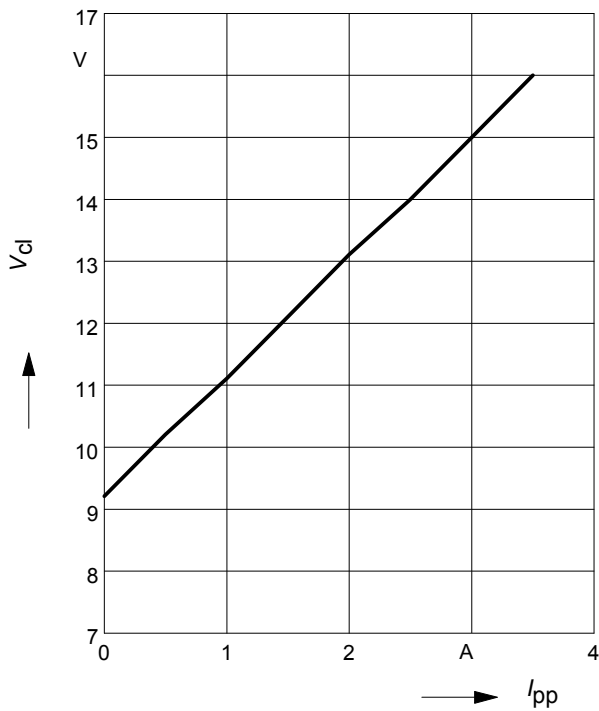

**Reverse current  $I_R = f(V_R)$**

$T_A = \text{Parameter}$

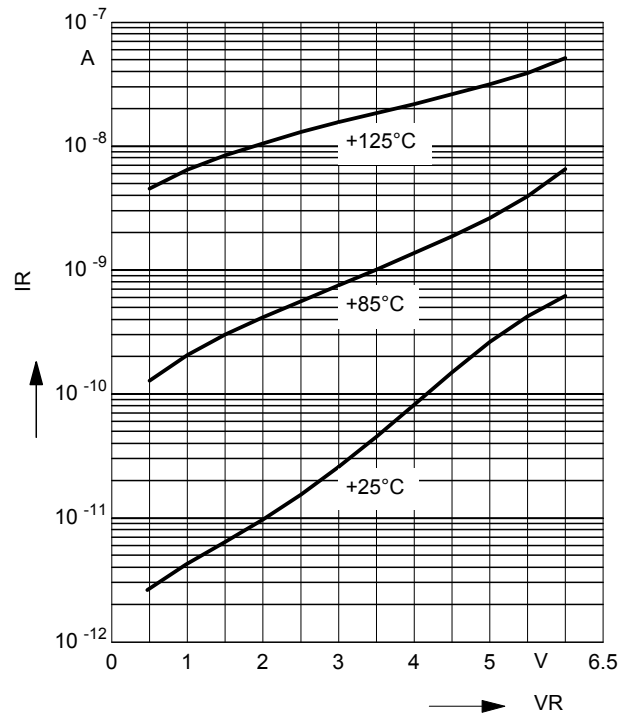

**Diode capacitance  $C_T = f(V_R)$**

$f = 1 \text{ MHz}$

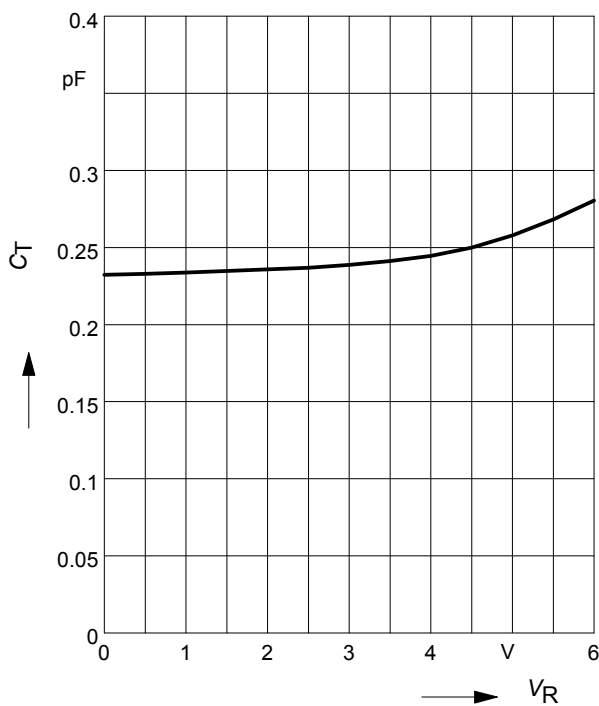

**Line capacitance  $C_T = f(f)$**

$V_R = \text{Parameter}$

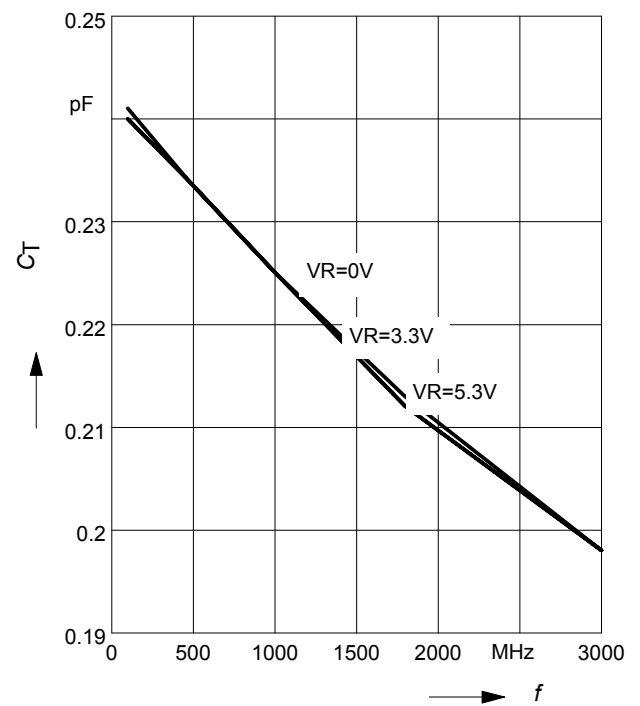

Line capacitance  $C_T = f(T_A)$

$V_R =$  Parameter,  $f = 1$  MHz

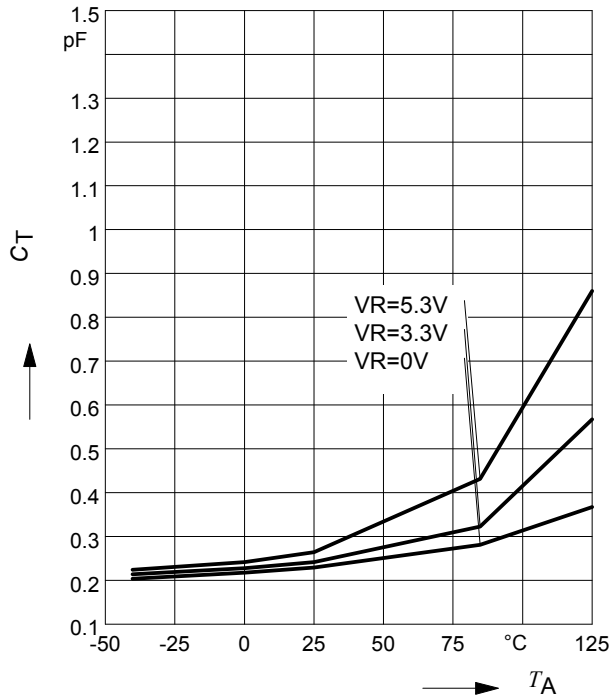

**Application example ESD0P2RF...**

1 line, bi-directional

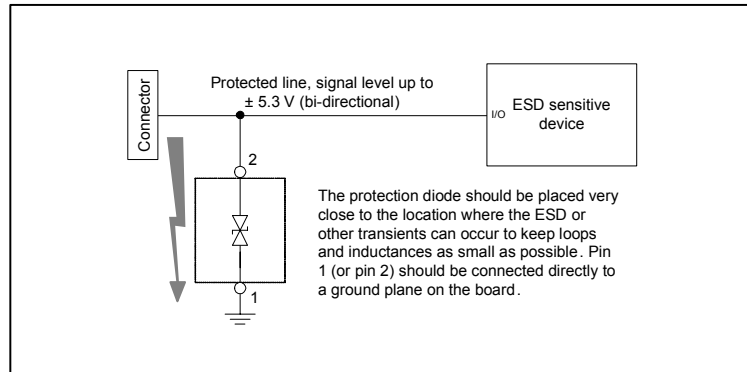

### Package Outline

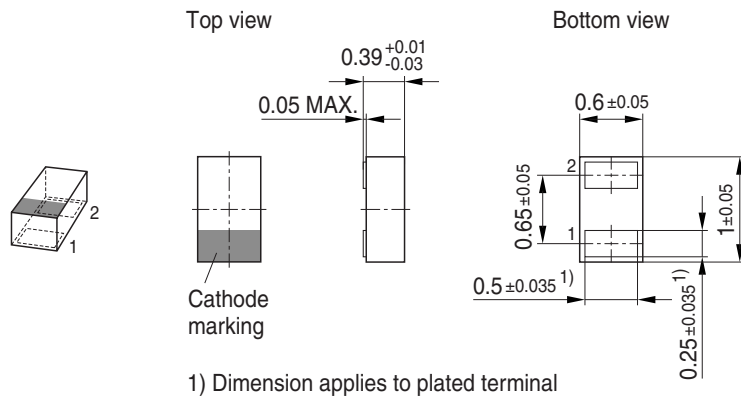

### Foot Print

For board assembly information please refer to Infineon website "Packages"

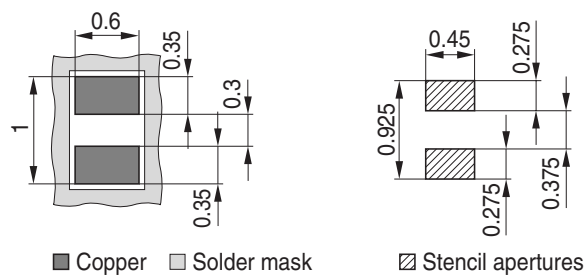

### Marking Layout (Example)

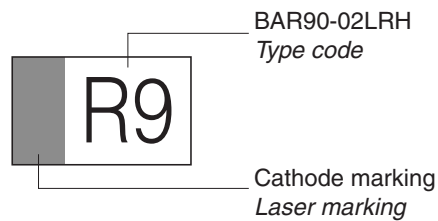

### Standard Packing

Reel  $\varnothing$ 180 mm = 15.000 Pieces/Reel  
 Reel  $\varnothing$ 330 mm = 50.000 Pieces/Reel (optional)

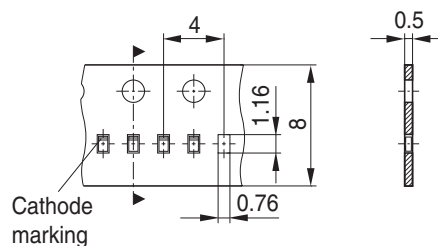

### Package Outline

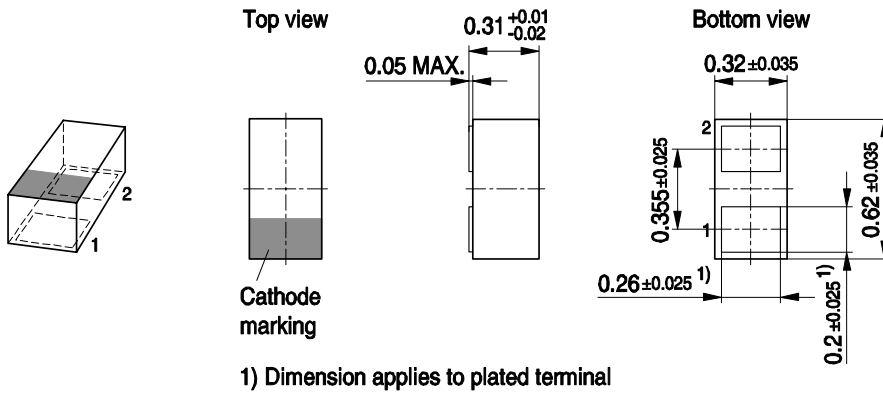

### Foot Print

For board assembly information please refer to Infineon website "Packages"

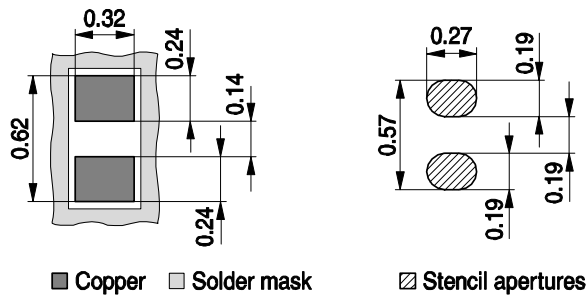

### Marking Layout (Example)

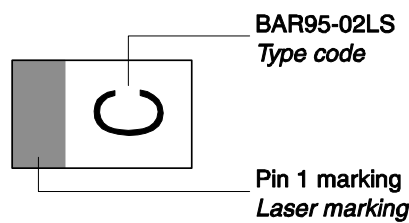

### Standard Packing

Reel ø180 mm = 15.000 Pieces/Reel

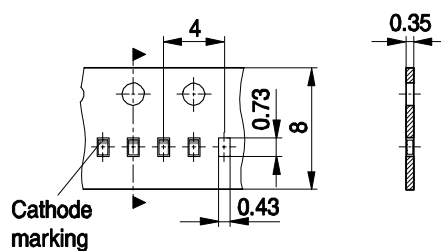

**Edition 2009-11-16**

**Published by  
Infineon Technologies AG  
81726 Munich, Germany**

**© 2009 Infineon Technologies AG  
All Rights Reserved.**

### **Legal Disclaimer**

The information given in this document shall in no event be regarded as a guarantee of conditions or characteristics. With respect to any examples or hints given herein, any typical values stated herein and/or any information regarding the application of the device, Infineon Technologies hereby disclaims any and all warranties and liabilities of any kind, including without limitation, warranties of non-infringement of intellectual property rights of any third party.

### **Information**

For further information on technology, delivery terms and conditions and prices, please contact the nearest Infineon Technologies Office ( [www.infineon.com](http://www.infineon.com) ).

### **Warnings**

Due to technical requirements, components may contain dangerous substances. For information on the types in question, please contact the nearest Infineon Technologies Office.

Infineon Technologies components may be used in life-support devices or systems only with the express written approval of Infineon Technologies, if a failure of such components can reasonably be expected to cause the failure of that life-support device or system or to affect the safety or effectiveness of that device or system. Life support devices or systems are intended to be implanted in the human body or to support and/or maintain and sustain and/or protect human life. If they fail, it is reasonable to assume that the health of the user or other persons may be endangered.