

Data Sheet

Description

The HPND-4028 and 4038 beam lead PIN diodes are designed for low capacitance, low resistance, and fast switching at microwave frequencies. These characteristics are achieved at low bias levels for minimal power consumption. Advanced processing techniques ensure uniform and consistent electrical performance, allowing guaranteed capacitance windows. This translates to improved performance in phased array applications.

Rugged construction and strong beams ensure high assembly yields while nitride passivation and polyimide coating ensure reliability.

Applications

These beam lead PIN diodes are designed for use in stripline, coplanar waveguide, or microstrip circuits. Applications include phase shifting and switching. The guaranteed capacitance windows ensure uniform performance in phased array radar. The low capacitance makes them ideal for circuits requiring high isolation in the series configuration. These devices have been fully characterized and S-parameters have been provided.

Maximum Ratings

Operating Temperature	-65°C to +150°C
Storage Temperature	-65°C to +200°C
Power Dissipation at $T_{CASE} = 25^{\circ}C$ (Derate linearly to zero at 150°C.)	250 mW
Minimum Lead Strength	4 grams pull on either lead per MIL-S-19500, LTPD = 20

Features

- Low Capacitance
0.025 pF Maximum at 1 MHz Guaranteed Min./Max.
- Fast Switching
2.0 nsec
- Low Resistance at Low Bias
1.5 Ω at IF = 10 mA (Typical)
- Rugged Construction
Typical 10 Gram Lead Pull
- Silicon Nitride Passivation

Outline 83

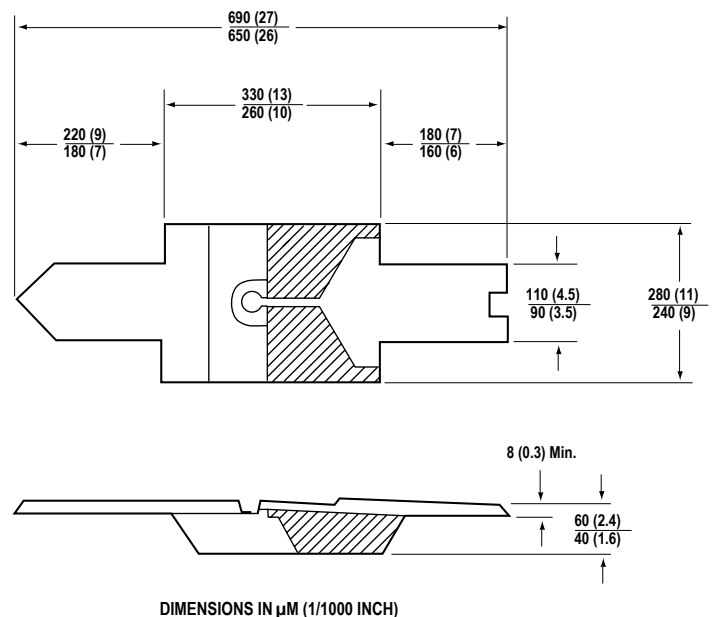

Electrical Specifications at TA = 25°C

Part Number	Capacitance (pF)		Series Resistance R_S (Ω)		Break-down Voltage V_{BR} (V)	Reverse Current I_R (nA)	Forward Voltage V_F (V)	Carrier Lifetime τ (ns)	Reverse Recovery t_{rr} (ns)	Series Resistance R_S (Ω)
	Min.	Max.	Typ.	Max.	Min.	Max.	Max.	Typ.	Typ.	Typ.
HPND-4028	0.025	0.045	2.3	3.0	60	100	1.1	36	2.6	2.0
HPND-4038	0.045	0.065	1.5	2.0	60	100	1.1	45	2.4	1.0
Test Conditions	$V_R = 30$ V $f = 1$ MHz		$I_F = 10$ mA $f = 100$ MHz		$V_R = V_{BR}$ Measure $I_R \leq 10$ mA	$V_R = 50$ V	$I_F = 20$ mA	$I_F = 10$ mA $I_R = 6$ mA	* $I_F = 10$ mA $I_F = 5$ mA $V_R = 10$ V	$I_F = 50$ mA $f = 100$ MHz 90% recovery

Typical Parameters

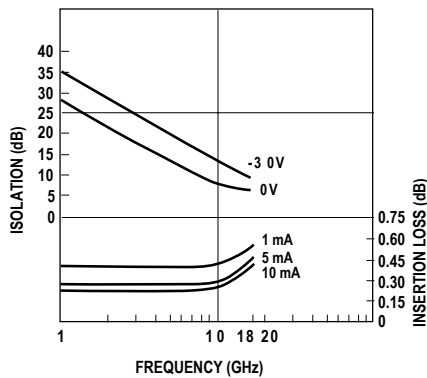

Figure 1. Typical Isolation and Insertion Loss, HPND-4028.

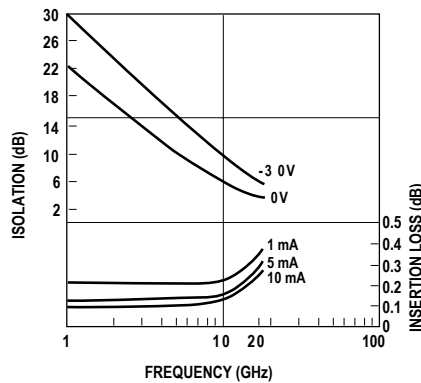

Figure 2. Typical Isolation and Insertion Loss, HPND-4038.

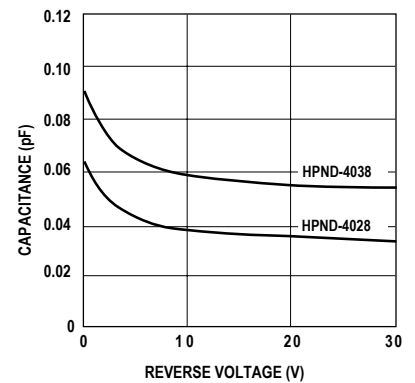

Figure 3. Typical Capacitance vs. Reverse Voltage (at 1 MHz).

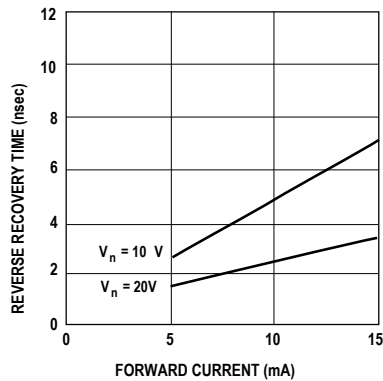

Figure 4. Typical Reverse Recovery Time vs. Forward Current (Series Configuration). HPND-4028, HPND-4038.

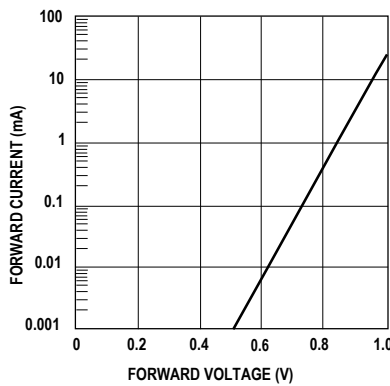

Figure 5. Typical Forward Characteristics.

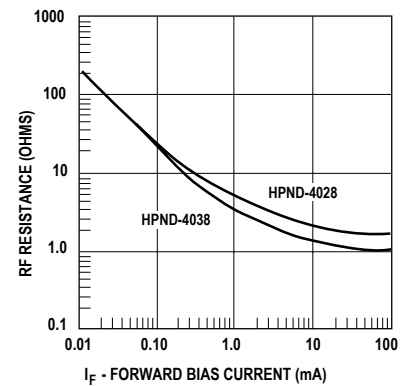

Figure 6. Typical RF Resistance vs. Forward Bias Current (at 100 MHz).

Typical S-Parameters (in series configuration) at $Z_0 = 50 \Omega$, 25°C
HPND-4028

Freq. (MHz)	$I_F = 1 \text{ mA}$						$I_F = 5 \text{ mA}$					$I_F = 10 \text{ mA}$				
	S_{11}/S_{22}			S_{21}/S_{12}			S_{11}/S_{22}		S_{21}/S_{12}			S_{11}/S_{22}		S_{21}/S_{12}		
	Mag.	Ang.	dB	Mag.	Ang.	Mag.	Ang.	dB	Mag.	Ang.	Mag.	Ang.	dB	Mag.	Ang.	
1000	0.046	7	-0.38	0.958	-1	0.031	17	-0.24	0.973	-1	0.027	19	-0.20	0.978	-1	
2000	0.048	20	-0.40	0.956	-2	0.036	33	-0.26	0.971	-2	0.033	37	-0.22	0.975	-2	
3000	0.052	29	-0.40	0.957	-4	0.041	43	-0.26	0.972	-4	0.040	47	-0.22	0.975	-4	
4000	0.058	36	-0.40	0.957	-5	0.049	49	-0.26	0.971	-5	0.047	53	-0.22	0.975	-5	
5000	0.063	42	-0.40	0.956	-6	0.057	54	-0.26	0.971	-6	0.055	58	-0.22	0.975	-6	
6000	0.069	46	-0.40	0.956	-7	0.064	57	-0.26	0.971	-7	0.063	60	-0.24	0.974	-7	
7000	0.075	48	-0.40	0.956	-8	0.070	60	-0.26	0.971	-8	0.070	62	-0.22	0.975	-8	
8000	0.081	50	-0.40	0.955	-9	0.077	60	-0.28	0.970	-9	0.076	63	-0.24	0.974	-9	
9000	0.087	51	-0.40	0.956	-11	0.084	61	-0.28	0.970	-11	0.083	63	-0.24	0.974	-11	
10000	0.092	52	-0.40	0.956	-12	0.089	61	-0.28	0.970	-12	0.089	63	-0.24	0.974	-12	
11000	0.097	53	-0.40	0.956	-13	0.095	61	-0.26	0.971	-13	0.095	63	-0.22	0.975	-13	
12000	0.103	52	-0.40	0.956	-14	0.101	60	-0.26	0.971	-14	0.101	62	-0.22	0.975	-14	
13000	0.107	51	-0.40	0.957	-15	0.106	59	-0.26	0.971	-15	0.105	62	-0.22	0.975	-15	
14000	0.112	51	-0.42	0.954	-17	0.110	59	-0.30	0.968	-17	0.111	61	-0.24	0.973	-17	
15000	0.119	51	-0.42	0.953	-18	0.117	58	-0.28	0.969	-18	0.117	60	-0.26	0.972	-18	
16000	0.123	51	-0.44	0.952	-19	0.122	57	-0.28	0.969	-19	0.123	60	-0.26	0.972	-19	
17000	0.129	49	-0.44	0.952	-20	0.130	56	-0.30	0.967	-20	0.129	57	-0.26	0.971	-20	
18000	0.139	48	-0.46	0.950	-22	0.139	55	-0.32	0.965	-21	0.140	56	-0.28	0.970	-22	

HPND-4028

Freq. (MHz)	$V_R = 0 \text{ V}$						$V_R = 10 \text{ V}$					$V_R = 30 \text{ V}$				
	S_{11}/S_{22}			S_{21}/S_{12}			S_{11}/S_{22}		S_{21}/S_{12}			S_{11}/S_{22}		S_{21}/S_{12}		
	Mag.	Ang.	dB	Mag.	Ang.	Mag.	Ang.	dB	Mag.	Ang.	Mag.	Ang.	dB	Mag.	Ang.	
1000	0.997	-4	-27.54	0.042	86	0.999	-3	-33.16	0.022	91	1.000	-2	-33.98	0.020	91	
2000	0.988	-7	-21.74	0.082	79	0.997	-6	-27.34	0.043	86	0.998	-5	-28.18	0.039	86	
3000	0.974	-11	-18.36	0.121	74	0.994	-8	-23.62	0.066	83	0.996	-7	-24.44	0.060	84	
4000	0.958	-14	-16.10	0.157	69	0.991	-10	-21.12	0.088	81	0.992	-10	-21.94	0.080	82	
5000	0.940	-17	-14.48	0.189	64	0.986	-13	-19.26	0.109	78	0.987	-13	-20.10	0.099	79	
6000	0.921	-21	-13.20	0.219	70	0.979	-16	-17.66	0.131	75	0.982	-15	-18.42	0.120	76	
7000	0.898	-24	-12.16	0.247	56	0.972	-19	-16.26	0.054	72	0.976	-18	-17.08	0.140	73	
8000	0.879	-26	-11.36	0.271	52	0.965	-21	-15.20	0.174	70	0.970	-21	-15.92	0.160	71	
9000	0.857	-29	-10.64	0.294	48	0.954	-24	-14.20	0.195	67	0.960	-23	-14.96	0.179	68	
10000	0.836	-32	-10.12	0.312	46	0.942	-27	-13.44	0.213	65	0.950	-26	-14.20	0.195	66	
11000	0.816	-35	-9.54	0.334	42	0.931	-30	-12.58	0.235	61	0.937	-29	-13.32	0.216	62	
12000	0.795	-37	-9.10	0.351	40	0.917	-33	-11.84	0.256	59	0.926	-32	-12.62	0.234	60	
13000	0.778	-40	-8.86	0.361	37	0.904	-36	-11.44	0.268	56	0.913	-34	-12.20	0.246	57	
14000	0.761	-42	-8.44	0.379	33	0.892	-38	-10.80	0.289	52	0.903	-37	-11.52	0.266	54	
15000	0.744	-44	-8.34	0.383	31	0.876	-41	-10.56	0.297	50	0.888	-39	-11.26	0.274	52	
16000	0.733	-46	-8.04	0.397	28	0.867	-43	-10.12	0.312	46	0.881	-42	-10.80	0.289	48	
17000	0.720	-48	-7.94	0.401	26	0.855	-45	-9.96	0.318	44	0.869	-44	-10.64	0.294	46	
18000	0.709	-50	-8.00	0.399	24	0.846	-47	-9.94	0.319	42	0.861	-46	-10.64	0.294	44	

Typical S-Parameters (in series configuration) at $Z_0 = 50 \Omega$, 25°C (cont.)

HPND-4038

Freq. (MHz)	$I_f = 1 \text{ mA}$						$I_f = 5 \text{ mA}$					$I_f = 10 \text{ mA}$				
	S_{11}/S_{22}			S_{21}/S_{12}			S_{11}/S_{22}			S_{21}/S_{12}		S_{11}/S_{22}			S_{21}/S_{12}	
	Mag.	Ang.	dB	Mag.	Ang.	Mag.	Ang.	dB	Mag.	Ang.	Mag.	Ang.	dB	Mag.	Ang.	
1000	0.028	15	-0.22	0.976	-1	0.019	28	-0.12	0.987	-1	0.017	35	-0.10	0.989	-1	
2000	0.032	34	-0.24	0.974	-2	0.026	50	-0.16	0.984	-2	0.024	56	-0.14	0.986	-2	
3000	0.037	47	-0.22	0.975	-3	0.034	61	-0.14	0.985	-3	0.033	66	-0.12	0.988	-4	
4000	0.045	55	-0.22	0.975	-5	0.042	67	-0.14	0.985	-5	0.042	70	-0.12	0.987	-5	
5000	0.052	61	-0.24	0.974	-6	0.051	72	-0.16	0.984	-6	0.051	75	-0.14	0.986	-6	
6000	0.060	65	-0.24	0.974	-7	0.059	74	-0.16	0.984	-7	0.059	77	-0.14	0.986	-7	
7000	0.067	67	-0.24	0.974	-8	0.067	76	-0.16	0.984	-8	0.067	78	-0.12	0.987	-8	
8000	0.073	69	-0.24	0.974	-9	0.074	76	-0.16	0.983	-9	0.073	78	-0.14	0.986	-9	
9000	0.081	70	-0.24	0.973	-10	0.081	77	-0.16	0.984	-10	0.081	78	-0.14	0.986	-10	
10000	0.087	71	-0.24	0.974	-11	0.088	77	-0.16	0.982	-11	0.089	79	-0.14	0.986	-11	
11000	0.092	71	-0.22	0.975	-12	0.094	77	-0.16	0.984	-12	0.094	79	-0.14	0.986	-12	
12000	0.099	70	-0.24	0.974	-14	0.100	76	-0.16	0.984	-14	0.101	77	-0.14	0.986	-14	
13000	0.104	70	-0.22	0.975	-15	0.106	75	-0.14	0.985	-15	0.107	76	-0.12	0.987	-15	
14000	0.110	69	-0.26	0.972	-16	0.112	74	-0.16	0.982	-16	0.113	75	-0.16	0.984	-16	
15000	0.118	67	-0.24	0.973	-17	0.119	72	-0.16	0.983	-17	0.120	73	-0.14	0.985	-17	
16000	0.123	66	-0.24	0.973	-18	0.125	71	-0.16	0.982	-18	0.126	72	-0.16	0.984	-18	
17000	0.132	64	-0.26	0.972	-19	0.133	68	-0.16	0.982	-19	0.133	69	-0.16	0.984	-19	
18000	0.141	62	-0.26	0.972	-20	0.143	66	-0.18	0.980	-20	0.143	67	-0.16	0.983	-20	

HPND-4038

Freq. (MHz)	$V_R = 0 \text{ V}$						$V_R = 10 \text{ V}$					$V_R = 30 \text{ V}$				
	S_{11}/S_{22}			S_{21}/S_{12}			S_{11}/S_{22}			S_{21}/S_{12}		S_{11}/S_{22}			S_{21}/S_{12}	
	Mag.	Ang.	dB	Mag.	Ang.	Mag.	Ang.	dB	Mag.	Ang.	Mag.	Ang.	dB	Mag.	Ang.	
1000	0.993	-5	-23.10	0.070	83	0.998	-3	-28.88	0.036	89	0.999	-3	-29.90	0.032	90	
2000	0.976	-10	-17.28	0.137	76	0.995	-7	-22.86	0.072	84	0.996	-6	-23.76	0.065	85	
3000	0.953	-15	-14.04	0.199	70	0.990	-10	-19.26	0.109	81	0.992	-9	-20.18	0.098	82	
4000	0.923	-19	-11.88	0.255	64	0.982	-13	-16.78	0.145	78	0.986	-12	-17.74	0.130	79	
5000	0.890	-23	-10.36	0.304	58	0.973	-16	-14.90	0.180	74	0.977	-15	-15.88	0.161	75	
6000	0.857	-27	-9.20	0.347	53	0.962	-20	-13.40	0.214	71	0.968	-19	-14.30	0.193	73	
7000	0.822	-31	-8.28	0.386	49	0.947	-23	-12.08	0.249	68	0.956	-22	-12.96	0.225	69	
8000	0.790	-34	-7.58	0.418	45	0.933	-27	-11.06	0.280	65	0.945	-25	-11.92	0.254	66	
9000	0.757	-38	-7.00	0.447	41	0.915	-30	-10.12	0.312	61	0.928	-29	-10.94	0.284	63	
10000	0.727	-41	-6.54	0.471	38	0.897	-34	-9.40	0.339	58	0.912	-32	-10.22	0.309	61	
11000	0.697	-44	-6.10	0.496	34	0.877	-37	-8.62	0.371	54	0.892	-35	-9.44	0.338	57	
12000	0.668	-46	-5.74	0.517	32	0.854	-41	-8.00	0.399	52	0.874	-38	-8.76	0.365	54	
13000	0.643	-49	-5.56	0.528	29	0.834	-44	-7.60	0.417	49	0.854	-42	-8.34	0.383	51	
14000	0.620	-51	-5.22	0.549	26	0.813	-47	-7.04	0.445	45	0.839	-45	-7.76	0.410	48	
15000	0.599	-53	-5.16	0.553	24	0.793	-50	-6.82	0.457	43	0.818	-48	-7.50	0.422	45	
16000	0.584	-55	-4.90	0.569	21	0.778	-53	-6.42	0.478	39	0.805	-50	-7.10	0.442	42	
17000	0.570	-57	-4.80	0.576	19	0.762	-55	-6.22	0.489	37	0.790	-53	-6.88	0.453	40	
18000	0.556	-59	-4.84	0.574	17	0.747	-58	-6.18	0.491	35	0.776	-55	-6.86	0.454	37	

Bonding and Handling Procedures for Beam Lead Diodes

1. Storage

Under normal circumstances, storage of beam lead diodes in Avago supplied waffle/gel packs is sufficient. In particularly dusty or chemically hazardous environments, storage in an inert atmosphere desiccator is advised.

2. Handling

In order to avoid damage to beam lead devices, particular care must be exercised during inspection, testing, and assembly. Although the beam lead diode is designed to have exceptional lead strength, its small size and delicate nature requires that special handling techniques be observed so that the devices will not be mechanically or electrically damaged. A vacuum pickup is recommended for picking up beam lead devices, particularly larger ones, e.g., quads. Care must be exercised to assure that the vacuum opening of the needle is sufficiently small to avoid passage of the device through the opening. A #27 tip is recommended for picking up single beam lead devices. A 20X magnification is needed for precise positioning of the tip on the device. Where a vacuum pickup is not used, a sharpened wooden Q-tip dipped in isopropyl alcohol is very commonly used to handle beam lead devices.

3. Cleaning

For organic contamination use a warm rinse of trichloroethane, or its locally approved equivalent, followed by a cold rinse in acetone and methanol. Dry under infrared heat lamp for 5–10 minutes on clean filter paper. Freon degreaser, or its locally approved equivalent, may replace trichloroethane for light organic contamination.

- Ultrasonic cleaning is not recommended.
- Acid solvents should not be used.

4. Bonding

Thermocompression: See Application Note 979 "The Handling and Bonding of Beam Lead Devices Made Easy". This method is good for hard substrates only.

Wobble: This method picks up the device, places it on the substrate and forms a thermo-compression bond all in one operation. This is described in the latest version of MIL-STD-883, Method 2017, and is intended for hard substrates only.

Resistance Welding or Parallel-GAP Welding: To make welding on soft substrates easier, a low pressure welding head is recommended. Suitable equipment is available from HUGHES, Industrial Products Division in Carlsbad, CA.

Epoxy: With solvent free, low resistivity epoxies (available from ABLESTIK and improvements in dispensing equipment, the quality of epoxy bonds is sufficient for many applications.

5. Lead Stress

In the process of bonding a beam lead diode, a certain amount of "bugging" occurs. The term bugging refers to the chip lifting away from the substrate during the bonding process due to the deformation of the beam by the bonding tool. This effect is beneficial as it provides stress relief for the diode during thermal cycling of the substrate. The coefficient of expansion of some substrate materials, specifically soft substrates, is such that some bugging is essential if the circuit is to be operated over wide temperature extremes.

Thick metal clad ground planes restrict the thermal expansion of the dielectric substrates in the X-Y axis. The expansion of the dielectric will then be mainly in the Z axis, which does not affect the beam lead device. An alternate solution to the problem of dielectric ground plane expansion is to heat the substrate to the maximum required operating temperature during the beam lead attachment. Thus, the substrate is at maximum expansion when the device is bonded. Subsequent cooling of the substrate will cause bugging, similar to bugging in thermocompression bonding or epoxy bonding. Other methods of bugging are preforming the leads during assembly or prestressing the substrate.

For product information and a complete list of distributors, please go to our web site: www.avagotech.com

Avago, Avago Technologies, and the A logo are trademarks of Avago Technologies Limited in the United States and other countries.
Data subject to change. Copyright © 2006 Avago Technologies Limited. All rights reserved. Obsoletes 5967-6157E
AV01-0594EN - October 20, 2006

