

IRF6648

DirectFET™ Power MOSFET ②

- RoHs Compliant Containing No Lead and Bromide ①
- Low Profile (<0.7 mm)
- Dual Sided Cooling Compatible ①
- Ultra Low Package Inductance
- Optimized for High Frequency Switching ①
- Optimized for Synchronous Rectification for 5V to 12V outputs
- Ideal for 24V input Primary Side Forward Converters
- Low Conduction Losses
- Compatible with Existing Surface Mount Techniques ①

Typical values (unless otherwise specified)

V_{DSS}	V_{GS}	$R_{DS(on)}$	$Q_{g\ tot}$	Q_{gd}
60V max	±20V max	5.5mΩ @ 10V	36nC	14nC

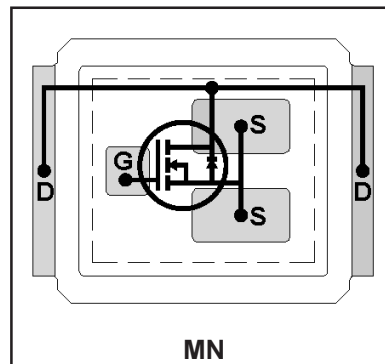

Applicable DirectFET Outline and Substrate Outline (see p.7,8 for details)①

SH	SJ	SP		MZ	MN				
----	----	----	--	----	-----------	--	--	--	--

Description

The IRF6648 combines the latest HEXFET® power MOSFET silicon technology with advanced DirectFET™ packaging to achieve the lowest on-state resistance in a package that has the footprint of an SO-8 and only 0.7 mm profile. The DirectFET package is compatible with existing layout geometries used in power applications, PCB assembly equipment and vapor phase, infra-red or convection soldering techniques, when application note AN-1035 is followed regarding the manufacturing methods and processes. The DirectFET package allows dual sided cooling to maximize thermal transfer in power systems, improving previous best thermal resistance by 80%.

The IRF6648 is an optimized switch for use in synchronous rectification circuits with 5-12Vout, and is also ideal for use as a primary side switch in 24Vin forward converters. The reduced total losses in the device coupled with the high level of thermal performance enables high efficiency and low temperatures, which are key for system reliability improvements, and makes this device ideal for high performance isolated DC-DC converters.

Absolute Maximum Ratings

	Parameter	Max.	Units
V_{DS}	Drain-to-Source Voltage	60	V
V_{GS}	Gate-to-Source Voltage	±20	
$I_D @ T_C = 25^\circ C$	Continuous Drain Current, $V_{GS} @ 10V$ ④	86	A
$I_D @ T_C = 70^\circ C$	Continuous Drain Current, $V_{GS} @ 10V$ ④	69	
I_{DM}	Pulsed Drain Current ③	260	
$I_S @ T_C = 25^\circ C$	Continuous Source Current (Body Diode) ④	81	
$I_S @ T_C = 70^\circ C$	Continuous Source Current (Body Diode) ④	52	
I_{SM}	Pulsed Source Current (Body Diode) ③	260	

Notes:

① Click on this section to link to the appropriate technical paper.

② Click on this section to link to the DirectFET Website.

③ Repetitive rating; pulse width limited by max. junction temperature.

④ T_C measured with thermocouple mounted to top (Drain) of part.

Electrical Characteristic @ $T_J = 25^\circ\text{C}$ (unless otherwise specified)

	Parameter	Min.	Typ.	Max.	Units	Conditions
BV_{DSS}	Drain-to-Source Breakdown Voltage	60	—	—	V	$V_{GS} = 0V, I_D = 250\mu A$
$\Delta BV_{DSS}/\Delta T_J$	Breakdown Voltage Temp. Coefficient	—	0.076	—	V/ $^\circ\text{C}$	Reference to 25°C , $I_D = 1\text{mA}$
$R_{DS(on)}$	Static Drain-to-Source On-Resistance	—	5.5	7.0	m Ω	$V_{GS} = 10V, I_D = 17A$ ⑤
$V_{GS(th)}$	Gate Threshold Voltage	3.0	4.0	4.9	V	$V_{DS} = V_{GS}, I_D = 150\mu A$
$\Delta V_{GS(th)}/\Delta T_J$	Gate Threshold Voltage Coefficient	—	-11	—	mV/ $^\circ\text{C}$	
I_{DSS}	Drain-to-Source Leakage Current	—	—	20	μA	$V_{DS} = 60V, V_{GS} = 0V$
		—	—	250		$V_{DS} = 48V, V_{GS} = 0V, T_J = 125^\circ\text{C}$
I_{GSS}	Gate-to-Source Forward Leakage	—	—	100	nA	$V_{GS} = 20V$
	Gate-to-Source Reverse Leakage	—	—	-100		$V_{GS} = -20V$
g_{fs}	Forward Transconductance	31	—	—	S	$V_{DS} = 10V, I_D = 17A$
Q_g	Total Gate Charge	—	36	50	nC	$V_{DS} = 30V$ $V_{GS} = 10V$ $I_D = 17A$ See Fig. 14
Q_{gs1}	Pre-Vth Gate-to-Source Charge	—	7.5	—		
Q_{gs2}	Post-Vth Gate-to-Source Charge	—	2.7	—		
Q_{gd}	Gate-to-Drain Charge	—	14	21		
Q_{godr}	Gate Charge Overdrive	—	12	—		
Q_{sw}	Switch Charge ($Q_{gs2} + Q_{gd}$)	—	17	—		
Q_{oss}	Output Charge	—	21	—	nC	$V_{DS} = 16V, V_{GS} = 0V$
R_G (Internal)	Gate Resistance	—	1.0	—	Ω	
$t_{d(on)}$	Turn-On Delay Time	—	16	—	ns	$V_{DD} = 30V, V_{GS} = 10V$ ⑤ $I_D = 17A$ $R_G = 6.2\Omega$ See Fig. 16
t_r	Rise Time	—	29	—		
$t_{d(off)}$	Turn-Off Delay Time	—	28	—		
t_f	Fall Time	—	13	—		
C_{iss}	Input Capacitance	—	2120	—	pF	$V_{GS} = 0V$ $V_{DS} = 25V$ $f = 1.0\text{MHz}$ $V_{GS} = 0V, V_{DS} = 1.0V, f = 1.0\text{MHz}$ $V_{GS} = 0V, V_{DS} = 48V, f = 1.0\text{MHz}$
C_{oss}	Output Capacitance	—	600	—		
C_{rss}	Reverse Transfer Capacitance	—	170	—		
C_{oss}	Output Capacitance	—	2450	—		
C_{oss}	Output Capacitance	—	440	—		

Avalanche Characteristics

	Parameter	Min.	Typ.	Max.	Units	Conditions
E_{AS}	Single Pulse Avalanche Energy	—	—	47	mJ	$T_J = 25^\circ\text{C}, I_S = 34A, R_G = 25\Omega$ $L = 0.082\text{mH}$. See Fig. 13

Diode Characteristics

	Parameter	Min.	Typ.	Max.	Units	Conditions
V_{SD}	Diode Forward Voltage	—	—	1.3	V	$T_J = 25^\circ\text{C}, I_S = 17A, V_{GS} = 0V$ ⑤
t_{rr}	Reverse Recovery Time	—	31	47	ns	$T_J = 25^\circ\text{C}, I_F = 17A, V_{DD} = 30V$
Q_{rr}	Reverse Recovery Charge	—	37	56	nC	$di/dt = 100A/\mu s$ ⑤

Notes:

⑤ Pulse width $\leq 400\mu s$; duty cycle $\leq 2\%$.

Absolute Maximum Ratings

	Parameter	Max.	Units
$P_D @ T_A = 25^\circ\text{C}$	Power Dissipation ⑥	2.8	W
$P_D @ T_A = 70^\circ\text{C}$	Power Dissipation ⑥	1.8	
$P_D @ T_C = 25^\circ\text{C}$	Power Dissipation ④	89	
T_P	Peak Soldering Temperature	270	°C
T_J	Operating Junction and	-40 to +150	
T_{STG}	Storage Temperature Range		

Thermal Resistance

	Parameter	Typ.	Max.	Units
$R_{\theta JA}$	Junction-to-Ambient ⑥⑧	—	45	°C/W
$R_{\theta JA}$	Junction-to-Ambient ⑦⑧	12.5	—	
$R_{\theta JC}$	Junction-to-Case ④⑧	—	1.4	
$R_{\theta J-PCB}$	Junction-to-PCB Mounted	1.0	—	

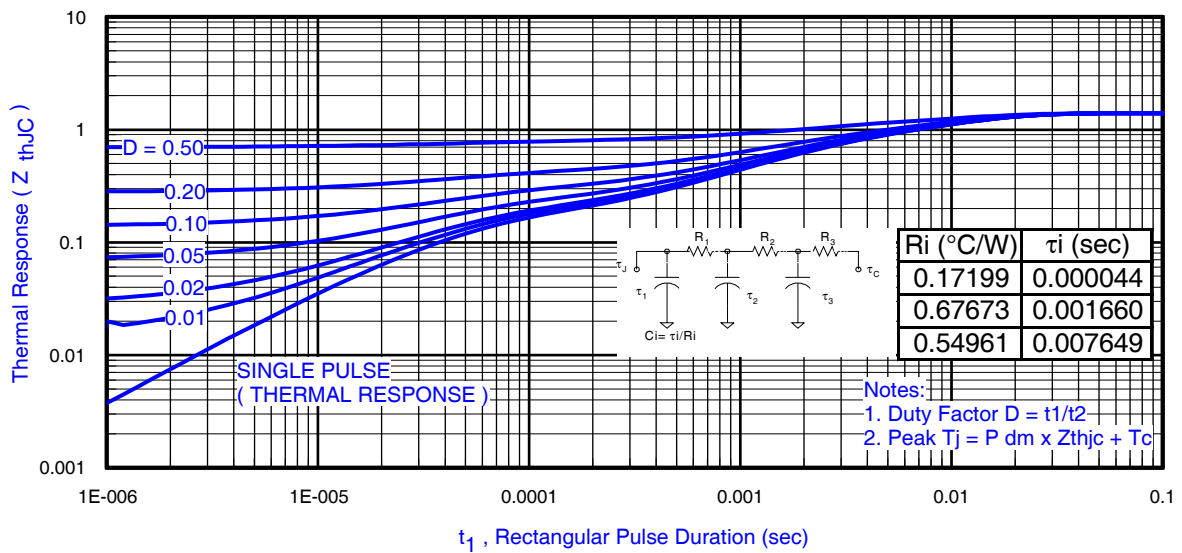

Fig 1. Maximum Effective Transient Thermal Impedance, Junction-to-Case ①

Notes:

- ⑥ Surface mounted on 1 in. square Cu, steady state (still air).
- ⑦ Used double sided cooling, mounted on 1 in. square Cu board PCB with small clip heatsink (still air).
- ⑧ R_{θ} is measured at T_J of approximately 90°C .



Note ⑥

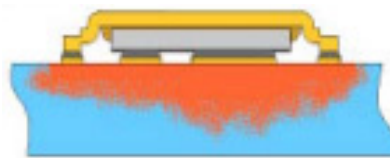

Note ⑦



Note ⑧

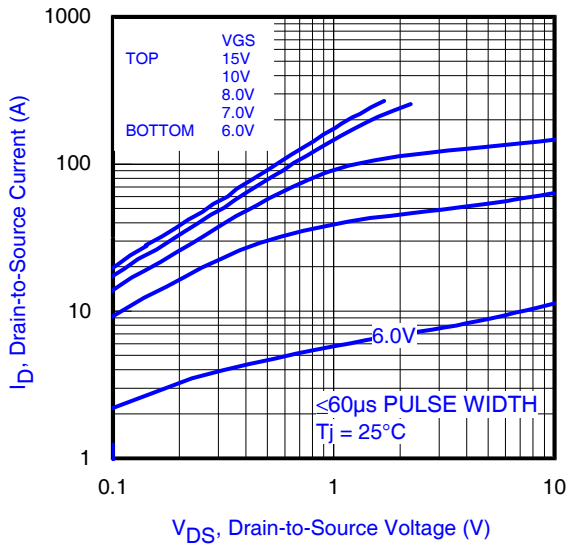

Fig 2. Typical Output Characteristics

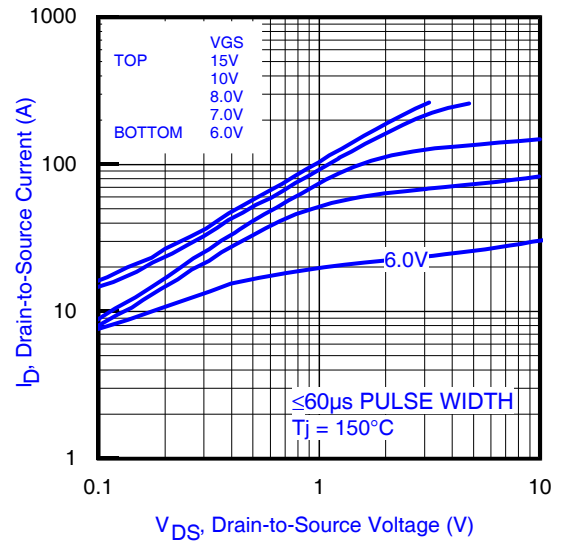

Fig 3. Typical Output Characteristics

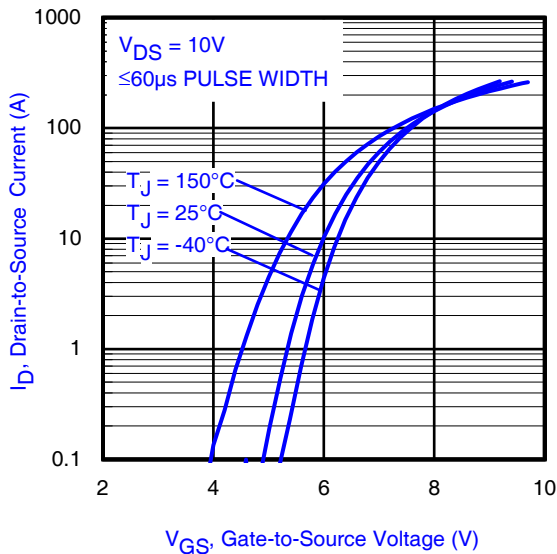

Fig 4. Typical Transfer Characteristics

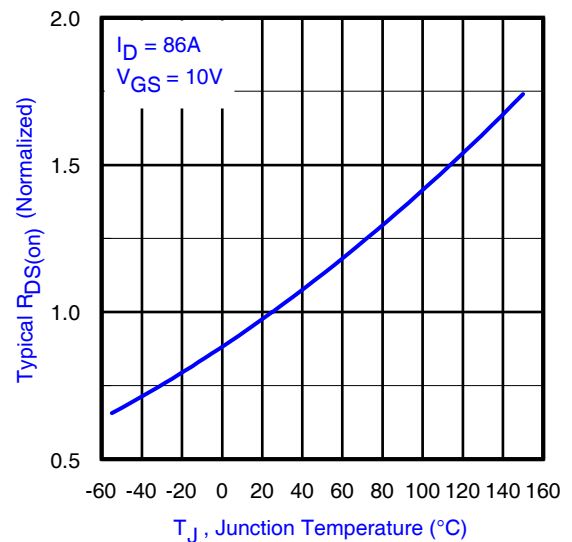

Fig 5. Normalized On-Resistance vs. Temperature

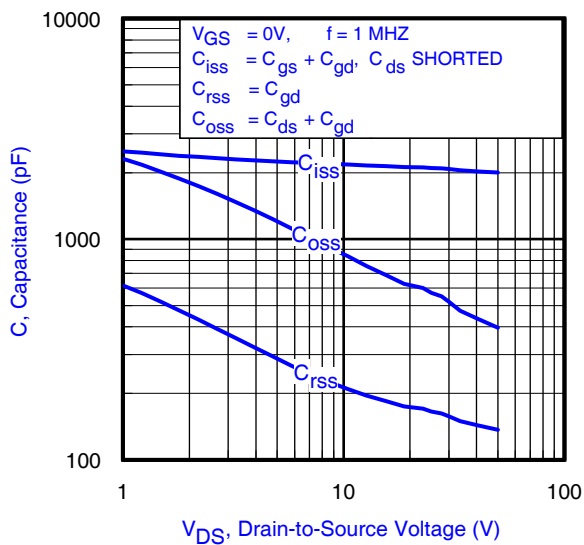

Fig 6. Typical Capacitance vs. Drain-to-Source Voltage

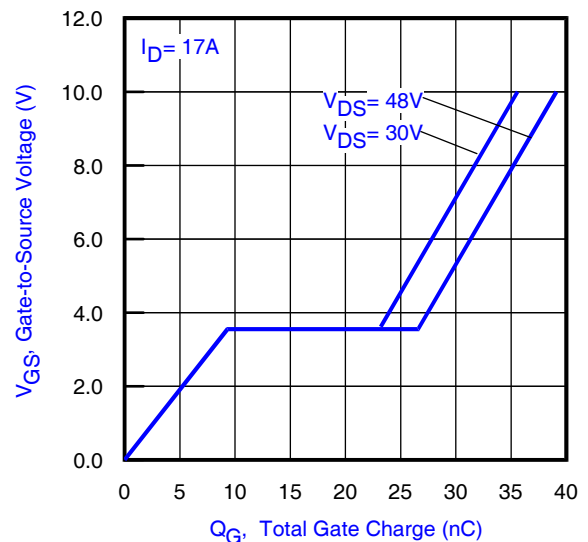

Fig 7. Typical Total Gate Charge vs. Gate-to-Source Voltage

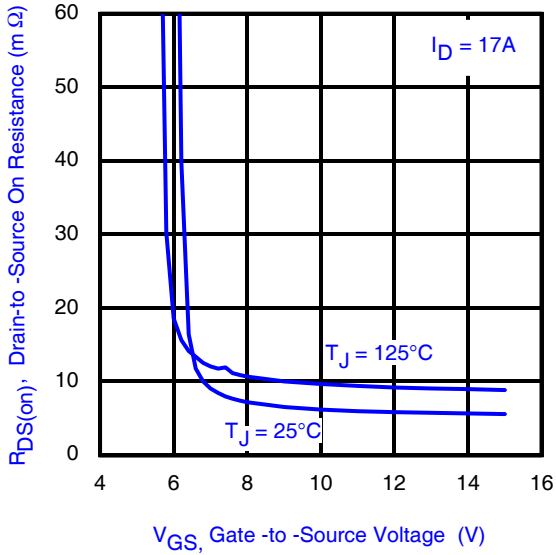

Fig 8. Typical On-Resistance vs. Gate Voltage

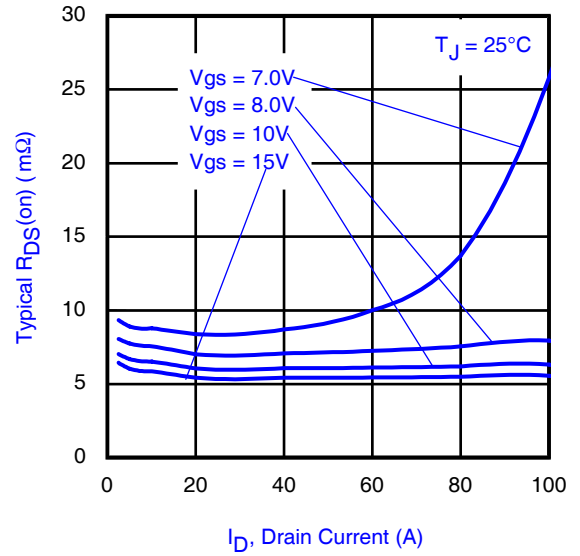

Fig 9. Typical On-Resistance vs. Drain Current

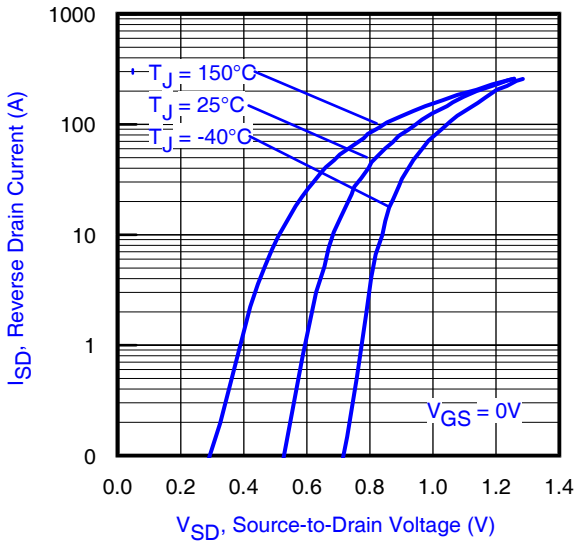

Fig 10. Typical Source-Drain Diode Forward Voltage

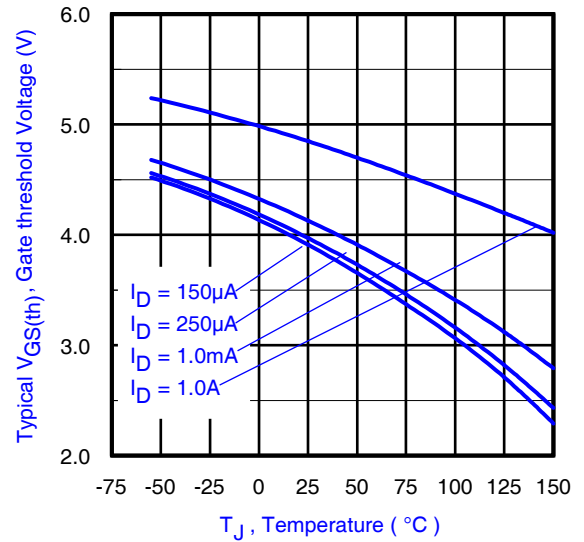

Fig 11. Typical Threshold Voltage vs. Junction Temperature

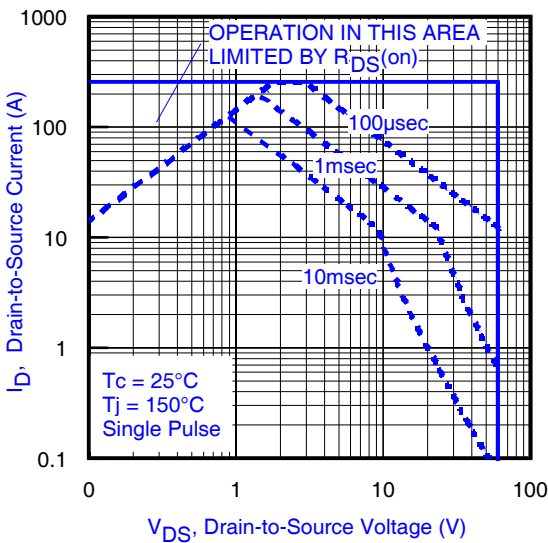

Fig 12. Maximum Safe Operating Area

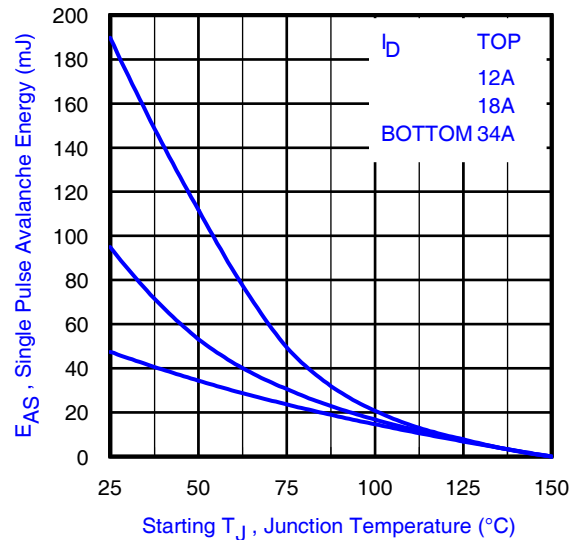

Fig 13. Maximum Avalanche Energy vs. Drain Current

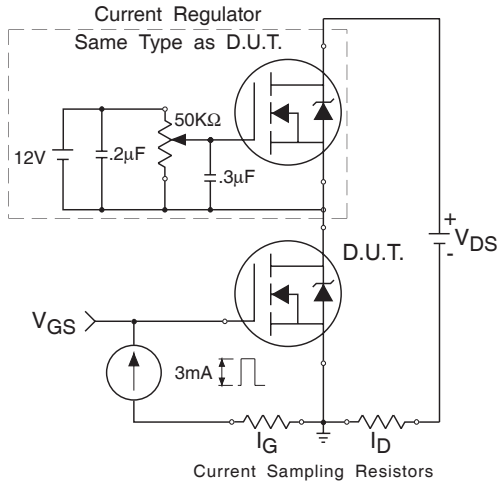

Fig 14a. Gate Charge Test Circuit

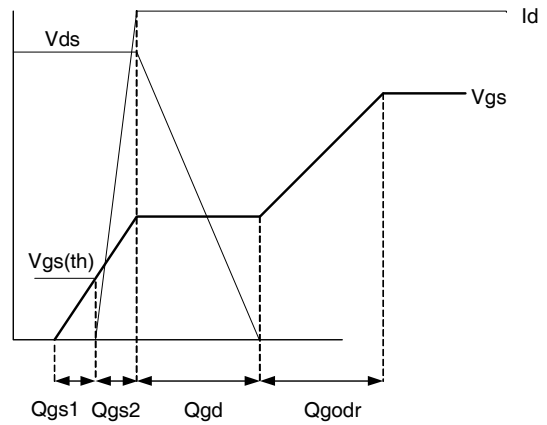

Fig 14b. Gate Charge Waveform

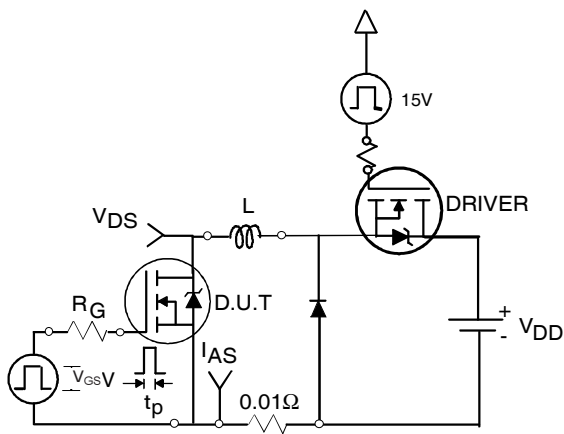

Fig 15a. Unclamped Inductive Test Circuit

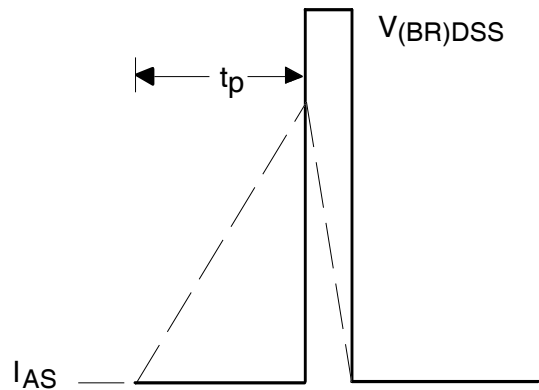

Fig 15b. Unclamped Inductive Waveforms

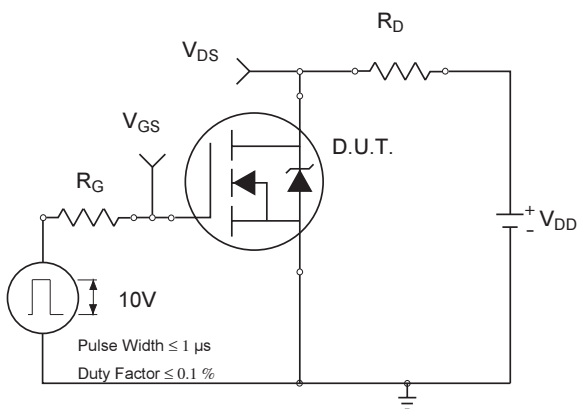

Fig 16a. Switching Time Test Circuit

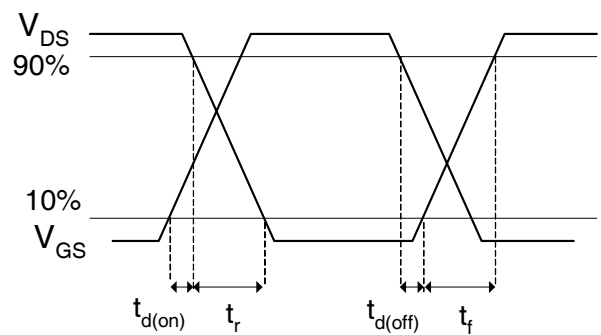

Fig 16b. Switching Time Waveforms

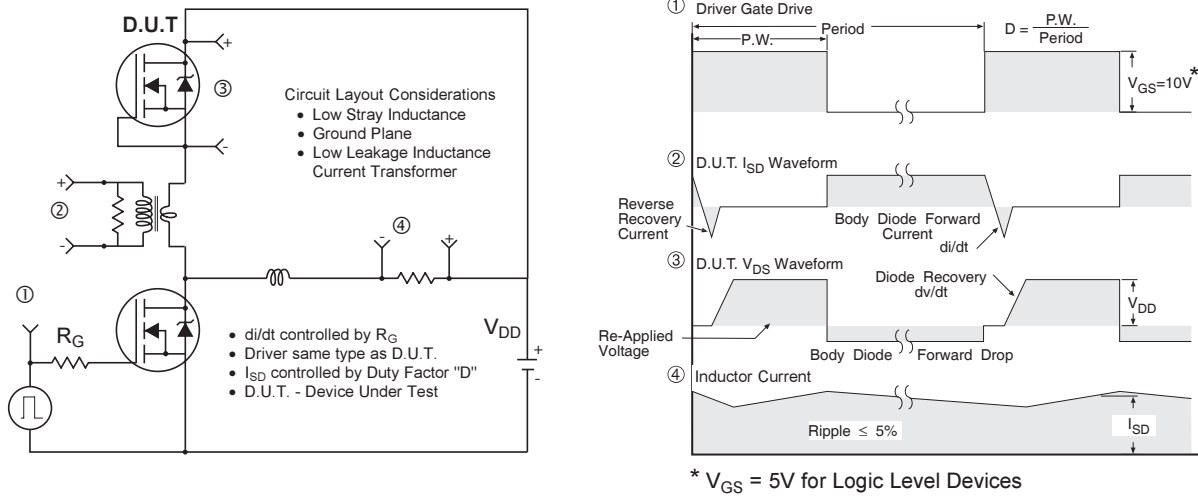
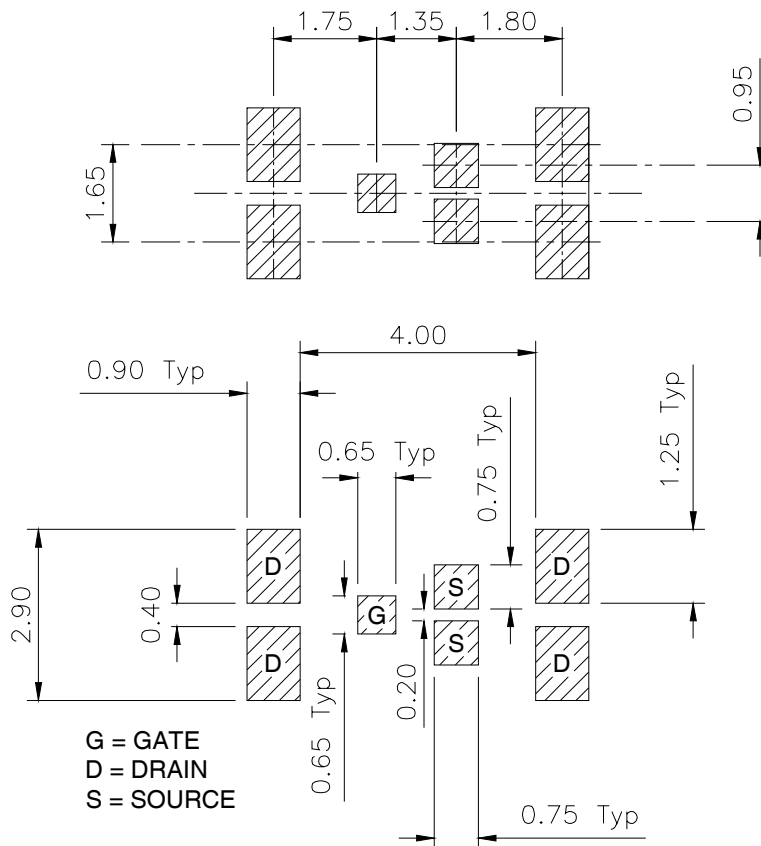

Fig 17. Diode Reverse Recovery Test Circuit for N-Channel HEXFET® Power MOSFETs

DirectFET™ Substrate and PCB Layout, MN Outline (Medium Size Can, N-Designation).

Please see DirectFET application note AN-1035 for all details regarding the assembly of DirectFET.

This includes all recommendations for stencil and substrate designs.



IRF6648

DirectFET™ Outline Dimension, MN Outline (Medium Size Can, N-Designation).

Please see DirectFET application note AN-1035 for all details regarding the assembly of DirectFET.

This includes all recommendations for stencil and substrate designs.

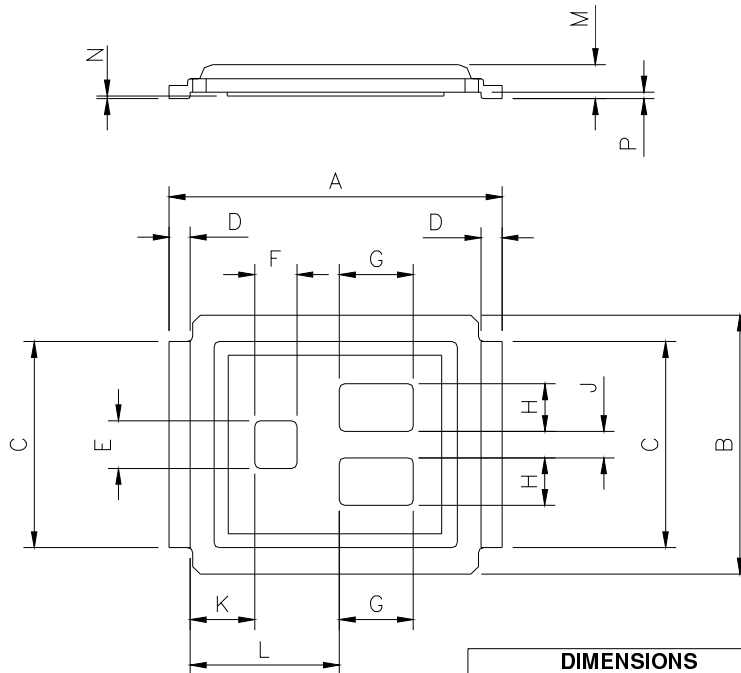

**NOTE: CONTROLLING
DIMENSIONS ARE IN MM**

DIMENSIONS				
	METRIC		IMPERIAL	
CODE	MIN	MAX	MIN	MAX
A	6.25	6.35	0.246	0.250
B	4.80	5.05	0.189	0.201
C	3.85	3.95	0.152	0.156
D	0.35	0.45	0.014	0.018
E	0.88	0.92	0.034	0.036
F	0.78	0.82	0.031	0.032
G	1.38	1.42	0.054	0.056
H	0.88	0.92	0.034	0.036
J	0.48	0.52	0.002	0.020
K	1.16	1.29	0.046	0.051
L	2.74	2.91	0.109	0.115
M	0.59	0.70	0.023	0.028
N	0.03	0.08	0.001	0.003
P	0.17	0.07	0.007	0.003

DirectFET™ Part Marking

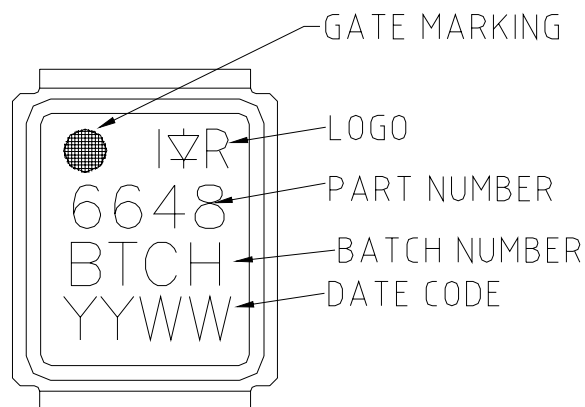

DirectFET™ Tape & Reel Dimension (Showing component orientation).

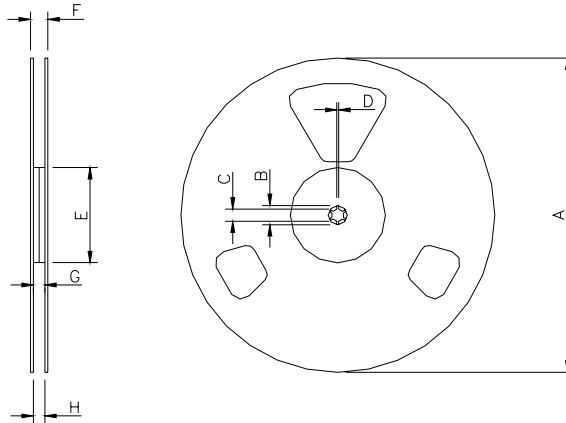

NOTE: Controlling dimensions in mm
 Std reel quantity is 4800 parts. (ordered as IRF6648). For 1000 parts on 7" reel,
 order IRF6648TR1

REEL DIMENSIONS								
CODE	STANDARD OPTION (QTY 4800)				TR1 OPTION (QTY 1000)			
	METRIC		IMPERIAL		METRIC		IMPERIAL	
A	330.0	N.C	12.992	N.C	177.77	N.C	6.9	N.C
B	20.2	N.C	0.795	N.C	19.06	N.C	0.75	N.C
C	12.8	13.2	0.504	0.520	13.5	12.8	0.53	0.50
D	1.5	N.C	0.059	N.C	1.5	N.C	0.059	N.C
E	100.0	N.C	3.937	N.C	58.72	N.C	2.31	N.C
F	N.C	18.4	N.C	0.724	N.C	13.50	N.C	0.53
G	12.4	14.4	0.488	0.567	11.9	12.01	0.47	N.C
H	11.9	15.4	0.469	0.606	11.9	12.01	0.47	N.C

Loaded Tape Feed Direction

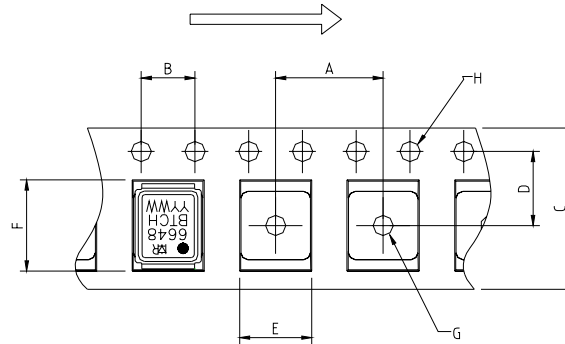

NOTE: CONTROLLING DIMENSIONS IN MM

CODE	DIMENSIONS			
	METRIC		IMPERIAL	
A	7.90	8.10	0.311	0.319
B	3.90	4.10	0.154	0.161
C	11.90	12.30	0.469	0.484
D	5.45	5.55	0.215	0.219
E	5.10	5.30	0.201	0.209
F	6.50	6.70	0.256	0.264
G	1.50	N.C	0.059	N.C
H	1.50	1.60	0.059	0.063

Data and specifications subject to change without notice.
 This product has been designed and qualified for the Consumer market.
 Qualification Standards can be found on IR's Web site.