

DC MOTOR SPEED CONTROLLER

The KA2404 is a monolithic integrated circuit designed for DC motor speed controllers.

FEATURES

- Suitable for DC motor speed controllers of cassette tape recorders and radio cassettes.
- Excellent stability of each characteristics against ambient temperature.
- High output current.
- Low quiescent current (1.3mA: typ).
- Low reference voltage.
- Wide operating supply voltage range ($V_{CC} = 4V \sim 12V$)
- KA2404A: TO-126 PKG type

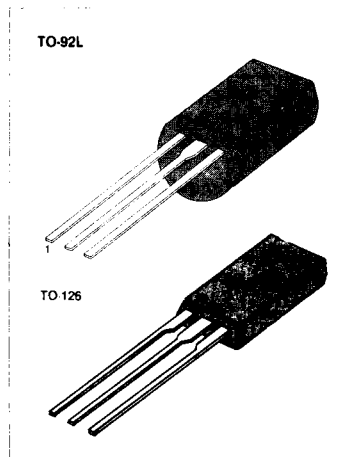

3

EQUIVALENT CIRCUIT BLOCK DIAGRAM

ORDERING INFORMATION

Device	Package	Operating Temperature
KA2404	TO-92L	-20°C ~ +70°C
KA2404A	TO-126	

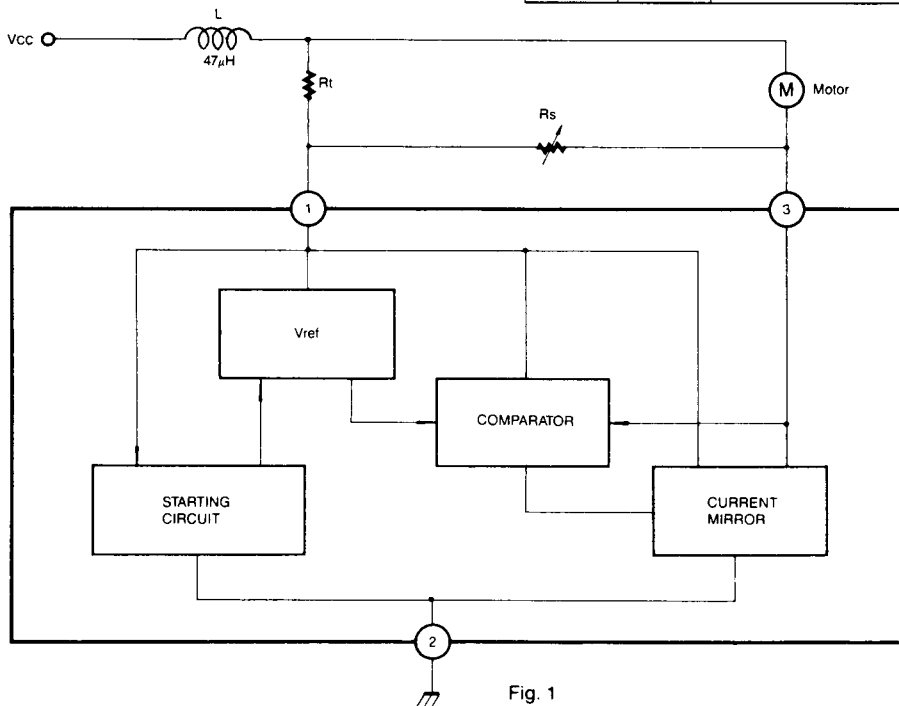

Fig. 1

ABSOLUTE MAXIMUM RATINGS (Ta = 25°C)

Characteristics	Symbol	Value	Unit
Supply Voltage	V _{CC}	16	V
Circuit Current	I ₃	2 (Note 1)	A
Power Dissipation (TO-126)	P _D (TO-92L) 1.3 (Note 2)	800 W	mW
Operating Temperature	T _{OPR}	-20 ~ +70	°C
Storage Temperature	T _{STG}	-40 ~ +125	°C

Note 1: 5 > 5 sec

Note 2: Ta = 25°C, with a 100 × 100mm bakelite printed circuit board (35μ Cu leaf)

ELECTRICAL CHARACTERISTICS

(Ta = 25°C, V_{CC} = 9V, unless otherwise specified)

Characteristic	Symbol	Test Conditions	Min	Typ	Max	Unit	Fig
Reference Voltage	V _{REF}	I ₃ = 10mA	1.10	1.27	1.40	V	2
Quiescent Circuit Current	I _{CCQ}	R _m = 180Ω	0.8	1.3	1.8	mA	4
Current Coefficient	K	R _{m1} = 44Ω R _{m2} = 33Ω	16	18	20		3
Voltage Characteristic of Current Coefficient	$\frac{\Delta K}{K} / \Delta V_{CC}$	I ₃ = 100mA V _{CC} = 4 ~ 12V		0.4		%/V	3
Voltage Characteristic of Reference Voltage	$\frac{\Delta V_{REF}}{V_{REF}} / \Delta V_{CC}$	I ₃ = 100mA V _{CC} = 4 ~ 12V		0.06		%/V	2
Current Characteristic of Current Coefficient	$\frac{\Delta K}{K} / \Delta I_3$	I ₃ = 30 ~ 200mA		-0.02		%/mA	3
Current Characteristic of Reference Voltage	$\frac{\Delta V_{REF}}{V_{REF}} / \Delta I_3$	I ₃ = 30 ~ 200mA		-0.02		%/mA	2
Temperature Characteristics of Current Coefficient	$\frac{\Delta K}{K} / \Delta T_a$	I ₃ = 100mA T _a = -20 ~ +75°C		0.01		%/°C	3
Temperature Characteristics of Reference Voltage	$\frac{\Delta V_{REF}}{V_{REF}} / \Delta T_a$	I ₃ = 100mA T _a = -20 ~ +75°C		0.01		%/°C	2

TEST CIRCUIT 1
Reference Voltage

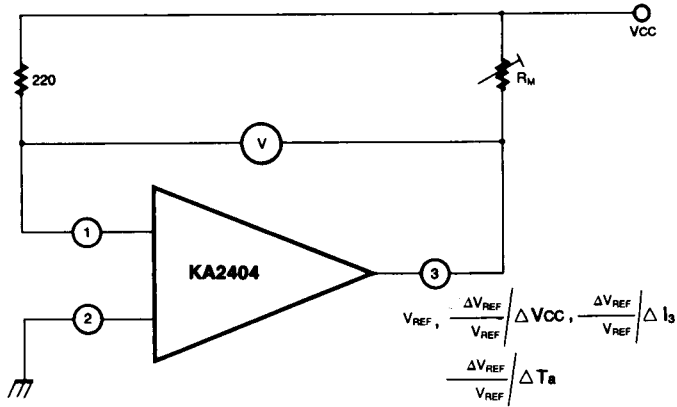

Fig. 2

TEST CIRCUIT 2
Current Coefficient

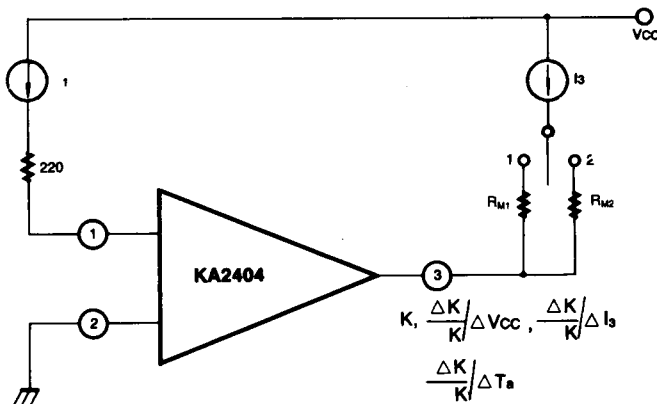

Fig. 3

$$K = \frac{I_s (SW 2) - (SW 1)}{I_1 (SW 2) - (SW 1)}$$

TEST CIRCUIT 3

Quiescent Circuit Current

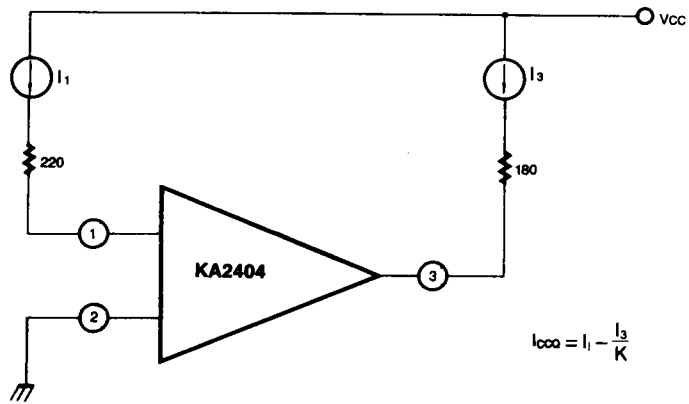
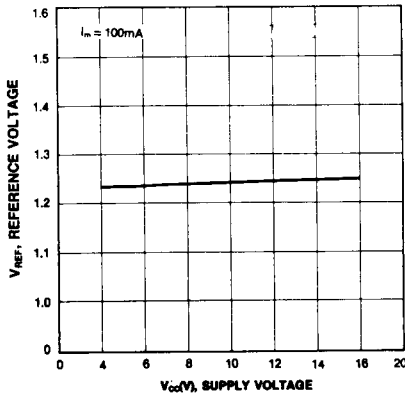
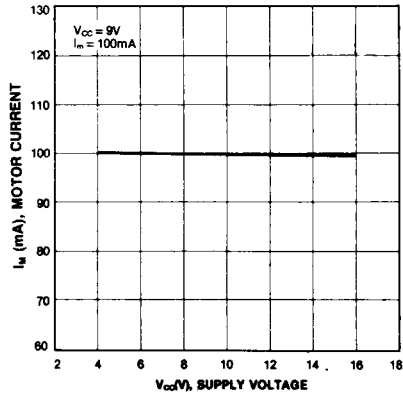

Fig. 4

REFERENCE VOLTAGE-SUPPLY VOLTAGE



MOTOR CURRENT-SUPPLY VOLTAGE



CURRENT COEFFICIENT-SUPPLY VOLTAGE

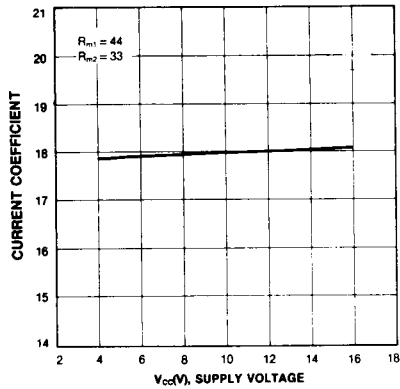

REFERENCE VOLTAGE-MOTOR CURRENT

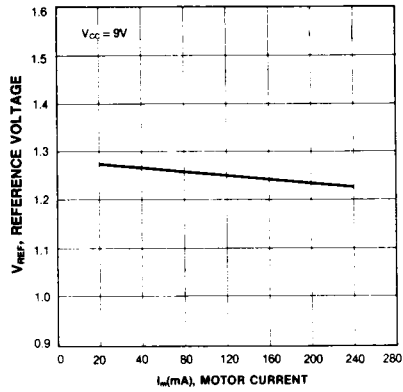

CURRENT COEFFICIENT-AMBIENT TEMPERATURE

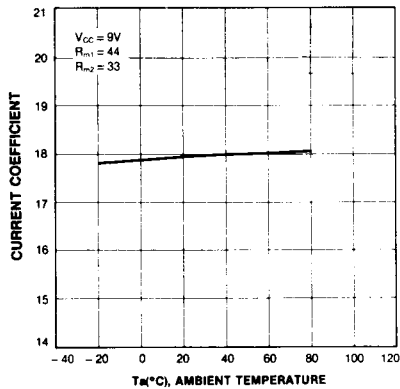

REFERENCE VOLTAGE-AMBIENT TEMPERATURE

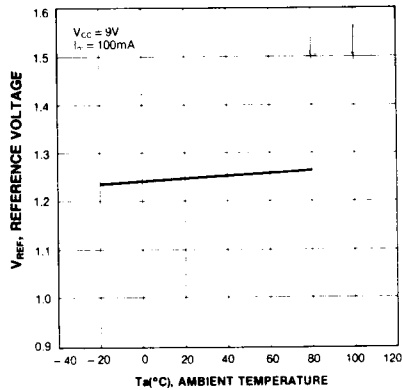

(APPLICATION CHARACTERISTICS)

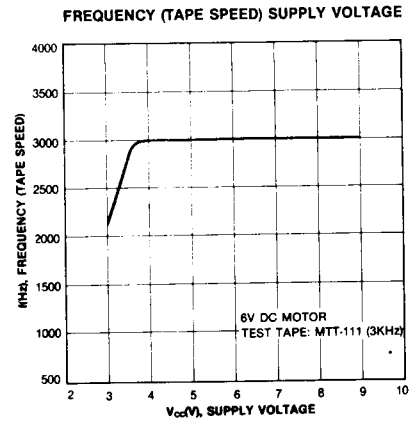
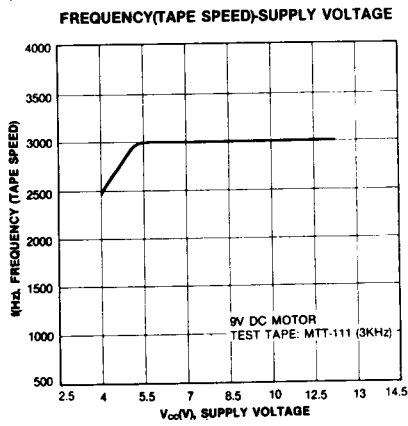

APPLICATION CIRCUIT

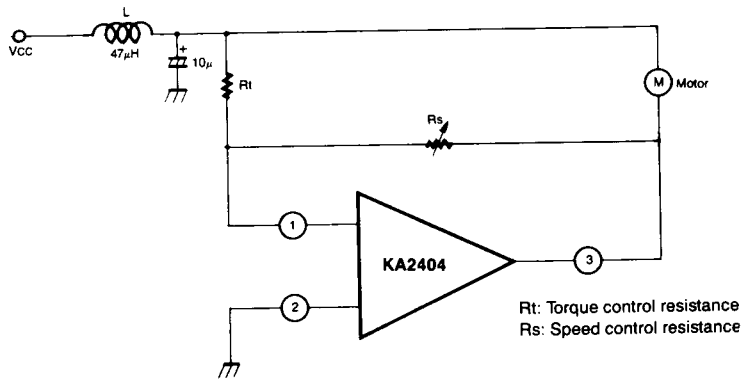

Fig. 5