

KAS07 SERIES

AC - DC POWER MODULE
7W SINGLE OUTPUT



FEATURES

- AC/DC POWER MODULE
- UNIVERSAL INPUT 85 ~ 265 VAC, 47 - 440Hz
- HIGH EFFICIENCY UP TO 80%
- SHORT CIRCUIT PROTECTION
- COMPLY WITH ErP
- 3 YEARS WARRANTY



MODEL LIST

MODEL NO.	INPUT VOLTAGE	OUTPUT WATTAGE	OUTPUT VOLTAGE	OUTPUT CURRENT	EFF. (min.)	EFF. (typ.)	EFF. (avg.)	CAPACITOR LOAD (max.)
Single Output Models								
KAS0703	85~265 VAC	6.6 WATTS	+ 3.3 VDC	2000 mA	70%	72%	71%	7000 μ F
KAS0705	85~265 VAC	7 WATTS	+ 5 VDC	1400 mA	72%	74%	71%	7000 μ F
KAS0709	85~265 VAC	7 WATTS	+ 9 VDC	780 mA	74%	76%	75%	2700 μ F
KAS0712	85~265 VAC	7.2 WATTS	+ 12 VDC	600 mA	76%	78%	75%	1500 μ F
KAS0715	85~265 VAC	7.2 WATTS	+ 15 VDC	480 mA	76%	78%	75%	1000 μ F
KAS0724	85~265 VAC	7.2 WATTS	+ 24 VDC	300 mA	78%	80%	75%	560 μ F

SPECIFICATION

All Specifications Typical At Nominal Line, Full Load, 25°C Unless Otherwise Noticed

GENERAL					
Characteristics	Conditions	min.	typ.	max.	unit
Switching frequency	Vi nom, Io nom		132		KHz
Isolation voltage	Input - Output	3,000/4,242			VAC/VDC
Isolation resistance	Input - Output, @ 500VDC	100			M Ω
Ambient temperature	Operating at Vi nom, Io nom	-40		+ 71	°C
Case temperature	Operating at Vi nom, Io nom			+ 85	°C
Derating	Vi nom, +5 l to + 71°C	3.3V & 5V		2	% / °C
	Vi nom, +6 l to + 71°C	Other		4	% / °C
Storage temperature	Non operational	-40		+100	°C
Relative humidity	Vi nom, Io nom	20		95	% RH

SPECIFICATION

All Specifications Typical At Nominal Line, Full Load, 25°C Unless Otherwise Noticed

GENERAL						
Characteristics	Conditions		min.	typ.	max.	unit
Temperature coefficient	Vi nom, Io min				± 0.03	% / °C
MTBF	Bellcore issue 6 @40°C, GB	3.3V & 12V		1,032,000		Hours
		5V		1,024,000		Hours
		9V & 15V		1,036,000		Hours
		24V		1,088,000		Hours
Altitude during operation	IEC 60068-2-13				4,850	m
Dimension			L50.8 x W25.4 x H19.0			mm
Cooling	Free air convection					

INPUT SPECIFICATIONS						
Characteristics	Conditions		min.	typ.	max.	unit
Rated input voltage	Io nom		100		240	VAC
Input voltage range	Ta min ... Ta max, Io nom	AC in	85		265	VAC
		DC in	120		375	VDC
Input current	Vi : 115 / 230 VAC, Io nom			145 / 100		mA
Rated input current	Vi : 85 VAC, Io nom				250	mA
Line frequency	Vi nom, Io nom		47		440	Hz
Inrush current	Vi : 115 / 230 VAC, Io nom				10/18	A
Leakage current	Input - Output				0.25	mA
Standby power consumption	Vi nom, Io = No Load				0.3	W

OUTPUT SPECIFICATIONS						
Characteristics	Conditions		min.	typ.	max.	unit
Output voltage accuracy	Vi nom, Io nom				± 2	%
Minimum load	Vi nom		0			%
Line regulation	Io nom, Vi min ... Vi max				± 1	%
Load regulation	Vi nom, Io min ... Io nom				± 2	%
Hold up time	Vi: 115/230 VAC, Io nom		15 / 30			ms
Turn on time	Vi nom, Io nom				1,000	ms
Rise time	Vi nom, Io nom				150	ms
Fall time	Vi nom, Io nom				150	ms
Transient recovery time	Vi nom, I ~ 0.5 Io nom				2	ms
Ripple & noise	Vi nom, Io nom, BW = 20MHz				100	mV
Efficiency	Vi nom, Io nom, Po / Pi		Up to 80%, See model list and typ efficiency curve			

CONTROL AND PROTECTION						
Characteristics	Conditions		min.	typ.	max.	unit
Input fuse			T1A / 250VAC internal			
Output short circuit			Hiccup mode			
Rated over load protection	Vi nom (see typ current limited curve)		130		180	%

SPECIFICATION

All Specifications Typical At Nominal Line, Full Load, 25°C Unless Otherwise Noticed

APPROVALS AND STANDARDS

cTUVus	UL 60950-1
TUV	EN 60950-1
CE	EN 61000-6-3, EN 55022 Class B, EN 61000-3-2, EN 61000-3-3 EN 61000-6-2, EN 55024, EN 61000-4-2, EN 61000-4-3 EN 61000-4-4, EN 61000-4-5, EN 61000-4-6, EN 61000-4-8 EN 61000-4-11, EN 61204-3
Vibration resistance	meet IEC 60068-2-6 (10-500 Hz, 2G, along X, Y, Z each Axis, 60 min for each Axis)
Shock resistance	meet IEC 60068-2-27 (15G, 11ms, 3 axes, 6 Faces, 3 times for each Face)

PHYSICAL CHARACTERISTICS

Case size	50.8 x 25.4 x 19.0mm (2.0 x 1.0 x 0.75 inches)
Case material	Plastic
Weight	45g
Potting material	Epoxy

MECHANISM & PIN CONFIGURATION

mm [inch]

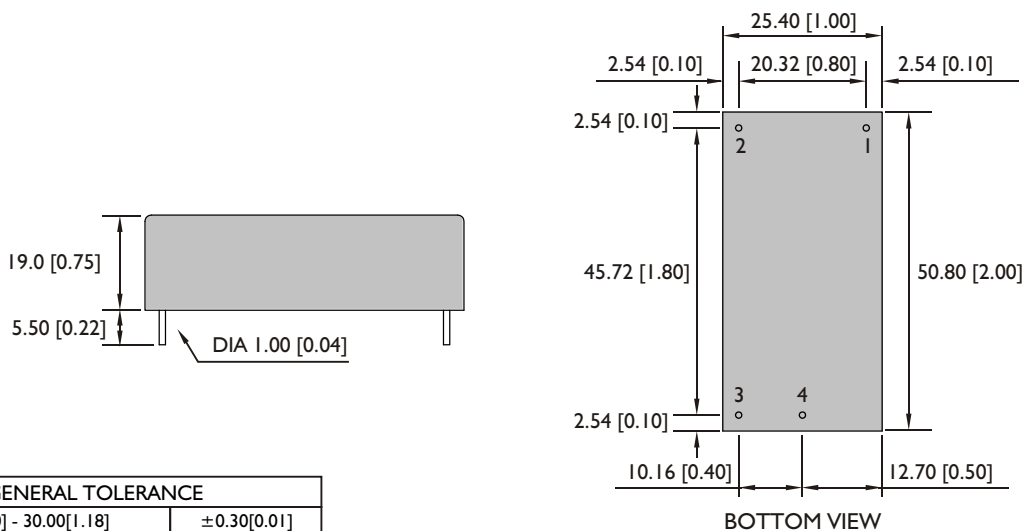

GENERAL TOLERANCE	
0.00[0.00] - 30.00[1.18]	±0.30[0.01]
30.00[1.18] - 120.00[4.72]	±0.50[0.02]

PIN ASSIGNMENT

GENERAL

PIN NO.	1	2	3	4
SINGLE	AC IN	AC IN	Vo +	Vo -

CIRCUIT SCHEMATIC

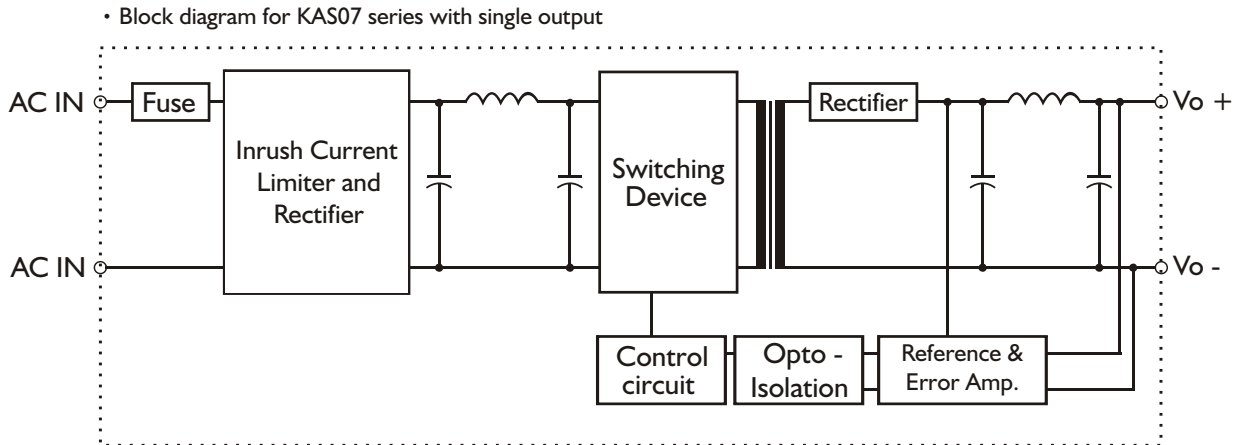

DERATING CURVE

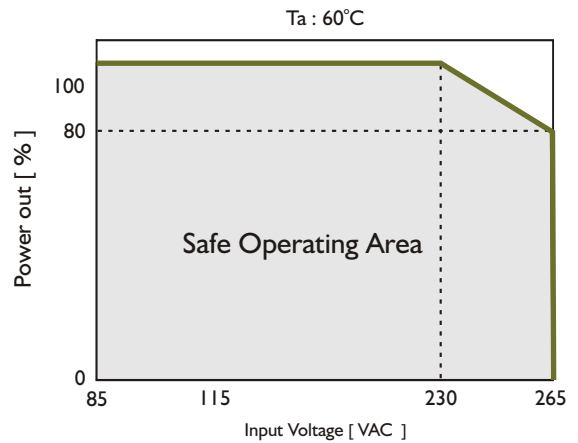
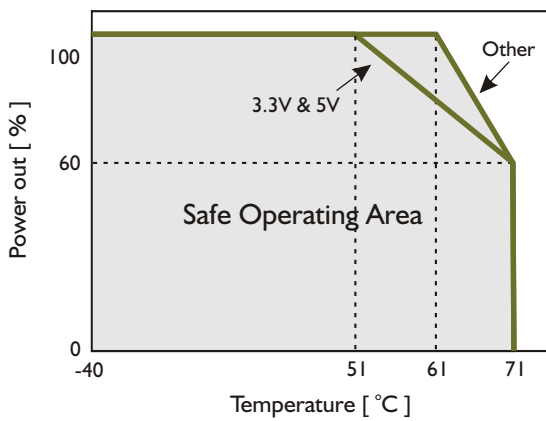

TYP. CURRENT LIMITED CURVE

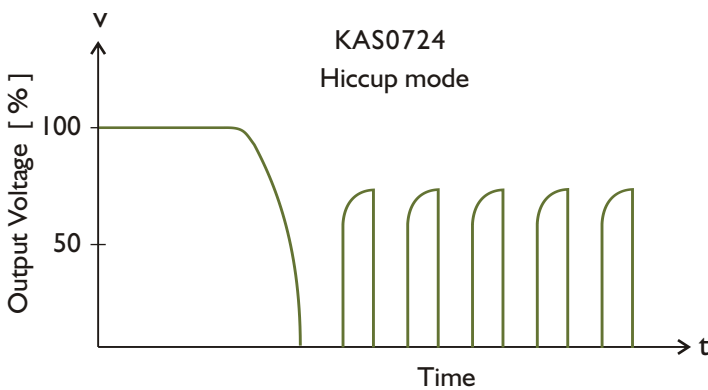

TYP. EFFICIENCY CURVE

