

Via Monfalcone 41  
20092 Cinisello Balsamo (Milano) – Italy  
Tel. +39 0266013695 – Fax +39 0266013500

USA Division  
**Khatod Optoelectronic USA**  
1033 Lenape Road - West Chester, PA 19382  
Phone: +1 484 947 9006 – Fax: +1 610 696 8035

## KCLP series REFLECTORS for Acriche® and P7® LEDs



### KCLP Series

- High efficiency
- Available in 2 different beams
- Ø 23mm and Ø 28mm Standard

### Typical applications are

- Lamps
- Architectural lighting
- Most applications where a compact light source is required

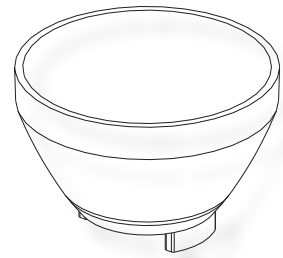

### DESCRIPTION:

The KCLP series offers two reflectors designed for Acriche® LEDs. These REFLECTORS have been studied by using software for optical simulation in order to get the narrow and medium beam with a homogeneous central spot.

### REPORT:

From 1 m ± 0,02 distance, we have measured Luminous Intensity emitted by LED. Such measurements have been repeated with the same test conditions but coupling LEDs to the lens Khatod cod. KCLP23CR, KCLP23ST, KCLP28ACR and KCLP28AST.

### MEASURED DATA:

Column 1 shows p/n of the Lenses, column 2 shows Luminous Intensity detected measuring LEDs without lens, column 3 shows Luminous Intensity detected on LEDs coupled with lens, column 4 shows the difference (X\*) between col. 2 and col. 3

Lens Type	LED Lux from 1 Mt (ftc From 1 Mt)	LED + REFLECTORS Lux from 1Mt (ftc From 1 Mt)	X*
KCLP23CR (20°)	50,3 (4,64 ftc)	470 (43,38 ftc)	9
KCLP23ST (40°)	50,3 (4,64 ftc)	260 (24,00 ftc)	5
KCLP28ACR (12°)	50,3 (4,64 ftc)	1030 (95,06 ftc)	20
KCLP28AST (35°)	50,3 (4,64 ftc)	450 (41,53 ftc)	9

Test carried out after 5 min. of operation of the LED  
Measurements carried out with Luxometer mod LUX-1337 of **ISO-TEC** and **MINOLTA** mod LS – 150  
\* X is the value of measurement of the LED brightness at 1 meter distance, without optic devices applied to the LED.

## White LED Illuminance Chart

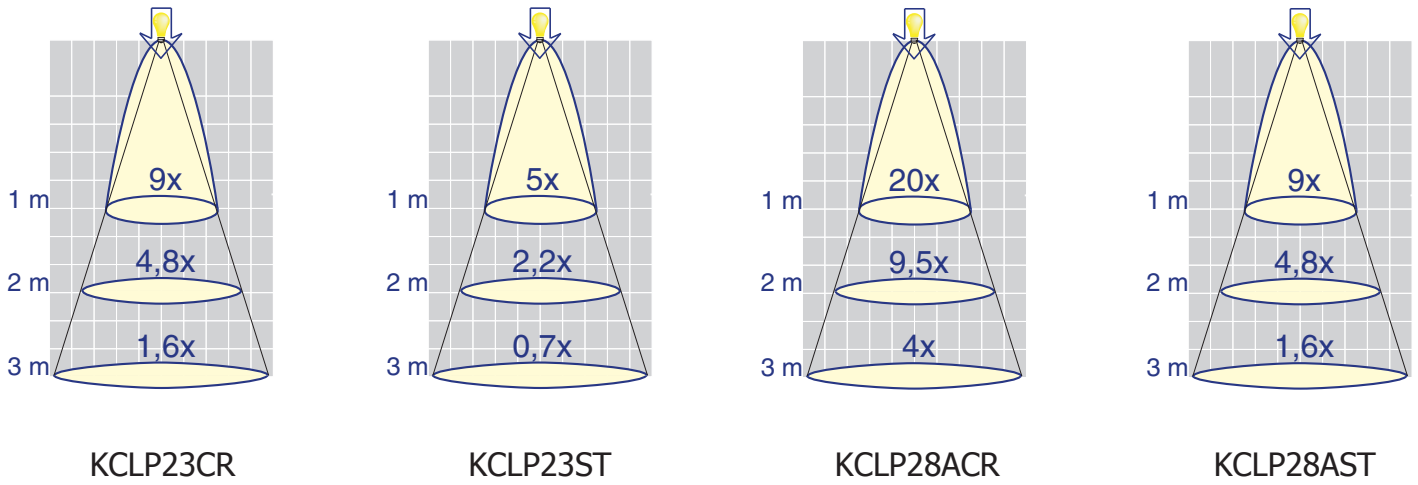

\* X is the value of measurement of the LED brightness at 1 meter distance, without optic devices applied to the LED.

### Test conditions:

Room Luminous Intensity :0 Lumen

Room Temperature: 32° C

LED temperature after 10 min. : ~ 48 °C

The diagram demonstrates the performance of the Khatod optoelectronic reflectors

Intensity to 1 Meter

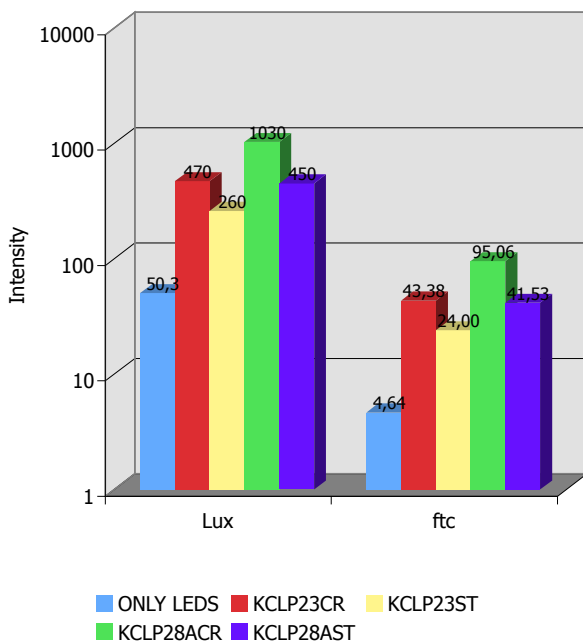

Spectrum Distribution

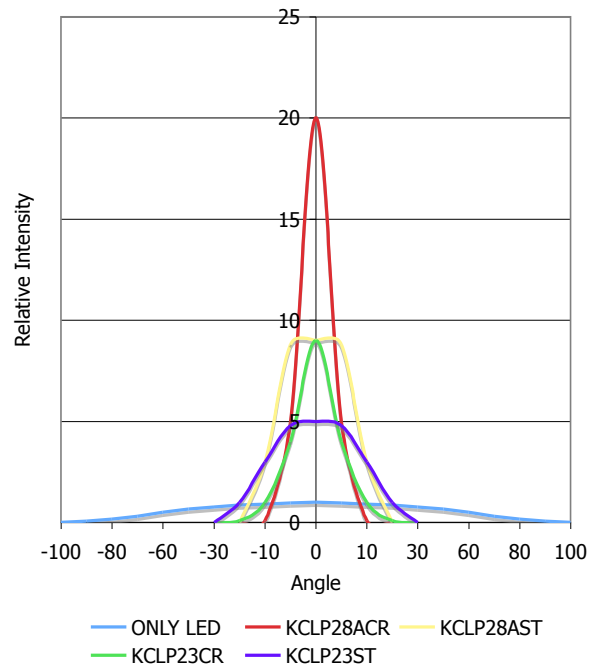

Photos:

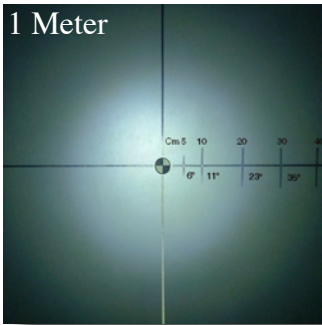

KCLP23CR

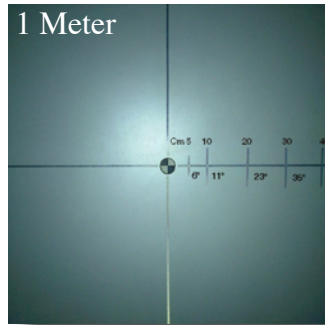

KCLP23ST

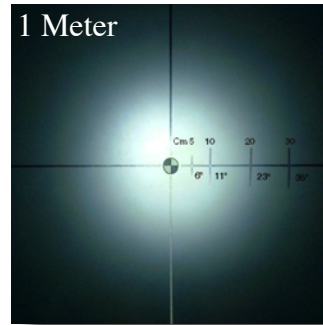

KCLP28ACR

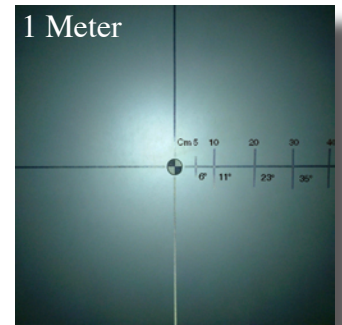

KCLP28AST

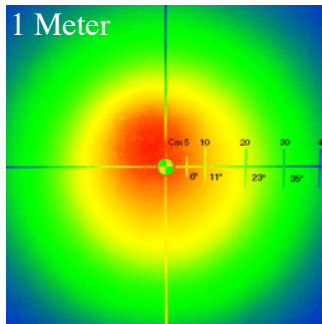

KCLP23CR  
spectro metric analysis

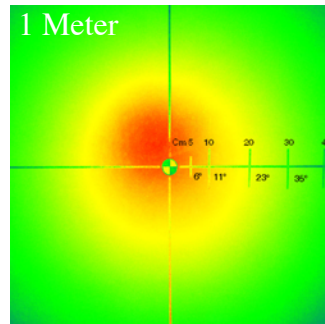

KCLP23ST  
spectro metric analysis

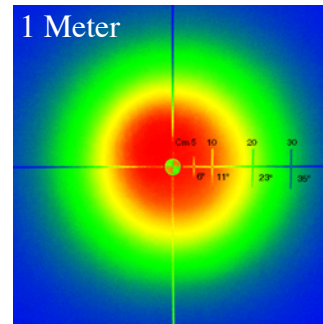

KCLP28ACR  
spectro metric analysis

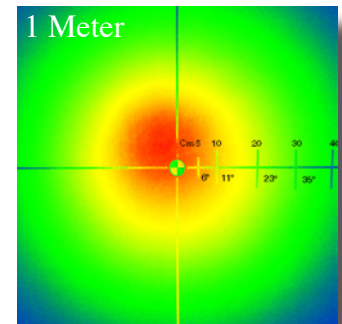

KCLP28AST  
spectro metric analysis

Measurements carried out with Luxometer mod LUX-1337. Room Luminous Intensity: 0 Lumen. Camera mod. Fujifilm S7000

Ordering part number:

KCLP XX XX

CR = metalized (Narrow beam)

ST = embossed surface (Medium beam)

23 = Ø 23 mm

28A = Ø 27,5 mm

Drawing.

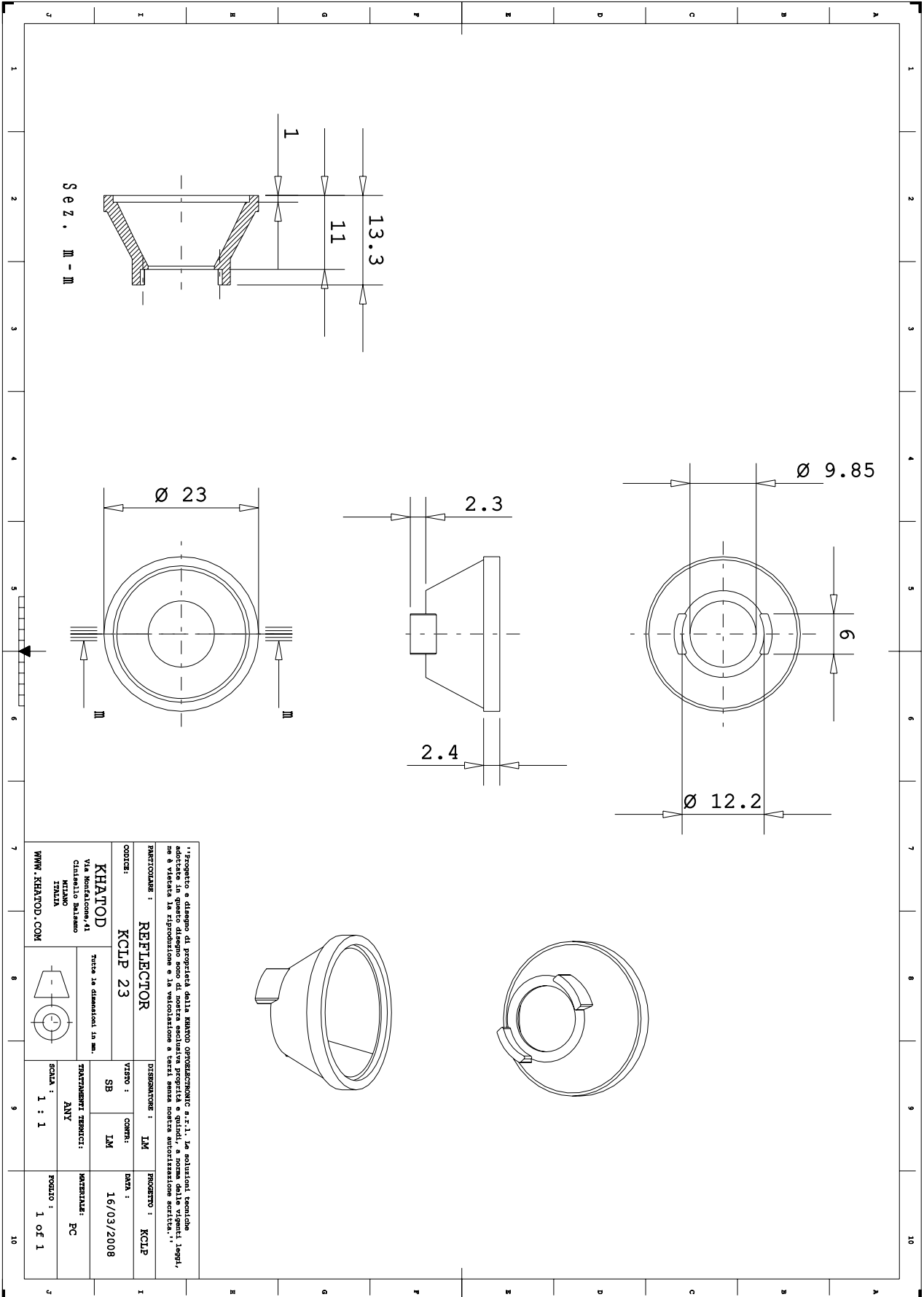

"Progetto e disegno di proprietà della KHATOD OPTOELECTRONIC s.r.l. In soluzioni tecniche adottate in questo disegno sono di nostra esclusiva proprietà e quindi, a norma della vigente legge, ma è vietata la riproduzione e la circolazione e terzi senza nostra autorizzazione scritta."

<b>REPERICIONE :</b> <b>REFLECTOR</b> <b>KCIIP 23</b>			
<b>CONDIZIONI :</b> KHATOD Via Montecorona, 41 Cinisello Balsamo MILANO ITALIA WWW.KHATOD.COM	<b>DISPENSARE :</b> IM		<b>PROGETTO :</b> KCIIP
	<b>STATO :</b> SB	<b>COMPR. :</b> IM	<b>DATA :</b> 16/03/2008
Tratto da disegni in mm.	<b>TRATTAMENTI TERMICI :</b> ANY	<b>MATERIALE :</b> PC	<b>Foglio :</b> 1 OF 1
<b>SCALA :</b> 1 : 1			

Drawing.

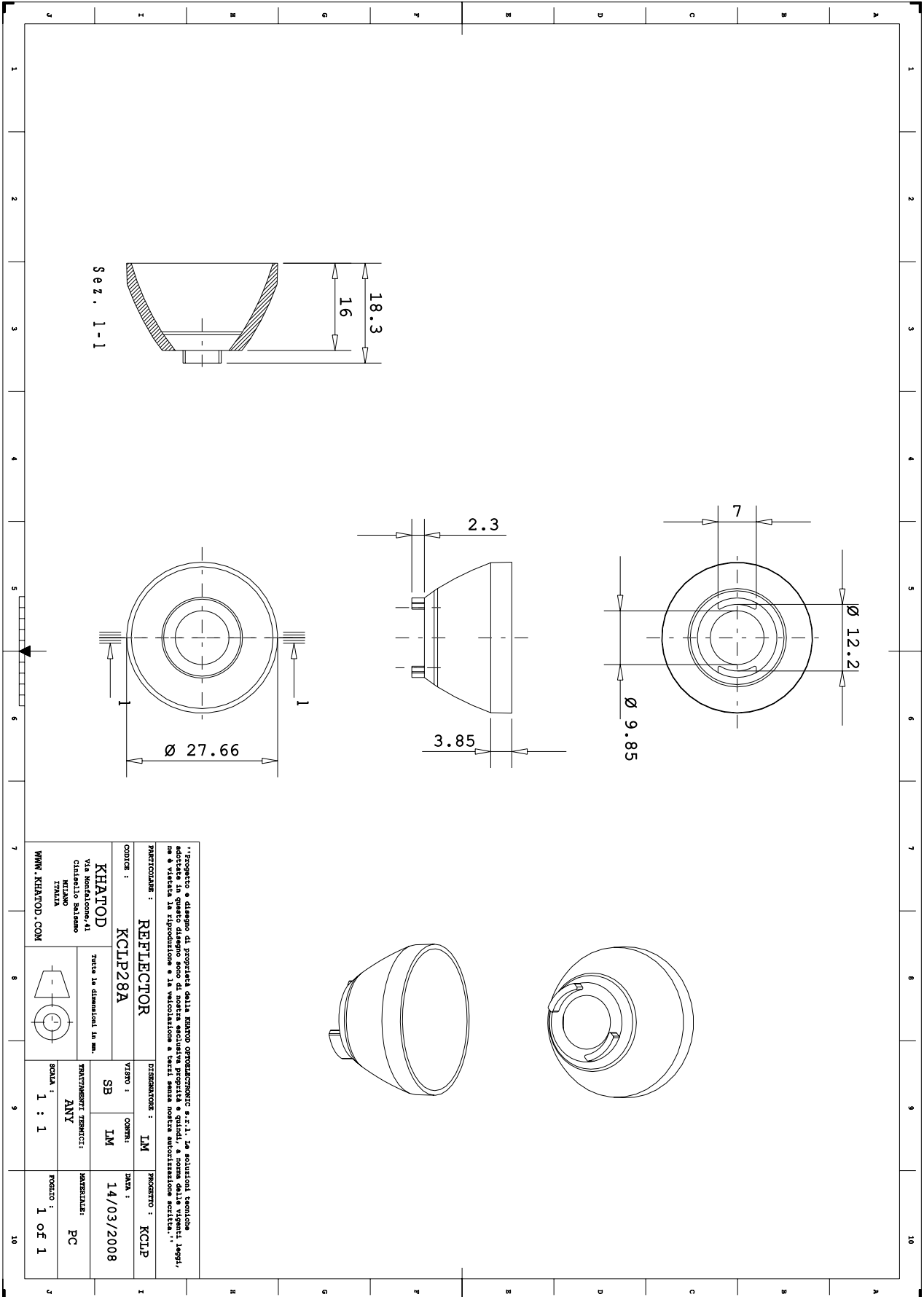

Progetto e disegno di proprietà della KHATOD OPTOELECTRONIC s.r.l. In qualsiasi tecnica adottata in questo disegno sono di nostra esclusiva proprietà e quindi, a norma delle vigenti leggi, ne è vietata la riproduzione e la pubblicazione senza nostra autorizzazione scritta.

PARTICOLARE : REFLECTOR		DISSEGNIATORE : IM		PROGETTO : KCIIP	
CODICE : KCIIP28A		VIZIO : SB		DATA : 14/03/2008	
KHATOD MILANO Via Montalcorno,41 Città del Sole Salorno 13044 WWW.KHATOD.COM		TRATTAZIONE TERMICA : ANY		MATERIALE : PC	
Tutte le dimensioni in mm.		SCALA : 1 : 1		FOGLIO : 1 OF 1	

## Reflectors characteristics

Parameter	Symbol	Rating	Unit
Reflector Material	PC Polycarbonate, Aluminium reflective coating with protective clear-coat	--	--
Operating Temperature	Topr	-40 to +120	°C
Storage Temperature	Tstg	-40 to +120	°C

*Published by Khatod optoelectronic srl - All the data contained in this documents are the property of Khatod optoelectronic srl and may change without notice.*

*For technical specification on LEDs please refer to Seoul Semiconductor<sup>®</sup> datasheet or visit [www.seoulsemicon.com](http://www.seoulsemicon.com)*

### Notes:

Please note that small defects in the reflective coating, flow lines and weld lines on the surfaces of the reflectors are acceptable if the optical performance of the reflectors is within the specification described in the section "OPTICAL CHARACTERISTICS"

- Should you require further information, please contact Khatod for advice.
- All reflectors testing must be subject to identical conditions as Khatod test condition.

### **KHATOD REFLECTORS Use And Maintenance**

- DO NOT HANDLE OR INSTALL REFLECTORS WITHOUT WEARING GLOVES, SKIN OILS MAY DAMAGE LENS OR LIGHT TRANSMISSION
- CLEAN LENSES WITH MILD SOAP AND WATER AND A SOFT CLOTH
- DO NOT USE ANY COMMERCIAL CLEANING SOLVENTS ON REFLECTORS

Khatod SRL, Milan, Italy, manufactures lenses for LEDs. Any other use of the lens shall void our liability and warranty. The lenses are an inert component to be used in the manufacture of various products. Our warranty and liability are limited only to the manufacture of the lens. You may not modify, copy, distribute reproduce, license or alter the lens and related materials of Khatod SRL. Khatod SRL does not warrant against damages or defects arising out of the use or misuse of the products; against defects or damage arising from improper installation, or against defects in the product or in its components. No warranty of any kind, expressed or implied, is made regarding the safety of the products. The entire risk as to the quality or performance of the product is with the buyer. In no event shall Khatod SRL or Khatod USA be liable for any direct, indirect, punitive, incidental, special, consequential damages, or any damages whatsoever arising out of or connected with the use or misuse of the product. Khatod SRL shall not have any obligation with respect to the product or any part thereof, whether based on contract, tort, strict liability or otherwise. Buyer assumes all risks and liability from use of the product. The laws of Milan, Italy govern this product warranty and liability and you hereby consent to the exclusive jurisdiction and venue of courts in Milan, Italy in all disputes arising out of or relating to the use of this product.

