



LB1648

Dual Bidirectional Motor Driver

The LB1648 is a dual bidirectional motor driver. It is especially suited for reel motor in cassette deck.

Features

- 2-input logic can be used to exercise control of bidirectional driving, braking and open.
- Output voltage variable by use of external Zener diode
- On-chip thermal protector

Absolute Maximum Ratings at Ta = 25°C

			unit
Maximum Supply Voltage	V _{CC} max	18	V
Input Voltage	V _{IN}	18	V
Output Current	I _O	±0.8	A
Allowable Power Dissipation	P _d max	1.9	W
Operating Temperature	T _{opr}	-25 to +75	°C
Storage Temperature	T _{stg}	-55 to +125	°C

Allowable Operating Conditions at Ta = 25°C

			unit
Supply Voltage	V _{CC}	7 to 16	V

Electrical Characteristics at Ta = 25°C, V_{CC} = 12V, per channel

			min	typ	max	unit
Current Dissipation	I _{CC1}	Pin 1 forward, R _L = ∞, V _Z = 4V		15	22	mA
	I _{CC2}	Pin 7 forward, R _L = ∞, V _Z = 4V		14	20	mA
	I _{CC3}	Pin 7 open, R _L = ∞		1.5	3	mA
Output Leakage Current	I _{OL}	Braking mode, R _L = ∞, per output pin		40	120	μA
Input Threshold Voltage	V _{th}	R _L = ∞	0.9	1.05	1.20	V
Output Voltage	V _O	V _Z = 4V, I _O UT = 85mA	3.75	4.0	4.25	V
Output Transistor Saturation Voltage (Upper)	V _{sat1}	I _O UT = 200mA		1.9	2.3	V
		I _O UT = 400mA		2.0	2.4	V
Output Transistor Saturation Voltage (Lower)	V _{sat2}	I _O UT = 200mA		0.3	0.55	V
		I _O UT = 400mA		0.5	0.7	V
V _Z Pin Flow-out Current	I _Z	V _Z = 4V, I _O UT = 0mA	0.55	0.85	1.15	mA

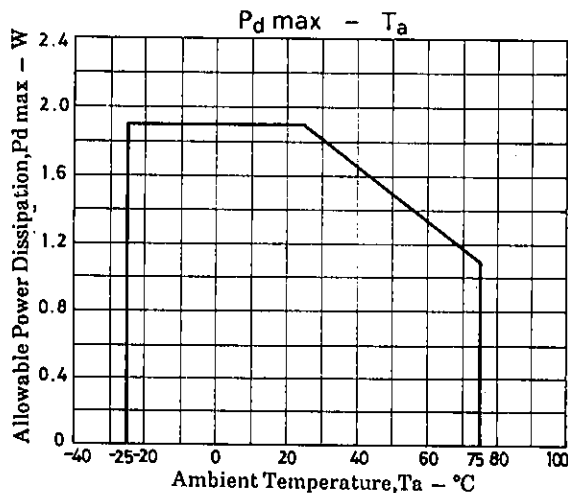

Package Dimensions

(unit: mm)

3022A-D12FIC

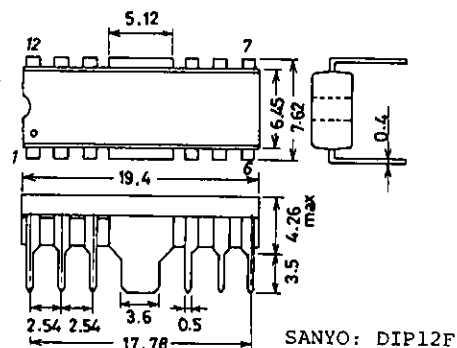

Equivalent Circuit Block Diagram

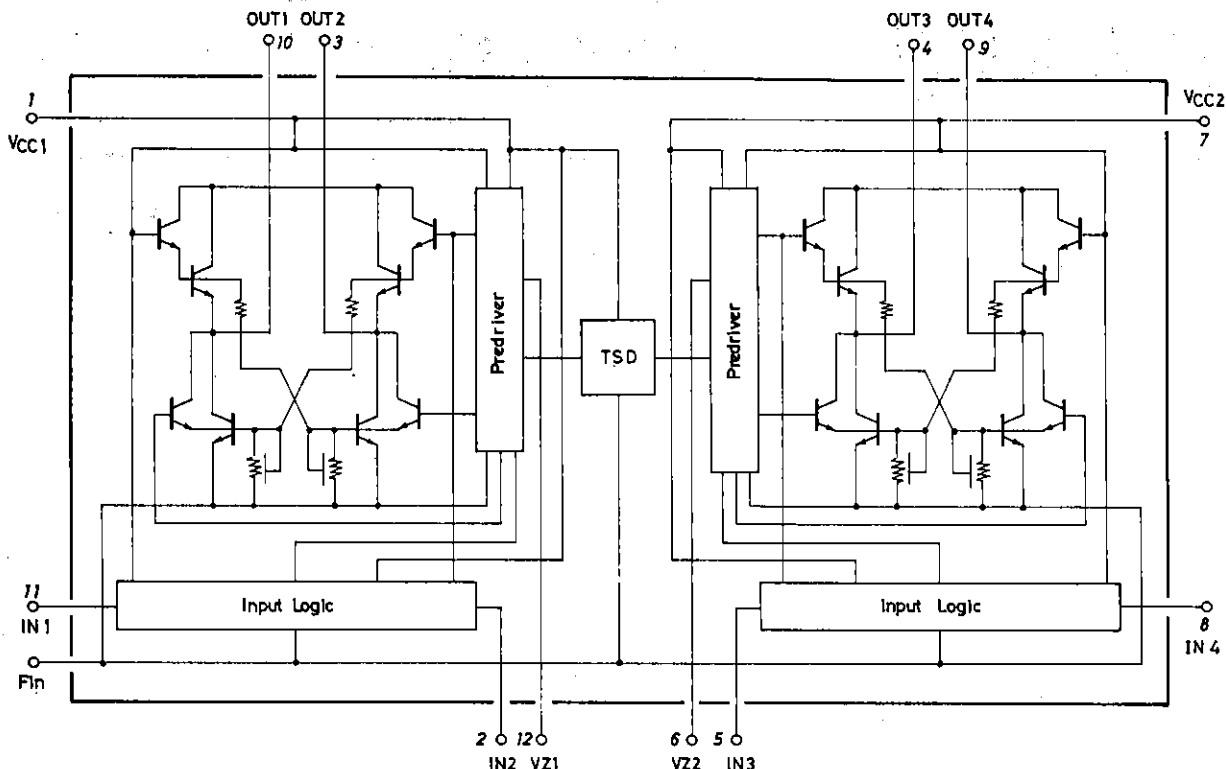

Logic Section Truth Table

Mode	IN1	IN2	OUT1	OUT2	IN3	IN4	OUT3	OUT4
Open	0	0	Open	Open	0	0	Open	Open
Forward	1	0	H	L	1	0	H	L
Reverse	0	1	L	H	0	1	L	H
Brake	1	1	L	L	1	1	L	L

Note) A capacitor of 0.01μF or greater must be connected across V_{CC1,2} and GND.

Sample Application Circuit

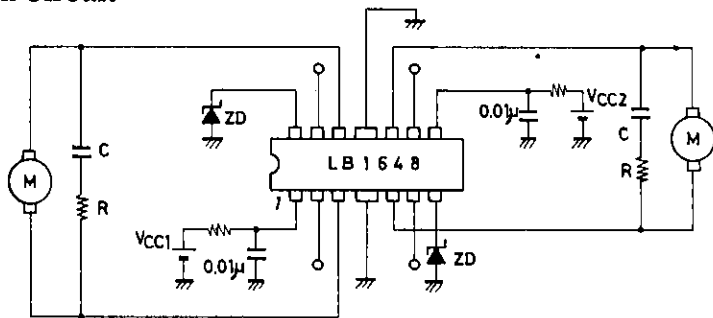

Unit (capacitance: F)

Test Circuits (1 channel)

- (1) I_{CC1} (pin 1)
- I_{CC2} (pin 7)
- I_{CC3} (pin 7)

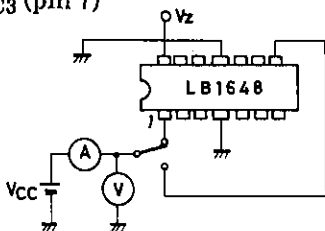

- (2) I_{OL}

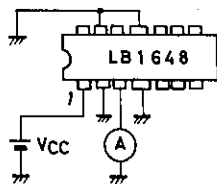

LB1648

(3) V_{th}

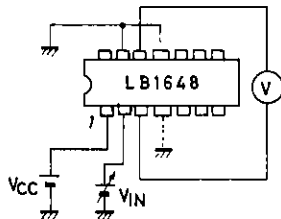

(4) V_o

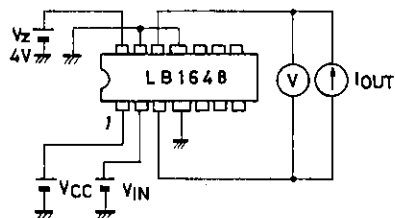

(5) V_{sat1}

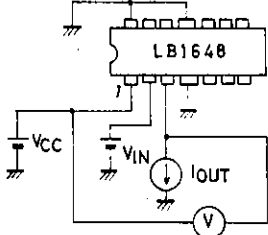

(6) V_{sat2}

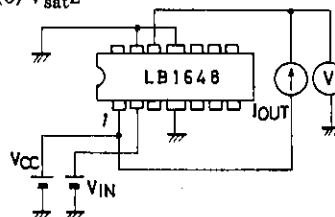

Internal Circuits Input Circuit,

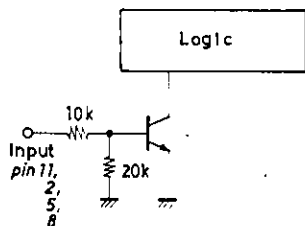

Resistance variations (including temperature characteristics)
- 35 ~ + 50%

Unit (resistance: Ω)

Output Circuit

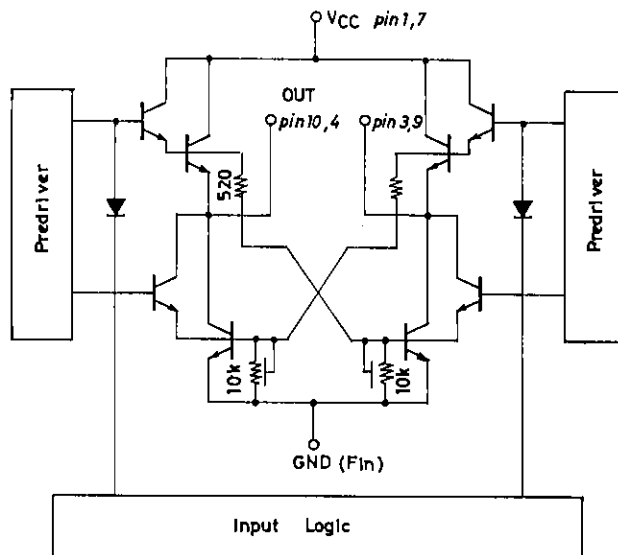

Unit (resistance: Ω)

Circuit of Pin V_Z

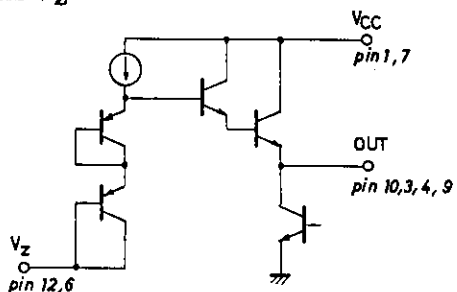

V_{BE} of 2 output NPN transistors
is canceled by V_{BE} of 2 PNP transistors.
 $V_o \approx V_Z$

Design Notes

1) Maximum voltage, maximum current

A voltage greater than the supply voltage, 7 to 16V, specified in the Allowable Operating Conditions must not be applied to pins 1 and 7. The maximum current is 0.8A (peak). The rush current at the time of start must not exceed the peak current.

2) Output transistor protection

A resistor (or fuse resistor) must be connected to the V_{CC} line to provide protection against output short, output pin-to-GND short.

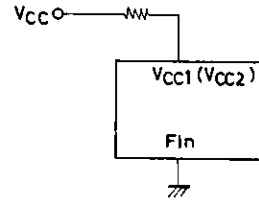

3) Wiring

The bypass capacitors connected across pins 1, 7 and GND must not have an impedance common to other lines. The GND line must be separated from other circuits.

4) Provision against oscillation

In applications where motors with brush are used, a capacitor may be connected across both terminals to prevent the spark-caused noise. This capacitor is connected across the output pins of the LB1648, which may cause oscillation to occur. In this case, the capacitor value must be made as small as possible or a resistor must be connected in series.

5) External Zener diode

The current flowing out of the V_Z pin varies with the load and its maximum value is approximately 1.2mA. If you use a Zener diode of soft clip type and need an accuracy in voltage, a current required for the Zener diode must be supplied externally.

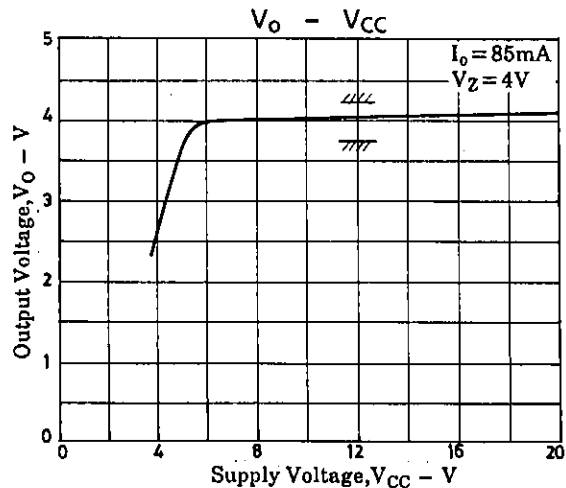
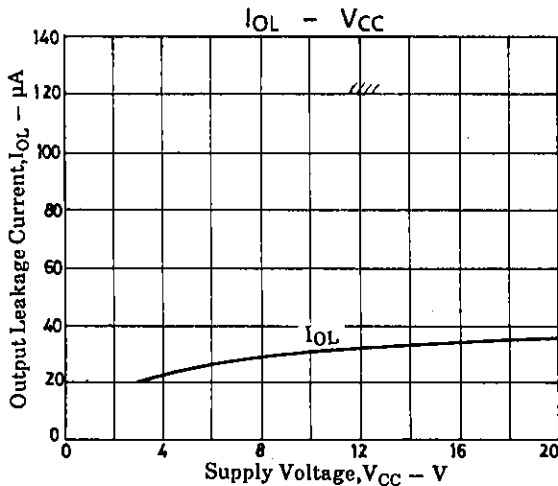
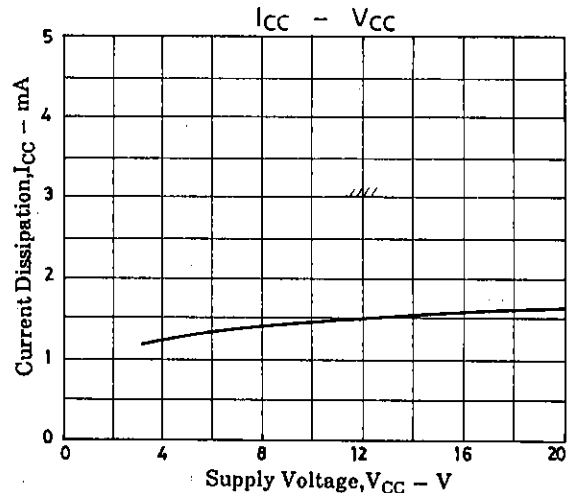
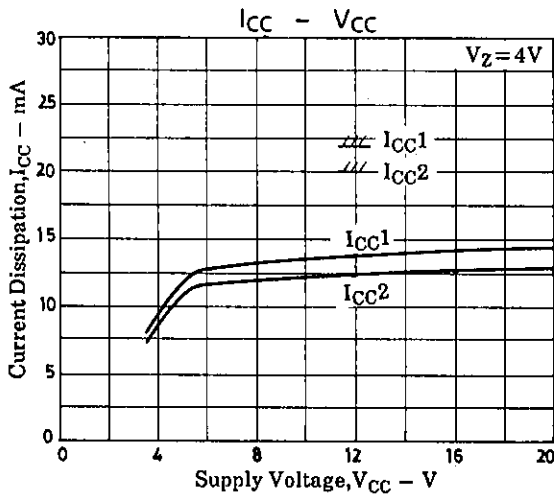
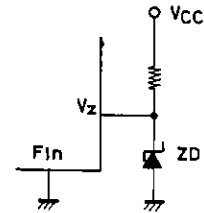

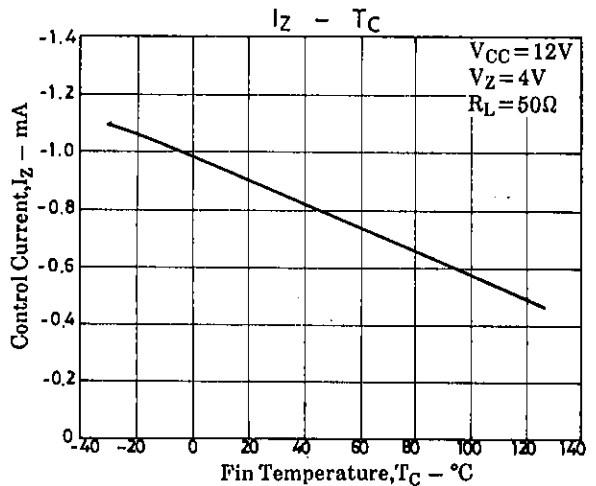
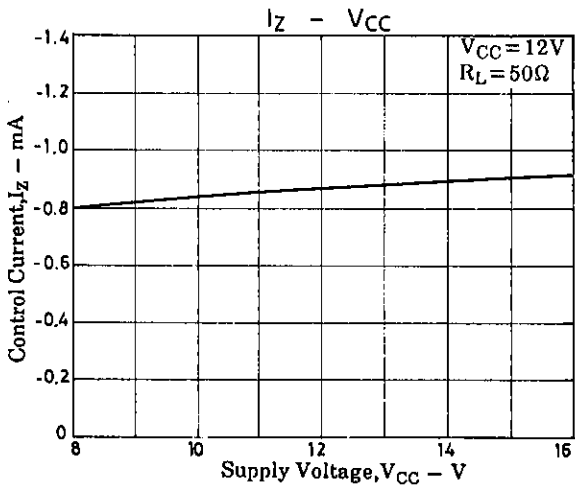
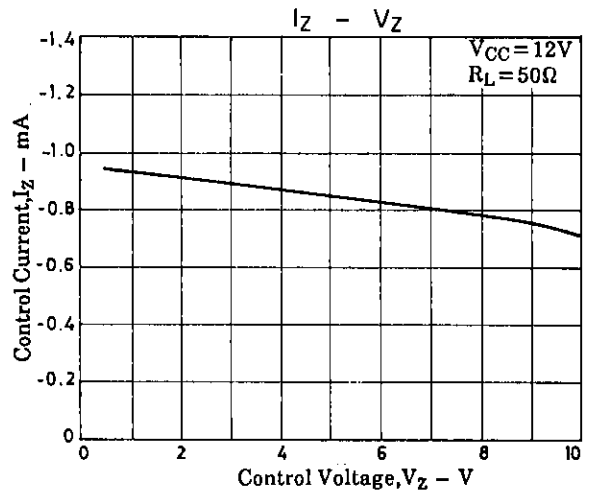
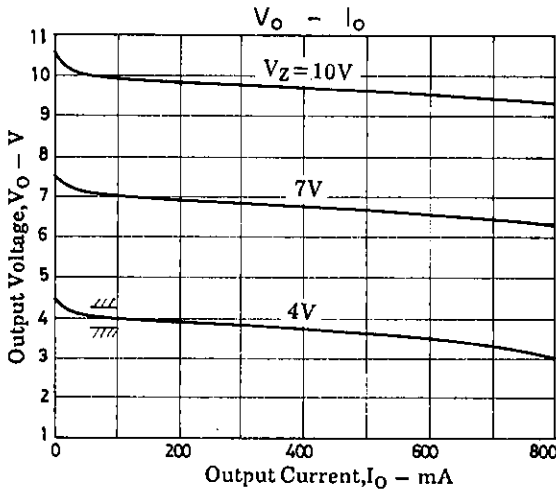
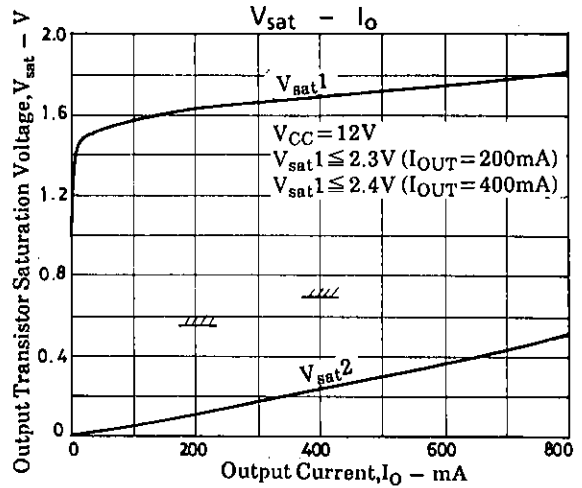
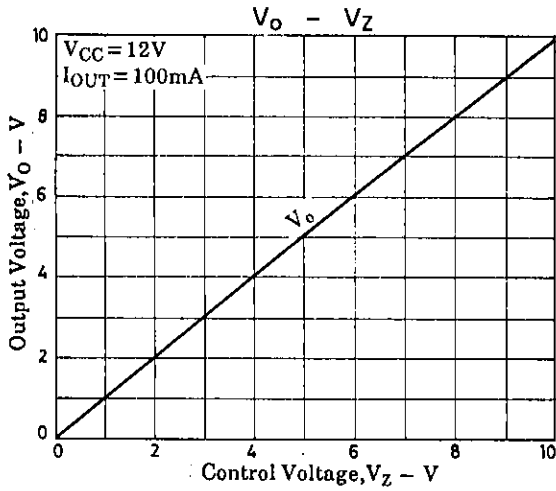

- No products described or contained herein are intended for use in surgical implants, life-support systems, aerospace equipment, nuclear power control systems, vehicles, disaster/crime-prevention equipment and the like, the failure of which may directly or indirectly cause injury, death or property loss.
- Anyone purchasing any products described or contained herein for an above-mentioned use shall:
 - ① Accept full responsibility and indemnify and defend SANYO ELECTRIC CO., LTD., its affiliates, subsidiaries and distributors and all their officers and employees, jointly and severally, against any and all claims and litigation and all damages, cost and expenses associated with such use;
 - ② Not impose any responsibility for any fault or negligence which may be cited in any such claim or litigation on SANYO ELECTRIC CO., LTD., its affiliates, subsidiaries and distributors or any of their officers and employees jointly or severally.
- Information (including circuit diagrams and circuit parameters) herein is for example only; it is not guaranteed for volume production. SANYO believes information herein is accurate and reliable, but no guarantees are made or implied regarding its use or any infringements of intellectual property rights or other rights of third parties.