



# Stellaris® LM3S9B96 Microcontroller

## DATA SHEET

---

# Copyright

Copyright © 2007-2010 Texas Instruments Incorporated All rights reserved. Stellaris and StellarisWare are registered trademarks of Texas Instruments Incorporated. ARM and Thumb are registered trademarks and Cortex is a trademark of ARM Limited. Other names and brands may be claimed as the property of others.

ADVANCE INFORMATION concerns new products in the sampling or preproduction phase of development. Characteristic data and other specifications are subject to change without notice.

 Please be aware that an important notice concerning availability, standard warranty, and use in critical applications of Texas Instruments semiconductor products and disclaimers thereto appears at the end of this data sheet.

Texas Instruments Incorporated  
108 Wild Basin, Suite 350  
Austin, TX 78746  
<http://www.ti.com/stellaris>  
<http://www-k.ext.ti.com/sc/technical-support/product-information-centers.htm>



# Table of Contents

<b>Revision History .....</b>	<b>37</b>
<b>About This Document .....</b>	<b>42</b>
Audience .....	42
About This Manual .....	42
Related Documents .....	42
Documentation Conventions .....	43
<b>1 Architectural Overview .....</b>	<b>45</b>
1.1 Functional Overview .....	47
1.1.1 ARM Cortex™-M3 .....	47
1.1.2 On-Chip Memory .....	49
1.1.3 External Peripheral Interface .....	50
1.1.4 Serial Communications Peripherals .....	52
1.1.5 System Integration .....	58
1.1.6 Advanced Motion Control .....	63
1.1.7 Analog .....	65
1.1.8 JTAG and ARM Serial Wire Debug .....	66
1.1.9 Packaging and Temperature .....	67
1.2 Target Applications .....	67
1.3 High-Level Block Diagram .....	67
1.4 Additional Features .....	69
1.4.1 Memory Map .....	69
1.4.2 Hardware Details .....	69
<b>2 ARM Cortex-M3 Processor Core .....</b>	<b>70</b>
2.1 Block Diagram .....	71
2.2 Functional Description .....	71
2.2.1 Programming Model .....	71
2.2.2 Serial Wire and JTAG Debug .....	78
2.2.3 Embedded Trace Macrocell (ETM) .....	78
2.2.4 Trace Port Interface Unit (TPIU) .....	78
2.2.5 ROM Table .....	79
2.2.6 Memory Protection Unit (MPU) .....	79
2.2.7 Nested Vectored Interrupt Controller (NVIC) .....	79
2.2.8 System Timer (SysTick) .....	80
<b>3 Memory Map .....</b>	<b>83</b>
<b>4 Interrupts .....</b>	<b>86</b>
<b>5 JTAG Interface .....</b>	<b>89</b>
5.1 Block Diagram .....	90
5.2 Signal Description .....	90
5.3 Functional Description .....	91
5.3.1 JTAG Interface Pins .....	91
5.3.2 JTAG TAP Controller .....	93
5.3.3 Shift Registers .....	93
5.3.4 Operational Considerations .....	94
5.4 Initialization and Configuration .....	96

5.5	Register Descriptions .....	97
5.5.1	Instruction Register (IR) .....	97
5.5.2	Data Registers .....	99
<b>6</b>	<b>System Control .....</b>	<b>101</b>
6.1	Signal Description .....	101
6.2	Functional Description .....	101
6.2.1	Device Identification .....	102
6.2.2	Reset Control .....	102
6.2.3	Non-Maskable Interrupt .....	106
6.2.4	Power Control .....	107
6.2.5	Clock Control .....	107
6.2.6	System Control .....	114
6.3	Initialization and Configuration .....	115
6.4	Register Map .....	116
6.5	Register Descriptions .....	117
<b>7</b>	<b>Internal Memory .....</b>	<b>209</b>
7.1	Block Diagram .....	209
7.2	Functional Description .....	209
7.2.1	SRAM .....	210
7.2.2	ROM .....	210
7.2.3	Flash Memory .....	212
7.3	Flash Memory Initialization and Configuration .....	214
7.3.1	Flash Memory Programming .....	214
7.3.2	32-Word Flash Memory Write Buffer .....	215
7.3.3	Nonvolatile Register Programming .....	215
7.4	Register Map .....	216
7.5	Flash Memory Register Descriptions (Flash Control Offset) .....	217
7.6	Memory Register Descriptions (System Control Offset) .....	228
<b>8</b>	<b>Micro Direct Memory Access (<math>\mu</math>DMA) .....</b>	<b>246</b>
8.1	Block Diagram .....	247
8.2	Functional Description .....	247
8.2.1	Channel Assignments .....	248
8.2.2	Priority .....	249
8.2.3	Arbitration Size .....	249
8.2.4	Request Types .....	249
8.2.5	Channel Configuration .....	250
8.2.6	Transfer Modes .....	252
8.2.7	Transfer Size and Increment .....	260
8.2.8	Peripheral Interface .....	260
8.2.9	Software Request .....	260
8.2.10	Interrupts and Errors .....	261
8.3	Initialization and Configuration .....	261
8.3.1	Module Initialization .....	261
8.3.2	Configuring a Memory-to-Memory Transfer .....	261
8.3.3	Configuring a Peripheral for Simple Transmit .....	263
8.3.4	Configuring a Peripheral for Ping-Pong Receive .....	264
8.3.5	Configuring Channel Assignments .....	267
8.4	Register Map .....	267

8.5	μDMA Channel Control Structure .....	268
8.6	μDMA Register Descriptions .....	275
<b>9</b>	<b>General-Purpose Input/Outputs (GPIOs) .....</b>	<b>304</b>
9.1	Signal Description .....	304
9.2	Functional Description .....	309
9.2.1	Data Control .....	310
9.2.2	Interrupt Control .....	311
9.2.3	Mode Control .....	312
9.2.4	Commit Control .....	312
9.2.5	Pad Control .....	313
9.2.6	Identification .....	313
9.3	Initialization and Configuration .....	313
9.4	Register Map .....	314
9.5	Register Descriptions .....	317
<b>10</b>	<b>External Peripheral Interface (EPI) .....</b>	<b>360</b>
10.1	EPI Block Diagram .....	361
10.2	Signal Description .....	362
10.3	Functional Description .....	364
10.3.1	Non-Blocking Reads .....	365
10.3.2	DMA Operation .....	366
10.4	Initialization and Configuration .....	366
10.4.1	SDRAM Mode .....	367
10.4.2	Host Bus Mode .....	371
10.4.3	General-Purpose Mode .....	380
10.5	Register Map .....	388
10.6	Register Descriptions .....	389
<b>11</b>	<b>General-Purpose Timers .....</b>	<b>433</b>
11.1	Block Diagram .....	434
11.2	Signal Description .....	434
11.3	Functional Description .....	437
11.3.1	GPTM Reset Conditions .....	437
11.3.2	32-Bit Timer Operating Modes .....	438
11.3.3	16-Bit Timer Operating Modes .....	439
11.3.4	DMA Operation .....	445
11.4	Initialization and Configuration .....	445
11.4.1	32-Bit One-Shot/Periodic Timer Mode .....	445
11.4.2	32-Bit Real-Time Clock (RTC) Mode .....	446
11.4.3	16-Bit One-Shot/Periodic Timer Mode .....	446
11.4.4	Input Edge-Count Mode .....	447
11.4.5	16-Bit Input Edge Timing Mode .....	447
11.4.6	16-Bit PWM Mode .....	448
11.5	Register Map .....	448
11.6	Register Descriptions .....	449
<b>12</b>	<b>Watchdog Timers .....</b>	<b>481</b>
12.1	Block Diagram .....	482
12.2	Functional Description .....	482
12.2.1	Register Access Timing .....	483

12.3	Initialization and Configuration .....	483
12.4	Register Map .....	483
12.5	Register Descriptions .....	484
<b>13</b>	<b>Analog-to-Digital Converter (ADC) .....</b>	<b>506</b>
13.1	Block Diagram .....	507
13.2	Signal Description .....	508
13.3	Functional Description .....	509
13.3.1	Sample Sequencers .....	509
13.3.2	Module Control .....	510
13.3.3	Hardware Sample Averaging Circuit .....	513
13.3.4	Analog-to-Digital Converter .....	513
13.3.5	Differential Sampling .....	515
13.3.6	Internal Temperature Sensor .....	518
13.3.7	Digital Comparator Unit .....	518
13.4	Initialization and Configuration .....	523
13.4.1	Module Initialization .....	523
13.4.2	Sample Sequencer Configuration .....	524
13.5	Register Map .....	524
13.6	Register Descriptions .....	526
<b>14</b>	<b>Universal Asynchronous Receivers/Transmitters (UARTs) .....</b>	<b>584</b>
14.1	Block Diagram .....	585
14.2	Signal Description .....	585
14.3	Functional Description .....	587
14.3.1	Transmit/Receive Logic .....	588
14.3.2	Baud-Rate Generation .....	588
14.3.3	Data Transmission .....	589
14.3.4	Serial IR (SIR) .....	589
14.3.5	ISO 7816 Support .....	590
14.3.6	Modem Handshake Support .....	590
14.3.7	LIN Support .....	592
14.3.8	FIFO Operation .....	593
14.3.9	Interrupts .....	593
14.3.10	Loopback Operation .....	594
14.3.11	DMA Operation .....	594
14.4	Initialization and Configuration .....	595
14.5	Register Map .....	596
14.6	Register Descriptions .....	597
<b>15</b>	<b>Synchronous Serial Interface (SSI) .....</b>	<b>646</b>
15.1	Block Diagram .....	647
15.2	Signal Description .....	647
15.3	Functional Description .....	648
15.3.1	Bit Rate Generation .....	649
15.3.2	FIFO Operation .....	649
15.3.3	Interrupts .....	649
15.3.4	Frame Formats .....	650
15.3.5	DMA Operation .....	657
15.4	Initialization and Configuration .....	658
15.5	Register Map .....	659

15.6	Register Descriptions .....	660
<b>16</b>	<b>Inter-Integrated Circuit (I<sup>2</sup>C) Interface .....</b>	<b>688</b>
16.1	Block Diagram .....	689
16.2	Signal Description .....	689
16.3	Functional Description .....	690
16.3.1	I <sup>2</sup> C Bus Functional Overview .....	690
16.3.2	Available Speed Modes .....	692
16.3.3	Interrupts .....	693
16.3.4	Loopback Operation .....	694
16.3.5	Command Sequence Flow Charts .....	694
16.4	Initialization and Configuration .....	701
16.5	Register Map .....	702
16.6	Register Descriptions (I <sup>2</sup> C Master) .....	703
16.7	Register Descriptions (I <sup>2</sup> C Slave) .....	716
<b>17</b>	<b>Inter-Integrated Circuit Sound (I<sup>2</sup>S) Interface .....</b>	<b>725</b>
17.1	Block Diagram .....	726
17.2	Signal Description .....	726
17.3	Functional Description .....	727
17.3.1	Transmit .....	729
17.3.2	Receive .....	733
17.4	Initialization and Configuration .....	735
17.5	Register Map .....	736
17.6	Register Descriptions .....	737
<b>18</b>	<b>Controller Area Network (CAN) Module .....</b>	<b>762</b>
18.1	Block Diagram .....	763
18.2	Signal Description .....	763
18.3	Functional Description .....	764
18.3.1	Initialization .....	765
18.3.2	Operation .....	766
18.3.3	Transmitting Message Objects .....	767
18.3.4	Configuring a Transmit Message Object .....	767
18.3.5	Updating a Transmit Message Object .....	768
18.3.6	Accepting Received Message Objects .....	769
18.3.7	Receiving a Data Frame .....	769
18.3.8	Receiving a Remote Frame .....	769
18.3.9	Receive/Transmit Priority .....	770
18.3.10	Configuring a Receive Message Object .....	770
18.3.11	Handling of Received Message Objects .....	771
18.3.12	Handling of Interrupts .....	773
18.3.13	Test Mode .....	774
18.3.14	Bit Timing Configuration Error Considerations .....	776
18.3.15	Bit Time and Bit Rate .....	776
18.3.16	Calculating the Bit Timing Parameters .....	778
18.4	Register Map .....	781
18.5	CAN Register Descriptions .....	782
<b>19</b>	<b>Ethernet Controller .....</b>	<b>814</b>
19.1	Block Diagram .....	815

19.2	Signal Description .....	816
19.3	Functional Description .....	817
19.3.1	MAC Operation .....	817
19.3.2	Internal MII Operation .....	820
19.3.3	PHY Operation .....	821
19.3.4	Interrupts .....	823
19.3.5	DMA Operation .....	824
19.4	Initialization and Configuration .....	824
19.4.1	Hardware Configuration .....	824
19.4.2	Software Configuration .....	825
19.5	Register Map .....	826
19.6	Ethernet MAC Register Descriptions .....	828
19.7	MII Management Register Descriptions .....	854
<b>20</b>	<b>Universal Serial Bus (USB) Controller .....</b>	<b>875</b>
20.1	Block Diagram .....	876
20.2	Signal Description .....	876
20.3	Functional Description .....	878
20.3.1	Operation as a Device .....	878
20.3.2	Operation as a Host .....	883
20.3.3	OTG Mode .....	887
20.3.4	DMA Operation .....	889
20.4	Initialization and Configuration .....	890
20.4.1	Pin Configuration .....	890
20.4.2	Endpoint Configuration .....	890
20.5	Register Map .....	891
20.6	Register Descriptions .....	902
<b>21</b>	<b>Analog Comparators .....</b>	<b>1014</b>
21.1	Block Diagram .....	1015
21.2	Signal Description .....	1015
21.3	Functional Description .....	1016
21.3.1	Internal Reference Programming .....	1017
21.4	Initialization and Configuration .....	1018
21.5	Register Map .....	1019
21.6	Register Descriptions .....	1019
<b>22</b>	<b>Pulse Width Modulator (PWM) .....</b>	<b>1027</b>
22.1	Block Diagram .....	1028
22.2	Signal Description .....	1029
22.3	Functional Description .....	1032
22.3.1	PWM Timer .....	1032
22.3.2	PWM Comparators .....	1032
22.3.3	PWM Signal Generator .....	1034
22.3.4	Dead-Band Generator .....	1035
22.3.5	Interrupt/ADC-Trigger Selector .....	1035
22.3.6	Synchronization Methods .....	1035
22.3.7	Fault Conditions .....	1036
22.3.8	Output Control Block .....	1037
22.4	Initialization and Configuration .....	1038
22.5	Register Map .....	1039



22.6	Register Descriptions .....	1041
<b>23</b>	<b>Quadrature Encoder Interface (QEI) .....</b>	<b>1104</b>
23.1	Block Diagram .....	1104
23.2	Signal Description .....	1105
23.3	Functional Description .....	1106
23.4	Initialization and Configuration .....	1108
23.5	Register Map .....	1109
23.6	Register Descriptions .....	1110
<b>24</b>	<b>Pin Diagram .....</b>	<b>1127</b>
<b>25</b>	<b>Signal Tables .....</b>	<b>1129</b>
25.1	100-Pin LQFP Package Pin Tables .....	1130
25.2	108-Pin BGA Package Pin Tables .....	1165
25.3	Connections for Unused Signals .....	1202
<b>26</b>	<b>Operating Characteristics .....</b>	<b>1204</b>
<b>27</b>	<b>Electrical Characteristics .....</b>	<b>1205</b>
27.1	DC Characteristics .....	1205
27.1.1	Maximum Ratings .....	1205
27.1.2	Recommended DC Operating Conditions .....	1205
27.1.3	On-Chip Low Drop-Out (LDO) Regulator Characteristics .....	1206
27.1.4	Flash Memory Characteristics .....	1206
27.1.5	GPIO Module Characteristics .....	1206
27.1.6	USB Module Characteristics .....	1207
27.1.7	Ethernet Controller Characteristics .....	1207
27.1.8	Current Specifications .....	1207
27.2	AC Characteristics .....	1207
27.2.1	Load Conditions .....	1207
27.2.2	Clocks .....	1208
27.2.3	JTAG and Boundary Scan .....	1210
27.2.4	Reset .....	1211
27.2.5	Sleep Modes .....	1213
27.2.6	General-Purpose I/O (GPIO) .....	1213
27.2.7	External Peripheral Interface (EPI) .....	1213
27.2.8	Analog-to-Digital Converter .....	1218
27.2.9	Synchronous Serial Interface (SSI) .....	1219
27.2.10	Inter-Integrated Circuit (I <sup>2</sup> C) Interface .....	1221
27.2.11	Inter-Integrated Circuit Sound (I <sup>2</sup> S) Interface .....	1221
27.2.12	Ethernet Controller .....	1223
27.2.13	Universal Serial Bus (USB) Controller .....	1226
27.2.14	Analog Comparator .....	1226
<b>A</b>	<b>Register Quick Reference .....</b>	<b>1227</b>
<b>B</b>	<b>Ordering and Contact Information .....</b>	<b>1276</b>
B.1	Ordering Information .....	1276
B.2	Part Markings .....	1276
B.3	Kits .....	1277
B.4	Support Information .....	1277
<b>C</b>	<b>Package Information .....</b>	<b>1278</b>

## List of Figures

Figure 1-1.	Stellaris® LM3S9B96 Microcontroller High-Level Block Diagram .....	68
Figure 2-1.	CPU Block Diagram .....	71
Figure 2-2.	TPIU Block Diagram .....	79
Figure 5-1.	JTAG Module Block Diagram .....	90
Figure 5-2.	Test Access Port State Machine .....	93
Figure 5-3.	IDCODE Register Format .....	99
Figure 5-4.	BYPASS Register Format .....	99
Figure 5-5.	Boundary Scan Register Format .....	100
Figure 6-1.	Basic $\overline{RST}$ Configuration .....	103
Figure 6-2.	External Circuitry to Extend Power-On Reset .....	104
Figure 6-3.	Reset Circuit Controlled by Switch .....	104
Figure 6-4.	Power Architecture .....	107
Figure 6-5.	Main Clock Tree .....	110
Figure 7-1.	Internal Memory Block Diagram .....	209
Figure 8-1.	$\mu$ DMA Block Diagram .....	247
Figure 8-2.	Example of Ping-Pong $\mu$ DMA Transaction .....	253
Figure 8-3.	Memory Scatter-Gather, Setup and Configuration .....	255
Figure 8-4.	Memory Scatter-Gather, $\mu$ DMA Copy Sequence .....	256
Figure 8-5.	Peripheral Scatter-Gather, Setup and Configuration .....	258
Figure 8-6.	Peripheral Scatter-Gather, $\mu$ DMA Copy Sequence .....	259
Figure 9-1.	Digital I/O Pads .....	309
Figure 9-2.	Analog/Digital I/O Pads .....	310
Figure 9-3.	GPIO DATA Write Example .....	311
Figure 9-4.	GPIO DATA Read Example .....	311
Figure 10-1.	EPI Block Diagram .....	362
Figure 10-2.	SDRAM Non-Blocking Read Cycle .....	369
Figure 10-3.	SDRAM Normal Read Cycle .....	370
Figure 10-4.	SDRAM Write Cycle .....	371
Figure 10-5.	Host-Bus Read Cycle, MODE = 0x1, WRHIGH = 1, RDHIGH = 1 .....	378
Figure 10-6.	Host-Bus Write Cycle, MODE = 0x1, WRHIGH = 1, RDHIGH = 1 .....	378
Figure 10-7.	Host-Bus Write Cycle with Multiplexed Address and Data, MODE = 0x0, WRHIGH = 1, RDHIGH = 1 .....	379
Figure 10-8.	Continuous Read Mode Accesses .....	379
Figure 10-9.	Write Followed by Read to External FIFO .....	380
Figure 10-10.	Two-Entry FIFO .....	380
Figure 10-11.	Single-Cycle Write Access, FRM50=0, FRMCNT=0, WRCYC=0 .....	384
Figure 10-12.	Two-Cycle Read, Write Accesses, FRM50=0, FRMCNT=0, RDCYC=1, WRCYC=1 .....	384
Figure 10-13.	Read Accesses, FRM50=0, FRMCNT=0, RDCYC=1 .....	385
Figure 10-14.	FRAME Signal Operation, FRM50=0 and FRMCNT=0 .....	385
Figure 10-15.	FRAME Signal Operation, FRM50=0 and FRMCNT=1 .....	385
Figure 10-16.	FRAME Signal Operation, FRM50=0 and FRMCNT=2 .....	386
Figure 10-17.	FRAME Signal Operation, FRM50=1 and FRMCNT=0 .....	386
Figure 10-18.	FRAME Signal Operation, FRM50=1 and FRMCNT=1 .....	386
Figure 10-19.	FRAME Signal Operation, FRM50=1 and FRMCNT=2 .....	386
Figure 10-20.	iRDY Signal Operation, FRM50=0, FRMCNT=0, and RD2CYC=1 .....	387

Figure 10-21. EPI Clock Operation, CLKGATE=1, WR2CYC=0 .....	387
Figure 10-22. EPI Clock Operation, CLKGATE=1, WR2CYC=1 .....	388
Figure 11-1. GPTM Module Block Diagram .....	434
Figure 11-2. 16-Bit Input Edge-Count Mode Example .....	441
Figure 11-3. 16-Bit Input Edge-Time Mode Example .....	443
Figure 11-4. 16-Bit PWM Mode Example .....	444
Figure 11-5. Timer Daisy Chain .....	444
Figure 12-1. WDT Module Block Diagram .....	482
Figure 13-1. Implementation of Two ADC Blocks .....	507
Figure 13-2. ADC Module Block Diagram .....	507
Figure 13-3. ADC Sample Phases .....	512
Figure 13-4. Doubling the ADC Sample Rate .....	512
Figure 13-5. Skewed Sampling .....	513
Figure 13-6. Internal Voltage Conversion Result .....	514
Figure 13-7. External Voltage Conversion Result .....	515
Figure 13-8. Differential Sampling Range, $V_{IN\_ODD} = 1.5\text{ V}$ .....	516
Figure 13-9. Differential Sampling Range, $V_{IN\_ODD} = 0.75\text{ V}$ .....	517
Figure 13-10. Differential Sampling Range, $V_{IN\_ODD} = 2.25\text{ V}$ .....	517
Figure 13-11. Internal Temperature Sensor Characteristic .....	518
Figure 13-12. Low-Band Operation (CIC=0x0 and/or CTC=0x0) .....	521
Figure 13-13. Mid-Band Operation (CIC=0x1 and/or CTC=0x1) .....	522
Figure 13-14. High-Band Operation (CIC=0x3 and/or CTC=0x3) .....	523
Figure 14-1. UART Module Block Diagram .....	585
Figure 14-2. UART Character Frame .....	588
Figure 14-3. IrDA Data Modulation .....	590
Figure 14-4. LIN Message .....	592
Figure 14-5. LIN Synchronization Field .....	593
Figure 15-1. SSI Module Block Diagram .....	647
Figure 15-2. TI Synchronous Serial Frame Format (Single Transfer) .....	651
Figure 15-3. TI Synchronous Serial Frame Format (Continuous Transfer) .....	651
Figure 15-4. Freescale SPI Format (Single Transfer) with SPO=0 and SPH=0 .....	652
Figure 15-5. Freescale SPI Format (Continuous Transfer) with SPO=0 and SPH=0 .....	652
Figure 15-6. Freescale SPI Frame Format with SPO=0 and SPH=1 .....	653
Figure 15-7. Freescale SPI Frame Format (Single Transfer) with SPO=1 and SPH=0 .....	654
Figure 15-8. Freescale SPI Frame Format (Continuous Transfer) with SPO=1 and SPH=0 .....	654
Figure 15-9. Freescale SPI Frame Format with SPO=1 and SPH=1 .....	655
Figure 15-10. MICROWIRE Frame Format (Single Frame) .....	656
Figure 15-11. MICROWIRE Frame Format (Continuous Transfer) .....	657
Figure 15-12. MICROWIRE Frame Format, SSIFss Input Setup and Hold Requirements .....	657
Figure 16-1. I <sup>2</sup> C Block Diagram .....	689
Figure 16-2. I <sup>2</sup> C Bus Configuration .....	690
Figure 16-3. START and STOP Conditions .....	691
Figure 16-4. Complete Data Transfer with a 7-Bit Address .....	691
Figure 16-5. R/S Bit in First Byte .....	691
Figure 16-6. Data Validity During Bit Transfer on the I <sup>2</sup> C Bus .....	692
Figure 16-7. Master Single TRANSMIT .....	695
Figure 16-8. Master Single RECEIVE .....	696
Figure 16-9. Master TRANSMIT with Repeated START .....	697

Figure 16-10. Master RECEIVE with Repeated START .....	698
Figure 16-11. Master RECEIVE with Repeated START after TRANSMIT with Repeated START .....	699
Figure 16-12. Master TRANSMIT with Repeated START after RECEIVE with Repeated START .....	700
Figure 16-13. Slave Command Sequence .....	701
Figure 17-1. I <sup>2</sup> S Block Diagram .....	726
Figure 17-2. I <sup>2</sup> S Data Transfer .....	729
Figure 17-3. Left-Justified Data Transfer .....	729
Figure 17-4. Right-Justified Data Transfer .....	729
Figure 18-1. CAN Controller Block Diagram .....	763
Figure 18-2. CAN Data/Remote Frame .....	765
Figure 18-3. Message Objects in a FIFO Buffer .....	773
Figure 18-4. CAN Bit Time .....	777
Figure 19-1. Ethernet Controller .....	815
Figure 19-2. Ethernet Controller Block Diagram .....	815
Figure 19-3. Ethernet Frame .....	817
Figure 19-4. Interface to an Ethernet Jack .....	825
Figure 20-1. USB Module Block Diagram .....	876
Figure 21-1. Analog Comparator Module Block Diagram .....	1015
Figure 21-2. Structure of Comparator Unit .....	1017
Figure 21-3. Comparator Internal Reference Structure .....	1017
Figure 22-1. PWM Unit Diagram .....	1029
Figure 22-2. PWM Module Block Diagram .....	1029
Figure 22-3. PWM Count-Down Mode .....	1033
Figure 22-4. PWM Count-Up/Down Mode .....	1034
Figure 22-5. PWM Generation Example In Count-Up/Down Mode .....	1034
Figure 22-6. PWM Dead-Band Generator .....	1035
Figure 23-1. QEI Block Diagram .....	1105
Figure 23-2. Quadrature Encoder and Velocity Predivider Operation .....	1107
Figure 24-1. 100-Pin LQFP Package Pin Diagram .....	1127
Figure 24-2. 108-Ball BGA Package Pin Diagram (Top View) .....	1128
Figure 27-1. Load Conditions .....	1208
Figure 27-2. JTAG Test Clock Input Timing .....	1210
Figure 27-3. JTAG Test Access Port (TAP) Timing .....	1211
Figure 27-4. External Reset Timing ( $\overline{\text{RST}}$ ) .....	1211
Figure 27-5. Power-On Reset Timing .....	1212
Figure 27-6. Brown-Out Reset Timing .....	1212
Figure 27-7. Software Reset Timing .....	1212
Figure 27-8. Watchdog Reset Timing .....	1212
Figure 27-9. MOSC Failure Reset Timing .....	1213
Figure 27-10. SDRAM Initialization and Load Mode Register Timing .....	1214
Figure 27-11. SDRAM Read Timing .....	1215
Figure 27-12. SDRAM Write Timing .....	1215
Figure 27-13. Host-Bus 8/16 Mode Read Timing .....	1216
Figure 27-14. Host-Bus 8/16 Mode Write Timing .....	1216
Figure 27-15. General-Purpose Mode Read and Write Timing .....	1217
Figure 27-16. General-Purpose Mode iRDY Timing .....	1217

---

Figure 27-17. ADC Input Equivalency Diagram .....	1219
Figure 27-18. SSI Timing for TI Frame Format (FRF=01), Single Transfer Timing Measurement .....	1220
Figure 27-19. SSI Timing for MICROWIRE Frame Format (FRF=10), Single Transfer .....	1220
Figure 27-20. SSI Timing for SPI Frame Format (FRF=00), with SPH=1 .....	1221
Figure 27-21. I <sup>2</sup> C Timing .....	1221
Figure 27-22. I <sup>2</sup> S Master Mode Transmit Timing .....	1222
Figure 27-23. I <sup>2</sup> S Master Mode Receive Timing .....	1222
Figure 27-24. I <sup>2</sup> S Slave Mode Transmit Timing .....	1223
Figure 27-25. I <sup>2</sup> S Slave Mode Receive Timing .....	1223
Figure 27-26. External XTLP Oscillator Characteristics .....	1225
Figure C-1. 100-Pin LQFP Package .....	1278
Figure C-2. 108-Ball BGA Package .....	1280

## List of Tables

Table 1.	Revision History .....	37
Table 2.	Documentation Conventions .....	43
Table 2-1.	16-Bit Cortex-M3 Instruction Set Summary .....	72
Table 2-2.	32-Bit Cortex-M3 Instruction Set Summary .....	74
Table 3-1.	Memory Map .....	83
Table 4-1.	Exception Types .....	86
Table 4-2.	Interrupts .....	87
Table 5-1.	Signals for JTAG_SWD_SWO (100LQFP) .....	90
Table 5-2.	Signals for JTAG_SWD_SWO (108BGA) .....	91
Table 5-3.	JTAG Port Pins State after Power-On Reset or $\overline{\text{RST}}$ assertion .....	92
Table 5-4.	JTAG Instruction Register Commands .....	97
Table 6-1.	Signals for System Control & Clocks (100LQFP) .....	101
Table 6-2.	Signals for System Control & Clocks (108BGA) .....	101
Table 6-3.	Reset Sources .....	102
Table 6-4.	Clock Source Options .....	108
Table 6-5.	Possible System Clock Frequencies Using the SYSDIV Field .....	111
Table 6-6.	Examples of Possible System Clock Frequencies Using the SYSDIV2 Field .....	111
Table 6-7.	Examples of Possible System Clock Frequencies with DIV400=1 .....	112
Table 6-8.	System Control Register Map .....	116
Table 6-9.	RCC2 Fields that Override RCC fields .....	137
Table 7-1.	Flash Memory Protection Policy Combinations .....	213
Table 7-2.	User-Programmable Flash Memory Resident Registers .....	216
Table 7-3.	Flash Register Map .....	216
Table 8-1.	$\mu$ DMA Channel Assignments .....	248
Table 8-2.	Request Type Support .....	250
Table 8-3.	Control Structure Memory Map .....	251
Table 8-4.	Channel Control Structure .....	251
Table 8-5.	$\mu$ DMA Read Example: 8-Bit Peripheral .....	260
Table 8-6.	$\mu$ DMA Interrupt Assignments .....	261
Table 8-7.	Channel Control Structure Offsets for Channel 30 .....	262
Table 8-8.	Channel Control Word Configuration for Memory Transfer Example .....	262
Table 8-9.	Channel Control Structure Offsets for Channel 7 .....	263
Table 8-10.	Channel Control Word Configuration for Peripheral Transmit Example .....	264
Table 8-11.	Primary and Alternate Channel Control Structure Offsets for Channel 8 .....	265
Table 8-12.	Channel Control Word Configuration for Peripheral Ping-Pong Receive Example .....	266
Table 8-13.	$\mu$ DMA Register Map .....	267
Table 9-1.	GPIO Pins With Non-Zero Reset Values .....	305
Table 9-2.	GPIO Pins and Alternate Functions (100LQFP) .....	305
Table 9-3.	GPIO Pins and Alternate Functions (108BGA) .....	307
Table 9-4.	GPIO Pad Configuration Examples .....	313
Table 9-5.	GPIO Interrupt Configuration Example .....	314
Table 9-6.	GPIO Pins With Non-Zero Reset Values .....	315
Table 9-7.	GPIO Register Map .....	316
Table 9-8.	GPIO Pins With Non-Zero Reset Values .....	328
Table 9-9.	GPIO Pins With Non-Zero Reset Values .....	334

Table 9-10.	GPIO Pins With Non-Zero Reset Values .....	336
Table 9-11.	GPIO Pins With Non-Zero Reset Values .....	339
Table 9-12.	GPIO Pins With Non-Zero Reset Values .....	346
Table 10-1.	Signals for External Peripheral Interface (100LQFP) .....	362
Table 10-2.	Signals for External Peripheral Interface (108BGA) .....	363
Table 10-3.	EPI SDRAM Signal Connections .....	368
Table 10-4.	Capabilities of Host Bus 8 and Host Bus 16 Modes .....	372
Table 10-5.	EPI Host-Bus 8 Signal Connections .....	373
Table 10-6.	EPI Host-Bus 16 Signal Connections .....	374
Table 10-7.	EPI General Purpose Signal Connections .....	382
Table 10-8.	External Peripheral Interface (EPI) Register Map .....	388
Table 11-1.	Available CCP Pins .....	434
Table 11-2.	Signals for General-Purpose Timers (100LQFP) .....	435
Table 11-3.	Signals for General-Purpose Timers (108BGA) .....	436
Table 11-4.	16-Bit Timer With Prescaler Configurations .....	440
Table 11-5.	Timers Register Map .....	449
Table 12-1.	Watchdog Timers Register Map .....	484
Table 13-1.	Signals for ADC (100LQFP) .....	508
Table 13-2.	Signals for ADC (108BGA) .....	508
Table 13-3.	Samples and FIFO Depth of Sequencers .....	509
Table 13-4.	Differential Sampling Pairs .....	515
Table 13-5.	ADC Register Map .....	524
Table 14-1.	Signals for UART (100LQFP) .....	586
Table 14-2.	Signals for UART (108BGA) .....	586
Table 14-3.	Flow Control Mode .....	591
Table 14-4.	UART Register Map .....	596
Table 15-1.	Signals for SSI (100LQFP) .....	648
Table 15-2.	Signals for SSI (108BGA) .....	648
Table 15-3.	SSI Register Map .....	659
Table 16-1.	Signals for I <sup>2</sup> C (100LQFP) .....	689
Table 16-2.	Signals for I <sup>2</sup> C (108BGA) .....	689
Table 16-3.	Examples of I <sup>2</sup> C Master Timer Period versus Speed Mode .....	693
Table 16-4.	Inter-Integrated Circuit (I <sup>2</sup> C) Interface Register Map .....	702
Table 16-5.	Write Field Decoding for I <sup>2</sup> CMCS[3:0] Field .....	708
Table 17-1.	Signals for I <sup>2</sup> S (100LQFP) .....	727
Table 17-2.	Signals for I <sup>2</sup> S (108BGA) .....	727
Table 17-3.	I <sup>2</sup> S Transmit FIFO Interface .....	730
Table 17-4.	Crystal Frequency (Values from 3.5795 MHz to 5 MHz) .....	731
Table 17-5.	Crystal Frequency (Values from 5.12 MHz to 8.192 MHz) .....	731
Table 17-6.	Crystal Frequency (Values from 10 MHz to 14.3181 MHz) .....	732
Table 17-7.	Crystal Frequency (Values from 16 MHz to 16.384 MHz) .....	732
Table 17-8.	I <sup>2</sup> S Receive FIFO Interface .....	734
Table 17-9.	Audio Formats Configuration .....	736
Table 17-10.	Inter-Integrated Circuit Sound (I <sup>2</sup> S) Interface Register Map .....	737
Table 18-1.	Signals for Controller Area Network (100LQFP) .....	764
Table 18-2.	Signals for Controller Area Network (108BGA) .....	764
Table 18-3.	Message Object Configurations .....	770
Table 18-4.	CAN Protocol Ranges .....	777

Table 18-5.	CANBIT Register Values .....	777
Table 18-6.	CAN Register Map .....	781
Table 19-1.	Signals for Ethernet (100LQFP) .....	816
Table 19-2.	Signals for Ethernet (108BGA) .....	816
Table 19-3.	TX & RX FIFO Organization .....	819
Table 19-4.	Ethernet Register Map .....	826
Table 20-1.	Signals for USB (100LQFP) .....	876
Table 20-2.	Signals for USB (108BGA) .....	877
Table 20-3.	Remainder (RxMaxP/4) .....	889
Table 20-4.	Actual Bytes Read .....	889
Table 20-5.	Packet Sizes That Clear RXRDY .....	889
Table 20-6.	Universal Serial Bus (USB) Controller Register Map .....	891
Table 21-1.	Signals for Analog Comparators (100LQFP) .....	1015
Table 21-2.	Signals for Analog Comparators (108BGA) .....	1016
Table 21-3.	Internal Reference Voltage and ACREFACTL Field Values .....	1018
Table 21-4.	Analog Comparators Register Map .....	1019
Table 22-1.	Signals for PWM (100LQFP) .....	1030
Table 22-2.	Signals for PWM (108BGA) .....	1031
Table 22-3.	PWM Register Map .....	1039
Table 23-1.	Signals for QEI (100LQFP) .....	1105
Table 23-2.	Signals for QEI (108BGA) .....	1106
Table 23-3.	QEI Register Map .....	1109
Table 25-1.	GPIO Pins With Default Alternate Functions .....	1129
Table 25-2.	Signals by Pin Number .....	1130
Table 25-3.	Signals by Signal Name .....	1141
Table 25-4.	Signals by Function, Except for GPIO .....	1151
Table 25-5.	GPIO Pins and Alternate Functions .....	1160
Table 25-6.	Possible Pin Assignments for Alternate Functions .....	1163
Table 25-7.	Signals by Pin Number .....	1165
Table 25-8.	Signals by Signal Name .....	1177
Table 25-9.	Signals by Function, Except for GPIO .....	1188
Table 25-10.	GPIO Pins and Alternate Functions .....	1197
Table 25-11.	Possible Pin Assignments for Alternate Functions .....	1200
Table 25-12.	Connections for Unused Signals (100-pin LQFP) .....	1202
Table 25-13.	Connections for Unused Signals, 108-pin BGA .....	1203
Table 26-1.	Temperature Characteristics .....	1204
Table 26-2.	Thermal Characteristics .....	1204
Table 26-3.	ESD Absolute Maximum Ratings .....	1204
Table 27-1.	Maximum Ratings .....	1205
Table 27-2.	Recommended DC Operating Conditions .....	1205
Table 27-3.	LDO Regulator Characteristics .....	1206
Table 27-4.	Flash Memory Characteristics .....	1206
Table 27-5.	GPIO Module DC Characteristics .....	1206
Table 27-6.	USB Controller DC Characteristics .....	1207
Table 27-7.	Ethernet Controller DC Characteristics .....	1207
Table 27-8.	Preliminary Current Consumption .....	1207
Table 27-9.	Phase Locked Loop (PLL) Characteristics .....	1208
Table 27-10.	Actual PLL Frequency .....	1208



Table 27-11.	PIOSC Clock Characteristics .....	1209
Table 27-12.	30-kHz Clock Characteristics .....	1209
Table 27-13.	Main Oscillator Clock Characteristics .....	1209
Table 27-14.	MOSC Oscillator Input Characteristics .....	1209
Table 27-15.	System Clock Characteristics with ADC Operation .....	1210
Table 27-16.	JTAG Characteristics .....	1210
Table 27-17.	Reset Characteristics .....	1211
Table 27-18.	Sleep Modes AC Characteristics .....	1213
Table 27-19.	GPIO Characteristics .....	1213
Table 27-20.	EPI SDRAM Characteristics .....	1213
Table 27-21.	EPI SDRAM Interface Characteristics .....	1214
Table 27-22.	EPI Host-Bus 8 and Host-Bus 16 Interface Characteristics .....	1215
Table 27-23.	EPI General-Purpose Interface Characteristics .....	1216
Table 27-24.	ADC Characteristics .....	1218
Table 27-25.	ADC Module External Reference Characteristics .....	1219
Table 27-26.	ADC Module Internal Reference Characteristics .....	1219
Table 27-27.	SSI Characteristics .....	1219
Table 27-28.	I <sup>2</sup> S Master Clock (Receive and Transmit) .....	1221
Table 27-29.	I <sup>2</sup> S Slave Clock (Receive and Transmit) .....	1221
Table 27-30.	I <sup>2</sup> S Master Mode .....	1222
Table 27-31.	I <sup>2</sup> S Slave Mode .....	1222
Table 27-32.	100BASE-TX Transmitter Characteristics .....	1223
Table 27-33.	100BASE-TX Transmitter Characteristics (informative) .....	1223
Table 27-34.	100BASE-TX Receiver Characteristics .....	1223
Table 27-35.	10BASE-T Transmitter Characteristics .....	1224
Table 27-36.	10BASE-T Transmitter Characteristics (informative) .....	1224
Table 27-37.	10BASE-T Receiver Characteristics .....	1224
Table 27-38.	Isolation Transformers .....	1224
Table 27-39.	Ethernet Reference Crystal .....	1225
Table 27-40.	External XTLP Oscillator Characteristics .....	1225
Table 27-41.	Analog Comparator Characteristics .....	1226
Table 27-42.	Analog Comparator Voltage Reference Characteristics .....	1226
Table B-1.	Part Ordering Information .....	1276

## List of Registers

<b>System Control</b> .....	<b>101</b>
Register 1: Device Identification 0 (DID0), offset 0x000 .....	118
Register 2: Brown-Out Reset Control (PBORCTL), offset 0x030 .....	120
Register 3: Raw Interrupt Status (RIS), offset 0x050 .....	121
Register 4: Interrupt Mask Control (IMC), offset 0x054 .....	123
Register 5: Masked Interrupt Status and Clear (MISC), offset 0x058 .....	125
Register 6: Reset Cause (RESC), offset 0x05C .....	127
Register 7: Run-Mode Clock Configuration (RCC), offset 0x060 .....	129
Register 8: XTAL to PLL Translation (PLLCFG), offset 0x064 .....	134
Register 9: GPIO High-Performance Bus Control (GPIOHBCTL), offset 0x06C .....	135
Register 10: Run-Mode Clock Configuration 2 (RCC2), offset 0x070 .....	137
Register 11: Main Oscillator Control (MOSCCTL), offset 0x07C .....	140
Register 12: Deep Sleep Clock Configuration (DSLPCCLKCFG), offset 0x144 .....	141
Register 13: Precision Internal Oscillator Calibration (PIOSCCAL), offset 0x150 .....	143
Register 14: I <sup>2</sup> S MCLK Configuration (I2SMCLKCFG), offset 0x170 .....	144
Register 15: Device Identification 1 (DID1), offset 0x004 .....	146
Register 16: Device Capabilities 0 (DC0), offset 0x008 .....	148
Register 17: Device Capabilities 1 (DC1), offset 0x010 .....	149
Register 18: Device Capabilities 2 (DC2), offset 0x014 .....	152
Register 19: Device Capabilities 3 (DC3), offset 0x018 .....	155
Register 20: Device Capabilities 4 (DC4), offset 0x01C .....	158
Register 21: Device Capabilities 5 (DC5), offset 0x020 .....	160
Register 22: Device Capabilities 6 (DC6), offset 0x024 .....	162
Register 23: Device Capabilities 7 (DC7), offset 0x028 .....	163
Register 24: Device Capabilities 8 ADC Channels (DC8), offset 0x02C .....	167
Register 25: Device Capabilities 9 ADC Digital Comparators (DC9), offset 0x190 .....	170
Register 26: Non-Volatile Memory Information (NVMSTAT), offset 0x1A0 .....	172
Register 27: Run Mode Clock Gating Control Register 0 (RCGC0), offset 0x100 .....	173
Register 28: Sleep Mode Clock Gating Control Register 0 (SCGC0), offset 0x110 .....	176
Register 29: Deep Sleep Mode Clock Gating Control Register 0 (DCGC0), offset 0x120 .....	179
Register 30: Run Mode Clock Gating Control Register 1 (RCGC1), offset 0x104 .....	181
Register 31: Sleep Mode Clock Gating Control Register 1 (SCGC1), offset 0x114 .....	185
Register 32: Deep-Sleep Mode Clock Gating Control Register 1 (DCGC1), offset 0x124 .....	189
Register 33: Run Mode Clock Gating Control Register 2 (RCGC2), offset 0x108 .....	193
Register 34: Sleep Mode Clock Gating Control Register 2 (SCGC2), offset 0x118 .....	196
Register 35: Deep Sleep Mode Clock Gating Control Register 2 (DCGC2), offset 0x128 .....	199
Register 36: Software Reset Control 0 (SRCR0), offset 0x040 .....	202
Register 37: Software Reset Control 1 (SRCR1), offset 0x044 .....	204
Register 38: Software Reset Control 2 (SRCR2), offset 0x048 .....	207
<b>Internal Memory</b> .....	<b>209</b>
Register 1: Flash Memory Address (FMA), offset 0x000 .....	218
Register 2: Flash Memory Data (FMD), offset 0x004 .....	219
Register 3: Flash Memory Control (FMC), offset 0x008 .....	220
Register 4: Flash Controller Raw Interrupt Status (FCRIS), offset 0x00C .....	222
Register 5: Flash Controller Interrupt Mask (FCIM), offset 0x010 .....	223

Register 6:	Flash Controller Masked Interrupt Status and Clear (FCMISC), offset 0x014 .....	224
Register 7:	Flash Memory Control 2 (FMC2), offset 0x020 .....	225
Register 8:	Flash Write Buffer Valid (FWBVAL), offset 0x030 .....	226
Register 9:	Flash Write Buffer n (FWBn), offset 0x100 - 0x17C .....	227
Register 10:	Flash Control (FCTL), offset 0x0F8 .....	228
Register 11:	ROM Control (RMCTL), offset 0x0F0 .....	229
Register 12:	ROM Version Register (RMVER), offset 0x0F4 .....	230
Register 13:	Flash Memory Protection Read Enable 0 (FMPRE0), offset 0x130 and 0x200 .....	231
Register 14:	Flash Memory Protection Program Enable 0 (FMPPE0), offset 0x134 and 0x400 .....	232
Register 15:	Boot Configuration (BOOTCFG), offset 0x1D0 .....	233
Register 16:	User Register 0 (USER_REG0), offset 0x1E0 .....	236
Register 17:	User Register 1 (USER_REG1), offset 0x1E4 .....	237
Register 18:	User Register 2 (USER_REG2), offset 0x1E8 .....	238
Register 19:	User Register 3 (USER_REG3), offset 0x1EC .....	239
Register 20:	Flash Memory Protection Read Enable 1 (FMPRE1), offset 0x204 .....	240
Register 21:	Flash Memory Protection Read Enable 2 (FMPRE2), offset 0x208 .....	241
Register 22:	Flash Memory Protection Read Enable 3 (FMPRE3), offset 0x20C .....	242
Register 23:	Flash Memory Protection Program Enable 1 (FMPPE1), offset 0x404 .....	243
Register 24:	Flash Memory Protection Program Enable 2 (FMPPE2), offset 0x408 .....	244
Register 25:	Flash Memory Protection Program Enable 3 (FMPPE3), offset 0x40C .....	245
<b>Micro Direct Memory Access (μDMA) .....</b>		<b>246</b>
Register 1:	DMA Channel Source Address End Pointer (DMASRCENDP), offset 0x000 .....	269
Register 2:	DMA Channel Destination Address End Pointer (DMADSTENDP), offset 0x004 .....	270
Register 3:	DMA Channel Control Word (DMACHCTL), offset 0x008 .....	271
Register 4:	DMA Status (DMASTAT), offset 0x000 .....	276
Register 5:	DMA Configuration (DMACFG), offset 0x004 .....	278
Register 6:	DMA Channel Control Base Pointer (DMACTLBASE), offset 0x008 .....	279
Register 7:	DMA Alternate Channel Control Base Pointer (DMAALTBASE), offset 0x00C .....	280
Register 8:	DMA Channel Wait-on-Request Status (DMAWAITSTAT), offset 0x010 .....	281
Register 9:	DMA Channel Software Request (DMASWREQ), offset 0x014 .....	282
Register 10:	DMA Channel Useburst Set (DMAUSEBURSTSET), offset 0x018 .....	283
Register 11:	DMA Channel Useburst Clear (DMAUSEBURSTCLR), offset 0x01C .....	284
Register 12:	DMA Channel Request Mask Set (DMAREQMASKSET), offset 0x020 .....	285
Register 13:	DMA Channel Request Mask Clear (DMAREQMASKCLR), offset 0x024 .....	286
Register 14:	DMA Channel Enable Set (DMAENASET), offset 0x028 .....	287
Register 15:	DMA Channel Enable Clear (DMAENACL), offset 0x02C .....	288
Register 16:	DMA Channel Primary Alternate Set (DMAALTSET), offset 0x030 .....	289
Register 17:	DMA Channel Primary Alternate Clear (DMAALTCLR), offset 0x034 .....	290
Register 18:	DMA Channel Priority Set (DMAPRIOSET), offset 0x038 .....	291
Register 19:	DMA Channel Priority Clear (DMAPRIOCLR), offset 0x03C .....	292
Register 20:	DMA Bus Error Clear (DMAERRCLR), offset 0x04C .....	293
Register 21:	DMA Channel Assignment (DMACHASGN), offset 0x500 .....	294
Register 22:	DMA Peripheral Identification 0 (DMAPeriphID0), offset 0xFE0 .....	295
Register 23:	DMA Peripheral Identification 1 (DMAPeriphID1), offset 0xFE4 .....	296
Register 24:	DMA Peripheral Identification 2 (DMAPeriphID2), offset 0xFE8 .....	297
Register 25:	DMA Peripheral Identification 3 (DMAPeriphID3), offset 0xFEC .....	298
Register 26:	DMA Peripheral Identification 4 (DMAPeriphID4), offset 0xFD0 .....	299
Register 27:	DMA PrimeCell Identification 0 (DMAPCellID0), offset 0xFF0 .....	300

Register 28:	DMA PrimeCell Identification 1 (DMAPCellID1), offset 0xFF4 .....	301
Register 29:	DMA PrimeCell Identification 2 (DMAPCellID2), offset 0xFF8 .....	302
Register 30:	DMA PrimeCell Identification 3 (DMAPCellID3), offset 0xFFC .....	303
<b>General-Purpose Input/Outputs (GPIOs) .....</b>		<b>304</b>
Register 1:	GPIO Data (GPIODATA), offset 0x000 .....	318
Register 2:	GPIO Direction (GPIODIR), offset 0x400 .....	319
Register 3:	GPIO Interrupt Sense (GPIOIS), offset 0x404 .....	320
Register 4:	GPIO Interrupt Both Edges (GPIOIBE), offset 0x408 .....	321
Register 5:	GPIO Interrupt Event (GPIOIEV), offset 0x40C .....	322
Register 6:	GPIO Interrupt Mask (GPIOIM), offset 0x410 .....	323
Register 7:	GPIO Raw Interrupt Status (GPIORIS), offset 0x414 .....	324
Register 8:	GPIO Masked Interrupt Status (GPIOMIS), offset 0x418 .....	325
Register 9:	GPIO Interrupt Clear (GPIOICR), offset 0x41C .....	327
Register 10:	GPIO Alternate Function Select (GPIOAFSEL), offset 0x420 .....	328
Register 11:	GPIO 2-mA Drive Select (GPIODR2R), offset 0x500 .....	330
Register 12:	GPIO 4-mA Drive Select (GPIODR4R), offset 0x504 .....	331
Register 13:	GPIO 8-mA Drive Select (GPIODR8R), offset 0x508 .....	332
Register 14:	GPIO Open Drain Select (GPIODR), offset 0x50C .....	333
Register 15:	GPIO Pull-Up Select (GPIOPUR), offset 0x510 .....	334
Register 16:	GPIO Pull-Down Select (GPIOPDR), offset 0x514 .....	336
Register 17:	GPIO Slew Rate Control Select (GPIOSLR), offset 0x518 .....	338
Register 18:	GPIO Digital Enable (GPIODEN), offset 0x51C .....	339
Register 19:	GPIO Lock (GPIOLOCK), offset 0x520 .....	341
Register 20:	GPIO Commit (GPIOCR), offset 0x524 .....	342
Register 21:	GPIO Analog Mode Select (GPIOAMSEL), offset 0x528 .....	344
Register 22:	GPIO Port Control (GPIOPCTL), offset 0x52C .....	346
Register 23:	GPIO Peripheral Identification 4 (GPIOPeriphID4), offset 0xFD0 .....	348
Register 24:	GPIO Peripheral Identification 5 (GPIOPeriphID5), offset 0xFD4 .....	349
Register 25:	GPIO Peripheral Identification 6 (GPIOPeriphID6), offset 0xFD8 .....	350
Register 26:	GPIO Peripheral Identification 7 (GPIOPeriphID7), offset 0xFDC .....	351
Register 27:	GPIO Peripheral Identification 0 (GPIOPeriphID0), offset 0xFE0 .....	352
Register 28:	GPIO Peripheral Identification 1 (GPIOPeriphID1), offset 0xFE4 .....	353
Register 29:	GPIO Peripheral Identification 2 (GPIOPeriphID2), offset 0xFE8 .....	354
Register 30:	GPIO Peripheral Identification 3 (GPIOPeriphID3), offset 0xFEC .....	355
Register 31:	GPIO PrimeCell Identification 0 (GPIOPCellID0), offset 0xFF0 .....	356
Register 32:	GPIO PrimeCell Identification 1 (GPIOPCellID1), offset 0xFF4 .....	357
Register 33:	GPIO PrimeCell Identification 2 (GPIOPCellID2), offset 0xFF8 .....	358
Register 34:	GPIO PrimeCell Identification 3 (GPIOPCellID3), offset 0xFFC .....	359
<b>External Peripheral Interface (EPI) .....</b>		<b>360</b>
Register 1:	EPI Configuration (EPICFG), offset 0x000 .....	390
Register 2:	EPI Main Baud Rate (EPIBAUD), offset 0x004 .....	392
Register 3:	EPI SDRAM Configuration (EPISDRAMCFG), offset 0x010 .....	394
Register 4:	EPI Host-Bus 8 Configuration (EPIHB8CFG), offset 0x010 .....	396
Register 5:	EPI Host-Bus 16 Configuration (EPIHB16CFG), offset 0x010 .....	400
Register 6:	EPI General-Purpose Configuration (EPIGPCFG), offset 0x010 .....	404
Register 7:	EPI Host-Bus 8 Configuration 2 (EPIHB8CFG2), offset 0x014 .....	409
Register 8:	EPI Host-Bus 16 Configuration 2 (EPIHB16CFG2), offset 0x014 .....	411
Register 9:	EPI General-Purpose Configuration 2 (EPIGPCFG2), offset 0x014 .....	413

Register 10:	EPI Address Map (EPIADDRMAP), offset 0x01C .....	414
Register 11:	EPI Read Size 0 (EPIRSIZE0), offset 0x020 .....	416
Register 12:	EPI Read Size 1 (EPIRSIZE1), offset 0x030 .....	416
Register 13:	EPI Read Address 0 (EPIRADDR0), offset 0x024 .....	417
Register 14:	EPI Read Address 1 (EPIRADDR1), offset 0x034 .....	417
Register 15:	EPI Non-Blocking Read Data 0 (EPIRPSTD0), offset 0x028 .....	418
Register 16:	EPI Non-Blocking Read Data 1 (EPIRPSTD1), offset 0x038 .....	418
Register 17:	EPI Status (EPISTAT), offset 0x060 .....	420
Register 18:	EPI Read FIFO Count (EPIRFIFOCNT), offset 0x06C .....	422
Register 19:	EPI Read FIFO (EPIREADFIFO), offset 0x070 .....	423
Register 20:	EPI Read FIFO Alias 1 (EPIREADFIFO1), offset 0x074 .....	423
Register 21:	EPI Read FIFO Alias 2 (EPIREADFIFO2), offset 0x078 .....	423
Register 22:	EPI Read FIFO Alias 3 (EPIREADFIFO3), offset 0x07C .....	423
Register 23:	EPI Read FIFO Alias 4 (EPIREADFIFO4), offset 0x080 .....	423
Register 24:	EPI Read FIFO Alias 5 (EPIREADFIFO5), offset 0x084 .....	423
Register 25:	EPI Read FIFO Alias 6 (EPIREADFIFO6), offset 0x088 .....	423
Register 26:	EPI Read FIFO Alias 7 (EPIREADFIFO7), offset 0x08C .....	423
Register 27:	EPI FIFO Level Selects (EPIFIFOLVL), offset 0x200 .....	424
Register 28:	EPI Write FIFO Count (EPIWFIFOCNT), offset 0x204 .....	426
Register 29:	EPI Interrupt Mask (EPIIM), offset 0x210 .....	427
Register 30:	EPI Raw Interrupt Status (EPIRIS), offset 0x214 .....	428
Register 31:	EPI Masked Interrupt Status (EPIMIS), offset 0x218 .....	430
Register 32:	EPI Error Interrupt Status and Clear (EPIEISC), offset 0x21C .....	431
<b>General-Purpose Timers .....</b>		<b>433</b>
Register 1:	GPTM Configuration (GPTMCFG), offset 0x000 .....	450
Register 2:	GPTM Timer A Mode (GPTMTAMR), offset 0x004 .....	451
Register 3:	GPTM Timer B Mode (GPTMTBMR), offset 0x008 .....	453
Register 4:	GPTM Control (GPTMCTL), offset 0x00C .....	455
Register 5:	GPTM Interrupt Mask (GPTMIMR), offset 0x018 .....	458
Register 6:	GPTM Raw Interrupt Status (GPTMRIS), offset 0x01C .....	460
Register 7:	GPTM Masked Interrupt Status (GPTMMIS), offset 0x020 .....	463
Register 8:	GPTM Interrupt Clear (GPTMICR), offset 0x024 .....	466
Register 9:	GPTM Timer A Interval Load (GPTMTAILR), offset 0x028 .....	468
Register 10:	GPTM Timer B Interval Load (GPTMTBILR), offset 0x02C .....	469
Register 11:	GPTM Timer A Match (GPTMTAMATCHR), offset 0x030 .....	470
Register 12:	GPTM Timer B Match (GPTMTBMATCHR), offset 0x034 .....	471
Register 13:	GPTM Timer A Prescale (GPTMTAPR), offset 0x038 .....	472
Register 14:	GPTM Timer B Prescale (GPTMTBPR), offset 0x03C .....	473
Register 15:	GPTM TimerA Prescale Match (GPTMTAPMR), offset 0x040 .....	474
Register 16:	GPTM TimerB Prescale Match (GPTMTBPMR), offset 0x044 .....	475
Register 17:	GPTM Timer A (GPTMTAR), offset 0x048 .....	476
Register 18:	GPTM Timer B (GPTMTBR), offset 0x04C .....	477
Register 19:	GPTM Timer A Value (GPTMTAV), offset 0x050 .....	479
Register 20:	GPTM Timer B Value (GPTMTBV), offset 0x054 .....	480
<b>Watchdog Timers .....</b>		<b>481</b>
Register 1:	Watchdog Load (WDTLOAD), offset 0x000 .....	485
Register 2:	Watchdog Value (WDTVALUE), offset 0x004 .....	486
Register 3:	Watchdog Control (WDTCTL), offset 0x008 .....	487

Register 4:	Watchdog Interrupt Clear (WDTICR), offset 0x00C .....	489
Register 5:	Watchdog Raw Interrupt Status (WDTRIS), offset 0x010 .....	490
Register 6:	Watchdog Masked Interrupt Status (WDTMIS), offset 0x014 .....	491
Register 7:	Watchdog Test (WDTTEST), offset 0x418 .....	492
Register 8:	Watchdog Lock (WDTLOCK), offset 0xC00 .....	493
Register 9:	Watchdog Peripheral Identification 4 (WDTPeriphID4), offset 0xFD0 .....	494
Register 10:	Watchdog Peripheral Identification 5 (WDTPeriphID5), offset 0xFD4 .....	495
Register 11:	Watchdog Peripheral Identification 6 (WDTPeriphID6), offset 0xFD8 .....	496
Register 12:	Watchdog Peripheral Identification 7 (WDTPeriphID7), offset 0xFDC .....	497
Register 13:	Watchdog Peripheral Identification 0 (WDTPeriphID0), offset 0xFE0 .....	498
Register 14:	Watchdog Peripheral Identification 1 (WDTPeriphID1), offset 0xFE4 .....	499
Register 15:	Watchdog Peripheral Identification 2 (WDTPeriphID2), offset 0xFE8 .....	500
Register 16:	Watchdog Peripheral Identification 3 (WDTPeriphID3), offset 0xFEC .....	501
Register 17:	Watchdog PrimeCell Identification 0 (WDTPCellID0), offset 0xFF0 .....	502
Register 18:	Watchdog PrimeCell Identification 1 (WDTPCellID1), offset 0xFF4 .....	503
Register 19:	Watchdog PrimeCell Identification 2 (WDTPCellID2), offset 0xFF8 .....	504
Register 20:	Watchdog PrimeCell Identification 3 (WDTPCellID3), offset 0xFFC .....	505
<b>Analog-to-Digital Converter (ADC) .....</b>		<b>506</b>
Register 1:	ADC Active Sample Sequencer (ADCACTSS), offset 0x000 .....	527
Register 2:	ADC Raw Interrupt Status (ADCRIS), offset 0x004 .....	528
Register 3:	ADC Interrupt Mask (ADCIM), offset 0x008 .....	530
Register 4:	ADC Interrupt Status and Clear (ADCISC), offset 0x00C .....	532
Register 5:	ADC Overflow Status (ADCOSTAT), offset 0x010 .....	535
Register 6:	ADC Event Multiplexer Select (ADCEMUX), offset 0x014 .....	537
Register 7:	ADC Underflow Status (ADCUSTAT), offset 0x018 .....	542
Register 8:	ADC Sample Sequencer Priority (ADCSSPRI), offset 0x020 .....	543
Register 9:	ADC Sample Phase Control (ADCSPC), offset 0x024 .....	545
Register 10:	ADC Processor Sample Sequence Initiate (ADCPSSI), offset 0x028 .....	546
Register 11:	ADC Sample Averaging Control (ADCSAC), offset 0x030 .....	548
Register 12:	ADC Digital Comparator Interrupt Status and Clear (ADCDCISC), offset 0x034 .....	549
Register 13:	ADC Control (ADCCTL), offset 0x038 .....	551
Register 14:	ADC Sample Sequence Input Multiplexer Select 0 (ADCSSMUX0), offset 0x040 .....	552
Register 15:	ADC Sample Sequence Control 0 (ADCSSCTL0), offset 0x044 .....	554
Register 16:	ADC Sample Sequence Result FIFO 0 (ADCSSFIFO0), offset 0x048 .....	557
Register 17:	ADC Sample Sequence Result FIFO 1 (ADCSSFIFO1), offset 0x068 .....	557
Register 18:	ADC Sample Sequence Result FIFO 2 (ADCSSFIFO2), offset 0x088 .....	557
Register 19:	ADC Sample Sequence Result FIFO 3 (ADCSSFIFO3), offset 0x0A8 .....	557
Register 20:	ADC Sample Sequence FIFO 0 Status (ADCSSFSTAT0), offset 0x04C .....	558
Register 21:	ADC Sample Sequence FIFO 1 Status (ADCSSFSTAT1), offset 0x06C .....	558
Register 22:	ADC Sample Sequence FIFO 2 Status (ADCSSFSTAT2), offset 0x08C .....	558
Register 23:	ADC Sample Sequence FIFO 3 Status (ADCSSFSTAT3), offset 0x0AC .....	558
Register 24:	ADC Sample Sequence 0 Operation (ADCSSOP0), offset 0x050 .....	560
Register 25:	ADC Sample Sequence 0 Digital Comparator Select (ADCSSDC0), offset 0x054 .....	562
Register 26:	ADC Sample Sequence Input Multiplexer Select 1 (ADCSSMUX1), offset 0x060 .....	564
Register 27:	ADC Sample Sequence Input Multiplexer Select 2 (ADCSSMUX2), offset 0x080 .....	564
Register 28:	ADC Sample Sequence Control 1 (ADCSSCTL1), offset 0x064 .....	565
Register 29:	ADC Sample Sequence Control 2 (ADCSSCTL2), offset 0x084 .....	565
Register 30:	ADC Sample Sequence 1 Operation (ADCSSOP1), offset 0x070 .....	567

Register 31:	ADC Sample Sequence 2 Operation (ADCSSOP2), offset 0x090 .....	567
Register 32:	ADC Sample Sequence 1 Digital Comparator Select (ADCSSDC1), offset 0x074 .....	568
Register 33:	ADC Sample Sequence 2 Digital Comparator Select (ADCSSDC2), offset 0x094 .....	568
Register 34:	ADC Sample Sequence Input Multiplexer Select 3 (ADCSSMUX3), offset 0x0A0 .....	570
Register 35:	ADC Sample Sequence Control 3 (ADCSSCTL3), offset 0x0A4 .....	571
Register 36:	ADC Sample Sequence 3 Operation (ADCSSOP3), offset 0x0B0 .....	572
Register 37:	ADC Sample Sequence 3 Digital Comparator Select (ADCSSDC3), offset 0x0B4 .....	573
Register 38:	ADC Digital Comparator Reset Initial Conditions (ADCDCRIC), offset 0xD00 .....	574
Register 39:	ADC Digital Comparator Control 0 (ADCDCCTL0), offset 0xE00 .....	579
Register 40:	ADC Digital Comparator Control 1 (ADCDCCTL1), offset 0xE04 .....	579
Register 41:	ADC Digital Comparator Control 2 (ADCDCCTL2), offset 0xE08 .....	579
Register 42:	ADC Digital Comparator Control 3 (ADCDCCTL3), offset 0xE0C .....	579
Register 43:	ADC Digital Comparator Control 4 (ADCDCCTL4), offset 0xE10 .....	579
Register 44:	ADC Digital Comparator Control 5 (ADCDCCTL5), offset 0xE14 .....	579
Register 45:	ADC Digital Comparator Control 6 (ADCDCCTL6), offset 0xE18 .....	579
Register 46:	ADC Digital Comparator Control 7 (ADCDCCTL7), offset 0xE1C .....	579
Register 47:	ADC Digital Comparator Range 0 (ADCDCCMP0), offset 0xE40 .....	583
Register 48:	ADC Digital Comparator Range 1 (ADCDCCMP1), offset 0xE44 .....	583
Register 49:	ADC Digital Comparator Range 2 (ADCDCCMP2), offset 0xE48 .....	583
Register 50:	ADC Digital Comparator Range 3 (ADCDCCMP3), offset 0xE4C .....	583
Register 51:	ADC Digital Comparator Range 4 (ADCDCCMP4), offset 0xE50 .....	583
Register 52:	ADC Digital Comparator Range 5 (ADCDCCMP5), offset 0xE54 .....	583
Register 53:	ADC Digital Comparator Range 6 (ADCDCCMP6), offset 0xE58 .....	583
Register 54:	ADC Digital Comparator Range 7 (ADCDCCMP7), offset 0xE5C .....	583
<b>Universal Asynchronous Receivers/Transmitters (UARTs) .....</b>		<b>584</b>
Register 1:	UART Data (UARTDR), offset 0x000 .....	598
Register 2:	UART Receive Status/Error Clear (UARTRSR/UARTECR), offset 0x004 .....	600
Register 3:	UART Flag (UARTFR), offset 0x018 .....	603
Register 4:	UART IrDA Low-Power Register (UARTILPR), offset 0x020 .....	606
Register 5:	UART Integer Baud-Rate Divisor (UARTIBRD), offset 0x024 .....	607
Register 6:	UART Fractional Baud-Rate Divisor (UARTFBRD), offset 0x028 .....	608
Register 7:	UART Line Control (UARTLCRH), offset 0x02C .....	609
Register 8:	UART Control (UARTCTL), offset 0x030 .....	611
Register 9:	UART Interrupt FIFO Level Select (UARTIFLS), offset 0x034 .....	615
Register 10:	UART Interrupt Mask (UARTIM), offset 0x038 .....	617
Register 11:	UART Raw Interrupt Status (UARTRIS), offset 0x03C .....	621
Register 12:	UART Masked Interrupt Status (UARTMIS), offset 0x040 .....	625
Register 13:	UART Interrupt Clear (UARTICR), offset 0x044 .....	628
Register 14:	UART DMA Control (UARTDMACTL), offset 0x048 .....	630
Register 15:	UART LIN Control (UARTLCTL), offset 0x090 .....	631
Register 16:	UART LIN Snap Shot (UARTLSS), offset 0x094 .....	632
Register 17:	UART LIN Timer (UARTLTIM), offset 0x098 .....	633
Register 18:	UART Peripheral Identification 4 (UARTPeriphID4), offset 0xFD0 .....	634
Register 19:	UART Peripheral Identification 5 (UARTPeriphID5), offset 0xFD4 .....	635
Register 20:	UART Peripheral Identification 6 (UARTPeriphID6), offset 0xFD8 .....	636
Register 21:	UART Peripheral Identification 7 (UARTPeriphID7), offset 0xFDC .....	637
Register 22:	UART Peripheral Identification 0 (UARTPeriphID0), offset 0xFE0 .....	638
Register 23:	UART Peripheral Identification 1 (UARTPeriphID1), offset 0xFE4 .....	639

Register 24:	UART Peripheral Identification 2 (UARTPeriphID2), offset 0xFE8 .....	640
Register 25:	UART Peripheral Identification 3 (UARTPeriphID3), offset 0xFEC .....	641
Register 26:	UART PrimeCell Identification 0 (UARTPCellID0), offset 0xFF0 .....	642
Register 27:	UART PrimeCell Identification 1 (UARTPCellID1), offset 0xFF4 .....	643
Register 28:	UART PrimeCell Identification 2 (UARTPCellID2), offset 0xFF8 .....	644
Register 29:	UART PrimeCell Identification 3 (UARTPCellID3), offset 0xFFC .....	645
<b>Synchronous Serial Interface (SSI) .....</b>		<b>646</b>
Register 1:	SSI Control 0 (SSICR0), offset 0x000 .....	661
Register 2:	SSI Control 1 (SSICR1), offset 0x004 .....	663
Register 3:	SSI Data (SSIDR), offset 0x008 .....	665
Register 4:	SSI Status (SSISR), offset 0x00C .....	666
Register 5:	SSI Clock Prescale (SSICPSR), offset 0x010 .....	668
Register 6:	SSI Interrupt Mask (SSIIM), offset 0x014 .....	669
Register 7:	SSI Raw Interrupt Status (SSIRIS), offset 0x018 .....	670
Register 8:	SSI Masked Interrupt Status (SSIMIS), offset 0x01C .....	672
Register 9:	SSI Interrupt Clear (SSIICR), offset 0x020 .....	674
Register 10:	SSI DMA Control (SSIDMACTL), offset 0x024 .....	675
Register 11:	SSI Peripheral Identification 4 (SSIPeriphID4), offset 0xFD0 .....	676
Register 12:	SSI Peripheral Identification 5 (SSIPeriphID5), offset 0xFD4 .....	677
Register 13:	SSI Peripheral Identification 6 (SSIPeriphID6), offset 0xFD8 .....	678
Register 14:	SSI Peripheral Identification 7 (SSIPeriphID7), offset 0xFDC .....	679
Register 15:	SSI Peripheral Identification 0 (SSIPeriphID0), offset 0xFE0 .....	680
Register 16:	SSI Peripheral Identification 1 (SSIPeriphID1), offset 0xFE4 .....	681
Register 17:	SSI Peripheral Identification 2 (SSIPeriphID2), offset 0xFE8 .....	682
Register 18:	SSI Peripheral Identification 3 (SSIPeriphID3), offset 0xFEC .....	683
Register 19:	SSI PrimeCell Identification 0 (SSIPCellID0), offset 0xFF0 .....	684
Register 20:	SSI PrimeCell Identification 1 (SSIPCellID1), offset 0xFF4 .....	685
Register 21:	SSI PrimeCell Identification 2 (SSIPCellID2), offset 0xFF8 .....	686
Register 22:	SSI PrimeCell Identification 3 (SSIPCellID3), offset 0xFFC .....	687
<b>Inter-Integrated Circuit (I<sup>2</sup>C) Interface .....</b>		<b>688</b>
Register 1:	I <sup>2</sup> C Master Slave Address (I2CMSA), offset 0x000 .....	704
Register 2:	I <sup>2</sup> C Master Control/Status (I2CMCS), offset 0x004 .....	705
Register 3:	I <sup>2</sup> C Master Data (I2CMDR), offset 0x008 .....	710
Register 4:	I <sup>2</sup> C Master Timer Period (I2CMTPR), offset 0x00C .....	711
Register 5:	I <sup>2</sup> C Master Interrupt Mask (I2CMIMR), offset 0x010 .....	712
Register 6:	I <sup>2</sup> C Master Raw Interrupt Status (I2CMRIS), offset 0x014 .....	713
Register 7:	I <sup>2</sup> C Master Masked Interrupt Status (I2CMMIS), offset 0x018 .....	714
Register 8:	I <sup>2</sup> C Master Interrupt Clear (I2CMICR), offset 0x01C .....	715
Register 9:	I <sup>2</sup> C Master Configuration (I2CMCR), offset 0x020 .....	716
Register 10:	I <sup>2</sup> C Slave Own Address (I2CSOAR), offset 0x000 .....	717
Register 11:	I <sup>2</sup> C Slave Control/Status (I2CSCSR), offset 0x004 .....	718
Register 12:	I <sup>2</sup> C Slave Data (I2CSDR), offset 0x008 .....	720
Register 13:	I <sup>2</sup> C Slave Interrupt Mask (I2CSIMR), offset 0x00C .....	721
Register 14:	I <sup>2</sup> C Slave Raw Interrupt Status (I2CSRIS), offset 0x010 .....	722
Register 15:	I <sup>2</sup> C Slave Masked Interrupt Status (I2CSMIS), offset 0x014 .....	723
Register 16:	I <sup>2</sup> C Slave Interrupt Clear (I2CSICR), offset 0x018 .....	724



<b>Inter-Integrated Circuit Sound (I<sup>2</sup>S) Interface .....</b>	<b>725</b>
Register 1: I <sup>2</sup> S Transmit FIFO Data (I2STXFIFO), offset 0x000 .....	738
Register 2: I <sup>2</sup> S Transmit FIFO Configuration (I2STXFIFOCFG), offset 0x004 .....	739
Register 3: I <sup>2</sup> S Transmit Module Configuration (I2STXCFG), offset 0x008 .....	740
Register 4: I <sup>2</sup> S Transmit FIFO Limit (I2STXLIMIT), offset 0x00C .....	742
Register 5: I <sup>2</sup> S Transmit Interrupt Status and Mask (I2STXISM), offset 0x010 .....	743
Register 6: I <sup>2</sup> S Transmit FIFO Level (I2STXLEV), offset 0x018 .....	744
Register 7: I <sup>2</sup> S Receive FIFO Data (I2SRXFIFO), offset 0x800 .....	745
Register 8: I <sup>2</sup> S Receive FIFO Configuration (I2SRXFIFOCFG), offset 0x804 .....	746
Register 9: I <sup>2</sup> S Receive Module Configuration (I2SRXCFG), offset 0x808 .....	747
Register 10: I <sup>2</sup> S Receive FIFO Limit (I2SRXLIMIT), offset 0x80C .....	750
Register 11: I <sup>2</sup> S Receive Interrupt Status and Mask (I2SRXISM), offset 0x810 .....	751
Register 12: I <sup>2</sup> S Receive FIFO Level (I2SRXLEV), offset 0x818 .....	752
Register 13: I <sup>2</sup> S Module Configuration (I2SCFG), offset 0xC00 .....	753
Register 14: I <sup>2</sup> S Interrupt Mask (I2SIM), offset 0xC10 .....	755
Register 15: I <sup>2</sup> S Raw Interrupt Status (I2SRIS), offset 0xC14 .....	757
Register 16: I <sup>2</sup> S Masked Interrupt Status (I2SMIS), offset 0xC18 .....	759
Register 17: I <sup>2</sup> S Interrupt Clear (I2SIC), offset 0xC1C .....	761
<b>Controller Area Network (CAN) Module .....</b>	<b>762</b>
Register 1: CAN Control (CANCTL), offset 0x000 .....	783
Register 2: CAN Status (CANSTS), offset 0x004 .....	785
Register 3: CAN Error Counter (CANERR), offset 0x008 .....	788
Register 4: CAN Bit Timing (CANBIT), offset 0x00C .....	789
Register 5: CAN Interrupt (CANINT), offset 0x010 .....	791
Register 6: CAN Test (CANTST), offset 0x014 .....	792
Register 7: CAN Baud Rate Prescaler Extension (CANBRPE), offset 0x018 .....	794
Register 8: CAN IF1 Command Request (CANIF1CRQ), offset 0x020 .....	795
Register 9: CAN IF2 Command Request (CANIF2CRQ), offset 0x080 .....	795
Register 10: CAN IF1 Command Mask (CANIF1CMSK), offset 0x024 .....	797
Register 11: CAN IF2 Command Mask (CANIF2CMSK), offset 0x084 .....	797
Register 12: CAN IF1 Mask 1 (CANIF1MSK1), offset 0x028 .....	800
Register 13: CAN IF2 Mask 1 (CANIF2MSK1), offset 0x088 .....	800
Register 14: CAN IF1 Mask 2 (CANIF1MSK2), offset 0x02C .....	801
Register 15: CAN IF2 Mask 2 (CANIF2MSK2), offset 0x08C .....	801
Register 16: CAN IF1 Arbitration 1 (CANIF1ARB1), offset 0x030 .....	803
Register 17: CAN IF2 Arbitration 1 (CANIF2ARB1), offset 0x090 .....	803
Register 18: CAN IF1 Arbitration 2 (CANIF1ARB2), offset 0x034 .....	804
Register 19: CAN IF2 Arbitration 2 (CANIF2ARB2), offset 0x094 .....	804
Register 20: CAN IF1 Message Control (CANIF1MCTL), offset 0x038 .....	806
Register 21: CAN IF2 Message Control (CANIF2MCTL), offset 0x098 .....	806
Register 22: CAN IF1 Data A1 (CANIF1DA1), offset 0x03C .....	809
Register 23: CAN IF1 Data A2 (CANIF1DA2), offset 0x040 .....	809
Register 24: CAN IF1 Data B1 (CANIF1DB1), offset 0x044 .....	809
Register 25: CAN IF1 Data B2 (CANIF1DB2), offset 0x048 .....	809
Register 26: CAN IF2 Data A1 (CANIF2DA1), offset 0x09C .....	809
Register 27: CAN IF2 Data A2 (CANIF2DA2), offset 0x0A0 .....	809
Register 28: CAN IF2 Data B1 (CANIF2DB1), offset 0x0A4 .....	809

Register 29:	CAN IF2 Data B2 (CANIF2DB2), offset 0x0A8 .....	809
Register 30:	CAN Transmission Request 1 (CANTXRQ1), offset 0x100 .....	810
Register 31:	CAN Transmission Request 2 (CANTXRQ2), offset 0x104 .....	810
Register 32:	CAN New Data 1 (CANNWDA1), offset 0x120 .....	811
Register 33:	CAN New Data 2 (CANNWDA2), offset 0x124 .....	811
Register 34:	CAN Message 1 Interrupt Pending (CANMSG1INT), offset 0x140 .....	812
Register 35:	CAN Message 2 Interrupt Pending (CANMSG2INT), offset 0x144 .....	812
Register 36:	CAN Message 1 Valid (CANMSG1VAL), offset 0x160 .....	813
Register 37:	CAN Message 2 Valid (CANMSG2VAL), offset 0x164 .....	813
<b>Ethernet Controller .....</b>		<b>814</b>
Register 1:	Ethernet MAC Raw Interrupt Status/Acknowledge (MACRIS/MACIACK), offset 0x000 .....	829
Register 2:	Ethernet MAC Interrupt Mask (MACIM), offset 0x004 .....	832
Register 3:	Ethernet MAC Receive Control (MACRCTL), offset 0x008 .....	834
Register 4:	Ethernet MAC Transmit Control (MACTCTL), offset 0x00C .....	836
Register 5:	Ethernet MAC Data (MACDATA), offset 0x010 .....	838
Register 6:	Ethernet MAC Individual Address 0 (MACIA0), offset 0x014 .....	840
Register 7:	Ethernet MAC Individual Address 1 (MACIA1), offset 0x018 .....	841
Register 8:	Ethernet MAC Threshold (MACTHR), offset 0x01C .....	842
Register 9:	Ethernet MAC Management Control (MACMCTL), offset 0x020 .....	844
Register 10:	Ethernet MAC Management Divider (MACMDV), offset 0x024 .....	846
Register 11:	Ethernet MAC Management Transmit Data (MACMTXD), offset 0x02C .....	847
Register 12:	Ethernet MAC Management Receive Data (MACMRXD), offset 0x030 .....	848
Register 13:	Ethernet MAC Number of Packets (MACNP), offset 0x034 .....	849
Register 14:	Ethernet MAC Transmission Request (MACTR), offset 0x038 .....	850
Register 15:	Ethernet MAC Timer Support (MACTS), offset 0x03C .....	851
Register 16:	Ethernet MAC LED Encoding (MACLED), offset 0x040 .....	852
Register 17:	Ethernet PHY MDIX (MDIX), offset 0x044 .....	854
Register 18:	Ethernet PHY Management Register 0 – Control (MR0), address 0x00 .....	855
Register 19:	Ethernet PHY Management Register 1 – Status (MR1), address 0x01 .....	857
Register 20:	Ethernet PHY Management Register 2 – PHY Identifier 1 (MR2), address 0x02 .....	859
Register 21:	Ethernet PHY Management Register 3 – PHY Identifier 2 (MR3), address 0x03 .....	860
Register 22:	Ethernet PHY Management Register 4 – Auto-Negotiation Advertisement (MR4), address 0x04 .....	861
Register 23:	Ethernet PHY Management Register 5 – Auto-Negotiation Link Partner Base Page Ability (MR5), address 0x05 .....	863
Register 24:	Ethernet PHY Management Register 6 – Auto-Negotiation Expansion (MR6), address 0x06 .....	865
Register 25:	Ethernet PHY Management Register 16 – Vendor-Specific (MR16), address 0x10 .....	866
Register 26:	Ethernet PHY Management Register 17 – Mode Control/Status (MR17), address 0x11 .....	867
Register 27:	Ethernet PHY Management Register 27 – Special Control/Status (MR27), address 0x1B .....	869
Register 28:	Ethernet PHY Management Register 29 – Interrupt Status (MR29), address 0x1D .....	870
Register 29:	Ethernet PHY Management Register 30 – Interrupt Mask (MR30), address 0x1E .....	872
Register 30:	Ethernet PHY Management Register 31 – PHY Special Control/Status (MR31), address 0x1F .....	874
<b>Universal Serial Bus (USB) Controller .....</b>		<b>875</b>
Register 1:	USB Device Functional Address (USBFADDR), offset 0x000 .....	903
Register 2:	USB Power (USBPOWER), offset 0x001 .....	904

Register 3:	USB Transmit Interrupt Status (USBTXIS), offset 0x002 .....	907
Register 4:	USB Receive Interrupt Status (USBRXIS), offset 0x004 .....	909
Register 5:	USB Transmit Interrupt Enable (USBTXIE), offset 0x006 .....	911
Register 6:	USB Receive Interrupt Enable (USBRXIE), offset 0x008 .....	913
Register 7:	USB General Interrupt Status (USBIS), offset 0x00A .....	915
Register 8:	USB Interrupt Enable (USBIE), offset 0x00B .....	918
Register 9:	USB Frame Value (USBFRAME), offset 0x00C .....	921
Register 10:	USB Endpoint Index (USBEPIDX), offset 0x00E .....	922
Register 11:	USB Test Mode (USBTEST), offset 0x00F .....	923
Register 12:	USB FIFO Endpoint 0 (USBFIFO0), offset 0x020 .....	925
Register 13:	USB FIFO Endpoint 1 (USBFIFO1), offset 0x024 .....	925
Register 14:	USB FIFO Endpoint 2 (USBFIFO2), offset 0x028 .....	925
Register 15:	USB FIFO Endpoint 3 (USBFIFO3), offset 0x02C .....	925
Register 16:	USB FIFO Endpoint 4 (USBFIFO4), offset 0x030 .....	925
Register 17:	USB FIFO Endpoint 5 (USBFIFO5), offset 0x034 .....	925
Register 18:	USB FIFO Endpoint 6 (USBFIFO6), offset 0x038 .....	925
Register 19:	USB FIFO Endpoint 7 (USBFIFO7), offset 0x03C .....	925
Register 20:	USB FIFO Endpoint 8 (USBFIFO8), offset 0x040 .....	925
Register 21:	USB FIFO Endpoint 9 (USBFIFO9), offset 0x044 .....	925
Register 22:	USB FIFO Endpoint 10 (USBFIFO10), offset 0x048 .....	925
Register 23:	USB FIFO Endpoint 11 (USBFIFO11), offset 0x04C .....	925
Register 24:	USB FIFO Endpoint 12 (USBFIFO12), offset 0x050 .....	925
Register 25:	USB FIFO Endpoint 13 (USBFIFO13), offset 0x054 .....	925
Register 26:	USB FIFO Endpoint 14 (USBFIFO14), offset 0x058 .....	925
Register 27:	USB FIFO Endpoint 15 (USBFIFO15), offset 0x05C .....	925
Register 28:	USB Device Control (USBDEVCTL), offset 0x060 .....	927
Register 29:	USB Transmit Dynamic FIFO Sizing (USBTXFIFOSZ), offset 0x062 .....	929
Register 30:	USB Receive Dynamic FIFO Sizing (USBRXFIFOSZ), offset 0x063 .....	929
Register 31:	USB Transmit FIFO Start Address (USBTXFIFOADD), offset 0x064 .....	930
Register 32:	USB Receive FIFO Start Address (USBRXFIFOADD), offset 0x066 .....	930
Register 33:	USB Connect Timing (USBCONTIM), offset 0x07A .....	931
Register 34:	USB OTG VBUS Pulse Timing (USBVPLEN), offset 0x07B .....	932
Register 35:	USB Full-Speed Last Transaction to End of Frame Timing (USBFSEOF), offset 0x07D .....	933
Register 36:	USB Low-Speed Last Transaction to End of Frame Timing (USBLSEOF), offset 0x07E .....	934
Register 37:	USB Transmit Functional Address Endpoint 0 (USBTXFUNCADDR0), offset 0x080 .....	935
Register 38:	USB Transmit Functional Address Endpoint 1 (USBTXFUNCADDR1), offset 0x088 .....	935
Register 39:	USB Transmit Functional Address Endpoint 2 (USBTXFUNCADDR2), offset 0x090 .....	935
Register 40:	USB Transmit Functional Address Endpoint 3 (USBTXFUNCADDR3), offset 0x098 .....	935
Register 41:	USB Transmit Functional Address Endpoint 4 (USBTXFUNCADDR4), offset 0x0A0 .....	935
Register 42:	USB Transmit Functional Address Endpoint 5 (USBTXFUNCADDR5), offset 0x0A8 .....	935
Register 43:	USB Transmit Functional Address Endpoint 6 (USBTXFUNCADDR6), offset 0x0B0 .....	935
Register 44:	USB Transmit Functional Address Endpoint 7 (USBTXFUNCADDR7), offset 0x0B8 .....	935
Register 45:	USB Transmit Functional Address Endpoint 8 (USBTXFUNCADDR8), offset 0x0C0 .....	935
Register 46:	USB Transmit Functional Address Endpoint 9 (USBTXFUNCADDR9), offset 0x0C8 .....	935
Register 47:	USB Transmit Functional Address Endpoint 10 (USBTXFUNCADDR10), offset 0x0D0 .....	935
Register 48:	USB Transmit Functional Address Endpoint 11 (USBTXFUNCADDR11), offset 0x0D8 .....	935
Register 49:	USB Transmit Functional Address Endpoint 12 (USBTXFUNCADDR12), offset 0x0E0 .....	935
Register 50:	USB Transmit Functional Address Endpoint 13 (USBTXFUNCADDR13), offset 0x0E8 .....	935

Register 51:	USB Transmit Functional Address Endpoint 14 (USBTXFUNCADDR14), offset 0x0F0 .....	935
Register 52:	USB Transmit Functional Address Endpoint 15 (USBTXFUNCADDR15), offset 0x0F8 .....	935
Register 53:	USB Transmit Hub Address Endpoint 0 (USBTXHUBADDR0), offset 0x082 .....	937
Register 54:	USB Transmit Hub Address Endpoint 1 (USBTXHUBADDR1), offset 0x08A .....	937
Register 55:	USB Transmit Hub Address Endpoint 2 (USBTXHUBADDR2), offset 0x092 .....	937
Register 56:	USB Transmit Hub Address Endpoint 3 (USBTXHUBADDR3), offset 0x09A .....	937
Register 57:	USB Transmit Hub Address Endpoint 4 (USBTXHUBADDR4), offset 0x0A2 .....	937
Register 58:	USB Transmit Hub Address Endpoint 5 (USBTXHUBADDR5), offset 0x0AA .....	937
Register 59:	USB Transmit Hub Address Endpoint 6 (USBTXHUBADDR6), offset 0x0B2 .....	937
Register 60:	USB Transmit Hub Address Endpoint 7 (USBTXHUBADDR7), offset 0x0BA .....	937
Register 61:	USB Transmit Hub Address Endpoint 8 (USBTXHUBADDR8), offset 0x0C2 .....	937
Register 62:	USB Transmit Hub Address Endpoint 9 (USBTXHUBADDR9), offset 0x0CA .....	937
Register 63:	USB Transmit Hub Address Endpoint 10 (USBTXHUBADDR10), offset 0x0D2 .....	937
Register 64:	USB Transmit Hub Address Endpoint 11 (USBTXHUBADDR11), offset 0x0DA .....	937
Register 65:	USB Transmit Hub Address Endpoint 12 (USBTXHUBADDR12), offset 0x0E2 .....	937
Register 66:	USB Transmit Hub Address Endpoint 13 (USBTXHUBADDR13), offset 0x0EA .....	937
Register 67:	USB Transmit Hub Address Endpoint 14 (USBTXHUBADDR14), offset 0x0F2 .....	937
Register 68:	USB Transmit Hub Address Endpoint 15 (USBTXHUBADDR15), offset 0x0FA .....	937
Register 69:	USB Transmit Hub Port Endpoint 0 (USBTXHUBPORT0), offset 0x083 .....	939
Register 70:	USB Transmit Hub Port Endpoint 1 (USBTXHUBPORT1), offset 0x08B .....	939
Register 71:	USB Transmit Hub Port Endpoint 2 (USBTXHUBPORT2), offset 0x093 .....	939
Register 72:	USB Transmit Hub Port Endpoint 3 (USBTXHUBPORT3), offset 0x09B .....	939
Register 73:	USB Transmit Hub Port Endpoint 4 (USBTXHUBPORT4), offset 0x0A3 .....	939
Register 74:	USB Transmit Hub Port Endpoint 5 (USBTXHUBPORT5), offset 0x0AB .....	939
Register 75:	USB Transmit Hub Port Endpoint 6 (USBTXHUBPORT6), offset 0x0B3 .....	939
Register 76:	USB Transmit Hub Port Endpoint 7 (USBTXHUBPORT7), offset 0x0BB .....	939
Register 77:	USB Transmit Hub Port Endpoint 8 (USBTXHUBPORT8), offset 0x0C3 .....	939
Register 78:	USB Transmit Hub Port Endpoint 9 (USBTXHUBPORT9), offset 0x0CB .....	939
Register 79:	USB Transmit Hub Port Endpoint 10 (USBTXHUBPORT10), offset 0x0D3 .....	939
Register 80:	USB Transmit Hub Port Endpoint 11 (USBTXHUBPORT11), offset 0x0DB .....	939
Register 81:	USB Transmit Hub Port Endpoint 12 (USBTXHUBPORT12), offset 0x0E3 .....	939
Register 82:	USB Transmit Hub Port Endpoint 13 (USBTXHUBPORT13), offset 0x0EB .....	939
Register 83:	USB Transmit Hub Port Endpoint 14 (USBTXHUBPORT14), offset 0x0F3 .....	939
Register 84:	USB Transmit Hub Port Endpoint 15 (USBTXHUBPORT15), offset 0x0FB .....	939
Register 85:	USB Receive Functional Address Endpoint 1 (USBRXFUNCADDR1), offset 0x08C .....	941
Register 86:	USB Receive Functional Address Endpoint 2 (USBRXFUNCADDR2), offset 0x094 .....	941
Register 87:	USB Receive Functional Address Endpoint 3 (USBRXFUNCADDR3), offset 0x09C .....	941
Register 88:	USB Receive Functional Address Endpoint 4 (USBRXFUNCADDR4), offset 0x0A4 .....	941
Register 89:	USB Receive Functional Address Endpoint 5 (USBRXFUNCADDR5), offset 0x0AC .....	941
Register 90:	USB Receive Functional Address Endpoint 6 (USBRXFUNCADDR6), offset 0x0B4 .....	941
Register 91:	USB Receive Functional Address Endpoint 7 (USBRXFUNCADDR7), offset 0x0BC .....	941
Register 92:	USB Receive Functional Address Endpoint 8 (USBRXFUNCADDR8), offset 0x0C4 .....	941
Register 93:	USB Receive Functional Address Endpoint 9 (USBRXFUNCADDR9), offset 0x0CC .....	941
Register 94:	USB Receive Functional Address Endpoint 10 (USBRXFUNCADDR10), offset 0x0D4 .....	941
Register 95:	USB Receive Functional Address Endpoint 11 (USBRXFUNCADDR11), offset 0x0DC .....	941
Register 96:	USB Receive Functional Address Endpoint 12 (USBRXFUNCADDR12), offset 0x0E4 .....	941
Register 97:	USB Receive Functional Address Endpoint 13 (USBRXFUNCADDR13), offset 0x0EC .....	941
Register 98:	USB Receive Functional Address Endpoint 14 (USBRXFUNCADDR14), offset 0x0F4 .....	941

Register 99:	USB Receive Functional Address Endpoint 15 (USBRXFUNCADDR15), offset 0x0FC	941
Register 100:	USB Receive Hub Address Endpoint 1 (USBRXHUBADDR1), offset 0x08E	943
Register 101:	USB Receive Hub Address Endpoint 2 (USBRXHUBADDR2), offset 0x096	943
Register 102:	USB Receive Hub Address Endpoint 3 (USBRXHUBADDR3), offset 0x09E	943
Register 103:	USB Receive Hub Address Endpoint 4 (USBRXHUBADDR4), offset 0x0A6	943
Register 104:	USB Receive Hub Address Endpoint 5 (USBRXHUBADDR5), offset 0x0AE	943
Register 105:	USB Receive Hub Address Endpoint 6 (USBRXHUBADDR6), offset 0x0B6	943
Register 106:	USB Receive Hub Address Endpoint 7 (USBRXHUBADDR7), offset 0x0BE	943
Register 107:	USB Receive Hub Address Endpoint 8 (USBRXHUBADDR8), offset 0x0C6	943
Register 108:	USB Receive Hub Address Endpoint 9 (USBRXHUBADDR9), offset 0x0CE	943
Register 109:	USB Receive Hub Address Endpoint 10 (USBRXHUBADDR10), offset 0x0D6	943
Register 110:	USB Receive Hub Address Endpoint 11 (USBRXHUBADDR11), offset 0x0DE	943
Register 111:	USB Receive Hub Address Endpoint 12 (USBRXHUBADDR12), offset 0x0E6	943
Register 112:	USB Receive Hub Address Endpoint 13 (USBRXHUBADDR13), offset 0x0EE	943
Register 113:	USB Receive Hub Address Endpoint 14 (USBRXHUBADDR14), offset 0x0F6	943
Register 114:	USB Receive Hub Address Endpoint 15 (USBRXHUBADDR15), offset 0x0FE	943
Register 115:	USB Receive Hub Port Endpoint 1 (USBRXHUBPORT1), offset 0x08F	945
Register 116:	USB Receive Hub Port Endpoint 2 (USBRXHUBPORT2), offset 0x097	945
Register 117:	USB Receive Hub Port Endpoint 3 (USBRXHUBPORT3), offset 0x09F	945
Register 118:	USB Receive Hub Port Endpoint 4 (USBRXHUBPORT4), offset 0x0A7	945
Register 119:	USB Receive Hub Port Endpoint 5 (USBRXHUBPORT5), offset 0x0AF	945
Register 120:	USB Receive Hub Port Endpoint 6 (USBRXHUBPORT6), offset 0x0B7	945
Register 121:	USB Receive Hub Port Endpoint 7 (USBRXHUBPORT7), offset 0x0BF	945
Register 122:	USB Receive Hub Port Endpoint 8 (USBRXHUBPORT8), offset 0x0C7	945
Register 123:	USB Receive Hub Port Endpoint 9 (USBRXHUBPORT9), offset 0x0CF	945
Register 124:	USB Receive Hub Port Endpoint 10 (USBRXHUBPORT10), offset 0x0D7	945
Register 125:	USB Receive Hub Port Endpoint 11 (USBRXHUBPORT11), offset 0x0DF	945
Register 126:	USB Receive Hub Port Endpoint 12 (USBRXHUBPORT12), offset 0x0E7	945
Register 127:	USB Receive Hub Port Endpoint 13 (USBRXHUBPORT13), offset 0x0EF	945
Register 128:	USB Receive Hub Port Endpoint 14 (USBRXHUBPORT14), offset 0x0F7	945
Register 129:	USB Receive Hub Port Endpoint 15 (USBRXHUBPORT15), offset 0x0FF	945
Register 130:	USB Maximum Transmit Data Endpoint 1 (USBTXMAXP1), offset 0x110	947
Register 131:	USB Maximum Transmit Data Endpoint 2 (USBTXMAXP2), offset 0x120	947
Register 132:	USB Maximum Transmit Data Endpoint 3 (USBTXMAXP3), offset 0x130	947
Register 133:	USB Maximum Transmit Data Endpoint 4 (USBTXMAXP4), offset 0x140	947
Register 134:	USB Maximum Transmit Data Endpoint 5 (USBTXMAXP5), offset 0x150	947
Register 135:	USB Maximum Transmit Data Endpoint 6 (USBTXMAXP6), offset 0x160	947
Register 136:	USB Maximum Transmit Data Endpoint 7 (USBTXMAXP7), offset 0x170	947
Register 137:	USB Maximum Transmit Data Endpoint 8 (USBTXMAXP8), offset 0x180	947
Register 138:	USB Maximum Transmit Data Endpoint 9 (USBTXMAXP9), offset 0x190	947
Register 139:	USB Maximum Transmit Data Endpoint 10 (USBTXMAXP10), offset 0x1A0	947
Register 140:	USB Maximum Transmit Data Endpoint 11 (USBTXMAXP11), offset 0x1B0	947
Register 141:	USB Maximum Transmit Data Endpoint 12 (USBTXMAXP12), offset 0x1C0	947
Register 142:	USB Maximum Transmit Data Endpoint 13 (USBTXMAXP13), offset 0x1D0	947
Register 143:	USB Maximum Transmit Data Endpoint 14 (USBTXMAXP14), offset 0x1E0	947
Register 144:	USB Maximum Transmit Data Endpoint 15 (USBTXMAXP15), offset 0x1F0	947
Register 145:	USB Control and Status Endpoint 0 Low (USBCSRL0), offset 0x102	949
Register 146:	USB Control and Status Endpoint 0 High (USBCSRH0), offset 0x103	953

Register 147: USB Receive Byte Count Endpoint 0 (USBCOUNT0), offset 0x108 .....	955
Register 148: USB Type Endpoint 0 (USBTYPE0), offset 0x10A .....	956
Register 149: USB NAK Limit (USBNAKLMT), offset 0x10B .....	957
Register 150: USB Transmit Control and Status Endpoint 1 Low (USBTXCSRL1), offset 0x112 .....	958
Register 151: USB Transmit Control and Status Endpoint 2 Low (USBTXCSRL2), offset 0x122 .....	958
Register 152: USB Transmit Control and Status Endpoint 3 Low (USBTXCSRL3), offset 0x132 .....	958
Register 153: USB Transmit Control and Status Endpoint 4 Low (USBTXCSRL4), offset 0x142 .....	958
Register 154: USB Transmit Control and Status Endpoint 5 Low (USBTXCSRL5), offset 0x152 .....	958
Register 155: USB Transmit Control and Status Endpoint 6 Low (USBTXCSRL6), offset 0x162 .....	958
Register 156: USB Transmit Control and Status Endpoint 7 Low (USBTXCSRL7), offset 0x172 .....	958
Register 157: USB Transmit Control and Status Endpoint 8 Low (USBTXCSRL8), offset 0x182 .....	958
Register 158: USB Transmit Control and Status Endpoint 9 Low (USBTXCSRL9), offset 0x192 .....	958
Register 159: USB Transmit Control and Status Endpoint 10 Low (USBTXCSRL10), offset 0x1A2 .....	958
Register 160: USB Transmit Control and Status Endpoint 11 Low (USBTXCSRL11), offset 0x1B2 .....	958
Register 161: USB Transmit Control and Status Endpoint 12 Low (USBTXCSRL12), offset 0x1C2 .....	958
Register 162: USB Transmit Control and Status Endpoint 13 Low (USBTXCSRL13), offset 0x1D2 .....	958
Register 163: USB Transmit Control and Status Endpoint 14 Low (USBTXCSRL14), offset 0x1E2 .....	958
Register 164: USB Transmit Control and Status Endpoint 15 Low (USBTXCSRL15), offset 0x1F2 .....	958
Register 165: USB Transmit Control and Status Endpoint 1 High (USBTXCSRH1), offset 0x113 .....	963
Register 166: USB Transmit Control and Status Endpoint 2 High (USBTXCSRH2), offset 0x123 .....	963
Register 167: USB Transmit Control and Status Endpoint 3 High (USBTXCSRH3), offset 0x133 .....	963
Register 168: USB Transmit Control and Status Endpoint 4 High (USBTXCSRH4), offset 0x143 .....	963
Register 169: USB Transmit Control and Status Endpoint 5 High (USBTXCSRH5), offset 0x153 .....	963
Register 170: USB Transmit Control and Status Endpoint 6 High (USBTXCSRH6), offset 0x163 .....	963
Register 171: USB Transmit Control and Status Endpoint 7 High (USBTXCSRH7), offset 0x173 .....	963
Register 172: USB Transmit Control and Status Endpoint 8 High (USBTXCSRH8), offset 0x183 .....	963
Register 173: USB Transmit Control and Status Endpoint 9 High (USBTXCSRH9), offset 0x193 .....	963
Register 174: USB Transmit Control and Status Endpoint 10 High (USBTXCSRH10), offset 0x1A3 .....	963
Register 175: USB Transmit Control and Status Endpoint 11 High (USBTXCSRH11), offset 0x1B3 .....	963
Register 176: USB Transmit Control and Status Endpoint 12 High (USBTXCSRH12), offset 0x1C3 .....	963
Register 177: USB Transmit Control and Status Endpoint 13 High (USBTXCSRH13), offset 0x1D3 .....	963
Register 178: USB Transmit Control and Status Endpoint 14 High (USBTXCSRH14), offset 0x1E3 .....	963
Register 179: USB Transmit Control and Status Endpoint 15 High (USBTXCSRH15), offset 0x1F3 .....	963
Register 180: USB Maximum Receive Data Endpoint 1 (USBRXMAXP1), offset 0x114 .....	967
Register 181: USB Maximum Receive Data Endpoint 2 (USBRXMAXP2), offset 0x124 .....	967
Register 182: USB Maximum Receive Data Endpoint 3 (USBRXMAXP3), offset 0x134 .....	967
Register 183: USB Maximum Receive Data Endpoint 4 (USBRXMAXP4), offset 0x144 .....	967
Register 184: USB Maximum Receive Data Endpoint 5 (USBRXMAXP5), offset 0x154 .....	967
Register 185: USB Maximum Receive Data Endpoint 6 (USBRXMAXP6), offset 0x164 .....	967
Register 186: USB Maximum Receive Data Endpoint 7 (USBRXMAXP7), offset 0x174 .....	967
Register 187: USB Maximum Receive Data Endpoint 8 (USBRXMAXP8), offset 0x184 .....	967
Register 188: USB Maximum Receive Data Endpoint 9 (USBRXMAXP9), offset 0x194 .....	967
Register 189: USB Maximum Receive Data Endpoint 10 (USBRXMAXP10), offset 0x1A4 .....	967
Register 190: USB Maximum Receive Data Endpoint 11 (USBRXMAXP11), offset 0x1B4 .....	967
Register 191: USB Maximum Receive Data Endpoint 12 (USBRXMAXP12), offset 0x1C4 .....	967
Register 192: USB Maximum Receive Data Endpoint 13 (USBRXMAXP13), offset 0x1D4 .....	967
Register 193: USB Maximum Receive Data Endpoint 14 (USBRXMAXP14), offset 0x1E4 .....	967
Register 194: USB Maximum Receive Data Endpoint 15 (USBRXMAXP15), offset 0x1F4 .....	967

Register 195: USB Receive Control and Status Endpoint 1 Low (USBRXCSRL1), offset 0x116 .....	969
Register 196: USB Receive Control and Status Endpoint 2 Low (USBRXCSRL2), offset 0x126 .....	969
Register 197: USB Receive Control and Status Endpoint 3 Low (USBRXCSRL3), offset 0x136 .....	969
Register 198: USB Receive Control and Status Endpoint 4 Low (USBRXCSRL4), offset 0x146 .....	969
Register 199: USB Receive Control and Status Endpoint 5 Low (USBRXCSRL5), offset 0x156 .....	969
Register 200: USB Receive Control and Status Endpoint 6 Low (USBRXCSRL6), offset 0x166 .....	969
Register 201: USB Receive Control and Status Endpoint 7 Low (USBRXCSRL7), offset 0x176 .....	969
Register 202: USB Receive Control and Status Endpoint 8 Low (USBRXCSRL8), offset 0x186 .....	969
Register 203: USB Receive Control and Status Endpoint 9 Low (USBRXCSRL9), offset 0x196 .....	969
Register 204: USB Receive Control and Status Endpoint 10 Low (USBRXCSRL10), offset 0x1A6 .....	969
Register 205: USB Receive Control and Status Endpoint 11 Low (USBRXCSRL11), offset 0x1B6 .....	969
Register 206: USB Receive Control and Status Endpoint 12 Low (USBRXCSRL12), offset 0x1C6 .....	969
Register 207: USB Receive Control and Status Endpoint 13 Low (USBRXCSRL13), offset 0x1D6 .....	969
Register 208: USB Receive Control and Status Endpoint 14 Low (USBRXCSRL14), offset 0x1E6 .....	969
Register 209: USB Receive Control and Status Endpoint 15 Low (USBRXCSRL15), offset 0x1F6 .....	969
Register 210: USB Receive Control and Status Endpoint 1 High (USBRXCSRH1), offset 0x117 .....	974
Register 211: USB Receive Control and Status Endpoint 2 High (USBRXCSRH2), offset 0x127 .....	974
Register 212: USB Receive Control and Status Endpoint 3 High (USBRXCSRH3), offset 0x137 .....	974
Register 213: USB Receive Control and Status Endpoint 4 High (USBRXCSRH4), offset 0x147 .....	974
Register 214: USB Receive Control and Status Endpoint 5 High (USBRXCSRH5), offset 0x157 .....	974
Register 215: USB Receive Control and Status Endpoint 6 High (USBRXCSRH6), offset 0x167 .....	974
Register 216: USB Receive Control and Status Endpoint 7 High (USBRXCSRH7), offset 0x177 .....	974
Register 217: USB Receive Control and Status Endpoint 8 High (USBRXCSRH8), offset 0x187 .....	974
Register 218: USB Receive Control and Status Endpoint 9 High (USBRXCSRH9), offset 0x197 .....	974
Register 219: USB Receive Control and Status Endpoint 10 High (USBRXCSRH10), offset 0x1A7 .....	974
Register 220: USB Receive Control and Status Endpoint 11 High (USBRXCSRH11), offset 0x1B7 .....	974
Register 221: USB Receive Control and Status Endpoint 12 High (USBRXCSRH12), offset 0x1C7 .....	974
Register 222: USB Receive Control and Status Endpoint 13 High (USBRXCSRH13), offset 0x1D7 .....	974
Register 223: USB Receive Control and Status Endpoint 14 High (USBRXCSRH14), offset 0x1E7 .....	974
Register 224: USB Receive Control and Status Endpoint 15 High (USBRXCSRH15), offset 0x1F7 .....	974
Register 225: USB Receive Byte Count Endpoint 1 (USBRXCOUNT1), offset 0x118 .....	979
Register 226: USB Receive Byte Count Endpoint 2 (USBRXCOUNT2), offset 0x128 .....	979
Register 227: USB Receive Byte Count Endpoint 3 (USBRXCOUNT3), offset 0x138 .....	979
Register 228: USB Receive Byte Count Endpoint 4 (USBRXCOUNT4), offset 0x148 .....	979
Register 229: USB Receive Byte Count Endpoint 5 (USBRXCOUNT5), offset 0x158 .....	979
Register 230: USB Receive Byte Count Endpoint 6 (USBRXCOUNT6), offset 0x168 .....	979
Register 231: USB Receive Byte Count Endpoint 7 (USBRXCOUNT7), offset 0x178 .....	979
Register 232: USB Receive Byte Count Endpoint 8 (USBRXCOUNT8), offset 0x188 .....	979
Register 233: USB Receive Byte Count Endpoint 9 (USBRXCOUNT9), offset 0x198 .....	979
Register 234: USB Receive Byte Count Endpoint 10 (USBRXCOUNT10), offset 0x1A8 .....	979
Register 235: USB Receive Byte Count Endpoint 11 (USBRXCOUNT11), offset 0x1B8 .....	979
Register 236: USB Receive Byte Count Endpoint 12 (USBRXCOUNT12), offset 0x1C8 .....	979
Register 237: USB Receive Byte Count Endpoint 13 (USBRXCOUNT13), offset 0x1D8 .....	979
Register 238: USB Receive Byte Count Endpoint 14 (USBRXCOUNT14), offset 0x1E8 .....	979
Register 239: USB Receive Byte Count Endpoint 15 (USBRXCOUNT15), offset 0x1F8 .....	979
Register 240: USB Host Transmit Configure Type Endpoint 1 (USBTXTYPE1), offset 0x11A .....	981
Register 241: USB Host Transmit Configure Type Endpoint 2 (USBTXTYPE2), offset 0x12A .....	981
Register 242: USB Host Transmit Configure Type Endpoint 3 (USBTXTYPE3), offset 0x13A .....	981

Register 243: USB Host Transmit Configure Type Endpoint 4 (USBTXTYPE4), offset 0x14A ..... 981

Register 244: USB Host Transmit Configure Type Endpoint 5 (USBTXTYPE5), offset 0x15A ..... 981

Register 245: USB Host Transmit Configure Type Endpoint 6 (USBTXTYPE6), offset 0x16A ..... 981

Register 246: USB Host Transmit Configure Type Endpoint 7 (USBTXTYPE7), offset 0x17A ..... 981

Register 247: USB Host Transmit Configure Type Endpoint 8 (USBTXTYPE8), offset 0x18A ..... 981

Register 248: USB Host Transmit Configure Type Endpoint 9 (USBTXTYPE9), offset 0x19A ..... 981

Register 249: USB Host Transmit Configure Type Endpoint 10 (USBTXTYPE10), offset 0x1AA ..... 981

Register 250: USB Host Transmit Configure Type Endpoint 11 (USBTXTYPE11), offset 0x1BA ..... 981

Register 251: USB Host Transmit Configure Type Endpoint 12 (USBTXTYPE12), offset 0x1CA ..... 981

Register 252: USB Host Transmit Configure Type Endpoint 13 (USBTXTYPE13), offset 0x1DA ..... 981

Register 253: USB Host Transmit Configure Type Endpoint 14 (USBTXTYPE14), offset 0x1EA ..... 981

Register 254: USB Host Transmit Configure Type Endpoint 15 (USBTXTYPE15), offset 0x1FA ..... 981

Register 255: USB Host Transmit Interval Endpoint 1 (USBTXINTERVAL1), offset 0x11B ..... 983

Register 256: USB Host Transmit Interval Endpoint 2 (USBTXINTERVAL2), offset 0x12B ..... 983

Register 257: USB Host Transmit Interval Endpoint 3 (USBTXINTERVAL3), offset 0x13B ..... 983

Register 258: USB Host Transmit Interval Endpoint 4 (USBTXINTERVAL4), offset 0x14B ..... 983

Register 259: USB Host Transmit Interval Endpoint 5 (USBTXINTERVAL5), offset 0x15B ..... 983

Register 260: USB Host Transmit Interval Endpoint 6 (USBTXINTERVAL6), offset 0x16B ..... 983

Register 261: USB Host Transmit Interval Endpoint 7 (USBTXINTERVAL7), offset 0x17B ..... 983

Register 262: USB Host Transmit Interval Endpoint 8 (USBTXINTERVAL8), offset 0x18B ..... 983

Register 263: USB Host Transmit Interval Endpoint 9 (USBTXINTERVAL9), offset 0x19B ..... 983

Register 264: USB Host Transmit Interval Endpoint 10 (USBTXINTERVAL10), offset 0x1AB ..... 983

Register 265: USB Host Transmit Interval Endpoint 11 (USBTXINTERVAL11), offset 0x1BB ..... 983

Register 266: USB Host Transmit Interval Endpoint 12 (USBTXINTERVAL12), offset 0x1CB ..... 983

Register 267: USB Host Transmit Interval Endpoint 13 (USBTXINTERVAL13), offset 0x1DB ..... 983

Register 268: USB Host Transmit Interval Endpoint 14 (USBTXINTERVAL14), offset 0x1EB ..... 983

Register 269: USB Host Transmit Interval Endpoint 15 (USBTXINTERVAL15), offset 0x1FB ..... 983

Register 270: USB Host Configure Receive Type Endpoint 1 (USBRXTYPE1), offset 0x11C ..... 985

Register 271: USB Host Configure Receive Type Endpoint 2 (USBRXTYPE2), offset 0x12C ..... 985

Register 272: USB Host Configure Receive Type Endpoint 3 (USBRXTYPE3), offset 0x13C ..... 985

Register 273: USB Host Configure Receive Type Endpoint 4 (USBRXTYPE4), offset 0x14C ..... 985

Register 274: USB Host Configure Receive Type Endpoint 5 (USBRXTYPE5), offset 0x15C ..... 985

Register 275: USB Host Configure Receive Type Endpoint 6 (USBRXTYPE6), offset 0x16C ..... 985

Register 276: USB Host Configure Receive Type Endpoint 7 (USBRXTYPE7), offset 0x17C ..... 985

Register 277: USB Host Configure Receive Type Endpoint 8 (USBRXTYPE8), offset 0x18C ..... 985

Register 278: USB Host Configure Receive Type Endpoint 9 (USBRXTYPE9), offset 0x19C ..... 985

Register 279: USB Host Configure Receive Type Endpoint 10 (USBRXTYPE10), offset 0x1AC ..... 985

Register 280: USB Host Configure Receive Type Endpoint 11 (USBRXTYPE11), offset 0x1BC ..... 985

Register 281: USB Host Configure Receive Type Endpoint 12 (USBRXTYPE12), offset 0x1CC ..... 985

Register 282: USB Host Configure Receive Type Endpoint 13 (USBRXTYPE13), offset 0x1DC ..... 985

Register 283: USB Host Configure Receive Type Endpoint 14 (USBRXTYPE14), offset 0x1EC ..... 985

Register 284: USB Host Configure Receive Type Endpoint 15 (USBRXTYPE15), offset 0x1FC ..... 985

Register 285: USB Host Receive Polling Interval Endpoint 1 (USBRXINTERVAL1), offset 0x11D ..... 987

Register 286: USB Host Receive Polling Interval Endpoint 2 (USBRXINTERVAL2), offset 0x12D ..... 987

Register 287: USB Host Receive Polling Interval Endpoint 3 (USBRXINTERVAL3), offset 0x13D ..... 987

Register 288: USB Host Receive Polling Interval Endpoint 4 (USBRXINTERVAL4), offset 0x14D ..... 987

Register 289: USB Host Receive Polling Interval Endpoint 5 (USBRXINTERVAL5), offset 0x15D ..... 987

Register 290: USB Host Receive Polling Interval Endpoint 6 (USBRXINTERVAL6), offset 0x16D ..... 987



Register 291:	USB Host Receive Polling Interval Endpoint 7 (USBRXINTERVAL7), offset 0x17D .....	987
Register 292:	USB Host Receive Polling Interval Endpoint 8 (USBRXINTERVAL8), offset 0x18D .....	987
Register 293:	USB Host Receive Polling Interval Endpoint 9 (USBRXINTERVAL9), offset 0x19D .....	987
Register 294:	USB Host Receive Polling Interval Endpoint 10 (USBRXINTERVAL10), offset 0x1AD .....	987
Register 295:	USB Host Receive Polling Interval Endpoint 11 (USBRXINTERVAL11), offset 0x1BD .....	987
Register 296:	USB Host Receive Polling Interval Endpoint 12 (USBRXINTERVAL12), offset 0x1CD .....	987
Register 297:	USB Host Receive Polling Interval Endpoint 13 (USBRXINTERVAL13), offset 0x1DD .....	987
Register 298:	USB Host Receive Polling Interval Endpoint 14 (USBRXINTERVAL14), offset 0x1ED .....	987
Register 299:	USB Host Receive Polling Interval Endpoint 15 (USBRXINTERVAL15), offset 0x1FD .....	987
Register 300:	USB Request Packet Count in Block Transfer Endpoint 1 (USBRQPKTCOUNT1), offset 0x304 .....	989
Register 301:	USB Request Packet Count in Block Transfer Endpoint 2 (USBRQPKTCOUNT2), offset 0x308 .....	989
Register 302:	USB Request Packet Count in Block Transfer Endpoint 3 (USBRQPKTCOUNT3), offset 0x30C .....	989
Register 303:	USB Request Packet Count in Block Transfer Endpoint 4 (USBRQPKTCOUNT4), offset 0x310 .....	989
Register 304:	USB Request Packet Count in Block Transfer Endpoint 5 (USBRQPKTCOUNT5), offset 0x314 .....	989
Register 305:	USB Request Packet Count in Block Transfer Endpoint 6 (USBRQPKTCOUNT6), offset 0x318 .....	989
Register 306:	USB Request Packet Count in Block Transfer Endpoint 7 (USBRQPKTCOUNT7), offset 0x31C .....	989
Register 307:	USB Request Packet Count in Block Transfer Endpoint 8 (USBRQPKTCOUNT8), offset 0x320 .....	989
Register 308:	USB Request Packet Count in Block Transfer Endpoint 9 (USBRQPKTCOUNT9), offset 0x324 .....	989
Register 309:	USB Request Packet Count in Block Transfer Endpoint 10 (USBRQPKTCOUNT10), offset 0x328 .....	989
Register 310:	USB Request Packet Count in Block Transfer Endpoint 11 (USBRQPKTCOUNT11), offset 0x32C .....	989
Register 311:	USB Request Packet Count in Block Transfer Endpoint 12 (USBRQPKTCOUNT12), offset 0x330 .....	989
Register 312:	USB Request Packet Count in Block Transfer Endpoint 13 (USBRQPKTCOUNT13), offset 0x334 .....	989
Register 313:	USB Request Packet Count in Block Transfer Endpoint 14 (USBRQPKTCOUNT14), offset 0x338 .....	989
Register 314:	USB Request Packet Count in Block Transfer Endpoint 15 (USBRQPKTCOUNT15), offset 0x33C .....	989
Register 315:	USB Receive Double Packet Buffer Disable (USBRXDPKTBUFDIS), offset 0x340 .....	991
Register 316:	USB Transmit Double Packet Buffer Disable (USBTXDPKTBUFDIS), offset 0x342 .....	993
Register 317:	USB External Power Control (USBEPCC), offset 0x400 .....	995
Register 318:	USB External Power Control Raw Interrupt Status (USBEPKRIS), offset 0x404 .....	998
Register 319:	USB External Power Control Interrupt Mask (USBEPKIM), offset 0x408 .....	999
Register 320:	USB External Power Control Interrupt Status and Clear (USBEPKISC), offset 0x40C .....	1000
Register 321:	USB Device RESUME Raw Interrupt Status (USBDRRIS), offset 0x410 .....	1001
Register 322:	USB Device RESUME Interrupt Mask (USBDRIM), offset 0x414 .....	1002
Register 323:	USB Device RESUME Interrupt Status and Clear (USBDRISC), offset 0x418 .....	1003
Register 324:	USB General-Purpose Control and Status (USBGPCS), offset 0x41C .....	1004

Register 325: USB VBUS Droop Control (USBVDC), offset 0x430 .....	1005
Register 326: USB VBUS Droop Control Raw Interrupt Status (USBVDCRIS), offset 0x434 .....	1006
Register 327: USB VBUS Droop Control Interrupt Mask (USBVDCIM), offset 0x438 .....	1007
Register 328: USB VBUS Droop Control Interrupt Status and Clear (USBVDCISC), offset 0x43C .....	1008
Register 329: USB ID Valid Detect Raw Interrupt Status (USBIDVRIS), offset 0x444 .....	1009
Register 330: USB ID Valid Detect Interrupt Mask (USBIDVIM), offset 0x448 .....	1010
Register 331: USB ID Valid Detect Interrupt Status and Clear (USBIDVISC), offset 0x44C .....	1011
Register 332: USB DMA Select (USBDMASEL), offset 0x450 .....	1012
<b>Analog Comparators .....</b>	<b>1014</b>
Register 1: Analog Comparator Masked Interrupt Status (ACMIS), offset 0x000 .....	1020
Register 2: Analog Comparator Raw Interrupt Status (ACRIS), offset 0x004 .....	1021
Register 3: Analog Comparator Interrupt Enable (ACINTEN), offset 0x008 .....	1022
Register 4: Analog Comparator Reference Voltage Control (ACREFCTL), offset 0x010 .....	1023
Register 5: Analog Comparator Status 0 (ACSTAT0), offset 0x020 .....	1024
Register 6: Analog Comparator Status 1 (ACSTAT1), offset 0x040 .....	1024
Register 7: Analog Comparator Status 2 (ACSTAT2), offset 0x060 .....	1024
Register 8: Analog Comparator Control 0 (ACCTL0), offset 0x024 .....	1025
Register 9: Analog Comparator Control 1 (ACCTL1), offset 0x044 .....	1025
Register 10: Analog Comparator Control 2 (ACCTL2), offset 0x064 .....	1025
<b>Pulse Width Modulator (PWM) .....</b>	<b>1027</b>
Register 1: PWM Master Control (PWMCTL), offset 0x000 .....	1042
Register 2: PWM Time Base Sync (PWMSYNC), offset 0x004 .....	1044
Register 3: PWM Output Enable (PWMENABLE), offset 0x008 .....	1045
Register 4: PWM Output Inversion (PWMINVERT), offset 0x00C .....	1047
Register 5: PWM Output Fault (PWMFAULT), offset 0x010 .....	1049
Register 6: PWM Interrupt Enable (PWMINTEN), offset 0x014 .....	1051
Register 7: PWM Raw Interrupt Status (PWMRIS), offset 0x018 .....	1053
Register 8: PWM Interrupt Status and Clear (PWMISC), offset 0x01C .....	1056
Register 9: PWM Status (PWMSTATUS), offset 0x020 .....	1059
Register 10: PWM Fault Condition Value (PWMFAULTVAL), offset 0x024 .....	1061
Register 11: PWM Enable Update (PWMENUUPD), offset 0x028 .....	1063
Register 12: PWM0 Control (PWM0CTL), offset 0x040 .....	1067
Register 13: PWM1 Control (PWM1CTL), offset 0x080 .....	1067
Register 14: PWM2 Control (PWM2CTL), offset 0x0C0 .....	1067
Register 15: PWM3 Control (PWM3CTL), offset 0x100 .....	1067
Register 16: PWM0 Interrupt and Trigger Enable (PWM0INTEN), offset 0x044 .....	1072
Register 17: PWM1 Interrupt and Trigger Enable (PWM1INTEN), offset 0x084 .....	1072
Register 18: PWM2 Interrupt and Trigger Enable (PWM2INTEN), offset 0x0C4 .....	1072
Register 19: PWM3 Interrupt and Trigger Enable (PWM3INTEN), offset 0x104 .....	1072
Register 20: PWM0 Raw Interrupt Status (PWM0RIS), offset 0x048 .....	1075
Register 21: PWM1 Raw Interrupt Status (PWM1RIS), offset 0x088 .....	1075
Register 22: PWM2 Raw Interrupt Status (PWM2RIS), offset 0x0C8 .....	1075
Register 23: PWM3 Raw Interrupt Status (PWM3RIS), offset 0x108 .....	1075
Register 24: PWM0 Interrupt Status and Clear (PWM0ISC), offset 0x04C .....	1077
Register 25: PWM1 Interrupt Status and Clear (PWM1ISC), offset 0x08C .....	1077
Register 26: PWM2 Interrupt Status and Clear (PWM2ISC), offset 0x0CC .....	1077
Register 27: PWM3 Interrupt Status and Clear (PWM3ISC), offset 0x10C .....	1077
Register 28: PWM0 Load (PWM0LOAD), offset 0x050 .....	1079

Register 29:	PWM1 Load (PWM1LOAD), offset 0x090	1079
Register 30:	PWM2 Load (PWM2LOAD), offset 0x0D0	1079
Register 31:	PWM3 Load (PWM3LOAD), offset 0x110	1079
Register 32:	PWM0 Counter (PWM0COUNT), offset 0x054	1080
Register 33:	PWM1 Counter (PWM1COUNT), offset 0x094	1080
Register 34:	PWM2 Counter (PWM2COUNT), offset 0x0D4	1080
Register 35:	PWM3 Counter (PWM3COUNT), offset 0x114	1080
Register 36:	PWM0 Compare A (PWM0CMPA), offset 0x058	1081
Register 37:	PWM1 Compare A (PWM1CMPA), offset 0x098	1081
Register 38:	PWM2 Compare A (PWM2CMPA), offset 0x0D8	1081
Register 39:	PWM3 Compare A (PWM3CMPA), offset 0x118	1081
Register 40:	PWM0 Compare B (PWM0CMPB), offset 0x05C	1082
Register 41:	PWM1 Compare B (PWM1CMPB), offset 0x09C	1082
Register 42:	PWM2 Compare B (PWM2CMPB), offset 0x0DC	1082
Register 43:	PWM3 Compare B (PWM3CMPB), offset 0x11C	1082
Register 44:	PWM0 Generator A Control (PWM0GENA), offset 0x060	1083
Register 45:	PWM1 Generator A Control (PWM1GENA), offset 0x0A0	1083
Register 46:	PWM2 Generator A Control (PWM2GENA), offset 0x0E0	1083
Register 47:	PWM3 Generator A Control (PWM3GENA), offset 0x120	1083
Register 48:	PWM0 Generator B Control (PWM0GENB), offset 0x064	1086
Register 49:	PWM1 Generator B Control (PWM1GENB), offset 0x0A4	1086
Register 50:	PWM2 Generator B Control (PWM2GENB), offset 0x0E4	1086
Register 51:	PWM3 Generator B Control (PWM3GENB), offset 0x124	1086
Register 52:	PWM0 Dead-Band Control (PWM0DBCTL), offset 0x068	1089
Register 53:	PWM1 Dead-Band Control (PWM1DBCTL), offset 0x0A8	1089
Register 54:	PWM2 Dead-Band Control (PWM2DBCTL), offset 0x0E8	1089
Register 55:	PWM3 Dead-Band Control (PWM3DBCTL), offset 0x128	1089
Register 56:	PWM0 Dead-Band Rising-Edge Delay (PWM0DBRISE), offset 0x06C	1090
Register 57:	PWM1 Dead-Band Rising-Edge Delay (PWM1DBRISE), offset 0x0AC	1090
Register 58:	PWM2 Dead-Band Rising-Edge Delay (PWM2DBRISE), offset 0x0EC	1090
Register 59:	PWM3 Dead-Band Rising-Edge Delay (PWM3DBRISE), offset 0x12C	1090
Register 60:	PWM0 Dead-Band Falling-Edge-Delay (PWM0DBFALL), offset 0x070	1091
Register 61:	PWM1 Dead-Band Falling-Edge-Delay (PWM1DBFALL), offset 0x0B0	1091
Register 62:	PWM2 Dead-Band Falling-Edge-Delay (PWM2DBFALL), offset 0x0F0	1091
Register 63:	PWM3 Dead-Band Falling-Edge-Delay (PWM3DBFALL), offset 0x130	1091
Register 64:	PWM0 Fault Source 0 (PWM0FLTSRC0), offset 0x074	1092
Register 65:	PWM1 Fault Source 0 (PWM1FLTSRC0), offset 0x0B4	1092
Register 66:	PWM2 Fault Source 0 (PWM2FLTSRC0), offset 0x0F4	1092
Register 67:	PWM3 Fault Source 0 (PWM3FLTSRC0), offset 0x134	1092
Register 68:	PWM0 Fault Source 1 (PWM0FLTSRC1), offset 0x078	1094
Register 69:	PWM1 Fault Source 1 (PWM1FLTSRC1), offset 0x0B8	1094
Register 70:	PWM2 Fault Source 1 (PWM2FLTSRC1), offset 0x0F8	1094
Register 71:	PWM3 Fault Source 1 (PWM3FLTSRC1), offset 0x138	1094
Register 72:	PWM0 Minimum Fault Period (PWM0MINFLTPER), offset 0x07C	1097
Register 73:	PWM1 Minimum Fault Period (PWM1MINFLTPER), offset 0x0BC	1097
Register 74:	PWM2 Minimum Fault Period (PWM2MINFLTPER), offset 0x0FC	1097
Register 75:	PWM3 Minimum Fault Period (PWM3MINFLTPER), offset 0x13C	1097
Register 76:	PWM0 Fault Pin Logic Sense (PWM0FLTSEN), offset 0x800	1098

Register 77:	PWM1 Fault Pin Logic Sense (PWM1FLTSEN), offset 0x880 .....	1098
Register 78:	PWM2 Fault Pin Logic Sense (PWM2FLTSEN), offset 0x900 .....	1098
Register 79:	PWM3 Fault Pin Logic Sense (PWM3FLTSEN), offset 0x980 .....	1098
Register 80:	PWM0 Fault Status 0 (PWM0FLTSTAT0), offset 0x804 .....	1099
Register 81:	PWM1 Fault Status 0 (PWM1FLTSTAT0), offset 0x884 .....	1099
Register 82:	PWM2 Fault Status 0 (PWM2FLTSTAT0), offset 0x904 .....	1099
Register 83:	PWM3 Fault Status 0 (PWM3FLTSTAT0), offset 0x984 .....	1099
Register 84:	PWM0 Fault Status 1 (PWM0FLTSTAT1), offset 0x808 .....	1101
Register 85:	PWM1 Fault Status 1 (PWM1FLTSTAT1), offset 0x888 .....	1101
Register 86:	PWM2 Fault Status 1 (PWM2FLTSTAT1), offset 0x908 .....	1101
Register 87:	PWM3 Fault Status 1 (PWM3FLTSTAT1), offset 0x988 .....	1101
<b>Quadrature Encoder Interface (QEI) .....</b>		<b>1104</b>
Register 1:	QEI Control (QEICTL), offset 0x000 .....	1111
Register 2:	QEI Status (QEISTAT), offset 0x004 .....	1114
Register 3:	QEI Position (QEIPOS), offset 0x008 .....	1115
Register 4:	QEI Maximum Position (QEIMAXPOS), offset 0x00C .....	1116
Register 5:	QEI Timer Load (QEILOAD), offset 0x010 .....	1117
Register 6:	QEI Timer (QEITIME), offset 0x014 .....	1118
Register 7:	QEI Velocity Counter (QEICOUNT), offset 0x018 .....	1119
Register 8:	QEI Velocity (QEISPEED), offset 0x01C .....	1120
Register 9:	QEI Interrupt Enable (QEIINTEN), offset 0x020 .....	1121
Register 10:	QEI Raw Interrupt Status (QEIRIS), offset 0x024 .....	1123
Register 11:	QEI Interrupt Status and Clear (QEIISC), offset 0x028 .....	1125

## Revision History

The revision history table notes changes made between the indicated revisions of the LM3S9B96 data sheet.

**Table 1. Revision History**

Date	Revision	Description
June 2010	7299	<ul style="list-style-type: none"> <li>■ Changed memory map ending address for EPI0 mapped peripheral and RAM from 0xCFFF.FFFF to 0xDFFF.FFFF.</li> <li>■ Removed 4.194304-MHz crystal as a source for the system clock and PLL.</li> <li>■ Summarized ROM contents descriptions in the "Internal Memory" chapter and removed various ROM appendices.</li> <li>■ Clarified DMA channel terminology: changed name of <b>DMA Channel Alternate Select (DMACHALT)</b> register to <b>DMA Channel Assignment (DMACHASGN)</b> register, changed <code>CHALT</code> bit field to <code>CHASGN</code>, and changed terminology from primary and alternate channels to primary and secondary channels.</li> <li>■ Clarified <b>EPI Main Baud Rate (EPIBAUD)</b> equation.</li> <li>■ In Signal Tables chapter, added table "Connections for Unused Signals."</li> <li>■ In "Electrical Characteristics" chapter: <ul style="list-style-type: none"> <li>– In "Reset Characteristics" table, corrected Supply voltage (VDD) rise time.</li> <li>– Clarified figure "SDRAM Initialization and Load Mode Register Timing".</li> <li>– Added BSEL0n/BSEL1n to EPI timing diagrams.</li> </ul> </li> </ul>
May 2010	7164	<ul style="list-style-type: none"> <li>■ Added data sheets for five new Stellaris® Tempest-class parts: LM3S1R26, LM3S1621, LM3S1B21, LM3S9781, and LM3S9B81.</li> <li>■ Additional minor data sheet clarifications and corrections.</li> </ul>
May 2010	7101	<ul style="list-style-type: none"> <li>■ Added pin table "Possible Pin Assignments for Alternate Functions", which lists the signals based on number of possible pin assignments. This table can be used to plan how to configure the pins for a particular functionality.</li> <li>■ Additional minor data sheet clarifications and corrections.</li> </ul>
March 2010	6983	<ul style="list-style-type: none"> <li>■ Corrected reset for <b>EPIHB8CFG</b>, <b>EPI_HB16CFG</b> and <b>EPIGPCFG</b> registers.</li> <li>■ Extended <code>TBRL</code> bit field in <b>GPTMTBR</b> register.</li> <li>■ Additional minor data sheet clarifications and corrections.</li> </ul>
March 2010	6912	<ul style="list-style-type: none"> <li>■ Renamed the <b>USER_DBG</b> register to the <b>BOOTCFG</b> register in the Internal Memory chapter. Added information on how to use a GPIO pin to force the ROM Boot Loader to execute on reset.</li> <li>■ Added three figures to the ADC chapter on sample phase control.</li> <li>■ Clarified configuration of <code>USB0VBUS</code> and <code>USB0ID</code> in OTG mode.</li> </ul>

Table 1. Revision History (continued)

Date	Revision	Description
February 2010	6790	<ul style="list-style-type: none"> <li>■ Added 108-ball BGA package.</li> <li>■ In "System Control" chapter: <ul style="list-style-type: none"> <li>– Clarified functional description for external reset and brown-out reset.</li> <li>– Clarified Debug Access Port operation after Sleep modes.</li> <li>– Corrected the reset value of the <b>Run-Mode Clock Configuration 2 (RCC2)</b> register.</li> </ul> </li> <li>■ In "Internal Memory" chapter, clarified wording on Flash memory access errors and added a section on interrupts to the Flash memory description.</li> <li>■ In "External Peripheral Interface" chapter: <ul style="list-style-type: none"> <li>– Added clarification about byte selects and dual chip selects.</li> <li>– Added timing diagrams for continuous-read mode (formerly SRAM mode).</li> <li>– Corrected reset values of <b>EPI Write FIFO Count (EPIWFIFCNT)</b> and <b>EPI Raw Interrupt Status (EPIRIS)</b> registers.</li> </ul> </li> <li>■ Added clarification about timer operating modes and added register descriptions for the <b>GPTM Timer n Prescale Match (GPTMTnPMR)</b> registers.</li> <li>■ Clarified register descriptions for <b>GPTM Timer A Value (GPTMTAV)</b> and <b>GPTM Timer B Value (GPTMTBV)</b> registers.</li> <li>■ Corrected the reset value of the <b>ADC Sample Sequence Result FIFO n (ADCSSFIFOn)</b> registers.</li> <li>■ Added <b>ADC Sample Phase Control (ADCSPC)</b> register at offset 0x24.</li> <li>■ Added caution note to the <b>I<sup>2</sup>C Master Timer Period (I2CMTPR)</b> register description and changed field width to 7 bits.</li> <li>■ In the "Controller Area Network" chapter, added clarification about reading from the CAN FIFO buffer and clarified packet timestamps functional description.</li> <li>■ In the "Ethernet Controller" chapter: <ul style="list-style-type: none"> <li>– Corrected the reset value and the <b>LED1</b> bit positions of the <b>Ethernet MAC LED Encoding (MACLED)</b> register.</li> <li>– Added clarification about the use of the <b>NPR</b> field in the <b>Ethernet MAC Number of Packets (MACNP)</b> register.</li> <li>– Corrected reset values for <b>Ethernet PHY Management Register 0 – Control (MR0)</b> and <b>Ethernet PHY Management Register 5 – Auto-Negotiation Link Partner Base Page Ability (MR5)</b> registers.</li> </ul> </li> <li>■ Added <b>Session Disconnect (DISCON)</b> bit to the <b>USB General Interrupt Status (USBIS)</b> and <b>USB Interrupt Enable (USBIE)</b> registers.</li> <li>■ Made these changes to the Operating Characteristics chapter: <ul style="list-style-type: none"> <li>– Added storage temperature ratings to "Temperature Characteristics" table</li> <li>– Added "ESD Absolute Maximum Ratings" table</li> </ul> </li> <li>■ Made these changes to the Electrical Characteristics chapter: <ul style="list-style-type: none"> <li>– In "Flash Memory Characteristics" table, corrected Mass erase time</li> <li>– Added sleep and deep-sleep wake-up times ("Sleep Modes AC Characteristics" table)</li> <li>– In "Reset Characteristics" table, corrected units for supply voltage (VDD) rise time</li> <li>– Modified the preliminary current consumption specification for Run mode 1 and Deep-Sleep mode.</li> <li>– Added table entry for VDD3ON power consumption to Table 27-8 on page 1207.</li> </ul> </li> <li>■ Added additional DriverLib functions to appendix.</li> </ul>

Table 1. Revision History (*continued*)

Date	Revision	Description
October 2009	6458	<ul style="list-style-type: none"> <li>■ Released new 1000, 3000, 5000 and 9000 series Stellaris® devices.</li> <li>■ The IDCODE value was corrected to be 0x4BA0.0477.</li> <li>■ Clarified that the NMISSET bit in the ICSR register in the NVIC is also a source for NMI.</li> <li>■ Clarified the use of the LDO.</li> <li>■ To clarify clock operation, reorganized clocking section, changed the USEFRACT bit to the DIV400 bit and the FRACT bit to the SYSDIV2LSB bit in the RCC2 register, added tables, and rewrote descriptions.</li> <li>■ Corrected bit description of the DSDIVORIDE field in the DSLPCLKCFG register.</li> <li>■ Removed the DSFLASHCFG register at System Control offset 0x14C as it does not function correctly.</li> <li>■ Removed the MAXADC1SPD and MAXADC0SPD fields from the DCGC0 as they have no function in deep-sleep mode.</li> <li>■ Corrected address offsets for the Flash Write Buffer (FWBn) registers.</li> <li>■ Added Flash Control (FCTL) register at Internal memory offset 0x0F8 to help control frequent power cycling when hibernation is not used.</li> <li>■ Changed the name of the EPI channels for clarification: EPI0_TX became EPI0_WFIFO and EPI0_RX became EPI0_NBRFIFO. This change was also made in the DC7 bit descriptions.</li> <li>■ Removed the DMACHIS register at DMA module offset 0x504 as it does not function correctly.</li> <li>■ Corrected alternate channel assignments for the µDMA controller.</li> <li>■ Major improvements to the EPI chapter.</li> <li>■ EPISDRAMCFG2 register was deleted as its function is not needed.</li> <li>■ Clarified CAN bit timing and corrected examples.</li> <li>■ Added pseudo-code for MDI/MDIX operation.</li> <li>■ Corrected reset value of the MR1 register to 0x7809.</li> <li>■ Clarified PWM source for ADC triggering</li> <li>■ Corrected ADDR field in the USBTXFIFOADD register to be 9 bits instead of 13 bits.</li> <li>■ Changed SSI set up and hold times to be expressed in system clocks, not ns.</li> <li>■ Updated Electrical Characteristics chapter with latest data. Changes were made to ADC and EPI content.</li> <li>■ Additional minor data sheet clarifications and corrections.</li> </ul>

Table 1. Revision History (*continued*)

Date	Revision	Description
July 2009	5930	<ul style="list-style-type: none"> <li>■ Added "Non-Blocking Read Cycle", "Normal Read Cycle", and "Write Cycle" sections to EPI chapter.</li> <li>■ Corrected values for MAXADC0SPD and MAXADC1SPD bits in <b>DC1</b>, <b>RCGC0</b>, <b>SCGC0</b>, and <b>DCGC0</b> registers.</li> <li>■ Corrected figure "TI Synchronous Serial Frame Format (Single Transfer)".</li> <li>■ Added description for Ethernet PHY power-saving modes.</li> <li>■ Made a number of corrections to the Electrical Characteristics chapter: <ul style="list-style-type: none"> <li>– Deleted <math>V_{BAT}</math> and <math>V_{REFA}</math> parameters from and added footnotes to Recommended DC Operating Conditions table.</li> <li>– Deleted Nominal and Maximum Current Specifications section.</li> <li>– Modified EPI SDRAM Characteristics table: <ul style="list-style-type: none"> <li>• Changed <math>t_{EPIR}</math> to <math>t_{SDRAMR}</math> and deleted values for 2-mA and 4-mA drive.</li> <li>• Changed <math>t_{EPIF}</math> to <math>t_{SDRAMF}</math> and deleted values for 2-mA and 4-mA drive.</li> </ul> </li> <li>– Changed values for <math>t_{COV}</math>, <math>t_{COI}</math>, and <math>t_{COT}</math> parameters in EPI SDRAM Interface Characteristics table.</li> <li>– Deleted SDRAM Read Command Timing, SDRAM Write Command Timing, SDRAM Write Burst Timing, SDRAM Precharge Command Timing and SDRAM CAS Latency Timing figures and replaced with SDRAM Read Timing and SDRAM Write Timing figures.</li> <li>– Modified Host-Bus 8/16 Mode Write Timing figure.</li> <li>– Modified General-Purpose Mode Read and Write Timing figure.</li> <li>– Modified values for <math>t_{DV}</math> and <math>t_{DI}</math> parameters, and deleted <math>t_{OD}</math> parameter from EPI General-Purpose Interface Characteristics figure.</li> <li>– Major changes to ADC Characteristics tables, including adding additional tables and diagram.</li> </ul> </li> <li>■ Added missing ROM_I2SIntStatus function to ROM DriverLib Functions appendix.</li> <li>■ Corrected ordering part numbers.</li> <li>■ Additional minor data sheet clarifications and corrections.</li> </ul>



Table 1. Revision History (*continued*)

Date	Revision	Description
June 2009	5779	<ul style="list-style-type: none"> <li>■ In System Control chapter, clarified power-on reset and external reset pin descriptions in "Reset Sources" section.</li> <li>■ Added missing comparator output pin bits to <b>DC3</b> register; reset value changed as well.</li> <li>■ Clarified explanation of nonvolatile register programming in Internal Memory chapter.</li> <li>■ Added explanation of reset value to <b>FMPRE0/1/2/3</b>, <b>FMPPE0/1/2/3</b>, <b>USER_DBG</b>, and <b>USER_REG0</b> registers.</li> <li>■ In Request Type Support table in DMA chapter, corrected general-purpose timer row.</li> <li>■ In General-Purpose Timers chapter, clarified DMA operation.</li> <li>■ Added table "Preliminary Current Consumption" to Characteristics chapter.</li> <li>■ Corrected Nom and Max values in EPI Characteristics table.</li> <li>■ Added "CSn to output invalid" parameter to EPI table "EPI Host-Bus 8 and Host-Bus 16 Interface Characteristics" and figure "Host-Bus 8/16 Mode Read Timing".</li> <li>■ Corrected INL, DNL, OFF and GAIN values in ADC Characteristics table.</li> <li>■ Updated ROM DriverLib appendix with RevC0 functions.</li> <li>■ Updated part ordering numbers.</li> <li>■ Additional minor data sheet clarifications and corrections.</li> </ul>
May 2009	5285	Started tracking revision history.

## About This Document

This data sheet provides reference information for the LM3S9B96 microcontroller, describing the functional blocks of the system-on-chip (SoC) device designed around the ARM® Cortex™-M3 core.

### Audience

This manual is intended for system software developers, hardware designers, and application developers.

### About This Manual

This document is organized into sections that correspond to each major feature.

### Related Documents

The following related documents are available on the documentation CD or from the Stellaris® web site at [www.ti.com/stellaris](http://www.ti.com/stellaris):

- *Stellaris® Errata*
- *ARM® Cortex™-M3 Errata*
- *ARM® CoreSight Technical Reference Manual*
- *ARM® Cortex™-M3 Technical Reference Manual*
- *ARM® v7-M Architecture Application Level Reference Manual*
- *Stellaris® Boot Loader User's Guide*
- *Stellaris® Graphics Library User's Guide*
- *Stellaris® Peripheral Driver Library User's Guide*
- *Stellaris® ROM User's Guide*
- *Stellaris® USB Library User's Guide*
- *SafeRTOS User's Manual*

The following related documents are also referenced:

- *IEEE Standard 1149.1-Test Access Port and Boundary-Scan Architecture*

This documentation list was current as of publication date. Please check the web site for additional documentation, including application notes and white papers.

## Documentation Conventions

This document uses the conventions shown in Table 2 on page 43.

**Table 2. Documentation Conventions**

Notation	Meaning
<b>General Register Notation</b>	
<b>REGISTER</b>	APB registers are indicated in uppercase bold. For example, <b>PBORCTL</b> is the Power-On and Brown-Out Reset Control register. If a register name contains a lowercase n, it represents more than one register. For example, <b>SRCRn</b> represents any (or all) of the three Software Reset Control registers: <b>SRCR0</b> , <b>SRCR1</b> , and <b>SRCR2</b> .
bit	A single bit in a register.
bit field	Two or more consecutive and related bits.
offset 0xnnn	A hexadecimal increment to a register's address, relative to that module's base address as specified in "Memory Map" on page 83.
Register N	Registers are numbered consecutively throughout the document to aid in referencing them. The register number has no meaning to software.
reserved	Register bits marked <i>reserved</i> are reserved for future use. In most cases, reserved bits are set to 0; however, user software should not rely on the value of a reserved bit. To provide software compatibility with future products, the value of a reserved bit should be preserved across a read-modify-write operation.
yy:xx	The range of register bits inclusive from xx to yy. For example, 31:15 means bits 15 through 31 in that register.
<b>Register Bit/Field Types</b>	
RC	Software can read this field. The bit or field is cleared by hardware after reading the bit/field.
RO	Software can read this field. Always write the chip reset value.
R/W	Software can read or write this field.
R/W1C	Software can read or write this field. A write of a 0 to a W1C bit does not affect the bit value in the register. A write of a 1 clears the value of the bit in the register; the remaining bits remain unchanged.  This register type is primarily used for clearing interrupt status bits where the read operation provides the interrupt status and the write of the read value clears only the interrupts being reported at the time the register was read.
R/W1S	Software can read or write a 1 to this field. A write of a 0 to a R/W1S bit does not affect the bit value in the register.
W1C	Software can write this field. A write of a 0 to a W1C bit does not affect the bit value in the register. A write of a 1 clears the value of the bit in the register; the remaining bits remain unchanged. A read of the register returns no meaningful data.  This register is typically used to clear the corresponding bit in an interrupt register.
WO	Only a write by software is valid; a read of the register returns no meaningful data.
<b>Register Bit/Field Reset Value</b>	
0	Bit cleared to 0 on chip reset.
1	Bit set to 1 on chip reset.
-	Nondeterministic.
<b>Pin/Signal Notation</b>	
[ ]	Pin alternate function; a pin defaults to the signal without the brackets.
pin	Refers to the physical connection on the package.
signal	Refers to the electrical signal encoding of a pin.

**Table 2. Documentation Conventions (continued)**

Notation	Meaning
assert a signal	Change the value of the signal from the logically False state to the logically True state. For active High signals, the asserted signal value is 1 (High); for active Low signals, the asserted signal value is 0 (Low). The active polarity (High or Low) is defined by the signal name (see <code>SIGNAL</code> and <code><u>SIGNAL</u></code> below).
deassert a signal	Change the value of the signal from the logically True state to the logically False state.
<code><u>SIGNAL</u></code>	Signal names are in uppercase and in the Courier font. An overbar on a signal name indicates that it is active Low. To assert <code><u>SIGNAL</u></code> is to drive it Low; to deassert <code><u>SIGNAL</u></code> is to drive it High.
<code>SIGNAL</code>	Signal names are in uppercase and in the Courier font. An active High signal has no overbar. To assert <code>SIGNAL</code> is to drive it High; to deassert <code>SIGNAL</code> is to drive it Low.
<b>Numbers</b>	
X	An uppercase X indicates any of several values is allowed, where X can be any legal pattern. For example, a binary value of 0X00 can be either 0100 or 0000, a hex value of 0xX is 0x0 or 0x1, and so on.
0x	Hexadecimal numbers have a prefix of 0x. For example, 0x00FF is the hexadecimal number FF.  All other numbers within register tables are assumed to be binary. Within conceptual information, binary numbers are indicated with a b suffix, for example, 1011b, and decimal numbers are written without a prefix or suffix.

# 1 Architectural Overview

Texas Instruments is the industry leader in bringing 32-bit capabilities and the full benefits of ARM® Cortex-M3™-based microcontrollers to the broadest reach of the microcontroller market. For current users of 8- and 16-bit MCUs, Stellaris® with Cortex-M3 offers a direct path to the strongest ecosystem of development tools, software and knowledge in the industry. Designers who migrate to Stellaris® benefit from great tools, small code footprint and outstanding performance. Even more important, designers can enter the ARM ecosystem with full confidence in a compatible roadmap from \$1 to 1 GHz. For users of current 32-bit MCUs, the Stellaris® family offers the industry's first implementation of Cortex-M3 and the Thumb-2 instruction set. With blazingly-fast responsiveness, Thumb-2 technology combines both 16-bit and 32-bit instructions to deliver the best balance of code density and performance. Thumb-2 uses 26 percent less memory than pure 32-bit code to reduce system cost while delivering 25 percent better performance. The Texas Instruments Stellaris® family of microcontrollers—the first ARM® Cortex™-M3 based controllers—brings high-performance 32-bit computing to cost-sensitive embedded microcontroller applications. These pioneering parts deliver customers 32-bit performance at a cost equivalent to legacy 8- and 16-bit devices, all in a package with a small footprint.

The LM3S9B96 microcontroller has the following features:

- ARM® Cortex™-M3 Processor Core
  - 80-MHz operation; 100 DMIPS performance
  - ARM Cortex SysTick Timer
  - Nested Vectored Interrupt Controller (NVIC)
- On-Chip Memory
  - 256 KB single-cycle Flash memory up to 50 MHz; a prefetch buffer improves performance above 50 MHz
  - 96 KB single-cycle SRAM
  - Internal ROM loaded with StellarisWare® software:
    - Stellaris® Peripheral Driver Library
    - Stellaris® Boot Loader
    - SafeRTOS™ kernel
    - Advanced Encryption Standard (AES) cryptography tables
    - Cyclic Redundancy Check (CRC) error detection functionality
- External Peripheral Interface (EPI)
  - 8/16/32-bit dedicated parallel bus for external peripherals
  - Supports SDRAM, SRAM/Flash memory, FPGAs, CPLDs
- Advanced Serial Integration

- 10/100 Ethernet MAC and PHY with IEEE 1588 PTP hardware support
- Two CAN 2.0 A/B controllers
- USB 2.0 OTG/Host/Device
- Three UARTs with IrDA and ISO 7816 support (one UART with full modem controls)
- Two I<sup>2</sup>C modules
- Two Synchronous Serial Interface modules (SSI)
- Integrated Interchip Sound (I<sup>2</sup>S) module
- System Integration
  - Direct Memory Access Controller (DMA)
  - System control and clocks including on-chip precision 16-MHz oscillator
  - Four 32-bit timers (up to eight 16-bit)
  - Eight Capture Compare PWM pins (CCP)
  - Real-Time Clock
  - Two Watchdog Timers
    - One timer runs off the main oscillator
    - One timer runs off the precision internal oscillator
  - Up to 65 GPIOs, depending on configuration
    - Highly flexible pin muxing allows use as GPIO or one of several peripheral functions
    - Independently configurable to 2, 4 or 8 mA drive capability
    - Up to 4 GPIOs can have 18 mA drive capability
- Advanced Motion Control
  - Eight advanced PWM outputs for motion and energy applications
  - Four fault inputs to promote low-latency shutdown
  - Two Quadrature Encoder Inputs (QEI)
- Analog
  - Two 10-bit Analog-to-Digital Converters (ADC) with sixteen analog input channels and sample rate of one million samples/second
  - Three analog comparators
  - 16 digital comparators

- On-chip voltage regulator
- JTAG and ARM Serial Wire Debug (SWD)
- 100-pin LQFP and 108-ball BGA package
- Industrial (-40°C to 85°C) Temperature Range

The LM3S9B96 microcontroller is targeted for industrial applications, including remote monitoring, electronic point-of-sale machines, test and measurement equipment, network appliances and switches, factory automation, HVAC and building control, gaming equipment, motion control, medical instrumentation, and fire and security.

In addition, the LM3S9B96 microcontroller offers the advantages of ARM's widely available development tools, System-on-Chip (SoC) infrastructure IP applications, and a large user community. Additionally, the microcontroller uses ARM's Thumb®-compatible Thumb-2 instruction set to reduce memory requirements and, thereby, cost. Finally, the LM3S9B96 microcontroller is code-compatible to all members of the extensive Stellaris® family; providing flexibility to fit our customers' precise needs.

Texas Instruments offers a complete solution to get to market quickly, with evaluation and development boards, white papers and application notes, an easy-to-use peripheral driver library, and a strong support, sales, and distributor network. See “Ordering and Contact Information” on page 1276 for ordering information for Stellaris® family devices.

## 1.1 Functional Overview

The following sections provide an overview of the features of the LM3S9B96 microcontroller. The page number in parentheses indicates where that feature is discussed in detail. Ordering and support information can be found in “Ordering and Contact Information” on page 1276.

### 1.1.1 ARM Cortex™-M3

The following sections provide an overview of the ARM Cortex™-M3 processor core and instruction set, the integrated System Timer (SysTick) and the Nested Vectored Interrupt Controller.

#### 1.1.1.1 Processor Core (see page 70)

All members of the Stellaris® product family, including the LM3S9B96 microcontroller, are designed around an ARM Cortex™-M3 processor core. The ARM Cortex-M3 processor provides the core for a high-performance, low-cost platform that meets the needs of minimal memory implementation, reduced pin count, and low power consumption, while delivering outstanding computational performance and exceptional system response to interrupts.

- 32-bit ARM® Cortex™-M3 v7M architecture optimized for small-footprint embedded applications
- Outstanding processing performance combined with fast interrupt handling
- Thumb-2 mixed 16-/32-bit instruction set, delivers the high performance expected of a 32-bit ARM core in a compact memory size usually associated with 8- and 16-bit devices; typically in the range of a few kilobytes of memory for microcontroller-class applications
  - Single-cycle multiply instruction and hardware divide
  - Atomic bit manipulation (bit-banding), delivering maximum memory utilization and streamlined peripheral control

- Unaligned data access, enabling data to be efficiently packed into memory
- Fast code execution permits slower processor clock or increases sleep mode time
- Harvard architecture characterized by separate buses for instruction and data
- Efficient processor core, system and memories
- Hardware division and fast multiplier
- Deterministic, high-performance interrupt handling for time-critical applications
- Memory protection unit (MPU) to provide a privileged mode for protected operating system functionality
- Enhanced system debug with extensive breakpoint and trace capabilities
- Serial Wire Debug and Serial Wire Trace reduce the number of pins required for debugging and tracing
- Migration from the ARM7™ processor family for better performance and power efficiency
- Optimized for single-cycle Flash memory usage
- Ultra-low power consumption with integrated sleep modes
- 80-MHz operation
- 1.25 DMIPS/MHz

“ARM Cortex-M3 Processor Core” on page 70 provides an overview of the ARM core; the core is detailed in the *ARM® Cortex™-M3 Technical Reference Manual*.

#### 1.1.1.2 System Timer (SysTick) (see page 80)

ARM Cortex-M3 includes an integrated system timer, SysTick. SysTick provides a simple, 24-bit, clear-on-write, decrementing, wrap-on-zero counter with a flexible control mechanism. The counter can be used in several different ways, for example:

- An RTOS tick timer that fires at a programmable rate (for example, 100 Hz) and invokes a SysTick routine
- A high-speed alarm timer using the system clock
- A variable rate alarm or signal timer—the duration is range-dependent on the reference clock used and the dynamic range of the counter
- A simple counter used to measure time to completion and time used
- An internal clock-source control based on missing/meeting durations. The COUNTFLAG field in the SysTick Control and Status register can be used to determine if an action completed within a set duration, as part of a dynamic clock management control loop

#### 1.1.1.3 Nested Vectored Interrupt Controller (NVIC) (see page 86)

The LM3S9B96 controller includes the ARM Nested Vectored Interrupt Controller (NVIC). The NVIC and Cortex-M3 prioritize and handle all exceptions in Handler Mode. The processor state is



automatically stored to the stack on an exception and automatically restored from the stack at the end of the Interrupt Service Routine (ISR). The interrupt vector is fetched in parallel to the state saving, enabling efficient interrupt entry. The processor supports tail-chaining, meaning that back-to-back interrupts can be performed without the overhead of state saving and restoration. Software can set eight priority levels on 7 exceptions (system handlers) and 53 interrupts.

- Deterministic, fast interrupt processing: always 12 cycles, or just 6 cycles with tail-chaining
- External non-maskable interrupt signal (NMI) available for immediate execution of NMI handler for safety critical applications
- Dynamically reprioritizable interrupts
- Exceptional interrupt handling via hardware implementation of required register manipulations

“Interrupts” on page 86 provides an overview of the NVIC controller and the interrupt map. Exceptions and interrupts are detailed in the *ARM® Cortex™-M3 Technical Reference Manual*.

## 1.1.2 On-Chip Memory

The following sections describe the on-chip memory modules.

### 1.1.2.1 SRAM (see page 210)

The LM3S9B96 microcontroller provides 96 KB of single-cycle on-chip SRAM. The internal SRAM of the Stellaris® devices is located at offset 0x2000.0000 of the device memory map.

Because read-modify-write (RMW) operations are very time consuming, ARM has introduced *bit-banding* technology in the new Cortex-M3 processor. With a bit-band-enabled processor, certain regions in the memory map (SRAM and peripheral space) can use address aliases to access individual bits in a single, atomic operation.

Data can be transferred to and from the SRAM using the Micro Direct Memory Access Controller (μDMA).

### 1.1.2.2 Flash Memory (see page 212)

The LM3S9B96 microcontroller provides 256 KB of single-cycle on-chip Flash memory (above 50 MHz, the Flash memory can be accessed in a single cycle as long as the code is linear; branches incur a one-cycle stall). The Flash memory is organized as a set of 2-KB blocks that can be individually erased. Erasing a block causes the entire contents of the block to be reset to all 1s. These blocks are paired into a set of 2-KB blocks that can be individually protected. The blocks can be marked as read-only or execute-only, providing different levels of code protection. Read-only blocks cannot be erased or programmed, protecting the contents of those blocks from being modified. Execute-only blocks cannot be erased or programmed, and can only be read by the controller instruction fetch mechanism, protecting the contents of those blocks from being read by either the controller or by a debugger.

### 1.1.2.3 ROM (see page 210)

The LM3S9B96 ROM is preprogrammed with the following software and programs:

- Stellaris® Peripheral Driver Library
- Stellaris® Boot Loader
- SafeRTOS™ preemptive real-time kernel

- Advanced Encryption Standard (AES) cryptography tables
- Cyclic Redundancy Check (CRC) error-detection functionality

The Stellaris<sup>®</sup> Peripheral Driver Library is a royalty-free software library for controlling on-chip peripherals with a boot-loader capability. The library performs both peripheral initialization and control functions, with a choice of polled or interrupt-driven peripheral support. In addition, the library is designed to take full advantage of the stellar interrupt performance of the ARM<sup>®</sup> Cortex<sup>™</sup>-M3 core. No special pragmas or custom assembly code prologue/epilogue functions are required. For applications that require in-field programmability, the royalty-free Stellaris<sup>®</sup> Boot Loader can act as an application loader and support in-field firmware updates.

Also included in the ROM is SafeRTOS<sup>™</sup> preemptive real-time kernel. This small-footprint kernel is designed for easy use in applications where a specified level of dependability is required. SafeRTOS<sup>™</sup> allows you to bring design-assured products to market rapidly with reduced risk and cost.

The Advanced Encryption Standard (AES) is a publicly defined encryption standard used by the U.S. Government. AES is a strong encryption method with reasonable performance and size. In addition, it is fast in both hardware and software, is fairly easy to implement, and requires little memory. The Texas Instruments encryption package is available with full source code, and is based on lesser general public license (LGPL) source. An LGPL means that the code can be used within an application without any copyleft implications for the application (the code does not automatically become open source). Modifications to the package source, however, must be open source.

CRC (Cyclic Redundancy Check) is a technique to validate a span of data has the same contents as when previously checked. This technique can be used to validate correct receipt of messages (nothing lost or modified in transit), to validate data after decompression, to validate that Flash memory contents have not been changed, and for other cases where the data needs to be validated. A CRC is preferred over a simple checksum (e.g. XOR all bits) because it catches changes more readily.

### 1.1.3 External Peripheral Interface (see page 360)

The External Peripheral Interface (EPI) provides access to external devices using a parallel path. Unlike communications peripherals such as SSI, UART, and I<sup>2</sup>C, the EPI is designed to act like a bus to external peripherals and memory.

The EPI has the following features:

- 8/16/32-bit dedicated parallel bus for external peripherals and memory
- Memory interface supports contiguous memory access independent of data bus width, thus enabling code execution directly from SDRAM, SRAM and Flash memory
- Blocking and non-blocking reads
- Separates processor from timing details through use of an internal write FIFO
- Efficient transfers using Micro Direct Memory Access Controller ( $\mu$ DMA)
  - Separate channels for read and write
  - Read channel request asserted by programmable levels on the internal non-blocking read FIFO (NBRFIFO)

- Write channel request asserted by empty on the internal write FIFO (WFIFO)

The EPI supports three primary functional modes: Synchronous Dynamic Random Access Memory (SDRAM) mode, Traditional Host-Bus mode, and General-Purpose mode. The EPI module also provides custom GPIOs; however, unlike regular GPIOs, the EPI module uses a FIFO in the same way as a communication mechanism and is speed-controlled using clocking.

- Synchronous Dynamic Random Access Memory (SDRAM)
  - Supports x16 (single data rate) SDRAM at up to 50 MHz
  - Supports low-cost SDRAMs up to 64 MB (512 megabits)
  - Includes automatic refresh and access to all banks/rows
  - Includes a Sleep/Standby mode to keep contents active with minimal power draw
  - Multiplexed address/data interface for reduced pin count
- Host-bus
  - Traditional x8 and x16 MCU bus interface capabilities
  - Similar device compatibility options as PIC, ATmega, 8051, and others
  - Access to SRAM, NOR Flash memory, and other devices, with up to 1 MB of addressing in unmultiplexed mode and 256 MB in multiplexed mode (512 MB in Host-Bus 16 mode with no byte selects)
  - Support of both muxed and de-muxed address and data
  - Access to a range of devices supporting the non-address FIFO x8 and x16 interface variant, with support for external FIFO (XFIFO) EMPTY and FULL signals
  - Speed controlled, with read and write data wait-state counters
  - Chip select modes include ALE, CSn, Dual CSn and ALE with dual CSn
  - Manual chip-enable (or use extra address pins)
- General Purpose
  - Wide parallel interfaces for fast communications with CPLDs and FPGAs
  - Data widths up to 32-bits
  - Data rates up to 150 MB/second
  - Optional “address” sizes from 4 bits to 20 bits
  - Optional clock output, read/write strobes, framing (with counter-based size), and clock-enable input
- General parallel GPIO
  - 1 to 32 bits, FIFOed with speed control

- Useful for custom peripherals or for digital data acquisition and actuator controls

### 1.1.4 Serial Communications Peripherals

The LM3S9B96 controller supports both asynchronous and synchronous serial communications with:

- 10/100 Ethernet MAC and PHY with IEEE 1588 PTP hardware support
- Two CAN 2.0 A/B Controllers
- USB 2.0 (full speed and low speed) OTG/Host/Device
- Three UARTs with IrDA and ISO 7816 support (one UART with full modem controls)
- Two I<sup>2</sup>C modules
- Two Synchronous Serial Interface modules (SSI)
- Integrated Interchip Sound (I<sup>2</sup>S) Module

The following sections provide more detail on each of these communications functions.

#### 1.1.4.1 Ethernet Controller (see page 814)

Ethernet is a frame-based computer networking technology for local area networks (LANs). Ethernet has been standardized as IEEE 802.3. This specification defines a number of wiring and signaling standards for the physical layer, two means of network access at the Media Access Control (MAC)/Data Link Layer, and a common addressing format.

The Stellaris<sup>®</sup> Ethernet Controller consists of a fully integrated media access controller (MAC) and network physical (PHY) interface and has the following features:

- Conforms to the *IEEE 802.3-2002 specification*
  - 10BASE-T/100BASE-TX IEEE-802.3 compliant. Requires only a dual 1:1 isolation transformer interface to the line
  - 10BASE-T/100BASE-TX ENDEC, 100BASE-TX scrambler/descrambler
  - Full-featured auto-negotiation
- Multiple operational modes
  - Full- and half-duplex 100 Mbps
  - Full- and half-duplex 10 Mbps
  - Power-saving and power-down modes
- Highly configurable
  - Programmable MAC address
  - LED activity selection
  - Promiscuous mode support

- CRC error-rejection control
- User-configurable interrupts
- Physical media manipulation
  - MDI/MDI-X cross-over support through software assist
  - Register-programmable transmit amplitude
  - Automatic polarity correction and 10BASE-T signal reception
- IEEE 1588 Precision Time Protocol: Provides highly accurate time stamps for individual packets
- Efficient transfers using Micro Direct Memory Access Controller ( $\mu$ DMA)
  - Separate channels for transmit and receive
  - Receive channel request asserted on packet receipt
  - Transmit channel request asserted on empty transmit FIFO

#### 1.1.4.2 Controller Area Network (see page 762)

Controller Area Network (CAN) is a multicast shared serial-bus standard for connecting electronic control units (ECUs). CAN was specifically designed to be robust in electromagnetically noisy environments and can utilize a differential balanced line like RS-485 or twisted-pair wire. Originally created for automotive purposes, it is now used in many embedded control applications (for example, industrial or medical). Bit rates up to 1 Mbps are possible at network lengths below 40 meters. Decreased bit rates allow longer network distances (for example, 125 Kbps at 500m).

A transmitter sends a message to all CAN nodes (broadcasting). Each node decides on the basis of the identifier received whether it should process the message. The identifier also determines the priority that the message enjoys in competition for bus access. Each CAN message can transmit from 0 to 8 bytes of user information.

The LM3S9B96 microcontroller includes two CAN units with the following features:

- CAN protocol version 2.0 part A/B
- Bit rates up to 1 Mbps
- 32 message objects with individual identifier masks
- Maskable interrupt
- Disable Automatic Retransmission mode for Time-Triggered CAN (TTCAN) applications
- Programmable Loopback mode for self-test operation
- Programmable FIFO mode enables storage of multiple message objects
- Gluelessly attaches to an external CAN transceiver through the `CANnTX` and `CANnRX` signals

### 1.1.4.3 USB (see page 875)

Universal Serial Bus (USB) is a serial bus standard designed to allow peripherals to be connected and disconnected using a standardized interface without rebooting the system.

The LM3S9B96 controller supports three configurations in USB 2.0 full and low speed: USB Device, USB Host, and USB On-The-Go (negotiated on-the-go as host or device when connected to other USB-enabled systems).

The USB module has the following features:

- Complies with USB-IF certification standards
- USB 2.0 full-speed (12 Mbps) and low-speed (1.5 Mbps) operation
- Integrated PHY
- 4 transfer types: Control, Interrupt, Bulk, and Isochronous
- 32 endpoints
  - 1 dedicated control IN endpoint and 1 dedicated control OUT endpoint
  - 15 configurable IN endpoints and 15 configurable OUT endpoints
- 4 KB dedicated endpoint memory: one endpoint may be defined for double-buffered 1023-byte isochronous packet size
- VBUS droop and valid ID detection and interrupt
- Efficient transfers using Micro Direct Memory Access Controller ( $\mu$ DMA)
  - Separate channels for transmit and receive for up to three IN endpoints and three OUT endpoints
  - Channel requests asserted when FIFO contains required amount of data

### 1.1.4.4 UART (see page 584)

A Universal Asynchronous Receiver/Transmitter (UART) is an integrated circuit used for RS-232C serial communications, containing a transmitter (parallel-to-serial converter) and a receiver (serial-to-parallel converter), each clocked separately.

The LM3S9B96 controller includes three fully programmable 16C550-type UARTs. Although the functionality is similar to a 16C550 UART, this UART design is not register compatible. The UART can generate individually masked interrupts from the Rx, Tx, modem status, and error conditions. The module generates a single combined interrupt when any of the interrupts are asserted and are unmasked.

The three UARTs have the following features:

- Programmable baud-rate generator allowing speeds up to 5 Mbps for regular speed (divide by 16) and 10 Mbps for high speed (divide by 8)
- Separate 16x8 transmit (TX) and receive (RX) FIFOs to reduce CPU interrupt service loading
- Programmable FIFO length, including 1-byte deep operation providing conventional double-buffered interface

- FIFO trigger levels of 1/8, 1/4, 1/2, 3/4, and 7/8
- Standard asynchronous communication bits for start, stop, and parity
- False-start bit detection
- Line-break generation and detection
- Fully programmable serial interface characteristics
  - 5, 6, 7, or 8 data bits
  - Even, odd, stick, or no-parity bit generation/detection
  - 1 or 2 stop bit generation
- IrDA serial-IR (SIR) encoder/decoder providing
  - Programmable use of IrDA Serial Infrared (SIR) or UART input/output
  - Support of IrDA SIR encoder/decoder functions for data rates up to 115.2 Kbps half-duplex
  - Support of normal 3/16 and low-power (1.41-2.23  $\mu$ s) bit durations
  - Programmable internal clock generator enabling division of reference clock by 1 to 256 for low-power mode bit duration
- Support for communication with ISO 7816 smart cards
- Full modem handshake support (on UART1)
- LIN protocol support
- Standard FIFO-level and End-of-Transmission interrupts
- Efficient transfers using Micro Direct Memory Access Controller ( $\mu$ DMA)
  - Separate channels for transmit and receive
  - Receive single request asserted when data is in the FIFO; burst request asserted at programmed FIFO level
  - Transmit single request asserted when there is space in the FIFO; burst request asserted at programmed FIFO level

#### 1.1.4.5 I<sup>2</sup>C (see page 688)

The Inter-Integrated Circuit (I<sup>2</sup>C) bus provides bi-directional data transfer through a two-wire design (a serial data line SDA and a serial clock line SCL). The I<sup>2</sup>C bus interfaces to external I<sup>2</sup>C devices such as serial memory (RAMs and ROMs), networking devices, LCDs, tone generators, and so on. The I<sup>2</sup>C bus may also be used for system testing and diagnostic purposes in product development and manufacture.

Each device on the I<sup>2</sup>C bus can be designated as either a master or a slave. Each I<sup>2</sup>C module supports both sending and receiving data as either a master or a slave and can operate simultaneously as both a master and a slave. Both the I<sup>2</sup>C master and slave can generate interrupts.

The LM3S9B96 controller includes two I<sup>2</sup>C modules with the following features:

- Devices on the I<sup>2</sup>C bus can be designated as either a master or a slave
  - Supports both transmitting and receiving data as either a master or a slave
  - Supports simultaneous master and slave operation
- Four I<sup>2</sup>C modes
  - Master transmit
  - Master receive
  - Slave transmit
  - Slave receive
- Two transmission speeds: Standard (100 Kbps) and Fast (400 Kbps)
- Master and slave interrupt generation
  - Master generates interrupts when a transmit or receive operation completes (or aborts due to an error)
  - Slave generates interrupts when data has been transferred or requested by a master or when a START or STOP condition is detected
- Master with arbitration and clock synchronization, multimaster support, and 7-bit addressing mode

#### 1.1.4.6 SSI (see page 646)

Synchronous Serial Interface (SSI) is a four-wire bi-directional communications interface that converts data between parallel and serial. The SSI module performs serial-to-parallel conversion on data received from a peripheral device, and parallel-to-serial conversion on data transmitted to a peripheral device. The SSI module can be configured as either a master or slave device. As a slave device, the SSI module can also be configured to disable its output, which allows a master device to be coupled with multiple slave devices. The TX and RX paths are buffered with separate internal FIFOs.

The SSI module also includes a programmable bit rate clock divider and prescaler to generate the output serial clock derived from the SSI module's input clock. Bit rates are generated based on the input clock and the maximum bit rate is determined by the connected peripheral.

The LM3S9B96 controller includes two SSI modules with the following features:

- Programmable interface operation for Freescale SPI, MICROWIRE, or Texas Instruments synchronous serial interfaces
- Master or slave operation
- Programmable clock bit rate and prescaler
- Separate transmit and receive FIFOs, each 16 bits wide and 8 locations deep
- Programmable data frame size from 4 to 16 bits



- Internal loopback test mode for diagnostic/debug testing
- Standard FIFO-based interrupts and End-of-Transmission interrupt
- Efficient transfers using Micro Direct Memory Access Controller ( $\mu$ DMA)
  - Separate channels for transmit and receive
  - Receive single request asserted when data is in the FIFO; burst request asserted when FIFO contains 4 entries
  - Transmit single request asserted when there is space in the FIFO; burst request asserted when FIFO contains 4 entries

#### 1.1.4.7 Inter-Integrated Circuit Sound (I<sup>2</sup>S) Interface (see page 725)

The I<sup>2</sup>S interface is a configurable serial audio core that contains a transmit module and a receive module. The module is configurable for the I<sup>2</sup>S as well as Left-Justified and Right-Justified serial audio formats. Data can be in one of four modes: Stereo, Mono, Compact 16-bit Stereo and Compact 8-Bit Stereo.

The transmit and receive modules each have an 8-entry audio-sample FIFO. An audio sample can consist of a Left and Right Stereo sample, a Mono sample, or a Left and Right Compact Stereo sample. In Compact 16-Bit Stereo, each FIFO entry contains both the 16-bit left and 16-bit right samples, allowing efficient data transfers and requiring less memory space. In Compact 8-bit Stereo, each FIFO entry contains an 8-bit left and an 8-bit right sample, reducing memory requirements further.

Both the transmitter and receiver are capable of being a master or a slave.

The Stellaris® I<sup>2</sup>S interface has the following features:

- Configurable audio format supporting I<sup>2</sup>S, Left-justification, and Right-justification
- Configurable sample size from 8 to 32 bits
- Mono and Stereo support
- 8-, 16-, and 32-bit FIFO interface for packing memory
- Independent transmit and receive 8-entry FIFOs
- Configurable FIFO-level interrupt and  $\mu$ DMA requests
- Independent transmit and receive MCLK direction control
- Transmit and receive internal MCLK sources
- Independent transmit and receive control for serial clock and word select
- MCLK and SCLK can be independently set to master or slave
- Configurable transmit zero or last sample when FIFO empty
- Efficient transfers using Micro Direct Memory Access Controller ( $\mu$ DMA)
  - Separate channels for transmit and receive

- Burst requests
- Channel requests asserted when FIFO contains required amount of data

### 1.1.5 System Integration

The LM3S9B96 controller provides a variety of standard system functions integrated into the device, including:

- Micro Direct Memory Access Controller ( $\mu$ DMA)
- System control and clocks including on-chip precision 16-MHz oscillator
- ARM Cortex SysTick Timer
- Four 32-bit timers (up to eight 16-bit)
- Eight Capture Compare PWM pins (CCP)
- Real-Time Clock
- Two Watchdog Timers
- Up to 65 GPIOs, depending on configuration
  - Highly flexible pin muxing allows use as GPIO or one of several peripheral functions
  - Independently configurable to 2, 4 or 8 mA drive capability
  - Up to 4 GPIOs can have 18 mA drive capability

The following sections provide more detail on each of these functions.

#### 1.1.5.1 Direct Memory Access (see page 246)

The LM3S9B96 microcontroller includes a Direct Memory Access (DMA) controller, known as micro-DMA ( $\mu$ DMA). The  $\mu$ DMA controller provides a way to offload data transfer tasks from the Cortex-M3 processor, allowing for more efficient use of the processor and the available bus bandwidth. The  $\mu$ DMA controller can perform transfers between memory and peripherals. It has dedicated channels for each supported on-chip module and can be programmed to automatically perform transfers between peripherals and memory as the peripheral is ready to transfer more data. The  $\mu$ DMA controller provides the following features:

- ARM PrimeCell® 32-channel configurable  $\mu$ DMA controller
- Support for memory-to-memory, memory-to-peripheral, and peripheral-to-memory in multiple transfer modes
  - Basic for simple transfer scenarios
  - Ping-pong for continuous data flow
  - Scatter-gather for a programmable list of arbitrary transfers initiated from a single request
- Highly flexible and configurable channel operation
  - Independently configured and operated channels

- Dedicated channels for supported on-chip modules: GP Timer, USB, UART, Ethernet, ADC, EPI, SSI, I<sup>2</sup>S
- Primary and secondary channel assignments
- One channel each for receive and transmit path for bidirectional modules
- Dedicated channel for software-initiated transfers
- Per-channel configurable bus arbitration scheme
- Optional software-initiated requests for any channel
- Two levels of priority
- Design optimizations for improved bus access performance between  $\mu$ DMA controller and the processor core
  - $\mu$ DMA controller access is subordinate to core access
  - RAM striping
  - Peripheral bus segmentation
- Data sizes of 8, 16, and 32 bits
- Transfer size is programmable in binary steps from 1 to 1024
- Source and destination address increment size of byte, half-word, word, or no increment
- Maskable peripheral requests
- Interrupt on transfer completion, with a separate interrupt per channel

### 1.1.5.2 System Control and Clocks (see page 101)

System control determines the overall operation of the device. It provides information about the device, controls power-saving features, controls the clocking of the device and individual peripherals, and handles reset detection and reporting.

- Device identification information: version, part number, SRAM size, Flash memory size, and so on
- Power control
  - On-chip fixed Low Drop-Out (LDO) voltage regulator
  - Low-power options for microcontroller: Sleep and Deep-sleep modes with clock gating
  - Low-power options for on-chip modules: software controls shutdown of individual peripherals and memory
  - 3.3-V supply brown-out detection and reporting via interrupt or reset
- Multiple clock sources for microcontroller system clock

- Precision Oscillator (PIOSC): on-chip resource providing a 16 MHz  $\pm$ 1% frequency at room temperature
  - 16 MHz  $\pm$ 3% across temperature
  - Software power down control for low power modes
- Main Oscillator (MOSC): a frequency-accurate clock source by one of two means: an external single-ended clock source is connected to the OSC0 input pin, or an external crystal is connected across the OSC0 input and OSC1 output pins.
  - External oscillator used with or without on-chip PLL: select supported frequencies from 1 MHz to 16.384 MHz.
  - External crystal: from DC to maximum device speed
- Internal 30-kHz Oscillator: on chip resource providing a 30 kHz  $\pm$  50% frequency, used during power-saving modes
- Flexible reset sources
  - Power-on reset (POR)
  - Reset pin assertion
  - Brown-out reset (BOR) detector alerts to system power drops
  - Software reset
  - Watchdog timer reset
  - MOSC failure

### 1.1.5.3 Four Programmable Timers (see page 433)

Programmable timers can be used to count or time external events that drive the Timer input pins. Each GPTM block provides two 16-bit timers/counters that can be configured to operate independently as timers or event counters, or configured to operate as one 32-bit timer or one 32-bit Real-Time Clock (RTC). Timers can also be used to trigger analog-to-digital (ADC) conversions.

The General-Purpose Timer Module (GPTM) contains four GPTM blocks with the following functional options:

- Count up or down
- 16- or 32-bit programmable one-shot timer
- 16- or 32-bit programmable periodic timer
- 16-bit general-purpose timer with an 8-bit prescaler
- 32-bit Real-Time Clock (RTC) when using an external 32.768-KHz clock as the input
- Eight Capture Compare PWM pins (CCP)
- Daisy chaining of timer modules to allow a single timer to initiate multiple timing events

- ADC event trigger
- User-enabled stalling when the controller asserts CPU Halt flag during debug (excluding RTC mode)
- 16-bit input-edge count- or time-capture modes
- 16-bit PWM mode with software-programmable output inversion of the PWM signal
- Ability to determine the elapsed time between the assertion of the timer interrupt and entry into the interrupt service routine.
- Efficient transfers using Micro Direct Memory Access Controller (μDMA)
  - Dedicated channel for each timer
  - Burst request generated on timer interrupt

#### 1.1.5.4 CCP Pins (see page 440)

Capture Compare PWM pins (CCP) can be used by the General-Purpose Timer Module to time/count external events using the CCP pin as an input. Alternatively, the GPTM can generate a simple PWM output on the CCP pin.

The LM3S9B96 microcontroller includes eight Capture Compare PWM pins (CCP) that can be programmed to operate in the following modes:

- Capture: The GP Timer is incremented/decremented by programmed events on the CCP input. The GP Timer captures and stores the current timer value when a programmed event occurs.
- Compare: The GP Timer is incremented/decremented by programmed events on the CCP input. The GP Timer compares the current value with a stored value and generates an interrupt when a match occurs.
- PWM: The GP Timer is incremented/decremented by the system clock. A PWM signal is generated based on a match between the counter value and a value stored in a match register and is output on the CCP pin.

#### 1.1.5.5 Watchdog Timers (see page 481)

A watchdog timer is used to regain control when a system has failed due to a software error or to the failure of an external device to respond in the expected way. The Stellaris® Watchdog Timer can generate an interrupt or a reset when a time-out value is reached. In addition, the Watchdog Timer is ARM FiRM-compliant and can be configured to generate an interrupt to the controller on its first time-out, and to generate a reset signal on its second time-out. Once the Watchdog Timer has been configured, the lock register can be written to prevent the timer configuration from being inadvertently altered.

The LM3S9B96 microcontroller has two Watchdog Timer modules: Watchdog Timer 0 uses the system clock for its timer clock; Watchdog Timer 1 uses the PIOSC as its timer clock. The Stellaris® Watchdog Timer module has the following features:

- 32-bit down counter with a programmable load register
- Separate watchdog clock with an enable

- Programmable interrupt generation logic with interrupt masking
- Lock register protection from runaway software
- Reset generation logic with an enable/disable
- User-enabled stalling when the microcontroller asserts the CPU Halt flag during debug

#### 1.1.5.6 Programmable GPIOs (see page 304)

General-purpose input/output (GPIO) pins offer flexibility for a variety of connections. The Stellaris<sup>®</sup> GPIO module is comprised of nine physical GPIO blocks, each corresponding to an individual GPIO port. The GPIO module is FIRM-compliant (compliant to the ARM Foundation IP for Real-Time Microcontrollers specification) and supports 0-65 programmable input/output pins. The number of GPIOs available depends on the peripherals being used (see “Signal Tables” on page 1129 for the signals available to each GPIO pin).

- Up to 65 GPIOs, depending on configuration
- Highly flexible pin muxing allows use as GPIO or one of several peripheral functions
- 5-V-tolerant input/outputs
- Fast toggle capable of a change every two clock cycles
- Two means of port access: either Advanced High-Performance Bus (AHB) with better back-to-back access performance, or the legacy Advanced Peripheral Bus (APB) for backwards-compatibility with existing code
- Programmable control for GPIO interrupts
  - Interrupt generation masking
  - Edge-triggered on rising, falling, or both
  - Level-sensitive on High or Low values
- Bit masking in both read and write operations through address lines
- Can be used to initiate an ADC sample sequence
- Pins configured as digital inputs are Schmitt-triggered
- Programmable control for GPIO pad configuration
  - Weak pull-up or pull-down resistors
  - 2-mA, 4-mA, and 8-mA pad drive for digital communication; up to four pads can be configured with an 18-mA pad drive for high-current applications
  - Slew rate control for the 8-mA drive
  - Open drain enables
  - Digital input enables

## 1.1.6 Advanced Motion Control

The LM3S9B96 controller provides motion control functions integrated into the device, including:

- Eight advanced PWM outputs for motion and energy applications
- Four fault input to promote low-latency shutdown
- Two Quadrature Encoder Inputs (QEI)

The following provides more detail on these motion control functions.

### 1.1.6.1 PWM (see page 1027)

Pulse width modulation (PWM) is a powerful technique for digitally encoding analog signal levels. High-resolution counters are used to generate a square wave, and the duty cycle of the square wave is modulated to encode an analog signal. Typical applications include switching power supplies and motor control. The LM3S9B96 PWM module consists of four PWM generator blocks and a control block. Each PWM generator block contains one timer (16-bit down or up/down counter), two comparators, a PWM signal generator, a dead-band generator, and an interrupt/ADC-trigger selector. Each PWM generator block produces two PWM signals that can either be independent signals or a single pair of complementary signals with dead-band delays inserted. PWM generator block has the following features:

- Four fault-condition handling input to quickly provide low-latency shutdown and prevent damage to the motor being controlled
- One 16-bit counter
  - Runs in Down or Up/Down mode
  - Output frequency controlled by a 16-bit load value
  - Load value updates can be synchronized
  - Produces output signals at zero and load value
- Two PWM comparators
  - Comparator value updates can be synchronized
  - Produces output signals on match
- PWM signal generator
  - Output PWM signal is constructed based on actions taken as a result of the counter and PWM comparator output signals
  - Produces two independent PWM signals
- Dead-band generator
  - Produces two PWM signals with programmable dead-band delays suitable for driving a half-H bridge
  - Can be bypassed, leaving input PWM signals unmodified

- Can initiate an ADC sample sequence

The control block determines the polarity of the PWM signals and which signals are passed through to the pins. The output of the PWM generation blocks are managed by the output control block before being passed to the device pins. The PWM control block has the following options:

- PWM output enable of each PWM signal
- Optional output inversion of each PWM signal (polarity control)
- Optional fault handling for each PWM signal
- Synchronization of timers in the PWM generator blocks
- Synchronization of timer/comparator updates across the PWM generator blocks
- Synchronization of PWM output enables across the PWM generator blocks
- Interrupt status summary of the PWM generator blocks
- Extended fault capabilities with multiple fault signals, programmable polarities, and filtering
- PWM generators can be operated independently or synchronized with other generators

#### 1.1.6.2 QEI (see page 1104)

A quadrature encoder, also known as a 2-channel incremental encoder, converts linear displacement into a pulse signal. By monitoring both the number of pulses and the relative phase of the two signals, the position, direction of rotation, and speed can be tracked. In addition, a third channel, or index signal, can be used to reset the position counter. The Stellaris<sup>®</sup> quadrature encoder with index (QEI) module interprets the code produced by a quadrature encoder wheel to integrate position over time and determine direction of rotation. In addition, it can capture a running estimate of the velocity of the encoder wheel. The input frequency of the QEI inputs may be as high as 1/4 of the processor frequency (for example, 20 MHz for a 80-MHz system).

The LM3S9B96 microcontroller includes two QEI modules providing control of two motors at the same time with the following features:

- Position integrator that tracks the encoder position
- Programmable noise filter on the inputs
- Velocity capture using built-in timer
- The input frequency of the QEI inputs may be as high as 1/4 of the processor frequency (for example, 12.5 MHz for a 50-MHz system)
- Interrupt generation on:
  - Index pulse
  - Velocity-timer expiration
  - Direction change
  - Quadrature error detection



## 1.1.7 Analog

The LM3S9B96 controller provides analog functions integrated into the device, including:

- Two 10-bit Analog-to-Digital Converters (ADC) with sixteen analog input channels and sample rate of one million samples/second
- Three analog comparators
- 16 digital comparators
- On-chip voltage regulator

The following provides more detail on these analog functions.

### 1.1.7.1 ADC (see page 506)

An analog-to-digital converter (ADC) is a peripheral that converts a continuous analog voltage to a discrete digital number. The Stellaris® ADC module features 10-bit conversion resolution and supports sixteen input channels plus an internal temperature sensor. Four buffered sample sequencers allow rapid sampling of up to eight analog input sources without controller intervention. Each sample sequencer provides flexible programming with fully configurable input source, trigger events, interrupt generation, and sequencer priority. A digital comparator function is included that allows the conversion value to be diverted to a comparison unit that provides 16 digital comparators.

The LM3S9B96 microcontroller provides two ADC modules with the following features:

- Sixteen analog input channels
- Single-ended and differential-input configurations
- On-chip internal temperature sensor
- Maximum sample rate of one million samples/second
- Optional phase shift in sample time programmable from 22.5° to 337.5°
- Four programmable sample conversion sequencers from one to eight entries long, with corresponding conversion result FIFOs
- Flexible trigger control
  - Controller (software)
  - Timers
  - Analog Comparators
  - PWM
  - GPIO
- Hardware averaging of up to 64 samples for improved accuracy
- Digital comparison unit providing sixteen digital comparators
- Converter uses an internal 3-V reference or an external reference

- Power and ground for the analog circuitry is separate from the digital power and ground
- Efficient transfers using Micro Direct Memory Access Controller ( $\mu$ DMA)
  - Dedicated channel for each sample sequencer
  - ADC module uses burst requests for DMA

#### 1.1.7.2 Analog Comparators (see page 1014)

An analog comparator is a peripheral that compares two analog voltages and provides a logical output that signals the comparison result. The LM3S9B96 microcontroller provides three independent integrated analog comparators that can be configured to drive an output or generate an interrupt or ADC event.

The comparator can provide its output to a device pin, acting as a replacement for an analog comparator on the board, or it can be used to signal the application via interrupts or triggers to the ADC to cause it to start capturing a sample sequence. The interrupt generation and ADC triggering logic is separate. This means, for example, that an interrupt can be generated on a rising edge and the ADC triggered on a falling edge.

The LM3S9B96 microcontroller provides three independent integrated analog comparators with the following functions:

- Compare external pin input to external pin input or to internal programmable voltage reference
- Compare a test voltage against any one of the following voltages:
  - An individual external reference voltage
  - A shared single external reference voltage
  - A shared internal reference voltage

#### 1.1.8 JTAG and ARM Serial Wire Debug (see page 89)

The Joint Test Action Group (JTAG) port is an IEEE standard that defines a Test Access Port and Boundary Scan Architecture for digital integrated circuits and provides a standardized serial interface for controlling the associated test logic. The TAP, Instruction Register (IR), and Data Registers (DR) can be used to test the interconnections of assembled printed circuit boards and obtain manufacturing information on the components. The JTAG Port also provides a means of accessing and controlling design-for-test features such as I/O pin observation and control, scan testing, and debugging. Texas Instruments replaces the ARM SW-DP and JTAG-DP with the ARM CoreSight™-compliant Serial Wire JTAG Debug Port (SWJ-DP) interface. The SWJ-DP interface combines the SWD and JTAG debug ports into one module providing all the normal JTAG debug and test functionality plus real-time access to system memory without halting the core or requiring any target resident code. See the *CoreSight™ Design Kit Technical Reference Manual* for details on SWJ-DP. The SWJ-DP interface has the following features:

- IEEE 1149.1-1990 compatible Test Access Port (TAP) controller
- Four-bit Instruction Register (IR) chain for storing JTAG instructions
- IEEE standard instructions: BYPASS, IDCODE, SAMPLE/PRELOAD, EXTEST and INTTEST
- ARM additional instructions: APACC, DPACC and ABORT

- Integrated ARM Serial Wire Debug (SWD)
  - Serial Wire JTAG Debug Port (SWJ-DP)
  - Flash Patch and Breakpoint (FPB) unit for implementing breakpoints
  - Data Watchpoint and Trigger (DWT) unit for implementing watchpoints, trigger resources, and system profiling
  - Instrumentation Trace Macrocell (ITM) for support of printf style debugging
  - Trace Port Interface Unit (TPIU) for bridging to a Trace Port Analyzer

### 1.1.9 Packaging and Temperature

- Industrial-range 100-pin RoHS-compliant LQFP package
- Industrial-range 108-ball RoHS-compliant BGA package

## 1.2 Target Applications

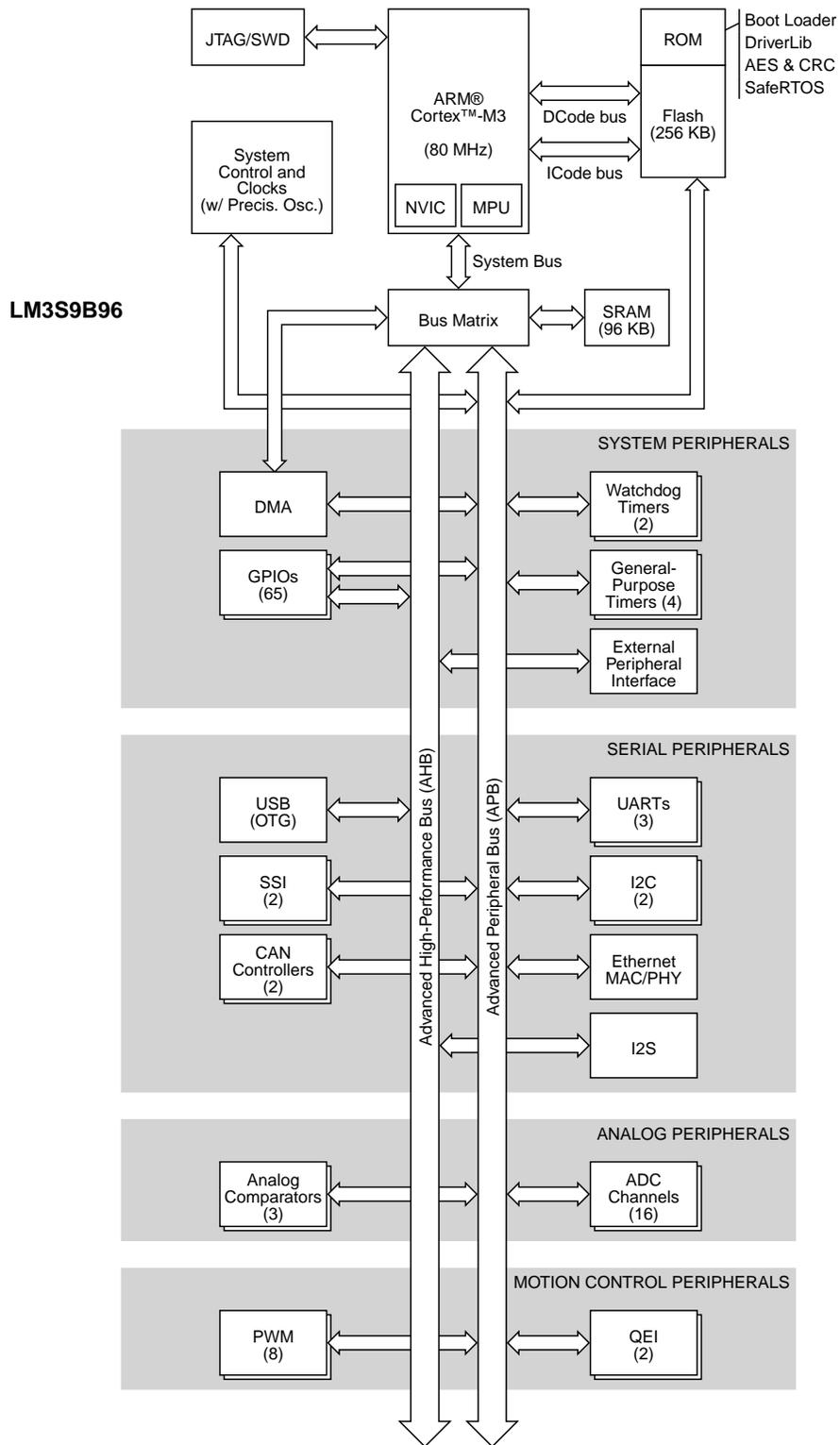
The Stellaris® family is positioned for cost-conscious applications requiring significant control processing and connectivity capabilities such as:

- Remote monitoring
- Electronic point-of-sale (POS) machines
- Test and measurement equipment
- Network appliances and switches
- Factory automation
- HVAC and building control
- Gaming equipment
- Motion control
- Medical instrumentation
- Fire and security
- Power and energy
- Transportation

## 1.3 High-Level Block Diagram

Figure 1-1 depicts the features on the Stellaris® LM3S9B96 microcontroller. Note that there are two on-chip buses that connect the core to the peripherals. The Advanced Peripheral Bus (APB) bus is the legacy bus. The Advanced High-Performance Bus (AHB) bus provides better back-to-back access performance than the APB bus.

Figure 1-1. Stellaris<sup>®</sup> LM3S9B96 Microcontroller High-Level Block Diagram



## 1.4 Additional Features

### 1.4.1 Memory Map (see page 83)

A memory map lists the location of instructions and data in memory. The memory map for the LM3S9B96 controller can be found in “Memory Map” on page 83. Register addresses are given as a hexadecimal increment, relative to the module's base address as shown in the memory map. The *ARM® Cortex™-M3 Technical Reference Manual* provides further information on the memory map.

### 1.4.2 Hardware Details

Details on the pins and package can be found in the following sections:

- “Pin Diagram” on page 1127
- “Signal Tables” on page 1129
- “Operating Characteristics” on page 1204
- “Electrical Characteristics” on page 1205
- “Package Information” on page 1278

## 2 ARM Cortex-M3 Processor Core

The ARM Cortex-M3 processor provides a high-performance, low-cost platform that meets the system requirements of minimal memory implementation, reduced pin count, and low power consumption, while delivering outstanding computational performance and exceptional system response to interrupts. Features include:

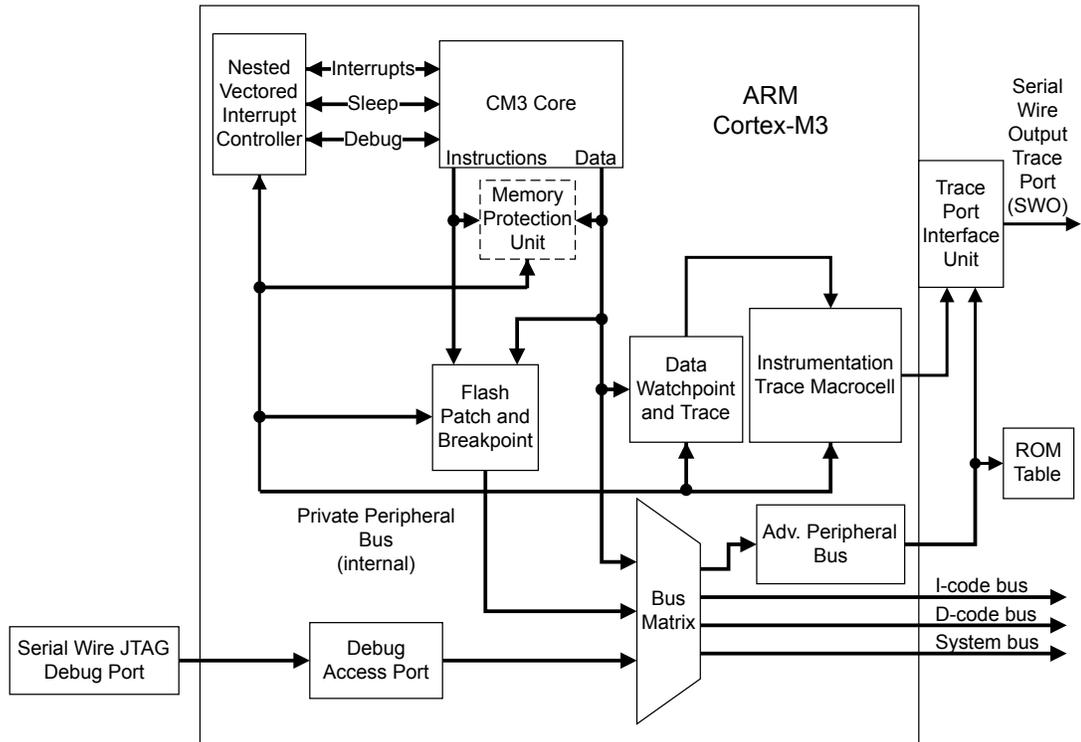
- 32-bit ARM® Cortex™-M3 v7M architecture optimized for small-footprint embedded applications
- Outstanding processing performance combined with fast interrupt handling
- Thumb-2 mixed 16-/32-bit instruction set, delivers the high performance expected of a 32-bit ARM core in a compact memory size usually associated with 8- and 16-bit devices; typically in the range of a few kilobytes of memory for microcontroller-class applications
  - Single-cycle multiply instruction and hardware divide
  - Atomic bit manipulation (bit-banding), delivering maximum memory utilization and streamlined peripheral control
  - Unaligned data access, enabling data to be efficiently packed into memory
- Fast code execution permits slower processor clock or increases sleep mode time
- Harvard architecture characterized by separate buses for instruction and data
- Efficient processor core, system and memories
- Hardware division and fast multiplier
- Deterministic, high-performance interrupt handling for time-critical applications
- Memory protection unit (MPU) to provide a privileged mode for protected operating system functionality
- Enhanced system debug with extensive breakpoint and trace capabilities
- Serial Wire Debug and Serial Wire Trace reduce the number of pins required for debugging and tracing
- Migration from the ARM7™ processor family for better performance and power efficiency
- Optimized for single-cycle Flash memory usage
- Ultra-low power consumption with integrated sleep modes
- 80-MHz operation
- 1.25 DMIPS/MHz

The Stellaris® family of microcontrollers builds on this core to bring high-performance 32-bit computing to cost-sensitive embedded microcontroller applications, such as factory automation and control, industrial control power devices, building and home automation, and stepper motors.

For more information on the ARM Cortex-M3 processor core, see the *ARM® Cortex™-M3 Technical Reference Manual*. For information on SWJ-DP, see the *ARM® CoreSight Technical Reference Manual*.

## 2.1 Block Diagram

Figure 2-1. CPU Block Diagram



## 2.2 Functional Description

**Important:** The *ARM® Cortex™-M3 Technical Reference Manual* describes all the features of an ARM Cortex-M3 in detail. However, these features differ based on the implementation. This section describes the Stellaris® implementation.

Texas Instruments implements the ARM Cortex-M3 core as shown in Figure 2-1 on page 71. The Cortex-M3 uses the entire 16-bit Thumb instruction set and the base Thumb-2 32-bit instruction set. In addition, as noted in the *ARM® Cortex™-M3 Technical Reference Manual*, several Cortex-M3 components are flexible in their implementation: SW/JTAG-DP, ETM, TPIU, the ROM table, the MPU, and the Nested Vectored Interrupt Controller (NVIC). Each of these is addressed in the sections that follow.

### 2.2.1 Programming Model

This section provides a brief overview of the programming model for the Cortex-M3 core. More detailed information can be found in the *ARM® Cortex™-M3 Technical Reference Manual*.

- Privileged access and user access - Code can execute as privileged or unprivileged. Unprivileged execution limits or excludes access to some resources. Privileged execution has access to all resources. Handler mode is always privileged. Thread mode can be privileged or unprivileged.

Thread mode is privileged out of reset, but you can change it to user or unprivileged by setting the CONTROL[0] bit using the MSR instruction. User access prevents:

- Use of some instructions such as CPS to set FAULTMASK and PRIMASK
- Access to most registers in System Control Space (SCS)

When Thread mode has been changed from privileged to user, it cannot change itself back to privileged. Only a Handler can change the privilege of Thread mode. Handler mode is always privileged.

- Register set - The processor has the following 32-bit registers:
  - 13 general-purpose registers, r0-r12
  - Stack point alias of banked registers, SP\_process and SP\_main
  - Link register, r14
  - Program counter, r15
  - One program status register, xPSR.
- Data types - The processor supports the following data types:
  - 32-bit words
  - 16-bit halfwords
  - 8-bit bytes
- Memory formats - The processor views memory as a linear collection of bytes numbered in ascending order from 0. For example, bytes 0-3 hold the first stored word and bytes 4-7 hold the second stored word. The processor accesses code and data in little-endian format, which means that the byte with the lowest address in a word is the least-significant byte of the word. The byte with the highest address in a word is the most significant. The byte at address 0 of the memory system connects to data lines 7-0.
- Instruction set - The Cortex-M3 instruction set contains both 16 and 32-bit instructions. These instructions are summarized in Table 2-1 on page 72 and Table 2-2 on page 74, respectively.

**Table 2-1. 16-Bit Cortex-M3 Instruction Set Summary**

Operation	Assembler
Add register value and C flag to register value	ADC <Rd>, <Rm>
Add immediate 3-bit value to register	ADD <Rd>, <Rn>, #<immed_3>
Add immediate 8-bit value to register	ADD <Rd>, #<immed_8>
Add low register value to low register value	ADD <Rd>, <Rn>, <Rm>
Add high register value to low or high register value	ADD <Rd>, <Rm>
Add 4* (immediate 8-bit value) with PC to register	ADD <Rd>, PC, #<immed_8> * 4
Add 4* (immediate 8-bit value) with SP to register	ADD <Rd>, SP, #<immed_8> * 4
Add 4* (immediate 7-bit value) to SP	ADD SP, #<immed_7> * 4
Bitwise AND register values	AND <Rd>, <Rm>
Arithmetic shift right by immediate number	ASR <Rd>, <Rm>, #<immed_5>



Table 2-1. 16-Bit Cortex-M3 Instruction Set Summary (continued)

Operation	Assembler
Arithmetic shift right by number in register	ASR <Rd>, <Rs>
Branch conditional	B<cond> <target address>
Branch unconditional	B <target_address>
Bit clear	BIC <Rd>, <Rm>
Software breakpoint	BKPT <immed_8>
Branch with link	BL <Rm>
Branch with link and exchange	BLX <Rm>
Branch and exchange	BX <Rm>
Compare not zero and branch	CBNZ <Rn>, <label>
Compare zero and branch	CBZ <Rn>, <label>
Compare negation of register value with another register value	CMN <Rn>, <Rm>
Compare immediate 8-bit value	CMP <Rn>, #<immed_8>
Compare registers	CMP <Rn>, <Rm>
Compare high register to low or high register	CMP <Rn>, <Rm>
Change processor state	CPS <effect>, <iflags>
Copy high or low register value to another high or low register	CPY <Rd> <Rm>
Bitwise exclusive OR register values	EOR <Rd>, <Rm>
Condition the following instruction	IT <cond>
Condition the following two instructions	IT<x> <cond>
Condition the following three instructions	IT<x><y> <cond>
Condition the following four instructions	IT<x><y><z> <cond>
Multiple sequential memory word loads	LDmia <Rn>!, <registers>
Load memory word from base register address + 5-bit immediate offset	LDR <Rd>, [<Rn>, #<immed_5> * 4]
Load memory word from base register address + register offset	LDR <Rd>, [<Rn>, <Rm>]
Load memory word from PC address + 8-bit immediate offset	LDR <Rd>, [PC, #<immed_8> * 4]
Load memory word from SP address + 8-bit immediate offset	LDR, <Rd>, [SP, #<immed_8> * 4]
Load memory byte [7:0] from register address + 5-bit immediate offset	LDRB <Rd>, [<Rn>, #<immed_5>]
Load memory byte [7:0] from register address + register offset	LDRB <Rd>, [<Rn>, <Rm>]
Load memory halfword [15:0] from register address + 5-bit immediate offset	LDRH <Rd>, [<Rn>, #<immed_5> * 2]
Load halfword [15:0] from register address + register offset	LDRH <Rd>, [<Rn>, <Rm>]
Load signed byte [7:0] from register address + register offset	LDRSB <Rd>, [<Rn>, <Rm>]
Load signed halfword [15:0] from register address + register offset	LDRSH <Rd>, [<Rn>, <Rm>]
Logical shift left by immediate number	LSL <Rd>, <Rm>, #<immed_5>
Logical shift left by number in register	LSL <Rd>, <Rs>
Logical shift right by immediate number	LSR <Rd>, <Rm>, #<immed_5>
Logical shift right by number in register	LSR <Rd>, <Rs>
Move immediate 8-bit value to register	MOV <Rd>, #<immed_8>
Move low register value to low register	MOV <Rd>, <Rn>
Move high or low register value to high or low register	MOV <Rd>, <Rm>
Multiply register values	MUL <Rd>, <Rm>
Move complement of register value to register	MVN <Rd>, <Rm>
Negate register value and store in register	NEG <Rd>, <Rm>

Table 2-1. 16-Bit Cortex-M3 Instruction Set Summary (continued)

Operation	Assembler
No operation	NOP <c>
Bitwise logical OR register values	ORR <Rd>, <Rm>
Pop registers from stack	POP <registers>
Pop registers and PC from stack	POP <registers, PC>
Push registers onto stack	PUSH <registers>
Push LR and registers onto stack	PUSH <registers, LR>
Reverse bytes in word and copy to register	REV <Rd>, <Rn>
Reverse bytes in two halfwords and copy to register	REV16 <Rd>, <Rn>
Reverse bytes in low halfword [15:0], sign-extend, and copy to register	REVSH <Rd>, <Rn>
Rotate right by amount in register	ROR <Rd>, <Rs>
Subtract register value and C flag from register value	SBC <Rd>, <Rm>
Send event	SEV <c>
Store multiple register words to sequential memory locations	STMIA <Rn>!, <registers>
Store register word to register address + 5-bit immediate offset	STR <Rd>, [<Rn>, #<immed_5> * 4]
Store register word to register address	STR <Rd>, [<Rn>, <Rm>]
Store register word to SP address + 8-bit immediate offset	STR <Rd>, [SP, #<immed_8> * 4]
Store register byte [7:0] to register address + 5-bit immediate offset	STRB <Rd>, [<Rn>, #<immed_5>]
Store register byte [7:0] to register address	STRB <Rd>, [<Rn>, <Rm>]
Store register halfword [15:0] to register address + 5-bit immediate offset	STRH <Rd>, [<Rn>, #<immed_5> * 2]
Store register halfword [15:0] to register address + register offset	STRH <Rd>, [<Rn>, <Rm>]
Subtract immediate 3-bit value from register	SUB <Rd>, <Rn>, #<immed_3>
Subtract immediate 8-bit value from register value	SUB <Rd>, #<immed_8>
Subtract register values	SUB <Rd>, <Rn>, <Rm>
Subtract 4 (immediate 7-bit value) from SP	SUB SP, #<immed_7> * 4
Operating system service call with 8-bit immediate call code	SVC <immed_8>
Extract byte [7:0] from register, move to register, and sign-extend to 32 bits	SXTB <Rd>, <Rm>
Extract halfword [15:0] from register, move to register, and sign-extend to 32 bits	SXTH <Rd>, <Rm>
Test register value for set bits by ANDing it with another register value	TST <Rn>, <Rm>
Extract byte [7:0] from register, move to register, and zero-extend to 32 bits	UXTB <Rd>, <Rm>#10
Extract halfword [15:0] from register, move to register, and zero-extend to 32 bits	UXTH <Rd>, <Rm>
Wait for event	WFE <c>
Wait for interrupt	WFI <c>

Table 2-2. 32-Bit Cortex-M3 Instruction Set Summary

Operation	Assembler
Add register value, immediate 12-bit value, and C bit	ADC{S}.W <Rd>, <Rn>, #<modify_constant(immed_12>
Add register value, shifted register value, and C bit	ADC{S}.W <Rd>, <Rn>, <Rm>{, <shift>}
Add register value and immediate 12-bit value	ADD{S}.W <Rd>, <Rn>, #<modify_constant(immed_12>
Add register value and shifted register value	ADD{S}.W <Rd>, <Rm>{, <shift>}
Add register value and immediate 12-bit value	ADDW.W <Rd>, <Rn>, #<immed_12>
Bitwise AND register value with immediate 12-bit value	AND{S}.W <Rd>, <Rn>, #<modify_constant(immed_12>

Table 2-2. 32-Bit Cortex-M3 Instruction Set Summary (continued)

Operation	Assembler
Bitwise AND register value with shifted register value	AND{S}.W <Rd>, <Rn>, Rm>{, <shift>}
Arithmetic shift right by number in register	ASR{S}.W <Rd>, <Rn>, <Rm>
Conditional branch	B{cond}.W <label>
Clear bit field	BFC.W <Rd>, #<lsb>, #<width>
Insert bit field from one register value into another	BFI.W <Rd>, <Rn>, #<lsb>, #<width>
Bitwise AND register value with complement of immediate 12-bit value	BIC{S}.W <Rd>, <Rn>, #<modify_constant(immed_12)>
Bitwise AND register value with complement of shifted register value	BIC{S}.W <Rd>, <Rn>, <Rm>{, <shift>}
Branch with link	BL <label>
Branch with link (immediate)	BL<c> <label>
Unconditional branch	B.W <label>
Clear exclusive clears the local record of the executing processor that an address has had a request for an exclusive access.	CLREX <c>
Return number of leading zeros in register value	CLZ.W <Rd>, <Rn>
Compare register value with two's complement of immediate 12-bit value	CMN.W <Rn>, #<modify_constant(immed_12)>
Compare register value with two's complement of shifted register value	CMN.W <Rn>, <Rm>{, <shift>}
Compare register value with immediate 12-bit value	CMP.W <Rn>, #<modify_constant(immed_12)>
Compare register value with shifted register value	CMP.W <Rn>, <Rm>{, <shift>}
Data memory barrier	DMB <c>
Data synchronization barrier	DSB <c>
Exclusive OR register value with immediate 12-bit value	EOR{S}.W <Rd>, <Rn>, #<modify_constant(immed_12)>
Exclusive OR register value with shifted register value	EOR{S}.W <Rd>, <Rn>, <Rm>{, <shift>}
Instruction synchronization barrier	ISB <c>
Load multiple memory registers, increment after or decrement before	LDM{IA DB}.W <Rn>{!}, <registers>
Memory word from base register address + immediate 12-bit offset	LDR.W <Rxf>, [<Rn>, #<offset_12>]
Memory word to PC from register address + immediate 12-bit offset	LDR.W PC, [<Rn>, #<offset_12>]
Memory word to PC from base register address immediate 8-bit offset, postindexed	LDR.W PC, [Rn], #<+/-<offset_8>
Memory word from base register address immediate 8-bit offset, postindexed	LDR.W <Rxf>, [<Rn>], #<+/-<offset_8>
Memory word from base register address immediate 8-bit offset, preindexed	LDR.W <Rxf>, [<Rn>, #<+/-<offset_8>!] LDRT.W <Rxf>, [<Rn>, #<offset_8>]
Memory word to PC from base register address immediate 8-bit offset, preindexed	LDR.W PC, [<Rn>, #<+/-<offset_8>!]
Memory word from register address shifted left by 0, 1, 2, or 3 places	LDR.W <Rxf>, [<Rn>, <Rm>{, LSL #<shift>}]
Memory word to PC from register address shifted left by 0, 1, 2, or 3 places	LDR.W PC, [<Rn>, <Rm>{, LSL #<shift>}]
Memory word from PC address immediate 12-bit offset	LDR.W <Rxf>, [PC, #<+/-<offset_12>]
Memory word to PC from PC address immediate 12-bit offset	LDR.W PC, [PC, #<+/-<offset_12>]
Memory byte [7:0] from base register address + immediate 12-bit offset	LDRB.W <Rxf>, [<Rn>, #<offset_12>]
Memory byte [7:0] from base register address immediate 8-bit offset, postindexed	LDRB.W <Rxf>. [<Rn>], #<+/-<offset_8>
Memory byte [7:0] from register address shifted left by 0, 1, 2, or 3 places	LDRB.W <Rxf>, [<Rn>, <Rm>{, LSL #<shift>}]
Memory byte [7:0] from base register address immediate 8-bit offset, preindexed	LDRB.W <Rxf>, [<Rn>, #<+/-<offset_8>!]
Memory byte from PC address immediate 12-bit offset	LDRB.W <Rxf>, [PC, #<+/-<offset_12>]
Memory doubleword from register address 8-bit offset 4, preindexed	LDRD.W <Rxf>, <Rxf2>, [<Rn>, #<+/-<offset_8> * 4]{!}

Table 2-2. 32-Bit Cortex-M3 Instruction Set Summary (continued)

Operation	Assembler
Memory doubleword from register address 8-bit offset 4, postindexed	LDRD.W <Rxf>, <Rxf2>, [<Rn>], #+/-<offset_8> * 4
Load register exclusive calculates an address from a base register value and an immediate offset, loads a word from memory, writes it to a register	LDREX<c> <Rt>, [<Rn>{, #<imm>}]
Load register exclusive halfword calculates an address from a base register value and an immediate offset, loads a halfword from memory, writes it to a register	LDREXH<c> <Rt>, [<Rn>{, #<imm>}]
Load register exclusive byte calculates an address from a base register value and an immediate offset, loads a byte from memory, writes it to a register	LDREXB<c> <Rt>, [<Rn>{, #<imm>}]
Memory halfword [15:0] from base register address + immediate 12-bit offset	LDRH.W <Rxf>, [<Rn>, #<offset_12>]
Memory halfword [15:0] from base register address immediate 8-bit offset, preindexed	LDRH.W <Rxf>, [<Rn>, #+/-<offset_8>!]
Memory halfword [15:0] from base register address immediate 8-bit offset, postindexed	LDRH.W <Rxf>, [<Rn>], #+/-<offset_8>
Memory halfword [15:0] from register address shifted left by 0, 1, 2, or 3 places	LDRH.W <Rxf>, [<Rn>, <Rm>{, LSL #<shift>}]
Memory halfword from PC address immediate 12-bit offset	LDRH.W <Rxf>, [PC, #+/-<offset_12>]
Memory signed byte [7:0] from base register address + immediate 12-bit offset	LDRSB.W <Rxf>, [<Rn>, #<offset_12>]
Memory signed byte [7:0] from base register address immediate 8-bit offset, postindexed	LDRSB.W <Rxf>, [<Rn>], #+/-<offset_8>
Memory signed byte [7:0] from base register address immediate 8-bit offset, preindexed	LDRSB.W <Rxf>, [<Rn>, #+/-<offset_8>!]
Memory signed byte [7:0] from register address shifted left by 0, 1, 2, or 3 places	LDRSB.W <Rxf>, [<Rn>, <Rm>{, LSL #<shift>}]
Memory signed byte from PC address immediate 12-bit offset	LDRSB.W <Rxf>, [PC, #+/-<offset_12>]
Memory signed halfword [15:0] from base register address + immediate 12-bit offset	LDRSH.W <Rxf>, [<Rn>, #<offset_12>]
Memory signed halfword [15:0] from base register address immediate 8-bit offset, postindexed	LDRSH.W <Rxf>, [<Rn>], #+/-<offset_8>
Memory signed halfword [15:0] from base register address immediate 8-bit offset, preindexed	LDRSH.W <Rxf>, [<Rn>, #+/-<offset_8>!]
Memory signed halfword [15:0] from register address shifted left by 0, 1, 2, or 3 places	LDRSH.W <Rxf>, [<Rn>, <Rm>{, LSL #<shift>}]
Memory signed halfword from PC address immediate 12-bit offset	LDRSH.W <Rxf>, [PC, #+/-<offset_12>]
Logical shift left register value by number in register	LSL{S}.W <Rd>, <Rn>, <Rm>
Logical shift right register value by number in register	LSR{S}.W <Rd>, <Rn>, <Rm>
Multiply two signed or unsigned register values and add the low 32 bits to a register value	MLA.W <Rd>, <Rn>, <Rm>, <Racc>
Multiply two signed or unsigned register values and subtract the low 32 bits from a register value	MLS.W <Rd>, <Rn>, <Rm>, <Racc>
Move immediate 12-bit value to register	MOV{S}.W <Rd>, #<modify_constant(immed_12)>
Move shifted register value to register	MOV{S}.W <Rd>, <Rm>{, <shift>}
Move immediate 16-bit value to top halfword [31:16] of register	MOV.T.W <Rd>, #<immed_16>
Move immediate 16-bit value to bottom halfword [15:0] of register and clear top halfword [31:16]	MOV.W.W <Rd>, #<immed_16>
Move to register from status	MRS<c> <Rd>, <psr>
Move to status register	MSR<c> <psr>_<fields>, <Rn>
Multiply two signed or unsigned register values	MUL.W <Rd>, <Rn>, <Rm>
No operation	NOP.W

Table 2-2. 32-Bit Cortex-M3 Instruction Set Summary (continued)

Operation	Assembler
Logical OR NOT register value with immediate 12-bit value	ORN{S}.W <Rd>, <Rn>, #<modify_constant(immed_12)>
Logical OR NOT register value with shifted register value	ORN{S}.W <Rd>, <Rn>, <Rm>{, <shift>}
Logical OR register value with immediate 12-bit value	ORR{S}.W <Rd>, <Rn>, #<modify_constant(immed_12)>
Logical OR register value with shifted register value	ORR{S}.W <Rd>, <Rn>, <Rm>{, <shift>}
Reverse bit order	RBIT.W <Rd>, <Rm>
Reverse bytes in word	REV.W <Rd>, <Rm>
Reverse bytes in each halfword	REV16.W <Rd>, <Rn>
Reverse bytes in bottom halfword and sign-extend	REVSH.W <Rd>, <Rn>
Rotate right by number in register	ROR{S}.W <Rd>, <Rn>, <Rm>
Rotate right with extend	RRX{S}.W <Rd>, <Rm>
Subtract a register value from an immediate 12-bit value	RSB{S}.W <Rd>, <Rn>, #<modify_constant(immed_12)>
Subtract a register value from a shifted register value	RSB{S}.W <Rd>, <Rn>, <Rm>{, <shift>}
Subtract immediate 12-bit value and C bit from register value	SBC{S}.W <Rd>, <Rn>, #<modify_constant(immed_12)>
Subtract shifted register value and C bit from register value	SBC{S}.W <Rd>, <Rn>, <Rm>{, <shift>}
Copy selected bits to register and sign-extend	SBFX.W <Rd>, <Rn>, #<lsb>, #<width>
Signed divide	SDIV<c> <Rd>, <Rn>, <Rm>
Send event	SEV<c>
Multiply signed words and add signed-extended value to 2-register value	SMLAL.W <RdLo>, <RdHi>, <Rn>, <Rm>
Multiply two signed register values	SMULL.W <RdLo>, <RdHi>, <Rn>, <Rm>
Signed saturate	SSAT.W <c> <Rd>, #<imm>, <Rn>{, <shift>}
Multiple register words to consecutive memory locations	STM{IA DB}.W <Rn>{!}, <registers>
Register word to register address + immediate 12-bit offset	STR.W <Rxf>, [<Rn>, #<offset_12>]
Register word to register address immediate 8-bit offset, postindexed	STR.W <Rxf>, [<Rn>], #+/-<offset_8>
Register word to register address shifted by 0, 1, 2, or 3 places	STR.W <Rxf>, [<Rn>, <Rm>{, LSL #<shift>}]
Register word to register address immediate 8-bit offset, preindexed Store, preindexed	STR.W <Rxf>, [<Rn>, #+/-<offset_8>]{!} STRT.W <Rxf>, [<Rn>, #<offset_8>]
Register byte [7:0] to register address immediate 8-bit offset, preindexed	STRB{T}.W <Rxf>, [<Rn>, #+/-<offset_8>]{!}
Register byte [7:0] to register address + immediate 12-bit offset	STRB.W <Rxf>, [<Rn>, #<offset_12>]
Register byte [7:0] to register address immediate 8-bit offset, postindexed	STRB.W <Rxf>, [<Rn>], #+/-<offset_8>
Register byte [7:0] to register address shifted by 0, 1, 2, or 3 places	STRB.W <Rxf>, [<Rn>, <Rm>{, LSL #<shift>}]
Store doubleword, preindexed	STRD.W <Rxf>, <Rxf2>, [<Rn>, #+/-<offset_8> * 4]{!}
Store doubleword, postindexed	STRD.W <Rxf>, <Rxf2>, [<Rn>, #+/-<offset_8> * 4]
Store register exclusive calculates an address from a base register value and an immediate offset, and stores a word from a register to memory if the executing processor has exclusive access to the memory addressed.	STREX <c> <Rd>, <Rt>, [<Rn>{, #<imm>}]
Store register exclusive byte derives an address from a base register value, and stores a byte from a register to memory if the executing processor has exclusive access to the memory addressed	STREXB <c> <Rd>, <Rt>, [<Rn>]
Store register exclusive halfword derives an address from a base register value, and stores a halfword from a register to memory if the executing processor has exclusive access to the memory addressed.	STREXH <c> <Rd>, <Rt>, [<Rn>]
Register halfword [15:0] to register address + immediate 12-bit offset	STRH.W <Rxf>, [<Rn>, #<offset_12>]
Register halfword [15:0] to register address shifted by 0, 1, 2, or 3 places	STRH.W <Rxf>, [<Rn>, <Rm>{, LSL #<shift>}]
Register halfword [15:0] to register address immediate 8-bit offset, preindexed	STRH{T}.W <Rxf>, [<Rn>, #+/-<offset_8>]{!}

Table 2-2. 32-Bit Cortex-M3 Instruction Set Summary (continued)

Operation	Assembler
Register halfword [15:0] to register address immediate 8-bit offset, postindexed	STRH.W <Rxf>, [<Rn>], #+/-<offset_8>
Subtract immediate 12-bit value from register value	SUB{S}.W <Rd>, <Rn>, #<modify_constant(immed_12)>
Subtract shifted register value from register value	SUB{S}.W <Rd>, <Rn>, <Rm>{, <shift>}
Subtract immediate 12-bit value from register value	SUBW.W <Rd>, <Rn>, #<immed_12>
Sign extend byte to 32 bits	SXTB.W <Rd>, <Rm>{, <rotation>}
Sign extend halfword to 32 bits	SXTH.W <Rd>, <Rm>{, <rotation>}
Table branch byte	TBB [<Rn>, <Rm>]
Table branch halfword	TBH [<Rn>, <Rm>, LSL #1]
Exclusive OR register value with immediate 12-bit value	TEQ.W <Rn>, #<modify_constant(immed_12)>
Exclusive OR register value with shifted register value	TEQ.W <Rn>, <Rm>{, <shift>}
Logical AND register value with 12-bit immediate value	TST.W <Rn>, #<modify_constant(immed_12)>
Logical AND register value with shifted register value	TST.W <Rn>, <Rm>{, <shift>}
Copy bit field from register value to register and zero-extend to 32 bits	UBFX.W <Rd>, <Rn>, #<lsb>, #<width>
Unsigned divide	UDIV<c> <Rd>, <Rn>, <Rm>
Multiply two unsigned register values and add to a 2-register value	UMLAL.W <RdLo>, <RdHi>, <Rn>, <Rm>
Multiply two unsigned register values	UMULL.W <RdLo>, <RdHi>, <Rn>, <Rm>
Unsigned saturate	USAT <c> <Rd>, #<imm>, <Rn>{, <shift>}
Copy unsigned byte to register and zero-extend to 32 bits	UXTB.W <Rd>, <Rm>{, <rotation>}
Copy unsigned halfword to register and zero-extend to 32 bits	UXTH.W <Rd>, <Rm>{, <rotation>}
Wait for event	WFE.W
Wait for interrupt	WFI.W

## 2.2.2 Serial Wire and JTAG Debug

Texas Instruments replaces the ARM SW-DP and JTAG-DP with the ARM CoreSight™-compliant Serial Wire JTAG Debug Port (SWJ-DP) interface. The SWJ-DP interface combines the SWD and JTAG debug ports into one module. See the *CoreSight™ Design Kit Technical Reference Manual* for details on SWJ-DP.

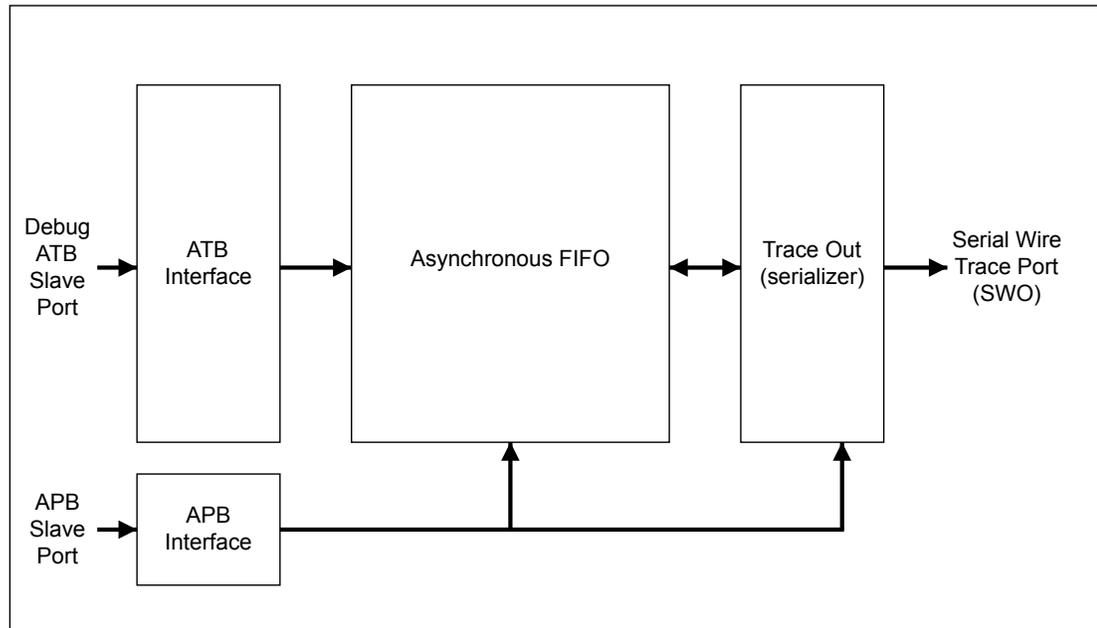
## 2.2.3 Embedded Trace Macrocell (ETM)

ETM is not implemented in the Stellaris® devices. As a result, Chapters 15 and 16 of the *ARM® Cortex™-M3 Technical Reference Manual* can be ignored.

## 2.2.4 Trace Port Interface Unit (TPIU)

The TPIU acts as a bridge between the Cortex-M3 trace data from the ITM, and an off-chip Trace Port Analyzer. Stellaris® devices implement the TPIU as shown in Figure 2-2. This implementation is similar to the non-ETM version described in the *ARM® Cortex™-M3 Technical Reference Manual*, however, SWJ-DP only provides the Serial Wire Viewer (SWV) output format for the TPIU.

Figure 2-2. TPIU Block Diagram



### 2.2.5 ROM Table

The default ROM table is implemented as described in the *ARM® Cortex™-M3 Technical Reference Manual*.

### 2.2.6 Memory Protection Unit (MPU)

The Memory Protection Unit (MPU) is included on the LM3S9B96 controller and supports the standard ARMv7 Protected Memory System Architecture (PMSA) model. The MPU provides full support for protection regions, overlapping protection regions, access permissions, and exporting memory attributes to the system.

### 2.2.7 Nested Vectored Interrupt Controller (NVIC)

The Nested Vectored Interrupt Controller (NVIC):

- Facilitates low-latency exception and interrupt handling
- Controls power management
- Implements system control registers

The NVIC and the processor core interface are closely coupled, which enables low latency interrupt processing and efficient processing of late arriving interrupts. The NVIC maintains knowledge of the stacked (nested) interrupts to enable tail-chaining of interrupts.

You can only fully access the NVIC from privileged mode, but you can pend interrupts in user-mode by enabling the Configuration Control Register (see the *ARM® Cortex™-M3 Technical Reference Manual*). Any other user-mode access causes a bus fault.

All NVIC registers are accessible using byte, halfword, and word unless otherwise stated.

### 2.2.7.1 Interrupts

The ARM® Cortex™-M3 *Technical Reference Manual* describes the maximum number of interrupts and interrupt priorities. The LM3S9B96 microcontroller supports 53 interrupts with eight priority levels.

In addition to the peripheral interrupts, the system also provides for a non-maskable interrupt (NMI). The NMI is generally used in safety critical applications where the immediate execution of an interrupt handler is required. The NMI signal is available as an external signal so that it may be generated by external circuitry. The NMI is also used internally as part of the main oscillator verification circuitry. More information on the non-maskable interrupt is located in “Non-Maskable Interrupt” on page 106.

### 2.2.8 System Timer (SysTick)

Cortex-M3 includes an integrated system timer, SysTick. SysTick provides a simple, 24-bit clear-on-write, decrementing, wrap-on-zero counter with a flexible control mechanism. The counter can be used in several different ways, for example:

- An RTOS tick timer which fires at a programmable rate (for example, 100 Hz) and invokes a SysTick routine
- A high-speed alarm timer using the system clock
- A variable rate alarm or signal timer—the duration is range-dependent on the reference clock used and the dynamic range of the counter.
- A simple counter used to measure time to completion and time used
- An internal clock source control based on missing/meeting durations. The COUNTFLAG bit-field in the control and status register can be used to determine if an action completed within a set duration, as part of a dynamic clock management control loop.

#### 2.2.8.1 Functional Description

The timer consists of three registers:

- SysTick Control and Status Register - a control and status counter to configure its clock, enable the counter, enable the SysTick interrupt, and determine counter status
- SysTick Reload Value Register - the reload value for the counter, used to provide the counter's wrap value
- SysTick Current Value Register - the current value of the counter

A fourth register, the SysTick Calibration Value Register, is not implemented in the Stellaris® devices.

When enabled, the timer counts down on each clock from the reload value to zero, reloads (wraps) to the value in the SysTick Reload Value register on the next clock edge, then decrements on subsequent clocks. Clearing the SysTick Reload Value register disables the counter on the next wrap. When the counter reaches zero, the COUNTFLAG status bit is set. The COUNTFLAG bit clears on reads.

Writing to the SysTick Current Value register clears the register and the COUNTFLAG status bit. The write does not trigger the SysTick exception logic. On a read, the current value is the value of the register at the time the register is accessed.



If the core is in debug state (halted), the counter does not decrement. The timer is clocked with respect to a reference clock, which can be either the core clock or an external clock source.

### 2.2.8.2 SysTick Control and Status Register

Use the SysTick Control and Status Register to enable the SysTick features. The reset is 0x0000.0000.

Bit/Field	Name	Type	Reset	Description
31:17	reserved	RO	0x000	Software should not rely on the value of a reserved bit. To provide compatibility with future products, the value of a reserved bit should be preserved across a read-modify-write operation.
16	COUNTFLAG	R/W	0	Count Flag When set, this bit indicates that the timer has counted to 0 since the last time this register was read. This bit is cleared by a read of the register. If read by the debugger using the DAP, this bit is cleared only if the MasterType bit in the AHB-AP Control Register is clear. Otherwise, the COUNTFLAG bit is not changed by the debugger read.
15:3	reserved	RO	0x000	Software should not rely on the value of a reserved bit. To provide compatibility with future products, the value of a reserved bit should be preserved across a read-modify-write operation.
2	CLKSOURCE	R/W	0	Clock Source  Value Description 0 External reference clock. (Not implemented for Stellaris® microcontrollers.) 1 Core clock  Because an external reference clock is not supported, this bit must be set in order for SysTick to operate.
1	TICKINT	R/W	0	Tick Interrupt When set, this bit causes an interrupt to be generated to the NVIC when SysTick counts to 0. When clear, interrupt generation is disabled. Software can use the COUNTFLAG to determine if the counter has ever reached 0.
0	ENABLE	R/W	0	Enable When set, this bit enables SysTick to operate in a multi-shot way. That is, the counter loads the Reload value and begins counting down. On reaching 0, the COUNTFLAG bit is set and an interrupt is generated if enabled by TICKINT. The counter then loads the Reload value again and begins counting. When this bit is clear, the counter is disabled.

### 2.2.8.3 SysTick Reload Value Register

The SysTick Reload Value Register specifies the start value to load into the SysTick Current Value Register when the counter reaches 0. The start value can be between 1 and 0x00FF.FFFF. A start value of 0 is possible but has no effect because the SysTick interrupt and COUNTFLAG are activated when counting from 1 to 0.

SysTick can be configured as a multi-shot timer, repeated over and over, firing every N+1 clock pulses, where N is any value from 1 to 0x00FF.FFFF. For example, if a tick interrupt is required every 100 clock pulses, 99 must be written into the RELOAD field.

When configuring SysTick as a single-shot timer, a new value is written on each tick interrupt, and the actual count down value must be written. For example, if a tick is next required after 400 clock pulses, 400 must be written into the RELOAD field.

Bit/Field	Name	Type	Reset	Description
31:24	reserved	RO	0x00	Software should not rely on the value of a reserved bit. To provide compatibility with future products, the value of a reserved bit should be preserved across a read-modify-write operation.
23:0	RELOAD	R/W	-	Reload Value Value to load into the SysTick Current Value Register when the counter reaches 0.

#### 2.2.8.4 SysTick Current Value Register

The SysTick Current Value Register contains the current value of the counter.

Bit/Field	Name	Type	Reset	Description
31:24	reserved	RO	0x00	Software should not rely on the value of a reserved bit. To provide compatibility with future products, the value of a reserved bit should be preserved across a read-modify-write operation.
23:0	CURRENT	W1C	-	Current Value This field contains the current value at the time the register is accessed. No read-modify-write protection is provided, so change with care. This register is write-clear. Writing to it with any value clears the register to 0. Clearing this register also clears the COUNTFLAG bit of the SysTick Control and Status Register.

#### 2.2.8.5 SysTick Calibration Value Register

The SysTick Calibration Value register is not implemented.

### 3 Memory Map

The memory map for the LM3S9B96 controller is provided in Table 3-1.

In this manual, register addresses are given as a hexadecimal increment, relative to the module's base address as shown in the memory map. See also Chapter 4, "Memory Map" in the *ARM® Cortex™-M3 Technical Reference Manual*.

Note that within the memory map, all reserved space returns a bus fault when read or written.

**Table 3-1. Memory Map**

Start	End	Description	For details, see page ...
<b>Memory</b>			
0x0000.0000	0x0003.FFFF	On-chip Flash	212
0x0004.0000	0x00FF.FFFF	Reserved	-
0x0100.0000	0x1FFF.FFFF	Reserved for ROM	210
0x2000.0000	0x2001.7FFF	Bit-banded on-chip SRAM	210
0x2001.8000	0x21FF.FFFF	Reserved	-
0x2200.0000	0x222F.FFFF	Bit-band alias of 0x2000.0000 through 0x200F.FFFF	210
0x2230.0000	0x3FFF.FFFF	Reserved	-
<b>FIRM Peripherals</b>			
0x4000.0000	0x4000.0FFF	Watchdog timer 0	484
0x4000.1000	0x4000.1FFF	Watchdog timer 1	484
0x4000.2000	0x4000.3FFF	Reserved	-
0x4000.4000	0x4000.4FFF	GPIO Port A	317
0x4000.5000	0x4000.5FFF	GPIO Port B	317
0x4000.6000	0x4000.6FFF	GPIO Port C	317
0x4000.7000	0x4000.7FFF	GPIO Port D	317
0x4000.8000	0x4000.8FFF	SSI0	660
0x4000.9000	0x4000.9FFF	SSI1	660
0x4000.A000	0x4000.BFFF	Reserved	-
0x4000.C000	0x4000.CFFF	UART0	597
0x4000.D000	0x4000.DFFF	UART1	597
0x4000.E000	0x4000.EFFF	UART2	597
0x4000.F000	0x4001.FFFF	Reserved	-
<b>Peripherals</b>			
0x4002.0000	0x4002.07FF	I <sup>2</sup> C Master 0	703
0x4002.0800	0x4002.0FFF	I <sup>2</sup> C Slave 0	716
0x4002.1000	0x4002.17FF	I <sup>2</sup> C Master 1	703
0x4002.1800	0x4002.1FFF	I <sup>2</sup> C Slave 1	716
0x4002.2000	0x4002.3FFF	Reserved	-
0x4002.4000	0x4002.4FFF	GPIO Port E	317
0x4002.5000	0x4002.5FFF	GPIO Port F	317
0x4002.6000	0x4002.6FFF	GPIO Port G	317
0x4002.7000	0x4002.7FFF	GPIO Port H	317

Table 3-1. Memory Map (continued)

Start	End	Description	For details, see page ...
0x4002.8000	0x4002.8FFF	PWM	1041
0x4002.9000	0x4002.BFFF	Reserved	-
0x4002.C000	0x4002.CFFF	QE10	1110
0x4002.D000	0x4002.DFFF	QE11	1110
0x4002.E000	0x4002.FFFF	Reserved	-
0x4003.0000	0x4003.0FFF	Timer 0	449
0x4003.1000	0x4003.1FFF	Timer 1	449
0x4003.2000	0x4003.2FFF	Timer 2	449
0x4003.3000	0x4003.3FFF	Timer 3	449
0x4003.4000	0x4003.7FFF	Reserved	-
0x4003.8000	0x4003.8FFF	ADC0	526
0x4003.9000	0x4003.9FFF	ADC1	526
0x4003.A000	0x4003.BFFF	Reserved	-
0x4003.C000	0x4003.CFFF	Analog Comparators	1014
0x4003.D000	0x4003.DFFF	GPIO Port J	317
0x4003.E000	0x4003.FFFF	Reserved	-
0x4004.0000	0x4004.0FFF	CAN0 Controller	782
0x4004.1000	0x4004.1FFF	CAN1 Controller	782
0x4004.2000	0x4004.7FFF	Reserved	-
0x4004.8000	0x4004.8FFF	Ethernet Controller	828
0x4004.9000	0x4004.FFFF	Reserved	-
0x4005.0000	0x4005.0FFF	USB	902
0x4005.1000	0x4005.3FFF	Reserved	-
0x4005.4000	0x4005.4FFF	I <sup>2</sup> S0	737
0x4005.5000	0x4005.7FFF	Reserved	-
0x4005.8000	0x4005.8FFF	GPIO Port A (AHB aperture)	317
0x4005.9000	0x4005.9FFF	GPIO Port B (AHB aperture)	317
0x4005.A000	0x4005.AFFF	GPIO Port C (AHB aperture)	317
0x4005.B000	0x4005.BFFF	GPIO Port D (AHB aperture)	317
0x4005.C000	0x4005.CFFF	GPIO Port E (AHB aperture)	317
0x4005.D000	0x4005.DFFF	GPIO Port F (AHB aperture)	317
0x4005.E000	0x4005.EFFF	GPIO Port G (AHB aperture)	317
0x4005.F000	0x4005.FFFF	GPIO Port H (AHB aperture)	317
0x4006.0000	0x4006.0FFF	GPIO Port J (AHB aperture)	317
0x4006.1000	0x400C.FFFF	Reserved	-
0x400D.0000	0x400D.0FFF	EPI0	389
0x400D.1000	0x400F.CFFF	Reserved	-
0x400F.D000	0x400F.DFFF	Flash memory control	217
0x400F.E000	0x400F.EFFF	System control	117
0x400F.F000	0x400F.FFFF	μDMA	267
0x4010.0000	0x41FF.FFFF	Reserved	-

Table 3-1. Memory Map (continued)

Start	End	Description	For details, see page ...
0x4200.0000	0x43FF.FFFF	Bit-banded alias of 0x4000.0000 through 0x400F.FFFF	-
0x4400.0000	0x5FFF.FFFF	Reserved	-
0x6000.0000	0xDFFF.FFFF	EPI0 mapped peripheral and RAM	-
<b>Private Peripheral Bus</b>			
0xE000.0000	0xE000.0FFF	Instrumentation Trace Macrocell (ITM)	ARM® Cortex™-M3 Technical Reference Manual
0xE000.1000	0xE000.1FFF	Data Watchpoint and Trace (DWT)	ARM® Cortex™-M3 Technical Reference Manual
0xE000.2000	0xE000.2FFF	Flash Patch and Breakpoint (FPB)	ARM® Cortex™-M3 Technical Reference Manual
0xE000.3000	0xE000.DFFF	Reserved	-
0xE000.E000	0xE000.EFFF	Nested Vectored Interrupt Controller (NVIC)	ARM® Cortex™-M3 Technical Reference Manual
0xE000.F000	0xE003.FFFF	Reserved	-
0xE004.0000	0xE004.0FFF	Trace Port Interface Unit (TPIU)	ARM® Cortex™-M3 Technical Reference Manual
0xE004.1000	0xFFFF.FFFF	Reserved	-

## 4 Interrupts

The ARM Cortex-M3 processor and the Nested Vectored Interrupt Controller (NVIC) prioritize and handle all exceptions in Handler Mode. The processor state is automatically stored to the stack on an exception and automatically restored from the stack at the end of the Interrupt Service Routine (ISR). The vector is fetched in parallel to the state saving, enabling efficient interrupt entry. The processor supports tail-chaining, which enables back-to-back interrupts to be performed without the overhead of state saving and restoration.

Table 4-1 on page 86 lists all exception types. Software can set eight priority levels on seven of these exceptions (system handlers) as well as on 53 interrupts (listed in Table 4-2 on page 87).

Priorities on the system handlers are set with the NVIC System Handler Priority registers. Interrupts are enabled through the NVIC Interrupt Set Enable register and prioritized with the NVIC Interrupt Priority registers. Priorities can be grouped by splitting priority levels into pre-emption priorities and subpriorities. All of the interrupt registers are described in Chapter 8, “Nested Vectored Interrupt Controller” in the *ARM® Cortex™-M3 Technical Reference Manual*.

Internally, the highest user-programmable priority (0) is treated as fourth priority, after a Reset, Non-Maskable Interrupt (NMI), and a Hard Fault, in that order. Note that 0 is the default priority for all the programmable priorities.

If you assign the same priority level to two or more interrupts, their hardware priority (the lower position number) determines the order in which the processor activates them. For example, if both GPIO Port A and GPIO Port B are priority level 1, then GPIO Port A has higher priority.

---

**Important:** It may take several processor cycles after a write to clear an interrupt source for the NVIC to see the interrupt source de-assert. Thus if the interrupt clear is done as the last action in an interrupt handler, it is possible for the interrupt handler to complete while the NVIC sees the interrupt as still asserted, causing the interrupt handler to be re-entered errantly. This situation can be avoided by either clearing the interrupt source at the beginning of the interrupt handler or by performing a read or write after the write to clear the interrupt source (and flush the write buffer).

---

See Chapter 5, “Exceptions” and Chapter 8, “Nested Vectored Interrupt Controller” in the *ARM® Cortex™-M3 Technical Reference Manual* for more information on exceptions and interrupts.

**Table 4-1. Exception Types**

Exception Type	Vector Number	Priority <sup>a</sup>	Description
-	0	-	Stack top is loaded from the first entry of the vector table on reset.
Reset	1	-3 (highest)	This exception is invoked on power up and warm reset. On the first instruction, Reset drops to the lowest priority (and then is called the base level of activation). This exception is asynchronous.
Non-Maskable Interrupt (NMI)	2	-2	This exception is caused by the assertion of the NMI signal or by using the NVIC Interrupt Control State register and cannot be stopped or preempted by any exception but Reset. This exception is asynchronous.
Hard Fault	3	-1	This exception is caused by all classes of Fault, when the fault cannot activate due to priority or the configurable fault handler has been disabled. This exception is synchronous.
Memory Management	4	programmable	This exception is caused by an MPU mismatch, including access violation and no match. This exception is synchronous.

**Table 4-1. Exception Types (continued)**

Exception Type	Vector Number	Priority <sup>a</sup>	Description
Bus Fault	5	programmable	This exception is caused by a pre-fetch fault, memory access fault, and other address/memory related faults. This exception is synchronous when precise and asynchronous when imprecise.  This fault can be enabled or disabled.
Usage Fault	6	programmable	This exception is caused by a usage fault, such as undefined instruction executed or illegal state transition attempt. This exception is synchronous.
-	7-10	-	Reserved.
SVCall	11	programmable	This exception is caused by a system service call with an SVC instruction. This exception is synchronous.
Debug Monitor	12	programmable	This exception is caused by the debug monitor (when not halting). This exception is synchronous, but only active when enabled. This exception does not activate if it is a lower priority than the current activation.
-	13	-	Reserved.
PendSV	14	programmable	This exception is caused by a penable request for system service. This exception is asynchronous and only pended by software.
SysTick	15	programmable	This exception is caused by the SysTick timer reaching 0, when it is enabled to generate an interrupt. This exception is asynchronous.
Interrupts	16 and above	programmable	This exception is caused by interrupts asserted from outside the ARM Cortex-M3 core and fed through the NVIC (prioritized). These exceptions are all asynchronous. Table 4-2 on page 87 lists the interrupts on the LM3S9B96 controller.

a. 0 is the default priority for all the programmable priorities.

**Table 4-2. Interrupts**

Vector Number	Interrupt Number (Bit in Interrupt Registers)	Description
0-15	-	Processor exceptions
16	0	GPIO Port A
17	1	GPIO Port B
18	2	GPIO Port C
19	3	GPIO Port D
20	4	GPIO Port E
21	5	UART0
22	6	UART1
23	7	SSI0
24	8	I <sup>2</sup> C0
25	9	PWM Fault
26	10	PWM Generator 0
27	11	PWM Generator 1
28	12	PWM Generator 2
29	13	QEI0
30	14	ADC0 Sequence 0
31	15	ADC0 Sequence 1
32	16	ADC0 Sequence 2

**Table 4-2. Interrupts (continued)**

Vector Number	Interrupt Number (Bit in Interrupt Registers)	Description
33	17	ADC0 Sequence 3
34	18	Watchdog Timers 0 and 1
35	19	Timer 0A
36	20	Timer 0B
37	21	Timer 1A
38	22	Timer 1B
39	23	Timer 2A
40	24	Timer 2B
41	25	Analog Comparator 0
42	26	Analog Comparator 1
43	27	Analog Comparator 2
44	28	System Control
45	29	Flash Memory Control
46	30	GPIO Port F
47	31	GPIO Port G
48	32	GPIO Port H
49	33	UART2
50	34	SSI1
51	35	Timer 3A
52	36	Timer 3B
53	37	I <sup>2</sup> C1
54	38	QE11
55	39	CAN0
56	40	CAN1
57	41	Reserved
58	42	Ethernet Controller
59	43	Reserved
60	44	USB
61	45	PWM Generator 3
62	46	μDMA Software
63	47	μDMA Error
64	48	ADC1 Sequence 0
65	49	ADC1 Sequence 1
66	50	ADC1 Sequence 2
67	51	ADC1 Sequence 3
68	52	I <sup>2</sup> S0
69	53	EPI
70	54	GPIO Port J
71	55	Reserved



## 5 JTAG Interface

The Joint Test Action Group (JTAG) port is an IEEE standard that defines a Test Access Port and Boundary Scan Architecture for digital integrated circuits and provides a standardized serial interface for controlling the associated test logic. The TAP, Instruction Register (IR), and Data Registers (DR) can be used to test the interconnections of assembled printed circuit boards and obtain manufacturing information on the components. The JTAG Port also provides a means of accessing and controlling design-for-test features such as I/O pin observation and control, scan testing, and debugging.

The JTAG port is comprised of four pins: TCK, TMS, TDI, and TDO. Data is transmitted serially into the controller on TDI and out of the controller on TDO. The interpretation of this data is dependent on the current state of the TAP controller. For detailed information on the operation of the JTAG port and TAP controller, please refer to the *IEEE Standard 1149.1-Test Access Port and Boundary-Scan Architecture*.

The Stellaris® JTAG controller works with the ARM JTAG controller built into the Cortex-M3 core by multiplexing the TDO outputs from both JTAG controllers. ARM JTAG instructions select the ARM TDO output while Stellaris® JTAG instructions select the Stellaris® TDO output. The multiplexer is controlled by the Stellaris® JTAG controller, which has comprehensive programming for the ARM, Stellaris®, and unimplemented JTAG instructions.

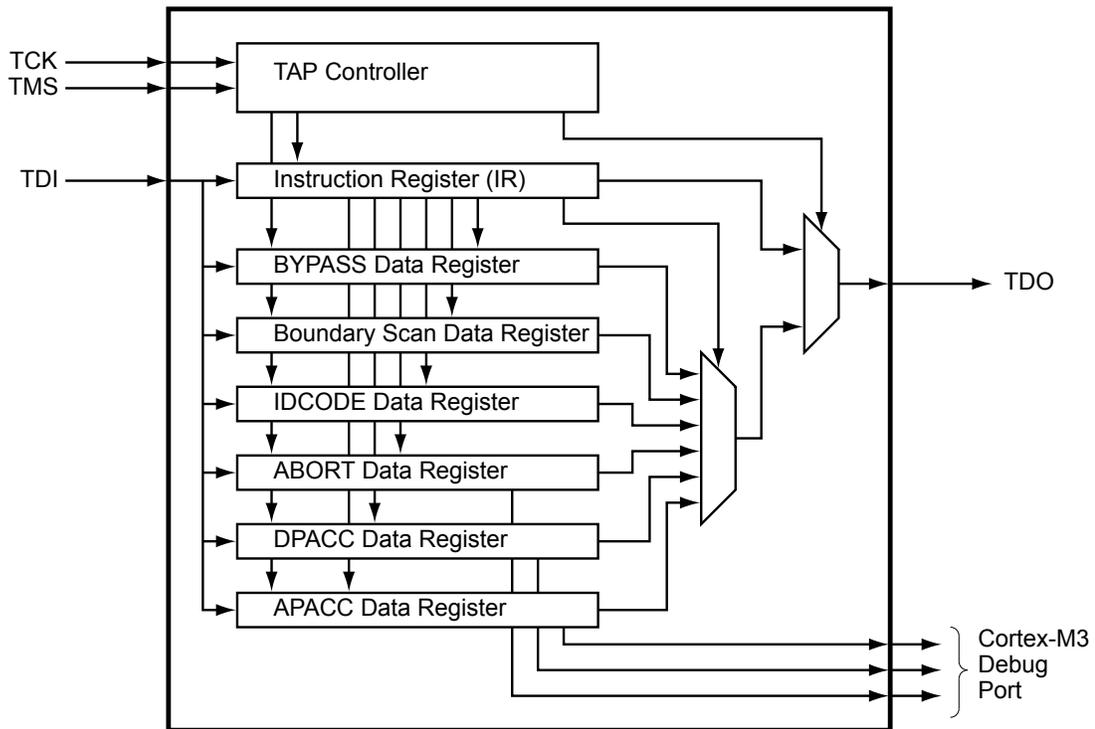
The Stellaris® JTAG module has the following features:

- IEEE 1149.1-1990 compatible Test Access Port (TAP) controller
- Four-bit Instruction Register (IR) chain for storing JTAG instructions
- IEEE standard instructions: BYPASS, IDCODE, SAMPLE/PRELOAD, EXTEST and INTTEST
- ARM additional instructions: APACC, DPACC and ABORT
- Integrated ARM Serial Wire Debug (SWD)
  - Serial Wire JTAG Debug Port (SWJ-DP)
  - Flash Patch and Breakpoint (FPB) unit for implementing breakpoints
  - Data Watchpoint and Trigger (DWT) unit for implementing watchpoints, trigger resources, and system profiling
  - Instrumentation Trace Macrocell (ITM) for support of printf style debugging
  - Trace Port Interface Unit (TPIU) for bridging to a Trace Port Analyzer

See the *ARM® Cortex™-M3 Technical Reference Manual* for more information on the ARM JTAG controller.

## 5.1 Block Diagram

Figure 5-1. JTAG Module Block Diagram



## 5.2 Signal Description

Table 5-1 on page 90 and Table 5-2 on page 91 list the external signals of the JTAG/SWD controller and describe the function of each. The JTAG/SWD controller signals are alternate functions for some GPIO signals, however note that the reset state of the pins is for the JTAG/SWD function. The JTAG/SWD controller signals are under commit protection and require a special process to be configured as GPIOs, see “Commit Control” on page 312. The column in the table below titled “Pin Mux/Pin Assignment” lists the GPIO pin placement for the JTAG/SWD controller signals. The `AFSEL` bit in the **GPIO Alternate Function Select (GPIOAFSEL)** register (page 328) is set to choose the JTAG/SWD function. The number in parentheses is the encoding that must be programmed into the `PMCn` field in the **GPIO Port Control (GPIOCTL)** register (page 346) to assign the JTAG/SWD controller signals to the specified GPIO port pin. For more information on configuring GPIOs, see “General-Purpose Input/Outputs (GPIOs)” on page 304.

Table 5-1. Signals for JTAG\_SWD\_SWO (100LQFP)

Pin Name	Pin Number	Pin Mux / Pin Assignment	Pin Type	Buffer Type <sup>a</sup>	Description
SWCLK	80	PC0 (3)	I	TTL	JTAG/SWD CLK.
SWDIO	79	PC1 (3)	I/O	TTL	JTAG TMS and SWDIO.
SWO	77	PC3 (3)	O	TTL	JTAG TDO and SWO.
TCK	80	PC0 (3)	I	TTL	JTAG/SWD CLK.
TDI	78	PC2 (3)	I	TTL	JTAG TDI.
TDO	77	PC3 (3)	O	TTL	JTAG TDO and SWO.

**Table 5-1. Signals for JTAG\_SWD\_SWO (100LQFP) (continued)**

Pin Name	Pin Number	Pin Mux / Pin Assignment	Pin Type	Buffer Type <sup>a</sup>	Description
TMS	79	PC1 (3)	I	TTL	JTAG TMS and SWDIO.

a. The TTL designation indicates the pin has TTL-compatible voltage levels.

**Table 5-2. Signals for JTAG\_SWD\_SWO (108BGA)**

Pin Name	Pin Number	Pin Mux / Pin Assignment	Pin Type	Buffer Type <sup>a</sup>	Description
SWCLK	A9	PC0 (3)	I	TTL	JTAG/SWD CLK.
SWDIO	B9	PC1 (3)	I/O	TTL	JTAG TMS and SWDIO.
SWO	A10	PC3 (3)	O	TTL	JTAG TDO and SWO.
TCK	A9	PC0 (3)	I	TTL	JTAG/SWD CLK.
TDI	B8	PC2 (3)	I	TTL	JTAG TDI.
TDO	A10	PC3 (3)	O	TTL	JTAG TDO and SWO.
TMS	B9	PC1 (3)	I	TTL	JTAG TMS and SWDIO.

a. The TTL designation indicates the pin has TTL-compatible voltage levels.

## 5.3 Functional Description

A high-level conceptual drawing of the JTAG module is shown in Figure 5-1 on page 90. The JTAG module is composed of the Test Access Port (TAP) controller and serial shift chains with parallel update registers. The TAP controller is a simple state machine controlled by the TCK and TMS inputs. The current state of the TAP controller depends on the sequence of values captured on TMS at the rising edge of TCK. The TAP controller determines when the serial shift chains capture new data, shift data from TDI towards TDO, and update the parallel load registers. The current state of the TAP controller also determines whether the Instruction Register (IR) chain or one of the Data Register (DR) chains is being accessed.

The serial shift chains with parallel load registers are comprised of a single Instruction Register (IR) chain and multiple Data Register (DR) chains. The current instruction loaded in the parallel load register determines which DR chain is captured, shifted, or updated during the sequencing of the TAP controller.

Some instructions, like EXTEST and INTEST, operate on data currently in a DR chain and do not capture, shift, or update any of the chains. Instructions that are not implemented decode to the BYPASS instruction to ensure that the serial path between TDI and TDO is always connected (see Table 5-4 on page 97 for a list of implemented instructions).

See “JTAG and Boundary Scan” on page 1210 for JTAG timing diagrams.

**Note:** Of all the possible reset sources, only Power-On reset (POR) and the assertion of the  $\overline{\text{RST}}$  input have any effect on the JTAG module. The pin configurations are reset by both the  $\overline{\text{RST}}$  input and POR, whereas the internal JTAG logic is only reset with POR. See “Reset Sources” on page 102 for more information on reset.

### 5.3.1 JTAG Interface Pins

The JTAG interface consists of four standard pins: TCK, TMS, TDI, and TDO. These pins and their associated state after a power-on reset or reset caused by the  $\overline{\text{RST}}$  input are given in Table 5-3. Detailed information on each pin follows. Refer to “General-Purpose Input/Outputs (GPIOs)” on page 304 for information on how to reprogram the configuration of these pins.

**Table 5-3. JTAG Port Pins State after Power-On Reset or  $\overline{\text{RST}}$  assertion**

Pin Name	Data Direction	Internal Pull-Up	Internal Pull-Down	Drive Strength	Drive Value
TCK	Input	Enabled	Disabled	N/A	N/A
TMS	Input	Enabled	Disabled	N/A	N/A
TDI	Input	Enabled	Disabled	N/A	N/A
TDO	Output	Enabled	Disabled	2-mA driver	High-Z

### 5.3.1.1 Test Clock Input (TCK)

The TCK pin is the clock for the JTAG module. This clock is provided so the test logic can operate independently of any other system clocks and to ensure that multiple JTAG TAP controllers that are daisy-chained together can synchronously communicate serial test data between components. During normal operation, TCK is driven by a free-running clock with a nominal 50% duty cycle. When necessary, TCK can be stopped at 0 or 1 for extended periods of time. While TCK is stopped at 0 or 1, the state of the TAP controller does not change and data in the JTAG Instruction and Data Registers is not lost.

By default, the internal pull-up resistor on the TCK pin is enabled after reset, assuring that no clocking occurs if the pin is not driven from an external source. The internal pull-up and pull-down resistors can be turned off to save internal power as long as the TCK pin is constantly being driven by an external source (see page 334 and page 336).

### 5.3.1.2 Test Mode Select (TMS)

The TMS pin selects the next state of the JTAG TAP controller. TMS is sampled on the rising edge of TCK. Depending on the current TAP state and the sampled value of TMS, the next state may be entered. Because the TMS pin is sampled on the rising edge of TCK, the *IEEE Standard 1149.1* expects the value on TMS to change on the falling edge of TCK.

Holding TMS high for five consecutive TCK cycles drives the TAP controller state machine to the Test-Logic-Reset state. When the TAP controller enters the Test-Logic-Reset state, the JTAG module and associated registers are reset to their default values. This procedure should be performed to initialize the JTAG controller. The JTAG Test Access Port state machine can be seen in its entirety in Figure 5-2 on page 93.

By default, the internal pull-up resistor on the TMS pin is enabled after reset. Changes to the pull-up resistor settings on GPIO Port C should ensure that the internal pull-up resistor remains enabled on PC1/TMS; otherwise JTAG communication could be lost (see page 334).

### 5.3.1.3 Test Data Input (TDI)

The TDI pin provides a stream of serial information to the IR chain and the DR chains. TDI is sampled on the rising edge of TCK and, depending on the current TAP state and the current instruction, may present this data to the proper shift register chain. Because the TDI pin is sampled on the rising edge of TCK, the *IEEE Standard 1149.1* expects the value on TDI to change on the falling edge of TCK.

By default, the internal pull-up resistor on the TDI pin is enabled after reset. Changes to the pull-up resistor settings on GPIO Port C should ensure that the internal pull-up resistor remains enabled on PC2/TDI; otherwise JTAG communication could be lost (see page 334).

### 5.3.1.4 Test Data Output (TDO)

The TDO pin provides an output stream of serial information from the IR chain or the DR chains. The value of TDO depends on the current TAP state, the current instruction, and the data in the

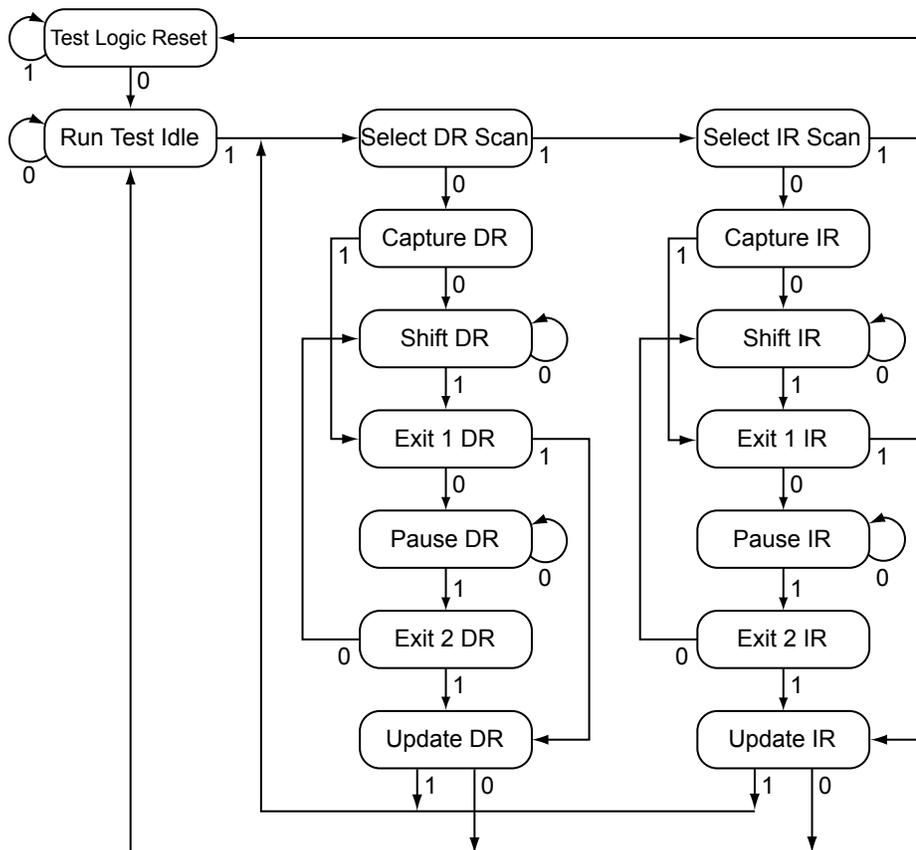
chain being accessed. In order to save power when the JTAG port is not being used, the TDO pin is placed in an inactive drive state when not actively shifting out data. Because TDO can be connected to the TDI of another controller in a daisy-chain configuration, the *IEEE Standard 1149.1* expects the value on TDO to change on the falling edge of TCK.

By default, the internal pull-up resistor on the TDO pin is enabled after reset, assuring that the pin remains at a constant logic level when the JTAG port is not being used. The internal pull-up and pull-down resistors can be turned off to save internal power if a High-Z output value is acceptable during certain TAP controller states (see page 334 and page 336).

### 5.3.2 JTAG TAP Controller

The JTAG TAP controller state machine is shown in Figure 5-2. The TAP controller state machine is reset to the Test-Logic-Reset state on the assertion of a Power-On-Reset (POR). In order to reset the JTAG module after the microcontroller has been powered on, the TMS input must be held HIGH for five TCK clock cycles, resetting the TAP controller and all associated JTAG chains. Asserting the correct sequence on the TMS pin allows the JTAG module to shift in new instructions, shift in data, or idle during extended testing sequences. For detailed information on the function of the TAP controller and the operations that occur in each state, please refer to *IEEE Standard 1149.1*.

**Figure 5-2. Test Access Port State Machine**



### 5.3.3 Shift Registers

The Shift Registers consist of a serial shift register chain and a parallel load register. The serial shift register chain samples specific information during the TAP controller's CAPTURE states and allows

this information to be shifted out on TDO during the TAP controller's SHIFT states. While the sampled data is being shifted out of the chain on TDO, new data is being shifted into the serial shift register on TDI. This new data is stored in the parallel load register during the TAP controller's UPDATE states. Each of the shift registers is discussed in detail in "Register Descriptions" on page 97.

### 5.3.4 Operational Considerations

Certain operational parameters must be considered when using the JTAG module. Because the JTAG pins can be programmed to be GPIOs, board configuration and reset conditions on these pins must be considered. In addition, because the JTAG module has integrated ARM Serial Wire Debug, the method for switching between these two operational modes is described below.

#### 5.3.4.1 GPIO Functionality

When the microcontroller is reset with either a POR or  $\overline{\text{RST}}$ , the JTAG/SWD port pins default to their JTAG/SWD configurations. The default configuration includes enabling digital functionality (DEN[3:0] set in the **Port C GPIO Digital Enable (GPIODEN)** register), enabling the pull-up resistors (PUE[3:0] set in the **Port C GPIO Pull-Up Select (GPIOPUR)** register), disabling the pull-down resistors (PDE[3:0] cleared in the **Port C GPIO Pull-Down Select (GPIOPDR)** register) and enabling the alternate hardware function (AFSEL[3:0] set in the **Port C GPIO Alternate Function Select (GPIOAFSEL)** register) on the JTAG/SWD pins. See page 328, page 334, page 336, and page 339.

It is possible for software to configure these pins as GPIOs after reset by clearing AFSEL[3:0] in the **Port C GPIOAFSEL** register. If the user does not require the JTAG/SWD port for debugging or board-level testing, this provides four more GPIOs for use in the design.

---

**Caution – It is possible to create a software sequence that prevents the debugger from connecting to the Stellaris® microcontroller. If the program code loaded into flash immediately changes the JTAG pins to their GPIO functionality, the debugger may not have enough time to connect and halt the controller before the JTAG pin functionality switches. As a result, the debugger may be locked out of the part. This issue can be avoided with a software routine that restores JTAG functionality based on an external or software trigger.**

---

The GPIO commit control registers provide a layer of protection against accidental programming of critical hardware peripherals. Protection is currently provided for the NMI pin (PB7) and the four JTAG/SWD pins (PC[3:0]). Writes to protected bits of the **GPIO Alternate Function Select (GPIOAFSEL)** register (see page 328), **GPIO Pull Up Select (GPIOPUR)** register (see page 334), **GPIO Pull-Down Select (GPIOPDR)** register (see page 336), and **GPIO Digital Enable (GPIODEN)** register (see page 339) are not committed to storage unless the **GPIO Lock (GPIOLOCK)** register (see page 341) has been unlocked and the appropriate bits of the **GPIO Commit (GPIOCR)** register (see page 342) have been set.

#### 5.3.4.2 Communication with JTAG/SWD

Because the debug clock and the system clock can be running at different frequencies, care must be taken to maintain reliable communication with the JTAG/SWD interface. In the Capture-DR state, the result of the previous transaction, if any, is returned, together with a 3-bit ACK response. Software should check the ACK response to see if the previous operation has completed before initiating a new transaction. Alternatively, if the system clock is at least 8 times faster than the debug clock (TCK or SWCLK), the previous operation has enough time to complete and the ACK bits do not have to be checked.

### 5.3.4.3 Recovering a "Locked" Microcontroller

**Note:** Performing the sequence below restores the nonvolatile registers discussed in “Nonvolatile Register Programming” on page 215 to their factory default values. The mass erase of the Flash memory caused by the sequence below occurs prior to the nonvolatile registers being restored.

If software configures any of the JTAG/SWD pins as GPIO and loses the ability to communicate with the debugger, there is a debug sequence that can be used to recover the microcontroller. Performing a total of ten JTAG-to-SWD and SWD-to-JTAG switch sequences while holding the microcontroller in reset mass erases the Flash memory. The sequence to recover the microcontroller is:

1. Assert and hold the  $\overline{\text{RST}}$  signal.
2. Perform steps 1 and 2 of the JTAG-to-SWD switch sequence on the section called “JTAG-to-SWD Switching” on page 96.
3. Perform steps 1 and 2 of the SWD-to-JTAG switch sequence on the section called “SWD-to-JTAG Switching” on page 96.
4. Perform steps 1 and 2 of the JTAG-to-SWD switch sequence.
5. Perform steps 1 and 2 of the SWD-to-JTAG switch sequence.
6. Perform steps 1 and 2 of the JTAG-to-SWD switch sequence.
7. Perform steps 1 and 2 of the SWD-to-JTAG switch sequence.
8. Perform steps 1 and 2 of the JTAG-to-SWD switch sequence.
9. Perform steps 1 and 2 of the SWD-to-JTAG switch sequence.
10. Perform steps 1 and 2 of the JTAG-to-SWD switch sequence.
11. Perform steps 1 and 2 of the SWD-to-JTAG switch sequence.
12. Release the  $\overline{\text{RST}}$  signal.
13. Wait 400 ms.
14. Power-cycle the microcontroller.

### 5.3.4.4 ARM Serial Wire Debug (SWD)

In order to seamlessly integrate the ARM Serial Wire Debug (SWD) functionality, a serial-wire debugger must be able to connect to the Cortex-M3 core without having to perform, or have any knowledge of, JTAG cycles. This integration is accomplished with a SWD preamble that is issued before the SWD session begins.

The switching preamble used to enable the SWD interface of the SWJ-DP module starts with the TAP controller in the Test-Logic-Reset state. From here, the preamble sequences the TAP controller through the following states: Run Test Idle, Select DR, Select IR, Test Logic Reset, Test Logic Reset, Run Test Idle, Run Test Idle, Select DR, Select IR, Test Logic Reset, Test Logic Reset, Run Test Idle, Run Test Idle, Select DR, Select IR, and Test Logic Reset states.

Stepping through this sequence of the TAP state machine enables the SWD interface and disables the JTAG interface. For more information on this operation and the SWD interface, see the *ARM® Cortex™-M3 Technical Reference Manual* and the *ARM® CoreSight Technical Reference Manual*.

Because this sequence is a valid series of JTAG operations that could be issued, the ARM JTAG TAP controller is not fully compliant to the *IEEE Standard 1149.1*. This instance is the only one where the ARM JTAG TAP controller does not meet full compliance with the specification. Due to the low probability of this sequence occurring during normal operation of the TAP controller, it should not affect normal performance of the JTAG interface.

### **JTAG-to-SWD Switching**

To switch the operating mode of the Debug Access Port (DAP) from JTAG to SWD mode, the external debug hardware must send the switching preamble to the microcontroller. The 16-bit TMS command for switching to SWD mode is defined as b1110.0111.1001.1110, transmitted LSB first. This command can also be represented as 0xE79E when transmitted LSB first. The complete switch sequence should consist of the following transactions on the TCK/SWCLK and TMS/SWDIO signals:

1. Send at least 50 TCK/SWCLK cycles with TMS/SWDIO High to ensure that both JTAG and SWD are in their reset/idle states.
2. Send the 16-bit JTAG-to-SWD switch command, 0xE79E, on TMS.
3. Send at least 50 TCK/SWCLK cycles with TMS/SWDIO High to ensure that if SWJ-DP was already in SWD mode, the SWD goes into the line reset state before sending the switch sequence.

### **SWD-to-JTAG Switching**

To switch the operating mode of the Debug Access Port (DAP) from SWD to JTAG mode, the external debug hardware must send a switch command to the microcontroller. The 16-bit TMS command for switching to JTAG mode is defined as b1110.0111.0011.1100, transmitted LSB first. This command can also be represented as 0xE73C when transmitted LSB first. The complete switch sequence should consist of the following transactions on the TCK/SWCLK and TMS/SWDIO signals:

1. Send at least 50 TCK/SWCLK cycles with TMS/SWDIO High to ensure that both JTAG and SWD are in their reset/idle states.
2. Send the 16-bit SWD-to-JTAG switch command, 0xE73C, on TMS.
3. Send at least 50 TCK/SWCLK cycles with TMS/SWDIO High to ensure that if SWJ-DP was already in JTAG mode, the JTAG goes into the Test Logic Reset state before sending the switch sequence.

## **5.4 Initialization and Configuration**

After a Power-On-Reset or an external reset ( $\overline{\text{RST}}$ ), the JTAG pins are automatically configured for JTAG communication. No user-defined initialization or configuration is needed. However, if the user application changes these pins to their GPIO function, they must be configured back to their JTAG functionality before JTAG communication can be restored. To return the pins to their JTAG functions, enable the four JTAG pins (PC[3:0]) for their alternate function using the **GPIOAFSEL** register. In addition to enabling the alternate functions, any other changes to the GPIO pad configurations on the four JTAG pins (PC[3:0]) should be returned to their default settings.



## 5.5 Register Descriptions

The registers in the JTAG TAP Controller or Shift Register chains are not memory mapped and are not accessible through the on-chip Advanced Peripheral Bus (APB). Instead, the registers within the JTAG controller are all accessed serially through the TAP Controller. These registers include the Instruction Register and the six Data Registers.

### 5.5.1 Instruction Register (IR)

The JTAG TAP Instruction Register (IR) is a four-bit serial scan chain connected between the JTAG TDI and TDO pins with a parallel load register. When the TAP Controller is placed in the correct states, bits can be shifted into the IR. Once these bits have been shifted into the chain and updated, they are interpreted as the current instruction. The decode of the IR bits is shown in Table 5-4. A detailed explanation of each instruction, along with its associated Data Register, follows.

**Table 5-4. JTAG Instruction Register Commands**

IR[3:0]	Instruction	Description
0x0	EXTEST	Drives the values preloaded into the Boundary Scan Chain by the SAMPLE/PRELOAD instruction onto the pads.
0x1	INTEST	Drives the values preloaded into the Boundary Scan Chain by the SAMPLE/PRELOAD instruction into the controller.
0x2	SAMPLE / PRELOAD	Captures the current I/O values and shifts the sampled values out of the Boundary Scan Chain while new preload data is shifted in.
0x8	ABORT	Shifts data into the ARM Debug Port Abort Register.
0xA	DPACC	Shifts data into and out of the ARM DP Access Register.
0xB	APACC	Shifts data into and out of the ARM AC Access Register.
0xE	IDCODE	Loads manufacturing information defined by the <i>IEEE Standard 1149.1</i> into the IDCODE chain and shifts it out.
0xF	BYPASS	Connects TDI to TDO through a single Shift Register chain.
All Others	Reserved	Defaults to the BYPASS instruction to ensure that TDI is always connected to TDO.

#### 5.5.1.1 EXTEST Instruction

The EXTEST instruction is not associated with its own Data Register chain. Instead, the EXTEST instruction uses the data that has been preloaded into the Boundary Scan Data Register using the SAMPLE/PRELOAD instruction. When the EXTEST instruction is present in the Instruction Register, the preloaded data in the Boundary Scan Data Register associated with the outputs and output enables are used to drive the GPIO pads rather than the signals coming from the core. With tests that drive known values out of the controller, this instruction can be used to verify connectivity. While the EXTEST instruction is present in the Instruction Register, the Boundary Scan Data Register can be accessed to sample and shift out the current data and load new data into the Boundary Scan Data Register.

#### 5.5.1.2 INTEST Instruction

The INTEST instruction is not associated with its own Data Register chain. Instead, the INTEST instruction uses the data that has been preloaded into the Boundary Scan Data Register using the SAMPLE/PRELOAD instruction. When the INTEST instruction is present in the Instruction Register, the preloaded data in the Boundary Scan Data Register associated with the inputs are used to drive the signals going into the core rather than the signals coming from the GPIO pads. With tests that drive known values into the controller, this instruction can be used for testing. It is important to note that although the RST input pin is on the Boundary Scan Data Register chain, it is only observable.

While the INTEST instruction is present in the Instruction Register, the Boundary Scan Data Register can be accessed to sample and shift out the current data and load new data into the Boundary Scan Data Register.

### 5.5.1.3 SAMPLE/PRELOAD Instruction

The SAMPLE/PRELOAD instruction connects the Boundary Scan Data Register chain between TDI and TDO. This instruction samples the current state of the pad pins for observation and preloads new test data. Each GPIO pad has an associated input, output, and output enable signal. When the TAP controller enters the Capture DR state during this instruction, the input, output, and output-enable signals to each of the GPIO pads are captured. These samples are serially shifted out on TDO while the TAP controller is in the Shift DR state and can be used for observation or comparison in various tests.

While these samples of the inputs, outputs, and output enables are being shifted out of the Boundary Scan Data Register, new data is being shifted into the Boundary Scan Data Register from TDI. Once the new data has been shifted into the Boundary Scan Data Register, the data is saved in the parallel load registers when the TAP controller enters the Update DR state. This update of the parallel load register preloads data into the Boundary Scan Data Register that is associated with each input, output, and output enable. This preloaded data can be used with the EXTEST and INTEST instructions to drive data into or out of the controller. See “Boundary Scan Data Register” on page 99 for more information.

### 5.5.1.4 ABORT Instruction

The ABORT instruction connects the associated ABORT Data Register chain between TDI and TDO. This instruction provides read and write access to the ABORT Register of the ARM Debug Access Port (DAP). Shifting the proper data into this Data Register clears various error bits or initiates a DAP abort of a previous request. See the “ABORT Data Register” on page 100 for more information.

### 5.5.1.5 DPACC Instruction

The DPACC instruction connects the associated DPACC Data Register chain between TDI and TDO. This instruction provides read and write access to the DPACC Register of the ARM Debug Access Port (DAP). Shifting the proper data into this register and reading the data output from this register allows read and write access to the ARM debug and status registers. See “DPACC Data Register” on page 100 for more information.

### 5.5.1.6 APACC Instruction

The APACC instruction connects the associated APACC Data Register chain between TDI and TDO. This instruction provides read and write access to the APACC Register of the ARM Debug Access Port (DAP). Shifting the proper data into this register and reading the data output from this register allows read and write access to internal components and buses through the Debug Port. See “APACC Data Register” on page 100 for more information.

### 5.5.1.7 IDCODE Instruction

The IDCODE instruction connects the associated IDCODE Data Register chain between TDI and TDO. This instruction provides information on the manufacturer, part number, and version of the ARM core. This information can be used by testing equipment and debuggers to automatically configure input and output data streams. IDCODE is the default instruction loaded into the JTAG Instruction Register when a Power-On-Reset (POR) is asserted, or the Test-Logic-Reset state is entered. See “IDCODE Data Register” on page 99 for more information.

### 5.5.1.8 BYPASS Instruction

The BYPASS instruction connects the associated BYPASS Data Register chain between TDI and TDO. This instruction is used to create a minimum length serial path between the TDI and TDO ports. The BYPASS Data Register is a single-bit shift register. This instruction improves test efficiency by allowing components that are not needed for a specific test to be bypassed in the JTAG scan chain by loading them with the BYPASS instruction. See “BYPASS Data Register” on page 99 for more information.

## 5.5.2 Data Registers

The JTAG module contains six Data Registers. These serial Data Register chains include: IDCODE, BYPASS, Boundary Scan, APACC, DPACC, and ABORT and are discussed in the following sections.

### 5.5.2.1 IDCODE Data Register

The format for the 32-bit IDCODE Data Register defined by the *IEEE Standard 1149.1* is shown in Figure 5-3. The standard requires that every JTAG-compliant microcontroller implement either the IDCODE instruction or the BYPASS instruction as the default instruction. The LSB of the IDCODE Data Register is defined to be a 1 to distinguish it from the BYPASS instruction, which has an LSB of 0. This definition allows auto-configuration test tools to determine which instruction is the default instruction.

The major uses of the JTAG port are for manufacturer testing of component assembly and program development and debug. To facilitate the use of auto-configuration debug tools, the IDCODE instruction outputs a value of 0x4BA0.0477. This value allows the debuggers to automatically configure themselves to work correctly with the Cortex-M3 during debug.

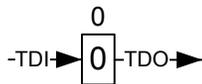
**Figure 5-3. IDCODE Register Format**



### 5.5.2.2 BYPASS Data Register

The format for the 1-bit BYPASS Data Register defined by the *IEEE Standard 1149.1* is shown in Figure 5-4. The standard requires that every JTAG-compliant microcontroller implement either the BYPASS instruction or the IDCODE instruction as the default instruction. The LSB of the BYPASS Data Register is defined to be a 0 to distinguish it from the IDCODE instruction, which has an LSB of 1. This definition allows auto-configuration test tools to determine which instruction is the default instruction.

**Figure 5-4. BYPASS Register Format**



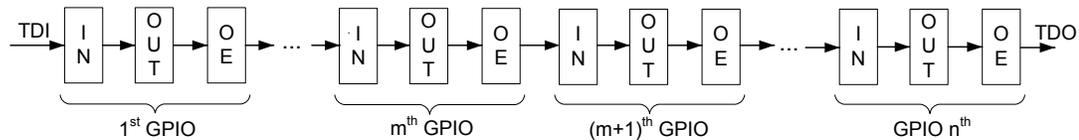
### 5.5.2.3 Boundary Scan Data Register

The format of the Boundary Scan Data Register is shown in Figure 5-5. Each GPIO pin, starting with a GPIO pin next to the JTAG port pins, is included in the Boundary Scan Data Register. Each

GPIO pin has three associated digital signals that are included in the chain. These signals are input, output, and output enable, and are arranged in that order as shown in the figure.

When the Boundary Scan Data Register is accessed with the SAMPLE/PRELOAD instruction, the input, output, and output enable from each digital pad are sampled and then shifted out of the chain to be verified. The sampling of these values occurs on the rising edge of TCK in the Capture DR state of the TAP controller. While the sampled data is being shifted out of the Boundary Scan chain in the Shift DR state of the TAP controller, new data can be preloaded into the chain for use with the EXTEST and INTEST instructions. The EXTEST instruction forces data out of the controller, and the INTEST instruction forces data into the controller.

**Figure 5-5. Boundary Scan Register Format**



#### 5.5.2.4 APACC Data Register

The format for the 35-bit APACC Data Register defined by ARM is described in the *ARM® Cortex™-M3 Technical Reference Manual*.

#### 5.5.2.5 DPACC Data Register

The format for the 35-bit DPACC Data Register defined by ARM is described in the *ARM® Cortex™-M3 Technical Reference Manual*.

#### 5.5.2.6 ABORT Data Register

The format for the 35-bit ABORT Data Register defined by ARM is described in the *ARM® Cortex™-M3 Technical Reference Manual*.

## 6 System Control

System control configures the overall operation of the device and provides information about the device. Configurable features include reset control, NMI operation, power control, clock control, and low-power modes.

### 6.1 Signal Description

Table 6-1 on page 101 and Table 6-2 on page 101 list the external signals of the System Control module and describe the function of each. The NMI signal is the alternate function for the GPIO PB7 signal and functions as a GPIO after reset. PB7 is under commit protection and requires a special process to be configured as the NMI signal or to subsequently return to the GPIO function, see “Commit Control” on page 312. The column in the table below titled “Pin Mux/Pin Assignment” lists the GPIO pin placement for the NMI signal. The AFSEL bit in the **GPIO Alternate Function Select (GPIOAFSEL)** register (page 328) should be set to choose the NMI function. The number in parentheses is the encoding that must be programmed into the PMC<sub>n</sub> field in the **GPIO Port Control (GPIOPTCL)** register (page 346) to assign the NMI signal to the specified GPIO port pin. For more information on configuring GPIOs, see “General-Purpose Input/Outputs (GPIOs)” on page 304. The remaining signals (with the word “fixed” in the Pin Mux/Pin Assignment column) have a fixed pin assignment and function.

**Table 6-1. Signals for System Control & Clocks (100LQFP)**

Pin Name	Pin Number	Pin Mux / Pin Assignment	Pin Type	Buffer Type <sup>a</sup>	Description
NMI	89	PB7 (4)	I	TTL	Non-maskable interrupt.
OSC0	48	fixed	I	Analog	Main oscillator crystal input or an external clock reference input.
OSC1	49	fixed	O	Analog	Main oscillator crystal output. Leave unconnected when using a single-ended clock source.
RST	64	fixed	I	TTL	System reset input.

a. The TTL designation indicates the pin has TTL-compatible voltage levels.

**Table 6-2. Signals for System Control & Clocks (108BGA)**

Pin Name	Pin Number	Pin Mux / Pin Assignment	Pin Type	Buffer Type <sup>a</sup>	Description
NMI	A8	PB7 (4)	I	TTL	Non-maskable interrupt.
OSC0	L11	fixed	I	Analog	Main oscillator crystal input or an external clock reference input.
OSC1	M11	fixed	O	Analog	Main oscillator crystal output. Leave unconnected when using a single-ended clock source.
RST	H11	fixed	I	TTL	System reset input.

a. The TTL designation indicates the pin has TTL-compatible voltage levels.

### 6.2 Functional Description

The System Control module provides the following capabilities:

- Device identification, see “Device Identification” on page 102

- Local control, such as reset (see “Reset Control” on page 102), power (see “Power Control” on page 107) and clock control (see “Clock Control” on page 107)
- System control (Run, Sleep, and Deep-Sleep modes), see “System Control” on page 114

## 6.2.1 Device Identification

Several read-only registers provide software with information on the microcontroller, such as version, part number, SRAM size, Flash memory size, and other features. See the **DID0** (page 118), **DID1** (page 146), **DC0-DC9** (page 148) and **NVMSTAT** (page 172) registers.

## 6.2.2 Reset Control

This section discusses aspects of hardware functions during reset as well as system software requirements following the reset sequence.

### 6.2.2.1 Reset Sources

The LM3S9B96 microcontroller has six sources of reset:

1. Power-on reset (POR) (see page 103).
2. External reset input pin ( $\overline{RST}$ ) assertion (see page 103).
3. Internal brown-out (BOR) detector (see page 105).
4. Software-initiated reset (with the software reset registers) (see page 105).
5. A watchdog timer reset condition violation (see page 106).
6. MOSC failure (see page 106).

Table 6-3 provides a summary of results of the various reset operations.

**Table 6-3. Reset Sources**

Reset Source	Core Reset?	JTAG Reset?	On-Chip Peripherals Reset?
Power-On Reset	Yes	Yes	Yes
$\overline{RST}$	Yes	Pin Config Only	Yes
Brown-Out Reset	Yes	No	Yes
Software System Request Reset	Yes <sup>a</sup>	No	Yes
Software Peripheral Reset	No	No	Yes <sup>b</sup>
Watchdog Reset	Yes	No	Yes
MOSC Failure Reset	Yes	No	Yes

a. By using the SYSRESETREQ bit in the ARM Cortex-M3 Application Interrupt and Reset Control register

b. Programmable on a module-by-module basis using the Software Reset Control Registers.

After a reset, the **Reset Cause (RESC)** register is set with the reset cause. The bits in this register are sticky and maintain their state across multiple reset sequences, except when an internal POR is the cause, in which case, all the bits in the **RESC** register are cleared except for the POR indicator. A bit in the **RESC** register can be cleared by writing a 0.

At any reset that resets the core, the user has the opportunity to direct the core to execute the ROM Boot Loader or the application in Flash memory by using any GPIO signal in Ports A-H as configured

in the **Boot Configuration (BOOTCFG)** register. If the ROM boot loader is not selected, code in the ROM checks address 0x000.0004 to see if the Flash memory has a valid reset vector. If the data at address 0x0000.0004 is 0xFFFF.FFFF, then it is assumed that the Flash memory has not yet been programmed, and the core executes the ROM Boot Loader.

For example, if the **BOOTCFG** register is written and committed with the value of 0x0000.3C01, then PB7 is examined at reset to determine if the ROM boot loader should be executed. If PB7 is Low, the core unconditionally begins executing the ROM boot loader. If PB7 is High, then the application in Flash memory is executed if the reset vector at location 0x0000.0004 is not 0xFFFF.FFFF. Otherwise, the ROM boot loader is executed.

### 6.2.2.2 Power-On Reset (POR)

**Note:** The power-on reset also resets the JTAG controller. An external reset does not.

The internal Power-On Reset (POR) circuit monitors the power supply voltage ( $V_{DD}$ ) and generates a reset signal to all of the internal logic including JTAG when the power supply ramp reaches a threshold value ( $V_{TH}$ ). The microcontroller must be operating within the specified operating parameters when the on-chip power-on reset pulse is complete. For applications that require the use of an external reset signal to hold the microcontroller in reset longer than the internal POR, the  $\overline{RST}$  input may be used as discussed in “External  $\overline{RST}$  Pin” on page 103.

The Power-On Reset sequence is as follows:

1. The microcontroller waits for internal POR to go inactive.
2. The internal reset is released and the core loads from memory the initial stack pointer, the initial program counter, and the first instruction designated by the program counter, and then begins execution.

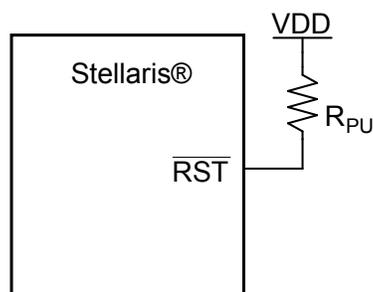
The internal POR is only active on the initial power-up of the microcontroller. The Power-On Reset timing is shown in Figure 27-5 on page 1212.

### 6.2.2.3 External $\overline{RST}$ Pin

**Note:** It is recommended that the trace for the  $\overline{RST}$  signal must be kept as short as possible. Be sure to place any components connected to the  $\overline{RST}$  signal as close to the microcontroller as possible.

If the application only uses the internal POR circuit, the  $\overline{RST}$  input must be connected to the power supply ( $V_{DD}$ ) through an optional pull-up resistor (0 to 100K  $\Omega$ ) as shown in Figure 6-1 on page 103.

**Figure 6-1. Basic  $\overline{RST}$  Configuration**



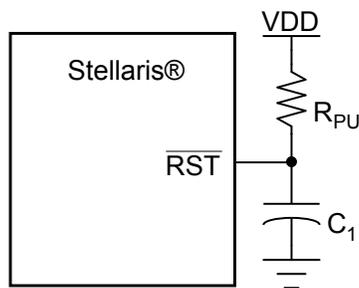
$R_{PU} = 0$  to 100 k $\Omega$

The external reset pin ( $\overline{\text{RST}}$ ) resets the microcontroller including the core and all the on-chip peripherals except the JTAG TAP controller (see “JTAG Interface” on page 89). The external reset sequence is as follows:

1. The external reset pin ( $\overline{\text{RST}}$ ) is asserted for the duration specified by  $T_{\text{MIN}}$  and then de-asserted (see “Reset” on page 1211).
2. The internal reset is released and the core loads from memory the initial stack pointer, the initial program counter, and the first instruction designated by the program counter, and then begins execution.

To improve noise immunity and/or to delay reset at power up, the  $\overline{\text{RST}}$  input may be connected to an RC network as shown in Figure 6-2 on page 104.

**Figure 6-2. External Circuitry to Extend Power-On Reset**

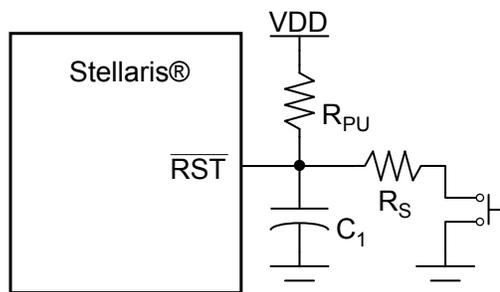


$$R_{\text{PU}} = 1 \text{ k}\Omega \text{ to } 100 \text{ k}\Omega$$

$$C_1 = 1 \text{ nF to } 10 \text{ }\mu\text{F}$$

If the application requires the use of an external reset switch, Figure 6-3 on page 104 shows the proper circuitry to use.

**Figure 6-3. Reset Circuit Controlled by Switch**



$$\text{Typical } R_{\text{PU}} = 10 \text{ k}\Omega$$

$$\text{Typical } R_{\text{S}} = 470 \text{ }\Omega$$

$$C_1 = 10 \text{ nF}$$

The  $R_{\text{PU}}$  and  $C_1$  components define the power-on delay.

The external reset timing is shown in Figure 27-4 on page 1211.



#### 6.2.2.4 Brown-Out Reset (BOR)

The microcontroller provides a brown-out detection circuit that triggers if the power supply ( $V_{DD}$ ) drops below a brown-out threshold voltage ( $V_{BTH}$ ). If a brown-out condition is detected, the system may generate an interrupt or a system reset. The default condition is to generate an interrupt, so BOR must be enabled. Brown-out resets are controlled with the **Power-On and Brown-Out Reset Control (PBORCTL)** register. The  $BORIOR$  bit in the **PBORCTL** register must be set for a brown-out condition to trigger a reset; if  $BORIOR$  is clear, an interrupt is generated. When a Brown-out condition occurs during a Flash PROGRAM or ERASE operation, a full system reset is always triggered without regard to the setting in the **PBORCTL** register.

The brown-out reset sequence is as follows:

1. When  $V_{DD}$  drops below  $V_{BTH}$ , an internal BOR condition is set.
2. If the BOR condition exists, an internal reset is asserted.
3. The internal reset is released and the microcontroller fetches and loads the initial stack pointer, the initial program counter, the first instruction designated by the program counter, and begins execution.
4. The internal BOR condition is reset after 500  $\mu$ s to prevent another BOR condition from being set before software has a chance to investigate the original cause.

The result of a brown-out reset is equivalent to that of an assertion of the external  $\overline{RST}$  input, and the reset is held active until the proper  $V_{DD}$  level is restored. The **RESC** register can be examined in the reset interrupt handler to determine if a Brown-Out condition was the cause of the reset, thus allowing software to determine what actions are required to recover.

The internal Brown-Out Reset timing is shown in Figure 27-6 on page 1212.

#### 6.2.2.5 Software Reset

Software can reset a specific peripheral or generate a reset to the entire microcontroller.

Peripherals can be individually reset by software via three registers that control reset signals to each on-chip peripheral (see the **SRCRn** registers, page 202). If the bit position corresponding to a peripheral is set and subsequently cleared, the peripheral is reset. The encoding of the reset registers is consistent with the encoding of the clock gating control for peripherals and on-chip functions (see "System Control" on page 114).

The entire microcontroller including the core can be reset by software by setting the **SYSRESETREQ** bit in the Cortex-M3 Application Interrupt and Reset Control register. The software-initiated system reset sequence is as follows:

1. A software microcontroller reset is initiated by setting the **SYSRESETREQ** bit in the ARM Cortex-M3 Application Interrupt and Reset Control register.
2. An internal reset is asserted.
3. The internal reset is deasserted and the microcontroller loads from memory the initial stack pointer, the initial program counter, and the first instruction designated by the program counter, and then begins execution.

The software-initiated system reset timing is shown in Figure 27-7 on page 1212.

### 6.2.2.6 Watchdog Timer Reset

The Watchdog Timer module's function is to prevent system hangs. The LM3S9B96 microcontroller has two Watchdog Timer modules in case one watchdog clock source fails. One watchdog is run off the system clock and the other is run off the Precision Internal Oscillator (PIOSC). Each module operates in the same manner except that because the PIOSC watchdog timer module is in a different clock domain, register accesses must have a time delay between them. The watchdog timer can be configured to generate an interrupt to the microcontroller on its first time-out and to generate a reset on its second time-out.

After the watchdog's first time-out event, the 32-bit watchdog counter is reloaded with the value of the **Watchdog Timer Load (WDTLOAD)** register and resumes counting down from that value. If the timer counts down to zero again before the first time-out interrupt is cleared, and the reset signal has been enabled, the watchdog timer asserts its reset signal to the microcontroller. The watchdog timer reset sequence is as follows:

1. The watchdog timer times out for the second time without being serviced.
2. An internal reset is asserted.
3. The internal reset is released and the microcontroller loads from memory the initial stack pointer, the initial program counter, and the first instruction designated by the program counter, and then begins execution.

For more information on the Watchdog Timer module, see "Watchdog Timers" on page 481.

The watchdog reset timing is shown in Figure 27-8 on page 1212.

### 6.2.3 Non-Maskable Interrupt

The microcontroller has three sources of non-maskable interrupt (NMI):

- The assertion of the `NMI` signal
- A main oscillator verification error
- The `NMISSET` bit in the **Interrupt Control and Status (ICSR)** register in the Cortex-M3.

Software must check the cause of the interrupt in order to distinguish among the sources.

#### 6.2.3.1 NMI Pin

The alternate function to GPIO port pin B7 is an NMI signal. The alternate function must be enabled in the GPIO for the signal to be used as an interrupt, as described in "General-Purpose Input/Outputs (GPIOs)" on page 304. Note that enabling the NMI alternate function requires the use of the GPIO lock and commit function just like the GPIO port pins associated with JTAG/SWD functionality, see page 342. The active sense of the NMI signal is High; asserting the enabled NMI signal above  $V_{IH}$  initiates the NMI interrupt sequence.

#### 6.2.3.2 Main Oscillator Verification Failure

The LM3S9B96 microcontroller provides a main oscillator verification circuit that generates an error condition if the oscillator is running too fast or too slow. The main oscillator verification circuit can be programmed to generate a reset event, at which time a Power-on Reset is generated and control is transferred to the NMI handler. The NMI handler is used to address the main oscillator verification failure because the necessary code can be removed from the general reset handler, speeding up reset processing. The detection circuit is enabled by setting the `CVAL` bit in the **Main Oscillator**

**Control (MOSCCTL)** register. The main oscillator verification error is indicated in the main oscillator fail status (MOSCFAIL) bit in the **Reset Cause (RESC)** register. The main oscillator verification circuit action is described in more detail in “Main Oscillator Verification Circuit” on page 114.

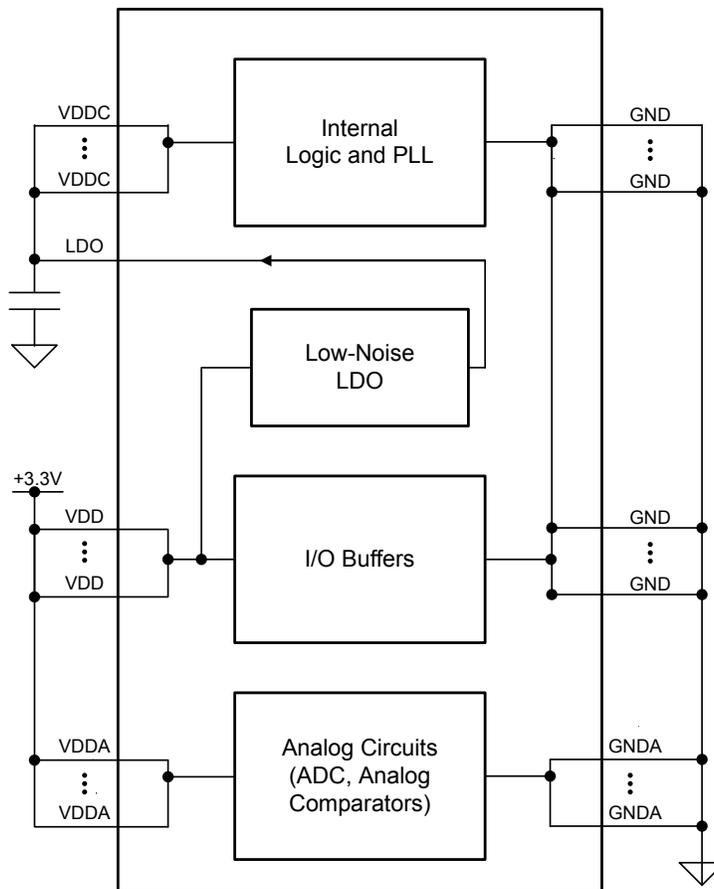
## 6.2.4 Power Control

The Stellaris® microcontroller provides an integrated LDO regulator that is used to provide power to the majority of the microcontroller's internal logic. For power reduction, a non-programmable LDO may be used to scale the microcontroller's 3.3 V input voltage to 1.2V. The voltage output has a minimum voltage of 1.08 V and a maximum of 1.35 V. The LDO delivers up to 60 ma.

Figure 6-4 shows the power architecture.

**Note:** On the printed circuit board, use the LDO output as the source of VDDC input. In addition, the LDO requires decoupling capacitors. See “On-Chip Low Drop-Out (LDO) Regulator Characteristics” on page 1206.

**Figure 6-4. Power Architecture**



## 6.2.5 Clock Control

System control determines the control of clocks in this part.

### 6.2.5.1 Fundamental Clock Sources

There are multiple clock sources for use in the microcontroller:

- **Precision Internal Oscillator (PIOSC).** The precision internal oscillator is an on-chip clock source that is the clock source the microcontroller uses during and following POR. It does not require the use of any external components and provides a clock that is 16 MHz  $\pm$ 1% at room temperature and  $\pm$ 3% across temperature. The PIOSC allows for a reduced system cost in applications that require an accurate clock source. If the main oscillator is required, software must enable the main oscillator following reset and allow the main oscillator to stabilize before changing the clock reference.
- **Main Oscillator (MOSC).** The main oscillator provides a frequency-accurate clock source by one of two means: an external single-ended clock source is connected to the OSC0 input pin, or an external crystal is connected across the OSC0 input and OSC1 output pins. If the PLL is being used, the crystal value must be one of the supported frequencies between 3.579545 MHz through 16.384 MHz (inclusive). If the PLL is not being used, the crystal may be any one of the supported frequencies between 1 MHz and 16.384 MHz. The single-ended clock source range is from DC through the specified speed of the microcontroller. The supported crystals are listed in the XTAL bit field in the **RCC** register (see page 129). Note that the MOSC must have a clock source for the USB PLL.
- **Internal 30-kHz Oscillator.** The internal 30-kHz oscillator provides an operational frequency of 30 kHz  $\pm$  50%. It is intended for use during Deep-Sleep power-saving modes. This power-savings mode benefits from reduced internal switching and also allows the MOSC and PIOSC to be powered down.

The internal system clock (SysCik), is derived from any of the above sources plus two others: the output of the main internal PLL and the precision internal oscillator divided by four (4 MHz  $\pm$  1%). The frequency of the PLL clock reference must be in the range of 3.579545 MHz to 16.384 MHz (inclusive). Table 6-4 on page 108 shows how the various clock sources can be used in a system.

**Table 6-4. Clock Source Options**

Clock Source	Drive PLL?		Used as SysCik?	
	Yes	BYPASS = 0, OSCSRC = 0x1	Yes	BYPASS = 1, OSCSRC = 0x1
Precision Internal Oscillator	Yes	BYPASS = 0, OSCSRC = 0x1	Yes	BYPASS = 1, OSCSRC = 0x1
Precision Internal Oscillator divide by 4 (4 MHz $\pm$ 1%)	No	BYPASS = 1	Yes	BYPASS = 1, OSCSRC = 0x2
Main Oscillator	Yes	BYPASS = 0, OSCSRC = 0x0	Yes	BYPASS = 1, OSCSRC = 0x0
Internal 30-kHz Oscillator	No	BYPASS = 1	Yes	BYPASS = 1, OSCSRC = 0x3

### 6.2.5.2 Clock Configuration

The **Run-Mode Clock Configuration (RCC)** and **Run-Mode Clock Configuration 2 (RCC2)** registers provide control for the system clock. The **RCC2** register is provided to extend fields that offer additional encodings over the **RCC** register. When used, the **RCC2** register field values are used by the logic over the corresponding field in the **RCC** register. In particular, **RCC2** provides for a larger assortment of clock configuration options. These registers control the following clock functionality:

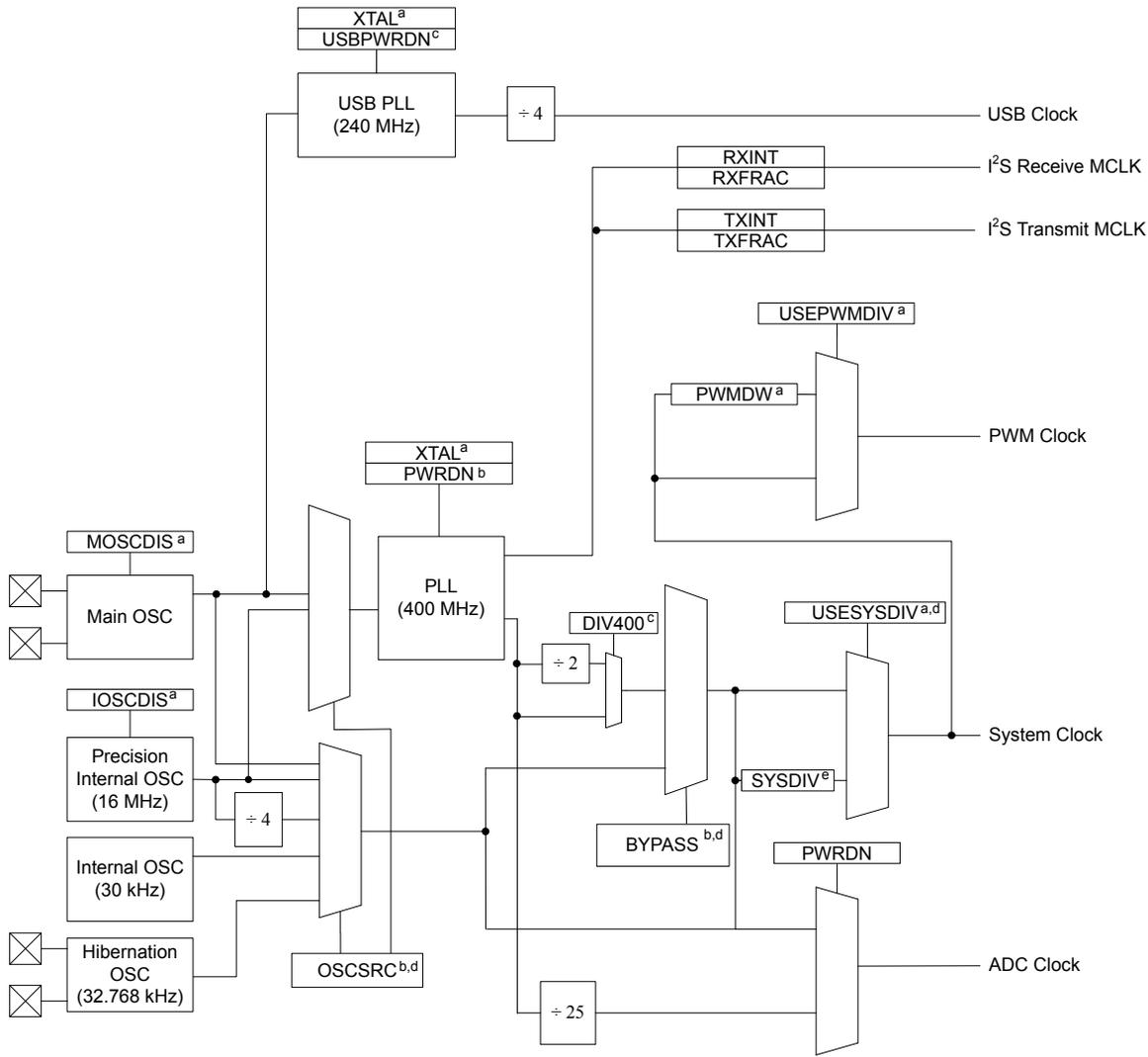
- Source of clocks in sleep and deep-sleep modes

- System clock derived from PLL or other clock source
- Enabling/disabling of oscillators and PLL
- Clock divisors
- Crystal input selection

Figure 6-5 shows the logic for the main clock tree. The peripheral blocks are driven by the system clock signal and can be individually enabled/disabled. The ADC clock signal is automatically divided down to 16 MHz for proper ADC operation. The PWM clock signal is a synchronous divide of the system clock to provide the PWM circuit with more range (set with `PWMDIV` in **RCC**).

**Note:** When the ADC module is in operation, the system clock must be at least 16 MHz.

Figure 6-5. Main Clock Tree



- a. Control provided by **RCC** register bit/field.  
 b. Control provided by **RCC** register bit/field or **RCC2** register bit/field, if overridden with **RCC2** register bit USERCC2.  
 c. Control provided by **RCC2** register bit/field.  
 d. Also may be controlled by **DSLPLCLKCFG** when in deep sleep mode.  
 e. Control provided by **RCC** register SYSDIV field, **RCC2** register SYSDIV2 field if overridden with USERCC2 bit, or [SYSDIV2,SYSDIV2LSB] if both USERCC2 and DIV400 bits are set.

**Note:** The figure above shows all features available on all Stellaris® Tempest-class microcontrollers.

In the **RCC** register, the **SYSDIV** field specifies which divisor is used to generate the system clock from either the PLL output or the oscillator source (depending on how the **BYPASS** bit in this register is configured). When using the PLL, the VCO frequency of 400 MHz is predivided by 2 before the divisor is applied. Table 6-5 shows how the **SYSDIV** encoding affects the system clock frequency, depending on whether the PLL is used (**BYPASS**=0) or another clock source is used (**BYPASS**=1). The divisor is equivalent to the **SYSDIV** encoding plus 1. For a list of possible clock sources, see Table 6-4 on page 108.

**Table 6-5. Possible System Clock Frequencies Using the SYSDIV Field**

SYSDIV	Divisor	Frequency (BYPASS=0)	Frequency (BYPASS=1)	StellarisWare Parameter <sup>a</sup>
0x0	/1	reserved	Clock source frequency/2	SYSCCTL_SYSDIV_1 <sup>b</sup>
0x1	/2	reserved	Clock source frequency/2	SYSCCTL_SYSDIV_2
0x2	/3	66.67 MHz	Clock source frequency/3	SYSCCTL_SYSDIV_3
0x3	/4	50 MHz	Clock source frequency/4	SYSCCTL_SYSDIV_4
0x4	/5	40 MHz	Clock source frequency/5	SYSCCTL_SYSDIV_5
0x5	/6	33.33 MHz	Clock source frequency/6	SYSCCTL_SYSDIV_6
0x6	/7	28.57 MHz	Clock source frequency/7	SYSCCTL_SYSDIV_7
0x7	/8	25 MHz	Clock source frequency/8	SYSCCTL_SYSDIV_8
0x8	/9	22.22 MHz	Clock source frequency/9	SYSCCTL_SYSDIV_9
0x9	/10	20 MHz	Clock source frequency/10	SYSCCTL_SYSDIV_10
0xA	/11	18.18 MHz	Clock source frequency/11	SYSCCTL_SYSDIV_11
0xB	/12	16.67 MHz	Clock source frequency/12	SYSCCTL_SYSDIV_12
0xC	/13	15.38 MHz	Clock source frequency/13	SYSCCTL_SYSDIV_13
0xD	/14	14.29 MHz	Clock source frequency/14	SYSCCTL_SYSDIV_14
0xE	/15	13.33 MHz	Clock source frequency/15	SYSCCTL_SYSDIV_15
0xF	/16	12.5 MHz (default)	Clock source frequency/16	SYSCCTL_SYSDIV_16

a. This parameter is used in functions such as SysCtlClockSet() in the Stellaris Peripheral Driver Library.

b. SYSCCTL\_SYSDIV\_1 does not set the USESYSYSDIV bit. As a result, using this parameter without enabling the PLL results in the system clock having the same frequency as the clock source.

The SYSDIV2 field in the **RCC2** register is 2 bits wider than the SYSDIV field in the **RCC** register so that additional larger divisors up to /64 are possible, allowing a lower system clock frequency for improved Deep Sleep power consumption. When using the PLL, the VCO frequency of 400 MHz is predivided by 2 before the divisor is applied. The divisor is equivalent to the SYSDIV2 encoding plus 1. Table 6-6 shows how the SYSDIV2 encoding affects the system clock frequency, depending on whether the PLL is used (BYPASS2=0) or another clock source is used (BYPASS2=1). For a list of possible clock sources, see Table 6-4 on page 108.

**Table 6-6. Examples of Possible System Clock Frequencies Using the SYSDIV2 Field**

SYSDIV2	Divisor	Frequency (BYPASS2=0)	Frequency (BYPASS2=1)	StellarisWare Parameter <sup>a</sup>
0x00	/1	reserved	Clock source frequency/2	SYSCCTL_SYSDIV_1 <sup>b</sup>
0x01	/2	reserved	Clock source frequency/2	SYSCCTL_SYSDIV_2
0x02	/3	66.67 MHz	Clock source frequency/3	SYSCCTL_SYSDIV_3
0x03	/4	50 MHz	Clock source frequency/4	SYSCCTL_SYSDIV_4
...	...	...	...	...
0x09	/10	20 MHz	Clock source frequency/10	SYSCCTL_SYSDIV_10
...	...	...	...	...
0x3F	/64	3.125 MHz	Clock source frequency/64	SYSCCTL_SYSDIV_64

a. This parameter is used in functions such as SysCtlClockSet() in the Stellaris Peripheral Driver Library.

b. SYSCCTL\_SYSDIV\_1 does not set the USESYSYSDIV bit. As a result, using this parameter without enabling the PLL results in the system clock having the same frequency as the clock source.

To allow for additional frequency choices when using the PLL, the DIV400 bit is provided along with the SYSDIV2LSB bit. When the DIV400 bit is set, bit 22 becomes the LSB for SYSDIV2. In

this situation, the divisor is equivalent to the (SYSDIV2 encoding with SYSDIV2LSB appended) plus one. Table 6-7 shows the frequency choices when DIV400 is set. When the DIV400 bit is clear, SYSDIV2LSB is ignored, and the system clock frequency is determined as shown in Table 6-6 on page 111.

**Table 6-7. Examples of Possible System Clock Frequencies with DIV400=1**

SYSDIV2	SYSDIV2LSB	Divisor	Frequency (BYPASS2=0) <sup>a</sup>	StellarisWare Parameter <sup>b</sup>
0x00	reserved	/2	reserved	-
0x01	0	/3	reserved	-
	1	/4	reserved	-
0x02	0	/5	80 MHz	SYSCTL_SYSDIV_2_5
	1	/6	66.67 MHz	SYSCTL_SYSDIV_3
0x03	0	/7	reserved	-
	1	/8	50 MHz	SYSCTL_SYSDIV_4
0x04	0	/9	44.44 MHz	SYSCTL_SYSDIV_4_5
	1	/10	40 MHz	SYSCTL_SYSDIV_5
...	...	...	...	...
0x3F	0	/127	3.15 MHz	SYSCTL_SYSDIV_63_5
	1	/128	3.125 MHz	SYSCTL_SYSDIV_64

a. Note that DIV400 and SYSDIV2LSB are only valid when BYPASS2=0.

b. This parameter is used in functions such as SysCtlClockSet() in the Stellaris Peripheral Driver Library.

### 6.2.5.3 Precision Internal Oscillator Operation (PIOSC)

The microcontroller powers up with the PIOSC running. If another clock source is desired, the PIOSC can be powered down by setting the IOSCDIS bit in the **RCC** register.

The PIOSC generates a 16 MHz clock with a  $\pm 1\%$  accuracy at room temperatures. Across the extended temperature range, the accuracy is  $\pm 3\%$ . At the factory, the PIOSC is set to 16 MHz at room temperature, however, the frequency can be trimmed for other voltage or temperature conditions using software in one of two ways:

- **Default calibration:** clear the UTEN bit and set the UPDATE bit in the **Precision Internal Oscillator Calibration (PIOSCCAL)** register.
- **User-defined calibration:** The user can program the UT value to adjust the PIOSC frequency. As the UT value increases, the generated period increases. To commit a new UT value, first set the UTEN bit, then program the UT field, and then set the UPDATE bit. The adjustment finishes within a few clock periods and is glitch free.

### 6.2.5.4 Crystal Configuration for the Main Oscillator (MOSC)

The main oscillator supports the use of a select number of crystals. If the main oscillator is used by the PLL as a reference clock, the supported range of crystals is 3.579545 to 16.384 MHz, otherwise, the range of supported crystals is 1 to 16.384 MHz.

The XTAL bit in the **RCC** register (see page 129) describes the available crystal choices and default programming values.

Software configures the **RCC** register XTAL field with the crystal number. If the PLL is used in the design, the XTAL field value is internally translated to the PLL settings.



### 6.2.5.5 Main PLL Frequency Configuration

The main PLL is disabled by default during power-on reset and is enabled later by software if required. Software specifies the output divisor to set the system clock frequency and enables the main PLL to drive the output. The PLL operates at 400 MHz, but is divided by two prior to the application of the output divisor.

To configure the PIOSC to be the clock source for the main PLL, program the `OSCR2` field in the **Run-Mode Clock Configuration 2 (RCC2)** register to be 0x1.

If the main oscillator provides the clock reference to the main PLL, the translation provided by hardware and used to program the PLL is available for software in the **XTAL to PLL Translation (PLLCFG)** register (see page 134). The internal translation provides a translation within  $\pm 1\%$  of the targeted PLL VCO frequency. Table 27-10 on page 1208 shows the actual PLL frequency and error for a given crystal choice.

The Crystal Value field (`XTAL`) in the **Run-Mode Clock Configuration (RCC)** register (see page 129) describes the available crystal choices and default programming of the **PLLCFG** register. Any time the `XTAL` field changes, the new settings are translated and the internal PLL settings are updated.

### 6.2.5.6 USB PLL Frequency Configuration

The USB PLL is disabled by default during power-on reset and is enabled later by software. The USB PLL must be enabled and running for proper USB function. The main oscillator is the only clock reference for the USB PLL. The USB PLL is enabled by clearing the `USBPWRDN` bit of the **RCC2** register. The `XTAL` bit field (Crystal Value) of the **RCC** register describes the available crystal choices. The main oscillator must be connected to one of the following crystal values in order to correctly generate the USB clock: 4, 5, 6, 8, 10, 12, or 16 MHz. Only these crystals provide the necessary USB PLL VCO frequency to conform with the USB timing specifications.

### 6.2.5.7 PLL Modes

Both PLLs have two modes of operation: Normal and Power-Down

- Normal: The PLL multiplies the input clock reference and drives the output.
- Power-Down: Most of the PLL internal circuitry is disabled and the PLL does not drive the output.

The modes are programmed using the **RCC/RCC2** register fields (see page 129 and page 137).

### 6.2.5.8 PLL Operation

If a PLL configuration is changed, the PLL output frequency is unstable until it reconverges (relocks) to the new setting. The time between the configuration change and relock is  $T_{\text{READY}}$  (see Table 27-9 on page 1208). During the relock time, the affected PLL is not usable as a clock reference.

Either PLL is changed by one of the following:

- Change to the `XTAL` value in the **RCC** register—writes of the same value do not cause a relock.
- Change in the PLL from Power-Down to Normal mode.

A counter is defined to measure the  $T_{\text{READY}}$  requirement. The counter is clocked by the main oscillator. The range of the main oscillator has been taken into account and the down counter is set to 0x1200 (that is,  $\sim 600 \mu\text{s}$  at an 8.192 MHz external oscillator clock). When the `XTAL` value is greater than 0x0F, the down counter is set to 0x2400 to maintain the required lock time on higher frequency crystal inputs. Hardware is provided to keep the PLL from being used as a system clock

until the  $T_{\text{READY}}$  condition is met after one of the two changes above. It is the user's responsibility to have a stable clock source (like the main oscillator) before the **RCC/RCC2** register is switched to use the PLL.

If the main PLL is enabled and the system clock is switched to use the PLL in one step, the system control hardware continues to clock the microcontroller from the oscillator selected by the **RCC/RCC2** register until the main PLL is stable ( $T_{\text{READY}}$  time met), after which it changes to the PLL. Software can use many methods to ensure that the system is clocked from the main PLL, including periodically polling the `PLLLRIS` bit in the **Raw Interrupt Status (RIS)** register, and enabling the PLL Lock interrupt.

The USB PLL is not protected during the lock time ( $T_{\text{READY}}$ ), and software should ensure that the USB PLL has locked before using the interface. Software can use many methods to ensure the  $T_{\text{READY}}$  period has passed, including periodically polling the `USBPLLLRIS` bit in the **Raw Interrupt Status (RIS)** register, and enabling the USB PLL Lock interrupt.

### 6.2.5.9 Main Oscillator Verification Circuit

The clock control includes circuitry to ensure that the main oscillator is running at the appropriate frequency. The circuit monitors the main oscillator frequency and signals if the frequency is outside of the allowable band of attached crystals.

The detection circuit is enabled using the `CVAL` bit in the **Main Oscillator Control (MOSCCTL)** register. If this circuit is enabled and detects an error, the following sequence is performed by the hardware:

1. The `MOSCFAIL` bit in the **Reset Cause (RESC)** register is set.
2. If the internal oscillator (PIOSC) is disabled, it is enabled.
3. The system clock is switched from the main oscillator to the PIOSC.
4. An internal power-on reset is initiated that lasts for 32 PIOSC periods.
5. Reset is de-asserted and the processor is directed to the NMI handler during the reset sequence.

### 6.2.6 System Control

For power-savings purposes, the **RCGCn**, **SCGCn**, and **DCGCn** registers control the clock gating logic for each peripheral or block in the system while the microcontroller is in Run, Sleep, and Deep-Sleep mode, respectively. The **DC1**, **DC2** and **DC4** registers act as a write mask for the **RCGCn**, **SCGCn**, and **DCGCn** registers.

There are three levels of operation for the microcontroller defined as:

- **Run Mode.** In Run mode, the microcontroller actively executes code. Run mode provides normal operation of the processor and all of the peripherals that are currently enabled by the **RCGCn** registers. The system clock can be any of the available clock sources including the PLL.
- **Sleep Mode.** In Sleep mode, the clock frequency of the active peripherals is unchanged, but the processor and the memory subsystem are not clocked and therefore no longer execute code. Sleep mode is entered by the Cortex-M3 core executing a WFI (Wait for Interrupt) instruction. Any properly configured interrupt event in the system brings the processor back into Run mode. See the system control NVIC section of the *ARM® Cortex™-M3 Technical Reference Manual* for more details.

Peripherals are clocked that are enabled in the **SCGCn** register when auto-clock gating is enabled (see the **RCC** register) or the **RCGCn** register when the auto-clock gating is disabled. The system clock has the same source and frequency as that during Run mode.

- **Deep-Sleep Mode.** In Deep-Sleep mode, the clock frequency of the active peripherals may change (depending on the Run mode clock configuration) in addition to the processor clock being stopped. An interrupt returns the microcontroller to Run mode from one of the sleep modes; the sleep modes are entered on request from the code. Deep-Sleep mode is entered by first writing the Deep Sleep Enable bit in the ARM Cortex-M3 NVIC system control register and then executing a WFI instruction. Any properly configured interrupt event in the system brings the processor back into Run mode. See the system control NVIC section of the *ARM® Cortex™-M3 Technical Reference Manual* for more details.

The Cortex-M3 processor core and the memory subsystem are not clocked. Peripherals are clocked that are enabled in the **DCGCn** register when auto-clock gating is enabled (see the **RCC** register) or the **RCGCn** register when auto-clock gating is disabled. The system clock source is specified in the **DSLCLKCFG** register. When the **DSLCLKCFG** register is used, the internal oscillator source is powered up, if necessary, and other clocks are powered down. If the PLL is running at the time of the WFI instruction, hardware powers the PLL down and overrides the **SYSDIV** field of the active **RCC/RCC2** register, to be determined by the **DSDIVORIDE** setting in the **DSLCLKCFG** register, up to /16 or /64 respectively. When the Deep-Sleep exit event occurs, hardware brings the system clock back to the source and frequency it had at the onset of Deep-Sleep mode before enabling the clocks that had been stopped during the Deep-Sleep duration. If the PIOSC is used as the PLL reference clock source, it may continue to provide the clock during Deep-Sleep. See page 141.

---

**Caution – If the Cortex-M3 Debug Access Port (DAP) has been enabled, and the device wakes from a low power sleep or deep-sleep mode, the core may start executing code before all clocks to peripherals have been restored to their run mode configuration. The DAP is usually enabled by software tools accessing the JTAG or SWD interface when debugging or flash programming. If this condition occurs, a Hard Fault is triggered when software accesses a peripheral with an invalid clock.**

A software delay loop can be used at the beginning of the interrupt routine that is used to wake up a system from a WFI (Wait For Interrupt) instruction. This stalls the execution of any code that accesses a peripheral register that might cause a fault. This loop can be removed for production software as the DAP is most likely not enabled during normal execution.

Because the DAP is disabled by default (power on reset), the user can also power cycle the device. The DAP is not enabled unless it is enabled through the JTAG or SWD interface.

---

## 6.3 Initialization and Configuration

The PLL is configured using direct register writes to the **RCC/RCC2** register. If the **RCC2** register is being used, the **USERCC2** bit must be set and the appropriate **RCC2** bit/field is used. The steps required to successfully change the PLL-based system clock are:

1. Bypass the PLL and system clock divider by setting the **BYPASS** bit and clearing the **USESYS** bit in the **RCC** register, thereby configuring the microcontroller to run off a “raw” clock source and allowing for the new PLL configuration to be validated before switching the system clock to the PLL.
2. Select the crystal value (**XTAL**) and oscillator source (**OSCSRC**), and clear the **PWRDN** bit in **RCC/RCC2**. Setting the **XTAL** field automatically pulls valid PLL configuration data for the appropriate crystal, and clearing the **PWRDN** bit powers and enables the PLL and its output.

3. Select the desired system divider (*SYSDIV*) in **RCC/RCC2** and set the *USESYS* bit in **RCC**. The *SYSDIV* field determines the system frequency for the microcontroller.
4. Wait for the PLL to lock by polling the *PLLLRIS* bit in the **Raw Interrupt Status (RIS)** register.
5. Enable use of the PLL by clearing the *BYPASS* bit in **RCC/RCC2**.

## 6.4 Register Map

Table 6-8 on page 116 lists the System Control registers, grouped by function. The offset listed is a hexadecimal increment to the register's address, relative to the System Control base address of 0x400F.E000.

**Note:** Spaces in the System Control register space that are not used are reserved for future or internal use. Software should not modify any reserved memory address.

Additional Flash and ROM registers defined in the System Control register space are described in the "Internal Memory" on page 209.

**Table 6-8. System Control Register Map**

Offset	Name	Type	Reset	Description	See page
0x000	DID0	RO	-	Device Identification 0	118
0x004	DID1	RO	-	Device Identification 1	146
0x008	DC0	RO	0x017F.007F	Device Capabilities 0	148
0x010	DC1	RO	-	Device Capabilities 1	149
0x014	DC2	RO	0x570F.5337	Device Capabilities 2	152
0x018	DC3	RO	0xBFFF.FFFF	Device Capabilities 3	155
0x01C	DC4	RO	0x5100.F1FF	Device Capabilities 4	158
0x020	DC5	RO	0x0F30.00FF	Device Capabilities 5	160
0x024	DC6	RO	0x0000.0013	Device Capabilities 6	162
0x028	DC7	RO	0xFFFF.FFFF	Device Capabilities 7	163
0x02C	DC8	RO	0xFFFF.FFFF	Device Capabilities 8 ADC Channels	167
0x030	PBORCTL	R/W	0x0000.7FFD	Brown-Out Reset Control	120
0x040	SRCR0	R/W	0x00000000	Software Reset Control 0	202
0x044	SRCR1	R/W	0x00000000	Software Reset Control 1	204
0x048	SRCR2	R/W	0x00000000	Software Reset Control 2	207
0x050	RIS	RO	0x0000.0000	Raw Interrupt Status	121
0x054	IMC	R/W	0x0000.0000	Interrupt Mask Control	123
0x058	MISC	R/W1C	0x0000.0000	Masked Interrupt Status and Clear	125
0x05C	RESC	R/W	-	Reset Cause	127
0x060	RCC	R/W	0x078E.3AD1	Run-Mode Clock Configuration	129

**Table 6-8. System Control Register Map (continued)**

Offset	Name	Type	Reset	Description	See page
0x064	PLLCFG	RO	-	XTAL to PLL Translation	134
0x06C	GPIOHBCTL	R/W	0x0000.0000	GPIO High-Performance Bus Control	135
0x070	RCC2	R/W	0x07C0.6810	Run-Mode Clock Configuration 2	137
0x07C	MOSCCTL	R/W	0x0000.0000	Main Oscillator Control	140
0x100	RCGC0	R/W	0x00000040	Run Mode Clock Gating Control Register 0	173
0x104	RCGC1	R/W	0x00000000	Run Mode Clock Gating Control Register 1	181
0x108	RCGC2	R/W	0x00000000	Run Mode Clock Gating Control Register 2	193
0x110	SCGC0	R/W	0x00000040	Sleep Mode Clock Gating Control Register 0	176
0x114	SCGC1	R/W	0x00000000	Sleep Mode Clock Gating Control Register 1	185
0x118	SCGC2	R/W	0x00000000	Sleep Mode Clock Gating Control Register 2	196
0x120	DCGC0	R/W	0x00000040	Deep Sleep Mode Clock Gating Control Register 0	179
0x124	DCGC1	R/W	0x00000000	Deep-Sleep Mode Clock Gating Control Register 1	189
0x128	DCGC2	R/W	0x00000000	Deep Sleep Mode Clock Gating Control Register 2	199
0x144	DSLPCCLKCFG	R/W	0x0780.0000	Deep Sleep Clock Configuration	141
0x150	PIOSCCAL	R/W	0x0000.0000	Precision Internal Oscillator Calibration	143
0x170	I2SMCLKCFG	R/W	0x0000.0000	I2S MCLK Configuration	144
0x190	DC9	RO	0x00FF.00FF	Device Capabilities 9 ADC Digital Comparators	170
0x1A0	NVMSTAT	RO	0x0000.0011	Non-Volatile Memory Information	172

## 6.5 Register Descriptions

All addresses given are relative to the System Control base address of 0x400F.E000.

## Register 1: Device Identification 0 (DID0), offset 0x000

This register identifies the version of the microcontroller.

### Device Identification 0 (DID0)

Base 0x400F.E000

Offset 0x000

Type RO, reset -

	31	30	29	28	27	26	25	24	23	22	21	20	19	18	17	16
	reserved	VER			reserved				CLASS							
Type	RO	RO	RO	RO	RO	RO	RO	RO	RO	RO	RO	RO	RO	RO	RO	RO
Reset	0	0	0	1	0	0	0	0	0	0	0	0	0	1	0	0
	15	14	13	12	11	10	9	8	7	6	5	4	3	2	1	0
	MAJOR								MINOR							
Type	RO	RO	RO	RO	RO	RO	RO	RO	RO	RO	RO	RO	RO	RO	RO	RO
Reset	-	-	-	-	-	-	-	-	-	-	-	-	-	-	-	-

Bit/Field	Name	Type	Reset	Description				
31	reserved	RO	0	Software should not rely on the value of a reserved bit. To provide compatibility with future products, the value of a reserved bit should be preserved across a read-modify-write operation.				
30:28	VER	RO	0x1	<p>DID0 Version</p> <p>This field defines the <b>DID0</b> register format version. The version number is numeric. The value of the <code>VER</code> field is encoded as follows (all other encodings are reserved):</p> <table border="1"> <thead> <tr> <th>Value</th> <th>Description</th> </tr> </thead> <tbody> <tr> <td>0x1</td> <td>Second version of the <b>DID0</b> register format.</td> </tr> </tbody> </table>	Value	Description	0x1	Second version of the <b>DID0</b> register format.
Value	Description							
0x1	Second version of the <b>DID0</b> register format.							
27:24	reserved	RO	0x0	Software should not rely on the value of a reserved bit. To provide compatibility with future products, the value of a reserved bit should be preserved across a read-modify-write operation.				
23:16	CLASS	RO	0x04	<p>Device Class</p> <p>The <code>CLASS</code> field value identifies the internal design from which all mask sets are generated for all microcontrollers in a particular product line. The <code>CLASS</code> field value is changed for new product lines, for changes in fab process (for example, a remap or shrink), or any case where the <code>MAJOR</code> or <code>MINOR</code> fields require differentiation from prior microcontrollers. The value of the <code>CLASS</code> field is encoded as follows (all other encodings are reserved):</p> <table border="1"> <thead> <tr> <th>Value</th> <th>Description</th> </tr> </thead> <tbody> <tr> <td>0x04</td> <td>Stellaris® Tempest-class microcontrollers</td> </tr> </tbody> </table>	Value	Description	0x04	Stellaris® Tempest-class microcontrollers
Value	Description							
0x04	Stellaris® Tempest-class microcontrollers							

Bit/Field	Name	Type	Reset	Description								
15:8	MAJOR	RO	-	<p>Major Revision</p> <p>This field specifies the major revision number of the microcontroller. The major revision reflects changes to base layers of the design. The major revision number is indicated in the part number as a letter (A for first revision, B for second, and so on). This field is encoded as follows:</p> <table border="1"> <thead> <tr> <th>Value</th> <th>Description</th> </tr> </thead> <tbody> <tr> <td>0x0</td> <td>Revision A (initial device)</td> </tr> <tr> <td>0x1</td> <td>Revision B (first base layer revision)</td> </tr> <tr> <td>0x2</td> <td>Revision C (second base layer revision)</td> </tr> </tbody> </table> <p>and so on.</p>	Value	Description	0x0	Revision A (initial device)	0x1	Revision B (first base layer revision)	0x2	Revision C (second base layer revision)
Value	Description											
0x0	Revision A (initial device)											
0x1	Revision B (first base layer revision)											
0x2	Revision C (second base layer revision)											
7:0	MINOR	RO	-	<p>Minor Revision</p> <p>This field specifies the minor revision number of the microcontroller. The minor revision reflects changes to the metal layers of the design. The MINOR field value is reset when the MAJOR field is changed. This field is numeric and is encoded as follows:</p> <table border="1"> <thead> <tr> <th>Value</th> <th>Description</th> </tr> </thead> <tbody> <tr> <td>0x0</td> <td>Initial device, or a major revision update.</td> </tr> <tr> <td>0x1</td> <td>First metal layer change.</td> </tr> <tr> <td>0x2</td> <td>Second metal layer change.</td> </tr> </tbody> </table> <p>and so on.</p>	Value	Description	0x0	Initial device, or a major revision update.	0x1	First metal layer change.	0x2	Second metal layer change.
Value	Description											
0x0	Initial device, or a major revision update.											
0x1	First metal layer change.											
0x2	Second metal layer change.											

## Register 2: Brown-Out Reset Control (PBORCTL), offset 0x030

This register is responsible for controlling reset conditions after initial power-on reset.

### Brown-Out Reset Control (PBORCTL)

Base 0x400F.E000  
 Offset 0x030  
 Type R/W, reset 0x0000.7FFD

	31	30	29	28	27	26	25	24	23	22	21	20	19	18	17	16	
	reserved																
Type	RO	RO	RO	RO	RO	RO	RO	RO	RO	RO	RO	RO	RO	RO	RO	RO	
Reset	0	0	0	0	0	0	0	0	0	0	0	0	0	0	0	0	
	15	14	13	12	11	10	9	8	7	6	5	4	3	2	1	0	
	reserved															BORIOR	reserved
Type	RO	RO	RO	RO	RO	RO	RO	RO	RO	RO	RO	RO	RO	RO	RO	R/W	RO
Reset	0	0	0	0	0	0	0	0	0	0	0	0	0	0	0	0	0

Bit/Field	Name	Type	Reset	Description
31:2	reserved	RO	0x0000.000	Software should not rely on the value of a reserved bit. To provide compatibility with future products, the value of a reserved bit should be preserved across a read-modify-write operation.
1	BORIOR	R/W	0	BOR Interrupt or Reset  Value Description 0 A Brown Out Event causes an interrupt to be generated to the interrupt controller. 1 A Brown Out Event causes a reset of the microcontroller.
0	reserved	RO	0	Software should not rely on the value of a reserved bit. To provide compatibility with future products, the value of a reserved bit should be preserved across a read-modify-write operation.



### Register 3: Raw Interrupt Status (RIS), offset 0x050

This register indicates the status for system control raw interrupts. An interrupt is sent to the interrupt controller if the corresponding bit in the **Interrupt Mask Control (IMC)** register is set. Writing a 1 to the corresponding bit in the **Masked Interrupt Status and Clear (MISC)** register clears an interrupt status bit.

#### Raw Interrupt Status (RIS)

Base 0x400F.E000

Offset 0x050

Type RO, reset 0x0000.0000

	31	30	29	28	27	26	25	24	23	22	21	20	19	18	17	16
	reserved															
Type	RO	RO	RO	RO	RO	RO	RO	RO	RO	RO	RO	RO	RO	RO	RO	RO
Reset	0	0	0	0	0	0	0	0	0	0	0	0	0	0	0	0
	15	14	13	12	11	10	9	8	7	6	5	4	3	2	1	0
	reserved							MOSCPUPRIS	USBPLLRRIS	PLLLRRIS	reserved				BORRIS	reserved
Type	RO	RO	RO	RO	RO	RO	RO	RO	RO	RO	RO	RO	RO	RO	RO	RO
Reset	0	0	0	0	0	0	0	0	0	0	0	0	0	0	0	0

Bit/Field	Name	Type	Reset	Description
31:9	reserved	RO	0x0000.00	Software should not rely on the value of a reserved bit. To provide compatibility with future products, the value of a reserved bit should be preserved across a read-modify-write operation.
8	MOSCPUPRIS	RO	0	MOSC Power Up Raw Interrupt Status  Value Description 1 Sufficient time has passed for the MOSC to reach the expected frequency. The value for this power-up time is indicated by $T_{MOSC\_SETTLE}$ . 0 Sufficient time has not passed for the MOSC to reach the expected frequency.  This bit is cleared by writing a 1 to the MOSCPUPMIS bit in the <b>MISC</b> register.
7	USBPLLRRIS	RO	0	USB PLL Lock Raw Interrupt Status  Value Description 1 The USB PLL timer has reached $T_{READY}$ indicating that sufficient time has passed for the USB PLL to lock. 0 The USB PLL timer has not reached $T_{READY}$ .  This bit is cleared by writing a 1 to the USBPLLRRMIS bit in the <b>MISC</b> register.
6	PLLLRRIS	RO	0	PLL Lock Raw Interrupt Status  Value Description 1 The PLL timer has reached $T_{READY}$ indicating that sufficient time has passed for the PLL to lock. 0 The PLL timer has not reached $T_{READY}$ .  This bit is cleared by writing a 1 to the PLLRRMIS bit in the <b>MISC</b> register.

Bit/Field	Name	Type	Reset	Description
5:2	reserved	RO	0x0	Software should not rely on the value of a reserved bit. To provide compatibility with future products, the value of a reserved bit should be preserved across a read-modify-write operation.
1	BORRIS	RO	0	<p>Brown-Out Reset Raw Interrupt Status</p> <p>Value Description</p> <p>1 A brown-out condition is currently active.</p> <p>0 A brown-out condition is not currently active.</p> <p>Note the BORIOR bit in the <b>PBORCTL</b> register must be cleared to cause an interrupt due to a Brown Out Event.</p> <p>This bit is cleared by writing a 1 to the BORMIS bit in the <b>MISC</b> register.</p>
0	reserved	RO	0	Software should not rely on the value of a reserved bit. To provide compatibility with future products, the value of a reserved bit should be preserved across a read-modify-write operation.

## Register 4: Interrupt Mask Control (IMC), offset 0x054

This register contains the mask bits for system control raw interrupts. A raw interrupt, indicated by a bit being set in the **Raw Interrupt Status (RIS)** register, is sent to the interrupt controller if the corresponding bit in this register is set.

### Interrupt Mask Control (IMC)

Base 0x400F.E000  
Offset 0x054  
Type R/W, reset 0x0000.0000

	31	30	29	28	27	26	25	24	23	22	21	20	19	18	17	16
	reserved															
Type	RO	RO	RO	RO	RO	RO	RO	RO	RO	RO	RO	RO	RO	RO	RO	RO
Reset	0	0	0	0	0	0	0	0	0	0	0	0	0	0	0	0
	15	14	13	12	11	10	9	8	7	6	5	4	3	2	1	0
	reserved							MOSCPUPIM	USBPLLIM	PLLLIM	reserved				BORIM	reserved
Type	RO	RO	RO	RO	RO	RO	RO	R/W	R/W	R/W	RO	RO	RO	RO	R/W	RO
Reset	0	0	0	0	0	0	0	0	0	0	0	0	0	0	0	0

Bit/Field	Name	Type	Reset	Description
31:9	reserved	RO	0x0000.00	Software should not rely on the value of a reserved bit. To provide compatibility with future products, the value of a reserved bit should be preserved across a read-modify-write operation.
8	MOSCPUPIM	R/W	0	MOSC Power Up Interrupt Mask  Value Description 1 An interrupt is sent to the interrupt controller when the MOSCPUPRIS bit in the <b>RIS</b> register is set. 0 The MOSCPUPRIS interrupt is suppressed and not sent to the interrupt controller.
7	USBPLLIM	R/W	0	USB PLL Lock Interrupt Mask  Value Description 1 An interrupt is sent to the interrupt controller when the USBPLLRRIS bit in the <b>RIS</b> register is set. 0 The USBPLLRRIS interrupt is suppressed and not sent to the interrupt controller.
6	PLLLIM	R/W	0	PLL Lock Interrupt Mask  Value Description 1 An interrupt is sent to the interrupt controller when the PLLRRIS bit in the <b>RIS</b> register is set. 0 The PLLRRIS interrupt is suppressed and not sent to the interrupt controller.
5:2	reserved	RO	0x0	Software should not rely on the value of a reserved bit. To provide compatibility with future products, the value of a reserved bit should be preserved across a read-modify-write operation.

Bit/Field	Name	Type	Reset	Description
1	BORIM	R/W	0	Brown-Out Reset Interrupt Mask  Value Description 1 An interrupt is sent to the interrupt controller when the BORRIS bit in the <b>RIS</b> register is set. 0 The BORRIS interrupt is suppressed and not sent to the interrupt controller.
0	reserved	RO	0	Software should not rely on the value of a reserved bit. To provide compatibility with future products, the value of a reserved bit should be preserved across a read-modify-write operation.

## Register 5: Masked Interrupt Status and Clear (MISC), offset 0x058

On a read, this register gives the current masked status value of the corresponding interrupt in the **Raw Interrupt Status (RIS)** register. All of the bits are R/W1C, thus writing a 1 to a bit clears the corresponding raw interrupt bit in the **RIS** register (see page 121).

### Masked Interrupt Status and Clear (MISC)

Base 0x400F.E000

Offset 0x058

Type R/W1C, reset 0x0000.0000

	31	30	29	28	27	26	25	24	23	22	21	20	19	18	17	16
	reserved															
Type	RO	RO	RO	RO	RO	RO	RO	RO	RO	RO	RO	RO	RO	RO	RO	RO
Reset	0	0	0	0	0	0	0	0	0	0	0	0	0	0	0	0
	15	14	13	12	11	10	9	8	7	6	5	4	3	2	1	0
	reserved							MOSCPUPMIS	USBPLLLMIS	PLLLMIS	reserved				BORMIS	reserved
Type	RO	RO	RO	RO	RO	RO	RO	R/W1C	R/W1C	R/W1C	RO	RO	RO	RO	R/W1C	RO
Reset	0	0	0	0	0	0	0	0	0	0	0	0	0	0	0	0

Bit/Field	Name	Type	Reset	Description
31:9	reserved	RO	0x0000.00	Software should not rely on the value of a reserved bit. To provide compatibility with future products, the value of a reserved bit should be preserved across a read-modify-write operation.
8	MOSCPUPMIS	R/W1C	0	MOSC Power Up Masked Interrupt Status  Value Description 1 When read, a 1 indicates that an unmasked interrupt was signaled because sufficient time has passed for the MOSC PLL to lock. Writing a 1 to this bit clears it and also the <code>MOSCPUPRIS</code> bit in the <b>RIS</b> register. 0 When read, a 0 indicates that sufficient time has not passed for the MOSC PLL to lock. A write of 0 has no effect on the state of this bit.
7	USBPLLLMIS	R/W1C	0	USB PLL Lock Masked Interrupt Status  Value Description 1 When read, a 1 indicates that an unmasked interrupt was signaled because sufficient time has passed for the USB PLL to lock. Writing a 1 to this bit clears it and also the <code>USBPLLLRIS</code> bit in the <b>RIS</b> register. 0 When read, a 0 indicates that sufficient time has not passed for the USB PLL to lock. A write of 0 has no effect on the state of this bit.

Bit/Field	Name	Type	Reset	Description
6	PLLLMIS	R/W1C	0	<p>PLL Lock Masked Interrupt Status</p> <p>Value Description</p> <p>1 When read, a 1 indicates that an unmasked interrupt was signaled because sufficient time has passed for the PLL to lock.</p> <p>Writing a 1 to this bit clears it and also the PLLLRIS bit in the <b>RIS</b> register.</p> <p>0 When read, a 0 indicates that sufficient time has not passed for the PLL to lock.</p> <p>A write of 0 has no effect on the state of this bit.</p>
5:2	reserved	RO	0x0	Software should not rely on the value of a reserved bit. To provide compatibility with future products, the value of a reserved bit should be preserved across a read-modify-write operation.
1	BORMIS	R/W1C	0	<p>BOR Masked Interrupt Status</p> <p>Value Description</p> <p>1 When read, a 1 indicates that an unmasked interrupt was signaled because of a brown-out condition.</p> <p>Writing a 1 to this bit clears it and also the BORRIS bit in the <b>RIS</b> register.</p> <p>0 When read, a 0 indicates that a brown-out condition has not occurred.</p> <p>A write of 0 has no effect on the state of this bit.</p>
0	reserved	RO	0	Software should not rely on the value of a reserved bit. To provide compatibility with future products, the value of a reserved bit should be preserved across a read-modify-write operation.

## Register 6: Reset Cause (RESC), offset 0x05C

This register is set with the reset cause after reset. The bits in this register are sticky and maintain their state across multiple reset sequences, except when an power-on reset is the cause, in which case, all bits other than POR in the **RESC** register are cleared.

### Reset Cause (RESC)

Base 0x400F.E000

Offset 0x05C

Type R/W, reset -

	31	30	29	28	27	26	25	24	23	22	21	20	19	18	17	16
	reserved															MOSCFAIL
Type	RO	RO	RO	RO	RO	RO	RO	RO	RO	RO	RO	RO	RO	RO	RO	RO
Reset	0	0	0	0	0	0	0	0	0	0	0	0	0	0	0	0
	15	14	13	12	11	10	9	8	7	6	5	4	3	2	1	0
	reserved										WDT1	SW	WDT0	BOR	POR	EXT
Type	RO	RO	RO	RO	RO	RO	RO	RO	RO	RO	R/W	R/W	R/W	R/W	R/W	R/W
Reset	0	0	0	0	0	0	0	0	0	0	-	-	-	-	-	-

Bit/Field	Name	Type	Reset	Description
31:17	reserved	RO	0x000	Software should not rely on the value of a reserved bit. To provide compatibility with future products, the value of a reserved bit should be preserved across a read-modify-write operation.
16	MOSCFAIL	R/W	-	MOSC Failure Reset
				Value Description
				1 When read, this bit indicates that the MOSC circuit was enabled for clock validation and failed, generating a reset event.
				0 When read, this bit indicates that a MOSC failure has not generated a reset since the previous power-on reset.
				Writing a 0 to this bit clears it.
15:6	reserved	RO	0x00	Software should not rely on the value of a reserved bit. To provide compatibility with future products, the value of a reserved bit should be preserved across a read-modify-write operation.
5	WDT1	R/W	-	Watchdog Timer 1 Reset
				Value Description
				1 When read, this bit indicates that Watchdog Timer 1 timed out and generated a reset.
				0 When read, this bit indicates that Watchdog Timer 1 has not generated a reset since the previous power-on reset.
				Writing a 0 to this bit clears it.

Bit/Field	Name	Type	Reset	Description
4	SW	R/W	-	<p>Software Reset</p> <p>Value Description</p> <p>1 When read, this bit indicates that a software reset has caused a reset event.</p> <p>0 When read, this bit indicates that a software reset has not generated a reset since the previous power-on reset.</p> <p>Writing a 0 to this bit clears it.</p>
3	WDT0	R/W	-	<p>Watchdog Timer 0 Reset</p> <p>Value Description</p> <p>1 When read, this bit indicates that Watchdog Timer 0 timed out and generated a reset.</p> <p>0 When read, this bit indicates that Watchdog Timer 0 has not generated a reset since the previous power-on reset.</p> <p>Writing a 0 to this bit clears it.</p>
2	BOR	R/W	-	<p>Brown-Out Reset</p> <p>Value Description</p> <p>1 When read, this bit indicates that a brown-out reset has caused a reset event.</p> <p>0 When read, this bit indicates that a brown-out reset has not generated a reset since the previous power-on reset.</p> <p>Writing a 0 to this bit clears it.</p>
1	POR	R/W	-	<p>Power-On Reset</p> <p>Value Description</p> <p>1 When read, this bit indicates that a power-on reset has caused a reset event.</p> <p>0 When read, this bit indicates that a power-on reset has not generated a reset.</p> <p>Writing a 0 to this bit clears it.</p>
0	EXT	R/W	-	<p>External Reset</p> <p>Value Description</p> <p>1 When read, this bit indicates that an external reset (<math>\overline{RST}</math> assertion) has caused a reset event.</p> <p>0 When read, this bit indicates that an external reset (<math>\overline{RST}</math> assertion) has not caused a reset event since the previous power-on reset.</p> <p>Writing a 0 to this bit clears it.</p>



## Register 7: Run-Mode Clock Configuration (RCC), offset 0x060

The bits in this register configure the system clock and oscillators.

### Run-Mode Clock Configuration (RCC)

Base 0x400F.E000

Offset 0x060

Type R/W, reset 0x078E.3AD1

	31	30	29	28	27	26	25	24	23	22	21	20	19	18	17	16
	reserved				ACG	SYSDIV				USESYS DIV	reserved	USEPWMDIV	PWMDIV			reserved
Type	RO	RO	RO	RO	R/W	R/W	R/W	R/W	R/W	R/W	RO	R/W	R/W	R/W	R/W	RO
Reset	0	0	0	0	0	1	1	1	1	0	0	0	1	1	1	0
	15	14	13	12	11	10	9	8	7	6	5	4	3	2	1	0
	reserved		PWRDN	reserved	BYPASS	XTAL				OSCSRC		reserved		IOSCDIS	MOSCDIS	
Type	RO	RO	R/W	RO	R/W	R/W	R/W	R/W	R/W	R/W	R/W	R/W	RO	RO	R/W	R/W
Reset	0	0	1	1	1	0	1	0	1	1	0	1	0	0	0	1

Bit/Field	Name	Type	Reset	Description
31:28	reserved	RO	0x0	Software should not rely on the value of a reserved bit. To provide compatibility with future products, the value of a reserved bit should be preserved across a read-modify-write operation.
27	ACG	R/W	0	<p>Auto Clock Gating</p> <p>This bit specifies whether the system uses the <b>Sleep-Mode Clock Gating Control (SCGCn)</b> registers and <b>Deep-Sleep-Mode Clock Gating Control (DCGCn)</b> registers if the microcontroller enters a Sleep or Deep-Sleep mode (respectively).</p> <p>Value Description</p> <p>1 The <b>SCGCn</b> or <b>DCGCn</b> registers are used to control the clocks distributed to the peripherals when the microcontroller is in a sleep mode. The <b>SCGCn</b> and <b>DCGCn</b> registers allow unused peripherals to consume less power when the microcontroller is in a sleep mode.</p> <p>0 The <b>Run-Mode Clock Gating Control (RCGCn)</b> registers are used when the microcontroller enters a sleep mode.</p> <p>The <b>RCGCn</b> registers are always used to control the clocks in Run mode.</p>
26:23	SYSDIV	R/W	0xF	<p>System Clock Divisor</p> <p>Specifies which divisor is used to generate the system clock from either the PLL output or the oscillator source (depending on how the <b>BYPASS</b> bit in this register is configured). See Table 6-5 on page 111 for bit encodings.</p> <p>If the <b>SYSDIV</b> value is less than <b>MINSYSDIV</b> (see page 149), and the PLL is being used, then the <b>MINSYSDIV</b> value is used as the divisor.</p> <p>If the PLL is not being used, the <b>SYSDIV</b> value can be less than <b>MINSYSDIV</b>.</p>

Bit/Field	Name	Type	Reset	Description
22	USESYSCLKDIV	R/W	0	<p>Enable System Clock Divider</p> <p>Value Description</p> <p>1 The system clock divider is the source for the system clock. The system clock divider is forced to be used when the PLL is selected as the source.</p> <p>If the <code>USERCC2</code> bit in the <code>RCC2</code> register is set, then the <code>SYSDIV2</code> field in the <code>RCC2</code> register is used as the system clock divider rather than the <code>SYSDIV</code> field in this register.</p> <p>0 The system clock is used undivided.</p>
21	reserved	RO	0	Software should not rely on the value of a reserved bit. To provide compatibility with future products, the value of a reserved bit should be preserved across a read-modify-write operation.
20	USEPWMDIV	R/W	0	<p>Enable PWM Clock Divisor</p> <p>Value Description</p> <p>1 The PWM clock divider is the source for the PWM clock.</p> <p>0 The system clock is the source for the PWM clock.</p>
19:17	PWMDIV	R/W	0x7	<p>PWM Unit Clock Divisor</p> <p>This field specifies the binary divisor used to predivide the system clock down for use as the timing reference for the PWM module. The rising edge of this clock is synchronous with the system clock.</p> <p>Value Divisor</p> <p>0x0 /2</p> <p>0x1 /4</p> <p>0x2 /8</p> <p>0x3 /16</p> <p>0x4 /32</p> <p>0x5 /64</p> <p>0x6 /64</p> <p>0x7 /64 (default)</p>
16:14	reserved	RO	0x0	Software should not rely on the value of a reserved bit. To provide compatibility with future products, the value of a reserved bit should be preserved across a read-modify-write operation.
13	PWRDN	R/W	1	<p>PLL Power Down</p> <p>Value Description</p> <p>1 The PLL is powered down. Care must be taken to ensure that another clock source is functioning and that the <code>BYPASS</code> bit is set before setting this bit.</p> <p>0 The PLL is operating normally.</p>

Bit/Field	Name	Type	Reset	Description
12	reserved	RO	1	Software should not rely on the value of a reserved bit. To provide compatibility with future products, the value of a reserved bit should be preserved across a read-modify-write operation.

11	BYPASS	R/W	1	PLL Bypass
----	--------	-----	---	------------

Value Description

1 The system clock is derived from the OSC source and divided by the divisor specified by *SYSDIV*.

0 The system clock is the PLL output clock divided by the divisor specified by *SYSDIV*.

See Table 6-5 on page 111 for programming guidelines.

**Note:** The ADC must be clocked from the PLL or directly from a 16-MHz clock source to operate properly.

Bit/Field	Name	Type	Reset	Description																																																																								
10:6	XTAL	R/W	0x0B	<p>Crystal Value</p> <p>This field specifies the crystal value attached to the main oscillator. The encoding for this field is provided below. Depending on the crystal used, the PLL frequency may not be exactly 400 MHz, see Table 27-10 on page 1208 for more information.</p> <p>Frequencies that may be used with the USB interface are indicated in the table. To function within the clocking requirements of the USB specification, a crystal of 4, 5, 6, 8, 10, 12, or 16 MHz must be used.</p> <table border="1"> <thead> <tr> <th>Value</th> <th>Crystal Frequency (MHz) Not Using the PLL</th> <th>Crystal Frequency (MHz) Using the PLL</th> </tr> </thead> <tbody> <tr> <td>0x00</td> <td>1.000</td> <td>reserved</td> </tr> <tr> <td>0x01</td> <td>1.8432</td> <td>reserved</td> </tr> <tr> <td>0x02</td> <td>2.000</td> <td>reserved</td> </tr> <tr> <td>0x03</td> <td>2.4576</td> <td>reserved</td> </tr> <tr> <td>0x04</td> <td></td> <td>3.579545 MHz</td> </tr> <tr> <td>0x05</td> <td></td> <td>3.6864 MHz</td> </tr> <tr> <td>0x06</td> <td></td> <td>4 MHz (USB)</td> </tr> <tr> <td>0x07</td> <td></td> <td>4.096 MHz</td> </tr> <tr> <td>0x08</td> <td></td> <td>4.9152 MHz</td> </tr> <tr> <td>0x09</td> <td></td> <td>5 MHz (USB)</td> </tr> <tr> <td>0x0A</td> <td></td> <td>5.12 MHz</td> </tr> <tr> <td>0x0B</td> <td></td> <td>6 MHz (reset value)(USB)</td> </tr> <tr> <td>0x0C</td> <td></td> <td>6.144 MHz</td> </tr> <tr> <td>0x0D</td> <td></td> <td>7.3728 MHz</td> </tr> <tr> <td>0x0E</td> <td></td> <td>8 MHz (USB)</td> </tr> <tr> <td>0x0F</td> <td></td> <td>8.192 MHz</td> </tr> <tr> <td>0x10</td> <td></td> <td>10.0 MHz (USB)</td> </tr> <tr> <td>0x11</td> <td></td> <td>12.0 MHz (USB)</td> </tr> <tr> <td>0x12</td> <td></td> <td>12.288 MHz</td> </tr> <tr> <td>0x13</td> <td></td> <td>13.56 MHz</td> </tr> <tr> <td>0x14</td> <td></td> <td>14.31818 MHz</td> </tr> <tr> <td>0x15</td> <td></td> <td>16.0 MHz (USB)</td> </tr> <tr> <td>0x16</td> <td></td> <td>16.384 MHz</td> </tr> </tbody> </table>	Value	Crystal Frequency (MHz) Not Using the PLL	Crystal Frequency (MHz) Using the PLL	0x00	1.000	reserved	0x01	1.8432	reserved	0x02	2.000	reserved	0x03	2.4576	reserved	0x04		3.579545 MHz	0x05		3.6864 MHz	0x06		4 MHz (USB)	0x07		4.096 MHz	0x08		4.9152 MHz	0x09		5 MHz (USB)	0x0A		5.12 MHz	0x0B		6 MHz (reset value)(USB)	0x0C		6.144 MHz	0x0D		7.3728 MHz	0x0E		8 MHz (USB)	0x0F		8.192 MHz	0x10		10.0 MHz (USB)	0x11		12.0 MHz (USB)	0x12		12.288 MHz	0x13		13.56 MHz	0x14		14.31818 MHz	0x15		16.0 MHz (USB)	0x16		16.384 MHz
Value	Crystal Frequency (MHz) Not Using the PLL	Crystal Frequency (MHz) Using the PLL																																																																										
0x00	1.000	reserved																																																																										
0x01	1.8432	reserved																																																																										
0x02	2.000	reserved																																																																										
0x03	2.4576	reserved																																																																										
0x04		3.579545 MHz																																																																										
0x05		3.6864 MHz																																																																										
0x06		4 MHz (USB)																																																																										
0x07		4.096 MHz																																																																										
0x08		4.9152 MHz																																																																										
0x09		5 MHz (USB)																																																																										
0x0A		5.12 MHz																																																																										
0x0B		6 MHz (reset value)(USB)																																																																										
0x0C		6.144 MHz																																																																										
0x0D		7.3728 MHz																																																																										
0x0E		8 MHz (USB)																																																																										
0x0F		8.192 MHz																																																																										
0x10		10.0 MHz (USB)																																																																										
0x11		12.0 MHz (USB)																																																																										
0x12		12.288 MHz																																																																										
0x13		13.56 MHz																																																																										
0x14		14.31818 MHz																																																																										
0x15		16.0 MHz (USB)																																																																										
0x16		16.384 MHz																																																																										

Bit/Field	Name	Type	Reset	Description										
5:4	OSCSRC	R/W	0x1	<p>Oscillator Source</p> <p>Selects the input source for the OSC. The values are:</p> <table border="1"> <thead> <tr> <th>Value</th> <th>Input Source</th> </tr> </thead> <tbody> <tr> <td>0x0</td> <td>MOSC Main oscillator</td> </tr> <tr> <td>0x1</td> <td>PIOSC Precision internal oscillator (default)</td> </tr> <tr> <td>0x2</td> <td>PIOSC/4 Precision internal oscillator / 4</td> </tr> <tr> <td>0x3</td> <td>30 kHz 30-kHz internal oscillator</td> </tr> </tbody> </table> <p>For additional oscillator sources, see the <b>RCC2</b> register.</p>	Value	Input Source	0x0	MOSC Main oscillator	0x1	PIOSC Precision internal oscillator (default)	0x2	PIOSC/4 Precision internal oscillator / 4	0x3	30 kHz 30-kHz internal oscillator
Value	Input Source													
0x0	MOSC Main oscillator													
0x1	PIOSC Precision internal oscillator (default)													
0x2	PIOSC/4 Precision internal oscillator / 4													
0x3	30 kHz 30-kHz internal oscillator													
3:2	reserved	RO	0x0	Software should not rely on the value of a reserved bit. To provide compatibility with future products, the value of a reserved bit should be preserved across a read-modify-write operation.										
1	IOSCDIS	R/W	0	<p>Precision Internal Oscillator Disable</p> <table border="1"> <thead> <tr> <th>Value</th> <th>Description</th> </tr> </thead> <tbody> <tr> <td>1</td> <td>The precision internal oscillator (PIOSC) is disabled.</td> </tr> <tr> <td>0</td> <td>The precision internal oscillator is enabled.</td> </tr> </tbody> </table>	Value	Description	1	The precision internal oscillator (PIOSC) is disabled.	0	The precision internal oscillator is enabled.				
Value	Description													
1	The precision internal oscillator (PIOSC) is disabled.													
0	The precision internal oscillator is enabled.													
0	MOSCDIS	R/W	1	<p>Main Oscillator Disable</p> <table border="1"> <thead> <tr> <th>Value</th> <th>Description</th> </tr> </thead> <tbody> <tr> <td>1</td> <td>The main oscillator is disabled (default).</td> </tr> <tr> <td>0</td> <td>The main oscillator is enabled.</td> </tr> </tbody> </table>	Value	Description	1	The main oscillator is disabled (default).	0	The main oscillator is enabled.				
Value	Description													
1	The main oscillator is disabled (default).													
0	The main oscillator is enabled.													

### Register 8: XTAL to PLL Translation (PLLCFG), offset 0x064

This register provides a means of translating external crystal frequencies into the appropriate PLL settings. This register is initialized during the reset sequence and updated anytime that the XTAL field changes in the Run-Mode Clock Configuration (RCC) register (see page 129).

The PLL frequency is calculated using the PLLCFG field values, as follows:

$$PLLFreq = OSCFreq * F / (R + 1)$$

#### XTAL to PLL Translation (PLLCFG)

Base 0x400F.E000

Offset 0x064

Type RO, reset -

	31	30	29	28	27	26	25	24	23	22	21	20	19	18	17	16
	reserved															
Type	RO	RO	RO	RO	RO	RO	RO	RO	RO	RO	RO	RO	RO	RO	RO	RO
Reset	0	0	0	0	0	0	0	0	0	0	0	0	0	0	0	0
	15	14	13	12	11	10	9	8	7	6	5	4	3	2	1	0
	reserved		F										R			
Type	RO	RO	RO	RO	RO	RO	RO	RO	RO	RO	RO	RO	RO	RO	RO	RO
Reset	0	0	-	-	-	-	-	-	-	-	-	-	-	-	-	-

Bit/Field	Name	Type	Reset	Description
31:14	reserved	RO	0x0000.0	Software should not rely on the value of a reserved bit. To provide compatibility with future products, the value of a reserved bit should be preserved across a read-modify-write operation.
13:5	F	RO	-	PLL F Value This field specifies the value supplied to the PLL's F input.
4:0	R	RO	-	PLL R Value This field specifies the value supplied to the PLL's R input.

**Register 9: GPIO High-Performance Bus Control (GPIOHBCTL), offset 0x06C**

This register controls which internal bus is used to access each GPIO port. When a bit is clear, the corresponding GPIO port is accessed across the legacy Advanced Peripheral Bus (APB) bus and through the APB memory aperture. When a bit is set, the corresponding port is accessed across the Advanced High-Performance Bus (AHB) bus and through the AHB memory aperture. Each GPIO port can be individually configured to use AHB or APB, but may be accessed only through one aperture. The AHB bus provides better back-to-back access performance than the APB bus. The address aperture in the memory map changes for the ports that are enabled for AHB access (see Table 9-7 on page 316).

**GPIO High-Performance Bus Control (GPIOHBCTL)**

Base 0x400F.E000

Offset 0x06C

Type R/W, reset 0x0000.0000

	31	30	29	28	27	26	25	24	23	22	21	20	19	18	17	16
	reserved															
Type	RO	RO	RO	RO	RO	RO	RO	RO	RO	RO	RO	RO	RO	RO	RO	RO
Reset	0	0	0	0	0	0	0	0	0	0	0	0	0	0	0	0
	15	14	13	12	11	10	9	8	7	6	5	4	3	2	1	0
	reserved							PORTJ	PORTH	PORTG	PORTF	PORTE	PORTD	PORTC	PORTB	PORTA
Type	RO	RO	RO	RO	RO	RO	RO	R/W	R/W	R/W	R/W	R/W	R/W	R/W	R/W	R/W
Reset	0	0	0	0	0	0	0	0	0	0	0	0	0	0	0	0

Bit/Field	Name	Type	Reset	Description
31:9	reserved	RO	0x0000.0	Software should not rely on the value of a reserved bit. To provide compatibility with future products, the value of a reserved bit should be preserved across a read-modify-write operation.
8	PORTJ	R/W	0	Port J Advanced High-Performance Bus This bit defines the memory aperture for Port J.  Value Description 1 Advanced High-Performance Bus (AHB) 0 Advanced Peripheral Bus (APB). This bus is the legacy bus.
7	PORTH	R/W	0	Port H Advanced High-Performance Bus This bit defines the memory aperture for Port H.  Value Description 1 Advanced High-Performance Bus (AHB) 0 Advanced Peripheral Bus (APB). This bus is the legacy bus.
6	PORTG	R/W	0	Port G Advanced High-Performance Bus This bit defines the memory aperture for Port G.  Value Description 1 Advanced High-Performance Bus (AHB) 0 Advanced Peripheral Bus (APB). This bus is the legacy bus.

Bit/Field	Name	Type	Reset	Description
5	PORTF	R/W	0	<p>Port F Advanced High-Performance Bus</p> <p>This bit defines the memory aperture for Port F.</p> <p>Value Description</p> <p>1 Advanced High-Performance Bus (AHB)</p> <p>0 Advanced Peripheral Bus (APB). This bus is the legacy bus.</p>
4	PORTE	R/W	0	<p>Port E Advanced High-Performance Bus</p> <p>This bit defines the memory aperture for Port E.</p> <p>Value Description</p> <p>1 Advanced High-Performance Bus (AHB)</p> <p>0 Advanced Peripheral Bus (APB). This bus is the legacy bus.</p>
3	PORTD	R/W	0	<p>Port D Advanced High-Performance Bus</p> <p>This bit defines the memory aperture for Port D.</p> <p>Value Description</p> <p>1 Advanced High-Performance Bus (AHB)</p> <p>0 Advanced Peripheral Bus (APB). This bus is the legacy bus.</p>
2	PORTC	R/W	0	<p>Port C Advanced High-Performance Bus</p> <p>This bit defines the memory aperture for Port C.</p> <p>Value Description</p> <p>1 Advanced High-Performance Bus (AHB)</p> <p>0 Advanced Peripheral Bus (APB). This bus is the legacy bus.</p>
1	PORTB	R/W	0	<p>Port B Advanced High-Performance Bus</p> <p>This bit defines the memory aperture for Port B.</p> <p>Value Description</p> <p>1 Advanced High-Performance Bus (AHB)</p> <p>0 Advanced Peripheral Bus (APB). This bus is the legacy bus.</p>
0	PORTA	R/W	0	<p>Port A Advanced High-Performance Bus</p> <p>This bit defines the memory aperture for Port A.</p> <p>Value Description</p> <p>1 Advanced High-Performance Bus (AHB)</p> <p>0 Advanced Peripheral Bus (APB). This bus is the legacy bus.</p>



## Register 10: Run-Mode Clock Configuration 2 (RCC2), offset 0x070

This register overrides the **RCC** equivalent register fields, as shown in Table 6-9, when the `USERCC2` bit is set, allowing the extended capabilities of the **RCC2** register to be used while also providing a means to be backward-compatible to previous parts. Each **RCC2** field that supersedes an **RCC** field is located at the same LSB bit position; however, some **RCC2** fields are larger than the corresponding **RCC** field.

**Table 6-9. RCC2 Fields that Override RCC fields**

RCC2 Field...	Overrides RCC Field
<code>SYSDIV2</code> , bits[28:23]	<code>SYSDIV</code> , bits[26:23]
<code>PWRDN2</code> , bit[13]	<code>PWRDN</code> , bit[13]
<code>BYPASS2</code> , bit[11]	<code>BYPASS</code> , bit[11]
<code>OSCSRC2</code> , bits[6:4]	<code>OSCSRC</code> , bits[5:4]

### Run-Mode Clock Configuration 2 (RCC2)

Base 0x400F.E000

Offset 0x070

Type R/W, reset 0x07C0.6810

	31	30	29	28	27	26	25	24	23	22	21	20	19	18	17	16	
	USERCC2	DIV400	reserved	SYSDIV2							SYSDIV2LSB	reserved					
Type	R/W	R/W	RO	R/W	R/W	R/W	R/W	R/W	R/W	R/W	RO	RO	RO	RO	RO	RO	
Reset	0	0	0	0	0	1	1	1	1	1	0	0	0	0	0	0	
	15	14	13	12	11	10	9	8	7	6	5	4	3	2	1	0	
	reserved	USBPWRDN	PWRDN2	reserved	BYPASS2	reserved				OSCSRC2			reserved				
Type	RO	R/W	R/W	RO	R/W	RO	RO	RO	RO	R/W	R/W	R/W	RO	RO	RO	RO	
Reset	0	1	1	0	1	0	0	0	0	0	0	1	0	0	0	0	

Bit/Field	Name	Type	Reset	Description
31	USERCC2	R/W	0	Use <b>RCC2</b>
				Value Description
				1 The <b>RCC2</b> register fields override the <b>RCC</b> register fields.
				0 The <b>RCC</b> register fields are used, and the fields in <b>RCC2</b> are ignored.
30	DIV400	R/W	0	Divide PLL as 400 MHz vs. 200 MHz
				This bit, along with the <code>SYSDIV2LSB</code> bit, allows additional frequency choices.
				Value Description
				1 Append the <code>SYSDIV2LSB</code> bit to the <code>SYSDIV2</code> field to create a 7 bit divisor using the 400 MHz PLL output, see Table 6-7 on page 112.
				0 Use <code>SYSDIV2</code> as is and apply to 200 MHz predivided PLL output. See Table 6-6 on page 111 for programming guidelines.
29	reserved	RO	0x0	Software should not rely on the value of a reserved bit. To provide compatibility with future products, the value of a reserved bit should be preserved across a read-modify-write operation.

Bit/Field	Name	Type	Reset	Description						
28:23	SYSDIV2	R/W	0x0F	<p>System Clock Divisor 2</p> <p>Specifies which divisor is used to generate the system clock from either the PLL output or the oscillator source (depending on how the <code>BYPASS2</code> bit is configured). <code>SYSDIV2</code> is used for the divisor when both the <code>USESYSYSDIV</code> bit in the <b>RCC</b> register and the <code>USERCC2</code> bit in this register are set. See Table 6-6 on page 111 for programming guidelines.</p>						
22	SYSDIV2LSB	R/W	1	<p>Additional LSB for <code>SYSDIV2</code></p> <p>When <code>DIV400</code> is set, this bit becomes the LSB of <code>SYSDIV2</code>. If <code>DIV400</code> is clear, this bit is not used. See Table 6-6 on page 111 for programming guidelines.</p> <p>This bit can only be set or cleared when <code>DIV400</code> is set.</p>						
21:15	reserved	RO	0x0	Software should not rely on the value of a reserved bit. To provide compatibility with future products, the value of a reserved bit should be preserved across a read-modify-write operation.						
14	USBPWRDN	R/W	1	<p>Power-Down USB PLL</p> <table border="0"> <thead> <tr> <th>Value</th> <th>Description</th> </tr> </thead> <tbody> <tr> <td>1</td> <td>The USB PLL is powered down.</td> </tr> <tr> <td>0</td> <td>The USB PLL operates normally.</td> </tr> </tbody> </table>	Value	Description	1	The USB PLL is powered down.	0	The USB PLL operates normally.
Value	Description									
1	The USB PLL is powered down.									
0	The USB PLL operates normally.									
13	PWRDN2	R/W	1	<p>Power-Down PLL 2</p> <table border="0"> <thead> <tr> <th>Value</th> <th>Description</th> </tr> </thead> <tbody> <tr> <td>1</td> <td>The PLL is powered down.</td> </tr> <tr> <td>0</td> <td>The PLL operates normally.</td> </tr> </tbody> </table>	Value	Description	1	The PLL is powered down.	0	The PLL operates normally.
Value	Description									
1	The PLL is powered down.									
0	The PLL operates normally.									
12	reserved	RO	0	Software should not rely on the value of a reserved bit. To provide compatibility with future products, the value of a reserved bit should be preserved across a read-modify-write operation.						
11	BYPASS2	R/W	1	<p>PLL Bypass 2</p> <table border="0"> <thead> <tr> <th>Value</th> <th>Description</th> </tr> </thead> <tbody> <tr> <td>1</td> <td>The system clock is derived from the OSC source and divided by the divisor specified by <code>SYSDIV2</code>.</td> </tr> <tr> <td>0</td> <td>The system clock is the PLL output clock divided by the divisor specified by <code>SYSDIV2</code>.</td> </tr> </tbody> </table> <p>See Table 6-6 on page 111 for programming guidelines.</p> <p><b>Note:</b> The ADC must be clocked from the PLL or directly from a 16-MHz clock source to operate properly.</p>	Value	Description	1	The system clock is derived from the OSC source and divided by the divisor specified by <code>SYSDIV2</code> .	0	The system clock is the PLL output clock divided by the divisor specified by <code>SYSDIV2</code> .
Value	Description									
1	The system clock is derived from the OSC source and divided by the divisor specified by <code>SYSDIV2</code> .									
0	The system clock is the PLL output clock divided by the divisor specified by <code>SYSDIV2</code> .									
10:7	reserved	RO	0x0	Software should not rely on the value of a reserved bit. To provide compatibility with future products, the value of a reserved bit should be preserved across a read-modify-write operation.						

Bit/Field	Name	Type	Reset	Description												
6:4	OSCSRC2	R/W	0x1	<p>Oscillator Source 2</p> <p>Selects the input source for the OSC. The values are:</p> <table border="1"> <thead> <tr> <th>Value</th> <th>Description</th> </tr> </thead> <tbody> <tr> <td>0x0</td> <td>MOSC Main oscillator</td> </tr> <tr> <td>0x1</td> <td>PIOSC Precision internal oscillator</td> </tr> <tr> <td>0x2</td> <td>PIOSC/4 Precision internal oscillator / 4</td> </tr> <tr> <td>0x3</td> <td>30 kHz 30-kHz internal oscillator</td> </tr> <tr> <td>0x4-0x7</td> <td>Reserved</td> </tr> </tbody> </table>	Value	Description	0x0	MOSC Main oscillator	0x1	PIOSC Precision internal oscillator	0x2	PIOSC/4 Precision internal oscillator / 4	0x3	30 kHz 30-kHz internal oscillator	0x4-0x7	Reserved
Value	Description															
0x0	MOSC Main oscillator															
0x1	PIOSC Precision internal oscillator															
0x2	PIOSC/4 Precision internal oscillator / 4															
0x3	30 kHz 30-kHz internal oscillator															
0x4-0x7	Reserved															
3:0	reserved	RO	0x0	Software should not rely on the value of a reserved bit. To provide compatibility with future products, the value of a reserved bit should be preserved across a read-modify-write operation.												

### Register 11: Main Oscillator Control (MOSCCTL), offset 0x07C

This register provides the ability to enable the MOSC clock verification circuit. When enabled, this circuit monitors the frequency of the MOSC to verify that the oscillator is operating within specified limits. If the clock goes invalid after being enabled, the microcontroller issues a power-on reset and reboots to the NMI handler.

#### Main Oscillator Control (MOSCCTL)

Base 0x400F.E000  
 Offset 0x07C  
 Type R/W, reset 0x0000.0000

	31	30	29	28	27	26	25	24	23	22	21	20	19	18	17	16
	reserved															
Type	RO	RO	RO	RO	RO	RO	RO	RO	RO	RO	RO	RO	RO	RO	RO	RO
Reset	0	0	0	0	0	0	0	0	0	0	0	0	0	0	0	0
	15	14	13	12	11	10	9	8	7	6	5	4	3	2	1	0
	reserved															CVAL
Type	RO	RO	RO	RO	RO	RO	RO	RO	RO	RO	RO	RO	RO	RO	RO	R/W
Reset	0	0	0	0	0	0	0	0	0	0	0	0	0	0	0	0

Bit/Field	Name	Type	Reset	Description
31:1	reserved	RO	0x0000.000	Software should not rely on the value of a reserved bit. To provide compatibility with future products, the value of a reserved bit should be preserved across a read-modify-write operation.
0	CVAL	R/W	0	Clock Validation for MOSC
				Value Description
				1 The MOSC monitor circuit is enabled.
				0 The MOSC monitor circuit is disabled.

## Register 12: Deep Sleep Clock Configuration (DSLPCCLKCFG), offset 0x144

This register provides configuration information for the hardware control of Deep Sleep Mode.

### Deep Sleep Clock Configuration (DSLPCCLKCFG)

Base 0x400F.E000

Offset 0x144

Type R/W, reset 0x0780.0000

	31	30	29	28	27	26	25	24	23	22	21	20	19	18	17	16
	reserved			DSDIVORIDE						reserved						
Type	RO	RO	RO	R/W	R/W	R/W	R/W	R/W	R/W	RO	RO	RO	RO	RO	RO	RO
Reset	0	0	0	0	0	1	1	1	1	0	0	0	0	0	0	0
	15	14	13	12	11	10	9	8	7	6	5	4	3	2	1	0
	reserved						DSOSCSRC				reserved					
Type	RO	RO	RO	RO	RO	RO	RO	RO	RO	R/W	R/W	R/W	RO	RO	RO	RO
Reset	0	0	0	0	0	0	0	0	0	0	0	0	0	0	0	0

Bit/Field	Name	Type	Reset	Description														
31:29	reserved	RO	0x0	Software should not rely on the value of a reserved bit. To provide compatibility with future products, the value of a reserved bit should be preserved across a read-modify-write operation.														
28:23	DSDIVORIDE	R/W	0x0F	<p>Divider Field Override</p> <p>If Deep-Sleep mode is enabled when the PLL is running, the PLL is disabled. This 6-bit field contains a system divider field that overrides the <code>SYSDIV</code> field in the <b>RCC</b> register or the <code>SYSDIV2</code> field in the <b>RCC2</b> register during Deep Sleep. This divider is applied to the source selected by the <b>DSOSCSRC</b> field.</p> <table border="1"> <thead> <tr> <th>Value</th> <th>Description</th> </tr> </thead> <tbody> <tr> <td>0x0</td> <td>/1</td> </tr> <tr> <td>0x1</td> <td>/2</td> </tr> <tr> <td>0x2</td> <td>/3</td> </tr> <tr> <td>0x3</td> <td>/4</td> </tr> <tr> <td>...</td> <td>...</td> </tr> <tr> <td>0x3F</td> <td>/64</td> </tr> </tbody> </table>	Value	Description	0x0	/1	0x1	/2	0x2	/3	0x3	/4	...	...	0x3F	/64
Value	Description																	
0x0	/1																	
0x1	/2																	
0x2	/3																	
0x3	/4																	
...	...																	
0x3F	/64																	
22:7	reserved	RO	0x000	Software should not rely on the value of a reserved bit. To provide compatibility with future products, the value of a reserved bit should be preserved across a read-modify-write operation.														

Bit/Field	Name	Type	Reset	Description												
6:4	DSOSCSRC	R/W	0x0	<p>Clock Source</p> <p>Specifies the clock source during Deep-Sleep mode.</p> <table border="1"> <thead> <tr> <th>Value</th> <th>Description</th> </tr> </thead> <tbody> <tr> <td>0x0</td> <td> <p>MOSC</p> <p>Use the main oscillator as the source.</p> <p><b>Note:</b> If the PIOSC is being used as the clock reference for the PLL, the PIOSC is the clock source instead of MOSC in Deep-Sleep mode.</p> </td> </tr> <tr> <td>0x1</td> <td> <p>PIOSC</p> <p>Use the precision internal 16-MHz oscillator as the source.</p> </td> </tr> <tr> <td>0x2</td> <td>Reserved</td> </tr> <tr> <td>0x3</td> <td> <p>30 kHz</p> <p>Use the 30-kHz internal oscillator as the source.</p> </td> </tr> <tr> <td>0x4-0x7</td> <td>Reserved</td> </tr> </tbody> </table>	Value	Description	0x0	<p>MOSC</p> <p>Use the main oscillator as the source.</p> <p><b>Note:</b> If the PIOSC is being used as the clock reference for the PLL, the PIOSC is the clock source instead of MOSC in Deep-Sleep mode.</p>	0x1	<p>PIOSC</p> <p>Use the precision internal 16-MHz oscillator as the source.</p>	0x2	Reserved	0x3	<p>30 kHz</p> <p>Use the 30-kHz internal oscillator as the source.</p>	0x4-0x7	Reserved
Value	Description															
0x0	<p>MOSC</p> <p>Use the main oscillator as the source.</p> <p><b>Note:</b> If the PIOSC is being used as the clock reference for the PLL, the PIOSC is the clock source instead of MOSC in Deep-Sleep mode.</p>															
0x1	<p>PIOSC</p> <p>Use the precision internal 16-MHz oscillator as the source.</p>															
0x2	Reserved															
0x3	<p>30 kHz</p> <p>Use the 30-kHz internal oscillator as the source.</p>															
0x4-0x7	Reserved															
3:0	reserved	RO	0x0	Software should not rely on the value of a reserved bit. To provide compatibility with future products, the value of a reserved bit should be preserved across a read-modify-write operation.												

**Register 13: Precision Internal Oscillator Calibration (PIOSCCAL), offset 0x150**

This register provides the ability to update or recalibrate the precision internal oscillator.

## Precision Internal Oscillator Calibration (PIOSCCAL)

Base 0x400F.E000

Offset 0x150

Type R/W, reset 0x0000.0000

	31	30	29	28	27	26	25	24	23	22	21	20	19	18	17	16
	UTEN	reserved														
Type	R/W	RO	RO	RO	RO	RO	RO	RO	RO	RO	RO	RO	RO	RO	RO	RO
Reset	0	0	0	0	0	0	0	0	0	0	0	0	0	0	0	0
	15	14	13	12	11	10	9	8	7	6	5	4	3	2	1	0
	reserved							UPDATE	reserved	UT						
Type	RO	RO	RO	RO	RO	RO	RO	R/W	RO	R/W	R/W	R/W	R/W	R/W	R/W	R/W
Reset	0	0	0	0	0	0	0	0	0	0	0	0	0	0	0	0

Bit/Field	Name	Type	Reset	Description
31	UTEN	R/W	0	Use User Trim Value  Value Description 1 The trim value in bits[6:0] of this register are used for any update trim operation. 0 The factory calibration value is used for an update trim operation.
30:9	reserved	RO	0x0000	Software should not rely on the value of a reserved bit. To provide compatibility with future products, the value of a reserved bit should be preserved across a read-modify-write operation.
8	UPDATE	R/W	0	Update Trim  Value Description 1 Updates the PIOSC trim value with the <b>UT</b> bit or the <b>DT</b> bit in the <b>PIOSCSTAT</b> register. Used with <b>UTEN</b> . 0 No action.  This bit is auto-cleared after the update.
7	reserved	RO	0	Software should not rely on the value of a reserved bit. To provide compatibility with future products, the value of a reserved bit should be preserved across a read-modify-write operation.
6:0	UT	R/W	0x0	User Trim Value  User trim value that can be loaded into the PIOSC.  Refer to "Main PLL Frequency Configuration" on page 113 for more information on calibrating the PIOSC.

### Register 14: I<sup>2</sup>S MCLK Configuration (I2SMCLKCFG), offset 0x170

This register configures the receive and transmit fractional clock dividers for the for the I<sup>2</sup>S master transmit and receive clocks (I2S0TXMCLK and I2S0RXMCLK) . Varying the integer and fractional inputs for the clocks allows greater accuracy in hitting the target I<sup>2</sup>S clock frequencies. Refer to “Clock Control” on page 730 for combinations of the TXI and TXF bits and the RXI and RXF bits that provide MCLK frequencies within acceptable error limits.

#### I2S MCLK Configuration (I2SMCLKCFG)

Base 0x400F.E000  
 Offset 0x170  
 Type R/W, reset 0x0000.0000

	31	30	29	28	27	26	25	24	23	22	21	20	19	18	17	16
	RXEN	reserved						RXI							RXF	
Type	R/W	RO	R/W	R/W	R/W	R/W	R/W	R/W	R/W	R/W	R/W	R/W	R/W	R/W	R/W	R/W
Reset	0	0	0	0	0	0	0	0	0	0	0	0	0	0	0	0
	15	14	13	12	11	10	9	8	7	6	5	4	3	2	1	0
	TXEN	reserved						TXI							TXF	
Type	R/W	RO	R/W	R/W	R/W	R/W	R/W	R/W	R/W	R/W	R/W	R/W	R/W	R/W	R/W	R/W
Reset	0	0	0	0	0	0	0	0	0	0	0	0	0	0	0	0

Bit/Field	Name	Type	Reset	Description
31	RXEN	R/W	0	RX Clock Enable  Value Description 1 The I <sup>2</sup> S receive clock generator is enabled. 0 The I <sup>2</sup> S receive clock generator is disabled.  If the RXSLV bit in the <b>I<sup>2</sup>S Module Configuration (I2SCFG)</b> register is set, then the I2S0RXMCLK must be externally generated.
30	reserved	RO	0	Software should not rely on the value of a reserved bit. To provide compatibility with future products, the value of a reserved bit should be preserved across a read-modify-write operation.
29:20	RXI	R/W	0x0	RX Clock Integer Input  This field contains the integer input for the receive clock generator.
19:16	RXF	R/W	0x0	RX Clock Fractional Input  This field contains the fractional input for the receive clock generator.
15	TXEN	R/W	0	TX Clock Enable  Value Description 1 The I <sup>2</sup> S transmit clock generator is enabled. 0 The I <sup>2</sup> S transmit clock generator is disabled.  If the TXSLV bit in the <b>I<sup>2</sup>S Module Configuration (I2SCFG)</b> register is set, then the I2S0TXMCLK must be externally generated.



---

Bit/Field	Name	Type	Reset	Description
14	reserved	RO	0	Software should not rely on the value of a reserved bit. To provide compatibility with future products, the value of a reserved bit should be preserved across a read-modify-write operation.
13:4	TXI	R/W	0x00	TX Clock Integer Input This field contains the integer input for the transmit clock generator.
3:0	TXF	R/W	0x0	TX Clock Fractional Input This field contains the fractional input for the transmit clock generator.

## Register 15: Device Identification 1 (DID1), offset 0x004

This register identifies the device family, part number, temperature range, and package type.

### Device Identification 1 (DID1)

Base 0x400F.E000

Offset 0x004

Type RO, reset -

	31	30	29	28	27	26	25	24	23	22	21	20	19	18	17	16
	VER				FAM				PARTNO							
Type	RO	RO	RO	RO	RO	RO	RO	RO	RO	RO	RO	RO	RO	RO	RO	RO
Reset	0	0	0	1	0	0	0	0	0	1	1	0	1	1	1	1
	15	14	13	12	11	10	9	8	7	6	5	4	3	2	1	0
	PINCOUNT			reserved				TEMP			PKG		ROHS	QUAL		
Type	RO	RO	RO	RO	RO	RO	RO	RO	RO	RO	RO	RO	RO	RO	RO	RO
Reset	0	1	0	0	0	0	0	0	-	-	-	-	-	1	-	-

Bit/Field	Name	Type	Reset	Description				
31:28	VER	RO	0x1	<p>DID1 Version</p> <p>This field defines the <b>DID1</b> register format version. The version number is numeric. The value of the <code>VER</code> field is encoded as follows (all other encodings are reserved):</p> <table border="1"> <thead> <tr> <th>Value</th> <th>Description</th> </tr> </thead> <tbody> <tr> <td>0x1</td> <td>Second version of the <b>DID1</b> register format.</td> </tr> </tbody> </table>	Value	Description	0x1	Second version of the <b>DID1</b> register format.
Value	Description							
0x1	Second version of the <b>DID1</b> register format.							
27:24	FAM	RO	0x0	<p>Family</p> <p>This field provides the family identification of the device within the Luminary Micro product portfolio. The value is encoded as follows (all other encodings are reserved):</p> <table border="1"> <thead> <tr> <th>Value</th> <th>Description</th> </tr> </thead> <tbody> <tr> <td>0x0</td> <td>Stellaris family of microcontrollers, that is, all devices with external part numbers starting with LM3S.</td> </tr> </tbody> </table>	Value	Description	0x0	Stellaris family of microcontrollers, that is, all devices with external part numbers starting with LM3S.
Value	Description							
0x0	Stellaris family of microcontrollers, that is, all devices with external part numbers starting with LM3S.							
23:16	PARTNO	RO	0x6F	<p>Part Number</p> <p>This field provides the part number of the device within the family. The value is encoded as follows (all other encodings are reserved):</p> <table border="1"> <thead> <tr> <th>Value</th> <th>Description</th> </tr> </thead> <tbody> <tr> <td>0x6F</td> <td>LM3S9B96</td> </tr> </tbody> </table>	Value	Description	0x6F	LM3S9B96
Value	Description							
0x6F	LM3S9B96							
15:13	PINCOUNT	RO	0x2	<p>Package Pin Count</p> <p>This field specifies the number of pins on the device package. The value is encoded as follows (all other encodings are reserved):</p> <table border="1"> <thead> <tr> <th>Value</th> <th>Description</th> </tr> </thead> <tbody> <tr> <td>0x2</td> <td>100-pin package</td> </tr> </tbody> </table>	Value	Description	0x2	100-pin package
Value	Description							
0x2	100-pin package							

Bit/Field	Name	Type	Reset	Description								
12:8	reserved	RO	0	Software should not rely on the value of a reserved bit. To provide compatibility with future products, the value of a reserved bit should be preserved across a read-modify-write operation.								
7:5	TEMP	RO	-	<p>Temperature Range</p> <p>This field specifies the temperature rating of the device. The value is encoded as follows (all other encodings are reserved):</p> <table border="1"> <thead> <tr> <th>Value</th> <th>Description</th> </tr> </thead> <tbody> <tr> <td>0x0</td> <td>Commercial temperature range (0°C to 70°C)</td> </tr> <tr> <td>0x1</td> <td>Industrial temperature range (-40°C to 85°C)</td> </tr> <tr> <td>0x2</td> <td>Extended temperature range (-40°C to 105°C)</td> </tr> </tbody> </table>	Value	Description	0x0	Commercial temperature range (0°C to 70°C)	0x1	Industrial temperature range (-40°C to 85°C)	0x2	Extended temperature range (-40°C to 105°C)
Value	Description											
0x0	Commercial temperature range (0°C to 70°C)											
0x1	Industrial temperature range (-40°C to 85°C)											
0x2	Extended temperature range (-40°C to 105°C)											
4:3	PKG	RO	-	<p>Package Type</p> <p>This field specifies the package type. The value is encoded as follows (all other encodings are reserved):</p> <table border="1"> <thead> <tr> <th>Value</th> <th>Description</th> </tr> </thead> <tbody> <tr> <td>0x0</td> <td>SOIC package</td> </tr> <tr> <td>0x1</td> <td>LQFP package</td> </tr> <tr> <td>0x2</td> <td>BGA package</td> </tr> </tbody> </table>	Value	Description	0x0	SOIC package	0x1	LQFP package	0x2	BGA package
Value	Description											
0x0	SOIC package											
0x1	LQFP package											
0x2	BGA package											
2	ROHS	RO	1	<p>RoHS-Compliance</p> <p>This bit specifies whether the device is RoHS-compliant. A 1 indicates the part is RoHS-compliant.</p>								
1:0	QUAL	RO	-	<p>Qualification Status</p> <p>This field specifies the qualification status of the device. The value is encoded as follows (all other encodings are reserved):</p> <table border="1"> <thead> <tr> <th>Value</th> <th>Description</th> </tr> </thead> <tbody> <tr> <td>0x0</td> <td>Engineering Sample (unqualified)</td> </tr> <tr> <td>0x1</td> <td>Pilot Production (unqualified)</td> </tr> <tr> <td>0x2</td> <td>Fully Qualified</td> </tr> </tbody> </table>	Value	Description	0x0	Engineering Sample (unqualified)	0x1	Pilot Production (unqualified)	0x2	Fully Qualified
Value	Description											
0x0	Engineering Sample (unqualified)											
0x1	Pilot Production (unqualified)											
0x2	Fully Qualified											

## Register 16: Device Capabilities 0 (DC0), offset 0x008

This register is predefined by the part and can be used to verify features.

### Device Capabilities 0 (DC0)

Base 0x400F.E000

Offset 0x008

Type RO, reset 0x017F.007F

	31	30	29	28	27	26	25	24	23	22	21	20	19	18	17	16
	SRAMSZ															
Type	RO	RO	RO	RO	RO	RO	RO	RO	RO	RO	RO	RO	RO	RO	RO	RO
Reset	0	0	0	0	0	0	0	1	0	1	1	1	1	1	1	1
	15	14	13	12	11	10	9	8	7	6	5	4	3	2	1	0
	FLASHSZ															
Type	RO	RO	RO	RO	RO	RO	RO	RO	RO	RO	RO	RO	RO	RO	RO	RO
Reset	0	0	0	0	0	0	0	0	0	1	1	1	1	1	1	1

Bit/Field	Name	Type	Reset	Description
31:16	SRAMSZ	RO	0x017F	SRAM Size Indicates the size of the on-chip SRAM memory.  Value    Description 0x017F  96 KB of SRAM
15:0	FLASHSZ	RO	0x007F	Flash Size Indicates the size of the on-chip flash memory.  Value    Description 0x007F  256 KB of Flash

## Register 17: Device Capabilities 1 (DC1), offset 0x010

This register is predefined by the part and can be used to verify features. If any bit is clear in this register, the module is not present. The corresponding bit in the RCGC0, SCGC0, and DCGC0 registers cannot be set.

### Device Capabilities 1 (DC1)

Base 0x400F.E000

Offset 0x010

Type RO, reset -

	31	30	29	28	27	26	25	24	23	22	21	20	19	18	17	16
	reserved			WDT1	reserved		CAN1	CAN0	reserved			PWM	reserved		ADC1	ADC0
Type	RO	RO	RO	RO	RO	RO	RO	RO	RO	RO	RO	RO	RO	RO	RO	RO
Reset	0	0	0	1	0	0	1	1	0	0	0	1	0	0	1	1
	15	14	13	12	11	10	9	8	7	6	5	4	3	2	1	0
	MINSYSDIV				MAXADC1SPD		MAXADC0SPD		MPU	reserved	TEMPSNS	PLL	WDT0	SWO	SWD	JTAG
Type	RO	RO	RO	RO	RO	RO	RO	RO	RO	RO	RO	RO	RO	RO	RO	RO
Reset	-	-	-	-	1	1	1	1	1	0	1	1	1	1	1	1

Bit/Field	Name	Type	Reset	Description
31:29	reserved	RO	0	Software should not rely on the value of a reserved bit. To provide compatibility with future products, the value of a reserved bit should be preserved across a read-modify-write operation.
28	WDT1	RO	1	Watchdog Timer1 Present When set, indicates that watchdog timer 1 is present.
27:26	reserved	RO	0	Software should not rely on the value of a reserved bit. To provide compatibility with future products, the value of a reserved bit should be preserved across a read-modify-write operation.
25	CAN1	RO	1	CAN Module 1 Present When set, indicates that CAN unit 1 is present.
24	CAN0	RO	1	CAN Module 0 Present When set, indicates that CAN unit 0 is present.
23:21	reserved	RO	0	Software should not rely on the value of a reserved bit. To provide compatibility with future products, the value of a reserved bit should be preserved across a read-modify-write operation.
20	PWM	RO	1	PWM Module Present When set, indicates that the PWM module is present.
19:18	reserved	RO	0	Software should not rely on the value of a reserved bit. To provide compatibility with future products, the value of a reserved bit should be preserved across a read-modify-write operation.
17	ADC1	RO	1	ADC Module 1 Present When set, indicates that ADC module 1 is present.
16	ADC0	RO	1	ADC Module 0 Present When set, indicates that ADC module 0 is present

Bit/Field	Name	Type	Reset	Description
15:12	MINSYSDIV	RO	-	<p>System Clock Divider</p> <p>Minimum 4-bit divider value for system clock. The reset value is hardware-dependent. See the RCC register for how to change the system clock divisor using the SYSDIV bit.</p> <p>Value Description</p> <p>0x1 Divide VCO (400MHZ) by 5 minimum</p> <p>0x2 Divide VCO (400MHZ) by <math>2^2 + 2 = 6</math> minimum</p> <p>0x3 Specifies a 50-MHz CPU clock with a PLL divider of 4.</p> <p>0x7 Specifies a 25-MHz clock with a PLL divider of 8.</p> <p>0x9 Specifies a 20-MHz clock with a PLL divider of 10.</p>
11:10	MAXADC1SPD	RO	0x3	<p>Max ADC1 Speed</p> <p>This field indicates the maximum rate at which the ADC samples data.</p> <p>Value Description</p> <p>0x3 1M samples/second</p>
9:8	MAXADC0SPD	RO	0x3	<p>Max ADC0 Speed</p> <p>This field indicates the maximum rate at which the ADC samples data.</p> <p>Value Description</p> <p>0x3 1M samples/second</p>
7	MPU	RO	1	<p>MPU Present</p> <p>When set, indicates that the Cortex-M3 Memory Protection Unit (MPU) module is present. See the ARM Cortex-M3 Technical Reference Manual for details on the MPU.</p>
6	reserved	RO	0	<p>Software should not rely on the value of a reserved bit. To provide compatibility with future products, the value of a reserved bit should be preserved across a read-modify-write operation.</p>
5	TEMPSNS	RO	1	<p>Temp Sensor Present</p> <p>When set, indicates that the on-chip temperature sensor is present.</p>
4	PLL	RO	1	<p>PLL Present</p> <p>When set, indicates that the on-chip Phase Locked Loop (PLL) is present.</p>
3	WDT0	RO	1	<p>Watchdog Timer 0 Present</p> <p>When set, indicates that watchdog timer 0 is present.</p>
2	SWO	RO	1	<p>SWO Trace Port Present</p> <p>When set, indicates that the Serial Wire Output (SWO) trace port is present.</p>
1	SWD	RO	1	<p>SWD Present</p> <p>When set, indicates that the Serial Wire Debugger (SWD) is present.</p>

Bit/Field	Name	Type	Reset	Description
0	JTAG	RO	1	JTAG Present When set, indicates that the JTAG debugger interface is present.

## Register 18: Device Capabilities 2 (DC2), offset 0x014

This register is predefined by the part and can be used to verify features. If any bit is clear in this register, the module is not present. The corresponding bit in the RCGC0, SCGC0, and DCGC0 registers cannot be set.

### Device Capabilities 2 (DC2)

Base 0x400F.E000

Offset 0x014

Type RO, reset 0x570F.5337

	31	30	29	28	27	26	25	24	23	22	21	20	19	18	17	16
	reserved	EPI0	reserved	I2S0	reserved	COMP2	COMP1	COMP0	reserved			TIMER3	TIMER2	TIMER1	TIMER0	
Type	RO	RO	RO	RO	RO	RO	RO	RO	RO	RO	RO	RO	RO	RO	RO	RO
Reset	0	1	0	1	0	1	1	1	0	0	0	0	1	1	1	1
	15	14	13	12	11	10	9	8	7	6	5	4	3	2	1	0
	reserved	I2C1	reserved	I2C0	reserved		QE1	QE0	reserved		SSI1	SSI0	reserved	UART2	UART1	UART0
Type	RO	RO	RO	RO	RO	RO	RO	RO	RO	RO	RO	RO	RO	RO	RO	RO
Reset	0	1	0	1	0	0	1	1	0	0	1	1	0	1	1	1

Bit/Field	Name	Type	Reset	Description
31	reserved	RO	0	Software should not rely on the value of a reserved bit. To provide compatibility with future products, the value of a reserved bit should be preserved across a read-modify-write operation.
30	EPI0	RO	1	EPI Module 0 Present When set, indicates that EPI module 0 is present.
29	reserved	RO	0	Software should not rely on the value of a reserved bit. To provide compatibility with future products, the value of a reserved bit should be preserved across a read-modify-write operation.
28	I2S0	RO	1	I2S Module 0 Present When set, indicates that I2S module 0 is present.
27	reserved	RO	0	Software should not rely on the value of a reserved bit. To provide compatibility with future products, the value of a reserved bit should be preserved across a read-modify-write operation.
26	COMP2	RO	1	Analog Comparator 2 Present When set, indicates that analog comparator 2 is present.
25	COMP1	RO	1	Analog Comparator 1 Present When set, indicates that analog comparator 1 is present.
24	COMP0	RO	1	Analog Comparator 0 Present When set, indicates that analog comparator 0 is present.
23:20	reserved	RO	0	Software should not rely on the value of a reserved bit. To provide compatibility with future products, the value of a reserved bit should be preserved across a read-modify-write operation.
19	TIMER3	RO	1	Timer Module 3 Present When set, indicates that General-Purpose Timer module 3 is present.



Bit/Field	Name	Type	Reset	Description
18	TIMER2	RO	1	Timer Module 2 Present When set, indicates that General-Purpose Timer module 2 is present.
17	TIMER1	RO	1	Timer Module 1 Present When set, indicates that General-Purpose Timer module 1 is present.
16	TIMER0	RO	1	Timer Module 0 Present When set, indicates that General-Purpose Timer module 0 is present.
15	reserved	RO	0	Software should not rely on the value of a reserved bit. To provide compatibility with future products, the value of a reserved bit should be preserved across a read-modify-write operation.
14	I2C1	RO	1	I2C Module 1 Present When set, indicates that I2C module 1 is present.
13	reserved	RO	0	Software should not rely on the value of a reserved bit. To provide compatibility with future products, the value of a reserved bit should be preserved across a read-modify-write operation.
12	I2C0	RO	1	I2C Module 0 Present When set, indicates that I2C module 0 is present.
11:10	reserved	RO	0	Software should not rely on the value of a reserved bit. To provide compatibility with future products, the value of a reserved bit should be preserved across a read-modify-write operation.
9	QEI1	RO	1	QEI Module 1 Present When set, indicates that QEI module 1 is present.
8	QEI0	RO	1	QEI Module 0 Present When set, indicates that QEI module 0 is present.
7:6	reserved	RO	0	Software should not rely on the value of a reserved bit. To provide compatibility with future products, the value of a reserved bit should be preserved across a read-modify-write operation.
5	SSI1	RO	1	SSI Module 1 Present When set, indicates that SSI module 1 is present.
4	SSI0	RO	1	SSI Module 0 Present When set, indicates that SSI module 0 is present.
3	reserved	RO	0	Software should not rely on the value of a reserved bit. To provide compatibility with future products, the value of a reserved bit should be preserved across a read-modify-write operation.
2	UART2	RO	1	UART Module 2 Present When set, indicates that UART module 2 is present.
1	UART1	RO	1	UART Module 1 Present When set, indicates that UART module 1 is present.

Bit/Field	Name	Type	Reset	Description
0	UART0	RO	1	UART Module 0 Present When set, indicates that UART module 0 is present.

## Register 19: Device Capabilities 3 (DC3), offset 0x018

This register is predefined by the part and can be used to verify features. If any bit is clear in this register, the module is not present. The corresponding bit in the RCGC0, SCGC0, and DCGC0 registers cannot be set.

### Device Capabilities 3 (DC3)

Base 0x400F.E000

Offset 0x018

Type RO, reset 0xBFFF.FFFF

	31	30	29	28	27	26	25	24	23	22	21	20	19	18	17	16
	32KHZ	reserved	CCP5	CCP4	CCP3	CCP2	CCP1	CCP0	ADC0AIN7	ADC0AIN6	ADC0AIN5	ADC0AIN4	ADC0AIN3	ADC0AIN2	ADC0AIN1	ADC0AIN0
Type	RO	RO	RO	RO	RO	RO	RO	RO	RO	RO	RO	RO	RO	RO	RO	RO
Reset	1	0	1	1	1	1	1	1	1	1	1	1	1	1	1	1
	15	14	13	12	11	10	9	8	7	6	5	4	3	2	1	0
	PWMFAULT	C2O	C2PLUS	C2MINUS	C1O	C1PLUS	C1MINUS	C0O	C0PLUS	C0MINUS	PWM5	PWM4	PWM3	PWM2	PWM1	PWM0
Type	RO	RO	RO	RO	RO	RO	RO	RO	RO	RO	RO	RO	RO	RO	RO	RO
Reset	1	1	1	1	1	1	1	1	1	1	1	1	1	1	1	1

Bit/Field	Name	Type	Reset	Description
31	32KHZ	RO	1	32KHz Input Clock Available When set, indicates an even CCP pin is present and can be used as a 32-KHz input clock.
30	reserved	RO	0	Software should not rely on the value of a reserved bit. To provide compatibility with future products, the value of a reserved bit should be preserved across a read-modify-write operation.
29	CCP5	RO	1	CCP5 Pin Present When set, indicates that Capture/Compare/PWM pin 5 is present.
28	CCP4	RO	1	CCP4 Pin Present When set, indicates that Capture/Compare/PWM pin 4 is present.
27	CCP3	RO	1	CCP3 Pin Present When set, indicates that Capture/Compare/PWM pin 3 is present.
26	CCP2	RO	1	CCP2 Pin Present When set, indicates that Capture/Compare/PWM pin 2 is present.
25	CCP1	RO	1	CCP1 Pin Present When set, indicates that Capture/Compare/PWM pin 1 is present.
24	CCP0	RO	1	CCP0 Pin Present When set, indicates that Capture/Compare/PWM pin 0 is present.
23	ADC0AIN7	RO	1	ADC Module 0 AIN7 Pin Present When set, indicates that ADC module 0 input pin 7 is present.
22	ADC0AIN6	RO	1	ADC Module 0 AIN6 Pin Present When set, indicates that ADC module 0 input pin 6 is present.

Bit/Field	Name	Type	Reset	Description
21	ADC0AIN5	RO	1	ADC Module 0 AIN5 Pin Present When set, indicates that ADC module 0 input pin 5 is present.
20	ADC0AIN4	RO	1	ADC Module 0 AIN4 Pin Present When set, indicates that ADC module 0 input pin 4 is present.
19	ADC0AIN3	RO	1	ADC Module 0 AIN3 Pin Present When set, indicates that ADC module 0 input pin 3 is present.
18	ADC0AIN2	RO	1	ADC Module 0 AIN2 Pin Present When set, indicates that ADC module 0 input pin 2 is present.
17	ADC0AIN1	RO	1	ADC Module 0 AIN1 Pin Present When set, indicates that ADC module 0 input pin 1 is present.
16	ADC0AIN0	RO	1	ADC Module 0 AIN0 Pin Present When set, indicates that ADC module 0 input pin 0 is present.
15	PWMFAULT	RO	1	PWM Fault Pin Present When set, indicates that a PWM Fault pin is present. See DC5 for specific Fault pins on this device.
14	C2O	RO	1	C2o Pin Present When set, indicates that the analog comparator 2 output pin is present.
13	C2PLUS	RO	1	C2+ Pin Present When set, indicates that the analog comparator 2 (+) input pin is present.
12	C2MINUS	RO	1	C2- Pin Present When set, indicates that the analog comparator 2 (-) input pin is present.
11	C1O	RO	1	C1o Pin Present When set, indicates that the analog comparator 1 output pin is present.
10	C1PLUS	RO	1	C1+ Pin Present When set, indicates that the analog comparator 1 (+) input pin is present.
9	C1MINUS	RO	1	C1- Pin Present When set, indicates that the analog comparator 1 (-) input pin is present.
8	C0O	RO	1	C0o Pin Present When set, indicates that the analog comparator 0 output pin is present.
7	C0PLUS	RO	1	C0+ Pin Present When set, indicates that the analog comparator 0 (+) input pin is present.
6	C0MINUS	RO	1	C0- Pin Present When set, indicates that the analog comparator 0 (-) input pin is present.

---

Bit/Field	Name	Type	Reset	Description
5	PWM5	RO	1	PWM5 Pin Present When set, indicates that the PWM pin 5 is present.
4	PWM4	RO	1	PWM4 Pin Present When set, indicates that the PWM pin 4 is present.
3	PWM3	RO	1	PWM3 Pin Present When set, indicates that the PWM pin 3 is present.
2	PWM2	RO	1	PWM2 Pin Present When set, indicates that the PWM pin 2 is present.
1	PWM1	RO	1	PWM1 Pin Present When set, indicates that the PWM pin 1 is present.
0	PWM0	RO	1	PWM0 Pin Present When set, indicates that the PWM pin 0 is present.

## Register 20: Device Capabilities 4 (DC4), offset 0x01C

This register is predefined by the part and can be used to verify features. If any bit is clear in this register, the module is not present. The corresponding bit in the RCGC0, SCGC0, and DCGC0 registers cannot be set.

### Device Capabilities 4 (DC4)

Base 0x400F.E000  
Offset 0x01C  
Type RO, reset 0x5100.F1FF

	31	30	29	28	27	26	25	24	23	22	21	20	19	18	17	16
	reserved	EPHY0	reserved	EMAC0	reserved			E1588	reserved							
Type	RO	RO	RO	RO	RO	RO	RO	RO	RO	RO	RO	RO	RO	RO	RO	RO
Reset	0	1	0	1	0	0	0	1	0	0	0	0	0	0	0	0
	15	14	13	12	11	10	9	8	7	6	5	4	3	2	1	0
	CCP7	CCP6	UDMA	ROM	reserved			GPIOJ	GPIOH	GPIOG	GPIOF	GPIOE	GPIOD	GPIOC	GPIOB	GPIOA
Type	RO	RO	RO	RO	RO	RO	RO	RO	RO	RO	RO	RO	RO	RO	RO	RO
Reset	1	1	1	1	0	0	0	1	1	1	1	1	1	1	1	1

Bit/Field	Name	Type	Reset	Description
31	reserved	RO	0	Software should not rely on the value of a reserved bit. To provide compatibility with future products, the value of a reserved bit should be preserved across a read-modify-write operation.
30	EPHY0	RO	1	Ethernet PHY Layer 0 Present When set, indicates that Ethernet PHY layer 0 is present.
29	reserved	RO	0	Software should not rely on the value of a reserved bit. To provide compatibility with future products, the value of a reserved bit should be preserved across a read-modify-write operation.
28	EMAC0	RO	1	Ethernet MAC Layer 0 Present When set, indicates that Ethernet MAC layer 0 is present.
27:25	reserved	RO	0	Software should not rely on the value of a reserved bit. To provide compatibility with future products, the value of a reserved bit should be preserved across a read-modify-write operation.
24	E1588	RO	1	1588 Capable When set, indicates that that Ethernet MAC layer 0 is 1588 capable.
23:16	reserved	RO	0	Software should not rely on the value of a reserved bit. To provide compatibility with future products, the value of a reserved bit should be preserved across a read-modify-write operation.
15	CCP7	RO	1	CCP7 Pin Present When set, indicates that Capture/Compare/PWM pin 7 is present.
14	CCP6	RO	1	CCP6 Pin Present When set, indicates that Capture/Compare/PWM pin 6 is present.
13	UDMA	RO	1	Micro-DMA Module Present When set, indicates that the micro-DMA module present.

Bit/Field	Name	Type	Reset	Description
12	ROM	RO	1	Internal Code ROM Present When set, indicates that internal code ROM is present.
11:9	reserved	RO	0	Software should not rely on the value of a reserved bit. To provide compatibility with future products, the value of a reserved bit should be preserved across a read-modify-write operation.
8	GPIOJ	RO	1	GPIO Port J Present When set, indicates that GPIO Port J is present.
7	GPIOH	RO	1	GPIO Port H Present When set, indicates that GPIO Port H is present.
6	GPIOG	RO	1	GPIO Port G Present When set, indicates that GPIO Port G is present.
5	GPIOF	RO	1	GPIO Port F Present When set, indicates that GPIO Port F is present.
4	GPIOE	RO	1	GPIO Port E Present When set, indicates that GPIO Port E is present.
3	GPIOD	RO	1	GPIO Port D Present When set, indicates that GPIO Port D is present.
2	GPIOC	RO	1	GPIO Port C Present When set, indicates that GPIO Port C is present.
1	GPIOB	RO	1	GPIO Port B Present When set, indicates that GPIO Port B is present.
0	GPIOA	RO	1	GPIO Port A Present When set, indicates that GPIO Port A is present.

## Register 21: Device Capabilities 5 (DC5), offset 0x020

This register is predefined by the part and can be used to verify features. If any bit is clear in this register, the module is not present. The corresponding bit in the RCGC0, SCGC0, and DCGC0 registers cannot be set.

### Device Capabilities 5 (DC5)

Base 0x400F.E000  
Offset 0x020  
Type RO, reset 0x0F30.00FF

	31	30	29	28	27	26	25	24	23	22	21	20	19	18	17	16
	reserved				PWMFAULT3	PWMFAULT2	PWMFAULT1	PWMFAULT0	reserved		PWMEFLT	PWMESYNC	reserved			
Type	RO	RO	RO	RO	RO	RO	RO	RO	RO	RO	RO	RO	RO	RO	RO	RO
Reset	0	0	0	0	1	1	1	1	0	0	1	1	0	0	0	0
	15	14	13	12	11	10	9	8	7	6	5	4	3	2	1	0
	reserved								PWM7	PWM6	PWM5	PWM4	PWM3	PWM2	PWM1	PWM0
Type	RO	RO	RO	RO	RO	RO	RO	RO	RO	RO	RO	RO	RO	RO	RO	RO
Reset	0	0	0	0	0	0	0	0	1	1	1	1	1	1	1	1

Bit/Field	Name	Type	Reset	Description
31:28	reserved	RO	0	Software should not rely on the value of a reserved bit. To provide compatibility with future products, the value of a reserved bit should be preserved across a read-modify-write operation.
27	PWMFAULT3	RO	1	PWM Fault 3 Pin Present When set, indicates that the PWM Fault 3 pin is present.
26	PWMFAULT2	RO	1	PWM Fault 2 Pin Present When set, indicates that the PWM Fault 2 pin is present.
25	PWMFAULT1	RO	1	PWM Fault 1 Pin Present When set, indicates that the PWM Fault 1 pin is present.
24	PWMFAULT0	RO	1	PWM Fault 0 Pin Present When set, indicates that the PWM Fault 0 pin is present.
23:22	reserved	RO	0	Software should not rely on the value of a reserved bit. To provide compatibility with future products, the value of a reserved bit should be preserved across a read-modify-write operation.
21	PWMEFLT	RO	1	PWM Extended Fault Active When set, indicates that the PWM Extended Fault feature is active.
20	PWMESYNC	RO	1	PWM Extended SYNC Active When set, indicates that the PWM Extended SYNC feature is active.
19:8	reserved	RO	0	Software should not rely on the value of a reserved bit. To provide compatibility with future products, the value of a reserved bit should be preserved across a read-modify-write operation.
7	PWM7	RO	1	PWM7 Pin Present When set, indicates that the PWM pin 7 is present.



---

Bit/Field	Name	Type	Reset	Description
6	PWM6	RO	1	PWM6 Pin Present When set, indicates that the PWM pin 6 is present.
5	PWM5	RO	1	PWM5 Pin Present When set, indicates that the PWM pin 5 is present.
4	PWM4	RO	1	PWM4 Pin Present When set, indicates that the PWM pin 4 is present.
3	PWM3	RO	1	PWM3 Pin Present When set, indicates that the PWM pin 3 is present.
2	PWM2	RO	1	PWM2 Pin Present When set, indicates that the PWM pin 2 is present.
1	PWM1	RO	1	PWM1 Pin Present When set, indicates that the PWM pin 1 is present.
0	PWM0	RO	1	PWM0 Pin Present When set, indicates that the PWM pin 0 is present.

## Register 22: Device Capabilities 6 (DC6), offset 0x024

This register is predefined by the part and can be used to verify features. If any bit is clear in this register, the module is not present. The corresponding bit in the RCGC0, SCGC0, and DCGC0 registers cannot be set.

### Device Capabilities 6 (DC6)

Base 0x400F.E000  
 Offset 0x024  
 Type RO, reset 0x0000.0013

	31	30	29	28	27	26	25	24	23	22	21	20	19	18	17	16
	reserved															
Type	RO	RO	RO	RO	RO	RO	RO	RO	RO	RO	RO	RO	RO	RO	RO	RO
Reset	0	0	0	0	0	0	0	0	0	0	0	0	0	0	0	0
	15	14	13	12	11	10	9	8	7	6	5	4	3	2	1	0
	reserved											USB0PHY	reserved		USB0	
Type	RO	RO	RO	RO	RO	RO	RO	RO	RO	RO	RO	RO	RO	RO	RO	RO
Reset	0	0	0	0	0	0	0	0	0	0	0	1	0	0	1	1

Bit/Field	Name	Type	Reset	Description
31:5	reserved	RO	0	Software should not rely on the value of a reserved bit. To provide compatibility with future products, the value of a reserved bit should be preserved across a read-modify-write operation.
4	USB0PHY	RO	1	USB Module 0 PHY Present  When set, indicates that the USB module 0 PHY is present.
3:2	reserved	RO	0	Software should not rely on the value of a reserved bit. To provide compatibility with future products, the value of a reserved bit should be preserved across a read-modify-write operation.
1:0	USB0	RO	0x3	USB Module 0 Present  This field indicates that USB module 0 is present and specifies its capability.  Value Description 0x3 USB0 is OTG.

## Register 23: Device Capabilities 7 (DC7), offset 0x028

This register is predefined by the part and can be used to verify uDMA channel features. A 1 indicates the channel is available on this device; a 0 that the channel is only available on other devices in the family. Most channels have primary and secondary assignments. If the primary function is not available on this microcontroller, the secondary function becomes the primary function. If the secondary function is not available, the primary function is the only option.

### Device Capabilities 7 (DC7)

Base 0x400F.E000  
Offset 0x028  
Type RO, reset 0xFFFF.FFFF

	31	30	29	28	27	26	25	24	23	22	21	20	19	18	17	16
	reserved	DMACH30	DMACH29	DMACH28	DMACH27	DMACH26	DMACH25	DMACH24	DMACH23	DMACH22	DMACH21	DMACH20	DMACH19	DMACH18	DMACH17	DMACH16
Type	RO	RO	RO	RO	RO	RO	RO	RO	RO	RO	RO	RO	RO	RO	RO	RO
Reset	1	1	1	1	1	1	1	1	1	1	1	1	1	1	1	1
	15	14	13	12	11	10	9	8	7	6	5	4	3	2	1	0
	DMACH15	DMACH14	DMACH13	DMACH12	DMACH11	DMACH10	DMACH9	DMACH8	DMACH7	DMACH6	DMACH5	DMACH4	DMACH3	DMACH2	DMACH1	DMACH0
Type	RO	RO	RO	RO	RO	RO	RO	RO	RO	RO	RO	RO	RO	RO	RO	RO
Reset	1	1	1	1	1	1	1	1	1	1	1	1	1	1	1	1

Bit/Field	Name	Type	Reset	Description
31	reserved	RO	1	Reserved  Reserved for uDMA channel 31.
30	DMACH30	RO	1	SW  When set, indicates uDMA channel 30 is available for software transfers.
29	DMACH29	RO	1	I2S0_TX / CAN1_TX  When set, indicates uDMA channel 29 is available and connected to the transmit path of I2S module 0. If the corresponding bit in the <b>DMACHASGN</b> register is set, the channel is connected instead to the secondary channel assignment of CAN module 1 transmit.
28	DMACH28	RO	1	I2S0_RX / CAN1_RX  When set, indicates uDMA channel 28 is available and connected to the receive path of I2S module 0. If the corresponding bit in the <b>DMACHASGN</b> register is set, the channel is connected instead to the secondary channel assignment of CAN module 1 receive.
27	DMACH27	RO	1	CAN1_TX / ADC1_SS3  When set, indicates uDMA channel 27 is available and connected to the transmit path of CAN module 1. If the corresponding bit in the <b>DMACHASGN</b> register is set, the channel is connected instead to the secondary channel assignment of ADC module 1 Sample Sequencer 3.
26	DMACH26	RO	1	CAN1_RX / ADC1_SS2  When set, indicates uDMA channel 26 is available and connected to the receive path of CAN module 1. If the corresponding bit in the <b>DMACHASGN</b> register is set, the channel is connected instead to the secondary channel assignment of ADC module 1 Sample Sequencer 2.

Bit/Field	Name	Type	Reset	Description
25	DMACH25	RO	1	SSI1_TX / ADC1_SS1 When set, indicates uDMA channel 25 is available and connected to the transmit path of SSI module 1. If the corresponding bit in the <b>DMACHASGN</b> register is set, the channel is connected instead to the secondary channel assignment of ADC module 1 Sample Sequencer 1.
24	DMACH24	RO	1	SSI1_RX / ADC1_SS0 When set, indicates uDMA channel 24 is available and connected to the receive path of SSI module 1. If the corresponding bit in the <b>DMACHASGN</b> register is set, the channel is connected instead to the secondary channel assignment of ADC module 1 Sample Sequencer 0.
23	DMACH23	RO	1	UART1_TX / CAN2_TX When set, indicates uDMA channel 23 is available and connected to the transmit path of UART module 1. If the corresponding bit in the <b>DMACHASGN</b> register is set, the channel is connected instead to the secondary channel assignment of CAN module 2 transmit.
22	DMACH22	RO	1	UART1_RX / CAN2_RX When set, indicates uDMA channel 22 is available and connected to the receive path of UART module 1. If the corresponding bit in the <b>DMACHASGN</b> register is set, the channel is connected instead to the secondary channel assignment of CAN module 2 receive.
21	DMACH21	RO	1	Timer1B / EPI0_WFIFO When set, indicates uDMA channel 21 is available and connected to Timer 1B. If the corresponding bit in the <b>DMACHASGN</b> register is set, the channel is connected instead to the secondary channel assignment of EPI module write FIFO (WRIFO).
20	DMACH20	RO	1	Timer1A / EPI0_NBRFIFO When set, indicates uDMA channel 20 is available and connected to Timer 1A. If the corresponding bit in the <b>DMACHASGN</b> register is set, the channel is connected instead to the secondary channel assignment of EPI module 0 non-blocking read FIFO (NBRFIFO).
19	DMACH19	RO	1	Timer0B / Timer1B When set, indicates uDMA channel 19 is available and connected to Timer 0B. If the corresponding bit in the <b>DMACHASGN</b> register is set, the channel is connected instead to the secondary channel assignment of Timer 1B.
18	DMACH18	RO	1	Timer0A / Timer1A When set, indicates uDMA channel 18 is available and connected to Timer 0A. If the corresponding bit in the <b>DMACHASGN</b> register is set, the channel is connected instead to the secondary channel assignment of Timer 1A.
17	DMACH17	RO	1	ADC0_SS3 When set, indicates uDMA channel 17 is available and connected to ADC module 0 Sample Sequencer 3.

Bit/Field	Name	Type	Reset	Description
16	DMACH16	RO	1	ADC0_SS2 When set, indicates uDMA channel 16 is available and connected to ADC module 0 Sample Sequencer 2.
15	DMACH15	RO	1	ADC0_SS1 / Timer2B When set, indicates uDMA channel 15 is available and connected to ADC module 0 Sample Sequencer 1. If the corresponding bit in the <b>DMACHASGN</b> register is set, the channel is connected instead to the secondary channel assignment of Timer 2B.
14	DMACH14	RO	1	ADC0_SS0 / Timer2A When set, indicates uDMA channel 14 is available and connected to ADC module 0 Sample Sequencer 0. If the corresponding bit in the <b>DMACHASGN</b> register is set, the channel is connected instead to the secondary channel assignment of Timer 2A.
13	DMACH13	RO	1	CAN0_TX / UART2_TX When set, indicates uDMA channel 13 is available and connected to the transmit path of CAN module 0. If the corresponding bit in the <b>DMACHASGN</b> register is set, the channel is connected instead to the secondary channel assignment of UART module 2 transmit.
12	DMACH12	RO	1	CAN0_RX / UART2_RX When set, indicates uDMA channel 12 is available and connected to the receive path of CAN module 0. If the corresponding bit in the <b>DMACHASGN</b> register is set, the channel is connected instead to the secondary channel assignment of UART module 2 receive.
11	DMACH11	RO	1	SSI0_TX / SSI1_TX When set, indicates uDMA channel 11 is available and connected to the transmit path of SSI module 0. If the corresponding bit in the <b>DMACHASGN</b> register is set, the channel is connected instead to the secondary channel assignment of SSI module 1 transmit.
10	DMACH10	RO	1	SSI0_RX / SSI1_RX When set, indicates uDMA channel 10 is available and connected to the receive path of SSI module 0. If the corresponding bit in the <b>DMACHASGN</b> register is set, the channel is connected instead to the secondary channel assignment of SSI module 1 receive.
9	DMACH9	RO	1	UART0_TX / UART1_TX When set, indicates uDMA channel 9 is available and connected to the transmit path of UART module 0. If the corresponding bit in the <b>DMACHASGN</b> register is set, the channel is connected instead to the secondary channel assignment of UART module 1 transmit.
8	DMACH8	RO	1	UART0_RX / UART1_RX When set, indicates uDMA channel 8 is available and connected to the receive path of UART module 0. If the corresponding bit in the <b>DMACHASGN</b> register is set, the channel is connected instead to the secondary channel assignment of UART module 1 receive.

Bit/Field	Name	Type	Reset	Description
7	DMACH7	RO	1	ETH_TX / Timer2B  When set, indicates uDMA channel 7 is available and connected to the transmit path of the Ethernet module. If the corresponding bit in the <b>DMACHASGN</b> register is set, the channel is connected instead to the secondary channel assignment of Timer 2B.
6	DMACH6	RO	1	ETH_RX / Timer2A  When set, indicates uDMA channel 6 is available and connected to the receive path of the Ethernet module. If the corresponding bit in the <b>DMACHASGN</b> register is set, the channel is connected instead to the secondary channel assignment of Timer 2A.
5	DMACH5	RO	1	USB_EP3_TX / Timer2B  When set, indicates uDMA channel 5 is available and connected to the transmit path of USB endpoint 3. If the corresponding bit in the <b>DMACHASGN</b> register is set, the channel is connected instead to the secondary channel assignment of Timer 2B.
4	DMACH4	RO	1	USB_EP3_RX / Timer2A  When set, indicates uDMA channel 4 is available and connected to the receive path of USB endpoint 3. If the corresponding bit in the <b>DMACHASGN</b> register is set, the channel is connected instead to the secondary channel assignment of Timer 2A.
3	DMACH3	RO	1	USB_EP2_TX / Timer3B  When set, indicates uDMA channel 3 is available and connected to the transmit path of USB endpoint 2. If the corresponding bit in the <b>DMACHASGN</b> register is set, the channel is connected instead to the secondary channel assignment of Timer 3B.
2	DMACH2	RO	1	USB_EP2_RX / Timer3A  When set, indicates uDMA channel 2 is available and connected to the receive path of USB endpoint 2. If the corresponding bit in the <b>DMACHASGN</b> register is set, the channel is connected instead to the secondary channel assignment of Timer 3A.
1	DMACH1	RO	1	USB_EP1_TX / UART2_TX  When set, indicates uDMA channel 1 is available and connected to the transmit path of USB endpoint 1. If the corresponding bit in the <b>DMACHASGN</b> register is set, the channel is connected instead to the secondary channel assignment of UART module 2 transmit.
0	DMACH0	RO	1	USB_EP1_RX / UART2_RX  When set, indicates uDMA channel 0 is available and connected to the receive path of USB endpoint 1. If the corresponding bit in the <b>DMACHASGN</b> register is set, the channel is connected instead to the secondary channel assignment of UART module 2 receive.

**Register 24: Device Capabilities 8 ADC Channels (DC8), offset 0x02C**

This register is predefined by the part and can be used to verify features.

**Device Capabilities 8 ADC Channels (DC8)**

Base 0x400F.E000

Offset 0x02C

Type RO, reset 0xFFFF.FFFF

	31	30	29	28	27	26	25	24	23	22	21	20	19	18	17	16
	ADC1AIN15	ADC1AIN14	ADC1AIN13	ADC1AIN12	ADC1AIN11	ADC1AIN10	ADC1AIN9	ADC1AIN8	ADC1AIN7	ADC1AIN6	ADC1AIN5	ADC1AIN4	ADC1AIN3	ADC1AIN2	ADC1AIN1	ADC1AIN0
Type	RO	RO	RO	RO	RO	RO	RO	RO	RO	RO	RO	RO	RO	RO	RO	RO
Reset	1	1	1	1	1	1	1	1	1	1	1	1	1	1	1	1
	15	14	13	12	11	10	9	8	7	6	5	4	3	2	1	0
	ADC0AIN15	ADC0AIN14	ADC0AIN13	ADC0AIN12	ADC0AIN11	ADC0AIN10	ADC0AIN9	ADC0AIN8	ADC0AIN7	ADC0AIN6	ADC0AIN5	ADC0AIN4	ADC0AIN3	ADC0AIN2	ADC0AIN1	ADC0AIN0
Type	RO	RO	RO	RO	RO	RO	RO	RO	RO	RO	RO	RO	RO	RO	RO	RO
Reset	1	1	1	1	1	1	1	1	1	1	1	1	1	1	1	1

Bit/Field	Name	Type	Reset	Description
31	ADC1AIN15	RO	1	ADC Module 1 AIN15 Pin Present When set, indicates that ADC module 1 input pin 15 is present.
30	ADC1AIN14	RO	1	ADC Module 1 AIN14 Pin Present When set, indicates that ADC module 1 input pin 14 is present.
29	ADC1AIN13	RO	1	ADC Module 1 AIN13 Pin Present When set, indicates that ADC module 1 input pin 13 is present.
28	ADC1AIN12	RO	1	ADC Module 1 AIN12 Pin Present When set, indicates that ADC module 1 input pin 12 is present.
27	ADC1AIN11	RO	1	ADC Module 1 AIN11 Pin Present When set, indicates that ADC module 1 input pin 11 is present.
26	ADC1AIN10	RO	1	ADC Module 1 AIN10 Pin Present When set, indicates that ADC module 1 input pin 10 is present.
25	ADC1AIN9	RO	1	ADC Module 1 AIN9 Pin Present When set, indicates that ADC module 1 input pin 9 is present.
24	ADC1AIN8	RO	1	ADC Module 1 AIN8 Pin Present When set, indicates that ADC module 1 input pin 8 is present.
23	ADC1AIN7	RO	1	ADC Module 1 AIN7 Pin Present When set, indicates that ADC module 1 input pin 7 is present.
22	ADC1AIN6	RO	1	ADC Module 1 AIN6 Pin Present When set, indicates that ADC module 1 input pin 6 is present.
21	ADC1AIN5	RO	1	ADC Module 1 AIN5 Pin Present When set, indicates that ADC module 1 input pin 5 is present.

Bit/Field	Name	Type	Reset	Description
20	ADC1AIN4	RO	1	ADC Module 1 AIN4 Pin Present When set, indicates that ADC module 1 input pin 4 is present.
19	ADC1AIN3	RO	1	ADC Module 1 AIN3 Pin Present When set, indicates that ADC module 1 input pin 3 is present.
18	ADC1AIN2	RO	1	ADC Module 1 AIN2 Pin Present When set, indicates that ADC module 1 input pin 2 is present.
17	ADC1AIN1	RO	1	ADC Module 1 AIN1 Pin Present When set, indicates that ADC module 1 input pin 1 is present.
16	ADC1AIN0	RO	1	ADC Module 1 AIN0 Pin Present When set, indicates that ADC module 1 input pin 0 is present.
15	ADC0AIN15	RO	1	ADC Module 0 AIN15 Pin Present When set, indicates that ADC module 0 input pin 15 is present.
14	ADC0AIN14	RO	1	ADC Module 0 AIN14 Pin Present When set, indicates that ADC module 0 input pin 14 is present.
13	ADC0AIN13	RO	1	ADC Module 0 AIN13 Pin Present When set, indicates that ADC module 0 input pin 13 is present.
12	ADC0AIN12	RO	1	ADC Module 0 AIN12 Pin Present When set, indicates that ADC module 0 input pin 12 is present.
11	ADC0AIN11	RO	1	ADC Module 0 AIN11 Pin Present When set, indicates that ADC module 0 input pin 11 is present.
10	ADC0AIN10	RO	1	ADC Module 0 AIN10 Pin Present When set, indicates that ADC module 0 input pin 10 is present.
9	ADC0AIN9	RO	1	ADC Module 0 AIN9 Pin Present When set, indicates that ADC module 0 input pin 9 is present.
8	ADC0AIN8	RO	1	ADC Module 0 AIN8 Pin Present When set, indicates that ADC module 0 input pin 8 is present.
7	ADC0AIN7	RO	1	ADC Module 0 AIN7 Pin Present When set, indicates that ADC module 0 input pin 7 is present.
6	ADC0AIN6	RO	1	ADC Module 0 AIN6 Pin Present When set, indicates that ADC module 0 input pin 6 is present.
5	ADC0AIN5	RO	1	ADC Module 0 AIN5 Pin Present When set, indicates that ADC module 0 input pin 5 is present.
4	ADC0AIN4	RO	1	ADC Module 0 AIN4 Pin Present When set, indicates that ADC module 0 input pin 4 is present.



---

Bit/Field	Name	Type	Reset	Description
3	ADC0AIN3	RO	1	ADC Module 0 AIN3 Pin Present When set, indicates that ADC module 0 input pin 3 is present.
2	ADC0AIN2	RO	1	ADC Module 0 AIN2 Pin Present When set, indicates that ADC module 0 input pin 2 is present.
1	ADC0AIN1	RO	1	ADC Module 0 AIN1 Pin Present When set, indicates that ADC module 0 input pin 1 is present.
0	ADC0AIN0	RO	1	ADC Module 0 AIN0 Pin Present When set, indicates that ADC module 0 input pin 0 is present.

## Register 25: Device Capabilities 9 ADC Digital Comparators (DC9), offset 0x190

This register is predefined by the part and can be used to verify features.

### Device Capabilities 9 ADC Digital Comparators (DC9)

Base 0x400F.E000

Offset 0x190

Type RO, reset 0x00FF.00FF

	31	30	29	28	27	26	25	24	23	22	21	20	19	18	17	16
	reserved								ADC1DC7	ADC1DC6	ADC1DC5	ADC1DC4	ADC1DC3	ADC1DC2	ADC1DC1	ADC1DC0
Type	RO	RO	RO	RO	RO	RO	RO	RO	RO	RO	RO	RO	RO	RO	RO	RO
Reset	0	0	0	0	0	0	0	0	1	1	1	1	1	1	1	1
	15	14	13	12	11	10	9	8	7	6	5	4	3	2	1	0
	reserved								ADC0DC7	ADC0DC6	ADC0DC5	ADC0DC4	ADC0DC3	ADC0DC2	ADC0DC1	ADC0DC0
Type	RO	RO	RO	RO	RO	RO	RO	RO	RO	RO	RO	RO	RO	RO	RO	RO
Reset	0	0	0	0	0	0	0	0	1	1	1	1	1	1	1	1

Bit/Field	Name	Type	Reset	Description
31:24	reserved	RO	0	Software should not rely on the value of a reserved bit. To provide compatibility with future products, the value of a reserved bit should be preserved across a read-modify-write operation.
23	ADC1DC7	RO	1	ADC1 DC7 Present When set, indicates that ADC module 1 Digital Comparator 7 is present.
22	ADC1DC6	RO	1	ADC1 DC6 Present When set, indicates that ADC module 1 Digital Comparator 6 is present.
21	ADC1DC5	RO	1	ADC1 DC5 Present When set, indicates that ADC module 1 Digital Comparator 5 is present.
20	ADC1DC4	RO	1	ADC1 DC4 Present When set, indicates that ADC module 1 Digital Comparator 4 is present.
19	ADC1DC3	RO	1	ADC1 DC3 Present When set, indicates that ADC module 1 Digital Comparator 3 is present.
18	ADC1DC2	RO	1	ADC1 DC2 Present When set, indicates that ADC module 1 Digital Comparator 2 is present.
17	ADC1DC1	RO	1	ADC1 DC1 Present When set, indicates that ADC module 1 Digital Comparator 1 is present.
16	ADC1DC0	RO	1	ADC1 DC0 Present When set, indicates that ADC module 1 Digital Comparator 0 is present.
15:8	reserved	RO	0	Software should not rely on the value of a reserved bit. To provide compatibility with future products, the value of a reserved bit should be preserved across a read-modify-write operation.
7	ADC0DC7	RO	1	ADC0 DC7 Present When set, indicates that ADC module 0 Digital Comparator 7 is present.

---

Bit/Field	Name	Type	Reset	Description
6	ADC0DC6	RO	1	ADC0 DC6 Present When set, indicates that ADC module 0 Digital Comparator 6 is present.
5	ADC0DC5	RO	1	ADC0 DC5 Present When set, indicates that ADC module 0 Digital Comparator 5 is present.
4	ADC0DC4	RO	1	ADC0 DC4 Present When set, indicates that ADC module 0 Digital Comparator 4 is present.
3	ADC0DC3	RO	1	ADC0 DC3 Present When set, indicates that ADC module 0 Digital Comparator 3 is present.
2	ADC0DC2	RO	1	ADC0 DC2 Present When set, indicates that ADC module 0 Digital Comparator 2 is present.
1	ADC0DC1	RO	1	ADC0 DC1 Present When set, indicates that ADC module 0 Digital Comparator 1 is present.
0	ADC0DC0	RO	1	ADC0 DC0 Present When set, indicates that ADC module 0 Digital Comparator 0 is present.

## Register 26: Non-Volatile Memory Information (NVMSTAT), offset 0x1A0

This register is predefined by the part and can be used to verify features.

### Non-Volatile Memory Information (NVMSTAT)

Base 0x400F.E000

Offset 0x1A0

Type RO, reset 0x0000.0011

	31	30	29	28	27	26	25	24	23	22	21	20	19	18	17	16	
	reserved																
Type	RO	RO	RO	RO	RO	RO	RO	RO	RO	RO	RO	RO	RO	RO	RO	RO	
Reset	0	0	0	0	0	0	0	0	0	0	0	0	0	0	0	0	
	15	14	13	12	11	10	9	8	7	6	5	4	3	2	1	0	
	reserved												TPSW	reserved			FWB
Type	RO	RO	RO	RO	RO	RO	RO	RO	RO	RO	RO	RO	RO	RO	RO	RO	
Reset	0	0	0	0	0	0	0	0	0	0	0	1	0	0	0	1	

Bit/Field	Name	Type	Reset	Description
31:5	reserved	RO	0	Software should not rely on the value of a reserved bit. To provide compatibility with future products, the value of a reserved bit should be preserved across a read-modify-write operation.
4	TPSW	RO	1	Third Party Software Present When set, indicates that the ROM contains third party software.
3:1	reserved	RO	0	Software should not rely on the value of a reserved bit. To provide compatibility with future products, the value of a reserved bit should be preserved across a read-modify-write operation.
0	FWB	RO	1	32 Word Flash Write Buffer Active When set, indicates that the 32 word Flash memory write buffer feature is active.

## Register 27: Run Mode Clock Gating Control Register 0 (RCGC0), offset 0x100

This register controls the clock gating logic in normal Run mode. Each bit controls a clock enable for a given interface, function, or module. If set, the module receives a clock and functions. Otherwise, the module is unlocked and disabled (saving power). If the module is unlocked, reads or writes to the module generate a bus fault. The reset state of these bits is 0 (unlocked) unless otherwise noted, so that all functional modules are disabled. It is the responsibility of software to enable the ports necessary for the application. Note that these registers may contain more bits than there are interfaces, functions, or modules to control. This configuration is implemented to assure reasonable code compatibility with other family and future parts. **RCGC0** is the clock configuration register for running operation, **SCGC0** for Sleep operation, and **DCGC0** for Deep-Sleep operation. Setting the **ACG** bit in the **Run-Mode Clock Configuration (RCC)** register specifies that the system uses sleep modes.

### Run Mode Clock Gating Control Register 0 (RCGC0)

Base 0x400F.E000

Offset 0x100

Type R/W, reset 0x00000040

	31	30	29	28	27	26	25	24	23	22	21	20	19	18	17	16
	reserved			WDT1	reserved		CAN1	CAN0	reserved			PWM	reserved		ADC1	ADC0
Type	RO	RO	RO	R/W	RO	RO	R/W	R/W	RO	RO	RO	R/W	RO	RO	R/W	R/W
Reset	0	0	0	0	0	0	0	0	0	0	0	0	0	0	0	0
	15	14	13	12	11	10	9	8	7	6	5	4	3	2	1	0
	reserved				MAXADC1SPD		MAXADC0SPD		reserved	reserved	reserved		WDT0	reserved		
Type	RO	RO	RO	RO	R/W	R/W	R/W	R/W	RO	RO	RO	RO	R/W	RO	RO	RO
Reset	0	0	0	0	0	0	0	0	0	1	0	0	0	0	0	0

Bit/Field	Name	Type	Reset	Description
31:29	reserved	RO	0	Software should not rely on the value of a reserved bit. To provide compatibility with future products, the value of a reserved bit should be preserved across a read-modify-write operation.
28	WDT1	R/W	0	WDT1 Clock Gating Control  This bit controls the clock gating for the Watchdog Timer module 1. If set, the module receives a clock and functions. Otherwise, the module is unlocked and disabled. If the module is unlocked, a read or write to the module generates a bus fault.
27:26	reserved	RO	0	Software should not rely on the value of a reserved bit. To provide compatibility with future products, the value of a reserved bit should be preserved across a read-modify-write operation.
25	CAN1	R/W	0	CAN1 Clock Gating Control  This bit controls the clock gating for CAN module 1. If set, the module receives a clock and functions. Otherwise, the module is unlocked and disabled. If the module is unlocked, a read or write to the module generates a bus fault.
24	CAN0	R/W	0	CAN0 Clock Gating Control  This bit controls the clock gating for CAN module 0. If set, the module receives a clock and functions. Otherwise, the module is unlocked and disabled. If the module is unlocked, a read or write to the module generates a bus fault.

Bit/Field	Name	Type	Reset	Description										
23:21	reserved	RO	0	Software should not rely on the value of a reserved bit. To provide compatibility with future products, the value of a reserved bit should be preserved across a read-modify-write operation.										
20	PWM	R/W	0	<p>PWM Clock Gating Control</p> <p>This bit controls the clock gating for the PWM module. If set, the module receives a clock and functions. Otherwise, the module is unlocked and disabled. If the module is unlocked, a read or write to the module generates a bus fault.</p>										
19:18	reserved	RO	0	Software should not rely on the value of a reserved bit. To provide compatibility with future products, the value of a reserved bit should be preserved across a read-modify-write operation.										
17	ADC1	R/W	0	<p>ADC1 Clock Gating Control</p> <p>This bit controls the clock gating for SAR ADC module 1. If set, the module receives a clock and functions. Otherwise, the module is unlocked and disabled. If the module is unlocked, a read or write to the module generates a bus fault.</p>										
16	ADC0	R/W	0	<p>ADC0 Clock Gating Control</p> <p>This bit controls the clock gating for ADC module 0. If set, the module receives a clock and functions. Otherwise, the module is unlocked and disabled. If the module is unlocked, a read or write to the module generates a bus fault.</p>										
15:12	reserved	RO	0	Software should not rely on the value of a reserved bit. To provide compatibility with future products, the value of a reserved bit should be preserved across a read-modify-write operation.										
11:10	MAXADC1SPD	R/W	0	<p>ADC1 Sample Speed</p> <p>This field sets the rate at which ADC module 1 samples data. You cannot set the rate higher than the maximum rate. You can set the sample rate by setting the MAXADC1SPD bit as follows (all other encodings are reserved):</p> <table border="1"> <thead> <tr> <th>Value</th> <th>Description</th> </tr> </thead> <tbody> <tr> <td>0x3</td> <td>1M samples/second</td> </tr> <tr> <td>0x2</td> <td>500K samples/second</td> </tr> <tr> <td>0x1</td> <td>250K samples/second</td> </tr> <tr> <td>0x0</td> <td>125K samples/second</td> </tr> </tbody> </table>	Value	Description	0x3	1M samples/second	0x2	500K samples/second	0x1	250K samples/second	0x0	125K samples/second
Value	Description													
0x3	1M samples/second													
0x2	500K samples/second													
0x1	250K samples/second													
0x0	125K samples/second													
9:8	MAXADC0SPD	R/W	0	<p>ADC0 Sample Speed</p> <p>This field sets the rate at which ADC0 samples data. You cannot set the rate higher than the maximum rate. You can set the sample rate by setting the MAXADC0SPD bit as follows (all other encodings are reserved):</p> <table border="1"> <thead> <tr> <th>Value</th> <th>Description</th> </tr> </thead> <tbody> <tr> <td>0x3</td> <td>1M samples/second</td> </tr> <tr> <td>0x2</td> <td>500K samples/second</td> </tr> <tr> <td>0x1</td> <td>250K samples/second</td> </tr> <tr> <td>0x0</td> <td>125K samples/second</td> </tr> </tbody> </table>	Value	Description	0x3	1M samples/second	0x2	500K samples/second	0x1	250K samples/second	0x0	125K samples/second
Value	Description													
0x3	1M samples/second													
0x2	500K samples/second													
0x1	250K samples/second													
0x0	125K samples/second													

---

Bit/Field	Name	Type	Reset	Description
7	reserved	RO	0	Software should not rely on the value of a reserved bit. To provide compatibility with future products, the value of a reserved bit should be preserved across a read-modify-write operation.
6	reserved	RO	1	Software should not rely on the value of a reserved bit. To provide compatibility with future products, the value of a reserved bit should be preserved across a read-modify-write operation.
5:4	reserved	RO	0	Software should not rely on the value of a reserved bit. To provide compatibility with future products, the value of a reserved bit should be preserved across a read-modify-write operation.
3	WDT0	R/W	0	WDT0 Clock Gating Control  This bit controls the clock gating for the Watchdog Timer module 0. If set, the module receives a clock and functions. Otherwise, the module is unclocked and disabled. If the module is unclocked, a read or write to the module generates a bus fault.
2:0	reserved	RO	0	Software should not rely on the value of a reserved bit. To provide compatibility with future products, the value of a reserved bit should be preserved across a read-modify-write operation.

## Register 28: Sleep Mode Clock Gating Control Register 0 (SCGC0), offset 0x110

This register controls the clock gating logic in Sleep mode. Each bit controls a clock enable for a given interface, function, or module. If set, the module receives a clock and functions. Otherwise, the module is unlocked and disabled (saving power). If the module is unlocked, reads or writes to the module generate a bus fault. The reset state of these bits is 0 (unlocked) unless otherwise noted, so that all functional modules are disabled. It is the responsibility of software to enable the ports necessary for the application. Note that these registers may contain more bits than there are interfaces, functions, or modules to control. This configuration is implemented to assure reasonable code compatibility with other family and future parts. **RCGC0** is the clock configuration register for running operation, **SCGC0** for Sleep operation, and **DCGC0** for Deep-Sleep operation. Setting the **ACG** bit in the **Run-Mode Clock Configuration (RCC)** register specifies that the system uses sleep modes.

### Sleep Mode Clock Gating Control Register 0 (SCGC0)

Base 0x400F.E000  
Offset 0x110  
Type R/W, reset 0x00000040

	31	30	29	28	27	26	25	24	23	22	21	20	19	18	17	16
	reserved			WDT1	reserved		CAN1	CAN0	reserved			PWM	reserved		ADC1	ADC0
Type	RO	RO	RO	R/W	RO	RO	R/W	R/W	RO	RO	RO	R/W	RO	RO	R/W	R/W
Reset	0	0	0	0	0	0	0	0	0	0	0	0	0	0	0	0
	15	14	13	12	11	10	9	8	7	6	5	4	3	2	1	0
	reserved				MAXADC1SPD		MAXADC0SPD		reserved	reserved	reserved		WDT0	reserved		
Type	RO	RO	RO	RO	R/W	R/W	R/W	R/W	RO	RO	RO	RO	R/W	RO	RO	RO
Reset	0	0	0	0	0	0	0	0	0	1	0	0	0	0	0	0

Bit/Field	Name	Type	Reset	Description
31:29	reserved	RO	0	Software should not rely on the value of a reserved bit. To provide compatibility with future products, the value of a reserved bit should be preserved across a read-modify-write operation.
28	WDT1	R/W	0	WDT1 Clock Gating Control  This bit controls the clock gating for Watchdog Timer module 1. If set, the module receives a clock and functions. Otherwise, the module is unlocked and disabled. If the module is unlocked, a read or write to the module generates a bus fault.
27:26	reserved	RO	0	Software should not rely on the value of a reserved bit. To provide compatibility with future products, the value of a reserved bit should be preserved across a read-modify-write operation.
25	CAN1	R/W	0	CAN1 Clock Gating Control  This bit controls the clock gating for CAN module 1. If set, the module receives a clock and functions. Otherwise, the module is unlocked and disabled. If the module is unlocked, a read or write to the module generates a bus fault.
24	CAN0	R/W	0	CAN0 Clock Gating Control  This bit controls the clock gating for CAN module 0. If set, the module receives a clock and functions. Otherwise, the module is unlocked and disabled. If the module is unlocked, a read or write to the module generates a bus fault.



Bit/Field	Name	Type	Reset	Description										
23:21	reserved	RO	0	Software should not rely on the value of a reserved bit. To provide compatibility with future products, the value of a reserved bit should be preserved across a read-modify-write operation.										
20	PWM	R/W	0	<p>PWM Clock Gating Control</p> <p>This bit controls the clock gating for the PWM module. If set, the module receives a clock and functions. Otherwise, the module is unlocked and disabled. If the module is unlocked, a read or write to the module generates a bus fault.</p>										
19:18	reserved	RO	0	Software should not rely on the value of a reserved bit. To provide compatibility with future products, the value of a reserved bit should be preserved across a read-modify-write operation.										
17	ADC1	R/W	0	<p>ADC1 Clock Gating Control</p> <p>This bit controls the clock gating for ADC module 1. If set, the module receives a clock and functions. Otherwise, the module is unlocked and disabled. If the module is unlocked, a read or write to the module generates a bus fault.</p>										
16	ADC0	R/W	0	<p>ADC0 Clock Gating Control</p> <p>This bit controls the clock gating for ADC module 0. If set, the module receives a clock and functions. Otherwise, the module is unlocked and disabled. If the module is unlocked, a read or write to the module generates a bus fault.</p>										
15:12	reserved	RO	0	Software should not rely on the value of a reserved bit. To provide compatibility with future products, the value of a reserved bit should be preserved across a read-modify-write operation.										
11:10	MAXADC1SPD	R/W	0	<p>ADC1 Sample Speed</p> <p>This field sets the rate at which ADC module 1 samples data. You cannot set the rate higher than the maximum rate. You can set the sample rate by setting the MAXADC1SPD bit as follows (all other encodings are reserved):</p> <table border="1"> <thead> <tr> <th>Value</th> <th>Description</th> </tr> </thead> <tbody> <tr> <td>0x3</td> <td>1M samples/second</td> </tr> <tr> <td>0x2</td> <td>500K samples/second</td> </tr> <tr> <td>0x1</td> <td>250K samples/second</td> </tr> <tr> <td>0x0</td> <td>125K samples/second</td> </tr> </tbody> </table>	Value	Description	0x3	1M samples/second	0x2	500K samples/second	0x1	250K samples/second	0x0	125K samples/second
Value	Description													
0x3	1M samples/second													
0x2	500K samples/second													
0x1	250K samples/second													
0x0	125K samples/second													

Bit/Field	Name	Type	Reset	Description										
9:8	MAXADC0SPD	R/W	0	<p>ADC0 Sample Speed</p> <p>This field sets the rate at which ADC module 0 samples data. You cannot set the rate higher than the maximum rate. You can set the sample rate by setting the MAXADC0SPD bit as follows (all other encodings are reserved):</p> <table border="1"> <thead> <tr> <th>Value</th> <th>Description</th> </tr> </thead> <tbody> <tr> <td>0x3</td> <td>1M samples/second</td> </tr> <tr> <td>0x2</td> <td>500K samples/second</td> </tr> <tr> <td>0x1</td> <td>250K samples/second</td> </tr> <tr> <td>0x0</td> <td>125K samples/second</td> </tr> </tbody> </table>	Value	Description	0x3	1M samples/second	0x2	500K samples/second	0x1	250K samples/second	0x0	125K samples/second
Value	Description													
0x3	1M samples/second													
0x2	500K samples/second													
0x1	250K samples/second													
0x0	125K samples/second													
7	reserved	RO	0	Software should not rely on the value of a reserved bit. To provide compatibility with future products, the value of a reserved bit should be preserved across a read-modify-write operation.										
6	reserved	RO	1	Software should not rely on the value of a reserved bit. To provide compatibility with future products, the value of a reserved bit should be preserved across a read-modify-write operation.										
5:4	reserved	RO	0	Software should not rely on the value of a reserved bit. To provide compatibility with future products, the value of a reserved bit should be preserved across a read-modify-write operation.										
3	WDT0	R/W	0	<p>WDT0 Clock Gating Control</p> <p>This bit controls the clock gating for the Watchdog Timer module 0. If set, the module receives a clock and functions. Otherwise, the module is unclocked and disabled. If the module is unclocked, a read or write to the module generates a bus fault.</p>										
2:0	reserved	RO	0	Software should not rely on the value of a reserved bit. To provide compatibility with future products, the value of a reserved bit should be preserved across a read-modify-write operation.										

## Register 29: Deep Sleep Mode Clock Gating Control Register 0 (DCGC0), offset 0x120

This register controls the clock gating logic in Deep-Sleep mode. Each bit controls a clock enable for a given interface, function, or module. If set, the module receives a clock and functions. Otherwise, the module is unlocked and disabled (saving power). If the module is unlocked, reads or writes to the module generate a bus fault. The reset state of these bits is 0 (unlocked) unless otherwise noted, so that all functional modules are disabled. It is the responsibility of software to enable the ports necessary for the application. Note that these registers may contain more bits than there are interfaces, functions, or modules to control. This configuration is implemented to assure reasonable code compatibility with other family and future parts. **RCGC0** is the clock configuration register for running operation, **SCGC0** for Sleep operation, and **DCGC0** for Deep-Sleep operation. Setting the **ACG** bit in the **Run-Mode Clock Configuration (RCC)** register specifies that the system uses sleep modes.

### Deep Sleep Mode Clock Gating Control Register 0 (DCGC0)

Base 0x400F.E000  
Offset 0x120  
Type R/W, reset 0x00000040

	31	30	29	28	27	26	25	24	23	22	21	20	19	18	17	16
	reserved			WDT1	reserved		CAN1	CAN0	reserved			PWM	reserved		ADC1	ADC0
Type	RO	RO	RO	R/W	RO	RO	R/W	R/W	RO	RO	RO	R/W	RO	RO	R/W	R/W
Reset	0	0	0	0	0	0	0	0	0	0	0	0	0	0	0	0
	15	14	13	12	11	10	9	8	7	6	5	4	3	2	1	0
	reserved										reserved	reserved	WDT0	reserved		
Type	RO	RO	RO	RO	RO	RO	RO	RO	RO	RO	RO	RO	R/W	RO	RO	RO
Reset	0	0	0	0	0	0	0	0	0	0	1	0	0	0	0	0

Bit/Field	Name	Type	Reset	Description
31:29	reserved	RO	0	Software should not rely on the value of a reserved bit. To provide compatibility with future products, the value of a reserved bit should be preserved across a read-modify-write operation.
28	WDT1	R/W	0	WDT1 Clock Gating Control  This bit controls the clock gating for the Watchdog Timer module 1. If set, the module receives a clock and functions. Otherwise, the module is unlocked and disabled. If the module is unlocked, a read or write to the module generates a bus fault.
27:26	reserved	RO	0	Software should not rely on the value of a reserved bit. To provide compatibility with future products, the value of a reserved bit should be preserved across a read-modify-write operation.
25	CAN1	R/W	0	CAN1 Clock Gating Control  This bit controls the clock gating for CAN module 1. If set, the module receives a clock and functions. Otherwise, the module is unlocked and disabled. If the module is unlocked, a read or write to the module generates a bus fault.
24	CAN0	R/W	0	CAN0 Clock Gating Control  This bit controls the clock gating for CAN module 0. If set, the module receives a clock and functions. Otherwise, the module is unlocked and disabled. If the module is unlocked, a read or write to the module generates a bus fault.

Bit/Field	Name	Type	Reset	Description
23:21	reserved	RO	0	Software should not rely on the value of a reserved bit. To provide compatibility with future products, the value of a reserved bit should be preserved across a read-modify-write operation.
20	PWM	R/W	0	<p>PWM Clock Gating Control</p> <p>This bit controls the clock gating for the PWM module. If set, the module receives a clock and functions. Otherwise, the module is unlocked and disabled. If the module is unlocked, a read or write to the module generates a bus fault.</p>
19:18	reserved	RO	0	Software should not rely on the value of a reserved bit. To provide compatibility with future products, the value of a reserved bit should be preserved across a read-modify-write operation.
17	ADC1	R/W	0	<p>ADC1 Clock Gating Control</p> <p>This bit controls the clock gating for ADC module 1. If set, the module receives a clock and functions. Otherwise, the module is unlocked and disabled. If the module is unlocked, a read or write to the module generates a bus fault.</p>
16	ADC0	R/W	0	<p>ADC0 Clock Gating Control</p> <p>This bit controls the clock gating for ADC module 0. If set, the module receives a clock and functions. Otherwise, the module is unlocked and disabled. If the module is unlocked, a read or write to the module generates a bus fault.</p>
15:7	reserved	RO	0	Software should not rely on the value of a reserved bit. To provide compatibility with future products, the value of a reserved bit should be preserved across a read-modify-write operation.
6	reserved	RO	1	Software should not rely on the value of a reserved bit. To provide compatibility with future products, the value of a reserved bit should be preserved across a read-modify-write operation.
5:4	reserved	RO	0	Software should not rely on the value of a reserved bit. To provide compatibility with future products, the value of a reserved bit should be preserved across a read-modify-write operation.
3	WDT0	R/W	0	<p>WDT0 Clock Gating Control</p> <p>This bit controls the clock gating for the Watchdog Timer module 0. If set, the module receives a clock and functions. Otherwise, the module is unlocked and disabled. If the module is unlocked, a read or write to the module generates a bus fault.</p>
2:0	reserved	RO	0	Software should not rely on the value of a reserved bit. To provide compatibility with future products, the value of a reserved bit should be preserved across a read-modify-write operation.

## Register 30: Run Mode Clock Gating Control Register 1 (RCGC1), offset 0x104

This register controls the clock gating logic in normal Run mode. Each bit controls a clock enable for a given interface, function, or module. If set, the module receives a clock and functions. Otherwise, the module is unlocked and disabled (saving power). If the module is unlocked, reads or writes to the module generate a bus fault. The reset state of these bits is 0 (unlocked) unless otherwise noted, so that all functional modules are disabled. It is the responsibility of software to enable the ports necessary for the application. Note that these registers may contain more bits than there are interfaces, functions, or modules to control. This configuration is implemented to assure reasonable code compatibility with other family and future parts. **RCGC1** is the clock configuration register for running operation, **SCGC1** for Sleep operation, and **DCGC1** for Deep-Sleep operation. Setting the **ACG** bit in the **Run-Mode Clock Configuration (RCC)** register specifies that the system uses sleep modes.

### Run Mode Clock Gating Control Register 1 (RCGC1)

Base 0x400F.E000

Offset 0x104

Type R/W, reset 0x00000000

	31	30	29	28	27	26	25	24	23	22	21	20	19	18	17	16
	reserved	EPI0	reserved	I2S0	reserved	COMP2	COMP1	COMP0	reserved			TIMER3	TIMER2	TIMER1	TIMER0	
Type	RO	R/W	RO	R/W	RO	R/W	R/W	R/W	RO	RO	RO	RO	R/W	R/W	R/W	R/W
Reset	0	0	0	0	0	0	0	0	0	0	0	0	0	0	0	0
	15	14	13	12	11	10	9	8	7	6	5	4	3	2	1	0
	reserved	I2C1	reserved	I2C0	reserved		QE11	QE10	reserved		SSI1	SSI0	reserved	UART2	UART1	UART0
Type	RO	R/W	RO	R/W	RO	RO	R/W	R/W	RO	RO	R/W	R/W	RO	R/W	R/W	R/W
Reset	0	0	0	0	0	0	0	0	0	0	0	0	0	0	0	0

Bit/Field	Name	Type	Reset	Description
31	reserved	RO	0	Software should not rely on the value of a reserved bit. To provide compatibility with future products, the value of a reserved bit should be preserved across a read-modify-write operation.
30	EPI0	R/W	0	EPI0 Clock Gating  This bit controls the clock gating for EPI module 0. If set, the module receives a clock and functions. Otherwise, the module is unlocked and disabled. If the module is unlocked, a read or write to the module generates a bus fault.
29	reserved	RO	0	Software should not rely on the value of a reserved bit. To provide compatibility with future products, the value of a reserved bit should be preserved across a read-modify-write operation.
28	I2S0	R/W	0	I2S0 Clock Gating  This bit controls the clock gating for I2S module 0. If set, the module receives a clock and functions. Otherwise, the module is unlocked and disabled. If the module is unlocked, a read or write to the module generates a bus fault.
27	reserved	RO	0	Software should not rely on the value of a reserved bit. To provide compatibility with future products, the value of a reserved bit should be preserved across a read-modify-write operation.

Bit/Field	Name	Type	Reset	Description
26	COMP2	R/W	0	<p>Analog Comparator 2 Clock Gating</p> <p>This bit controls the clock gating for analog comparator 2. If set, the module receives a clock and functions. Otherwise, the module is unlocked and disabled. If the module is unlocked, a read or write to the module generates a bus fault.</p>
25	COMP1	R/W	0	<p>Analog Comparator 1 Clock Gating</p> <p>This bit controls the clock gating for analog comparator 1. If set, the module receives a clock and functions. Otherwise, the module is unlocked and disabled. If the module is unlocked, a read or write to the module generates a bus fault.</p>
24	COMP0	R/W	0	<p>Analog Comparator 0 Clock Gating</p> <p>This bit controls the clock gating for analog comparator 0. If set, the module receives a clock and functions. Otherwise, the module is unlocked and disabled. If the module is unlocked, a read or write to the module generates a bus fault.</p>
23:20	reserved	RO	0	<p>Software should not rely on the value of a reserved bit. To provide compatibility with future products, the value of a reserved bit should be preserved across a read-modify-write operation.</p>
19	TIMER3	R/W	0	<p>Timer 3 Clock Gating Control</p> <p>This bit controls the clock gating for General-Purpose Timer module 3. If set, the module receives a clock and functions. Otherwise, the module is unlocked and disabled. If the module is unlocked, a read or write to the module generates a bus fault.</p>
18	TIMER2	R/W	0	<p>Timer 2 Clock Gating Control</p> <p>This bit controls the clock gating for General-Purpose Timer module 2. If set, the module receives a clock and functions. Otherwise, the module is unlocked and disabled. If the module is unlocked, a read or write to the module generates a bus fault.</p>
17	TIMER1	R/W	0	<p>Timer 1 Clock Gating Control</p> <p>This bit controls the clock gating for General-Purpose Timer module 1. If set, the module receives a clock and functions. Otherwise, the module is unlocked and disabled. If the module is unlocked, a read or write to the module generates a bus fault.</p>
16	TIMER0	R/W	0	<p>Timer 0 Clock Gating Control</p> <p>This bit controls the clock gating for General-Purpose Timer module 0. If set, the module receives a clock and functions. Otherwise, the module is unlocked and disabled. If the module is unlocked, a read or write to the module generates a bus fault.</p>
15	reserved	RO	0	<p>Software should not rely on the value of a reserved bit. To provide compatibility with future products, the value of a reserved bit should be preserved across a read-modify-write operation.</p>
14	I2C1	R/W	0	<p>I2C1 Clock Gating Control</p> <p>This bit controls the clock gating for I2C module 1. If set, the module receives a clock and functions. Otherwise, the module is unlocked and disabled. If the module is unlocked, a read or write to the module generates a bus fault.</p>

Bit/Field	Name	Type	Reset	Description
13	reserved	RO	0	Software should not rely on the value of a reserved bit. To provide compatibility with future products, the value of a reserved bit should be preserved across a read-modify-write operation.
12	I2C0	R/W	0	I2C0 Clock Gating Control  This bit controls the clock gating for I2C module 0. If set, the module receives a clock and functions. Otherwise, the module is unlocked and disabled. If the module is unlocked, a read or write to the module generates a bus fault.
11:10	reserved	RO	0	Software should not rely on the value of a reserved bit. To provide compatibility with future products, the value of a reserved bit should be preserved across a read-modify-write operation.
9	QE11	R/W	0	QE11 Clock Gating Control  This bit controls the clock gating for QE1 module 1. If set, the module receives a clock and functions. Otherwise, the module is unlocked and disabled. If the module is unlocked, a read or write to the module generates a bus fault.
8	QE10	R/W	0	QE10 Clock Gating Control  This bit controls the clock gating for QE1 module 0. If set, the module receives a clock and functions. Otherwise, the module is unlocked and disabled. If the module is unlocked, a read or write to the module generates a bus fault.
7:6	reserved	RO	0	Software should not rely on the value of a reserved bit. To provide compatibility with future products, the value of a reserved bit should be preserved across a read-modify-write operation.
5	SSI1	R/W	0	SSI1 Clock Gating Control  This bit controls the clock gating for SSI module 1. If set, the module receives a clock and functions. Otherwise, the module is unlocked and disabled. If the module is unlocked, a read or write to the module generates a bus fault.
4	SSI0	R/W	0	SSI0 Clock Gating Control  This bit controls the clock gating for SSI module 0. If set, the module receives a clock and functions. Otherwise, the module is unlocked and disabled. If the module is unlocked, a read or write to the module generates a bus fault.
3	reserved	RO	0	Software should not rely on the value of a reserved bit. To provide compatibility with future products, the value of a reserved bit should be preserved across a read-modify-write operation.
2	UART2	R/W	0	UART2 Clock Gating Control  This bit controls the clock gating for UART module 2. If set, the module receives a clock and functions. Otherwise, the module is unlocked and disabled. If the module is unlocked, a read or write to the module generates a bus fault.

Bit/Field	Name	Type	Reset	Description
1	UART1	R/W	0	UART1 Clock Gating Control  This bit controls the clock gating for UART module 1. If set, the module receives a clock and functions. Otherwise, the module is unclocked and disabled. If the module is unclocked, a read or write to the module generates a bus fault.
0	UART0	R/W	0	UART0 Clock Gating Control  This bit controls the clock gating for UART module 0. If set, the module receives a clock and functions. Otherwise, the module is unclocked and disabled. If the module is unclocked, a read or write to the module generates a bus fault.



## Register 31: Sleep Mode Clock Gating Control Register 1 (SCGC1), offset 0x114

This register controls the clock gating logic in Sleep mode. Each bit controls a clock enable for a given interface, function, or module. If set, the module receives a clock and functions. Otherwise, the module is unclocked and disabled (saving power). If the module is unclocked, reads or writes to the module generate a bus fault. The reset state of these bits is 0 (unclocked) unless otherwise noted, so that all functional modules are disabled. It is the responsibility of software to enable the ports necessary for the application. Note that these registers may contain more bits than there are interfaces, functions, or modules to control. This configuration is implemented to assure reasonable code compatibility with other family and future parts. **RCGC1** is the clock configuration register for running operation, **SCGC1** for Sleep operation, and **DCGC1** for Deep-Sleep operation. Setting the **ACG** bit in the **Run-Mode Clock Configuration (RCC)** register specifies that the system uses sleep modes.

### Sleep Mode Clock Gating Control Register 1 (SCGC1)

Base 0x400F.E000

Offset 0x114

Type R/W, reset 0x00000000

	31	30	29	28	27	26	25	24	23	22	21	20	19	18	17	16
	reserved	EPI0	reserved	I2S0	reserved	COMP2	COMP1	COMP0	reserved			TIMER3	TIMER2	TIMER1	TIMER0	
Type	RO	R/W	RO	R/W	RO	R/W	R/W	R/W	RO	RO	RO	RO	R/W	R/W	R/W	R/W
Reset	0	0	0	0	0	0	0	0	0	0	0	0	0	0	0	0
	15	14	13	12	11	10	9	8	7	6	5	4	3	2	1	0
	reserved	I2C1	reserved	I2C0	reserved		QE1	QE0	reserved		SSI1	SSI0	reserved	UART2	UART1	UART0
Type	RO	R/W	RO	R/W	RO	RO	R/W	R/W	RO	RO	R/W	R/W	RO	R/W	R/W	R/W
Reset	0	0	0	0	0	0	0	0	0	0	0	0	0	0	0	0

Bit/Field	Name	Type	Reset	Description
31	reserved	RO	0	Software should not rely on the value of a reserved bit. To provide compatibility with future products, the value of a reserved bit should be preserved across a read-modify-write operation.
30	EPI0	R/W	0	EPI0 Clock Gating  This bit controls the clock gating for EPI module 0. If set, the module receives a clock and functions. Otherwise, the module is unclocked and disabled. If the module is unclocked, a read or write to the module generates a bus fault.
29	reserved	RO	0	Software should not rely on the value of a reserved bit. To provide compatibility with future products, the value of a reserved bit should be preserved across a read-modify-write operation.
28	I2S0	R/W	0	I2S0 Clock Gating  This bit controls the clock gating for I2S module 0. If set, the module receives a clock and functions. Otherwise, the module is unclocked and disabled. If the module is unclocked, a read or write to the module generates a bus fault.
27	reserved	RO	0	Software should not rely on the value of a reserved bit. To provide compatibility with future products, the value of a reserved bit should be preserved across a read-modify-write operation.

Bit/Field	Name	Type	Reset	Description
26	COMP2	R/W	0	<p>Analog Comparator 2 Clock Gating</p> <p>This bit controls the clock gating for analog comparator 2. If set, the module receives a clock and functions. Otherwise, the module is unlocked and disabled. If the module is unlocked, a read or write to the module generates a bus fault.</p>
25	COMP1	R/W	0	<p>Analog Comparator 1 Clock Gating</p> <p>This bit controls the clock gating for analog comparator 1. If set, the module receives a clock and functions. Otherwise, the module is unlocked and disabled. If the module is unlocked, a read or write to the module generates a bus fault.</p>
24	COMP0	R/W	0	<p>Analog Comparator 0 Clock Gating</p> <p>This bit controls the clock gating for analog comparator 0. If set, the module receives a clock and functions. Otherwise, the module is unlocked and disabled. If the module is unlocked, a read or write to the module generates a bus fault.</p>
23:20	reserved	RO	0	<p>Software should not rely on the value of a reserved bit. To provide compatibility with future products, the value of a reserved bit should be preserved across a read-modify-write operation.</p>
19	TIMER3	R/W	0	<p>Timer 3 Clock Gating Control</p> <p>This bit controls the clock gating for General-Purpose Timer module 3. If set, the module receives a clock and functions. Otherwise, the module is unlocked and disabled. If the module is unlocked, a read or write to the module generates a bus fault.</p>
18	TIMER2	R/W	0	<p>Timer 2 Clock Gating Control</p> <p>This bit controls the clock gating for General-Purpose Timer module 2. If set, the module receives a clock and functions. Otherwise, the module is unlocked and disabled. If the module is unlocked, a read or write to the module generates a bus fault.</p>
17	TIMER1	R/W	0	<p>Timer 1 Clock Gating Control</p> <p>This bit controls the clock gating for General-Purpose Timer module 1. If set, the module receives a clock and functions. Otherwise, the module is unlocked and disabled. If the module is unlocked, a read or write to the module generates a bus fault.</p>
16	TIMER0	R/W	0	<p>Timer 0 Clock Gating Control</p> <p>This bit controls the clock gating for General-Purpose Timer module 0. If set, the module receives a clock and functions. Otherwise, the module is unlocked and disabled. If the module is unlocked, a read or write to the module generates a bus fault.</p>
15	reserved	RO	0	<p>Software should not rely on the value of a reserved bit. To provide compatibility with future products, the value of a reserved bit should be preserved across a read-modify-write operation.</p>
14	I2C1	R/W	0	<p>I2C1 Clock Gating Control</p> <p>This bit controls the clock gating for I2C module 1. If set, the module receives a clock and functions. Otherwise, the module is unlocked and disabled. If the module is unlocked, a read or write to the module generates a bus fault.</p>

Bit/Field	Name	Type	Reset	Description
13	reserved	RO	0	Software should not rely on the value of a reserved bit. To provide compatibility with future products, the value of a reserved bit should be preserved across a read-modify-write operation.
12	I2C0	R/W	0	I2C0 Clock Gating Control  This bit controls the clock gating for I2C module 0. If set, the module receives a clock and functions. Otherwise, the module is unlocked and disabled. If the module is unlocked, a read or write to the module generates a bus fault.
11:10	reserved	RO	0	Software should not rely on the value of a reserved bit. To provide compatibility with future products, the value of a reserved bit should be preserved across a read-modify-write operation.
9	QE11	R/W	0	QE11 Clock Gating Control  This bit controls the clock gating for QE1 module 1. If set, the module receives a clock and functions. Otherwise, the module is unlocked and disabled. If the module is unlocked, a read or write to the module generates a bus fault.
8	QE10	R/W	0	QE10 Clock Gating Control  This bit controls the clock gating for QE1 module 0. If set, the module receives a clock and functions. Otherwise, the module is unlocked and disabled. If the module is unlocked, a read or write to the module generates a bus fault.
7:6	reserved	RO	0	Software should not rely on the value of a reserved bit. To provide compatibility with future products, the value of a reserved bit should be preserved across a read-modify-write operation.
5	SSI1	R/W	0	SSI1 Clock Gating Control  This bit controls the clock gating for SSI module 1. If set, the module receives a clock and functions. Otherwise, the module is unlocked and disabled. If the module is unlocked, a read or write to the module generates a bus fault.
4	SSI0	R/W	0	SSI0 Clock Gating Control  This bit controls the clock gating for SSI module 0. If set, the module receives a clock and functions. Otherwise, the module is unlocked and disabled. If the module is unlocked, a read or write to the module generates a bus fault.
3	reserved	RO	0	Software should not rely on the value of a reserved bit. To provide compatibility with future products, the value of a reserved bit should be preserved across a read-modify-write operation.
2	UART2	R/W	0	UART2 Clock Gating Control  This bit controls the clock gating for UART module 2. If set, the module receives a clock and functions. Otherwise, the module is unlocked and disabled. If the module is unlocked, a read or write to the module generates a bus fault.

Bit/Field	Name	Type	Reset	Description
1	UART1	R/W	0	UART1 Clock Gating Control  This bit controls the clock gating for UART module 1. If set, the module receives a clock and functions. Otherwise, the module is unclocked and disabled. If the module is unclocked, a read or write to the module generates a bus fault.
0	UART0	R/W	0	UART0 Clock Gating Control  This bit controls the clock gating for UART module 0. If set, the module receives a clock and functions. Otherwise, the module is unclocked and disabled. If the module is unclocked, a read or write to the module generates a bus fault.

## Register 32: Deep-Sleep Mode Clock Gating Control Register 1 (DCGC1), offset 0x124

This register controls the clock gating logic in Deep-Sleep mode. Each bit controls a clock enable for a given interface, function, or module. If set, the module receives a clock and functions. Otherwise, the module is unclocked and disabled (saving power). If the module is unclocked, reads or writes to the module generate a bus fault. The reset state of these bits is 0 (unclocked) unless otherwise noted, so that all functional modules are disabled. It is the responsibility of software to enable the ports necessary for the application. Note that these registers may contain more bits than there are interfaces, functions, or modules to control. This configuration is implemented to assure reasonable code compatibility with other family and future parts. **RCGC1** is the clock configuration register for running operation, **SCGC1** for Sleep operation, and **DCGC1** for Deep-Sleep operation. Setting the **ACG** bit in the **Run-Mode Clock Configuration (RCC)** register specifies that the system uses sleep modes.

### Deep-Sleep Mode Clock Gating Control Register 1 (DCGC1)

Base 0x400F.E000

Offset 0x124

Type R/W, reset 0x00000000

	31	30	29	28	27	26	25	24	23	22	21	20	19	18	17	16
	reserved	EPI0	reserved	I2S0	reserved	COMP2	COMP1	COMP0	reserved			TIMER3	TIMER2	TIMER1	TIMER0	
Type	RO	R/W	RO	R/W	RO	R/W	R/W	R/W	RO	RO	RO	RO	R/W	R/W	R/W	R/W
Reset	0	0	0	0	0	0	0	0	0	0	0	0	0	0	0	0
	15	14	13	12	11	10	9	8	7	6	5	4	3	2	1	0
	reserved	I2C1	reserved	I2C0	reserved		QE1	QE0	reserved		SSI1	SSI0	reserved	UART2	UART1	UART0
Type	RO	R/W	RO	R/W	RO	RO	R/W	R/W	RO	RO	R/W	R/W	RO	R/W	R/W	R/W
Reset	0	0	0	0	0	0	0	0	0	0	0	0	0	0	0	0

Bit/Field	Name	Type	Reset	Description
31	reserved	RO	0	Software should not rely on the value of a reserved bit. To provide compatibility with future products, the value of a reserved bit should be preserved across a read-modify-write operation.
30	EPI0	R/W	0	EPI0 Clock Gating  This bit controls the clock gating for EPI module 0. If set, the module receives a clock and functions. Otherwise, the module is unclocked and disabled. If the module is unclocked, a read or write to the module generates a bus fault.
29	reserved	RO	0	Software should not rely on the value of a reserved bit. To provide compatibility with future products, the value of a reserved bit should be preserved across a read-modify-write operation.
28	I2S0	R/W	0	I2S0 Clock Gating  This bit controls the clock gating for I2S module 0. If set, the module receives a clock and functions. Otherwise, the module is unclocked and disabled. If the module is unclocked, a read or write to the module generates a bus fault.
27	reserved	RO	0	Software should not rely on the value of a reserved bit. To provide compatibility with future products, the value of a reserved bit should be preserved across a read-modify-write operation.

Bit/Field	Name	Type	Reset	Description
26	COMP2	R/W	0	<p>Analog Comparator 2 Clock Gating</p> <p>This bit controls the clock gating for analog comparator 2. If set, the module receives a clock and functions. Otherwise, the module is unlocked and disabled. If the module is unlocked, a read or write to the module generates a bus fault.</p>
25	COMP1	R/W	0	<p>Analog Comparator 1 Clock Gating</p> <p>This bit controls the clock gating for analog comparator 1. If set, the module receives a clock and functions. Otherwise, the module is unlocked and disabled. If the module is unlocked, a read or write to the module generates a bus fault.</p>
24	COMP0	R/W	0	<p>Analog Comparator 0 Clock Gating</p> <p>This bit controls the clock gating for analog comparator 0. If set, the module receives a clock and functions. Otherwise, the module is unlocked and disabled. If the module is unlocked, a read or write to the module generates a bus fault.</p>
23:20	reserved	RO	0	<p>Software should not rely on the value of a reserved bit. To provide compatibility with future products, the value of a reserved bit should be preserved across a read-modify-write operation.</p>
19	TIMER3	R/W	0	<p>Timer 3 Clock Gating Control</p> <p>This bit controls the clock gating for General-Purpose Timer module 3. If set, the module receives a clock and functions. Otherwise, the module is unlocked and disabled. If the module is unlocked, a read or write to the module generates a bus fault.</p>
18	TIMER2	R/W	0	<p>Timer 2 Clock Gating Control</p> <p>This bit controls the clock gating for General-Purpose Timer module 2. If set, the module receives a clock and functions. Otherwise, the module is unlocked and disabled. If the module is unlocked, a read or write to the module generates a bus fault.</p>
17	TIMER1	R/W	0	<p>Timer 1 Clock Gating Control</p> <p>This bit controls the clock gating for General-Purpose Timer module 1. If set, the module receives a clock and functions. Otherwise, the module is unlocked and disabled. If the module is unlocked, a read or write to the module generates a bus fault.</p>
16	TIMER0	R/W	0	<p>Timer 0 Clock Gating Control</p> <p>This bit controls the clock gating for General-Purpose Timer module 0. If set, the module receives a clock and functions. Otherwise, the module is unlocked and disabled. If the module is unlocked, a read or write to the module generates a bus fault.</p>
15	reserved	RO	0	<p>Software should not rely on the value of a reserved bit. To provide compatibility with future products, the value of a reserved bit should be preserved across a read-modify-write operation.</p>
14	I2C1	R/W	0	<p>I2C1 Clock Gating Control</p> <p>This bit controls the clock gating for I2C module 1. If set, the module receives a clock and functions. Otherwise, the module is unlocked and disabled. If the module is unlocked, a read or write to the module generates a bus fault.</p>

Bit/Field	Name	Type	Reset	Description
13	reserved	RO	0	Software should not rely on the value of a reserved bit. To provide compatibility with future products, the value of a reserved bit should be preserved across a read-modify-write operation.
12	I2C0	R/W	0	I2C0 Clock Gating Control  This bit controls the clock gating for I2C module 0. If set, the module receives a clock and functions. Otherwise, the module is unlocked and disabled. If the module is unlocked, a read or write to the module generates a bus fault.
11:10	reserved	RO	0	Software should not rely on the value of a reserved bit. To provide compatibility with future products, the value of a reserved bit should be preserved across a read-modify-write operation.
9	QE11	R/W	0	QE11 Clock Gating Control  This bit controls the clock gating for QE1 module 1. If set, the module receives a clock and functions. Otherwise, the module is unlocked and disabled. If the module is unlocked, a read or write to the module generates a bus fault.
8	QE10	R/W	0	QE10 Clock Gating Control  This bit controls the clock gating for QE1 module 0. If set, the module receives a clock and functions. Otherwise, the module is unlocked and disabled. If the module is unlocked, a read or write to the module generates a bus fault.
7:6	reserved	RO	0	Software should not rely on the value of a reserved bit. To provide compatibility with future products, the value of a reserved bit should be preserved across a read-modify-write operation.
5	SSI1	R/W	0	SSI1 Clock Gating Control  This bit controls the clock gating for SSI module 1. If set, the module receives a clock and functions. Otherwise, the module is unlocked and disabled. If the module is unlocked, a read or write to the module generates a bus fault.
4	SSI0	R/W	0	SSI0 Clock Gating Control  This bit controls the clock gating for SSI module 0. If set, the module receives a clock and functions. Otherwise, the module is unlocked and disabled. If the module is unlocked, a read or write to the module generates a bus fault.
3	reserved	RO	0	Software should not rely on the value of a reserved bit. To provide compatibility with future products, the value of a reserved bit should be preserved across a read-modify-write operation.
2	UART2	R/W	0	UART2 Clock Gating Control  This bit controls the clock gating for UART module 2. If set, the module receives a clock and functions. Otherwise, the module is unlocked and disabled. If the module is unlocked, a read or write to the module generates a bus fault.

Bit/Field	Name	Type	Reset	Description
1	UART1	R/W	0	UART1 Clock Gating Control  This bit controls the clock gating for UART module 1. If set, the module receives a clock and functions. Otherwise, the module is unclocked and disabled. If the module is unclocked, a read or write to the module generates a bus fault.
0	UART0	R/W	0	UART0 Clock Gating Control  This bit controls the clock gating for UART module 0. If set, the module receives a clock and functions. Otherwise, the module is unclocked and disabled. If the module is unclocked, a read or write to the module generates a bus fault.



### Register 33: Run Mode Clock Gating Control Register 2 (RCGC2), offset 0x108

This register controls the clock gating logic in normal Run mode. Each bit controls a clock enable for a given interface, function, or module. If set, the module receives a clock and functions. Otherwise, the module is unlocked and disabled (saving power). If the module is unlocked, reads or writes to the module generate a bus fault. The reset state of these bits is 0 (unlocked) unless otherwise noted, so that all functional modules are disabled. It is the responsibility of software to enable the ports necessary for the application. Note that these registers may contain more bits than there are interfaces, functions, or modules to control. This configuration is implemented to assure reasonable code compatibility with other family and future parts. **RCGC2** is the clock configuration register for running operation, **SCGC2** for Sleep operation, and **DCGC2** for Deep-Sleep operation. Setting the **ACG** bit in the **Run-Mode Clock Configuration (RCC)** register specifies that the system uses sleep modes.

#### Run Mode Clock Gating Control Register 2 (RCGC2)

Base 0x400F.E000

Offset 0x108

Type R/W, reset 0x00000000

	31	30	29	28	27	26	25	24	23	22	21	20	19	18	17	16	
	reserved	EPHY0	reserved	EMAC0	reserved											USB0	
Type	RO	R/W	RO	R/W	RO	RO	RO	RO	RO	RO	RO	RO	RO	RO	RO	RO	R/W
Reset	0	0	0	0	0	0	0	0	0	0	0	0	0	0	0	0	0
	15	14	13	12	11	10	9	8	7	6	5	4	3	2	1	0	
	reserved		UDMA	reserved				GPIOJ	GPIOH	GPIOG	GPIOF	GPIOE	GIPOD	GPIOC	GPIOB	GPIOA	
Type	RO	RO	R/W	RO	RO	RO	RO	R/W	R/W	R/W	R/W	R/W	R/W	R/W	R/W	R/W	R/W
Reset	0	0	0	0	0	0	0	0	0	0	0	0	0	0	0	0	0

Bit/Field	Name	Type	Reset	Description
31	reserved	RO	0	Software should not rely on the value of a reserved bit. To provide compatibility with future products, the value of a reserved bit should be preserved across a read-modify-write operation.
30	EPHY0	R/W	0	PHY0 Clock Gating Control  This bit controls the clock gating for Ethernet PHY layer 0. If set, the module receives a clock and functions. Otherwise, the module is unlocked and disabled. If the module is unlocked, a read or write to the module generates a bus fault.
29	reserved	RO	0	Software should not rely on the value of a reserved bit. To provide compatibility with future products, the value of a reserved bit should be preserved across a read-modify-write operation.
28	EMAC0	R/W	0	MAC0 Clock Gating Control  This bit controls the clock gating for Ethernet MAC layer 0. If set, the module receives a clock and functions. Otherwise, the module is unlocked and disabled. If the module is unlocked, a read or write to the module generates a bus fault.
27:17	reserved	RO	0	Software should not rely on the value of a reserved bit. To provide compatibility with future products, the value of a reserved bit should be preserved across a read-modify-write operation.

Bit/Field	Name	Type	Reset	Description
16	USB0	R/W	0	<p>USB0 Clock Gating Control</p> <p>This bit controls the clock gating for USB module 0. If set, the module receives a clock and functions. Otherwise, the module is unlocked and disabled. If the module is unlocked, a read or write to the module generates a bus fault.</p>
15:14	reserved	RO	0	<p>Software should not rely on the value of a reserved bit. To provide compatibility with future products, the value of a reserved bit should be preserved across a read-modify-write operation.</p>
13	UDMA	R/W	0	<p>Micro-DMA Clock Gating Control</p> <p>This bit controls the clock gating for micro-DMA. If set, the module receives a clock and functions. Otherwise, the module is unlocked and disabled. If the module is unlocked, a read or write to the module generates a bus fault.</p>
12:9	reserved	RO	0	<p>Software should not rely on the value of a reserved bit. To provide compatibility with future products, the value of a reserved bit should be preserved across a read-modify-write operation.</p>
8	GPIOJ	R/W	0	<p>Port J Clock Gating Control</p> <p>This bit controls the clock gating for Port J. If set, the module receives a clock and functions. Otherwise, the module is unlocked and disabled. If the module is unlocked, a read or write to the module generates a bus fault.</p>
7	GPIOH	R/W	0	<p>Port H Clock Gating Control</p> <p>This bit controls the clock gating for Port H. If set, the module receives a clock and functions. Otherwise, the module is unlocked and disabled. If the module is unlocked, a read or write to the module generates a bus fault.</p>
6	GPIOG	R/W	0	<p>Port G Clock Gating Control</p> <p>This bit controls the clock gating for Port G. If set, the module receives a clock and functions. Otherwise, the module is unlocked and disabled. If the module is unlocked, a read or write to the module generates a bus fault.</p>
5	GPIOF	R/W	0	<p>Port F Clock Gating Control</p> <p>This bit controls the clock gating for Port F. If set, the module receives a clock and functions. Otherwise, the module is unlocked and disabled. If the module is unlocked, a read or write to the module generates a bus fault.</p>
4	GPIOE	R/W	0	<p>Port E Clock Gating Control</p> <p>Port E Clock Gating Control. This bit controls the clock gating for Port E. If set, the module receives a clock and functions. Otherwise, the module is unlocked and disabled. If the module is unlocked, a read or write to the module generates a bus fault.</p>
3	GPIOD	R/W	0	<p>Port D Clock Gating Control</p> <p>Port D Clock Gating Control. This bit controls the clock gating for Port D. If set, the module receives a clock and functions. Otherwise, the module is unlocked and disabled. If the module is unlocked, a read or write to the module generates a bus fault.</p>

---

Bit/Field	Name	Type	Reset	Description
2	GPIOC	R/W	0	Port C Clock Gating Control  This bit controls the clock gating for Port C. If set, the module receives a clock and functions. Otherwise, the module is unlocked and disabled. If the module is unlocked, a read or write to the module generates a bus fault.
1	GPIOB	R/W	0	Port B Clock Gating Control  This bit controls the clock gating for Port B. If set, the module receives a clock and functions. Otherwise, the module is unlocked and disabled. If the module is unlocked, a read or write to the module generates a bus fault.
0	GPIOA	R/W	0	Port A Clock Gating Control  This bit controls the clock gating for Port A. If set, the module receives a clock and functions. Otherwise, the module is unlocked and disabled. If the module is unlocked, a read or write to the module generates a bus fault.

## Register 34: Sleep Mode Clock Gating Control Register 2 (SCGC2), offset 0x118

This register controls the clock gating logic in Sleep mode. Each bit controls a clock enable for a given interface, function, or module. If set, the module receives a clock and functions. Otherwise, the module is unlocked and disabled (saving power). If the module is unlocked, reads or writes to the module generate a bus fault. The reset state of these bits is 0 (unlocked) unless otherwise noted, so that all functional modules are disabled. It is the responsibility of software to enable the ports necessary for the application. Note that these registers may contain more bits than there are interfaces, functions, or modules to control. This configuration is implemented to assure reasonable code compatibility with other family and future parts. **RCGC2** is the clock configuration register for running operation, **SCGC2** for Sleep operation, and **DCGC2** for Deep-Sleep operation. Setting the **ACG** bit in the **Run-Mode Clock Configuration (RCC)** register specifies that the system uses sleep modes.

### Sleep Mode Clock Gating Control Register 2 (SCGC2)

Base 0x400F.E000  
Offset 0x118  
Type R/W, reset 0x00000000

	31	30	29	28	27	26	25	24	23	22	21	20	19	18	17	16	
	reserved	EPHY0	reserved	EMAC0	reserved											USB0	
Type	RO	R/W	RO	R/W	RO	RO	RO	RO	RO	RO	RO	RO	RO	RO	RO	RO	R/W
Reset	0	0	0	0	0	0	0	0	0	0	0	0	0	0	0	0	0
	15	14	13	12	11	10	9	8	7	6	5	4	3	2	1	0	
	reserved		UDMA	reserved				GPIOJ	GPIOH	GPIOG	GPIOF	GPIOE	GPIOD	GPIOC	GPIOB	GPIOA	
Type	RO	RO	R/W	RO	RO	RO	RO	R/W	R/W	R/W	R/W	R/W	R/W	R/W	R/W	R/W	
Reset	0	0	0	0	0	0	0	0	0	0	0	0	0	0	0	0	0

Bit/Field	Name	Type	Reset	Description
31	reserved	RO	0	Software should not rely on the value of a reserved bit. To provide compatibility with future products, the value of a reserved bit should be preserved across a read-modify-write operation.
30	EPHY0	R/W	0	PHY0 Clock Gating Control  This bit controls the clock gating for Ethernet PHY layer 0. If set, the module receives a clock and functions. Otherwise, the module is unlocked and disabled. If the module is unlocked, a read or write to the module generates a bus fault.
29	reserved	RO	0	Software should not rely on the value of a reserved bit. To provide compatibility with future products, the value of a reserved bit should be preserved across a read-modify-write operation.
28	EMAC0	R/W	0	MAC0 Clock Gating Control  This bit controls the clock gating for Ethernet MAC layer 0. If set, the module receives a clock and functions. Otherwise, the module is unlocked and disabled. If the module is unlocked, a read or write to the module generates a bus fault.
27:17	reserved	RO	0	Software should not rely on the value of a reserved bit. To provide compatibility with future products, the value of a reserved bit should be preserved across a read-modify-write operation.

Bit/Field	Name	Type	Reset	Description
16	USB0	R/W	0	<p>USB0 Clock Gating Control</p> <p>This bit controls the clock gating for USB module 0. If set, the module receives a clock and functions. Otherwise, the module is unlocked and disabled. If the module is unlocked, a read or write to the module generates a bus fault.</p>
15:14	reserved	RO	0	<p>Software should not rely on the value of a reserved bit. To provide compatibility with future products, the value of a reserved bit should be preserved across a read-modify-write operation.</p>
13	UDMA	R/W	0	<p>Micro-DMA Clock Gating Control</p> <p>This bit controls the clock gating for micro-DMA. If set, the module receives a clock and functions. Otherwise, the module is unlocked and disabled. If the module is unlocked, a read or write to the module generates a bus fault.</p>
12:9	reserved	RO	0	<p>Software should not rely on the value of a reserved bit. To provide compatibility with future products, the value of a reserved bit should be preserved across a read-modify-write operation.</p>
8	GPIOJ	R/W	0	<p>Port J Clock Gating Control</p> <p>This bit controls the clock gating for Port J. If set, the module receives a clock and functions. Otherwise, the module is unlocked and disabled. If the module is unlocked, a read or write to the module generates a bus fault.</p>
7	GPIOH	R/W	0	<p>Port H Clock Gating Control</p> <p>This bit controls the clock gating for Port H. If set, the module receives a clock and functions. Otherwise, the module is unlocked and disabled. If the module is unlocked, a read or write to the module generates a bus fault.</p>
6	GPIOG	R/W	0	<p>Port G Clock Gating Control</p> <p>This bit controls the clock gating for Port G. If set, the module receives a clock and functions. Otherwise, the module is unlocked and disabled. If the module is unlocked, a read or write to the module generates a bus fault.</p>
5	GPIOF	R/W	0	<p>Port F Clock Gating Control</p> <p>This bit controls the clock gating for Port F. If set, the module receives a clock and functions. Otherwise, the module is unlocked and disabled. If the module is unlocked, a read or write to the module generates a bus fault.</p>
4	GPIOE	R/W	0	<p>Port E Clock Gating Control</p> <p>Port E Clock Gating Control. This bit controls the clock gating for Port E. If set, the module receives a clock and functions. Otherwise, the module is unlocked and disabled. If the module is unlocked, a read or write to the module generates a bus fault.</p>
3	GPIOD	R/W	0	<p>Port D Clock Gating Control</p> <p>Port D Clock Gating Control. This bit controls the clock gating for Port D. If set, the module receives a clock and functions. Otherwise, the module is unlocked and disabled. If the module is unlocked, a read or write to the module generates a bus fault.</p>

Bit/Field	Name	Type	Reset	Description
2	GPIOC	R/W	0	Port C Clock Gating Control  This bit controls the clock gating for Port C. If set, the module receives a clock and functions. Otherwise, the module is unlocked and disabled. If the module is unlocked, a read or write to the module generates a bus fault.
1	GPIOB	R/W	0	Port B Clock Gating Control  This bit controls the clock gating for Port B. If set, the module receives a clock and functions. Otherwise, the module is unlocked and disabled. If the module is unlocked, a read or write to the module generates a bus fault.
0	GPIOA	R/W	0	Port A Clock Gating Control  This bit controls the clock gating for Port A. If set, the module receives a clock and functions. Otherwise, the module is unlocked and disabled. If the module is unlocked, a read or write to the module generates a bus fault.

## Register 35: Deep Sleep Mode Clock Gating Control Register 2 (DCGC2), offset 0x128

This register controls the clock gating logic in Deep-Sleep mode. Each bit controls a clock enable for a given interface, function, or module. If set, the module receives a clock and functions. Otherwise, the module is unclocked and disabled (saving power). If the module is unclocked, reads or writes to the module generate a bus fault. The reset state of these bits is 0 (unclocked) unless otherwise noted, so that all functional modules are disabled. It is the responsibility of software to enable the ports necessary for the application. Note that these registers may contain more bits than there are interfaces, functions, or modules to control. This configuration is implemented to assure reasonable code compatibility with other family and future parts. **RCGC2** is the clock configuration register for running operation, **SCGC2** for Sleep operation, and **DCGC2** for Deep-Sleep operation. Setting the **ACG** bit in the **Run-Mode Clock Configuration (RCC)** register specifies that the system uses sleep modes.

### Deep Sleep Mode Clock Gating Control Register 2 (DCGC2)

Base 0x400F.E000

Offset 0x128

Type R/W, reset 0x00000000

	31	30	29	28	27	26	25	24	23	22	21	20	19	18	17	16	
	reserved	EPHY0	reserved	EMAC0	reserved											USB0	
Type	RO	R/W	RO	R/W	RO	RO	RO	RO	RO	RO	RO	RO	RO	RO	RO	RO	R/W
Reset	0	0	0	0	0	0	0	0	0	0	0	0	0	0	0	0	0
	15	14	13	12	11	10	9	8	7	6	5	4	3	2	1	0	
	reserved		UDMA	reserved				GPIOJ	GPIOH	GPIOG	GPIOF	GPIOE	GPIOD	GPIOC	GPIOB	GPIOA	
Type	RO	RO	R/W	RO	RO	RO	RO	R/W	R/W	R/W	R/W	R/W	R/W	R/W	R/W	R/W	
Reset	0	0	0	0	0	0	0	0	0	0	0	0	0	0	0	0	0

Bit/Field	Name	Type	Reset	Description
31	reserved	RO	0	Software should not rely on the value of a reserved bit. To provide compatibility with future products, the value of a reserved bit should be preserved across a read-modify-write operation.
30	EPHY0	R/W	0	PHY0 Clock Gating Control  This bit controls the clock gating for Ethernet PHY layer 0. If set, the module receives a clock and functions. Otherwise, the module is unclocked and disabled. If the module is unclocked, a read or write to the module generates a bus fault.
29	reserved	RO	0	Software should not rely on the value of a reserved bit. To provide compatibility with future products, the value of a reserved bit should be preserved across a read-modify-write operation.
28	EMAC0	R/W	0	MAC0 Clock Gating Control  This bit controls the clock gating for Ethernet MAC layer 0. If set, the module receives a clock and functions. Otherwise, the module is unclocked and disabled. If the module is unclocked, a read or write to the module generates a bus fault.
27:17	reserved	RO	0	Software should not rely on the value of a reserved bit. To provide compatibility with future products, the value of a reserved bit should be preserved across a read-modify-write operation.

Bit/Field	Name	Type	Reset	Description
16	USB0	R/W	0	<p>USB0 Clock Gating Control</p> <p>This bit controls the clock gating for USB module 0. If set, the module receives a clock and functions. Otherwise, the module is unlocked and disabled. If the module is unlocked, a read or write to the module generates a bus fault.</p>
15:14	reserved	RO	0	<p>Software should not rely on the value of a reserved bit. To provide compatibility with future products, the value of a reserved bit should be preserved across a read-modify-write operation.</p>
13	UDMA	R/W	0	<p>Micro-DMA Clock Gating Control</p> <p>This bit controls the clock gating for micro-DMA. If set, the module receives a clock and functions. Otherwise, the module is unlocked and disabled. If the module is unlocked, a read or write to the module generates a bus fault.</p>
12:9	reserved	RO	0	<p>Software should not rely on the value of a reserved bit. To provide compatibility with future products, the value of a reserved bit should be preserved across a read-modify-write operation.</p>
8	GPIOJ	R/W	0	<p>Port J Clock Gating Control</p> <p>This bit controls the clock gating for Port J. If set, the module receives a clock and functions. Otherwise, the module is unlocked and disabled. If the module is unlocked, a read or write to the module generates a bus fault.</p>
7	GPIOH	R/W	0	<p>Port H Clock Gating Control</p> <p>This bit controls the clock gating for Port H. If set, the module receives a clock and functions. Otherwise, the module is unlocked and disabled. If the module is unlocked, a read or write to the module generates a bus fault.</p>
6	GPIOG	R/W	0	<p>Port G Clock Gating Control</p> <p>This bit controls the clock gating for Port G. If set, the module receives a clock and functions. Otherwise, the module is unlocked and disabled. If the module is unlocked, a read or write to the module generates a bus fault.</p>
5	GPIOF	R/W	0	<p>Port F Clock Gating Control</p> <p>This bit controls the clock gating for Port F. If set, the module receives a clock and functions. Otherwise, the module is unlocked and disabled. If the module is unlocked, a read or write to the module generates a bus fault.</p>
4	GPIOE	R/W	0	<p>Port E Clock Gating Control</p> <p>Port E Clock Gating Control. This bit controls the clock gating for Port E. If set, the module receives a clock and functions. Otherwise, the module is unlocked and disabled. If the module is unlocked, a read or write to the module generates a bus fault.</p>
3	GPIOD	R/W	0	<p>Port D Clock Gating Control</p> <p>Port D Clock Gating Control. This bit controls the clock gating for Port D. If set, the module receives a clock and functions. Otherwise, the module is unlocked and disabled. If the module is unlocked, a read or write to the module generates a bus fault.</p>



---

Bit/Field	Name	Type	Reset	Description
2	GPIOC	R/W	0	Port C Clock Gating Control  This bit controls the clock gating for Port C. If set, the module receives a clock and functions. Otherwise, the module is unlocked and disabled. If the module is unlocked, a read or write to the module generates a bus fault.
1	GPIOB	R/W	0	Port B Clock Gating Control  This bit controls the clock gating for Port B. If set, the module receives a clock and functions. Otherwise, the module is unlocked and disabled. If the module is unlocked, a read or write to the module generates a bus fault.
0	GPIOA	R/W	0	Port A Clock Gating Control  This bit controls the clock gating for Port A. If set, the module receives a clock and functions. Otherwise, the module is unlocked and disabled. If the module is unlocked, a read or write to the module generates a bus fault.

**Register 36: Software Reset Control 0 (SRCR0), offset 0x040**

This register allows individual modules to be reset. Writes to this register are masked by the bits in the **Device Capabilities 1 (DC1)** register.

## Software Reset Control 0 (SRCR0)

Base 0x400F.E000

Offset 0x040

Type R/W, reset 0x00000000

	31	30	29	28	27	26	25	24	23	22	21	20	19	18	17	16
	reserved			WDT1	reserved		CAN1	CAN0	reserved			PWM	reserved		ADC1	ADC0
Type	RO	RO	RO	R/W	RO	RO	R/W	R/W	RO	RO	RO	R/W	RO	RO	R/W	R/W
Reset	0	0	0	0	0	0	0	0	0	0	0	0	0	0	0	0
	15	14	13	12	11	10	9	8	7	6	5	4	3	2	1	0
	reserved												WDT0	reserved		
Type	RO	RO	RO	RO	RO	RO	RO	RO	RO	RO	RO	RO	R/W	RO	RO	RO
Reset	0	0	0	0	0	0	0	0	0	0	0	0	0	0	0	0

Bit/Field	Name	Type	Reset	Description
31:29	reserved	RO	0	Software should not rely on the value of a reserved bit. To provide compatibility with future products, the value of a reserved bit should be preserved across a read-modify-write operation.
28	WDT1	R/W	0	WDT1 Reset Control  When this bit is set, Watchdog Timer module 1 is reset. All internal data is lost and the registers are returned to their reset states. This bit must be manually cleared after being set.
27:26	reserved	RO	0	Software should not rely on the value of a reserved bit. To provide compatibility with future products, the value of a reserved bit should be preserved across a read-modify-write operation.
25	CAN1	R/W	0	CAN1 Reset Control  When this bit is set, CAN module 1 is reset. All internal data is lost and the registers are returned to their reset states. This bit must be manually cleared after being set.
24	CAN0	R/W	0	CAN0 Reset Control  When this bit is set, CAN module 0 is reset. All internal data is lost and the registers are returned to their reset states. This bit must be manually cleared after being set.
23:21	reserved	RO	0	Software should not rely on the value of a reserved bit. To provide compatibility with future products, the value of a reserved bit should be preserved across a read-modify-write operation.
20	PWM	R/W	0	PWM Reset Control  When this bit is set, PWM module 0 is reset. All internal data is lost and the registers are returned to their reset states. This bit must be manually cleared after being set.
19:18	reserved	RO	0	Software should not rely on the value of a reserved bit. To provide compatibility with future products, the value of a reserved bit should be preserved across a read-modify-write operation.

Bit/Field	Name	Type	Reset	Description
17	ADC1	R/W	0	ADC1 Reset Control When this bit is set, ADC module 1 is reset. All internal data is lost and the registers are returned to their reset states. This bit must be manually cleared after being set.
16	ADC0	R/W	0	ADC0 Reset Control When this bit is set, ADC module 0 is reset. All internal data is lost and the registers are returned to their reset states. This bit must be manually cleared after being set.
15:4	reserved	RO	0	Software should not rely on the value of a reserved bit. To provide compatibility with future products, the value of a reserved bit should be preserved across a read-modify-write operation.
3	WDT0	R/W	0	WDT0 Reset Control When this bit is set, Watchdog Timer module 0 is reset. All internal data is lost and the registers are returned to their reset states. This bit must be manually cleared after being set.
2:0	reserved	RO	0	Software should not rely on the value of a reserved bit. To provide compatibility with future products, the value of a reserved bit should be preserved across a read-modify-write operation.

## Register 37: Software Reset Control 1 (SRCR1), offset 0x044

This register allows individual modules to be reset. Writes to this register are masked by the bits in the **Device Capabilities 2 (DC2)** register.

### Software Reset Control 1 (SRCR1)

Base 0x400F.E000

Offset 0x044

Type R/W, reset 0x00000000

	31	30	29	28	27	26	25	24	23	22	21	20	19	18	17	16
	reserved	EPI0	reserved	I2S0	reserved	COMP2	COMP1	COMP0	reserved			TIMER3	TIMER2	TIMER1	TIMER0	
Type	RO	R/W	RO	R/W	RO	R/W	R/W	R/W	RO	RO	RO	RO	R/W	R/W	R/W	R/W
Reset	0	0	0	0	0	0	0	0	0	0	0	0	0	0	0	0
	15	14	13	12	11	10	9	8	7	6	5	4	3	2	1	0
	reserved	I2C1	reserved	I2C0	reserved		QE1	QE10	reserved		SSI1	SSI0	reserved	UART2	UART1	UART0
Type	RO	R/W	RO	R/W	RO	RO	R/W	R/W	RO	RO	R/W	R/W	RO	R/W	R/W	R/W
Reset	0	0	0	0	0	0	0	0	0	0	0	0	0	0	0	0

Bit/Field	Name	Type	Reset	Description
31	reserved	RO	0	Software should not rely on the value of a reserved bit. To provide compatibility with future products, the value of a reserved bit should be preserved across a read-modify-write operation.
30	EPI0	R/W	0	EPI0 Reset Control  When this bit is set, EPI module 0 is reset. All internal data is lost and the registers are returned to their reset states. This bit must be manually cleared after being set.
29	reserved	RO	0	Software should not rely on the value of a reserved bit. To provide compatibility with future products, the value of a reserved bit should be preserved across a read-modify-write operation.
28	I2S0	R/W	0	I2S0 Reset Control  When this bit is set, I2S module 0 is reset. All internal data is lost and the registers are returned to their reset states. This bit must be manually cleared after being set.
27	reserved	RO	0	Software should not rely on the value of a reserved bit. To provide compatibility with future products, the value of a reserved bit should be preserved across a read-modify-write operation.
26	COMP2	R/W	0	Analog Comp 2 Reset Control  When this bit is set, Analog Comparator module 2 is reset. All internal data is lost and the registers are returned to their reset states. This bit must be manually cleared after being set.
25	COMP1	R/W	0	Analog Comp 1 Reset Control  When this bit is set, Analog Comparator module 1 is reset. All internal data is lost and the registers are returned to their reset states. This bit must be manually cleared after being set.
24	COMP0	R/W	0	Analog Comp 0 Reset Control  When this bit is set, Analog Comparator module 0 is reset. All internal data is lost and the registers are returned to their reset states. This bit must be manually cleared after being set.

Bit/Field	Name	Type	Reset	Description
23:20	reserved	RO	0	Software should not rely on the value of a reserved bit. To provide compatibility with future products, the value of a reserved bit should be preserved across a read-modify-write operation.
19	TIMER3	R/W	0	Timer 3 Reset Control  Timer 3 Reset Control. When this bit is set, General-Purpose Timer module 3 is reset. All internal data is lost and the registers are returned to their reset states. This bit must be manually cleared after being set.
18	TIMER2	R/W	0	Timer 2 Reset Control  When this bit is set, General-Purpose Timer module 2 is reset. All internal data is lost and the registers are returned to their reset states. This bit must be manually cleared after being set.
17	TIMER1	R/W	0	Timer 1 Reset Control  When this bit is set, General-Purpose Timer module 1 is reset. All internal data is lost and the registers are returned to their reset states. This bit must be manually cleared after being set.
16	TIMER0	R/W	0	Timer 0 Reset Control  When this bit is set, General-Purpose Timer module 0 is reset. All internal data is lost and the registers are returned to their reset states. This bit must be manually cleared after being set.
15	reserved	RO	0	Software should not rely on the value of a reserved bit. To provide compatibility with future products, the value of a reserved bit should be preserved across a read-modify-write operation.
14	I2C1	R/W	0	I2C1 Reset Control  When this bit is set, I2C module 1 is reset. All internal data is lost and the registers are returned to their reset states. This bit must be manually cleared after being set.
13	reserved	RO	0	Software should not rely on the value of a reserved bit. To provide compatibility with future products, the value of a reserved bit should be preserved across a read-modify-write operation.
12	I2C0	R/W	0	I2C0 Reset Control  When this bit is set, I2C module 0 is reset. All internal data is lost and the registers are returned to their reset states. This bit must be manually cleared after being set.
11:10	reserved	RO	0	Software should not rely on the value of a reserved bit. To provide compatibility with future products, the value of a reserved bit should be preserved across a read-modify-write operation.
9	QE11	R/W	0	QE11 Reset Control  When this bit is set, QE1 module 1 is reset. All internal data is lost and the registers are returned to their reset states. This bit must be manually cleared after being set.
8	QE10	R/W	0	QE10 Reset Control  When this bit is set, QE1 module 0 is reset. All internal data is lost and the registers are returned to their reset states. This bit must be manually cleared after being set.

Bit/Field	Name	Type	Reset	Description
7:6	reserved	RO	0	Software should not rely on the value of a reserved bit. To provide compatibility with future products, the value of a reserved bit should be preserved across a read-modify-write operation.
5	SSI1	R/W	0	SSI1 Reset Control  When this bit is set, SSI module 1 is reset. All internal data is lost and the registers are returned to their reset states. This bit must be manually cleared after being set.
4	SSI0	R/W	0	SSI0 Reset Control  When this bit is set, SSI module 0 is reset. All internal data is lost and the registers are returned to their reset states. This bit must be manually cleared after being set.
3	reserved	RO	0	Software should not rely on the value of a reserved bit. To provide compatibility with future products, the value of a reserved bit should be preserved across a read-modify-write operation.
2	UART2	R/W	0	UART2 Reset Control  When this bit is set, UART module 2 is reset. All internal data is lost and the registers are returned to their reset states. This bit must be manually cleared after being set.
1	UART1	R/W	0	UART1 Reset Control  When this bit is set, UART module 1 is reset. All internal data is lost and the registers are returned to their reset states. This bit must be manually cleared after being set.
0	UART0	R/W	0	UART0 Reset Control  When this bit is set, UART module 0 is reset. All internal data is lost and the registers are returned to their reset states. This bit must be manually cleared after being set.

**Register 38: Software Reset Control 2 (SRCR2), offset 0x048**

This register allows individual modules to be reset. Writes to this register are masked by the bits in the **Device Capabilities 4 (DC4)** register.

**Software Reset Control 2 (SRCR2)**

Base 0x400F.E000

Offset 0x048

Type R/W, reset 0x00000000

	31	30	29	28	27	26	25	24	23	22	21	20	19	18	17	16	
	reserved	EPHY0	reserved	EMAC0	reserved											USB0	
Type	RO	R/W	RO	R/W	RO	RO	RO	RO	RO	RO	RO	RO	RO	RO	RO	R/W	
Reset	0	0	0	0	0	0	0	0	0	0	0	0	0	0	0	0	
	15	14	13	12	11	10	9	8	7	6	5	4	3	2	1	0	
	reserved		UDMA	reserved				GPIOD	GPIOC	GPIOB	GPIOA	GPIOD	GPIOC	GPIOB	GPIOA		
Type	RO	RO	R/W	RO	RO	RO	RO	R/W	R/W	R/W	R/W	R/W	R/W	R/W	R/W	R/W	
Reset	0	0	0	0	0	0	0	0	0	0	0	0	0	0	0	0	

Bit/Field	Name	Type	Reset	Description
31	reserved	RO	0	Software should not rely on the value of a reserved bit. To provide compatibility with future products, the value of a reserved bit should be preserved across a read-modify-write operation.
30	EPHY0	R/W	0	PHY0 Reset Control  When this bit is set, Ethernet PHY layer 0 is reset. All internal data is lost and the registers are returned to their reset states. This bit must be manually cleared after being set.
29	reserved	RO	0	Software should not rely on the value of a reserved bit. To provide compatibility with future products, the value of a reserved bit should be preserved across a read-modify-write operation.
28	EMAC0	R/W	0	MAC0 Reset Control  When this bit is set, Ethernet MAC layer 0 is reset. All internal data is lost and the registers are returned to their reset states. This bit must be manually cleared after being set.
27:17	reserved	RO	0	Software should not rely on the value of a reserved bit. To provide compatibility with future products, the value of a reserved bit should be preserved across a read-modify-write operation.
16	USB0	R/W	0	USB0 Reset Control  When this bit is set, USB module 0 is reset. All internal data is lost and the registers are returned to their reset states. This bit must be manually cleared after being set.
15:14	reserved	RO	0	Software should not rely on the value of a reserved bit. To provide compatibility with future products, the value of a reserved bit should be preserved across a read-modify-write operation.
13	UDMA	R/W	0	Micro-DMA Reset Control  When this bit is set, uDMA module is reset. All internal data is lost and the registers are returned to their reset states. This bit must be manually cleared after being set.

Bit/Field	Name	Type	Reset	Description
12:9	reserved	RO	0	Software should not rely on the value of a reserved bit. To provide compatibility with future products, the value of a reserved bit should be preserved across a read-modify-write operation.
8	GPIOJ	R/W	0	Port J Reset Control  When this bit is set, Port J module is reset. All internal data is lost and the registers are returned to their reset states. This bit must be manually cleared after being set.
7	GPIOH	R/W	0	Port H Reset Control  When this bit is set, Port H module is reset. All internal data is lost and the registers are returned to their reset states. This bit must be manually cleared after being set.
6	GPIOG	R/W	0	Port G Reset Control  When this bit is set, Port G module is reset. All internal data is lost and the registers are returned to their reset states. This bit must be manually cleared after being set.
5	GPIOF	R/W	0	Port F Reset Control  When this bit is set, Port F module is reset. All internal data is lost and the registers are returned to their reset states. This bit must be manually cleared after being set.
4	GPIOE	R/W	0	Port E Reset Control  When this bit is set, Port E module is reset. All internal data is lost and the registers are returned to their reset states. This bit must be manually cleared after being set.
3	GPIOD	R/W	0	Port D Reset Control  When this bit is set, Port D module is reset. All internal data is lost and the registers are returned to their reset states. This bit must be manually cleared after being set.
2	GPIOC	R/W	0	Port C Reset Control  When this bit is set, Port C module is reset. All internal data is lost and the registers are returned to their reset states. This bit must be manually cleared after being set.
1	GPIOB	R/W	0	Port B Reset Control  When this bit is set, Port B module is reset. All internal data is lost and the registers are returned to their reset states. This bit must be manually cleared after being set.
0	GPIOA	R/W	0	Port A Reset Control  When this bit is set, Port A module is reset. All internal data is lost and the registers are returned to their reset states. This bit must be manually cleared after being set.



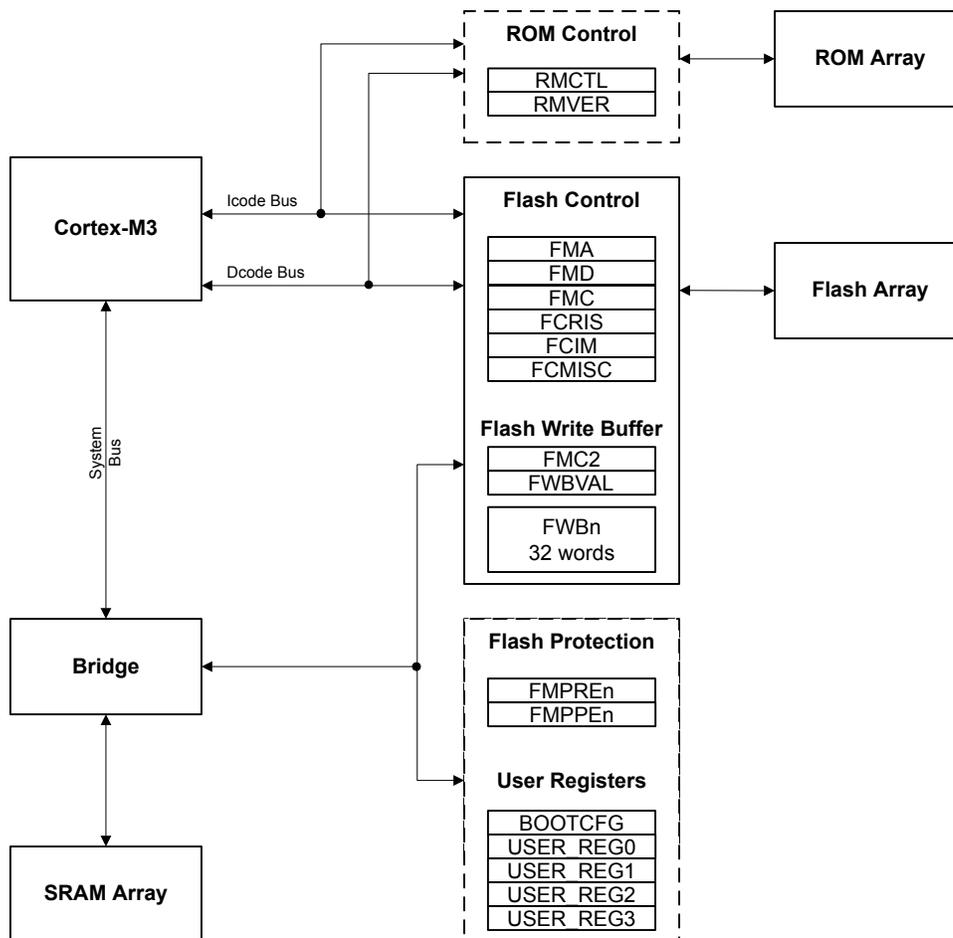
## 7 Internal Memory

The LM3S9B96 microcontroller comes with 96 KB of bit-banded SRAM, internal ROM, and 256 KB of Flash memory. The Flash memory controller provides a user-friendly interface, making Flash memory programming a simple task. Flash memory protection can be applied to the Flash memory on a 2-KB block basis.

### 7.1 Block Diagram

Figure 7-1 on page 209 illustrates the internal memory blocks and control logic. The dashed boxes in the figure indicate registers residing in the System Control module.

**Figure 7-1. Internal Memory Block Diagram**



### 7.2 Functional Description

This section describes the functionality of the SRAM, ROM, and Flash memories.

**Note:** The  $\mu$ DMA controller can transfer data to and from the on-chip SRAM. However, because the Flash memory and ROM are located on a separate internal bus, it is not possible to transfer data from the Flash memory or ROM with the  $\mu$ DMA controller.

## 7.2.1 SRAM

**Note:** The SRAM is implemented using two 32-bit wide SRAM banks (separate SRAM arrays). The banks are partitioned such that one bank contains all even words (the even bank) and the other contains all odd words (the odd bank). A write access that is followed immediately by a read access to the same bank incurs a stall of a single clock cycle. However, a write to one bank followed by a read of the other bank can occur in successive clock cycles without incurring any delay.

The internal SRAM of the Stellaris<sup>®</sup> devices is located at address 0x2000.0000 of the device memory map. To reduce the number of time consuming read-modify-write (RMW) operations, ARM has introduced *bit-banding* technology in the Cortex-M3 processor. With a bit-band-enabled processor, certain regions in the memory map (SRAM and peripheral space) can use address aliases to access individual bits in a single, atomic operation. The bit-band base is located at address 0x2200.0000.

The bit-band alias is calculated by using the formula:

$$\text{bit-band alias} = \text{bit-band base} + (\text{byte offset} * 32) + (\text{bit number} * 4)$$

For example, if bit 3 at address 0x2000.1000 is to be modified, the bit-band alias is calculated as:

$$0x2200.0000 + (0x1000 * 32) + (3 * 4) = 0x2202.000C$$

With the alias address calculated, an instruction performing a read/write to address 0x2202.000C allows direct access to only bit 3 of the byte at address 0x2000.1000.

For details about bit-banding, please refer to Chapter 4, “Memory Map” in the *ARM<sup>®</sup> Cortex<sup>™</sup>-M3 Technical Reference Manual*.

## 7.2.2 ROM

The internal ROM of the Stellaris<sup>®</sup> device is located at address 0x0100.0000 of the device memory map. The ROM contains the following components:

- Stellaris<sup>®</sup> Boot Loader and vector table
- Stellaris<sup>®</sup> Peripheral Driver Library (DriverLib) release for product-specific peripherals and interfaces
- SafeRTOS code
- Advanced Encryption Standard (AES) cryptography tables
- Cyclic Redundancy Check (CRC) error detection functionality

The boot loader is used as an initial program loader (when the Flash memory is empty) as well as an application-initiated firmware upgrade mechanism (by calling back to the boot loader). The Peripheral Driver Library APIs in ROM can be called by applications, reducing Flash memory requirements and freeing the Flash memory to be used for other purposes (such as additional features in the application). SafeRTOS is a low-overhead, mini, pre-emptive real-time scheduler. Advance Encryption Standard (AES) is a publicly defined encryption standard used by the U.S. Government and Cyclic Redundancy Check (CRC) is a technique to validate a span of data has the same contents as when previously checked.

### 7.2.2.1 Boot Loader Overview

The Stellaris<sup>®</sup> Boot Loader is executed from the ROM when the Flash memory is empty and is used to download code to the Flash memory of a device without the use of a debug interface. At any

reset that resets the core, the user has the opportunity to direct the core to execute the ROM Boot Loader or the application in Flash memory by using any GPIO signal in Ports A-H as configured in the **Boot Configuration (BOOTCFG)** register. If the ROM boot loader is not selected, code in the ROM checks address 0x000.0004 to see if the Flash memory has a valid reset vector. If the data at address 0x0000.0004 is 0xFFFF.FFFF, then it is assumed that the Flash memory has not yet been programmed, and the core executes the ROM Boot Loader.

The boot loader uses a simple packet interface to provide synchronous communication with the device. The speed of the boot loader is determined by the internal oscillator (PIOSC) frequency as it does not enable the PLL. The following serial interfaces can be used:

- UART0
- SSIO
- I<sup>2</sup>C0
- Ethernet

For simplicity, both the data format and communication protocol are identical for all serial interfaces.

**Note:** The Flash-memory-resident version of the Boot Loader also supports CAN and USB.

See the *Stellaris® Boot Loader User's Guide* for information on the boot loader software.

### 7.2.2.2 Stellaris® Peripheral Driver Library

The Stellaris® Peripheral Driver Library contains a file called `driverlib/rom.h` that assists with calling the peripheral driver library functions in the ROM. The detailed description of each function is available in the *Stellaris® ROM User's Guide*. See the "Using the ROM" chapter of the *Stellaris® Peripheral Driver Library User's Guide* for more details on calling the ROM functions and using `driverlib/rom.h`.

A table at the beginning of the ROM points to the entry points for the APIs that are provided in the ROM. Accessing the API through these tables provides scalability; while the API locations may change in future versions of the ROM, the API tables will not. The tables are split into two levels; the main table contains one pointer per peripheral which points to a secondary table that contains one pointer per API that is associated with that peripheral. The main table is located at 0x0100.0010, right after the Cortex-M3 vector table in the ROM.

DriverLib functions are described in detail in the *Stellaris® Peripheral Driver Library User's Guide*.

Additional APIs are available for graphics and USB functions, but are not preloaded into ROM. The Stellaris® Graphics Library provides a set of graphics primitives and a widget set for creating graphical user interfaces on Stellaris® microcontroller-based boards that have a graphical display (for more information, see the *Stellaris® Graphics Library User's Guide*). The Stellaris® USB Library is a set of data types and functions for creating USB Device, Host or On-The-Go (OTG) applications on Stellaris microcontroller-based boards (for more information, see the *Stellaris® USB Library User's Guide*).

### 7.2.2.3 SafeRTOS

SafeRTOS is a SIL3 RTOS version that has been certified for use in safety-critical applications. It is functionally similar to FreeRTOS, but has extended safety functionality. Complete IEC 61508-compliant development and safety lifecycle documentation is available (conformance certified by TÜV SÜD, including compiler verification evidence).

SafeRTOS is produced by WITTENSTEIN high-integrity systems for IEC 61508-compliant systems.

SafeRTOS is available in the integrated ROM of the LM3S9B96 microcontroller and is used with the SafeRTOS header files and initialization code and examples. For full SIL certification, the compliance specifications may be purchased from WITTENSTEIN.

For more information, refer to the *SafeRTOS User's Manual*.

#### 7.2.2.4 Advanced Encryption Standard (AES) Cryptography Tables

AES is a strong encryption method with reasonable performance and size. AES is fast in both hardware and software, is fairly easy to implement, and requires little memory. AES is ideal for applications that can use pre-arranged keys, such as setup during manufacturing or configuration. Four data tables used by the XySSL AES implementation are provided in the ROM. The first is the forward S-box substitution table, the second is the reverse S-box substitution table, the third is the forward polynomial table, and the final is the reverse polynomial table. See the *Stellaris® ROM User's Guide* for more information on AES.

#### 7.2.2.5 Cyclic Redundancy Check (CRC) Error Detection

The CRC technique can be used to validate correct receipt of messages (nothing lost or modified in transit), to validate data after decompression, to validate that Flash memory contents have not been changed, and for other cases where the data needs to be validated. A CRC is preferred over a simple checksum (e.g. XOR all bits) because it catches changes more readily. See the *Stellaris® ROM User's Guide* for more information on CRC.

### 7.2.3 Flash Memory

At system clock speeds of 50 MHz and below, the Flash memory is read in a single cycle. The Flash memory is organized as a set of 1-KB blocks that can be individually erased. An individual 32-bit word can be programmed to change bits from 1 to 0. In addition, a write buffer provides the ability to concurrently program 32 continuous words in Flash memory. Erasing a block causes the entire contents of the block to be reset to all 1s. The 1-KB blocks are paired into sets of 2-KB blocks that can be individually protected. The protection allows blocks to be marked as read-only or execute-only, providing different levels of code protection. Read-only blocks cannot be erased or programmed, protecting the contents of those blocks from being modified. Execute-only blocks cannot be erased or programmed and can only be read by the controller instruction fetch mechanism, protecting the contents of those blocks from being read by either the controller or by a debugger.

---

**Caution – In systems where the microcontroller is frequently powered for less than five minutes, power should be removed from the microcontroller in a controlled manner to ensure proper operation. Software should request permission to power down the part using the USDREQ bit in the Flash Control (FCTL) register and wait to receive an acknowledge from the USDACK bit prior to removing power.**

---

#### 7.2.3.1 Prefetch Buffer

The Flash memory controller has a prefetch buffer that is automatically used when the CPU frequency is greater than 50 MHz. In this mode, the Flash memory operates at half of the system clock. The prefetch buffer fetches two 32-bit words per clock allowing instructions to be fetched with no wait states while code is executing linearly. The fetch buffer includes a branch speculation mechanism that recognizes a branch and avoids extra wait states by not reading the next word pair. Also, short loop branches often stay in the buffer. As a result, some branches can be executed with no wait states. Other branches incur a single wait state.

### 7.2.3.2 Flash Memory Protection

The user is provided two forms of Flash memory protection per 2-KB Flash memory block in four pairs of 32-bit wide registers. The policy for each protection form is controlled by individual bits (per policy per block) in the **FMPPEn** and **FMPREn** registers.

- **Flash Memory Protection Program Enable (FMPPEn)**: If a bit is set, the corresponding block may be programmed (written) or erased. If a bit is cleared, the corresponding block may not be changed.
- **Flash Memory Protection Read Enable (FMPREn)**: If a bit is set, the corresponding block may be executed or read by software or debuggers. If a bit is cleared, the corresponding block may only be executed, and contents of the memory block are prohibited from being read as data.

The policies may be combined as shown in Table 7-1 on page 213.

**Table 7-1. Flash Memory Protection Policy Combinations**

FMPPEn	FMPREn	Protection
0	0	Execute-only protection. The block may only be executed and may not be written or erased. This mode is used to protect code.
1	0	The block may be written, erased or executed, but not read. This combination is unlikely to be used.
0	1	Read-only protection. The block may be read or executed but may not be written or erased. This mode is used to lock the block from further modification while allowing any read or execute access.
1	1	No protection. The block may be written, erased, executed or read.

A Flash memory access that attempts to read a read-protected block (**FMPREn** bit is set) is prohibited and generates a bus fault. A Flash memory access that attempts to program or erase a program-protected block (**FMPPEn** bit is set) is prohibited and can optionally generate an interrupt (by setting the **AMASK** bit in the **Flash Controller Interrupt Mask (FCIM)** register) to alert software developers of poorly behaving software during the development and debug phases.

The factory settings for the **FMPREn** and **FMPPEn** registers are a value of 1 for all implemented banks. These settings create a policy of open access and programmability. The register bits may be changed by clearing the specific register bit. The changes are not permanent until the register is committed (saved), at which point the bit change is permanent. If a bit is changed from a 1 to a 0 and not committed, it may be restored by executing a power-on reset sequence. The changes are committed using the **Flash Memory Control (FMC)** register. Details on programming these bits are discussed in “Nonvolatile Register Programming” on page 215.

### 7.2.3.3 Interrupts

The Flash memory controller can generate interrupts when the following conditions are observed:

- Programming Interrupt - signals when a program or erase action is complete.
- Access Interrupt - signals when a program or erase action has been attempted on a 2-kB block of memory that is protected by its corresponding **FMPPEn** bit.

The interrupt events that can trigger a controller-level interrupt are defined in the **Flash Controller Masked Interrupt Status (FCMIS)** register (see page 223) by setting the corresponding **MASK** bits. If interrupts are not used, the raw interrupt status is always visible via the **Flash Controller Raw Interrupt Status (FCRIS)** register (see page 222).

Interrupts are always cleared (for both the **FCMIS** and **FCRIS** registers) by writing a 1 to the corresponding bit in the **Flash Controller Masked Interrupt Status and Clear (FCMISC)** register (see page 224).

## 7.3 Flash Memory Initialization and Configuration

### 7.3.1 Flash Memory Programming

The Stellaris<sup>®</sup> devices provide a user-friendly interface for Flash memory programming. All erase/program operations are handled via three registers: **Flash Memory Address (FMA)**, **Flash Memory Data (FMD)**, and **Flash Memory Control (FMC)**. Note that if the debug capabilities of the microcontroller have been deactivated, resulting in a "locked" state, a recovery sequence must be performed in order to reactivate the debug module. See "Recovering a "Locked" Microcontroller" on page 95.

---

**Caution** – The Flash memory is divided into sectors of electrically separated address ranges of 4 KB each, aligned on 4 KB boundaries. Erase/program operations on a 1-KB page have an electrical effect on the other three 1-KB pages within the sector. A specific 1-KB page must be erased after 6 total erase/program cycles occur to the other pages within its 4-KB sector. The following sequence of operations on a 4-KB sector of Flash memory (Page 0..3) provides an example:

- Page 3 is erase and programmed with values.
  - Page 0, Page 1, and Page 2 are erased and then programmed with values. At this point Page 3 has been affected by 3 erase/program cycles.
  - Page 0, Page 1, and Page 2 are again erased and then programmed with values. At this point Page 3 has been affected by 6 erase/program cycles.
  - If the contents of Page 3 must continue to be valid, Page 3 must be erased and reprogrammed before any other page in this sector has another erase or program operation.
- 

#### 7.3.1.1 To program a 32-bit word

1. Write source data to the **FMD** register.
  2. Write the target address to the **FMA** register.
  3. Write the Flash memory write key and the **WRITE** bit (a value of 0xA442.0001) to the **FMC** register.
  4. Poll the **FMC** register until the **WRITE** bit is cleared.
- 

**Important:** To ensure proper operation, two writes to the same word must be separated by an **ERASE**. The following two sequences are allowed:

- ERASE -> PROGRAM value -> PROGRAM 0x0000.0000
- ERASE -> PROGRAM value -> ERASE

The following sequence is NOT allowed:

- ERASE -> PROGRAM value -> PROGRAM value
-

### 7.3.1.2 To perform an erase of a 1-KB page

1. Write the page address to the **FMA** register.
2. Write the Flash memory write key and the **ERASE** bit (a value of 0xA442.0002) to the **FMC** register.
3. Poll the **FMC** register until the **ERASE** bit is cleared.

### 7.3.1.3 To perform a mass erase of the Flash memory

1. Write the Flash memory write key and the **MERASE** bit (a value of 0xA442.0004) to the **FMC** register.
2. Poll the **FMC** register until the **MERASE** bit is cleared.

## 7.3.2 32-Word Flash Memory Write Buffer

A 32-word write buffer provides the capability to perform faster write accesses to the Flash memory by concurrently programming 32 words with a single buffered Flash memory write operation. The buffered Flash memory write operation takes the same amount of time as the single word write operation controlled by bit 0 in the **FMC** register. The data for the buffered write is written to the **Flash Write Buffer (FWBn)** registers.

The registers are 32-word aligned with Flash memory, and therefore the register **FWB0** corresponds with the address in **FMA** where bits [6:0] of **FMA** are all 0. **FWB1** corresponds with the address in **FMA + 0x4** and so on. Only the **FWBn** registers that have been updated since the previous buffered Flash memory write operation are written. The **Flash Write Buffer Valid (FWBVAL)** register shows which registers have been written since the last buffered Flash memory write operation. This register contains a bit for each of the 32 **FWBn** registers, where bit[n] of **FWBVAL** corresponds to **FWBn**. The **FWBn** register has been updated if the corresponding bit in the **FWBVAL** register is set.

### 7.3.2.1 To program 32 words with a single buffered Flash memory write operation

1. Write the source data to the **FWBn** registers.
2. Write the target address to the **FMA** register. This must be a 32-word aligned address (that is, bits [6:0] in **FMA** must be 0s).
3. Write the Flash memory write key and the **WRBUF** bit (a value of 0xA442.0001) to the **FMC2** register.
4. Poll the **FMC2** register until the **WRBUF** bit is cleared.

## 7.3.3 Nonvolatile Register Programming

This section discusses how to update registers that are resident within the Flash memory itself. These registers exist in a separate space from the main Flash memory array and are not affected by an **ERASE** or **MASS ERASE** operation. The bits in these registers can be changed from 1 to 0 with a write operation. The register contents are unaffected by any reset condition except power-on reset, which returns the register contents to 0xFFFF.FFFF. By committing the register values using the **COMT** bit in the **FMC** register, the register contents become nonvolatile and are therefore retained following power cycling. Once the register contents are committed, the only way to restore the factory default values is to perform the sequence described in "Recovering a "Locked" Microcontroller" on page 95.

With the exception of the **Boot Configuration (BOOTCFG)** register, the settings in these registers can be tested before committing them to Flash memory. For the **BOOTCFG** register, the data to be written is loaded into the **FMD** register before it is committed. The **FMD** register is read only and does not allow the **BOOTCFG** operation to be tried before committing it to nonvolatile memory.

**Important:** The Flash memory resident registers can only have bits changed from 1 to 0 by user programming and can only be committed once. After being committed, these registers can only be restored to their factory default values only by performing the sequence described in "Recovering a "Locked" Microcontroller" on page 95. The mass erase of the main Flash memory array caused by the sequence is performed prior to restoring these registers.

In addition, the **USER\_REG0**, **USER\_REG1**, **USER\_REG2**, **USER\_REG3**, and **BOOTCFG** registers each use bit 31 (NW) to indicate that they have not been committed and bits in the register may be changed from 1 to 0. Table 7-2 on page 216 provides the **FMA** address required for commitment of each of the registers and the source of the data to be written when the **FMC** register is written with a value of 0xA442.0008. After writing the **COMT** bit, the user may poll the **FMC** register to wait for the commit operation to complete.

**Table 7-2. User-Programmable Flash Memory Resident Registers**

Register to be Committed	FMA Value	Data Source
FMPRE0	0x0000.0000	FMPRE0
FMPRE1	0x0000.0002	FMPRE1
FMPRE2	0x0000.0004	FMPRE2
FMPRE3	0x0000.0006	FMPRE3
FMPPE0	0x0000.0001	FMPPE0
FMPPE1	0x0000.0003	FMPPE1
FMPPE2	0x0000.0005	FMPPE2
FMPPE3	0x0000.0007	FMPPE3
USER_REG0	0x8000.0000	USER_REG0
USER_REG1	0x8000.0001	USER_REG1
USER_REG2	0x8000.0002	USER_REG2
USER_REG3	0x8000.0003	USER_REG3
BOOTCFG	0x7510.0000	FMD

## 7.4 Register Map

Table 7-3 on page 216 lists the ROM Controller register and the Flash memory and control registers. The offset listed is a hexadecimal increment to the register's address. The **FMA**, **FMD**, **FMC**, **FCRIS**, **FCIM**, **FCMISC**, **FMC2**, **FWBVAL**, and **FWBn** register offsets are relative to the Flash memory control base address of 0x400F.D000. The ROM and Flash memory protection register offsets are relative to the System Control base address of 0x400F.E000.

**Table 7-3. Flash Register Map**

Offset	Name	Type	Reset	Description	See page
<b>Flash Memory Registers (Flash Control Offset)</b>					
0x000	FMA	R/W	0x0000.0000	Flash Memory Address	218



Table 7-3. Flash Register Map (continued)

Offset	Name	Type	Reset	Description	See page
0x004	FMD	R/W	0x0000.0000	Flash Memory Data	219
0x008	FMC	R/W	0x0000.0000	Flash Memory Control	220
0x00C	FCRIS	RO	0x0000.0000	Flash Controller Raw Interrupt Status	222
0x010	FCIM	R/W	0x0000.0000	Flash Controller Interrupt Mask	223
0x014	FCMISC	R/W1C	0x0000.0000	Flash Controller Masked Interrupt Status and Clear	224
0x020	FMC2	R/W	0x0000.0000	Flash Memory Control 2	225
0x030	FWBVAL	R/W	0x0000.0000	Flash Write Buffer Valid	226
0x0F8	FCTL	R/W	0x0000.0000	Flash Control	228
0x100 - 0x17C	FWBn	R/W	0x0000.0000	Flash Write Buffer n	227
<b>Memory Registers (System Control Offset)</b>					
0x0F0	RMCTL	R/W1C	-	ROM Control	229
0x0F4	RMVER	RO	0x0303.5400	ROM Version Register	230
0x130	FMPRE0	R/W	0xFFFF.FFFF	Flash Memory Protection Read Enable 0	231
0x200	FMPRE0	R/W	0xFFFF.FFFF	Flash Memory Protection Read Enable 0	231
0x134	FMPPE0	R/W	0xFFFF.FFFF	Flash Memory Protection Program Enable 0	232
0x400	FMPPE0	R/W	0xFFFF.FFFF	Flash Memory Protection Program Enable 0	232
0x1D0	BOOTCFG	R/W	0xFFFF.FFFE	Boot Configuration	233
0x1E0	USER_REG0	R/W	0xFFFF.FFFF	User Register 0	236
0x1E4	USER_REG1	R/W	0xFFFF.FFFF	User Register 1	237
0x1E8	USER_REG2	R/W	0xFFFF.FFFF	User Register 2	238
0x1EC	USER_REG3	R/W	0xFFFF.FFFF	User Register 3	239
0x204	FMPRE1	R/W	0xFFFF.FFFF	Flash Memory Protection Read Enable 1	240
0x208	FMPRE2	R/W	0xFFFF.FFFF	Flash Memory Protection Read Enable 2	241
0x20C	FMPRE3	R/W	0xFFFF.FFFF	Flash Memory Protection Read Enable 3	242
0x404	FMPPE1	R/W	0xFFFF.FFFF	Flash Memory Protection Program Enable 1	243
0x408	FMPPE2	R/W	0xFFFF.FFFF	Flash Memory Protection Program Enable 2	244
0x40C	FMPPE3	R/W	0xFFFF.FFFF	Flash Memory Protection Program Enable 3	245

## 7.5 Flash Memory Register Descriptions (Flash Control Offset)

This section lists and describes the Flash Memory registers, in numerical order by address offset. Registers in this section are relative to the Flash control base address of 0x400F.D000.

## Register 1: Flash Memory Address (FMA), offset 0x000

During a write operation, this register contains a 4-byte-aligned address and specifies where the data is written. During erase operations, this register contains a 1 KB-aligned address and specifies which page is erased. Note that the alignment requirements must be met by software or the results of the operation are unpredictable.

### Flash Memory Address (FMA)

Base 0x400F.D000

Offset 0x000

Type R/W, reset 0x0000.0000

	31	30	29	28	27	26	25	24	23	22	21	20	19	18	17	16
	reserved														OFFSET	
Type	RO	RO	RO	RO	RO	RO	RO	RO	RO	RO	RO	RO	RO	RO	R/W	R/W
Reset	0	0	0	0	0	0	0	0	0	0	0	0	0	0	0	0
	15	14	13	12	11	10	9	8	7	6	5	4	3	2	1	0
	OFFSET															
Type	R/W	R/W	R/W	R/W	R/W	R/W	R/W	R/W	R/W	R/W	R/W	R/W	R/W	R/W	R/W	R/W
Reset	0	0	0	0	0	0	0	0	0	0	0	0	0	0	0	0

Bit/Field	Name	Type	Reset	Description
31:18	reserved	RO	0x0	Software should not rely on the value of a reserved bit. To provide compatibility with future products, the value of a reserved bit should be preserved across a read-modify-write operation.
17:0	OFFSET	R/W	0x0	Address Offset  Address offset in Flash memory where operation is performed, except for nonvolatile registers (see "Nonvolatile Register Programming" on page 215 for details on values for this field).

## Register 2: Flash Memory Data (FMD), offset 0x004

This register contains the data to be written during the programming cycle or read during the read cycle. Note that the contents of this register are undefined for a read access of an execute-only block. This register is not used during erase cycles.

### Flash Memory Data (FMD)

Base 0x400F.D000

Offset 0x004

Type R/W, reset 0x0000.0000

	31	30	29	28	27	26	25	24	23	22	21	20	19	18	17	16
	DATA															
Type	R/W	R/W	R/W	R/W	R/W	R/W	R/W	R/W	R/W	R/W	R/W	R/W	R/W	R/W	R/W	R/W
Reset	0	0	0	0	0	0	0	0	0	0	0	0	0	0	0	0
	15	14	13	12	11	10	9	8	7	6	5	4	3	2	1	0
	DATA															
Type	R/W	R/W	R/W	R/W	R/W	R/W	R/W	R/W	R/W	R/W	R/W	R/W	R/W	R/W	R/W	R/W
Reset	0	0	0	0	0	0	0	0	0	0	0	0	0	0	0	0

Bit/Field	Name	Type	Reset	Description
31:0	DATA	R/W	0x0000.0000	Data Value Data value for write operation.

### Register 3: Flash Memory Control (FMC), offset 0x008

When this register is written, the Flash memory controller initiates the appropriate access cycle for the location specified by the **Flash Memory Address (FMA)** register (see page 218). If the access is a write access, the data contained in the **Flash Memory Data (FMD)** register (see page 219) is written to the specified address.

This register must be the final register written and initiates the memory operation. The four control bits in the lower byte of this register are used to initiate memory operations.

Care must be taken not to set multiple control bits as the results of such an operation are unpredictable.

#### Flash Memory Control (FMC)

Base 0x400F.D000  
Offset 0x008  
Type R/W, reset 0x0000.0000

	31	30	29	28	27	26	25	24	23	22	21	20	19	18	17	16
	WRKEY															
Type	WO	WO	WO	WO	WO	WO	WO	WO	WO	WO	WO	WO	WO	WO	WO	WO
Reset	0	0	0	0	0	0	0	0	0	0	0	0	0	0	0	0
	15	14	13	12	11	10	9	8	7	6	5	4	3	2	1	0
	reserved												COMT	MERASE	ERASE	WRITE
Type	RO	RO	RO	RO	RO	RO	RO	RO	RO	RO	RO	RO	R/W	R/W	R/W	R/W
Reset	0	0	0	0	0	0	0	0	0	0	0	0	0	0	0	0

Bit/Field	Name	Type	Reset	Description				
31:16	WRKEY	WO	0x0000	Flash Memory Write Key  This field contains a write key, which is used to minimize the incidence of accidental Flash memory writes. The value 0xA442 must be written into this field for a Flash memory write to occur. Writes to the <b>FMC</b> register without this <code>WRKEY</code> value are ignored. A read of this field returns the value 0.				
15:4	reserved	RO	0x000	Software should not rely on the value of a reserved bit. To provide compatibility with future products, the value of a reserved bit should be preserved across a read-modify-write operation.				
3	COMT	R/W	0	Commit Register Value  This bit is used to commit writes to Flash-memory-resident registers and to monitor the progress of that process.  Value Description <table border="0"> <tr> <td>1</td> <td>Set this bit to commit (write) the register value to a Flash-memory-resident register.  When read, a 1 indicates that the previous commit access is not complete.</td> </tr> <tr> <td>0</td> <td>A write of 0 has no effect on the state of this bit.  When read, a 0 indicates that the previous commit access is complete.</td> </tr> </table> A commit can take up to 50 $\mu$ s.  See "Nonvolatile Register Programming" on page 215 for more information on programming Flash-memory-resident registers.	1	Set this bit to commit (write) the register value to a Flash-memory-resident register.  When read, a 1 indicates that the previous commit access is not complete.	0	A write of 0 has no effect on the state of this bit.  When read, a 0 indicates that the previous commit access is complete.
1	Set this bit to commit (write) the register value to a Flash-memory-resident register.  When read, a 1 indicates that the previous commit access is not complete.							
0	A write of 0 has no effect on the state of this bit.  When read, a 0 indicates that the previous commit access is complete.							

Bit/Field	Name	Type	Reset	Description
2	MERASE	R/W	0	<p>Mass Erase Flash Memory</p> <p>This bit is used to mass erase the Flash main memory and to monitor the progress of that process.</p> <p>Value Description</p> <p>1 Set this bit to erase the Flash main memory.</p> <p>When read, a 1 indicates that the previous mass erase access is not complete.</p> <p>0 A write of 0 has no effect on the state of this bit.</p> <p>When read, a 0 indicates that the previous mass erase access is complete.</p> <p>A mass erase can take up to 16 ms.</p>
1	ERASE	R/W	0	<p>Erase a Page of Flash Memory</p> <p>This bit is used to erase a page of Flash memory and to monitor the progress of that process.</p> <p>Value Description</p> <p>1 Set this bit to erase the Flash memory page specified by the contents of the <b>FMA</b> register.</p> <p>When read, a 1 indicates that the previous page erase access is not complete.</p> <p>0 A write of 0 has no effect on the state of this bit.</p> <p>When read, a 0 indicates that the previous page erase access is complete.</p> <p>A page erase can take up to 25 ms.</p>
0	WRITE	R/W	0	<p>Write a Word into Flash Memory</p> <p>This bit is used to write a word into Flash memory and to monitor the progress of that process.</p> <p>Value Description</p> <p>1 Set this bit to write the data stored in the <b>FMD</b> register into the Flash memory location specified by the contents of the <b>FMA</b> register.</p> <p>When read, a 1 indicates that the write update access is not complete.</p> <p>0 A write of 0 has no effect on the state of this bit.</p> <p>When read, a 0 indicates that the previous write update access is complete.</p> <p>Writing a single word can take up to 50 <math>\mu</math>s.</p>

## Register 4: Flash Controller Raw Interrupt Status (FCRIS), offset 0x00C

This register indicates that the Flash memory controller has an interrupt condition. An interrupt is sent to the interrupt controller only if the corresponding **FCIM** register bit is set.

### Flash Controller Raw Interrupt Status (FCRIS)

Base 0x400F.D000

Offset 0x00C

Type RO, reset 0x0000.0000

	31	30	29	28	27	26	25	24	23	22	21	20	19	18	17	16	
	reserved																
Type	RO	RO	RO	RO	RO	RO	RO	RO	RO	RO	RO	RO	RO	RO	RO	RO	
Reset	0	0	0	0	0	0	0	0	0	0	0	0	0	0	0	0	
	15	14	13	12	11	10	9	8	7	6	5	4	3	2	1	0	
	reserved															PRIS	ARIS
Type	RO	RO	RO	RO	RO	RO	RO	RO	RO	RO	RO	RO	RO	RO	RO	RO	RO
Reset	0	0	0	0	0	0	0	0	0	0	0	0	0	0	0	0	0

Bit/Field	Name	Type	Reset	Description				
31:2	reserved	RO	0x0000.000	Software should not rely on the value of a reserved bit. To provide compatibility with future products, the value of a reserved bit should be preserved across a read-modify-write operation.				
1	PRIS	RO	0	<p>Programming Raw Interrupt Status</p> <p>This bit provides status on programming cycles which are write or erase actions generated through the <b>FMC</b> or <b>FMC2</b> register bits (see page 220 and page 225).</p> <p>Value Description</p> <table border="0"> <tr> <td>1</td> <td>The programming cycle has completed.</td> </tr> <tr> <td>0</td> <td>The programming cycle has not completed.</td> </tr> </table> <p>This status is sent to the interrupt controller when the <b>PMASK</b> bit in the <b>FCIM</b> register is set.</p> <p>This bit is cleared by writing a 1 to the <b>PMISC</b> bit in the <b>FCMISC</b> register.</p>	1	The programming cycle has completed.	0	The programming cycle has not completed.
1	The programming cycle has completed.							
0	The programming cycle has not completed.							
0	ARIS	RO	0	<p>Access Raw Interrupt Status</p> <p>Value Description</p> <table border="0"> <tr> <td>1</td> <td>A program or erase action was attempted on a block of Flash memory that contradicts the protection policy for that block as set in the <b>FMPPEn</b> registers.</td> </tr> <tr> <td>0</td> <td>No access has tried to improperly program or erase the Flash memory.</td> </tr> </table> <p>This status is sent to the interrupt controller when the <b>AMASK</b> bit in the <b>FCIM</b> register is set.</p> <p>This bit is cleared by writing a 1 to the <b>AMISC</b> bit in the <b>FCMISC</b> register.</p>	1	A program or erase action was attempted on a block of Flash memory that contradicts the protection policy for that block as set in the <b>FMPPEn</b> registers.	0	No access has tried to improperly program or erase the Flash memory.
1	A program or erase action was attempted on a block of Flash memory that contradicts the protection policy for that block as set in the <b>FMPPEn</b> registers.							
0	No access has tried to improperly program or erase the Flash memory.							

## Register 5: Flash Controller Interrupt Mask (FCIM), offset 0x010

This register controls whether the Flash memory controller generates interrupts to the controller.

### Flash Controller Interrupt Mask (FCIM)

Base 0x400F.D000

Offset 0x010

Type R/W, reset 0x0000.0000

	31	30	29	28	27	26	25	24	23	22	21	20	19	18	17	16	
	reserved																
Type	RO	RO	RO	RO	RO	RO	RO	RO	RO	RO	RO	RO	RO	RO	RO	RO	
Reset	0	0	0	0	0	0	0	0	0	0	0	0	0	0	0	0	
	15	14	13	12	11	10	9	8	7	6	5	4	3	2	1	0	
	reserved														PMASK	AMASK	
Type	RO	RO	RO	RO	RO	RO	RO	RO	RO	RO	RO	RO	RO	RO	RO	R/W	R/W
Reset	0	0	0	0	0	0	0	0	0	0	0	0	0	0	0	0	0

Bit/Field	Name	Type	Reset	Description				
31:2	reserved	RO	0x0000.000	Software should not rely on the value of a reserved bit. To provide compatibility with future products, the value of a reserved bit should be preserved across a read-modify-write operation.				
1	PMASK	R/W	0	<p>Programming Interrupt Mask</p> <p>This bit controls the reporting of the programming raw interrupt status to the interrupt controller.</p> <p>Value Description</p> <table border="0"> <tr> <td>1</td> <td>An interrupt is sent to the interrupt controller when the <code>PRIS</code> bit is set.</td> </tr> <tr> <td>0</td> <td>The <code>PRIS</code> interrupt is suppressed and not sent to the interrupt controller.</td> </tr> </table>	1	An interrupt is sent to the interrupt controller when the <code>PRIS</code> bit is set.	0	The <code>PRIS</code> interrupt is suppressed and not sent to the interrupt controller.
1	An interrupt is sent to the interrupt controller when the <code>PRIS</code> bit is set.							
0	The <code>PRIS</code> interrupt is suppressed and not sent to the interrupt controller.							
0	AMASK	R/W	0	<p>Access Interrupt Mask</p> <p>This bit controls the reporting of the access raw interrupt status to the interrupt controller.</p> <p>Value Description</p> <table border="0"> <tr> <td>1</td> <td>An interrupt is sent to the interrupt controller when the <code>ARIS</code> bit is set.</td> </tr> <tr> <td>0</td> <td>The <code>ARIS</code> interrupt is suppressed and not sent to the interrupt controller.</td> </tr> </table>	1	An interrupt is sent to the interrupt controller when the <code>ARIS</code> bit is set.	0	The <code>ARIS</code> interrupt is suppressed and not sent to the interrupt controller.
1	An interrupt is sent to the interrupt controller when the <code>ARIS</code> bit is set.							
0	The <code>ARIS</code> interrupt is suppressed and not sent to the interrupt controller.							

## Register 6: Flash Controller Masked Interrupt Status and Clear (FCMISC), offset 0x014

This register provides two functions. First, it reports the cause of an interrupt by indicating which interrupt source or sources are signalling the interrupt. Second, it serves as the method to clear the interrupt reporting.

### Flash Controller Masked Interrupt Status and Clear (FCMISC)

Base 0x400F.D000

Offset 0x014

Type R/W1C, reset 0x0000.0000

	31	30	29	28	27	26	25	24	23	22	21	20	19	18	17	16	
	reserved																
Type	RO	RO	RO	RO	RO	RO	RO	RO	RO	RO	RO	RO	RO	RO	RO	RO	
Reset	0	0	0	0	0	0	0	0	0	0	0	0	0	0	0	0	
	15	14	13	12	11	10	9	8	7	6	5	4	3	2	1	0	
	reserved															PMISC	AMISC
Type	RO	RO	RO	RO	RO	RO	RO	RO	RO	RO	RO	RO	RO	RO	RO	R/W1C	R/W1C
Reset	0	0	0	0	0	0	0	0	0	0	0	0	0	0	0	0	0

Bit/Field	Name	Type	Reset	Description
31:2	reserved	RO	0x0000.000	Software should not rely on the value of a reserved bit. To provide compatibility with future products, the value of a reserved bit should be preserved across a read-modify-write operation.
1	PMISC	R/W1C	0	<p>Programming Masked Interrupt Status and Clear</p> <p><b>Value Description</b></p> <p>1 When read, a 1 indicates that an unmasked interrupt was signaled because a programming cycle completed.</p> <p>Writing a 1 to this bit clears <b>PMISC</b> and also the <b>PRIS</b> bit in the <b>FCRIS</b> register (see page 222).</p> <p>0 When read, a 0 indicates that a programming cycle complete interrupt has not occurred.</p> <p>A write of 0 has no effect on the state of this bit.</p>
0	AMISC	R/W1C	0	<p>Access Masked Interrupt Status and Clear</p> <p><b>Value Description</b></p> <p>1 When read, a 1 indicates that an unmasked interrupt was signaled because a program or erase action was attempted on a block of Flash memory that contradicts the protection policy for that block as set in the <b>FMPPEn</b> registers.</p> <p>Writing a 1 to this bit clears <b>AMISC</b> and also the <b>ARIS</b> bit in the <b>FCRIS</b> register (see page 222).</p> <p>0 When read, a 0 indicates that no improper accesses have occurred.</p> <p>A write of 0 has no effect on the state of this bit.</p>



## Register 7: Flash Memory Control 2 (FMC2), offset 0x020

When this register is written, the Flash memory controller initiates the appropriate access cycle for the location specified by the **Flash Memory Address (FMA)** register (see page 218). If the access is a write access, the data contained in the **Flash Write Buffer (FWB)** registers is written.

This register must be the final register written as it initiates the memory operation.

### Flash Memory Control 2 (FMC2)

Base 0x400F.D000

Offset 0x020

Type R/W, reset 0x0000.0000

	31	30	29	28	27	26	25	24	23	22	21	20	19	18	17	16
	WRKEY															
Type	WO	WO	WO	WO	WO	WO	WO	WO	WO	WO	WO	WO	WO	WO	WO	WO
Reset	0	0	0	0	0	0	0	0	0	0	0	0	0	0	0	0
	15	14	13	12	11	10	9	8	7	6	5	4	3	2	1	0
	reserved															WRBUF
Type	RO	RO	RO	RO	RO	RO	RO	RO	RO	RO	RO	RO	RO	RO	RO	R/W
Reset	0	0	0	0	0	0	0	0	0	0	0	0	0	0	0	0

Bit/Field	Name	Type	Reset	Description
31:16	WRKEY	WO	0x0000	Flash Memory Write Key  This field contains a write key, which is used to minimize the incidence of accidental Flash memory writes. The value 0xA442 must be written into this field for a write to occur. Writes to the <b>FMC2</b> register without this <b>WRKEY</b> value are ignored. A read of this field returns the value 0.
15:1	reserved	RO	0x000	Software should not rely on the value of a reserved bit. To provide compatibility with future products, the value of a reserved bit should be preserved across a read-modify-write operation.
0	WRBUF	R/W	0	Buffered Flash Memory Write

This bit is used to start a buffered write to Flash memory.

#### Value Description

1 Set this bit to write the data stored in the **FWBn** registers to the location specified by the contents of the **FMA** register.

When read, a 1 indicates that the previous buffered Flash memory write access is not complete.

0 A write of 0 has no effect on the state of this bit.

When read, a 0 indicates that the previous buffered Flash memory write access is complete.

A buffered Flash memory write can take up to 4 ms.

## Register 8: Flash Write Buffer Valid (FWBVAL), offset 0x030

This register provides a bitwise status of which **FWB<sub>n</sub>** registers have been written by the processor since the last write of the Flash memory write buffer. The entries with a 1 are written on the next write of the Flash memory write buffer. This register is cleared after the write operation by hardware. A protection violation on the write operation also clears this status.

Software can program the same 32 words to various Flash memory locations by setting the **FWB<sub>[n]</sub>** bits after they are cleared by the write operation. The next write operation then uses the same data as the previous one. In addition, if a **FWB<sub>n</sub>** register change should not be written to Flash memory, software can clear the corresponding **FWB<sub>[n]</sub>** bit to preserve the existing data when the next write operation occurs.

### Flash Write Buffer Valid (FWBVAL)

Base 0x400F.D000

Offset 0x030

Type R/W, reset 0x0000.0000

	31	30	29	28	27	26	25	24	23	22	21	20	19	18	17	16
	FWB[n]															
Type	R/W	R/W	R/W	R/W	R/W	R/W	R/W	R/W	R/W	R/W	R/W	R/W	R/W	R/W	R/W	R/W
Reset	0	0	0	0	0	0	0	0	0	0	0	0	0	0	0	0
	15	14	13	12	11	10	9	8	7	6	5	4	3	2	1	0
	FWB[n]															
Type	R/W	R/W	R/W	R/W	R/W	R/W	R/W	R/W	R/W	R/W	R/W	R/W	R/W	R/W	R/W	R/W
Reset	0	0	0	0	0	0	0	0	0	0	0	0	0	0	0	0

Bit/Field	Name	Type	Reset	Description
31:0	FWB[n]	R/W	0x0	Flash Memory Write Buffer

#### Value Description

- |   |  |
|---|--|
| 1 | The corresponding <b>FWB<sub>n</sub></b> register has been updated since the last buffer write operation and is ready to be written to Flash memory. |
| 0 | The corresponding <b>FWB<sub>n</sub></b> register has no new data to be written.   |

Bit 0 corresponds to **FWB<sub>0</sub>**, offset 0x100, and bit 31 corresponds to **FWB<sub>31</sub>**, offset 0x13C.

## Register 9: Flash Write Buffer n (FWBn), offset 0x100 - 0x17C

These 32 registers hold the contents of the data to be written into the Flash memory on a buffered Flash memory write operation. The offset selects one of the 32-bit registers. Only **FWBn** registers that have been updated since the preceding buffered Flash memory write operation are written into the Flash memory, so it is not necessary to write the entire bank of registers in order to write 1 or 2 words. The **FWBn** registers are written into the Flash memory with the **FWB0** register corresponding to the address contained in **FMA**. **FWB1** is written to the address **FMA+0x4** etc. Note that only data bits that are 0 result in the Flash memory being modified. A data bit that is 1 leaves the content of the Flash memory bit at its previous value.

### Flash Write Buffer n (FWBn)

Base 0x400F.D000  
Offset 0x100 - 0x17C  
Type R/W, reset 0x0000.0000

	31	30	29	28	27	26	25	24	23	22	21	20	19	18	17	16
	DATA															
Type	R/W	R/W	R/W	R/W	R/W	R/W	R/W	R/W	R/W	R/W	R/W	R/W	R/W	R/W	R/W	R/W
Reset	0	0	0	0	0	0	0	0	0	0	0	0	0	0	0	0
	15	14	13	12	11	10	9	8	7	6	5	4	3	2	1	0
	DATA															
Type	R/W	R/W	R/W	R/W	R/W	R/W	R/W	R/W	R/W	R/W	R/W	R/W	R/W	R/W	R/W	R/W
Reset	0	0	0	0	0	0	0	0	0	0	0	0	0	0	0	0

Bit/Field	Name	Type	Reset	Description
31:0	DATA	R/W	0x0000.0000	Data Data to be written into the Flash memory.

## Register 10: Flash Control (FCTL), offset 0x0F8

This register is used to ensure that the microcontroller is powered down in a controlled fashion in systems where power is cycled more frequently than once every five minutes. The `USDREQ` bit should be set to indicate that power is going to be turned off. Software should poll the `USDACK` bit to determine when it is acceptable to power down.

### Flash Control (FCTL)

Base 0x400F.D000  
Offset 0x0F8  
Type R/W, reset 0x0000.0000

	31	30	29	28	27	26	25	24	23	22	21	20	19	18	17	16	
	reserved																
Type	RO	RO	RO	RO	RO	RO	RO	RO	RO	RO	RO	RO	RO	RO	RO	RO	
Reset	0	0	0	0	0	0	0	0	0	0	0	0	0	0	0	0	
	15	14	13	12	11	10	9	8	7	6	5	4	3	2	1	0	
	reserved															USDACK	USDREQ
Type	RO	RO	RO	RO	RO	RO	RO	RO	RO	RO	RO	RO	RO	RO	RO	R/W	
Reset	0	0	0	0	0	0	0	0	0	0	0	0	0	0	0	0	

Bit/Field	Name	Type	Reset	Description
31:2	reserved	RO	0x0000.000	Software should not rely on the value of a reserved bit. To provide compatibility with future products, the value of a reserved bit should be preserved across a read-modify-write operation.
1	USDACK	RO	0	User Shut Down Acknowledge  Value Description 1 The microcontroller can be powered down. 0 The microcontroller cannot yet be powered down.  This bit should be set within 50 ms of setting the <code>USDREQ</code> bit.
0	USDREQ	R/W	0	User Shut Down Request  Value Description 1 Requests permission to power down the microcontroller. 0 No effect.

## 7.6 Memory Register Descriptions (System Control Offset)

The remainder of this section lists and describes the registers that reside in Flash memory, in numerical order by address offset. Registers in this section are relative to the System Control base address of 0x400F.E000.

**Register 11: ROM Control (RMCTL), offset 0x0F0**

This register provides control of the ROM controller state. This register offset is relative to the System Control base address of 0x400F.E000.

**ROM Control (RMCTL)**

Base 0x400F.E000

Offset 0x0F0

Type R/W1C, reset -

	31	30	29	28	27	26	25	24	23	22	21	20	19	18	17	16
	reserved															
Type	RO	RO	RO	RO	RO	RO	RO	RO	RO	RO	RO	RO	RO	RO	RO	RO
Reset	0	0	0	0	0	0	0	0	0	0	0	0	0	0	0	0
	15	14	13	12	11	10	9	8	7	6	5	4	3	2	1	0
	reserved															BA
Type	RO	RO	RO	RO	RO	RO	RO	RO	RO	RO	RO	RO	RO	RO	RO	R/W1C
Reset	0	0	0	0	0	0	0	0	0	0	0	0	0	0	0	-

Bit/Field	Name	Type	Reset	Description
31:1	reserved	RO	0x0000.000	Software should not rely on the value of a reserved bit. To provide compatibility with future products, the value of a reserved bit should be preserved across a read-modify-write operation.
0	BA	R/W1C	-	Boot Alias

At reset, the user has the opportunity to direct the core to execute the ROM Boot Loader or the application in Flash memory by using any GPIO signal as configured in the **BOOTCFG** register. If the ROM boot loader is not selected, the system control module checks address 0x000.0004 to see if the Flash memory has a valid reset vector. If the data at address 0x0000.0004 is 0xFFFF.FFFF, then it is assumed that the Flash memory has not yet been programmed, and this bit is then set by hardware so that the on-chip ROM appears at address 0x0.

**Value Description**

- |   |  |
|---|--|
| 1 | The microcontroller's ROM appears at address 0x0. This bit is set automatically if the data at address 0x0000.0004 is 0xFFFF.FFFF. |
| 0 | The Flash memory is at address 0x0.  |

This bit is cleared by writing a 1 to this bit position.

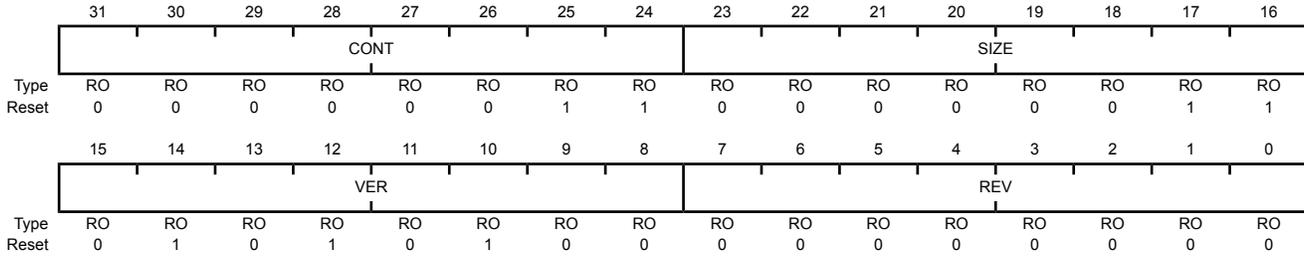
**Register 12: ROM Version Register (RMVER), offset 0x0F4**

**Note:** Offset is relative to System Control base address of 0x400FE000.

A 32-bit read-only register containing the ROM content version information.

ROM Version Register (RMVER)

Base 0x400F.E000  
 Offset 0x0F4  
 Type RO, reset 0x0303.5400



Bit/Field	Name	Type	Reset	Description
31:24	CONT	RO	0x03	ROM Contents  Value Description 0x03 Stellaris Boot Loader & DriverLib with AES, SAFERTOS, and Ethernet
23:16	SIZE	RO	0x03	ROM Size of Contents  This field encodes the size of the ROM.  Value Description 0x03 Stellaris Boot Loader & DriverLib with AES, SAFERTOS, and Ethernet
15:8	VER	RO	0x54	ROM Version
7:0	REV	RO	0x0	ROM Revision

## Register 13: Flash Memory Protection Read Enable 0 (FMPRE0), offset 0x130 and 0x200

**Note:** This register is aliased for backwards compatibility.

**Note:** Offset is relative to System Control base address of 0x400FE000.

This register stores the read-only protection bits for each 2-KB flash block (**FMPPEn** stores the execute-only bits). Flash memory up to a total of 64 KB is controlled by this register. Other **FMPREN** registers (if any) provide protection for other 64K blocks. This register is loaded during the power-on reset sequence. The factory settings for the **FMPREN** and **FMPPEn** registers are a value of 1 for all implemented banks. This achieves a policy of open access and programmability. The register bits may be changed by writing the specific register bit. However, this register is R/W0; the user can only change the protection bit from a 1 to a 0 (and may NOT change a 0 to a 1). The changes are not permanent until the register is committed (saved), at which point the bit change is permanent. If a bit is changed from a 1 to a 0 and not committed, it may be restored by executing a power-on reset sequence. The reset value shown only applies to power-on reset; any other type of reset does not affect this register. Once committed, the only way to restore the factory default value of this register is to perform the "Recover Locked Device" sequence detailed in the JTAG chapter. For additional information, see the "Flash Memory Protection" section.

### Flash Memory Protection Read Enable 0 (FMPRE0)

Base 0x400F.E000  
Offset 0x130 and 0x200  
Type R/W, reset 0xFFFF.FFFF

	31	30	29	28	27	26	25	24	23	22	21	20	19	18	17	16
	READ_ENABLE															
Type	R/W	R/W	R/W	R/W	R/W	R/W	R/W	R/W	R/W	R/W	R/W	R/W	R/W	R/W	R/W	R/W
Reset	1	1	1	1	1	1	1	1	1	1	1	1	1	1	1	1
	15	14	13	12	11	10	9	8	7	6	5	4	3	2	1	0
	READ_ENABLE															
Type	R/W	R/W	R/W	R/W	R/W	R/W	R/W	R/W	R/W	R/W	R/W	R/W	R/W	R/W	R/W	R/W
Reset	1	1	1	1	1	1	1	1	1	1	1	1	1	1	1	1

Bit/Field	Name	Type	Reset	Description
31:0	READ_ENABLE	R/W	0xFFFFFFFF	Flash Read Enable  Configures 2-KB flash blocks to be read or executed only. The policies may be combined as shown in the table "Flash Protection Policy Combinations".  Value            Description 0xFFFFFFFF    Bits [31:0] each enable protection on a 2-KB block of Flash memory up to the total of 64 KB.

## Register 14: Flash Memory Protection Program Enable 0 (FMPPE0), offset 0x134 and 0x400

**Note:** This register is aliased for backwards compatibility.

**Note:** Offset is relative to System Control base address of 0x400FE000.

This register stores the execute-only protection bits for each 2-KB flash block (**FMPPE<sub>n</sub>** stores the execute-only bits). Flash memory up to a total of 64 KB is controlled by this register. Other **FMPPE<sub>n</sub>** registers (if any) provide protection for other 64K blocks. This register is loaded during the power-on reset sequence. The factory settings for the **FMPPE<sub>n</sub>** and **FMPPE<sub>n</sub>** registers are a value of 1 for all implemented banks. This achieves a policy of open access and programmability. The register bits may be changed by writing the specific register bit. However, this register is R/W0; the user can only change the protection bit from a 1 to a 0 (and may NOT change a 0 to a 1). The changes are not permanent until the register is committed (saved), at which point the bit change is permanent. If a bit is changed from a 1 to a 0 and not committed, it may be restored by executing a power-on reset sequence. The reset value shown only applies to power-on reset; any other type of reset does not affect this register. Once committed, the only way to restore the factory default value of this register is to perform the "Recover Locked Device" sequence detailed in the JTAG chapter. For additional information, see the "Flash Memory Protection" section.

### Flash Memory Protection Program Enable 0 (FMPPE0)

Base 0x400F.E000  
Offset 0x134 and 0x400  
Type R/W, reset 0xFFFF.FFFF

	31	30	29	28	27	26	25	24	23	22	21	20	19	18	17	16
	PROG_ENABLE															
Type	R/W	R/W	R/W	R/W	R/W	R/W	R/W	R/W	R/W	R/W	R/W	R/W	R/W	R/W	R/W	R/W
Reset	1	1	1	1	1	1	1	1	1	1	1	1	1	1	1	1
	15	14	13	12	11	10	9	8	7	6	5	4	3	2	1	0
	PROG_ENABLE															
Type	R/W	R/W	R/W	R/W	R/W	R/W	R/W	R/W	R/W	R/W	R/W	R/W	R/W	R/W	R/W	R/W
Reset	1	1	1	1	1	1	1	1	1	1	1	1	1	1	1	1

Bit/Field	Name	Type	Reset	Description
31:0	PROG_ENABLE	R/W	0xFFFFFFFF	Flash Programming Enable

Configures 2-KB flash blocks to be execute only. The policies may be combined as shown in the table "Flash Protection Policy Combinations".

Value	Description
-------	-------------

0xFFFFFFFF	Bits [31:0] each enable protection on a 2-KB block of Flash memory up to the total of 64 KB.
------------	--



**Register 15: Boot Configuration (BOOTCFG), offset 0x1D0**

**Note:** Offset is relative to System Control base address of 0x400FE000.

This register provides configuration of a GPIO pin to enable the ROM Boot Loader as well as a write-once mechanism to disable external debugger access to the device. Upon reset, the user has the opportunity to direct the core to execute the ROM Boot Loader or the application in Flash memory by using any GPIO signal from Ports A-H as configured by the bits in this register. If the EN bit is set or the specified pin does not have the required polarity, the system control module checks address 0x000.0004 to see if the Flash memory has a valid reset vector. If the data at address 0x0000.0004 is 0xFFFF.FFFF, then it is assumed that the Flash memory has not yet been programmed, and the core executes the ROM Boot Loader. The DBG0 bit (bit 0) is set to 0 from the factory and the DBG1 bit (bit 1) is set to 1, which enables external debuggers. Clearing the DBG1 bit disables any external debugger access to the device permanently, starting with the next power-up cycle of the device. The NW bit (bit 31) indicates that the register has not yet been committed and is controlled through hardware to ensure that the register is only committed once. Prior to being committed, bits can only be changed from 1 to 0. The reset value shown only applies to power-on reset; any other type of reset does not affect this register. The only way to restore the factory default value of this register is to perform the "Recover Locked Device" sequence detailed in the JTAG chapter.

**Boot Configuration (BOOTCFG)**

Base 0x400F.E000

Offset 0x1D0

Type R/W, reset 0xFFFF.FFFE

	31	30	29	28	27	26	25	24	23	22	21	20	19	18	17	16
	NW	reserved														
Type	R/W	RO	RO	RO	RO	RO	RO	RO	RO	RO	RO	RO	RO	RO	RO	RO
Reset	1	1	1	1	1	1	1	1	1	1	1	1	1	1	1	1
	15	14	13	12	11	10	9	8	7	6	5	4	3	2	1	0
	PORT			PIN		POL	EN	reserved							DBG1	DBG0
Type	R/W	R/W	R/W	R/W	R/W	R/W	R/W	RO	RO	RO	RO	RO	RO	RO	R/W	R/W
Reset	1	1	1	1	1	1	1	1	1	1	1	1	1	1	1	0

Bit/Field	Name	Type	Reset	Description
31	NW	R/W	1	Not Written  When set, this bit indicates that this 32-bit register has not been committed. When clear, this bit specifies that this register has been committed and may not be committed again.
30:16	reserved	RO	0x7FFF	Software should not rely on the value of a reserved bit. To provide compatibility with future products, the value of a reserved bit should be preserved across a read-modify-write operation.

Bit/Field	Name	Type	Reset	Description																		
15:13	PORT	R/W	0x7	<p>Boot GPIO Port</p> <p>This field selects the port of the GPIO port pin that enables the ROM boot loader at reset.</p> <table border="1"> <thead> <tr> <th>Value</th> <th>Description</th> </tr> </thead> <tbody> <tr><td>0x0</td><td>Port A</td></tr> <tr><td>0x1</td><td>Port B</td></tr> <tr><td>0x2</td><td>Port C</td></tr> <tr><td>0x3</td><td>Port D</td></tr> <tr><td>0x4</td><td>Port E</td></tr> <tr><td>0x5</td><td>Port F</td></tr> <tr><td>0x6</td><td>Port G</td></tr> <tr><td>0x7</td><td>Port H</td></tr> </tbody> </table>	Value	Description	0x0	Port A	0x1	Port B	0x2	Port C	0x3	Port D	0x4	Port E	0x5	Port F	0x6	Port G	0x7	Port H
Value	Description																					
0x0	Port A																					
0x1	Port B																					
0x2	Port C																					
0x3	Port D																					
0x4	Port E																					
0x5	Port F																					
0x6	Port G																					
0x7	Port H																					
12:10	PIN	R/W	0x7	<p>Boot GPIO Pin</p> <p>This field selects the pin number of the GPIO port pin that enables the ROM boot loader at reset.</p> <table border="1"> <thead> <tr> <th>Value</th> <th>Description</th> </tr> </thead> <tbody> <tr><td>0x0</td><td>Pin 0</td></tr> <tr><td>0x1</td><td>Pin 1</td></tr> <tr><td>0x2</td><td>Pin 2</td></tr> <tr><td>0x3</td><td>Pin 3</td></tr> <tr><td>0x4</td><td>Pin 4</td></tr> <tr><td>0x5</td><td>Pin 5</td></tr> <tr><td>0x6</td><td>Pin 6</td></tr> <tr><td>0x7</td><td>Pin 7</td></tr> </tbody> </table>	Value	Description	0x0	Pin 0	0x1	Pin 1	0x2	Pin 2	0x3	Pin 3	0x4	Pin 4	0x5	Pin 5	0x6	Pin 6	0x7	Pin 7
Value	Description																					
0x0	Pin 0																					
0x1	Pin 1																					
0x2	Pin 2																					
0x3	Pin 3																					
0x4	Pin 4																					
0x5	Pin 5																					
0x6	Pin 6																					
0x7	Pin 7																					
9	POL	R/W	0x1	<p>Boot GPIO Polarity</p> <p>When set, this bit selects a high level for the GPIO port pin to enable the ROM boot loader at reset. When clear, this bit selects a low level for the GPIO port pin.</p>																		
8	EN	R/W	0x1	<p>Boot GPIO Enable</p> <p>Clearing this bit enables the use of a GPIO pin to enable the ROM Boot Loader at reset. When this bit is set, the contents of address 0x0000.0004 are checked to see if the Flash memory has been programmed. If the contents are not 0xFFFF.FFFF, the core executes out of Flash memory. If the Flash has not been programmed, the core executes out of ROM.</p>																		
7:2	reserved	RO	0x3F	<p>Software should not rely on the value of a reserved bit. To provide compatibility with future products, the value of a reserved bit should be preserved across a read-modify-write operation.</p>																		
1	DBG1	R/W	1	<p>Debug Control 1</p> <p>The DBG1 bit must be 1 and DBG0 must be 0 for debug to be available.</p>																		

Bit/Field	Name	Type	Reset	Description
0	DBG0	R/W	0x0	Debug Control 0 The DBG1 bit must be 1 and DBG0 must be 0 for debug to be available.

**Register 16: User Register 0 (USER\_REG0), offset 0x1E0**

**Note:** Offset is relative to System Control base address of 0x400FE000.

This register provides 31 bits of user-defined data that is non-volatile and can only be committed once. Bit 31 indicates that the register is available to be committed and is controlled through hardware to ensure that the register is only committed once. Prior to being committed, bits can only be changed from 1 to 0. The reset value shown only applies to power-on reset; any other type of reset does not affect this register. The write-once characteristics of this register are useful for keeping static information like communication addresses that need to be unique per part and would otherwise require an external EEPROM or other non-volatile device. The only way to restore the factory default value of this register is to perform the "Recover Locked Device" sequence detailed in the JTAG section.

**User Register 0 (USER\_REG0)**

Base 0x400F.E000

Offset 0x1E0

Type R/W, reset 0xFFFF.FFFF

	31	30	29	28	27	26	25	24	23	22	21	20	19	18	17	16
	NW	DATA														
Type	R/W	R/W	R/W	R/W	R/W	R/W	R/W	R/W	R/W	R/W	R/W	R/W	R/W	R/W	R/W	R/W
Reset	1	1	1	1	1	1	1	1	1	1	1	1	1	1	1	1
	15	14	13	12	11	10	9	8	7	6	5	4	3	2	1	0
	DATA															
Type	R/W	R/W	R/W	R/W	R/W	R/W	R/W	R/W	R/W	R/W	R/W	R/W	R/W	R/W	R/W	R/W
Reset	1	1	1	1	1	1	1	1	1	1	1	1	1	1	1	1

Bit/Field	Name	Type	Reset	Description
31	NW	R/W	1	Not Written  When set, this bit indicates that this 32-bit register has not been committed. When clear, this bit specifies that this register has been committed and may not be committed again.
30:0	DATA	R/W	0x7FFFFFFF	User Data  Contains the user data value. This field is initialized to all 1s and can only be committed once.

**Register 17: User Register 1 (USER\_REG1), offset 0x1E4**

**Note:** Offset is relative to System Control base address of 0x400FE000.

This register provides 31 bits of user-defined data that is non-volatile and can only be written once. Bit 31 indicates that the register is available to be written and is controlled through hardware to ensure that the register is only written once. The write-once characteristics of this register are useful for keeping static information like communication addresses that need to be unique per part and would otherwise require an external EEPROM or other non-volatile device.

**User Register 1 (USER\_REG1)**

Base 0x400F.E000

Offset 0x1E4

Type R/W, reset 0xFFFF.FFFF

	31	30	29	28	27	26	25	24	23	22	21	20	19	18	17	16
	NW	DATA														
Type	R/W	R/W	R/W	R/W	R/W	R/W	R/W	R/W	R/W	R/W	R/W	R/W	R/W	R/W	R/W	R/W
Reset	1	1	1	1	1	1	1	1	1	1	1	1	1	1	1	1
	15	14	13	12	11	10	9	8	7	6	5	4	3	2	1	0
	DATA															
Type	R/W	R/W	R/W	R/W	R/W	R/W	R/W	R/W	R/W	R/W	R/W	R/W	R/W	R/W	R/W	R/W
Reset	1	1	1	1	1	1	1	1	1	1	1	1	1	1	1	1

Bit/Field	Name	Type	Reset	Description
31	NW	R/W	1	Not Written  When set, this bit indicates that this 32-bit register has not been committed. When clear, this bit specifies that this register has been committed and may not be committed again.
30:0	DATA	R/W	0x7FFFFFFF	User Data  Contains the user data value. This field is initialized to all 1s and can only be committed once.

### Register 18: User Register 2 (USER\_REG2), offset 0x1E8

**Note:** Offset is relative to System Control base address of 0x400FE000.

This register provides 31 bits of user-defined data that is non-volatile and can only be written once. Bit 31 indicates that the register is available to be written and is controlled through hardware to ensure that the register is only written once. The write-once characteristics of this register are useful for keeping static information like communication addresses that need to be unique per part and would otherwise require an external EEPROM or other non-volatile device.

#### User Register 2 (USER\_REG2)

Base 0x400F.E000  
 Offset 0x1E8  
 Type R/W, reset 0xFFFF.FFFF

	31	30	29	28	27	26	25	24	23	22	21	20	19	18	17	16
	NW	DATA														
Type	R/W	R/W	R/W	R/W	R/W	R/W	R/W	R/W	R/W	R/W	R/W	R/W	R/W	R/W	R/W	R/W
Reset	1	1	1	1	1	1	1	1	1	1	1	1	1	1	1	1
	15	14	13	12	11	10	9	8	7	6	5	4	3	2	1	0
	DATA															
Type	R/W	R/W	R/W	R/W	R/W	R/W	R/W	R/W	R/W	R/W	R/W	R/W	R/W	R/W	R/W	R/W
Reset	1	1	1	1	1	1	1	1	1	1	1	1	1	1	1	1

Bit/Field	Name	Type	Reset	Description
31	NW	R/W	1	Not Written  When set, this bit indicates that this 32-bit register has not been committed. When clear, this bit specifies that this register has been committed and may not be committed again.
30:0	DATA	R/W	0x7FFFFFFF	User Data  Contains the user data value. This field is initialized to all 1s and can only be committed once.

**Register 19: User Register 3 (USER\_REG3), offset 0x1EC**

**Note:** Offset is relative to System Control base address of 0x400FE000.

This register provides 31 bits of user-defined data that is non-volatile and can only be written once. Bit 31 indicates that the register is available to be written and is controlled through hardware to ensure that the register is only written once. The write-once characteristics of this register are useful for keeping static information like communication addresses that need to be unique per part and would otherwise require an external EEPROM or other non-volatile device.

**User Register 3 (USER\_REG3)**

Base 0x400F.E000

Offset 0x1EC

Type R/W, reset 0xFFFF.FFFF

	31	30	29	28	27	26	25	24	23	22	21	20	19	18	17	16
	NW	DATA														
Type	R/W	R/W	R/W	R/W	R/W	R/W	R/W	R/W	R/W	R/W	R/W	R/W	R/W	R/W	R/W	R/W
Reset	1	1	1	1	1	1	1	1	1	1	1	1	1	1	1	1
	15	14	13	12	11	10	9	8	7	6	5	4	3	2	1	0
	DATA															
Type	R/W	R/W	R/W	R/W	R/W	R/W	R/W	R/W	R/W	R/W	R/W	R/W	R/W	R/W	R/W	R/W
Reset	1	1	1	1	1	1	1	1	1	1	1	1	1	1	1	1

Bit/Field	Name	Type	Reset	Description
31	NW	R/W	1	Not Written  When set, this bit indicates that this 32-bit register has not been committed. When clear, this bit specifies that this register has been committed and may not be committed again.
30:0	DATA	R/W	0x7FFFFFFF	User Data  Contains the user data value. This field is initialized to all 1s and can only be committed once.

## Register 20: Flash Memory Protection Read Enable 1 (FMPRE1), offset 0x204

**Note:** Offset is relative to System Control base address of 0x400FE000.

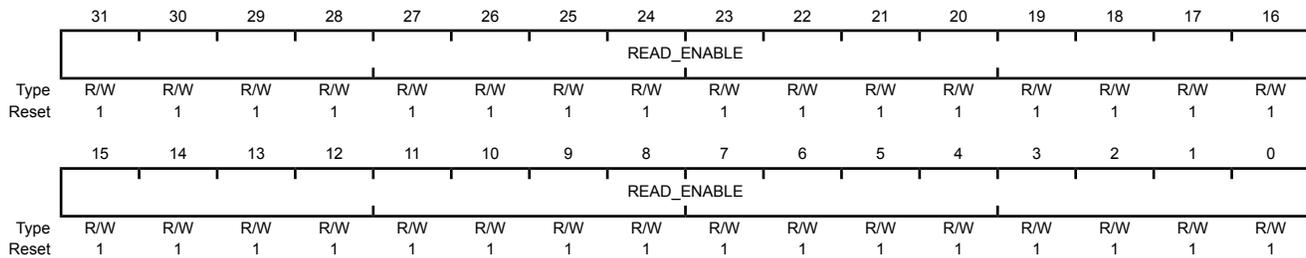
This register stores the read-only protection bits for each 2-KB flash block (**FMPPE<sub>n</sub>** stores the execute-only bits). Flash memory up to a total of 64 KB is controlled by this register. Other **FMPRE<sub>n</sub>** registers (if any) provide protection for other 64K blocks. This register is loaded during the power-on reset sequence. The factory settings for the **FMPRE<sub>n</sub>** and **FMPPE<sub>n</sub>** registers are a value of 1 for all implemented banks. This achieves a policy of open access and programmability. The register bits may be changed by writing the specific register bit. However, this register is R/W0; the user can only change the protection bit from a 1 to a 0 (and may NOT change a 0 to a 1). The changes are not permanent until the register is committed (saved), at which point the bit change is permanent. If a bit is changed from a 1 to a 0 and not committed, it may be restored by executing a power-on reset sequence. The reset value shown only applies to power-on reset; any other type of reset does not affect this register. Once committed, the only way to restore the factory default value of this register is to perform the "Recover Locked Device" sequence detailed in the JTAG chapter. If the Flash memory size on the device is less than 64 KB, this register usually reads as zeroes, but software should not rely on these bits to be zero. For additional information, see the "Flash Memory Protection" section.

### Flash Memory Protection Read Enable 1 (FMPRE1)

Base 0x400F.E000

Offset 0x204

Type R/W, reset 0xFFFF.FFFF



Bit/Field	Name	Type	Reset	Description
-----------	------	------	-------	-------------

31:0	READ_ENABLE	R/W	0xFFFFFFFF	Flash Read Enable
------	-------------	-----	------------	-------------------

Configures 2-KB flash blocks to be read or executed only. The policies may be combined as shown in the table "Flash Protection Policy Combinations".

Value	Description
-------	-------------

0xFFFFFFFF	Bits [31:0] each enable protection on a 2-KB block of Flash memory in memory range from 65 to 128 KB.
------------	---



**Register 21: Flash Memory Protection Read Enable 2 (FMPRE2), offset 0x208**

**Note:** Offset is relative to System Control base address of 0x400FE000.

This register stores the read-only protection bits for each 2-KB flash block (**FMPPE<sub>n</sub>** stores the execute-only bits). Flash memory up to a total of 64 KB is controlled by this register. Other **FMPRE<sub>n</sub>** registers (if any) provide protection for other 64K blocks. This register is loaded during the power-on reset sequence. The factory settings for the **FMPRE<sub>n</sub>** and **FMPPE<sub>n</sub>** registers are a value of 1 for all implemented banks. This achieves a policy of open access and programmability. The register bits may be changed by writing the specific register bit. However, this register is R/W0; the user can only change the protection bit from a 1 to a 0 (and may NOT change a 0 to a 1). The changes are not permanent until the register is committed (saved), at which point the bit change is permanent. If a bit is changed from a 1 to a 0 and not committed, it may be restored by executing a power-on reset sequence. The reset value shown only applies to power-on reset; any other type of reset does not affect this register. Once committed, the only way to restore the factory default value of this register is to perform the "Recover Locked Device" sequence detailed in the JTAG chapter. If the Flash memory size on the device is less than 128 KB, this register usually reads as zeroes, but software should not rely on these bits to be zero. For additional information, see the "Flash Memory Protection" section.

**Flash Memory Protection Read Enable 2 (FMPRE2)**

Base 0x400F.E000

Offset 0x208

Type R/W, reset 0xFFFF.FFFF

	31	30	29	28	27	26	25	24	23	22	21	20	19	18	17	16
	READ_ENABLE															
Type	R/W	R/W	R/W	R/W	R/W	R/W	R/W	R/W	R/W	R/W	R/W	R/W	R/W	R/W	R/W	R/W
Reset	1	1	1	1	1	1	1	1	1	1	1	1	1	1	1	1
	15	14	13	12	11	10	9	8	7	6	5	4	3	2	1	0
	READ_ENABLE															
Type	R/W	R/W	R/W	R/W	R/W	R/W	R/W	R/W	R/W	R/W	R/W	R/W	R/W	R/W	R/W	R/W
Reset	1	1	1	1	1	1	1	1	1	1	1	1	1	1	1	1

Bit/Field	Name	Type	Reset	Description
31:0	READ_ENABLE	R/W	0xFFFFFFFF	Flash Read Enable

Configures 2-KB flash blocks to be read or executed only. The policies may be combined as shown in the table "Flash Protection Policy Combinations".

Value	Description
-------	-------------

0xFFFFFFFF	Bits [31:0] each enable protection on a 2-KB block of Flash memory in the range from 129 to 192 KB.
------------	---

**Register 22: Flash Memory Protection Read Enable 3 (FMPRE3), offset 0x20C**

**Note:** Offset is relative to System Control base address of 0x400FE000.

This register stores the read-only protection bits for each 2-KB flash block (**FMPPEn** stores the execute-only bits). Flash memory up to a total of 64 KB is controlled by this register. Other **FMPREn** registers (if any) provide protection for other 64K blocks. This register is loaded during the power-on reset sequence. The factory settings for the **FMPREN** and **FMPPEn** registers are a value of 1 for all implemented banks. This achieves a policy of open access and programmability. The register bits may be changed by writing the specific register bit. However, this register is R/W0; the user can only change the protection bit from a 1 to a 0 (and may NOT change a 0 to a 1). The changes are not permanent until the register is committed (saved), at which point the bit change is permanent. If a bit is changed from a 1 to a 0 and not committed, it may be restored by executing a power-on reset sequence. The reset value shown only applies to power-on reset; any other type of reset does not affect this register. Once committed, the only way to restore the factory default value of this register is to perform the "Recover Locked Device" sequence detailed in the JTAG chapter. If the Flash memory size on the device is less than 192 KB, this register usually reads as zeroes, but software should not rely on these bits to be zero. For additional information, see the "Flash Memory Protection" section.

## Flash Memory Protection Read Enable 3 (FMPRE3)

Base 0x400F.E000

Offset 0x20C

Type R/W, reset 0xFFFFFFFF

	31	30	29	28	27	26	25	24	23	22	21	20	19	18	17	16
	READ_ENABLE															
Type	R/W	R/W	R/W	R/W	R/W	R/W	R/W	R/W	R/W	R/W	R/W	R/W	R/W	R/W	R/W	R/W
Reset	1	1	1	1	1	1	1	1	1	1	1	1	1	1	1	1
	15	14	13	12	11	10	9	8	7	6	5	4	3	2	1	0
	READ_ENABLE															
Type	R/W	R/W	R/W	R/W	R/W	R/W	R/W	R/W	R/W	R/W	R/W	R/W	R/W	R/W	R/W	R/W
Reset	1	1	1	1	1	1	1	1	1	1	1	1	1	1	1	1

Bit/Field	Name	Type	Reset	Description
31:0	READ_ENABLE	R/W	0xFFFFFFFF	Flash Read Enable

Configures 2-KB flash blocks to be read or executed only. The policies may be combined as shown in the table "Flash Protection Policy Combinations".

Value	Description
-------	-------------

0xFFFFFFFF	Bits [31:0] each enable protection on a 2-KB block of Flash memory in the range from 193 to 256 KB.
------------	---

## Register 23: Flash Memory Protection Program Enable 1 (FMPPE1), offset 0x404

**Note:** Offset is relative to System Control base address of 0x400FE000.

This register stores the execute-only protection bits for each 2-KB flash block (**FMPREN** stores the execute-only bits). Flash memory up to a total of 64 KB is controlled by this register. Other **FMPPEn** registers (if any) provide protection for other 64K blocks. This register is loaded during the power-on reset sequence. The factory settings for the **FMPREN** and **FMPPEn** registers are a value of 1 for all implemented banks. This achieves a policy of open access and programmability. The register bits may be changed by writing the specific register bit. However, this register is R/W0; the user can only change the protection bit from a 1 to a 0 (and may NOT change a 0 to a 1). The changes are not permanent until the register is committed (saved), at which point the bit change is permanent. If a bit is changed from a 1 to a 0 and not committed, it may be restored by executing a power-on reset sequence. The reset value shown only applies to power-on reset; any other type of reset does not affect this register. Once committed, the only way to restore the factory default value of this register is to perform the "Recover Locked Device" sequence detailed in the JTAG chapter. If the Flash memory size on the device is less than 64 KB, this register usually reads as zeroes, but software should not rely on these bits to be zero. For additional information, see the "Flash Memory Protection" section.

### Flash Memory Protection Program Enable 1 (FMPPE1)

Base 0x400F.E000

Offset 0x404

Type R/W, reset 0xFFFF.FFFF

	31	30	29	28	27	26	25	24	23	22	21	20	19	18	17	16
	PROG_ENABLE															
Type	R/W	R/W	R/W	R/W	R/W	R/W	R/W	R/W	R/W	R/W	R/W	R/W	R/W	R/W	R/W	R/W
Reset	1	1	1	1	1	1	1	1	1	1	1	1	1	1	1	1
	15	14	13	12	11	10	9	8	7	6	5	4	3	2	1	0
	PROG_ENABLE															
Type	R/W	R/W	R/W	R/W	R/W	R/W	R/W	R/W	R/W	R/W	R/W	R/W	R/W	R/W	R/W	R/W
Reset	1	1	1	1	1	1	1	1	1	1	1	1	1	1	1	1

Bit/Field	Name	Type	Reset	Description
31:0	PROG_ENABLE	R/W	0xFFFFFFFF	Flash Programming Enable

Value	Description
0xFFFFFFFF	Bits [31:0] each enable protection on a 2-KB block of Flash memory in memory range from 65 to 128 KB.

## Register 24: Flash Memory Protection Program Enable 2 (FMPPE2), offset 0x408

**Note:** Offset is relative to System Control base address of 0x400FE000.

This register stores the execute-only protection bits for each 2-KB flash block (**FMPPE<sub>n</sub>** stores the execute-only bits). Flash memory up to a total of 64 KB is controlled by this register. Other **FMPPE<sub>n</sub>** registers (if any) provide protection for other 64K blocks. This register is loaded during the power-on reset sequence. The factory settings for the **FMPPE<sub>n</sub>** and **FMPPE<sub>n</sub>** registers are a value of 1 for all implemented banks. This achieves a policy of open access and programmability. The register bits may be changed by writing the specific register bit. However, this register is R/W0; the user can only change the protection bit from a 1 to a 0 (and may NOT change a 0 to a 1). The changes are not permanent until the register is committed (saved), at which point the bit change is permanent. If a bit is changed from a 1 to a 0 and not committed, it may be restored by executing a power-on reset sequence. The reset value shown only applies to power-on reset; any other type of reset does not affect this register. Once committed, the only way to restore the factory default value of this register is to perform the "Recover Locked Device" sequence detailed in the JTAG chapter. If the Flash memory size on the device is less than 128 KB, this register usually reads as zeroes, but software should not rely on these bits to be zero. For additional information, see the "Flash Memory Protection" section.

### Flash Memory Protection Program Enable 2 (FMPPE2)

Base 0x400F.E000

Offset 0x408

Type R/W, reset 0xFFFF.FFFF

	31	30	29	28	27	26	25	24	23	22	21	20	19	18	17	16
	PROG_ENABLE															
Type	R/W	R/W	R/W	R/W	R/W	R/W	R/W	R/W	R/W	R/W	R/W	R/W	R/W	R/W	R/W	R/W
Reset	1	1	1	1	1	1	1	1	1	1	1	1	1	1	1	1
	15	14	13	12	11	10	9	8	7	6	5	4	3	2	1	0
	PROG_ENABLE															
Type	R/W	R/W	R/W	R/W	R/W	R/W	R/W	R/W	R/W	R/W	R/W	R/W	R/W	R/W	R/W	R/W
Reset	1	1	1	1	1	1	1	1	1	1	1	1	1	1	1	1

Bit/Field	Name	Type	Reset	Description
31:0	PROG_ENABLE	R/W	0xFFFFFFFF	Flash Programming Enable

Value	Description
0xFFFFFFFF	Bits [31:0] each enable protection on a 2-KB block of Flash memory in the range from 129 to 192 KB.

## Register 25: Flash Memory Protection Program Enable 3 (FMPPE3), offset 0x40C

**Note:** Offset is relative to System Control base address of 0x400FE000.

This register stores the execute-only protection bits for each 2-KB flash block (**FMPPEn** stores the execute-only bits). Flash memory up to a total of 64 KB is controlled by this register. Other **FMPPEn** registers (if any) provide protection for other 64K blocks. This register is loaded during the power-on reset sequence. The factory settings for the **FMPPEn** and **FMPPEn** registers are a value of 1 for all implemented banks. This achieves a policy of open access and programmability. The register bits may be changed by writing the specific register bit. However, this register is R/W0; the user can only change the protection bit from a 1 to a 0 (and may NOT change a 0 to a 1). The changes are not permanent until the register is committed (saved), at which point the bit change is permanent. If a bit is changed from a 1 to a 0 and not committed, it may be restored by executing a power-on reset sequence. The reset value shown only applies to power-on reset; any other type of reset does not affect this register. Once committed, the only way to restore the factory default value of this register is to perform the "Recover Locked Device" sequence detailed in the JTAG chapter. If the Flash memory size on the device is less than 192 KB, this register usually reads as zeroes, but software should not rely on these bits to be zero. For additional information, see the "Flash Memory Protection" section.

### Flash Memory Protection Program Enable 3 (FMPPE3)

Base 0x400F.E000

Offset 0x40C

Type R/W, reset 0xFFFF.FFFF

	31	30	29	28	27	26	25	24	23	22	21	20	19	18	17	16
	PROG_ENABLE															
Type	R/W	R/W	R/W	R/W	R/W	R/W	R/W	R/W	R/W	R/W	R/W	R/W	R/W	R/W	R/W	R/W
Reset	1	1	1	1	1	1	1	1	1	1	1	1	1	1	1	1
	15	14	13	12	11	10	9	8	7	6	5	4	3	2	1	0
	PROG_ENABLE															
Type	R/W	R/W	R/W	R/W	R/W	R/W	R/W	R/W	R/W	R/W	R/W	R/W	R/W	R/W	R/W	R/W
Reset	1	1	1	1	1	1	1	1	1	1	1	1	1	1	1	1

Bit/Field	Name	Type	Reset	Description
31:0	PROG_ENABLE	R/W	0xFFFFFFFF	Flash Programming Enable

Value	Description
0xFFFFFFFF	Bits [31:0] each enable protection on a 2-KB block of Flash memory in the range from 193 to 256 KB.

## 8 Micro Direct Memory Access ( $\mu$ DMA)

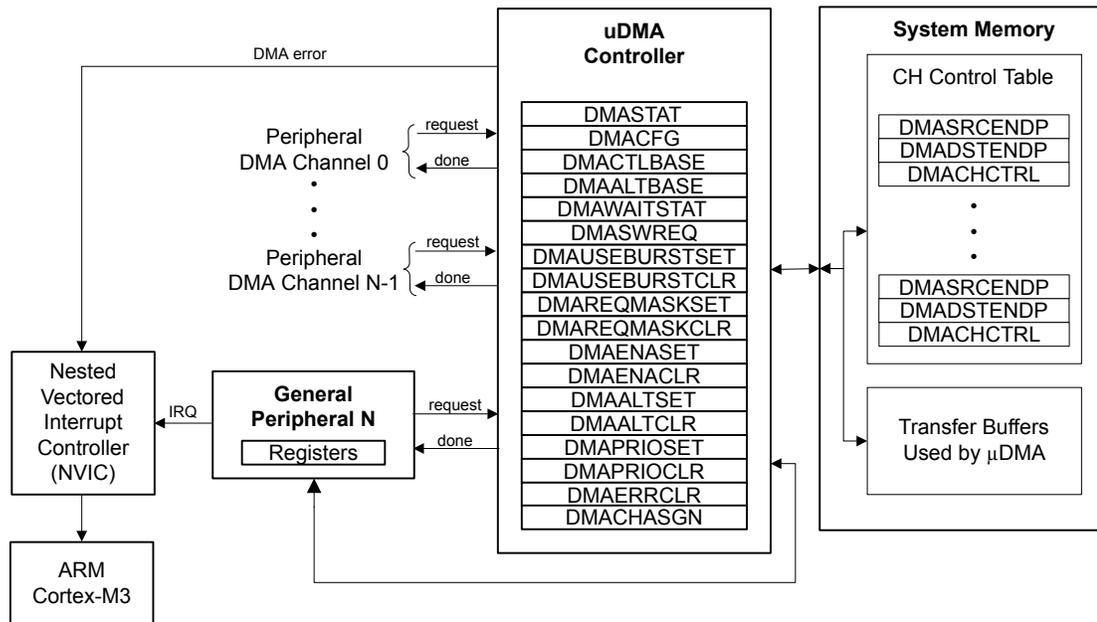
The LM3S9B96 microcontroller includes a Direct Memory Access (DMA) controller, known as micro-DMA ( $\mu$ DMA). The  $\mu$ DMA controller provides a way to offload data transfer tasks from the Cortex-M3 processor, allowing for more efficient use of the processor and the available bus bandwidth. The  $\mu$ DMA controller can perform transfers between memory and peripherals. It has dedicated channels for each supported on-chip module and can be programmed to automatically perform transfers between peripherals and memory as the peripheral is ready to transfer more data. The  $\mu$ DMA controller provides the following features:

- ARM PrimeCell® 32-channel configurable  $\mu$ DMA controller
- Support for memory-to-memory, memory-to-peripheral, and peripheral-to-memory in multiple transfer modes
  - Basic for simple transfer scenarios
  - Ping-pong for continuous data flow
  - Scatter-gather for a programmable list of arbitrary transfers initiated from a single request
- Highly flexible and configurable channel operation
  - Independently configured and operated channels
  - Dedicated channels for supported on-chip modules: GP Timer, USB, UART, Ethernet, ADC, EPI, SSI, I<sup>2</sup>S
  - Primary and secondary channel assignments
  - One channel each for receive and transmit path for bidirectional modules
  - Dedicated channel for software-initiated transfers
  - Per-channel configurable bus arbitration scheme
  - Optional software-initiated requests for any channel
- Two levels of priority
- Design optimizations for improved bus access performance between  $\mu$ DMA controller and the processor core
  - $\mu$ DMA controller access is subordinate to core access
  - RAM striping
  - Peripheral bus segmentation
- Data sizes of 8, 16, and 32 bits
- Transfer size is programmable in binary steps from 1 to 1024
- Source and destination address increment size of byte, half-word, word, or no increment

- Maskable peripheral requests
- Interrupt on transfer completion, with a separate interrupt per channel

## 8.1 Block Diagram

Figure 8-1.  $\mu$ DMA Block Diagram



## 8.2 Functional Description

The  $\mu$ DMA controller is a flexible and highly configurable DMA controller designed to work efficiently with the microcontroller's Cortex-M3 processor core. It supports multiple data sizes and address increment schemes, multiple levels of priority among DMA channels, and several transfer modes to allow for sophisticated programmed data transfers. The  $\mu$ DMA controller's usage of the bus is always subordinate to the processor core, so it never holds up a bus transaction by the processor. Because the  $\mu$ DMA controller is only using otherwise-idle bus cycles, the data transfer bandwidth it provides is essentially free, with no impact on the rest of the system. The bus architecture has been optimized to greatly enhance the ability of the processor core and the  $\mu$ DMA controller to efficiently share the on-chip bus, thus improving performance. The optimizations include RAM striping and peripheral bus segmentation, which in many cases allow both the processor core and the  $\mu$ DMA controller to access the bus and perform simultaneous data transfers.

The  $\mu$ DMA controller can transfer data to and from the on-chip SRAM. However, because the Flash memory and ROM are located on a separate internal bus, it is not possible to transfer data from the Flash memory or ROM with the  $\mu$ DMA controller.

Each peripheral function that is supported has a dedicated channel on the  $\mu$ DMA controller that can be configured independently. The  $\mu$ DMA controller implements a unique configuration method using channel control structures that are maintained in system memory by the processor. While simple transfer modes are supported, it is also possible to build up sophisticated "task" lists in memory that allow the  $\mu$ DMA controller to perform arbitrary-sized transfers to and from arbitrary locations as part of a single transfer request. The  $\mu$ DMA controller also supports the use of ping-pong buffering to accommodate constant streaming of data to or from a peripheral.

Each channel also has a configurable arbitration size. The arbitration size is the number of items that are transferred in a burst before the  $\mu$ DMA controller rearbiterates for channel priority. Using the arbitration size, it is possible to control exactly how many items are transferred to or from a peripheral each time it makes a  $\mu$ DMA service request.

## 8.2.1 Channel Assignments

$\mu$ DMA channels 0-31 are assigned to peripherals according to the following table. The **DMA Channel Assignment (DMACHASGN)** register (see page 294) can be used to specify the primary or secondary assignment. If the primary function is not available on this microcontroller, the secondary function becomes the primary function. If the secondary function is not available, the primary function is the only option.

**Note:** Channels noted in the table as "Available for software" may be assigned to peripherals in the future. However, they are currently available for software use. Channel 30 is dedicated for software use.

The USB endpoints mapped to  $\mu$ DMA channels 0-3 can be changed with the **USBDMASEL** register (see page 1012).

If a channel is marked with "\*" below and is configured to transfer data with a software request using the **DMASWREQ** register, this channel must also be enabled in the **DMAENASET** register.

**Table 8-1.  $\mu$ DMA Channel Assignments**

$\mu$ DMA Channel	Primary Assignment	Secondary Assignment
0	USB Endpoint 1 Receive	UART2 Receive*
1	USB Endpoint 1 Transmit	UART2 Transmit*
2	USB Endpoint 2 Receive	General-Purpose Timer 3A*
3	USB Endpoint 2 Transmit	General-Purpose Timer 3B*
4	USB Endpoint 3 Receive	General-Purpose Timer 2A*
5	USB Endpoint 3 Transmit	General-Purpose Timer 2B*
6	Ethernet Receive	General-Purpose Timer 2A*
7	Ethernet Transmit	General-Purpose Timer 2B*
8	UART0 Receive	UART1 Receive
9	UART0 Transmit	UART1 Transmit
10	SSI0 Receive	SSI1 Receive
11	SSI0 Transmit	SSI1 Transmit
12	Available for software	UART2 Receive*
13	Available for software	UART2 Transmit*
14	ADC0 Sample Sequencer 0	General-Purpose Timer 2A*
15	ADC0 Sample Sequencer 1	General-Purpose Timer 2B*
16	ADC0 Sample Sequencer 2	Available for software
17	ADC0 Sample Sequencer 3	Available for software
18	General-Purpose Timer 0A	General-Purpose Timer 1A
19	General-Purpose Timer 0B	General-Purpose Timer 1B
20	General-Purpose Timer 1A	EPI0 NBRFIFO*
21	General-Purpose Timer 1B	EPI0 WFIFO*
22	UART1 Receive	Available for software



Table 8-1.  $\mu$ DMA Channel Assignments (*continued*)

$\mu$ DMA Channel	Primary Assignment	Secondary Assignment
23	UART1 Transmit	Available for software
24	SSI1 Receive	ADC1 Sample Sequencer 0*
25	SSI1 Transmit	ADC1 Sample Sequencer 1*
26	Available for software	ADC1 Sample Sequencer 2*
27	Available for software	ADC1 Sample Sequencer 3*
28	I <sup>2</sup> S0 Receive	Available for software
29	I <sup>2</sup> S0 Transmit	Available for software
30	Dedicated for software use	
31	Reserved	

### 8.2.2 Priority

The  $\mu$ DMA controller assigns priority to each channel based on the channel number and the priority level bit for the channel. Channel number 0 has the highest priority and as the channel number increases, the priority of a channel decreases. Each channel has a priority level bit to provide two levels of priority: default priority and high priority. If the priority level bit is set, then that channel has higher priority than all other channels at default priority. If multiple channels are set for high priority, then the channel number is used to determine relative priority among all the high priority channels.

The priority bit for a channel can be set using the **DMA Channel Priority Set (DMAPRIOSET)** register and cleared with the **DMA Channel Priority Clear (DMAPRIOCLR)** register.

### 8.2.3 Arbitration Size

When a  $\mu$ DMA channel requests a transfer, the  $\mu$ DMA controller arbitrates among all the channels making a request and services the  $\mu$ DMA channel with the highest priority. Once a transfer begins, it continues for a selectable number of transfers before re-arbitrating among the requesting channels again. The arbitration size can be configured for each channel, ranging from 1 to 1024 item transfers. After the  $\mu$ DMA controller transfers the number of items specified by the arbitration size, it then checks among all the channels making a request and services the channel with the highest priority.

If a lower priority  $\mu$ DMA channel uses a large arbitration size, the latency for higher priority channels is increased because the  $\mu$ DMA controller completes the lower priority burst before checking for higher priority requests. Therefore, lower priority channels should not use a large arbitration size for best response on high priority channels.

The arbitration size can also be thought of as a burst size. It is the maximum number of items that are transferred at any one time in a burst. Here, the term arbitration refers to determination of  $\mu$ DMA channel priority, not arbitration for the bus. When the  $\mu$ DMA controller arbitrates for the bus, the processor always takes priority. Furthermore, the  $\mu$ DMA controller is held off whenever the processor must perform a bus transaction on the same bus, even in the middle of a burst transfer.

### 8.2.4 Request Types

The  $\mu$ DMA controller responds to two types of requests from a peripheral: single or burst. Each peripheral may support either or both types of requests. A single request means that the peripheral is ready to transfer one item, while a burst request means that the peripheral is ready to transfer multiple items.

The  $\mu$ DMA controller responds differently depending on whether the peripheral is making a single request or a burst request. If both are asserted, and the  $\mu$ DMA channel has been set up for a burst

transfer, then the burst request takes precedence. See Table 8-2, which shows how each peripheral supports the two request types.

**Table 8-2. Request Type Support**

Peripheral	Single Request Signal	Burst Request Signal
USB TX	None	FIFO TXRDY
USB RX	None	FIFO RXRDY
Ethernet TX	TX FIFO empty	None
Ethernet RX	RX packet received	None
UART TX	TX FIFO Not Full	TX FIFO Level (configurable)
UART RX	RX FIFO Not Empty	RX FIFO Level (configurable)
SSI TX	TX FIFO Not Full	TX FIFO Level (fixed at 4)
SSI RX	RX FIFO Not Empty	RX FIFO Level (fixed at 4)
ADC	None	Sequencer $\overline{IE}$ bit
General-Purpose Timer	None	Raw interrupt pulse
I <sup>2</sup> S TX	None	FIFO service request
I <sup>2</sup> S RX	None	FIFO service request
EPI WFIFO	None	WFIFO Level (configurable)
EPI NBRFIFO	None	NBRFIFO Level (configurable)

#### 8.2.4.1 Single Request

When a single request is detected, and not a burst request, the  $\mu$ DMA controller transfers one item and then stops to wait for another request.

#### 8.2.4.2 Burst Request

When a burst request is detected, the  $\mu$ DMA controller transfers the number of items that is the lesser of the arbitration size or the number of items remaining in the transfer. Therefore, the arbitration size should be the same as the number of data items that the peripheral can accommodate when making a burst request. For example, the UART generates a burst request based on the FIFO trigger level. In this case, the arbitration size should be set to the amount of data that the FIFO can transfer when the trigger level is reached. A burst transfer runs to completion once it is started, and cannot be interrupted, even by a higher priority channel. Burst transfers complete in a shorter time than the same number of non-burst transfers.

It may be desirable to use only burst transfers and not allow single transfers. For example, perhaps the nature of the data is such that it only makes sense when transferred together as a single unit rather than one piece at a time. The single request can be disabled by using the **DMA Channel Useburst Set (DMAUSEBURSTSET)** register. By setting the bit for a channel in this register, the  $\mu$ DMA controller only responds to burst requests for that channel.

### 8.2.5 Channel Configuration

The  $\mu$ DMA controller uses an area of system memory to store a set of channel control structures in a table. The control table may have one or two entries for each  $\mu$ DMA channel. Each entry in the table structure contains source and destination pointers, transfer size, and transfer mode. The control table can be located anywhere in system memory, but it must be contiguous and aligned on a 1024-byte boundary.

Table 8-3 on page 251 shows the layout in memory of the channel control table. Each channel may have one or two control structures in the control table: a primary control structure and an optional

alternate control structure. The table is organized so that all of the primary entries are in the first half of the table, and all the alternate structures are in the second half of the table. The primary entry is used for simple transfer modes where transfers can be reconfigured and restarted after each transfer is complete. In this case, the alternate control structures are not used and therefore only the first half of the table must be allocated in memory; the second half of the control table is not necessary, and that memory can be used for something else. If a more complex transfer mode is used such as ping-pong or scatter-gather, then the alternate control structure is also used and memory space should be allocated for the entire table.

Any unused memory in the control table may be used by the application. This includes the control structures for any channels that are unused by the application as well as the unused control word for each channel.

**Table 8-3. Control Structure Memory Map**

Offset	Channel
0x0	0, Primary
0x10	1, Primary
...	...
0x1F0	31, Primary
0x200	0, Alternate
0x210	1, Alternate
...	...
0x3F0	31, Alternate

Table 8-4 shows an individual control structure entry in the control table. Each entry is aligned on a 16-byte boundary. The entry contains four long words: the source end pointer, the destination end pointer, the control word, and an unused entry. The end pointers point to the ending address of the transfer and are inclusive. If the source or destination is non-incrementing (as for a peripheral register), then the pointer should point to the transfer address.

**Table 8-4. Channel Control Structure**

Offset	Description
0x000	Source End Pointer
0x004	Destination End Pointer
0x008	Control Word
0x00C	Unused

The control word contains the following fields:

- Source and destination data sizes
- Source and destination address increment size
- Number of transfers before bus arbitration
- Total number of items to transfer
- Useburst flag
- Transfer mode

The control word and each field are described in detail in “ $\mu$ DMA Channel Control Structure” on page 268. The  $\mu$ DMA controller updates the transfer size and transfer mode fields as the transfer is performed. At the end of a transfer, the transfer size indicates 0, and the transfer mode indicates "stopped." Because the control word is modified by the  $\mu$ DMA controller, it must be reconfigured before each new transfer. The source and destination end pointers are not modified, so they can be left unchanged if the source or destination addresses remain the same.

Prior to starting a transfer, a  $\mu$ DMA channel must be enabled by setting the appropriate bit in the **DMA Channel Enable Set (DMAENASET)** register. A channel can be disabled by setting the channel bit in the **DMA Channel Enable Clear (DMAENACLR)** register. At the end of a complete  $\mu$ DMA transfer, the controller automatically disables the channel.

## 8.2.6 Transfer Modes

The  $\mu$ DMA controller supports several transfer modes. Two of the modes support simple one-time transfers. Several complex modes support a continuous flow of data.

### 8.2.6.1 Stop Mode

While Stop is not actually a transfer mode, it is a valid value for the mode field of the control word. When the mode field has this value, the  $\mu$ DMA controller does not perform any transfers and disables the channel if it is enabled. At the end of a transfer, the  $\mu$ DMA controller updates the control word to set the mode to Stop.

### 8.2.6.2 Basic Mode

In Basic mode, the  $\mu$ DMA controller performs transfers as long as there are more items to transfer, and a transfer request is present. This mode is used with peripherals that assert a  $\mu$ DMA request signal whenever the peripheral is ready for a data transfer. Basic mode should not be used in any situation where the request is momentary even though the entire transfer should be completed. For example, a software-initiated transfer creates a momentary request, and in Basic mode, only the number of transfers specified by the `ARBSIZE` field in the **DMA Channel Control Word (DMACHCTL)** register is transferred on a software request, even if there is more data to transfer.

When all of the items have been transferred using Basic mode, the  $\mu$ DMA controller sets the mode for that channel to Stop.

### 8.2.6.3 Auto Mode

Auto mode is similar to Basic mode, except that once a transfer request is received, the transfer runs to completion, even if the  $\mu$ DMA request is removed. This mode is suitable for software-triggered transfers. Generally, Auto mode is not used with a peripheral.

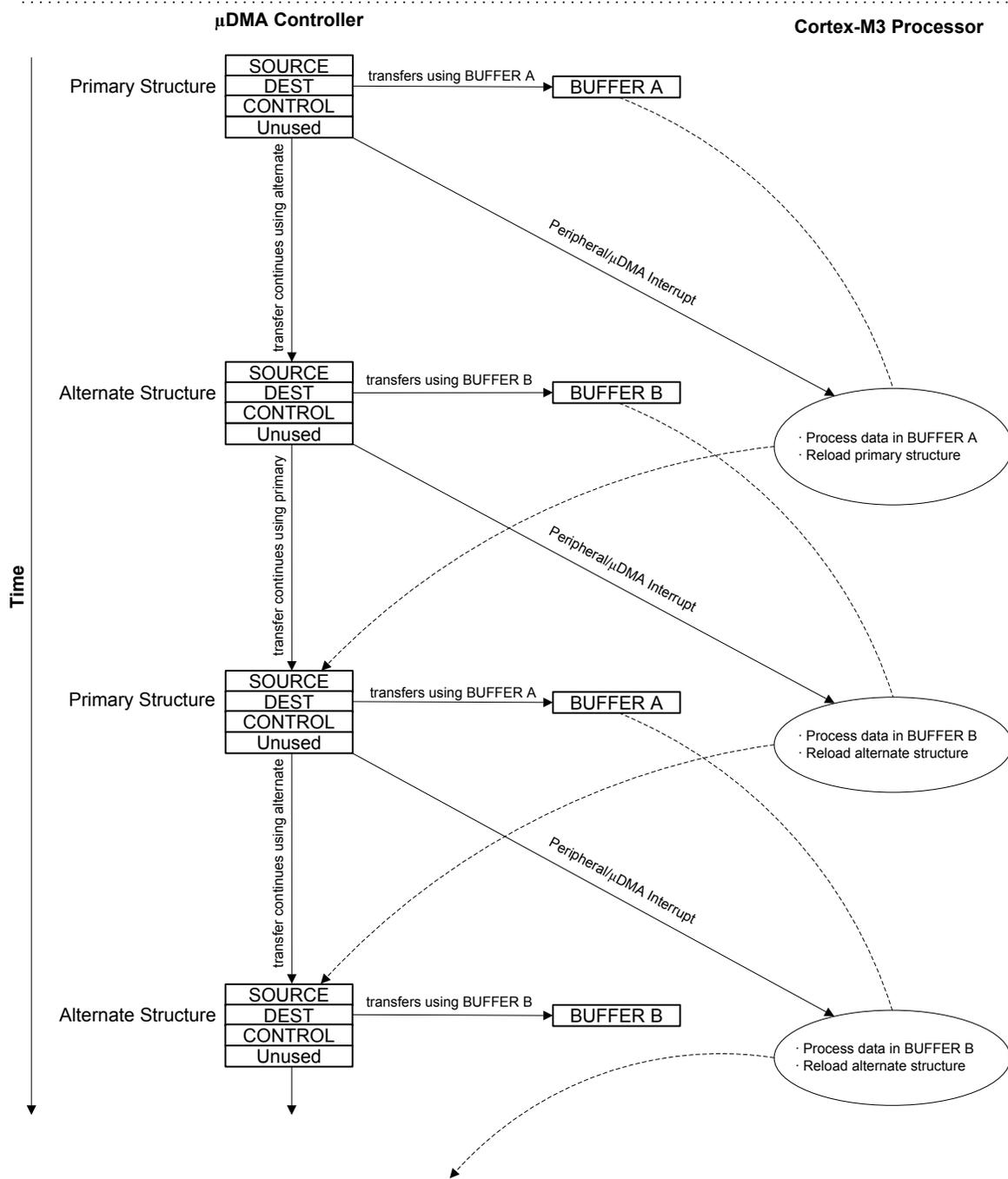
When all the items have been transferred using Auto mode, the  $\mu$ DMA controller sets the mode for that channel to Stop.

### 8.2.6.4 Ping-Pong

Ping-Pong mode is used to support a continuous data flow to or from a peripheral. To use Ping-Pong mode, both the primary and alternate data structures must be implemented. Both structures are set up by the processor for data transfer between memory and a peripheral. The transfer is started using the primary control structure. When the transfer using the primary control structure is complete, the  $\mu$ DMA controller reads the alternate control structure for that channel to continue the transfer. Each time this happens, an interrupt is generated, and the processor can reload the control structure for the just-completed transfer. Data flow can continue indefinitely this way, using the primary and alternate control structures to switch back and forth between buffers as the data flows to or from the peripheral.

Refer to Figure 8-2 for an example showing operation in Ping-Pong mode.

Figure 8-2. Example of Ping-Pong  $\mu$ DMA Transaction



### 8.2.6.5 Memory Scatter-Gather

Memory Scatter-Gather mode is a complex mode used when data must be transferred to or from varied locations in memory instead of a set of contiguous locations in a memory buffer. For example,

a gather  $\mu$ DMA operation could be used to selectively read the payload of several stored packets of a communication protocol and store them together in sequence in a memory buffer.

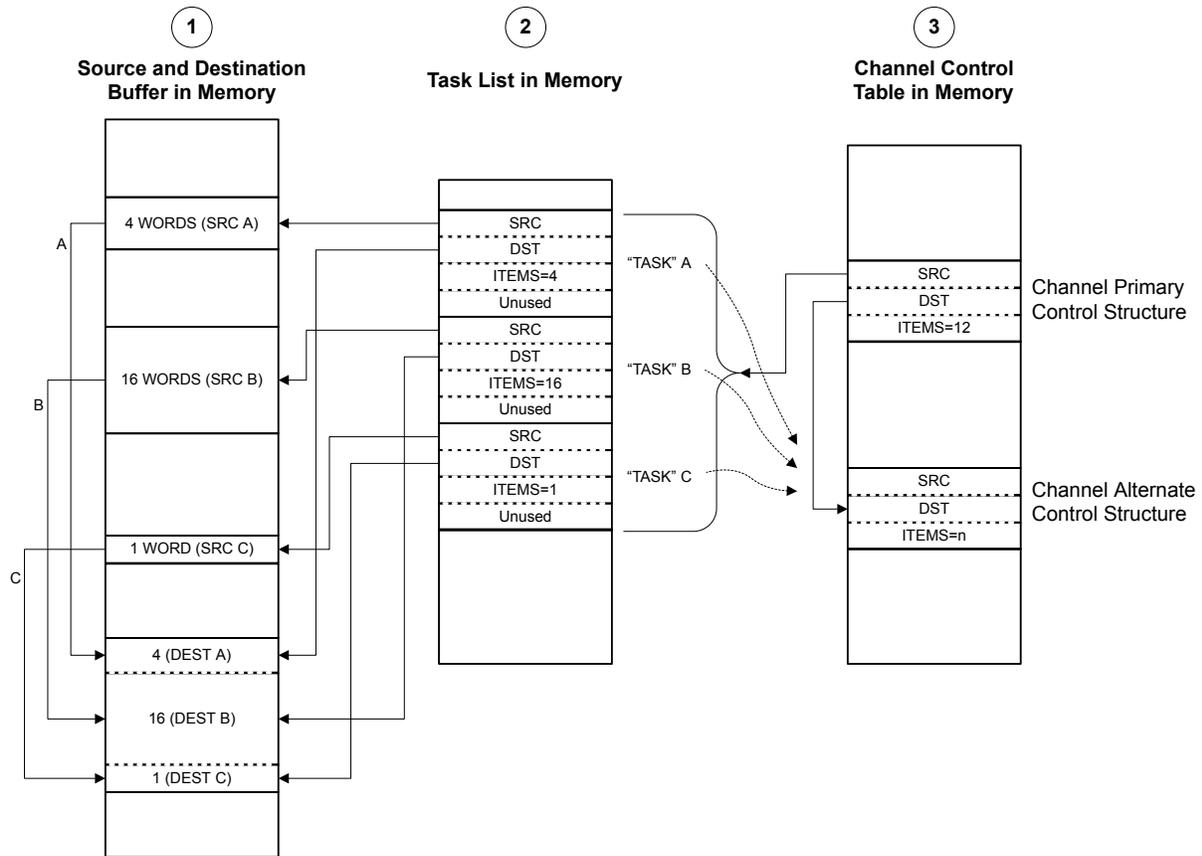
In Memory Scatter-Gather mode, the primary control structure is used to program the alternate control structure from a table in memory. The table is set up by the processor software and contains a list of control structures, each containing the source and destination end pointers, and the control word for a specific transfer. The mode of each control word must be set to Scatter-Gather mode. Each entry in the table is copied in turn to the alternate structure where it is then executed. The  $\mu$ DMA controller alternates between using the primary control structure to copy the next transfer instruction from the list and then executing the new transfer instruction. The end of the list is marked by programming the control word for the last entry to use Basic transfer mode. Once the last transfer is performed using Basic mode, the  $\mu$ DMA controller stops. A completion interrupt is generated only after the last transfer. It is possible to loop the list by having the last entry copy the primary control structure to point back to the beginning of the list (or to a new list). It is also possible to trigger a set of other channels to perform a transfer, either directly, by programming a write to the software trigger for another channel, or indirectly, by causing a peripheral action that results in a  $\mu$ DMA request.

By programming the  $\mu$ DMA controller using this method, a set of arbitrary transfers can be performed based on a single  $\mu$ DMA request.

Refer to Figure 8-3 on page 255 and Figure 8-4 on page 256, which show an example of operation in Memory Scatter-Gather mode. This example shows a *gather* operation, where data in three separate buffers in memory is copied together into one buffer. Figure 8-3 on page 255 shows how the application sets up a  $\mu$ DMA task list in memory that is used by the controller to perform three sets of copy operations from different locations in memory. The primary control structure for the channel that is used for the operation is configured to copy from the task list to the alternate control structure.

Figure 8-4 on page 256 shows the sequence as the  $\mu$ DMA controller performs the three sets of copy operations. First, using the primary control structure, the  $\mu$ DMA controller loads the alternate control structure with task A. It then performs the copy operation specified by task A, copying the data from the source buffer A to the destination buffer. Next, the  $\mu$ DMA controller again uses the primary control structure to load task B into the alternate control structure, and then performs the B operation with the alternate control structure. The process is repeated for task C.

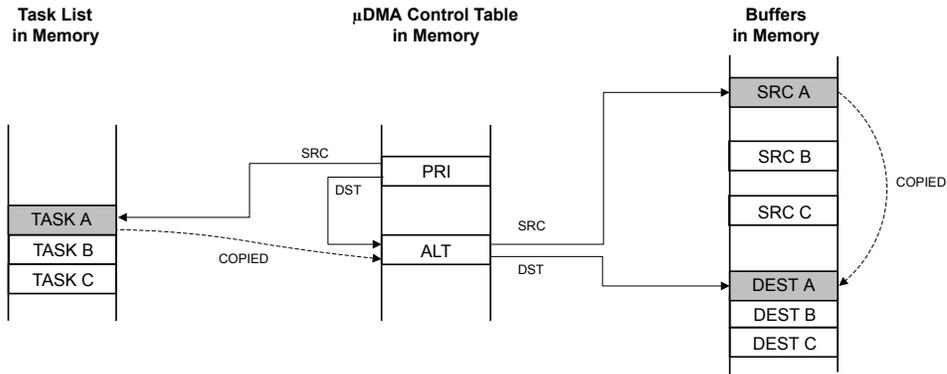
Figure 8-3. Memory Scatter-Gather, Setup and Configuration



## NOTES:

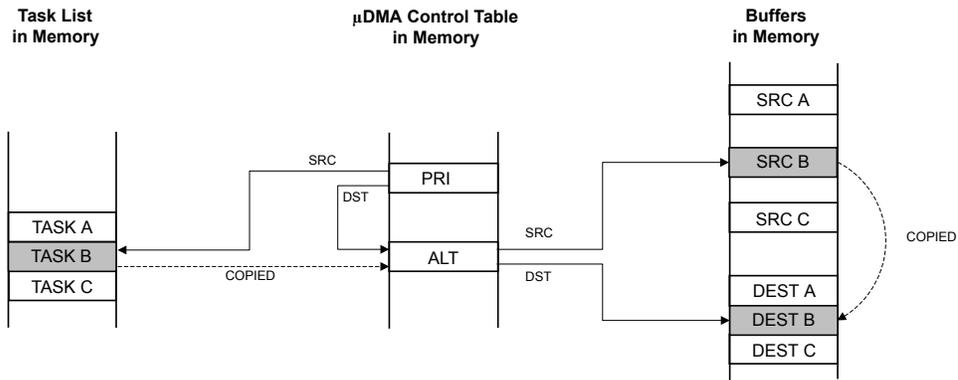
1. Application has a need to copy data items from three separate locations in memory into one combined buffer.
2. Application sets up  $\mu$ DMA "task list" in memory, which contains the pointers and control configuration for three  $\mu$ DMA copy "tasks."
3. Application sets up the channel primary control structure to copy each task configuration, one at a time, to the alternate control structure, where it is executed by the  $\mu$ DMA controller.

Figure 8-4. Memory Scatter-Gather,  $\mu$ DMA Copy Sequence



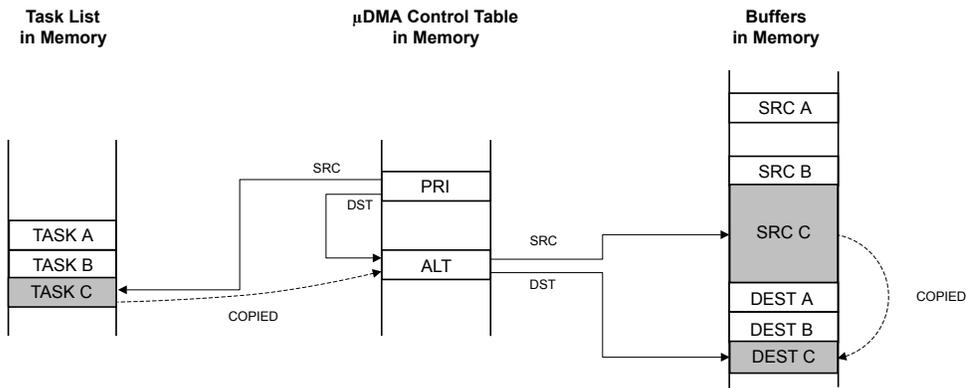
Using the channel's primary control structure, the  $\mu$ DMA controller copies task A configuration to the channel's alternate control structure.

Then, using the channel's alternate control structure, the  $\mu$ DMA controller copies data from the source buffer A to the destination buffer.



Using the channel's primary control structure, the  $\mu$ DMA controller copies task B configuration to the channel's alternate control structure.

Then, using the channel's alternate control structure, the  $\mu$ DMA controller copies data from the source buffer B to the destination buffer.



Using the channel's primary control structure, the  $\mu$ DMA controller copies task C configuration to the channel's alternate control structure.

Then, using the channel's alternate control structure, the  $\mu$ DMA controller copies data from the source buffer C to the destination buffer.



### 8.2.6.6 Peripheral Scatter-Gather

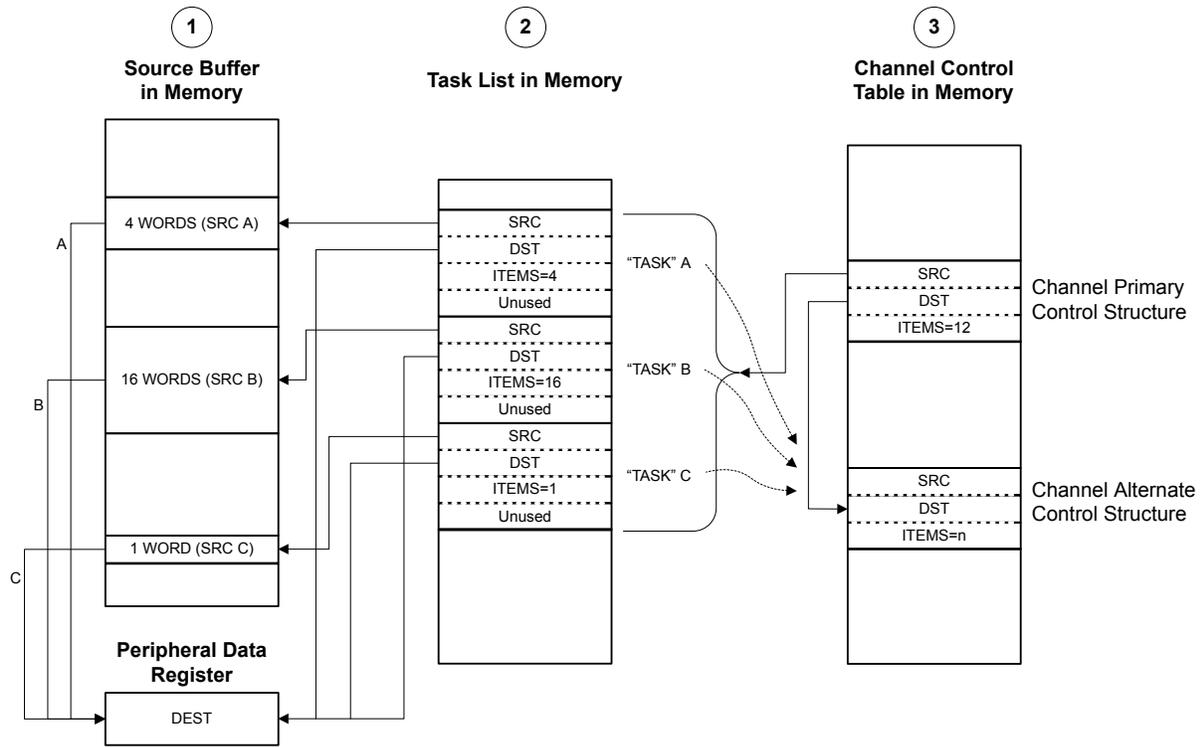
Peripheral Scatter-Gather mode is very similar to Memory Scatter-Gather, except that the transfers are controlled by a peripheral making a  $\mu$ DMA request. Upon detecting a request from the peripheral, the  $\mu$ DMA controller uses the primary control structure to copy one entry from the list to the alternate control structure and then performs the transfer. At the end of this transfer, the next transfer is started only if the peripheral again asserts a  $\mu$ DMA request. The  $\mu$ DMA controller continues to perform transfers from the list only when the peripheral is making a request, until the last transfer is complete. A completion interrupt is generated only after the last transfer.

By using this method, the  $\mu$ DMA controller can transfer data to or from a peripheral from a set of arbitrary locations whenever the peripheral is ready to transfer data.

Refer to Figure 8-5 on page 258 and Figure 8-6 on page 259, which show an example of operation in Peripheral Scatter-Gather mode. This example shows a gather operation, where data from three separate buffers in memory is copied to a single peripheral data register. Figure 8-5 on page 258 shows how the application sets up a  $\mu$ DMA task list in memory that is used by the controller to perform three sets of copy operations from different locations in memory. The primary control structure for the channel that is used for the operation is configured to copy from the task list to the alternate control structure.

Figure 8-6 on page 259 shows the sequence as the  $\mu$ DMA controller performs the three sets of copy operations. First, using the primary control structure, the  $\mu$ DMA controller loads the alternate control structure with task A. It then performs the copy operation specified by task A, copying the data from the source buffer A to the peripheral data register. Next, the  $\mu$ DMA controller again uses the primary control structure to load task B into the alternate control structure, and then performs the B operation with the alternate control structure. The process is repeated for task C.

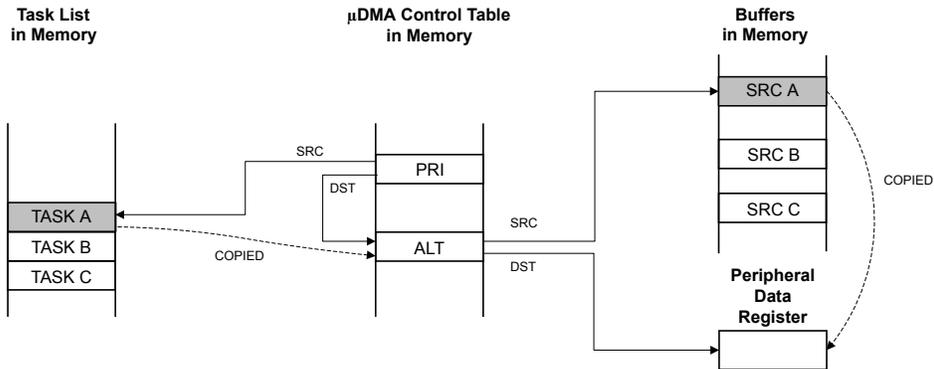
Figure 8-5. Peripheral Scatter-Gather, Setup and Configuration



NOTES:

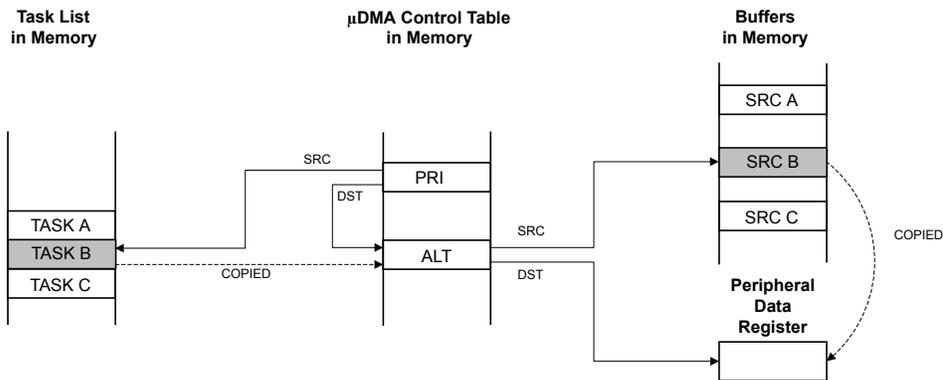
1. Application has a need to copy data items from three separate locations in memory into a peripheral data register.
2. Application sets up  $\mu$ DMA "task list" in memory, which contains the pointers and control configuration for three  $\mu$ DMA copy "tasks."
3. Application sets up the channel primary control structure to copy each task configuration, one at a time, to the alternate control structure, where it is executed by the  $\mu$ DMA controller.

Figure 8-6. Peripheral Scatter-Gather,  $\mu$ DMA Copy Sequence



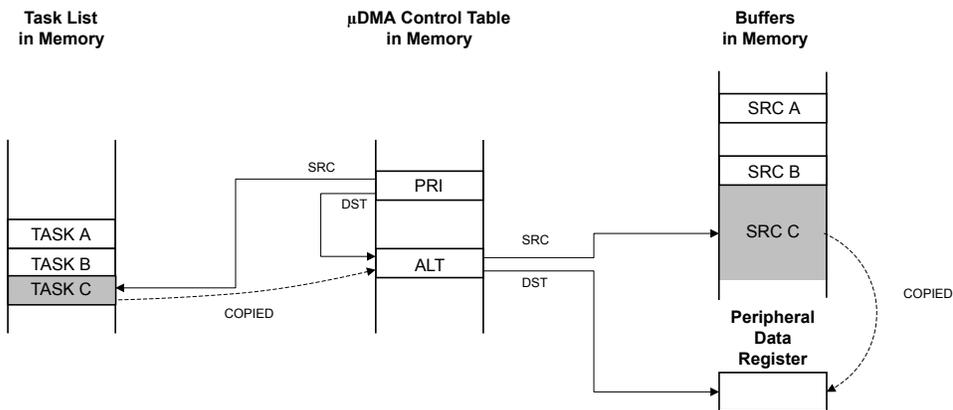
Using the channel's primary control structure, the  $\mu$ DMA controller copies task A configuration to the channel's alternate control structure.

Then, using the channel's alternate control structure, the  $\mu$ DMA controller copies data from the source buffer A to the peripheral data register.



Using the channel's primary control structure, the  $\mu$ DMA controller copies task B configuration to the channel's alternate control structure.

Then, using the channel's alternate control structure, the  $\mu$ DMA controller copies data from the source buffer B to the peripheral data register.



Using the channel's primary control structure, the  $\mu$ DMA controller copies task C configuration to the channel's alternate control structure.

Then, using the channel's alternate control structure, the  $\mu$ DMA controller copies data from the source buffer C to the peripheral data register.

## 8.2.7 Transfer Size and Increment

The  $\mu$ DMA controller supports transfer data sizes of 8, 16, or 32 bits. The source and destination data size must be the same for any given transfer. The source and destination address can be auto-incremented by bytes, half-words, or words, or can be set to no increment. The source and destination address increment values can be set independently, and it is not necessary for the address increment to match the data size as long as the increment is the same or larger than the data size. For example, it is possible to perform a transfer using 8-bit data size, but using an address increment of full words (4 bytes). The data to be transferred must be aligned in memory according to the data size (8, 16, or 32 bits).

Table 8-5 shows the configuration to read from a peripheral that supplies 8-bit data.

**Table 8-5.  $\mu$ DMA Read Example: 8-Bit Peripheral**

Field	Configuration
Source data size	8 bits
Destination data size	8 bits
Source address increment	No increment
Destination address increment	Byte
Source end pointer	Peripheral read FIFO register
Destination end pointer	End of the data buffer in memory

## 8.2.8 Peripheral Interface

Each peripheral that supports  $\mu$ DMA has a single request and/or burst request signal that is asserted when the peripheral is ready to transfer data (see Table 8-2 on page 250). The request signal can be disabled or enabled using the **DMA Channel Request Mask Set (DMAREQMASKSET)** and **DMA Channel Request Mask Clear (DMAREQMASKCLR)** registers. The  $\mu$ DMA request signal is disabled, or masked, when the channel request mask bit is set. When the request is not masked, the  $\mu$ DMA channel is configured correctly and enabled, and the peripheral asserts the request signal, the  $\mu$ DMA controller begins the transfer.

When a  $\mu$ DMA transfer is complete, the  $\mu$ DMA controller generates an interrupt, see “Interrupts and Errors” on page 261 for more information.

For more information on how a specific peripheral interacts with the  $\mu$ DMA controller, refer to the DMA Operation section in the chapter that discusses that peripheral.

## 8.2.9 Software Request

One  $\mu$ DMA channel is dedicated to software-initiated transfers. This channel also has a dedicated interrupt to signal completion of a  $\mu$ DMA transfer. A transfer is initiated by software by first configuring and enabling the transfer, and then issuing a software request using the **DMA Channel Software Request (DMASWREQ)** register. For software-based transfers, the Auto transfer mode should be used.

It is possible to initiate a transfer on any channel using the **DMASWREQ** register. If a request is initiated by software using a peripheral  $\mu$ DMA channel, then the completion interrupt occurs on the interrupt vector for the peripheral instead of the software interrupt vector. Any channel may be used for software requests as long as the corresponding peripheral is not using  $\mu$ DMA for data transfer.

## 8.2.10 Interrupts and Errors

When a  $\mu$ DMA transfer is complete, the  $\mu$ DMA controller generates a completion interrupt on the interrupt vector of the peripheral. Therefore, if  $\mu$ DMA is used to transfer data for a peripheral and interrupts are used, then the interrupt handler for that peripheral must be designed to handle the  $\mu$ DMA transfer completion interrupt. If the transfer uses the software  $\mu$ DMA channel, then the completion interrupt occurs on the dedicated software  $\mu$ DMA interrupt vector (see Table 8-6).

When  $\mu$ DMA is enabled for a peripheral, the  $\mu$ DMA controller stops the normal transfer interrupts for a peripheral from reaching the interrupt controller (the interrupts are still reported in the peripheral's interrupt registers). Thus, when a large amount of data is transferred using  $\mu$ DMA, instead of receiving multiple interrupts from the peripheral as data flows, the interrupt controller receives only one interrupt when the transfer is complete. Unmasked peripheral error interrupts continue to be sent to the interrupt controller.

If the  $\mu$ DMA controller encounters a bus or memory protection error as it attempts to perform a data transfer, it disables the  $\mu$ DMA channel that caused the error and generates an interrupt on the  $\mu$ DMA error interrupt vector. The processor can read the **DMA Bus Error Clear (DMAERRCLR)** register to determine if an error is pending. The `ERRCLR` bit is set if an error occurred. The error can be cleared by writing a 1 to the `ERRCLR` bit.

Table 8-6 shows the dedicated interrupt assignments for the  $\mu$ DMA controller.

**Table 8-6.  $\mu$ DMA Interrupt Assignments**

Interrupt	Assignment
46	$\mu$ DMA Software Channel Transfer
47	$\mu$ DMA Error

## 8.3 Initialization and Configuration

### 8.3.1 Module Initialization

Before the  $\mu$ DMA controller can be used, it must be enabled in the System Control block and in the peripheral. The location of the channel control structure must also be programmed.

The following steps should be performed one time during system initialization:

1. The  $\mu$ DMA peripheral must be enabled in the System Control block. To do this, set the `UDMA` bit of the System Control **RCGC2** register (see page 193).
2. Enable the  $\mu$ DMA controller by setting the `MASTEREN` bit of the **DMA Configuration (DMACFG)** register.
3. Program the location of the channel control table by writing the base address of the table to the **DMA Channel Control Base Pointer (DMACTLBASE)** register. The base address must be aligned on a 1024-byte boundary.

### 8.3.2 Configuring a Memory-to-Memory Transfer

$\mu$ DMA channel 30 is dedicated for software-initiated transfers. However, any channel can be used for software-initiated, memory-to-memory transfer if the associated peripheral is not being used.

#### 8.3.2.1 Configure the Channel Attributes

First, configure the channel attributes:

1. Program bit 30 of the **DMA Channel Priority Set (DMAPRIOSET)** or **DMA Channel Priority Clear (DMAPRIOCLR)** registers to set the channel to High priority or Default priority.
2. Set bit 30 of the **DMA Channel Primary Alternate Clear (DMAALTCLR)** register to select the primary channel control structure for this transfer.
3. Set bit 30 of the **DMA Channel Useburst Clear (DMAUSEBURSTCLR)** register to allow the  $\mu$ DMA controller to respond to single and burst requests.
4. Set bit 30 of the **DMA Channel Request Mask Clear (DMAREQMASKCLR)** register to allow the  $\mu$ DMA controller to recognize requests for this channel.

### 8.3.2.2 Configure the Channel Control Structure

Now the channel control structure must be configured.

This example transfers 256 words from one memory buffer to another. Channel 30 is used for a software transfer, and the control structure for channel 30 is at offset 0x1E0 of the channel control table. The channel control structure for channel 30 is located at the offsets shown in Table 8-7.

**Table 8-7. Channel Control Structure Offsets for Channel 30**

Offset	Description
Control Table Base + 0x1E0	Channel 30 Source End Pointer
Control Table Base + 0x1E4	Channel 30 Destination End Pointer
Control Table Base + 0x1E8	Channel 30 Control Word

#### **Configure the Source and Destination**

The source and destination end pointers must be set to the last address for the transfer (inclusive).

1. Program the source end pointer at offset 0x1E0 to the address of the source buffer + 0x3FC.
2. Program the destination end pointer at offset 0x1E4 to the address of the destination buffer + 0x3FC.

The control word at offset 0x1E8 must be programmed according to Table 8-8.

**Table 8-8. Channel Control Word Configuration for Memory Transfer Example**

Field in DMACHCTL	Bits	Value	Description
DSTINC	31:30	2	32-bit destination address increment
DSTSIZE	29:28	2	32-bit destination data size
SRCINC	27:26	2	32-bit source address increment
SRCSIZE	25:24	2	32-bit source data size
reserved	23:18	0	Reserved
ARBSIZE	17:14	3	Arbitrates after 8 transfers
XFERSIZE	13:4	255	Transfer 256 items
NXTUSEBURST	3	0	N/A for this transfer type
XFERMODE	2:0	2	Use Auto-request transfer mode

### 8.3.2.3 Start the Transfer

Now the channel is configured and is ready to start.

1. Enable the channel by setting bit 30 of the **DMA Channel Enable Set (DMAENASET)** register.
2. Issue a transfer request by setting bit 30 of the **DMA Channel Software Request (DMASWREQ)** register.

The  $\mu$ DMA transfer begins. If the interrupt is enabled, then the processor is notified by interrupt when the transfer is complete. If needed, the status can be checked by reading bit 30 of the **DMAENASET** register. This bit is automatically cleared when the transfer is complete. The status can also be checked by reading the `XFERMODE` field of the channel control word at offset 0x1E8. This field is automatically cleared at the end of the transfer.

### 8.3.3 Configuring a Peripheral for Simple Transmit

This example configures the  $\mu$ DMA controller to transmit a buffer of data to a peripheral. The peripheral has a transmit FIFO with a trigger level of 4. The example peripheral uses  $\mu$ DMA channel 7.

#### 8.3.3.1 Configure the Channel Attributes

First, configure the channel attributes:

1. Configure bit 7 of the **DMA Channel Priority Set (DMAPRIOSET)** or **DMA Channel Priority Clear (DMAPRIOCLR)** registers to set the channel to High priority or Default priority.
2. Set bit 7 of the **DMA Channel Primary Alternate Clear (DMAALTCLR)** register to select the primary channel control structure for this transfer.
3. Set bit 7 of the **DMA Channel Useburst Clear (DMAUSEBURSTCLR)** register to allow the  $\mu$ DMA controller to respond to single and burst requests.
4. Set bit 7 of the **DMA Channel Request Mask Clear (DMAREQMASKCLR)** register to allow the  $\mu$ DMA controller to recognize requests for this channel.

#### 8.3.3.2 Configure the Channel Control Structure

This example transfers 64 bytes from a memory buffer to the peripheral's transmit FIFO register using  $\mu$ DMA channel 7. The control structure for channel 7 is at offset 0x070 of the channel control table. The channel control structure for channel 7 is located at the offsets shown in Table 8-9.

**Table 8-9. Channel Control Structure Offsets for Channel 7**

Offset	Description
Control Table Base + 0x070	Channel 7 Source End Pointer
Control Table Base + 0x074	Channel 7 Destination End Pointer
Control Table Base + 0x078	Channel 7 Control Word

#### **Configure the Source and Destination**

The source and destination end pointers must be set to the last address for the transfer (inclusive). Because the peripheral pointer does not change, it simply points to the peripheral's data register.

1. Program the source end pointer at offset 0x070 to the address of the source buffer + 0x3F.
2. Program the destination end pointer at offset 0x074 to the address of the peripheral's transmit FIFO register.

The control word at offset 0x078 must be programmed according to Table 8-10.

**Table 8-10. Channel Control Word Configuration for Peripheral Transmit Example**

Field in DMACHCTL	Bits	Value	Description
DSTINC	31:30	3	Destination address does not increment
DSTSIZE	29:28	0	8-bit destination data size
SRCINC	27:26	0	8-bit source address increment
SRCSIZE	25:24	0	8-bit source data size
reserved	23:18	0	Reserved
ARBSIZE	17:14	2	Arbitrates after 4 transfers
XFERSIZE	13:4	63	Transfer 64 items
NXTUSEBURST	3	0	N/A for this transfer type
XFERMODE	2:0	1	Use Basic transfer mode

**Note:** In this example, it is not important if the peripheral makes a single request or a burst request. Because the peripheral has a FIFO that triggers at a level of 4, the arbitration size is set to 4. If the peripheral does make a burst request, then 4 bytes are transferred, which is what the FIFO can accommodate. If the peripheral makes a single request (if there is any space in the FIFO), then one byte is transferred at a time. If it is important to the application that transfers only be made in bursts, then the Channel Useburst `SET[7]` bit should be set in the **DMA Channel Useburst Set (DMAUSEBURSTSET)** register.

### 8.3.3.3 Start the Transfer

Now the channel is configured and is ready to start.

1. Enable the channel by setting bit 7 of the **DMA Channel Enable Set (DMAENASET)** register.

The  $\mu$ DMA controller is now configured for transfer on channel 7. The controller makes transfers to the peripheral whenever the peripheral asserts a  $\mu$ DMA request. The transfers continue until the entire buffer of 64 bytes has been transferred. When that happens, the  $\mu$ DMA controller disables the channel and sets the `XFERMODE` field of the channel control word to 0 (Stopped). The status of the transfer can be checked by reading bit 7 of the **DMA Channel Enable Set (DMAENASET)** register. This bit is automatically cleared when the transfer is complete. The status can also be checked by reading the `XFERMODE` field of the channel control word at offset 0x078. This field is automatically cleared at the end of the transfer.

If peripheral interrupts are enabled, then the peripheral interrupt handler receives an interrupt when the entire transfer is complete.

## 8.3.4 Configuring a Peripheral for Ping-Pong Receive

This example configures the  $\mu$ DMA controller to continuously receive 8-bit data from a peripheral into a pair of 64-byte buffers. The peripheral has a receive FIFO with a trigger level of 8. The example peripheral uses  $\mu$ DMA channel 8.

### 8.3.4.1 Configure the Channel Attributes

First, configure the channel attributes:

1. Configure bit 8 of the **DMA Channel Priority Set (DMAPRIOSET)** or **DMA Channel Priority Clear (DMAPRIOCLR)** registers to set the channel to High priority or Default priority.



2. Set bit 8 of the **DMA Channel Primary Alternate Clear (DMAALTCLR)** register to select the primary channel control structure for this transfer.
3. Set bit 8 of the **DMA Channel Useburst Clear (DMAUSEBURSTCLR)** register to allow the  $\mu$ DMA controller to respond to single and burst requests.
4. Set bit 8 of the **DMA Channel Request Mask Clear (DMAREQMASKCLR)** register to allow the  $\mu$ DMA controller to recognize requests for this channel.

#### 8.3.4.2 Configure the Channel Control Structure

This example transfers bytes from the peripheral's receive FIFO register into two memory buffers of 64 bytes each. As data is received, when one buffer is full, the  $\mu$ DMA controller switches to use the other.

To use Ping-Pong buffering, both primary and alternate channel control structures must be used. The primary control structure for channel 8 is at offset 0x080 of the channel control table, and the alternate channel control structure is at offset 0x280. The channel control structures for channel 8 are located at the offsets shown in Table 8-11.

**Table 8-11. Primary and Alternate Channel Control Structure Offsets for Channel 8**

Offset	Description
Control Table Base + 0x080	Channel 8 Primary Source End Pointer
Control Table Base + 0x084	Channel 8 Primary Destination End Pointer
Control Table Base + 0x088	Channel 8 Primary Control Word
Control Table Base + 0x280	Channel 8 Alternate Source End Pointer
Control Table Base + 0x284	Channel 8 Alternate Destination End Pointer
Control Table Base + 0x288	Channel 8 Alternate Control Word

#### **Configure the Source and Destination**

The source and destination end pointers must be set to the last address for the transfer (inclusive). Because the peripheral pointer does not change, it simply points to the peripheral's data register. Both the primary and alternate sets of pointers must be configured.

1. Program the primary source end pointer at offset 0x080 to the address of the peripheral's receive buffer.
2. Program the primary destination end pointer at offset 0x084 to the address of ping-pong buffer A + 0x3F.
3. Program the alternate source end pointer at offset 0x280 to the address of the peripheral's receive buffer.
4. Program the alternate destination end pointer at offset 0x284 to the address of ping-pong buffer B + 0x3F.

The primary control word at offset 0x088 and the alternate control word at offset 0x288 are initially programmed the same way.

1. Program the primary channel control word at offset 0x088 according to Table 8-12.
2. Program the alternate channel control word at offset 0x288 according to Table 8-12.

**Table 8-12. Channel Control Word Configuration for Peripheral Ping-Pong Receive Example**

Field in DMACHCTL	Bits	Value	Description
DSTINC	31:30	0	8-bit destination address increment
DSTSIZE	29:28	0	8-bit destination data size
SRCINC	27:26	3	Source address does not increment
SRCSIZE	25:24	0	8-bit source data size
reserved	23:18	0	Reserved
ARBSIZE	17:14	3	Arbitrates after 8 transfers
XFERSIZE	13:4	63	Transfer 64 items
NXTUSEBURST	3	0	N/A for this transfer type
XFERMODE	2:0	3	Use Ping-Pong transfer mode

**Note:** In this example, it is not important if the peripheral makes a single request or a burst request. Because the peripheral has a FIFO that triggers at a level of 8, the arbitration size is set to 8. If the peripheral does make a burst request, then 8 bytes are transferred, which is what the FIFO can accommodate. If the peripheral makes a single request (if there is any data in the FIFO), then one byte is transferred at a time. If it is important to the application that transfers only be made in bursts, then the Channel Useburst `SET[8]` bit should be set in the **DMA Channel Useburst Set (DMAUSEBURSTSET)** register.

#### 8.3.4.3 Configure the Peripheral Interrupt

An interrupt handler should be configured when using  $\mu$ DMA Ping-Pong mode, it is best to use an interrupt handler. However, the Ping-Pong mode can be configured without interrupts by polling. The interrupt handler is triggered after each buffer is complete.

1. Configure and enable an interrupt handler for the peripheral.

#### 8.3.4.4 Enable the $\mu$ DMA Channel

Now the channel is configured and is ready to start.

1. Enable the channel by setting bit 8 of the **DMA Channel Enable Set (DMAENASET)** register.

#### 8.3.4.5 Process Interrupts

The  $\mu$ DMA controller is now configured and enabled for transfer on channel 8. When the peripheral asserts the  $\mu$ DMA request signal, the  $\mu$ DMA controller makes transfers into buffer A using the primary channel control structure. When the primary transfer to buffer A is complete, it switches to the alternate channel control structure and makes transfers into buffer B. At the same time, the primary channel control word mode field is configured to indicate Stopped, and an interrupt is

When an interrupt is triggered, the interrupt handler must determine which buffer is complete and process the data or set a flag that the data must be processed by non-interrupt buffer processing code. Then the next buffer transfer must be set up.

In the interrupt handler:

1. Read the primary channel control word at offset 0x088 and check the `XFERMODE` field. If the field is 0, this means buffer A is complete. If buffer A is complete, then:
  - a. Process the newly received data in buffer A or signal the buffer processing code that buffer A has data available.

- b. Reprogram the primary channel control word at offset 0x88 according to Table 8-12 on page 266.
  2. Read the alternate channel control word at offset 0x288 and check the `XFERMODE` field. If the field is 0, this means buffer B is complete. If buffer B is complete, then:
    - a. Process the newly received data in buffer B or signal the buffer processing code that buffer B has data available.
    - b. Reprogram the alternate channel control word at offset 0x288 according to Table 8-12 on page 266.

### 8.3.5 Configuring Channel Assignments

Channel assignments for each  $\mu$ DMA channel can be changed using the **DMACHASGN** register. Each bit represents a  $\mu$ DMA channel. If the bit is set, then the secondary function is used for the channel.

Refer to Table 8-1 on page 248 for channel assignments.

For example, to use SS11 Receive on channel 8 instead of UART0, set bit 8 of the **DMACHASGN** register.

## 8.4 Register Map

Table 8-13 on page 267 lists the  $\mu$ DMA channel control structures and registers. The channel control structure shows the layout of one entry in the channel control table. The channel control table is located in system memory, and the location is determined by the application, that is, the base address is n/a (not applicable). In the table below, the offset for the channel control structures is the offset from the entry in the channel control table. See “Channel Configuration” on page 250 and Table 8-3 on page 251 for a description of how the entries in the channel control table are located in memory. The  $\mu$ DMA register addresses are given as a hexadecimal increment, relative to the  $\mu$ DMA base address of 0x400F.F000. Note that the  $\mu$ DMA module clock must be enabled before the registers can be programmed (see page 193).

**Table 8-13.  $\mu$ DMA Register Map**

Offset	Name	Type	Reset	Description	See page
<b><math>\mu</math>DMA Channel Control Structure (Offset from Channel Control Table Base)</b>					
0x000	DMASRCENDP	R/W	-	DMA Channel Source Address End Pointer	269
0x004	DMADSTENDP	R/W	-	DMA Channel Destination Address End Pointer	270
0x008	DMACHCTL	R/W	-	DMA Channel Control Word	271
<b><math>\mu</math>DMA Registers (Offset from <math>\mu</math>DMA Base Address)</b>					
0x000	DMASTAT	RO	0x001F.0000	DMA Status	276
0x004	DMACFG	WO	-	DMA Configuration	278
0x008	DMACTLBASE	R/W	0x0000.0000	DMA Channel Control Base Pointer	279
0x00C	DMAALTBASE	RO	0x0000.0200	DMA Alternate Channel Control Base Pointer	280
0x010	DMAWAITSTAT	RO	0x0000.0000	DMA Channel Wait-on-Request Status	281

Table 8-13.  $\mu$ DMA Register Map (continued)

Offset	Name	Type	Reset	Description	See page
0x014	DMASWREQ	WO	-	DMA Channel Software Request	282
0x018	DMAUSEBURSTSET	R/W	0x0000.0000	DMA Channel Useburst Set	283
0x01C	DMAUSEBURSTCLR	WO	-	DMA Channel Useburst Clear	284
0x020	DMAREQMASKSET	R/W	0x0000.0000	DMA Channel Request Mask Set	285
0x024	DMAREQMASKCLR	WO	-	DMA Channel Request Mask Clear	286
0x028	DMAENASET	R/W	0x0000.0000	DMA Channel Enable Set	287
0x02C	DMAENACLAR	WO	-	DMA Channel Enable Clear	288
0x030	DMAALTSET	R/W	0x0000.0000	DMA Channel Primary Alternate Set	289
0x034	DMAALTCLR	WO	-	DMA Channel Primary Alternate Clear	290
0x038	DMAPRIOSET	R/W	0x0000.0000	DMA Channel Priority Set	291
0x03C	DMAPRIOCLR	WO	-	DMA Channel Priority Clear	292
0x04C	DMAERRCLR	R/W	0x0000.0000	DMA Bus Error Clear	293
0x500	DMACHASGN	R/W	0x0000.0000	DMA Channel Assignment	294
0xFD0	DMAPeriphID4	RO	0x0000.0004	DMA Peripheral Identification 4	299
0xFE0	DMAPeriphID0	RO	0x0000.0030	DMA Peripheral Identification 0	295
0xFE4	DMAPeriphID1	RO	0x0000.00B2	DMA Peripheral Identification 1	296
0xFE8	DMAPeriphID2	RO	0x0000.000B	DMA Peripheral Identification 2	297
0xFEC	DMAPeriphID3	RO	0x0000.0000	DMA Peripheral Identification 3	298
0xFF0	DMAPrimeCellID0	RO	0x0000.000D	DMA PrimeCell Identification 0	300
0xFF4	DMAPrimeCellID1	RO	0x0000.00F0	DMA PrimeCell Identification 1	301
0xFF8	DMAPrimeCellID2	RO	0x0000.0005	DMA PrimeCell Identification 2	302
0xFFC	DMAPrimeCellID3	RO	0x0000.00B1	DMA PrimeCell Identification 3	303

## 8.5 $\mu$ DMA Channel Control Structure

The  $\mu$ DMA Channel Control Structure holds the transfer settings for a  $\mu$ DMA channel. Each channel has two control structures, which are located in a table in system memory. Refer to “Channel Configuration” on page 250 for an explanation of the Channel Control Table and the Channel Control Structure.

The channel control structure is one entry in the channel control table. Each channel has a primary and alternate structure. The primary control structures are located at offsets 0x0, 0x10, 0x20 and so on. The alternate control structures are located at offsets 0x200, 0x210, 0x220, and so on.

## Register 1: DMA Channel Source Address End Pointer (DMASRCENDP), offset 0x000

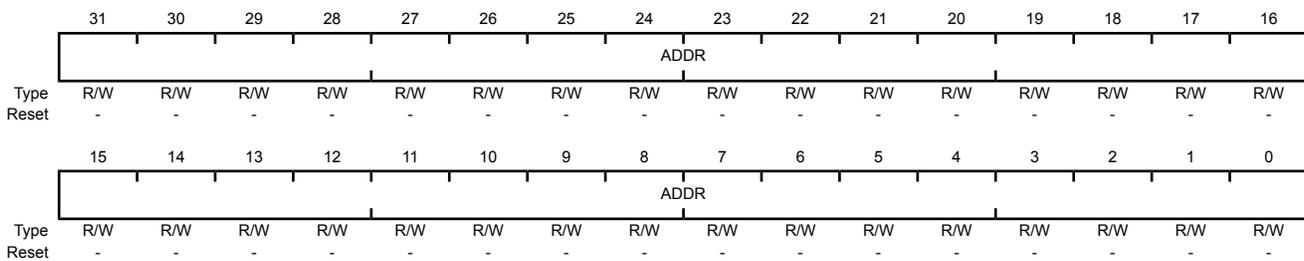
**DMA Channel Source Address End Pointer (DMASRCENDP)** is part of the Channel Control Structure and is used to specify the source address for a  $\mu$ DMA transfer.

The  $\mu$ DMA controller can transfer data to and from the on-chip SRAM. However, because the Flash memory and ROM are located on a separate internal bus, it is not possible to transfer data from the Flash memory or ROM with the  $\mu$ DMA controller.

**Note:** The offset specified is from the base address of the control structure in system memory, not the  $\mu$ DMA module base address.

### DMA Channel Source Address End Pointer (DMASRCENDP)

Base n/a  
Offset 0x000  
Type R/W, reset -



Bit/Field	Name	Type	Reset	Description
31:0	ADDR	R/W	-	Source Address End Pointer  This field points to the last address of the $\mu$ DMA transfer source (inclusive). If the source address is not incrementing (the <b>SRCINC</b> field in the <b>DMACHCTL</b> register is 0x3), then this field points at the source location itself (such as a peripheral data register).

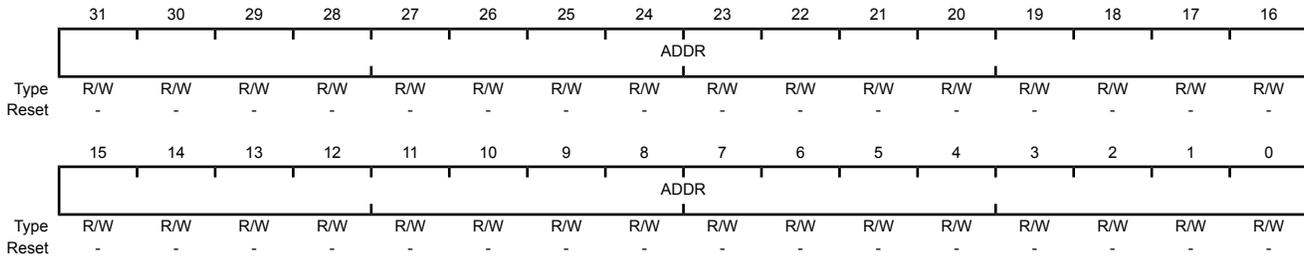
## Register 2: DMA Channel Destination Address End Pointer (DMADSTENDP), offset 0x004

**DMA Channel Destination Address End Pointer (DMADSTENDP)** is part of the Channel Control Structure and is used to specify the destination address for a  $\mu$ DMA transfer.

**Note:** The offset specified is from the base address of the control structure in system memory, not the  $\mu$ DMA module base address.

### DMA Channel Destination Address End Pointer (DMADSTENDP)

Base n/a  
Offset 0x004  
Type R/W, reset -



Bit/Field	Name	Type	Reset	Description
31:0	ADDR	R/W	-	Destination Address End Pointer

This field points to the last address of the  $\mu$ DMA transfer destination (inclusive). If the destination address is not incrementing (the `DSTINC` field in the `DMACHCTL` register is 0x3), then this field points at the destination location itself (such as a peripheral data register).

### Register 3: DMA Channel Control Word (DMACHCTL), offset 0x008

**DMA Channel Control Word (DMACHCTL)** is part of the Channel Control Structure and is used to specify parameters of a  $\mu$ DMA transfer.

**Note:** The offset specified is from the base address of the control structure in system memory, not the  $\mu$ DMA module base address.

#### DMA Channel Control Word (DMACHCTL)

Base n/a  
Offset 0x008  
Type R/W, reset -

	31	30	29	28	27	26	25	24	23	22	21	20	19	18	17	16
	DSTINC		DSTSIZE		SRCINC		SRCSIZE		reserved						ARBSIZE	
Type	R/W	R/W	R/W	R/W	R/W	R/W	R/W	R/W	R/W	R/W	R/W	R/W	R/W	R/W	R/W	R/W
Reset	-	-	-	-	-	-	-	-	-	-	-	-	-	-	-	-
	15	14	13	12	11	10	9	8	7	6	5	4	3	2	1	0
	ARBSIZE		XFERSIZE										NXTUSEBURST	XFERMODE		
Type	R/W	R/W	R/W	R/W	R/W	R/W	R/W	R/W	R/W	R/W	R/W	R/W	R/W	R/W	R/W	R/W
Reset	-	-	-	-	-	-	-	-	-	-	-	-	-	-	-	-

Bit/Field	Name	Type	Reset	Description										
31:30	DSTINC	R/W	-	<p>Destination Address Increment</p> <p>This field configures the destination address increment.</p> <p>The address increment value must be equal or greater than the value of the destination size (DSTSIZE).</p> <table border="1"> <thead> <tr> <th>Value</th> <th>Description</th> </tr> </thead> <tbody> <tr> <td>0x0</td> <td>Byte Increment by 8-bit locations</td> </tr> <tr> <td>0x1</td> <td>Half-word Increment by 16-bit locations</td> </tr> <tr> <td>0x2</td> <td>Word Increment by 32-bit locations</td> </tr> <tr> <td>0x3</td> <td>No increment Address remains set to the value of the Destination Address End Pointer (DMADSTENDP) for the channel</td> </tr> </tbody> </table>	Value	Description	0x0	Byte Increment by 8-bit locations	0x1	Half-word Increment by 16-bit locations	0x2	Word Increment by 32-bit locations	0x3	No increment Address remains set to the value of the Destination Address End Pointer (DMADSTENDP) for the channel
Value	Description													
0x0	Byte Increment by 8-bit locations													
0x1	Half-word Increment by 16-bit locations													
0x2	Word Increment by 32-bit locations													
0x3	No increment Address remains set to the value of the Destination Address End Pointer (DMADSTENDP) for the channel													

Bit/Field	Name	Type	Reset	Description										
29:28	DSTSIZE	R/W	-	<p>Destination Data Size</p> <p>This field configures the destination item data size.</p> <p><b>Note:</b> DSTSIZE must be the same as SRCSIZE.</p> <table border="1"> <thead> <tr> <th>Value</th> <th>Description</th> </tr> </thead> <tbody> <tr> <td>0x0</td> <td>Byte 8-bit data size</td> </tr> <tr> <td>0x1</td> <td>Half-word 16-bit data size</td> </tr> <tr> <td>0x2</td> <td>Word 32-bit data size</td> </tr> <tr> <td>0x3</td> <td>Reserved</td> </tr> </tbody> </table>	Value	Description	0x0	Byte 8-bit data size	0x1	Half-word 16-bit data size	0x2	Word 32-bit data size	0x3	Reserved
Value	Description													
0x0	Byte 8-bit data size													
0x1	Half-word 16-bit data size													
0x2	Word 32-bit data size													
0x3	Reserved													
27:26	SRCINC	R/W	-	<p>Source Address Increment</p> <p>This field configures the source address increment.</p> <p>The address increment value must be equal or greater than the value of the source size (SRCSIZE).</p> <table border="1"> <thead> <tr> <th>Value</th> <th>Description</th> </tr> </thead> <tbody> <tr> <td>0x0</td> <td>Byte Increment by 8-bit locations</td> </tr> <tr> <td>0x1</td> <td>Half-word Increment by 16-bit locations</td> </tr> <tr> <td>0x2</td> <td>Word Increment by 32-bit locations</td> </tr> <tr> <td>0x3</td> <td>No increment Address remains set to the value of the Source Address End Pointer (DMASRCENDE) for the channel</td> </tr> </tbody> </table>	Value	Description	0x0	Byte Increment by 8-bit locations	0x1	Half-word Increment by 16-bit locations	0x2	Word Increment by 32-bit locations	0x3	No increment Address remains set to the value of the Source Address End Pointer (DMASRCENDE) for the channel
Value	Description													
0x0	Byte Increment by 8-bit locations													
0x1	Half-word Increment by 16-bit locations													
0x2	Word Increment by 32-bit locations													
0x3	No increment Address remains set to the value of the Source Address End Pointer (DMASRCENDE) for the channel													
25:24	SRCSIZE	R/W	-	<p>Source Data Size</p> <p>This field configures the source item data size.</p> <p><b>Note:</b> DSTSIZE must be the same as SRCSIZE.</p> <table border="1"> <thead> <tr> <th>Value</th> <th>Description</th> </tr> </thead> <tbody> <tr> <td>0x0</td> <td>Byte 8-bit data size.</td> </tr> <tr> <td>0x1</td> <td>Half-word 16-bit data size.</td> </tr> <tr> <td>0x2</td> <td>Word 32-bit data size.</td> </tr> <tr> <td>0x3</td> <td>Reserved</td> </tr> </tbody> </table>	Value	Description	0x0	Byte 8-bit data size.	0x1	Half-word 16-bit data size.	0x2	Word 32-bit data size.	0x3	Reserved
Value	Description													
0x0	Byte 8-bit data size.													
0x1	Half-word 16-bit data size.													
0x2	Word 32-bit data size.													
0x3	Reserved													



Bit/Field	Name	Type	Reset	Description																										
23:18	reserved	R/W	-	Software should not rely on the value of a reserved bit. To provide compatibility with future products, the value of a reserved bit should be preserved across a read-modify-write operation.																										
17:14	ARBSIZE	R/W	-	<p>Arbitration Size</p> <p>This field configures the number of transfers that can occur before the <math>\mu</math>DMA controller re-arbitrates. The possible arbitration rate configurations represent powers of 2 and are shown below.</p> <table border="1"> <thead> <tr> <th>Value</th> <th>Description</th> </tr> </thead> <tbody> <tr> <td>0x0</td> <td>1 Transfer</td> </tr> <tr> <td></td> <td>Arbitrates after each <math>\mu</math>DMA transfer</td> </tr> <tr> <td>0x1</td> <td>2 Transfers</td> </tr> <tr> <td>0x2</td> <td>4 Transfers</td> </tr> <tr> <td>0x3</td> <td>8 Transfers</td> </tr> <tr> <td>0x4</td> <td>16 Transfers</td> </tr> <tr> <td>0x5</td> <td>32 Transfers</td> </tr> <tr> <td>0x6</td> <td>64 Transfers</td> </tr> <tr> <td>0x7</td> <td>128 Transfers</td> </tr> <tr> <td>0x8</td> <td>256 Transfers</td> </tr> <tr> <td>0x9</td> <td>512 Transfers</td> </tr> <tr> <td>0xA-0xF</td> <td>1024 Transfers</td> </tr> </tbody> </table> <p>In this configuration, no arbitration occurs during the <math>\mu</math>DMA transfer because the maximum transfer size is 1024.</p>	Value	Description	0x0	1 Transfer		Arbitrates after each $\mu$ DMA transfer	0x1	2 Transfers	0x2	4 Transfers	0x3	8 Transfers	0x4	16 Transfers	0x5	32 Transfers	0x6	64 Transfers	0x7	128 Transfers	0x8	256 Transfers	0x9	512 Transfers	0xA-0xF	1024 Transfers
Value	Description																													
0x0	1 Transfer																													
	Arbitrates after each $\mu$ DMA transfer																													
0x1	2 Transfers																													
0x2	4 Transfers																													
0x3	8 Transfers																													
0x4	16 Transfers																													
0x5	32 Transfers																													
0x6	64 Transfers																													
0x7	128 Transfers																													
0x8	256 Transfers																													
0x9	512 Transfers																													
0xA-0xF	1024 Transfers																													
13:4	XFERSIZE	R/W	-	<p>Transfer Size (minus 1)</p> <p>This field configures the total number of items to transfer. The value of this field is 1 less than the number to transfer (value 0 means transfer 1 item). The maximum value for this 10-bit field is 1023 which represents a transfer size of 1024 items.</p> <p>The transfer size is the number of items, not the number of bytes. If the data size is 32 bits, then this value is the number of 32-bit words to transfer.</p> <p>The <math>\mu</math>DMA controller updates this field immediately prior to entering the arbitration process, so it contains the number of outstanding items that is necessary to complete the <math>\mu</math>DMA cycle.</p>																										
3	NXTUSEBURST	R/W	-	<p>Next Useburst</p> <p>This field controls whether the Useburst <math>SET[n]</math> bit is automatically set for the last transfer of a peripheral scatter-gather operation. Normally, for the last transfer, if the number of remaining items to transfer is less than the arbitration size, the <math>\mu</math>DMA controller uses single transfers to complete the transaction. If this bit is set, then the controller uses a burst transfer to complete the last transfer.</p>																										

Bit/Field	Name	Type	Reset	Description																		
2:0	XFERMODE	R/W	-	<p><math>\mu</math>DMA Transfer Mode</p> <p>This field configures the operating mode of the <math>\mu</math>DMA cycle. Refer to “Transfer Modes” on page 252 for a detailed explanation of transfer modes.</p> <p>Because this register is in system RAM, it has no reset value. Therefore, this field should be initialized to 0 before the channel is enabled.</p> <table border="1"> <thead> <tr> <th>Value</th> <th>Description</th> </tr> </thead> <tbody> <tr> <td>0x0</td> <td>Stop</td> </tr> <tr> <td>0x1</td> <td>Basic</td> </tr> <tr> <td>0x2</td> <td>Auto-Request</td> </tr> <tr> <td>0x3</td> <td>Ping-Pong</td> </tr> <tr> <td>0x4</td> <td>Memory Scatter-Gather</td> </tr> <tr> <td>0x5</td> <td>Alternate Memory Scatter-Gather</td> </tr> <tr> <td>0x6</td> <td>Peripheral Scatter-Gather</td> </tr> <tr> <td>0x7</td> <td>Alternate Peripheral Scatter-Gather</td> </tr> </tbody> </table>	Value	Description	0x0	Stop	0x1	Basic	0x2	Auto-Request	0x3	Ping-Pong	0x4	Memory Scatter-Gather	0x5	Alternate Memory Scatter-Gather	0x6	Peripheral Scatter-Gather	0x7	Alternate Peripheral Scatter-Gather
Value	Description																					
0x0	Stop																					
0x1	Basic																					
0x2	Auto-Request																					
0x3	Ping-Pong																					
0x4	Memory Scatter-Gather																					
0x5	Alternate Memory Scatter-Gather																					
0x6	Peripheral Scatter-Gather																					
0x7	Alternate Peripheral Scatter-Gather																					

**XFERMODE Bit Field Values.**

**Stop**

Channel is stopped or configuration data is invalid. No more transfers can occur.

**Basic**

For each trigger (whether from a peripheral or a software request), the  $\mu$ DMA controller performs the number of transfers specified by the `ARBSIZE` field.

**Auto-Request**

The initial request (software- or peripheral-initiated) is sufficient to complete the entire transfer of `XFERSIZE` items without any further requests.

**Ping-Pong**

This mode uses both the primary and alternate control structures for this channel. When the number of transfers specified by the `XFERSIZE` field have completed for the current control structure (primary or alternate), the  $\mu$ DMA controller switches to the other one. These switches continue until one of the control structures is not set to ping-pong mode. At that point, the  $\mu$ DMA controller stops. An interrupt is generated on completion of the transfers configured by each control structure. See “Ping-Pong” on page 252.

**Memory Scatter-Gather**

When using this mode, the primary control structure for the channel is configured to allow a list of operations (tasks) to be performed. The source address pointer specifies the start of a table of tasks to be copied to the alternate control structure for this channel. The `XFERMODE` field for the alternate control structure should be configured to 0x5 (Alternate memory scatter-gather) to perform the task. When the task completes, the  $\mu$ DMA switches back to the primary channel control structure, which then copies the next task to the alternate control structure. This process continues until the table of tasks is empty. The last task must have an `XFERMODE` value other than 0x5. Note that for continuous operation, the last task can update the primary channel control structure back to the start of the list or to another list. See “Memory Scatter-Gather” on page 253.

**Alternate Memory Scatter-Gather**

This value must be used in the alternate channel control data structure when the  $\mu$ DMA controller operates in Memory Scatter-Gather mode.

**Peripheral Scatter-Gather**

This value must be used in the primary channel control data structure when the  $\mu$ DMA controller operates in Peripheral Scatter-Gather mode. In this mode, the  $\mu$ DMA controller operates exactly the same as in Memory Scatter-Gather mode, except that instead of performing the number of transfers specified by the `XFERSIZE` field in the alternate control structure at one time, the  $\mu$ DMA controller only performs the number of transfers specified by the `ARBSIZE` field per trigger; see Basic mode for details. See “Peripheral Scatter-Gather” on page 257.

**Alternate Peripheral Scatter-Gather**

This value must be used in the alternate channel control data structure when the  $\mu$ DMA controller operates in Peripheral Scatter-Gather mode.

## 8.6 $\mu$ DMA Register Descriptions

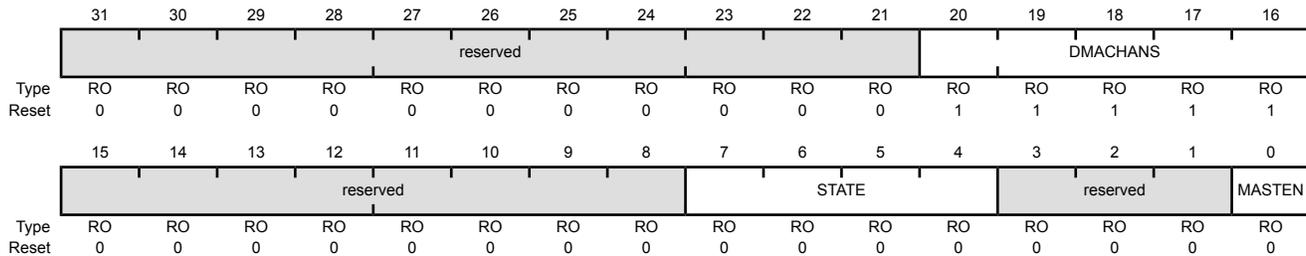
The register addresses given are relative to the  $\mu$ DMA base address of 0x400F.F000.

### Register 4: DMA Status (DMASTAT), offset 0x000

The **DMA Status (DMASTAT)** register returns the status of the  $\mu$ DMA controller. You cannot read this register when the  $\mu$ DMA controller is in the reset state.

#### DMA Status (DMASTAT)

Base 0x400F.F000  
 Offset 0x000  
 Type RO, reset 0x001F.0000



Bit/Field	Name	Type	Reset	Description																								
31:21	reserved	RO	0x000	Software should not rely on the value of a reserved bit. To provide compatibility with future products, the value of a reserved bit should be preserved across a read-modify-write operation.																								
20:16	DMACHANS	RO	0x1F	Available $\mu$ DMA Channels Minus 1  This field contains a value equal to the number of $\mu$ DMA channels the $\mu$ DMA controller is configured to use, minus one. The value of 0x1F corresponds to 32 $\mu$ DMA channels.																								
15:8	reserved	RO	0x00	Software should not rely on the value of a reserved bit. To provide compatibility with future products, the value of a reserved bit should be preserved across a read-modify-write operation.																								
7:4	STATE	RO	0x0	Control State Machine Status  This field shows the current status of the control state machine. Status can be one of the following.  <table border="1"> <thead> <tr> <th>Value</th> <th>Description</th> </tr> </thead> <tbody> <tr><td>0x0</td><td>Idle</td></tr> <tr><td>0x1</td><td>Reading channel controller data.</td></tr> <tr><td>0x2</td><td>Reading source end pointer.</td></tr> <tr><td>0x3</td><td>Reading destination end pointer.</td></tr> <tr><td>0x4</td><td>Reading source data.</td></tr> <tr><td>0x5</td><td>Writing destination data.</td></tr> <tr><td>0x6</td><td>Waiting for <math>\mu</math>DMA request to clear.</td></tr> <tr><td>0x7</td><td>Writing channel controller data.</td></tr> <tr><td>0x8</td><td>Stalled</td></tr> <tr><td>0x9</td><td>Done</td></tr> <tr><td>0xA-0xF</td><td>Undefined</td></tr> </tbody> </table>	Value	Description	0x0	Idle	0x1	Reading channel controller data.	0x2	Reading source end pointer.	0x3	Reading destination end pointer.	0x4	Reading source data.	0x5	Writing destination data.	0x6	Waiting for $\mu$ DMA request to clear.	0x7	Writing channel controller data.	0x8	Stalled	0x9	Done	0xA-0xF	Undefined
Value	Description																											
0x0	Idle																											
0x1	Reading channel controller data.																											
0x2	Reading source end pointer.																											
0x3	Reading destination end pointer.																											
0x4	Reading source data.																											
0x5	Writing destination data.																											
0x6	Waiting for $\mu$ DMA request to clear.																											
0x7	Writing channel controller data.																											
0x8	Stalled																											
0x9	Done																											
0xA-0xF	Undefined																											
3:1	reserved	RO	0x0	Software should not rely on the value of a reserved bit. To provide compatibility with future products, the value of a reserved bit should be preserved across a read-modify-write operation.																								

---

Bit/Field	Name	Type	Reset	Description
0	MASTEN	RO	0	Master Enable Status
				Value Description
				0 The $\mu$ DMA controller is disabled.
				1 The $\mu$ DMA controller is enabled.

## Register 5: DMA Configuration (DMACFG), offset 0x004

The **DMACFG** register controls the configuration of the  $\mu$ DMA controller.

### DMA Configuration (DMACFG)

Base 0x400F.F000

Offset 0x004

Type WO, reset -

	31	30	29	28	27	26	25	24	23	22	21	20	19	18	17	16
	reserved															
Type	WO	WO	WO	WO	WO	WO	WO	WO	WO	WO	WO	WO	WO	WO	WO	WO
Reset	-	-	-	-	-	-	-	-	-	-	-	-	-	-	-	-
	15	14	13	12	11	10	9	8	7	6	5	4	3	2	1	0
	reserved															MASTEN
Type	WO	WO	WO	WO	WO	WO	WO	WO	WO	WO	WO	WO	WO	WO	WO	WO
Reset	-	-	-	-	-	-	-	-	-	-	-	-	-	-	-	-

Bit/Field	Name	Type	Reset	Description
31:1	reserved	WO	-	Software should not rely on the value of a reserved bit. To provide compatibility with future products, the value of a reserved bit should be preserved across a read-modify-write operation.
0	MASTEN	WO	-	Controller Master Enable
				Value Description
				0 Disables the $\mu$ DMA controller.
				1 Enables $\mu$ DMA controller.

**Register 6: DMA Channel Control Base Pointer (DMACTLBASE), offset 0x008**

The **DMACTLBASE** register must be configured so that the base pointer points to a location in system memory.

The amount of system memory that must be assigned to the  $\mu$ DMA controller depends on the number of  $\mu$ DMA channels used and whether the alternate channel control data structure is used. See “Channel Configuration” on page 250 for details about the Channel Control Table. The base address must be aligned on a 1024-byte boundary. This register cannot be read when the  $\mu$ DMA controller is in the reset state.

**DMA Channel Control Base Pointer (DMACTLBASE)**

Base 0x400F.F000

Offset 0x008

Type R/W, reset 0x0000.0000

	31	30	29	28	27	26	25	24	23	22	21	20	19	18	17	16
	ADDR															
Type	R/W	R/W	R/W	R/W	R/W	R/W	R/W	R/W	R/W	R/W	R/W	R/W	R/W	R/W	R/W	R/W
Reset	0	0	0	0	0	0	0	0	0	0	0	0	0	0	0	0
	15	14	13	12	11	10	9	8	7	6	5	4	3	2	1	0
	ADDR						reserved									
Type	R/W	R/W	R/W	R/W	R/W	R/W	RO	RO	RO	RO	RO	RO	RO	RO	RO	RO
Reset	0	0	0	0	0	0	0	0	0	0	0	0	0	0	0	0

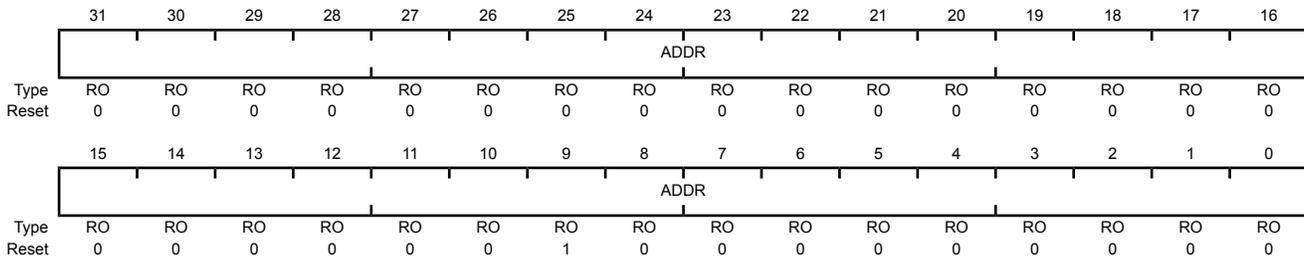
Bit/Field	Name	Type	Reset	Description
31:10	ADDR	R/W	0x0000.00	Channel Control Base Address  This field contains the pointer to the base address of the channel control table. The base address must be 1024-byte aligned.
9:0	reserved	RO	0x00	Software should not rely on the value of a reserved bit. To provide compatibility with future products, the value of a reserved bit should be preserved across a read-modify-write operation.

### Register 7: DMA Alternate Channel Control Base Pointer (DMAALTBASE), offset 0x00C

The **DMAALTBASE** register returns the base address of the alternate channel control data. This register removes the necessity for application software to calculate the base address of the alternate channel control structures. This register cannot be read when the  $\mu$ DMA controller is in the reset state.

#### DMA Alternate Channel Control Base Pointer (DMAALTBASE)

Base 0x400F.F000  
 Offset 0x00C  
 Type RO, reset 0x0000.0200



Bit/Field	Name	Type	Reset	Description
31:0	ADDR	RO	0x0000.0200	Alternate Channel Address Pointer  This field provides the base address of the alternate channel control structures.



## Register 8: DMA Channel Wait-on-Request Status (DMAWAITSTAT), offset 0x010

This read-only register indicates that the  $\mu$ DMA channel is waiting on a request. A peripheral can hold off the  $\mu$ DMA from performing a single request until the peripheral is ready for a burst request to enhance the  $\mu$ DMA performance. The use of this feature is dependent on the design of the peripheral and is not controllable by software in any way. This register cannot be read when the  $\mu$ DMA controller is in the reset state.

### DMA Channel Wait-on-Request Status (DMAWAITSTAT)

Base 0x400F.F000  
Offset 0x010  
Type RO, reset 0x0000.0000

	31	30	29	28	27	26	25	24	23	22	21	20	19	18	17	16
	WAITREQ[n]															
Type	RO	RO	RO	RO	RO	RO	RO	RO	RO	RO	RO	RO	RO	RO	RO	RO
Reset	0	0	0	0	0	0	0	0	0	0	0	0	0	0	0	0
	15	14	13	12	11	10	9	8	7	6	5	4	3	2	1	0
	WAITREQ[n]															
Type	RO	RO	RO	RO	RO	RO	RO	RO	RO	RO	RO	RO	RO	RO	RO	RO
Reset	0	0	0	0	0	0	0	0	0	0	0	0	0	0	0	0

Bit/Field	Name	Type	Reset	Description
-----------	------	------	-------	-------------

31:0	WAITREQ[n]	RO	0x0000.0000	Channel [n] Wait Status
------	------------	----	-------------	-------------------------

These bits provide the channel wait-on-request status. Bit 0 corresponds to channel 0.

Value Description

- |   |  |
|---|--|
| 1 | The corresponding channel is waiting on a request.     |
| 0 | The corresponding channel is not waiting on a request. |

### Register 9: DMA Channel Software Request (DMASWREQ), offset 0x014

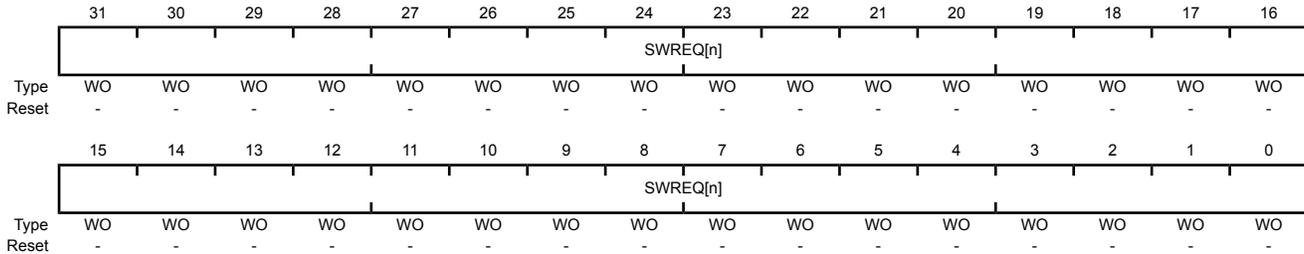
Each bit of the **DMASWREQ** register represents the corresponding  $\mu$ DMA channel. Setting a bit generates a request for the specified  $\mu$ DMA channel.

#### DMA Channel Software Request (DMASWREQ)

Base 0x400F.F000

Offset 0x014

Type WO, reset -



Bit/Field	Name	Type	Reset	Description				
31:0	SWREQ[n]	WO	-	<p>Channel [n] Software Request</p> <p>These bits generate software requests. Bit 0 corresponds to channel 0.</p> <p>Value Description</p> <table border="0"> <tr> <td>1</td> <td>Generate a software request for the corresponding channel.</td> </tr> <tr> <td>0</td> <td>No request generated.</td> </tr> </table> <p>These bits are automatically cleared when the software request has been completed.</p>	1	Generate a software request for the corresponding channel.	0	No request generated.
1	Generate a software request for the corresponding channel.							
0	No request generated.							

**Register 10: DMA Channel Useburst Set (DMAUSEBURSTSET), offset 0x018**

Each bit of the **DMAUSEBURSTSET** register represents the corresponding  $\mu$ DMA channel. Setting a bit disables the channel's single request input from generating requests, configuring the channel to only accept burst requests. Reading the register returns the status of USEBURST.

If the amount of data to transfer is a multiple of the arbitration (burst) size, the corresponding  $SET[n]$  bit is cleared after completing the final transfer. If there are fewer items remaining to transfer than the arbitration (burst) size, the  $\mu$ DMA controller automatically clears the corresponding  $SET[n]$  bit, allowing the remaining items to transfer using single requests. In order to resume transfers using burst requests, the corresponding bit must be set again. A bit should not be set if the corresponding peripheral does not support the burst request model.

Refer to “Request Types” on page 249 for more details about request types.

**DMA Channel Useburst Set (DMAUSEBURSTSET)**

Base 0x400F.F000  
Offset 0x018  
Type R/W, reset 0x0000.0000

	31	30	29	28	27	26	25	24	23	22	21	20	19	18	17	16
	SET[n]															
Type	R/W	R/W	R/W	R/W	R/W	R/W	R/W	R/W	R/W	R/W	R/W	R/W	R/W	R/W	R/W	R/W
Reset	0	0	0	0	0	0	0	0	0	0	0	0	0	0	0	0
	15	14	13	12	11	10	9	8	7	6	5	4	3	2	1	0
	SET[n]															
Type	R/W	R/W	R/W	R/W	R/W	R/W	R/W	R/W	R/W	R/W	R/W	R/W	R/W	R/W	R/W	R/W
Reset	0	0	0	0	0	0	0	0	0	0	0	0	0	0	0	0

Bit/Field	Name	Type	Reset	Description
31:0	SET[n]	R/W	0x0000.0000	Channel [n] Useburst Set

Value	Description
0	$\mu$ DMA channel [n] responds to single or burst requests.
1	$\mu$ DMA channel [n] responds only to burst requests.

Bit 0 corresponds to channel 0. This bit is automatically cleared as described above. A bit can also be manually cleared by setting the corresponding  $CLR[n]$  bit in the **DMAUSEBURSTCLR** register.

### Register 11: DMA Channel Useburst Clear (DMAUSEBURSTCLR), offset 0x01C

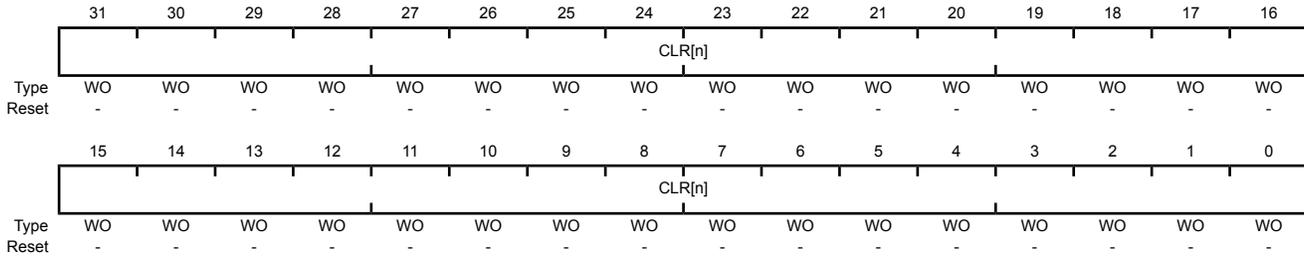
Each bit of the **DMAUSEBURSTCLR** register represents the corresponding  $\mu$ DMA channel. Setting a bit clears the corresponding **SET[n]** bit in the **DMAUSEBURSTSET** register.

#### DMA Channel Useburst Clear (DMAUSEBURSTCLR)

Base 0x400F.F000

Offset 0x01C

Type WO, reset -



Bit/Field	Name	Type	Reset	Description
31:0	CLR[n]	WO	-	Channel [n] Useburst Clear

Value Description

0 No effect.

1 Setting a bit clears the corresponding **SET[n]** bit in the **DMAUSEBURSTSET** register meaning that  $\mu$ DMA channel [n] responds to single and burst requests.

## Register 12: DMA Channel Request Mask Set (DMAREQMASKSET), offset 0x020

Each bit of the **DMAREQMASKSET** register represents the corresponding  $\mu$ DMA channel. Setting a bit disables  $\mu$ DMA requests for the channel. Reading the register returns the request mask status. When a  $\mu$ DMA channel's request is masked, that means the peripheral can no longer request  $\mu$ DMA transfers. The channel can then be used for software-initiated transfers.

### DMA Channel Request Mask Set (DMAREQMASKSET)

Base 0x400F.F000  
Offset 0x020  
Type R/W, reset 0x0000.0000

	31	30	29	28	27	26	25	24	23	22	21	20	19	18	17	16
	SET[n]															
Type	R/W	R/W	R/W	R/W	R/W	R/W	R/W	R/W	R/W	R/W	R/W	R/W	R/W	R/W	R/W	R/W
Reset	0	0	0	0	0	0	0	0	0	0	0	0	0	0	0	0
	15	14	13	12	11	10	9	8	7	6	5	4	3	2	1	0
	SET[n]															
Type	R/W	R/W	R/W	R/W	R/W	R/W	R/W	R/W	R/W	R/W	R/W	R/W	R/W	R/W	R/W	R/W
Reset	0	0	0	0	0	0	0	0	0	0	0	0	0	0	0	0

Bit/Field	Name	Type	Reset	Description
31:0	SET[n]	R/W	0x0000.0000	Channel [n] Request Mask Set

#### Value Description

Value	Description
0	The peripheral associated with channel [n] is enabled to request $\mu$ DMA transfers.
1	The peripheral associated with channel [n] is not able to request $\mu$ DMA transfers. Channel [n] may be used for software-initiated transfers.

Bit 0 corresponds to channel 0. A bit can only be cleared by setting the corresponding `CLR[n]` bit in the **DMAREQMASKCLR** register.

### Register 13: DMA Channel Request Mask Clear (DMAREQMASKCLR), offset 0x024

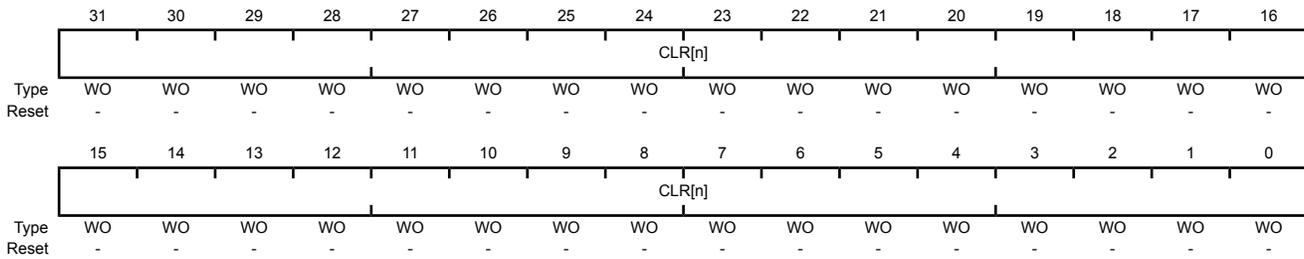
Each bit of the **DMAREQMASKCLR** register represents the corresponding  $\mu$ DMA channel. Setting a bit clears the corresponding **SET[n]** bit in the **DMAREQMASKSET** register.

#### DMA Channel Request Mask Clear (DMAREQMASKCLR)

Base 0x400F.F000

Offset 0x024

Type WO, reset -



Bit/Field	Name	Type	Reset	Description
31:0	CLR[n]	WO	-	Channel [n] Request Mask Clear

**Value Description**

- 0 No effect.
- 1 Setting a bit clears the corresponding **SET[n]** bit in the **DMAREQMASKSET** register meaning that the peripheral associated with channel [n] is enabled to request  $\mu$ DMA transfers.

## Register 14: DMA Channel Enable Set (DMAENASET), offset 0x028

Each bit of the **DMAENASET** register represents the corresponding  $\mu$ DMA channel. Setting a bit enables the corresponding  $\mu$ DMA channel. Reading the register returns the enable status of the channels. If a channel is enabled but the request mask is set (**DMAREQMASKSET**), then the channel can be used for software-initiated transfers.

### DMA Channel Enable Set (DMAENASET)

Base 0x400F.F000  
Offset 0x028  
Type R/W, reset 0x0000.0000

	31	30	29	28	27	26	25	24	23	22	21	20	19	18	17	16
	SET[n]															
Type	R/W	R/W	R/W	R/W	R/W	R/W	R/W	R/W	R/W	R/W	R/W	R/W	R/W	R/W	R/W	R/W
Reset	0	0	0	0	0	0	0	0	0	0	0	0	0	0	0	0
	15	14	13	12	11	10	9	8	7	6	5	4	3	2	1	0
	SET[n]															
Type	R/W	R/W	R/W	R/W	R/W	R/W	R/W	R/W	R/W	R/W	R/W	R/W	R/W	R/W	R/W	R/W
Reset	0	0	0	0	0	0	0	0	0	0	0	0	0	0	0	0

Bit/Field	Name	Type	Reset	Description
31:0	SET[n]	R/W	0x0000.0000	Channel [n] Enable Set

Value	Description
0	$\mu$ DMA Channel [n] is disabled.
1	$\mu$ DMA Channel [n] is enabled.

Bit 0 corresponds to channel 0. A bit can only be cleared by setting the corresponding **CLR[n]** bit in the **DMAENACL** register.

### Register 15: DMA Channel Enable Clear (DMAENACL<sub>R</sub>), offset 0x02C

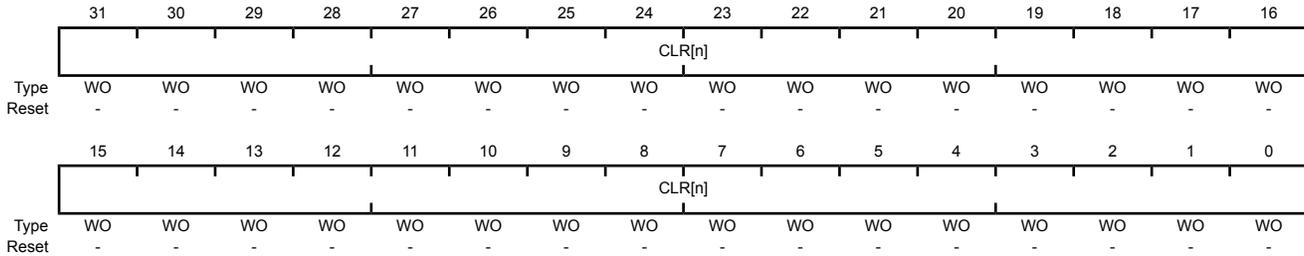
Each bit of the **DMAENACL<sub>R</sub>** register represents the corresponding  $\mu$ DMA channel. Setting a bit clears the corresponding **SET[n]** bit in the **DMAENASET** register.

#### DMA Channel Enable Clear (DMAENACL<sub>R</sub>)

Base 0x400F.F000

Offset 0x02C

Type WO, reset -



Bit/Field	Name	Type	Reset	Description
31:0	CLR[n]	WO	-	Clear Channel [n] Enable Clear

Value	Description
0	No effect.
1	Setting a bit clears the corresponding <b>SET[n]</b> bit in the <b>DMAENASET</b> register meaning that channel [n] is disabled for $\mu$ DMA transfers.

**Note:** The controller disables a channel when it completes the  $\mu$ DMA cycle.



**Register 16: DMA Channel Primary Alternate Set (DMAALTSET), offset 0x030**

Each bit of the **DMAALTSET** register represents the corresponding  $\mu$ DMA channel. Setting a bit configures the  $\mu$ DMA channel to use the alternate control data structure. Reading the register returns the status of which control data structure is in use for the corresponding  $\mu$ DMA channel.

**DMA Channel Primary Alternate Set (DMAALTSET)**

Base 0x400F.F000  
Offset 0x030  
Type R/W, reset 0x0000.0000

	31	30	29	28	27	26	25	24	23	22	21	20	19	18	17	16
	SET[n]															
Type	R/W	R/W	R/W	R/W	R/W	R/W	R/W	R/W	R/W	R/W	R/W	R/W	R/W	R/W	R/W	R/W
Reset	0	0	0	0	0	0	0	0	0	0	0	0	0	0	0	0
	15	14	13	12	11	10	9	8	7	6	5	4	3	2	1	0
	SET[n]															
Type	R/W	R/W	R/W	R/W	R/W	R/W	R/W	R/W	R/W	R/W	R/W	R/W	R/W	R/W	R/W	R/W
Reset	0	0	0	0	0	0	0	0	0	0	0	0	0	0	0	0

Bit/Field	Name	Type	Reset	Description
31:0	SET[n]	R/W	0x0000.0000	Channel [n] Alternate Set

**Value Description**

- |   |   |
|---|---|
| 0 | $\mu$ DMA channel [n] is using the primary control structure.   |
| 1 | $\mu$ DMA channel [n] is using the alternate control structure. |

Bit 0 corresponds to channel 0. A bit can only be cleared by setting the corresponding CLR[n] bit in the **DMAALTCLR** register.

**Note:** For Ping-Pong and Scatter-Gather cycle types, the  $\mu$ DMA controller automatically sets these bits to select the alternate channel control data structure.

## Register 17: DMA Channel Primary Alternate Clear (DMAALTCLR), offset 0x034

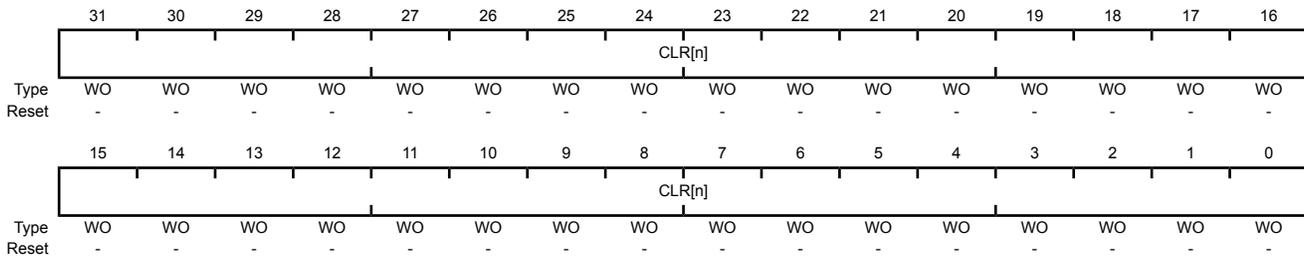
Each bit of the **DMAALTCLR** register represents the corresponding  $\mu$ DMA channel. Setting a bit clears the corresponding **SET[n]** bit in the **DMAALTSET** register.

### DMA Channel Primary Alternate Clear (DMAALTCLR)

Base 0x400F.F000

Offset 0x034

Type WO, reset -



Bit/Field	Name	Type	Reset	Description
31:0	CLR[n]	WO	-	Channel [n] Alternate Clear

Value	Description
0	No effect.
1	Setting a bit clears the corresponding <b>SET[n]</b> bit in the <b>DMAALTSET</b> register meaning that channel [n] is using the primary control structure.

**Note:** For Ping-Pong and Scatter-Gather cycle types, the  $\mu$ DMA controller automatically sets these bits to select the alternate channel control data structure.

## Register 18: DMA Channel Priority Set (DMAPRIOSET), offset 0x038

Each bit of the **DMAPRIOSET** register represents the corresponding  $\mu$ DMA channel. Setting a bit configures the  $\mu$ DMA channel to have a high priority level. Reading the register returns the status of the channel priority mask.

### DMA Channel Priority Set (DMAPRIOSET)

Base 0x400F.F000  
Offset 0x038  
Type R/W, reset 0x0000.0000

	31	30	29	28	27	26	25	24	23	22	21	20	19	18	17	16
	SET[n]															
Type	R/W	R/W	R/W	R/W	R/W	R/W	R/W	R/W	R/W	R/W	R/W	R/W	R/W	R/W	R/W	R/W
Reset	0	0	0	0	0	0	0	0	0	0	0	0	0	0	0	0
	15	14	13	12	11	10	9	8	7	6	5	4	3	2	1	0
	SET[n]															
Type	R/W	R/W	R/W	R/W	R/W	R/W	R/W	R/W	R/W	R/W	R/W	R/W	R/W	R/W	R/W	R/W
Reset	0	0	0	0	0	0	0	0	0	0	0	0	0	0	0	0

Bit/Field	Name	Type	Reset	Description
31:0	SET[n]	R/W	0x0000.0000	Channel [n] Priority Set

#### Value Description

- 0  $\mu$ DMA channel [n] is using the default priority level.
- 1  $\mu$ DMA channel [n] is using a high priority level.

Bit 0 corresponds to channel 0. A bit can only be cleared by setting the corresponding CLR[n] bit in the **DMAPRIOCLR** register.

### Register 19: DMA Channel Priority Clear (DMPRIOCLR), offset 0x03C

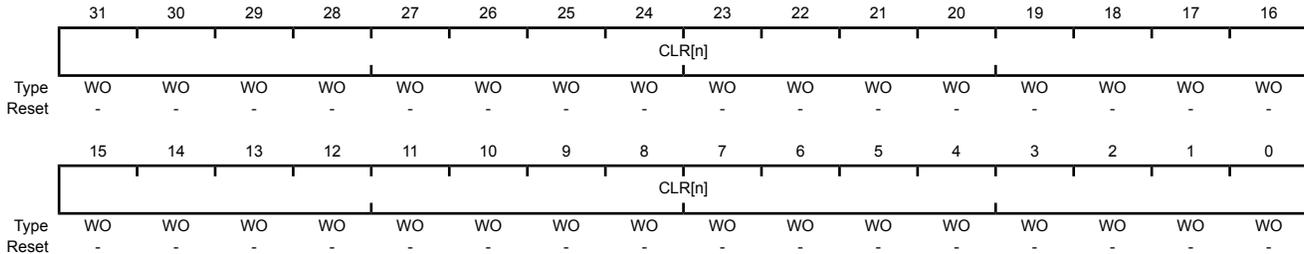
Each bit of the **DMPRIOCLR** register represents the corresponding  $\mu$ DMA channel. Setting a bit clears the corresponding **SET[n]** bit in the **DMPRIOSET** register.

#### DMA Channel Priority Clear (DMPRIOCLR)

Base 0x400F.F000

Offset 0x03C

Type WO, reset -



Bit/Field	Name	Type	Reset	Description
31:0	CLR[n]	WO	-	Channel [n] Priority Clear
				Value Description
				0 No effect.
				1 Setting a bit clears the corresponding <b>SET[n]</b> bit in the <b>DMPRIOSET</b> register meaning that channel [n] is using the default priority level.

## Register 20: DMA Bus Error Clear (DMAERRCLR), offset 0x04C

The **DMAERRCLR** register is used to read and clear the  $\mu$ DMA bus error status. The error status is set if the  $\mu$ DMA controller encountered a bus error while performing a transfer. If a bus error occurs on a channel, that channel is automatically disabled by the  $\mu$ DMA controller. The other channels are unaffected.

### DMA Bus Error Clear (DMAERRCLR)

Base 0x400F.F000  
Offset 0x04C  
Type R/W, reset 0x0000.0000

	31	30	29	28	27	26	25	24	23	22	21	20	19	18	17	16	
	reserved																
Type	RO	RO	RO	RO	RO	RO	RO	RO	RO	RO	RO	RO	RO	RO	RO	RO	
Reset	0	0	0	0	0	0	0	0	0	0	0	0	0	0	0	0	
	15	14	13	12	11	10	9	8	7	6	5	4	3	2	1	0	
	reserved															ERRCLR	
Type	RO	RO	RO	RO	RO	RO	RO	RO	RO	RO	RO	RO	RO	RO	RO	RO	R/W1C
Reset	0	0	0	0	0	0	0	0	0	0	0	0	0	0	0	0	0

Bit/Field	Name	Type	Reset	Description
31:1	reserved	RO	0x0000.000	Software should not rely on the value of a reserved bit. To provide compatibility with future products, the value of a reserved bit should be preserved across a read-modify-write operation.

0	ERRCLR	R/W1C	0	$\mu$ DMA Bus Error Status
---	--------	-------	---	----------------------------

#### Value Description

Value	Description
0	No bus error is pending.
1	A bus error is pending.

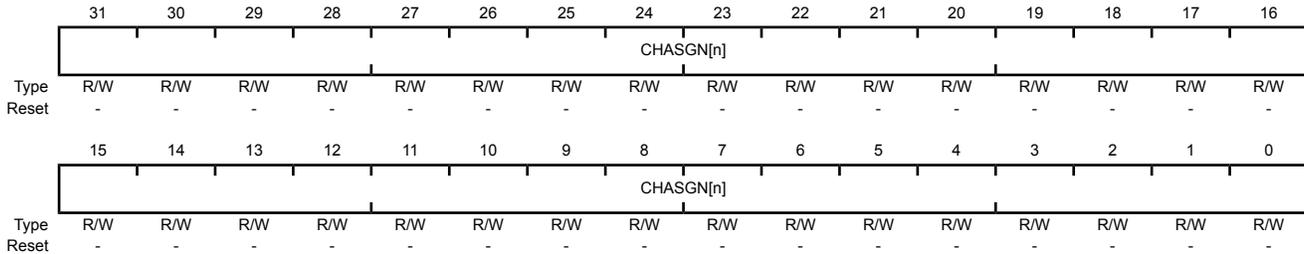
This bit is cleared by writing a 1 to it.

### Register 21: DMA Channel Assignment (DMACHASGN), offset 0x500

Each bit of the **DMACHASGN** register represents the corresponding  $\mu$ DMA channel. Setting a bit selects the secondary channel assignment as specified in Table 8-1 on page 248.

#### DMA Channel Assignment (DMACHASGN)

Base 0x400F.F000  
 Offset 0x500  
 Type R/W, reset 0x0000.0000



Bit/Field	Name	Type	Reset	Description
31:0	CHASGN[n]	R/W	-	Channel [n] Assignment Select
				Value Description
				0 Use the primary channel assignment.
				1 Use the secondary channel assignment.

**Register 22: DMA Peripheral Identification 0 (DMAPeriphID0), offset 0xFE0**

The **DMAPeriphIDn** registers are hard-coded, and the fields within the registers determine the reset values.

**DMA Peripheral Identification 0 (DMAPeriphID0)**

Base 0x400F.F000

Offset 0xFE0

Type RO, reset 0x0000.0030

	31	30	29	28	27	26	25	24	23	22	21	20	19	18	17	16
	reserved															
Type	RO	RO	RO	RO	RO	RO	RO	RO	RO	RO	RO	RO	RO	RO	RO	RO
Reset	0	0	0	0	0	0	0	0	0	0	0	0	0	0	0	0
	15	14	13	12	11	10	9	8	7	6	5	4	3	2	1	0
	reserved								PID0							
Type	RO	RO	RO	RO	RO	RO	RO	RO	RO	RO	RO	RO	RO	RO	RO	RO
Reset	0	0	0	0	0	0	0	0	0	0	1	1	0	0	0	0

Bit/Field	Name	Type	Reset	Description
31:8	reserved	RO	0x0000.00	Software should not rely on the value of a reserved bit. To provide compatibility with future products, the value of a reserved bit should be preserved across a read-modify-write operation.
7:0	PID0	RO	0x30	<p>μDMA Peripheral ID Register [7:0]</p> <p>Can be used by software to identify the presence of this peripheral.</p>

### Register 23: DMA Peripheral Identification 1 (DMAPeriphID1), offset 0xFE4

The **DMAPeriphIDn** registers are hard-coded, and the fields within the registers determine the reset values.

#### DMA Peripheral Identification 1 (DMAPeriphID1)

Base 0x400F.F000

Offset 0xFE4

Type RO, reset 0x0000.00B2

	31	30	29	28	27	26	25	24	23	22	21	20	19	18	17	16
	reserved															
Type	RO	RO	RO	RO	RO	RO	RO	RO	RO	RO	RO	RO	RO	RO	RO	RO
Reset	0	0	0	0	0	0	0	0	0	0	0	0	0	0	0	0
	15	14	13	12	11	10	9	8	7	6	5	4	3	2	1	0
	reserved								PID1							
Type	RO	RO	RO	RO	RO	RO	RO	RO	RO	RO	RO	RO	RO	RO	RO	RO
Reset	0	0	0	0	0	0	0	0	1	0	1	1	0	0	1	0

Bit/Field	Name	Type	Reset	Description
31:8	reserved	RO	0x0000.00	Software should not rely on the value of a reserved bit. To provide compatibility with future products, the value of a reserved bit should be preserved across a read-modify-write operation.
7:0	PID1	RO	0xB2	$\mu$ DMA Peripheral ID Register [15:8] Can be used by software to identify the presence of this peripheral.



**Register 24: DMA Peripheral Identification 2 (DMAPeriphID2), offset 0xFE8**

The **DMAPeriphIDn** registers are hard-coded, and the fields within the registers determine the reset values.

**DMA Peripheral Identification 2 (DMAPeriphID2)**

Base 0x400F.F000

Offset 0xFE8

Type RO, reset 0x0000.000B

	31	30	29	28	27	26	25	24	23	22	21	20	19	18	17	16
	reserved															
Type	RO	RO	RO	RO	RO	RO	RO	RO	RO	RO	RO	RO	RO	RO	RO	RO
Reset	0	0	0	0	0	0	0	0	0	0	0	0	0	0	0	0
	15	14	13	12	11	10	9	8	7	6	5	4	3	2	1	0
	reserved								PID2							
Type	RO	RO	RO	RO	RO	RO	RO	RO	RO	RO	RO	RO	RO	RO	RO	RO
Reset	0	0	0	0	0	0	0	0	0	0	0	0	1	0	1	1

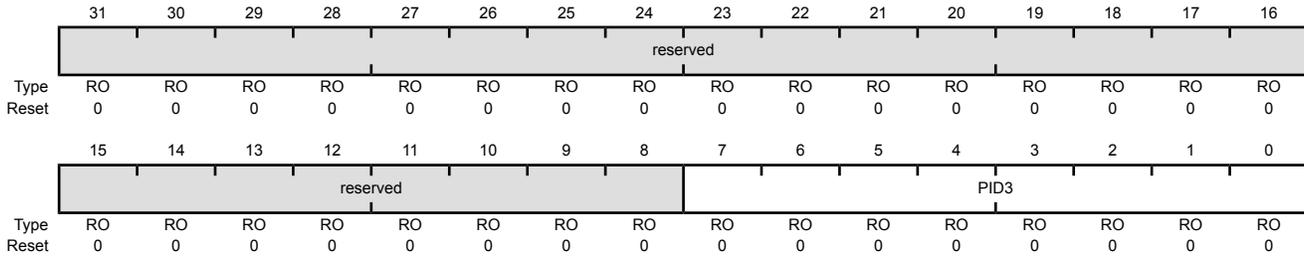
Bit/Field	Name	Type	Reset	Description
31:8	reserved	RO	0x0000.00	Software should not rely on the value of a reserved bit. To provide compatibility with future products, the value of a reserved bit should be preserved across a read-modify-write operation.
7:0	PID2	RO	0x0B	$\mu$ DMA Peripheral ID Register [23:16] Can be used by software to identify the presence of this peripheral.

### Register 25: DMA Peripheral Identification 3 (DMAPeriphID3), offset 0xFEC

The DMAPeriphIDn registers are hard-coded and the fields within the registers determine the reset values.

#### DMA Peripheral Identification 3 (DMAPeriphID3)

Base 0x400F.F000  
 Offset 0xFEC  
 Type RO, reset 0x0000.0000



Bit/Field	Name	Type	Reset	Description
31:8	reserved	RO	0x0000.00	Software should not rely on the value of a reserved bit. To provide compatibility with future products, the value of a reserved bit should be preserved across a read-modify-write operation.
7:0	PID3	RO	0x00	$\mu$ DMA Peripheral ID Register [31:24] Can be used by software to identify the presence of this peripheral.

**Register 26: DMA Peripheral Identification 4 (DMAPeriphID4), offset 0xFD0**

The **DMAPeriphIDn** registers are hard-coded, and the fields within the registers determine the reset values.

**DMA Peripheral Identification 4 (DMAPeriphID4)**

Base 0x400F.F000

Offset 0xFD0

Type RO, reset 0x0000.0004

	31	30	29	28	27	26	25	24	23	22	21	20	19	18	17	16
	reserved															
Type	RO	RO	RO	RO	RO	RO	RO	RO	RO	RO	RO	RO	RO	RO	RO	RO
Reset	0	0	0	0	0	0	0	0	0	0	0	0	0	0	0	0
	15	14	13	12	11	10	9	8	7	6	5	4	3	2	1	0
	reserved								PID4							
Type	RO	RO	RO	RO	RO	RO	RO	RO	RO	RO	RO	RO	RO	RO	RO	RO
Reset	0	0	0	0	0	0	0	0	0	0	0	0	0	1	0	0

Bit/Field	Name	Type	Reset	Description
31:8	reserved	RO	0x0000.00	Software should not rely on the value of a reserved bit. To provide compatibility with future products, the value of a reserved bit should be preserved across a read-modify-write operation.
7:0	PID4	RO	0x04	$\mu$ DMA Peripheral ID Register Can be used by software to identify the presence of this peripheral.

### Register 27: DMA PrimeCell Identification 0 (DMAPCellID0), offset 0xFF0

The **DMAPCellIDn** registers are hard-coded, and the fields within the registers determine the reset values.

#### DMA PrimeCell Identification 0 (DMAPCellID0)

Base 0x400F.F000

Offset 0xFF0

Type RO, reset 0x0000.000D

	31	30	29	28	27	26	25	24	23	22	21	20	19	18	17	16
	reserved															
Type	RO	RO	RO	RO	RO	RO	RO	RO	RO	RO	RO	RO	RO	RO	RO	RO
Reset	0	0	0	0	0	0	0	0	0	0	0	0	0	0	0	0
	15	14	13	12	11	10	9	8	7	6	5	4	3	2	1	0
	reserved								CID0							
Type	RO	RO	RO	RO	RO	RO	RO	RO	RO	RO	RO	RO	RO	RO	RO	RO
Reset	0	0	0	0	0	0	0	0	0	0	0	0	1	1	0	1

Bit/Field	Name	Type	Reset	Description
31:8	reserved	RO	0x0000.00	Software should not rely on the value of a reserved bit. To provide compatibility with future products, the value of a reserved bit should be preserved across a read-modify-write operation.
7:0	CID0	RO	0x0D	$\mu$ DMA PrimeCell ID Register [7:0] Provides software a standard cross-peripheral identification system.

**Register 28: DMA PrimeCell Identification 1 (DMAPCellID1), offset 0xFF4**

The **DMAPCellIDn** registers are hard-coded, and the fields within the registers determine the reset values.

## DMA PrimeCell Identification 1 (DMAPCellID1)

Base 0x400F.F000

Offset 0xFF4

Type RO, reset 0x0000.00F0

	31	30	29	28	27	26	25	24	23	22	21	20	19	18	17	16
	reserved															
Type	RO	RO	RO	RO	RO	RO	RO	RO	RO	RO	RO	RO	RO	RO	RO	RO
Reset	0	0	0	0	0	0	0	0	0	0	0	0	0	0	0	0
	15	14	13	12	11	10	9	8	7	6	5	4	3	2	1	0
	reserved								CID1							
Type	RO	RO	RO	RO	RO	RO	RO	RO	RO	RO	RO	RO	RO	RO	RO	RO
Reset	0	0	0	0	0	0	0	0	1	1	1	1	0	0	0	0

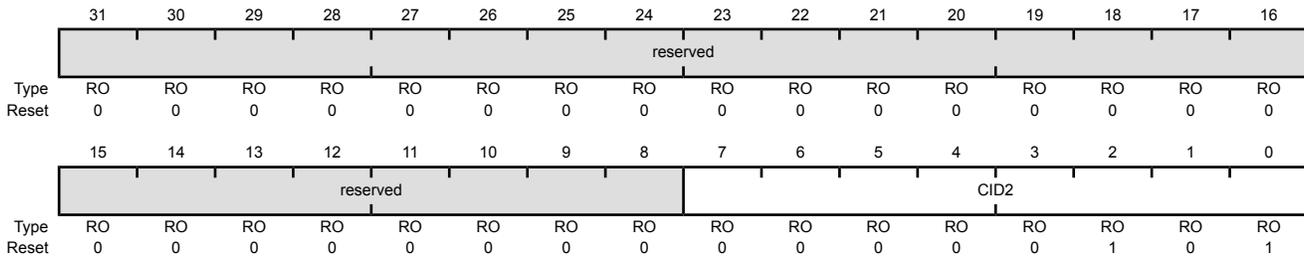
Bit/Field	Name	Type	Reset	Description
31:8	reserved	RO	0x0000.00	Software should not rely on the value of a reserved bit. To provide compatibility with future products, the value of a reserved bit should be preserved across a read-modify-write operation.
7:0	CID1	RO	0xF0	<p>μDMA PrimeCell ID Register [15:8]</p> <p>Provides software a standard cross-peripheral identification system.</p>

### Register 29: DMA PrimeCell Identification 2 (DMAPCellID2), offset 0xFF8

The **DMAPCellIDn** registers are hard-coded, and the fields within the registers determine the reset values.

#### DMA PrimeCell Identification 2 (DMAPCellID2)

Base 0x400F.F000  
 Offset 0xFF8  
 Type RO, reset 0x0000.0005



Bit/Field	Name	Type	Reset	Description
31:8	reserved	RO	0x00	Software should not rely on the value of a reserved bit. To provide compatibility with future products, the value of a reserved bit should be preserved across a read-modify-write operation.
7:0	CID2	RO	0x05	$\mu$ DMA PrimeCell ID Register [23:16] Provides software a standard cross-peripheral identification system.

**Register 30: DMA PrimeCell Identification 3 (DMAPCellID3), offset 0xFFC**

The **DMAPCellIDn** registers are hard-coded, and the fields within the registers determine the reset values.

**DMA PrimeCell Identification 3 (DMAPCellID3)**

Base 0x400F.F000

Offset 0xFFC

Type RO, reset 0x0000.00B1

	31	30	29	28	27	26	25	24	23	22	21	20	19	18	17	16
	reserved															
Type	RO	RO	RO	RO	RO	RO	RO	RO	RO	RO	RO	RO	RO	RO	RO	RO
Reset	0	0	0	0	0	0	0	0	0	0	0	0	0	0	0	0
	15	14	13	12	11	10	9	8	7	6	5	4	3	2	1	0
	reserved								CID3							
Type	RO	RO	RO	RO	RO	RO	RO	RO	RO	RO	RO	RO	RO	RO	RO	RO
Reset	0	0	0	0	0	0	0	0	1	0	1	1	0	0	0	1

Bit/Field	Name	Type	Reset	Description
31:8	reserved	RO	0x00	Software should not rely on the value of a reserved bit. To provide compatibility with future products, the value of a reserved bit should be preserved across a read-modify-write operation.
7:0	CID3	RO	0xB1	<p>μDMA PrimeCell ID Register [31:24]</p> <p>Provides software a standard cross-peripheral identification system.</p>

## 9 General-Purpose Input/Outputs (GPIOs)

The GPIO module is composed of nine physical GPIO blocks, each corresponding to an individual GPIO port (Port A, Port B, Port C, Port D, Port E, Port F, Port G, Port H, Port J). The GPIO module supports up to 65 programmable input/output pins, depending on the peripherals being used.

The GPIO module has the following features:

- Up to 65 GPIOs, depending on configuration
- Highly flexible pin muxing allows use as GPIO or one of several peripheral functions
- 5-V-tolerant input/outputs
- Fast toggle capable of a change every two clock cycles
- Two means of port access: either Advanced High-Performance Bus (AHB) with better back-to-back access performance, or the legacy Advanced Peripheral Bus (APB) for backwards-compatibility with existing code
- Programmable control for GPIO interrupts
  - Interrupt generation masking
  - Edge-triggered on rising, falling, or both
  - Level-sensitive on High or Low values
- Bit masking in both read and write operations through address lines
- Can be used to initiate an ADC sample sequence
- Pins configured as digital inputs are Schmitt-triggered
- Programmable control for GPIO pad configuration
  - Weak pull-up or pull-down resistors
  - 2-mA, 4-mA, and 8-mA pad drive for digital communication; up to four pads can be configured with an 18-mA pad drive for high-current applications
  - Slew rate control for the 8-mA drive
  - Open drain enables
  - Digital input enables

### 9.1 Signal Description

GPIO signals have alternate hardware functions. Table 9-2 on page 305 and Table 9-3 on page 307 list the GPIO pins and their analog and digital alternate functions. The  $A_{INx}$  and  $V_{REFA}$  analog signals are not 5-V tolerant and go through an isolation circuit before reaching their circuitry. These signals are configured by clearing the corresponding  $DEN$  bit in the **GPIO Digital Enable (GPIO DEN)** register and setting the corresponding  $AMSEL$  bit in the **GPIO Analog Mode Select (GPIO AMSEL)** register. Other analog signals are 5-V tolerant and are connected directly to their circuitry ( $C0-$ ,



C0+, C1-, C1+, C2-, C2+, USB0VBUS, USB0ID). These signals are configured by clearing the DEN bit in the **GPIO Digital Enable (GPIODEN)** register. The digital alternate hardware functions are enabled by setting the appropriate bit in the **GPIO Alternate Function Select (GPIOAFSEL)** and **GPIODEN** registers and configuring the PMC<sub>x</sub> bit field in the **GPIO Port Control (GPIOPCTL)** register to the numeric encoding shown in the table below. Table entries that are shaded gray are the default values for the corresponding GPIO pin.

**Important:** All GPIO pins are configured as GPIOs and tri-stated by default (**GPIOAFSEL=0**, **GPIODEN=0**, **GPIOPDR=0**, **GPIOPUR=0**, and **GPIOPCTL=0**) with the exception of the pins shown in the table below. A Power-On-Reset ( $\overline{\text{POR}}$ ) or asserting  $\overline{\text{RST}}$  puts the pins back to their default state.

**Table 9-1. GPIO Pins With Non-Zero Reset Values**

GPIO Pins	Default State	GPIOAFSEL	GPIODEN	GPIOPDR	GPIOPUR	GPIOPCTL
PA[1:0]	UART0	1	1	0	0	0x1
PA[5:2]	SSI0	1	1	0	0	0x1
PB[3:2]	I <sup>2</sup> C0	1	1	0	0	0x1
PC[3:0]	JTAG/SWD	1	1	0	1	0x3

**Table 9-2. GPIO Pins and Alternate Functions (100LQFP)**

IO	Pin	Analog Function	Digital Function (GPIOPCTL PMC <sub>x</sub> Bit Field Encoding) <sup>a</sup>											
			1	2	3	4	5	6	7	8	9	10	11	
PA0	26	-	U0Rx	-	-	-	-	-	-	-	I2C1SCL	U1Rx	-	-
PA1	27	-	U0Tx	-	-	-	-	-	-	-	I2C1SDA	U1Tx	-	-
PA2	28	-	SSI0Clk	-	-	PWM4	-	-	-	-	I2S0RXSD	-	-	-
PA3	29	-	SSI0Fss	-	-	PWM5	-	-	-	-	I2S0RMCLK	-	-	-
PA4	30	-	SSI0Rx	-	-	PWM6	CAN0Rx	-	-	-	I2S0TXSCK	-	-	-
PA5	31	-	SSI0Tx	-	-	PWM7	CAN0Tx	-	-	-	I2S0TXWS	-	-	-
PA6	34	-	I2C1SCL	CCP1	-	PWM0	PWM4	CAN0Rx	-	USB0EPEN	U1CTS	-	-	-
PA7	35	-	I2C1SDA	CCP4	-	PWM1	PWM5	CAN0Tx	CCP3	USB0PFLT	U1DCD	-	-	-
PB0	66	USB0ID	CCP0	PWM2	-	-	U1Rx	-	-	-	-	-	-	-
PB1	67	USB0VBUS	CCP2	PWM3	-	CCP1	U1Tx	-	-	-	-	-	-	-
PB2	72	-	I2C0SCL	IDX0	-	CCP3	CCP0	-	-	USB0EPEN	-	-	-	-
PB3	65	-	I2C0SDA	Fault0	-	Fault3	-	-	-	USB0PFLT	-	-	-	-
PB4	92	AIN10 C0-	-	-	-	U2Rx	CAN0Rx	IDX0	U1Rx	EPI0S23	-	-	-	-
PB5	91	AIN11 C1-	C0o	CCP5	CCP6	CCP0	CAN0Tx	CCP2	U1Tx	EPI0S22	-	-	-	-
PB6	90	VREFA C0+	CCP1	CCP7	C0o	Fault1	IDX0	CCP5	-	-	I2S0TXSCK	-	-	-
PB7	89	-	-	-	-	NMI	-	-	-	-	-	-	-	-
PC0	80	-	-	-	TCK SWCLK	-	-	-	-	-	-	-	-	-
PC1	79	-	-	-	TMS SWDIO	-	-	-	-	-	-	-	-	-
PC2	78	-	-	-	TDI	-	-	-	-	-	-	-	-	-

Table 9-2. GPIO Pins and Alternate Functions (100LQFP) (continued)

IO	Pin	Analog Function	Digital Function (GPIOCTL PMCx Bit Field Encoding) <sup>a</sup>										
			1	2	3	4	5	6	7	8	9	10	11
PC3	77	-	-	-	TDO SWO	-	-	-	-	-	-	-	-
PC4	25	-	CCP5	PhA0	-	PWM6	CCP2	CCP4	-	EPI0S2	CCP1	-	-
PC5	24	C1+	CCP1	C1o	C0o	Fault2	CCP3	USB0EPEN	-	EPI0S3	-	-	-
PC6	23	C2+	CCP3	PhB0	C2o	PWM7	U1Rx	CCP0	USB0PFLT	EPI0S4	-	-	-
PC7	22	C2-	CCP4	PhB0	-	CCP0	U1Tx	USB0PFLT	C1o	EPI0S5	-	-	-
PD0	10	AIN15	PWM0	CAN0Rx	IDX0	U2Rx	U1Rx	CCP6	-	I2S0RXSCK	U1CTS	-	-
PD1	11	AIN14	PWM1	CAN0Tx	PhA0	U2Tx	U1Tx	CCP7	-	I2S0RXWS	U1DCD	CCP2	PhB1
PD2	12	AIN13	U1Rx	CCP6	PWM2	CCP5	-	-	-	EPI0S20	-	-	-
PD3	13	AIN12	U1Tx	CCP7	PWM3	CCP0	-	-	-	EPI0S21	-	-	-
PD4	97	AIN7	CCP0	CCP3	-	-	-	-	-	I2S0RXSD	U1RI	EPI0S19	-
PD5	98	AIN6	CCP2	CCP4	-	-	-	-	-	I2S0RMCLK	U2Rx	EPI0S28	-
PD6	99	AIN5	Fault0	-	-	-	-	-	-	I2S0TXSCK	U2Tx	EPI0S29	-
PD7	100	AIN4	IDX0	C0o	CCP1	-	-	-	-	I2S0TXWS	U1DTR	EPI0S30	-
PE0	74	-	PWM4	SSI1Clk	CCP3	-	-	-	-	EPI0S8	USB0PFLT	-	-
PE1	75	-	PWM5	SSI1Fss	Fault0	CCP2	CCP6	-	-	EPI0S9	-	-	-
PE2	95	AIN9	CCP4	SSI1Rx	PhB1	PhA0	CCP2	-	-	EPI0S24	-	-	-
PE3	96	AIN8	CCP1	SSI1Tx	PhA1	PhB0	CCP7	-	-	EPI0S25	-	-	-
PE4	6	AIN3	CCP3	-	-	Fault0	U2Tx	CCP2	-	-	I2S0TXWS	-	-
PE5	5	AIN2	CCP5	-	-	-	-	-	-	-	I2S0TXSD	-	-
PE6	2	AIN1	PWM4	C1o	-	-	-	-	-	-	U1CTS	-	-
PE7	1	AIN0	PWM5	C2o	-	-	-	-	-	-	U1DCD	-	-
PF0	47	-	CAN1Rx	PhB0	PWM0	-	-	-	-	I2S0TXSD	U1DSR	-	-
PF1	61	-	CAN1Tx	IDX1	PWM1	-	-	-	-	I2S0RMCLK	U1RTS	CCP3	-
PF2	60	-	LED1	PWM4	-	PWM2	-	-	-	-	SSI1Clk	-	-
PF3	59	-	LED0	PWM5	-	PWM3	-	-	-	-	SSI1Fss	-	-
PF4	42	-	CCP0	C0o	-	Fault0	-	-	-	EPI0S12	SSI1Rx	-	-
PF5	41	-	CCP2	C1o	-	-	-	-	-	EPI0S15	SSI1Tx	-	-
PG0	19	-	U2Rx	PWM0	I2C1SCL	PWM4	-	-	USB0EPEN	EPI0S13	-	-	-
PG1	18	-	U2Tx	PWM1	I2C1SDA	PWM5	-	-	-	EPI0S14	-	-	-
PG7	36	-	PhB1	-	-	PWM7	-	-	-	CCP5	EPI0S31	-	-
PH0	86	-	CCP6	PWM2	-	-	-	-	-	EPI0S6	PWM4	-	-
PH1	85	-	CCP7	PWM3	-	-	-	-	-	EPI0S7	PWM5	-	-
PH2	84	-	IDX1	C1o	-	Fault3	-	-	-	EPI0S1	-	-	-
PH3	83	-	PhB0	Fault0	-	USB0EPEN	-	-	-	EPI0S0	-	-	-
PH4	76	-	-	-	-	USB0PFLT	-	-	-	EPI0S10	-	-	SSI1Clk
PH5	63	-	-	-	-	-	-	-	-	EPI0S11	-	Fault2	SSI1Fss
PH6	62	-	-	-	-	-	-	-	-	EPI0S26	-	PWM4	SSI1Rx
PH7	15	-	-	-	-	-	-	-	-	EPI0S27	-	PWM5	SSI1Tx
PJ0	14	-	-	-	-	-	-	-	-	EPI0S16	-	PWM0	I2C1SCL
PJ1	87	-	-	-	-	-	-	-	-	EPI0S17	USB0PFLT	PWM1	I2C1SDA

Table 9-2. GPIO Pins and Alternate Functions (100LQFP) (continued)

IO	Pin	Analog Function	Digital Function (GPIOCTL PMCx Bit Field Encoding) <sup>a</sup>											
			1	2	3	4	5	6	7	8	9	10	11	
PJ2	39	-	-	-	-	-	-	-	-	-	EPI0S18	CCP0	Fault0	-
PJ3	50	-	-	-	-	-	-	-	-	-	EPI0S19	U1CTS	CCP6	-
PJ4	52	-	-	-	-	-	-	-	-	-	EPI0S28	U1DCD	CCP4	-
PJ5	53	-	-	-	-	-	-	-	-	-	EPI0S29	U1DSR	CCP2	-
PJ6	54	-	-	-	-	-	-	-	-	-	EPI0S30	U1RTS	CCP1	-
PJ7	55	-	-	-	-	-	-	-	-	-	-	U1DTR	CCP0	-

a. The digital signals that are shaded gray are the power-on default values for the corresponding GPIO pin.

Table 9-3. GPIO Pins and Alternate Functions (108BGA)

IO	Pin	Analog Function	Digital Function (GPIOCTL PMCx Bit Field Encoding) <sup>a</sup>											
			1	2	3	4	5	6	7	8	9	10	11	
PA0	L3	-	U0Rx	-	-	-	-	-	-	-	I2C1SCL	U1Rx	-	-
PA1	M3	-	U0Tx	-	-	-	-	-	-	-	I2C1SDA	U1Tx	-	-
PA2	M4	-	SSI0Clk	-	-	PWM4	-	-	-	-	I2S0RXSD	-	-	
PA3	L4	-	SSI0Fss	-	-	PWM5	-	-	-	-	I2S0RMCLK	-	-	
PA4	L5	-	SSI0Rx	-	-	PWM6	CAN0Rx	-	-	-	I2S0TXSCK	-	-	
PA5	M5	-	SSI0Tx	-	-	PWM7	CAN0Tx	-	-	-	I2S0TXWS	-	-	
PA6	L6	-	I2C1SCL	CCP1	-	PWM0	PWM4	CAN0Rx	-	USB0EPEN	U1CTS	-	-	
PA7	M6	-	I2C1SDA	CCP4	-	PWM1	PWM5	CAN0Tx	CCP3	USB0PFLT	U1DCD	-	-	
PB0	E12	USB0ID	CCP0	PWM2	-	-	U1Rx	-	-	-	-	-	-	
PB1	D12	USB0VBUS	CCP2	PWM3	-	CCP1	U1Tx	-	-	-	-	-	-	
PB2	A11	-	I2C0SCL	IDX0	-	CCP3	CCP0	-	-	USB0EPEN	-	-	-	
PB3	E11	-	I2C0SDA	Fault0	-	Fault3	-	-	-	USB0PFLT	-	-	-	
PB4	A6	AIN10 C0-	-	-	-	U2Rx	CAN0Rx	IDX0	U1Rx	EPI0S23	-	-	-	
PB5	B7	AIN11 C1-	C0o	CCP5	CCP6	CCP0	CAN0Tx	CCP2	U1Tx	EPI0S22	-	-	-	
PB6	A7	VREFA C0+	CCP1	CCP7	C0o	Fault1	IDX0	CCP5	-	-	I2S0TXSCK	-	-	
PB7	A8	-	-	-	-	NMI	-	-	-	-	-	-	-	
PC0	A9	-	-	-	TCK SWCLK	-	-	-	-	-	-	-	-	
PC1	B9	-	-	-	TMS SWDIO	-	-	-	-	-	-	-	-	
PC2	B8	-	-	-	TDI	-	-	-	-	-	-	-	-	
PC3	A10	-	-	-	TDO SWO	-	-	-	-	-	-	-	-	
PC4	L1	-	CCP5	PhA0	-	PWM6	CCP2	CCP4	-	EPI0S2	CCP1	-	-	
PC5	M1	C1+	CCP1	C1o	C0o	Fault2	CCP3	USB0EPEN	-	EPI0S3	-	-	-	
PC6	M2	C2+	CCP3	PhB0	C2o	PWM7	U1Rx	CCP0	USB0PFLT	EPI0S4	-	-	-	
PC7	L2	C2-	CCP4	PhB0	-	CCP0	U1Tx	USB0PFLT	C1o	EPI0S5	-	-	-	
PD0	G1	AIN15	PWM0	CAN0Rx	IDX0	U2Rx	U1Rx	CCP6	-	I2S0RXSCK	U1CTS	-	-	
PD1	G2	AIN14	PWM1	CAN0Tx	PhA0	U2Tx	U1Tx	CCP7	-	I2S0RXWS	U1DCD	CCP2	PhB1	

Table 9-3. GPIO Pins and Alternate Functions (108BGA) (continued)

IO	Pin	Analog Function	Digital Function (GPIOCTL PMCx Bit Field Encoding) <sup>a</sup>										
			1	2	3	4	5	6	7	8	9	10	11
PD2	H2	AIN13	U1Rx	CCP6	PWM2	CCP5	-	-	-	EPI0S20	-	-	-
PD3	H1	AIN12	U1Tx	CCP7	PWM3	CCP0	-	-	-	EPI0S21	-	-	-
PD4	B5	AIN7	CCP0	CCP3	-	-	-	-	-	I2S0RXSD	U1RI	EPI0S19	-
PD5	C6	AIN6	CCP2	CCP4	-	-	-	-	-	I2S0RMCLK	U2Rx	EPI0S28	-
PD6	A3	AIN5	Fault0	-	-	-	-	-	-	I2S0TXSCK	U2Tx	EPI0S29	-
PD7	A2	AIN4	IDX0	C0o	CCP1	-	-	-	-	I2S0TXWS	U1DTR	EPI0S30	-
PE0	B11	-	PWM4	SSI1Clk	CCP3	-	-	-	-	EPI0S8	USB0PFLT	-	-
PE1	A12	-	PWM5	SSI1Fss	Fault0	CCP2	CCP6	-	-	EPI0S9	-	-	-
PE2	A4	AIN9	CCP4	SSI1Rx	PhB1	PhA0	CCP2	-	-	EPI0S24	-	-	-
PE3	B4	AIN8	CCP1	SSI1Tx	PhA1	PhB0	CCP7	-	-	EPI0S25	-	-	-
PE4	B2	AIN3	CCP3	-	-	Fault0	U2Tx	CCP2	-	-	I2S0TXWS	-	-
PE5	B3	AIN2	CCP5	-	-	-	-	-	-	-	I2S0TXSD	-	-
PE6	A1	AIN1	PWM4	C1o	-	-	-	-	-	-	U1CTS	-	-
PE7	B1	AIN0	PWM5	C2o	-	-	-	-	-	-	U1DCD	-	-
PF0	M9	-	CAN1Rx	PhB0	PWM0	-	-	-	-	I2S0TXSD	U1DSR	-	-
PF1	H12	-	CAN1Tx	IDX1	PWM1	-	-	-	-	I2S0RMCLK	U1RTS	CCP3	-
PF2	J11	-	LED1	PWM4	-	PWM2	-	-	-	-	SSI1Clk	-	-
PF3	J12	-	LED0	PWM5	-	PWM3	-	-	-	-	SSI1Fss	-	-
PF4	K4	-	CCP0	C0o	-	Fault0	-	-	-	EPI0S12	SSI1Rx	-	-
PF5	K3	-	CCP2	C1o	-	-	-	-	-	EPI0S15	SSI1Tx	-	-
PG0	K1	-	U2Rx	PWM0	I2C1SCL	PWM4	-	-	USB0EPEN	EPI0S13	-	-	-
PG1	K2	-	U2Tx	PWM1	I2C1SDA	PWM5	-	-	-	EPI0S14	-	-	-
PG7	C10	-	PhB1	-	-	PWM7	-	-	-	CCP5	EPI0S31	-	-
PH0	C9	-	CCP6	PWM2	-	-	-	-	-	EPI0S6	PWM4	-	-
PH1	C8	-	CCP7	PWM3	-	-	-	-	-	EPI0S7	PWM5	-	-
PH2	D11	-	IDX1	C1o	-	Fault3	-	-	-	EPI0S1	-	-	-
PH3	D10	-	PhB0	Fault0	-	USB0EPEN	-	-	-	EPI0S0	-	-	-
PH4	B10	-	-	-	-	USB0PFLT	-	-	-	EPI0S10	-	-	SSI1Clk
PH5	F10	-	-	-	-	-	-	-	-	EPI0S11	-	Fault2	SSI1Fss
PH6	G3	-	-	-	-	-	-	-	-	EPI0S26	-	PWM4	SSI1Rx
PH7	H3	-	-	-	-	-	-	-	-	EPI0S27	-	PWM5	SSI1Tx
PJ0	F3	-	-	-	-	-	-	-	-	EPI0S16	-	PWM0	I2C1SCL
PJ1	B6	-	-	-	-	-	-	-	-	EPI0S17	USB0PFLT	PWM1	I2C1SDA
PJ2	K6	-	-	-	-	-	-	-	-	EPI0S18	CCP0	Fault0	-
PJ3	M10	-	-	-	-	-	-	-	-	EPI0S19	U1CTS	CCP6	-
PJ4	K11	-	-	-	-	-	-	-	-	EPI0S28	U1DCD	CCP4	-
PJ5	K12	-	-	-	-	-	-	-	-	EPI0S29	U1DSR	CCP2	-
PJ6	L10	-	-	-	-	-	-	-	-	EPI0S30	U1RTS	CCP1	-
PJ7	L12	-	-	-	-	-	-	-	-	-	U1DTR	CCP0	-

a. The digital signals that are shaded gray are the power-on default values for the corresponding GPIO pin.

## 9.2 Functional Description

Each GPIO port is a separate hardware instantiation of the same physical block (see Figure 9-1 on page 309 and Figure 9-2 on page 310). The LM3S9B96 microcontroller contains nine ports and thus nine of these physical GPIO blocks. Note that not all pins may be implemented on every block. Some GPIO pins can function as I/O signals for the on-chip peripheral modules. For information on which GPIO pins are used for alternate hardware functions, refer to Table 25-5 on page 1160.

Figure 9-1. Digital I/O Pads

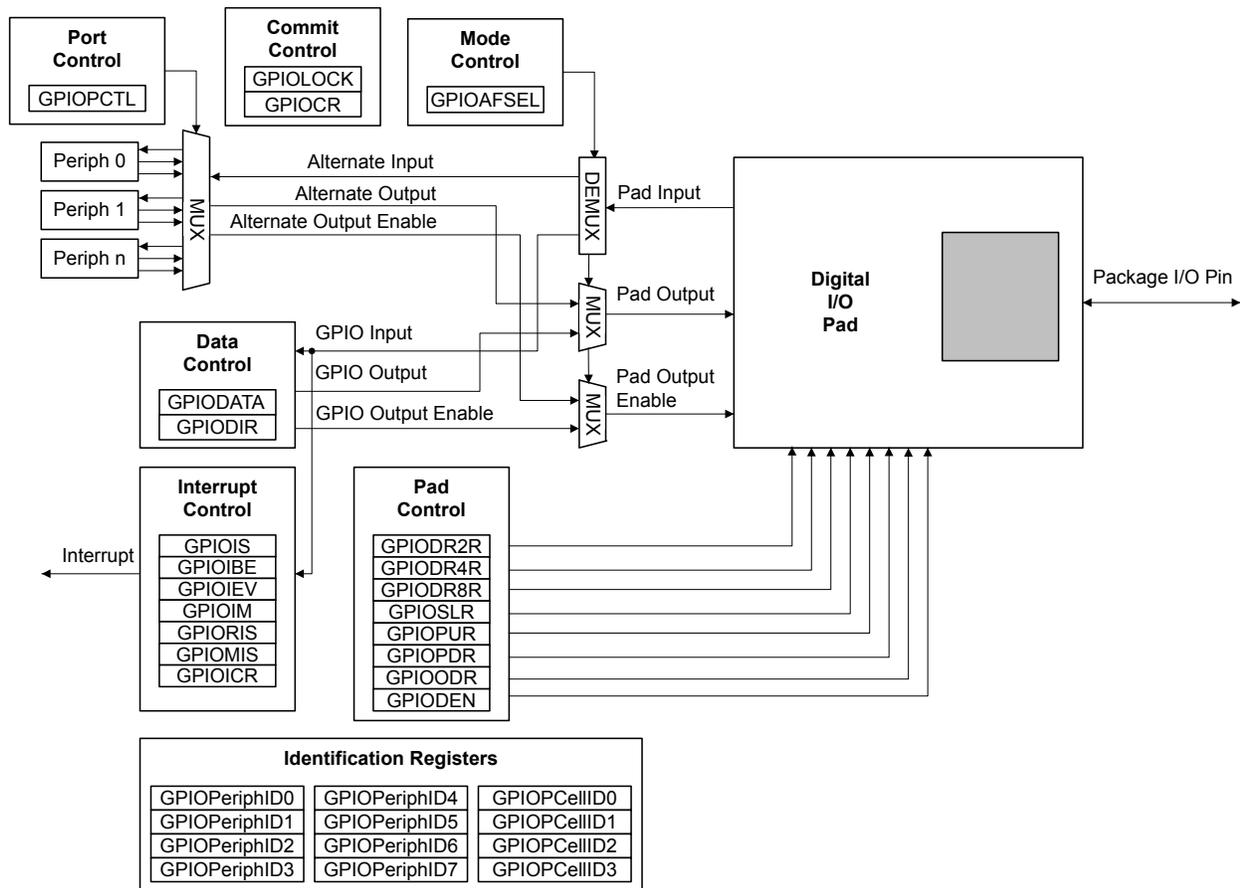
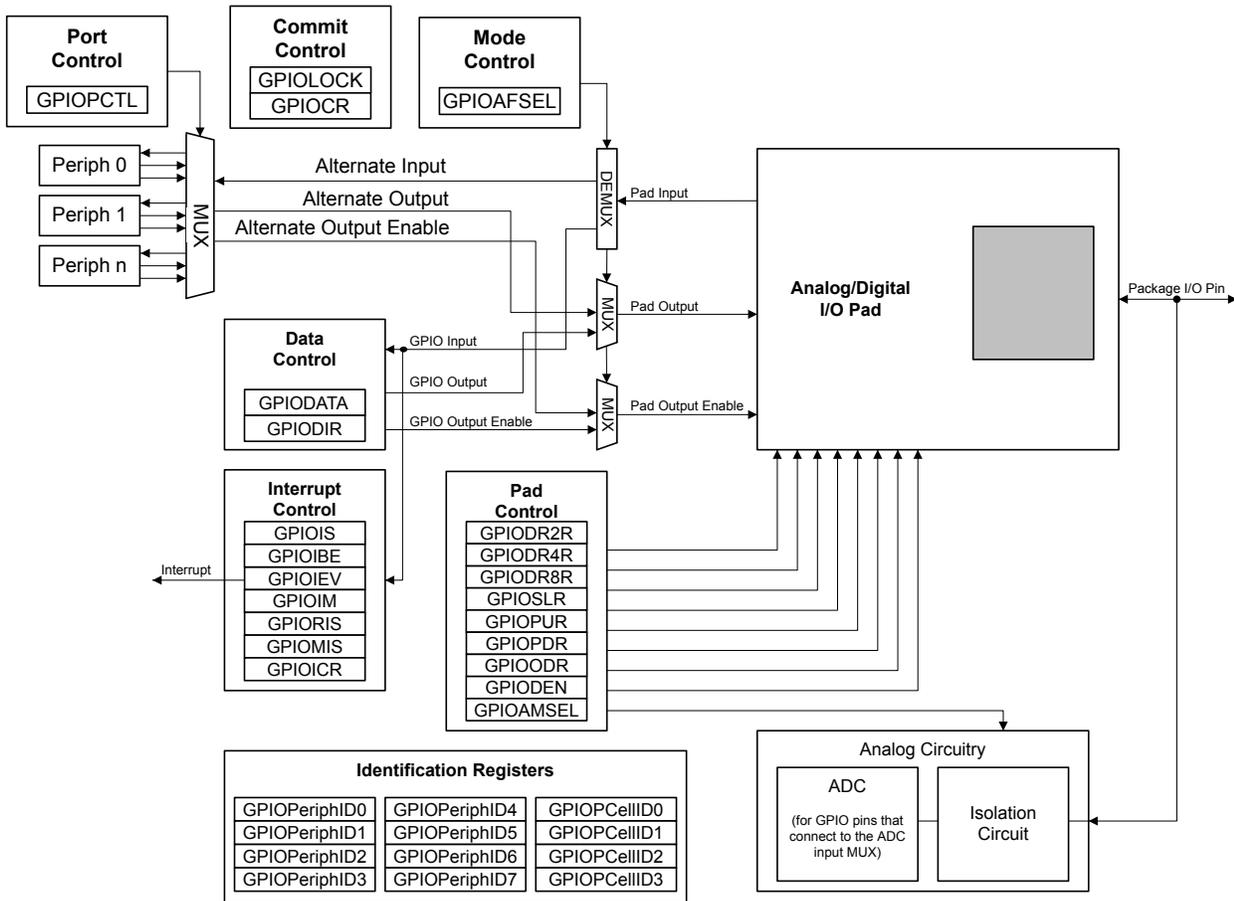


Figure 9-2. Analog/Digital I/O Pads



### 9.2.1 Data Control

The data control registers allow software to configure the operational modes of the GPIOs. The data direction register configures the GPIO as an input or an output while the data register either captures incoming data or drives it out to the pads.

**Caution – It is possible to create a software sequence that prevents the debugger from connecting to the Stellaris® microcontroller. If the program code loaded into flash immediately changes the JTAG pins to their GPIO functionality, the debugger may not have enough time to connect and halt the controller before the JTAG pin functionality switches. As a result, the debugger may be locked out of the part. This issue can be avoided with a software routine that restores JTAG functionality based on an external or software trigger.**

#### 9.2.1.1 Data Direction Operation

The **GPIO Direction (GPIODIR)** register (see page 319) is used to configure each individual pin as an input or output. When the data direction bit is cleared, the GPIO is configured as an input, and the corresponding data register bit captures and stores the value on the GPIO port. When the data direction bit is set, the GPIO is configured as an output, and the corresponding data register bit is driven out on the GPIO port.

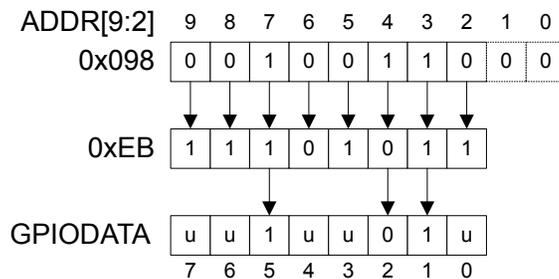
### 9.2.1.2 Data Register Operation

To aid in the efficiency of software, the GPIO ports allow for the modification of individual bits in the **GPIO Data (GPIODATA)** register (see page 318) by using bits [9:2] of the address bus as a mask. In this manner, software drivers can modify individual GPIO pins in a single instruction without affecting the state of the other pins. This method is more efficient than the conventional method of performing a read-modify-write operation to set or clear an individual GPIO pin. To implement this feature, the **GPIODATA** register covers 256 locations in the memory map.

During a write, if the address bit associated with that data bit is set, the value of the **GPIODATA** register is altered. If the address bit is cleared, the data bit is left unchanged.

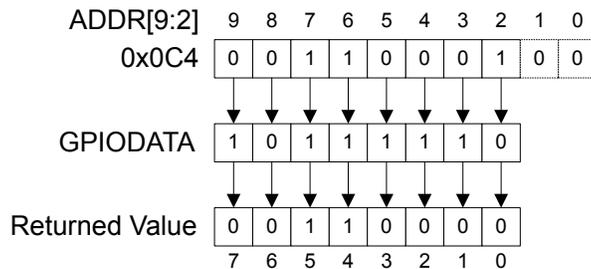
For example, writing a value of 0xEB to the address GPIODATA + 0x098 has the results shown in Figure 9-3, where u indicates that data is unchanged by the write.

**Figure 9-3. GPIODATA Write Example**



During a read, if the address bit associated with the data bit is set, the value is read. If the address bit associated with the data bit is cleared, the data bit is read as a zero, regardless of its actual value. For example, reading address GPIODATA + 0x0C4 yields as shown in Figure 9-4.

**Figure 9-4. GPIODATA Read Example**



## 9.2.2 Interrupt Control

The interrupt capabilities of each GPIO port are controlled by a set of seven registers. These registers are used to select the source of the interrupt, its polarity, and the edge properties. When one or more GPIO inputs cause an interrupt, a single interrupt output is sent to the interrupt controller for the entire GPIO port. For edge-triggered interrupts, software must clear the interrupt to enable any further interrupts. For a level-sensitive interrupt, the external source must hold the level constant for the interrupt to be recognized by the controller.

Three registers define the edge or sense that causes interrupts:

- **GPIO Interrupt Sense (GPIOIS)** register (see page 320)

- **GPIO Interrupt Both Edges (GPIOIBE)** register (see page 321)
- **GPIO Interrupt Event (GPIOIEV)** register (see page 322)

Interrupts are enabled/disabled via the **GPIO Interrupt Mask (GPIOIM)** register (see page 323).

When an interrupt condition occurs, the state of the interrupt signal can be viewed in two locations: the **GPIO Raw Interrupt Status (GPIORIS)** and **GPIO Masked Interrupt Status (GPIOMIS)** registers (see page 324 and page 325). As the name implies, the **GPIOMIS** register only shows interrupt conditions that are allowed to be passed to the interrupt controller. The **GPIORIS** register indicates that a GPIO pin meets the conditions for an interrupt, but has not necessarily been sent to the interrupt controller.

In addition to providing GPIO functionality,  $PB4$  can also be used as an external trigger for the ADC. If  $PB4$  is configured as a non-masked interrupt pin (the appropriate bit of **GPIOIM** is set), an interrupt for Port B is generated, and an external trigger signal is sent to the ADC. If the **ADC Event Multiplexer Select (ADCEMUX)** register is configured to use the external trigger, an ADC conversion is initiated. See page 537.

If no other Port B pins are being used to generate interrupts, the ARM Integrated Nested Vectored Interrupt Controller (NVIC) Interrupt Set Enable (SETENA) register can disable the Port B interrupts, and the ADC interrupt can be used to read back the converted data. Otherwise, the Port B interrupt handler must ignore and clear interrupts on  $PB4$  and wait for the ADC interrupt, or the ADC interrupt must be disabled in the SETENA register and the Port B interrupt handler must poll the ADC registers until the conversion is completed. See the *ARM® Cortex™-M3 Technical Reference Manual* for more information.

Interrupts are cleared by writing a 1 to the appropriate bit of the **GPIO Interrupt Clear (GPIOICR)** register (see page 327).

When programming the interrupt control registers (**GPIOIS**, **GPIOIBE**, or **GPIOIEV**), the interrupts should be masked (**GPIOIM** cleared). Writing any value to an interrupt control register can generate a spurious interrupt if the corresponding bits are enabled.

### 9.2.3 Mode Control

The GPIO pins can be controlled by either software or hardware. Software control is the default for most signals and corresponds to the GPIO mode, where the **GPIO DATA** register is used to read or write the corresponding pins. When hardware control is enabled via the **GPIO Alternate Function Select (GPIOAFSEL)** register (see page 328), the pin state is controlled by its alternate function (that is, the peripheral).

Further pin muxing options are provided through the **GPIO Port Control (GPIOCTL)** register which selects one of several peripheral functions for each GPIO. For information on the configuration options, refer to Table 25-5 on page 1160.

**Note:** If any pin is to be used as an ADC input, the appropriate bit in the **GPIOAMSEL** register must be set to disable the analog isolation circuit.

### 9.2.4 Commit Control

The GPIO commit control registers provide a layer of protection against accidental programming of critical hardware peripherals. Protection is currently provided for the **NMI** pin ( $PB7$ ) and the four **JTAG/SWD** pins ( $PC[3:0]$ ). Writes to protected bits of the **GPIO Alternate Function Select (GPIOAFSEL)** register (see page 328), **GPIO Pull Up Select (GPIOPUR)** register (see page 334), **GPIO Pull-Down Select (GPIOPDR)** register (see page 336), and **GPIO Digital Enable (GPIODEN)** register (see page 339) are not committed to storage unless the **GPIO Lock (GPIOLOCK)** register



(see page 341) has been unlocked and the appropriate bits of the **GPIO Commit (GPIOCR)** register (see page 342) have been set.

### 9.2.5 Pad Control

The pad control registers allow software to configure the GPIO pads based on the application requirements. The pad control registers include the **GPIODR2R**, **GPIODR4R**, **GPIODR8R**, **GPIOODR**, **GPIOPUR**, **GPIOPDR**, **GPIOSLR**, and **GIODEN** registers. These registers control drive strength, open-drain configuration, pull-up and pull-down resistors, slew-rate control and digital input enable for each GPIO.

For special high-current applications, the GPIO output buffers may be used with the following restrictions. With the GPIO pins configured as 8-mA output drivers, a total of four GPIO outputs may be used to sink current loads up to 18 mA each. At 18-mA sink current loading, the  $V_{OL}$  value is specified as 1.2 V. The high-current GPIO package pins must be selected such that there are only a maximum of two per side of the physical package or BGA pin group with the total number of high-current GPIO outputs not exceeding four for the entire package.

### 9.2.6 Identification

The identification registers configured at reset allow software to detect and identify the module as a GPIO block. The identification registers include the **GPIOPeriphID0-GPIOPeriphID7** registers as well as the **GPIOCellID0-GPIOCellID3** registers.

## 9.3 Initialization and Configuration

The GPIO modules may be accessed via two different memory apertures. The legacy aperture, the Advanced Peripheral Bus (APB), is backwards-compatible with previous Stellaris® parts. The other aperture, the Advanced High-Performance Bus (AHB), offers the same register map but provides better back-to-back access performance than the APB bus. These apertures are mutually exclusive. The aperture enabled for a given GPIO port is controlled by the appropriate bit in the **GPIOHBCTL** register (see page 135).

To use the pins in a particular GPIO port, the clock for the port must be enabled by setting the appropriate GPIO Port bit field ( $GPIO_n$ ) in the **RCGC2** register (see page 193).

On reset, all GPIO pins are configured out of reset to be undriven (tristate): **GPIOAFSEL=0**, **GIODEN=0**, **GPIOPDR=0**, and **GPIOPUR=0**, except for the pins shown in Table 9-1 on page 305. Table 9-4 on page 313 shows all possible configurations of the GPIO pads and the control register settings required to achieve them. Table 9-5 on page 314 shows how a rising edge interrupt is configured for pin 2 of a GPIO port.

**Table 9-4. GPIO Pad Configuration Examples**

Configuration	GPIO Register Bit Value <sup>a</sup>									
	AFSEL	DIR	ODR	DEN	PUR	PDR	DR2R	DR4R	DR8R	SLR
Digital Input (GPIO)	0	0	0	1	?	?	X	X	X	X
Digital Output (GPIO)	0	1	0	1	?	?	?	?	?	?
Open Drain Output (GPIO)	0	1	1	1	X	X	?	?	?	?
Open Drain Input/Output (I <sup>2</sup> C)	1	X	1	1	X	X	?	?	?	?
Digital Input (Timer CCP)	1	X	0	1	?	?	X	X	X	X

**Table 9-4. GPIO Pad Configuration Examples (continued)**

Configuration	GPIO Register Bit Value <sup>a</sup>									
	AFSEL	DIR	ODR	DEN	PUR	PDR	DR2R	DR4R	DR8R	SLR
Digital Input (QEI)	1	X	0	1	?	?	X	X	X	X
Digital Output (PWM)	1	X	0	1	?	?	?	?	?	?
Digital Output (Timer PWM)	1	X	0	1	?	?	?	?	?	?
Digital Input/Output (SSI)	1	X	0	1	?	?	?	?	?	?
Digital Input/Output (UART)	1	X	0	1	?	?	?	?	?	?
Analog Input (Comparator)	0	0	0	0	0	0	X	X	X	X
Digital Output (Comparator)	1	X	0	1	?	?	?	?	?	?

a. X=Ignored (don't care bit)

?=Can be either 0 or 1, depending on the configuration

**Table 9-5. GPIO Interrupt Configuration Example**

Register	Desired Interrupt Event Trigger	Pin 2 Bit Value <sup>a</sup>							
		7	6	5	4	3	2	1	0
GPIOIS	0=edge 1=level	X	X	X	X	X	0	X	X
GPIOIBE	0=single edge 1=both edges	X	X	X	X	X	0	X	X
GPIOIEV	0=Low level, or falling edge 1=High level, or rising edge	X	X	X	X	X	1	X	X
GPIOIM	0=masked 1=not masked	0	0	0	0	0	1	0	0

a. X=Ignored (don't care bit)

## 9.4 Register Map

Table 9-7 on page 316 lists the GPIO registers. Each GPIO port can be accessed through one of two bus apertures. The legacy aperture, the Advanced Peripheral Bus (APB), is backwards-compatible with previous Stellaris® parts. The other aperture, the Advanced High-Performance Bus (AHB), offers the same register map but provides better back-to-back access performance than the APB bus.

**Important:** The GPIO registers in this chapter are duplicated in each GPIO block; however, depending on the block, all eight bits may not be connected to a GPIO pad. In those

cases, writing to unconnected bits has no effect, and reading unconnected bits returns no meaningful data.

The offset listed is a hexadecimal increment to the register's address, relative to that GPIO port's base address:

- GPIO Port A (APB): 0x4000.4000
- GPIO Port A (AHB): 0x4005.8000
- GPIO Port B (APB): 0x4000.5000
- GPIO Port B (AHB): 0x4005.9000
- GPIO Port C (APB): 0x4000.6000
- GPIO Port C (AHB): 0x4005.A000
- GPIO Port D (APB): 0x4000.7000
- GPIO Port D (AHB): 0x4005.B000
- GPIO Port E (APB): 0x4002.4000
- GPIO Port E (AHB): 0x4005.C000
- GPIO Port F (APB): 0x4002.5000
- GPIO Port F (AHB): 0x4005.D000
- GPIO Port G (APB): 0x4002.6000
- GPIO Port G (AHB): 0x4005.E000
- GPIO Port H (APB): 0x4002.7000
- GPIO Port H (AHB): 0x4005.F000
- GPIO Port J (APB): 0x4003.D000
- GPIO Port J (AHB): 0x4006.0000

Note that each GPIO module clock must be enabled before the registers can be programmed (see page 193).

**Important:** All GPIO pins are configured as GPIOs and tri-stated by default (**GPIOASEL**=0, **GPIODEN**=0, **GPIOPDR**=0, **GPIOPUR**=0, and **GPIOPCTL**=0) with the exception of the pins shown in the table below. A Power-On-Reset ( $\overline{POR}$ ) or asserting  $\overline{RST}$  puts the pins back to their default state.

**Table 9-6. GPIO Pins With Non-Zero Reset Values**

GPIO Pins	Default State	GPIOASEL	GPIODEN	GPIOPDR	GPIOPUR	GPIOPCTL
PA[1:0]	UART0	1	1	0	0	0x1
PA[5:2]	SSI0	1	1	0	0	0x1
PB[3:2]	I <sup>2</sup> C0	1	1	0	0	0x1
PC[3:0]	JTAG/SWD	1	1	0	1	0x3

**Note:** The default register type for the **GPIOCR** register is RO for all GPIO pins with the exception of the **NMI** pin and the four JTAG/SWD pins (**PB7** and **PC[3:0]**). These five pins are currently the only GPIOs that are protected by the **GPIOCR** register. Because of this, the register type for GPIO Port B7 and GPIO Port C[3:0] is R/W.

The default reset value for the **GPIOCR** register is 0x0000.00FF for all GPIO pins, with the exception of the **NMI** pin and the four JTAG/SWD pins (**PB7** and **PC[3:0]**). To ensure that the JTAG port is not accidentally programmed as a GPIO, these four pins default to non-committable. To ensure that the **NMI** pin is not accidentally programmed as the non-maskable interrupt pin, it defaults to non-committable. Because of this, the default reset

value of **GPIOCR** for GPIO Port B is 0x0000.007F while the default reset value of GPIOCR for Port C is 0x0000.00F0.

**Table 9-7. GPIO Register Map**

Offset	Name	Type	Reset	Description	See page
0x000	GPIODATA	R/W	0x0000.0000	GPIO Data	318
0x400	GPIODIR	R/W	0x0000.0000	GPIO Direction	319
0x404	GPIOIS	R/W	0x0000.0000	GPIO Interrupt Sense	320
0x408	GPIOIBE	R/W	0x0000.0000	GPIO Interrupt Both Edges	321
0x40C	GPIOIEV	R/W	0x0000.0000	GPIO Interrupt Event	322
0x410	GPIOIM	R/W	0x0000.0000	GPIO Interrupt Mask	323
0x414	GPIORIS	RO	0x0000.0000	GPIO Raw Interrupt Status	324
0x418	GPIONIS	RO	0x0000.0000	GPIO Masked Interrupt Status	325
0x41C	GPIOICR	W1C	0x0000.0000	GPIO Interrupt Clear	327
0x420	GPIOAFSEL	R/W	-	GPIO Alternate Function Select	328
0x500	GPIODR2R	R/W	0x0000.00FF	GPIO 2-mA Drive Select	330
0x504	GPIODR4R	R/W	0x0000.0000	GPIO 4-mA Drive Select	331
0x508	GPIODR8R	R/W	0x0000.0000	GPIO 8-mA Drive Select	332
0x50C	GPIOODR	R/W	0x0000.0000	GPIO Open Drain Select	333
0x510	GPIOPUR	R/W	-	GPIO Pull-Up Select	334
0x514	GPIOPDR	R/W	0x0000.0000	GPIO Pull-Down Select	336
0x518	GPIOSLR	R/W	0x0000.0000	GPIO Slew Rate Control Select	338
0x51C	GPIODEN	R/W	-	GPIO Digital Enable	339
0x520	GPIOLOCK	R/W	0x0000.0001	GPIO Lock	341
0x524	GPIOCR	-	-	GPIO Commit	342
0x528	GPIOAMSEL	R/W	0x0000.0000	GPIO Analog Mode Select	344
0x52C	GPIOCTL	R/W	-	GPIO Port Control	346
0xFD0	GPIOPeriphID4	RO	0x0000.0000	GPIO Peripheral Identification 4	348
0xFD4	GPIOPeriphID5	RO	0x0000.0000	GPIO Peripheral Identification 5	349
0xFD8	GPIOPeriphID6	RO	0x0000.0000	GPIO Peripheral Identification 6	350
0xFDC	GPIOPeriphID7	RO	0x0000.0000	GPIO Peripheral Identification 7	351
0xFE0	GPIOPeriphID0	RO	0x0000.0061	GPIO Peripheral Identification 0	352
0xFE4	GPIOPeriphID1	RO	0x0000.0000	GPIO Peripheral Identification 1	353
0xFE8	GPIOPeriphID2	RO	0x0000.0018	GPIO Peripheral Identification 2	354
0xFEC	GPIOPeriphID3	RO	0x0000.0001	GPIO Peripheral Identification 3	355

**Table 9-7. GPIO Register Map (continued)**

Offset	Name	Type	Reset	Description	See page
0xFF0	GPIOCellID0	RO	0x0000.000D	GPIO PrimeCell Identification 0	356
0xFF4	GPIOCellID1	RO	0x0000.00F0	GPIO PrimeCell Identification 1	357
0xFF8	GPIOCellID2	RO	0x0000.0005	GPIO PrimeCell Identification 2	358
0xFFC	GPIOCellID3	RO	0x0000.00B1	GPIO PrimeCell Identification 3	359

## 9.5 Register Descriptions

The remainder of this section lists and describes the GPIO registers, in numerical order by address offset.

### Register 1: GPIO Data (GPIODATA), offset 0x000

The **GPIODATA** register is the data register. In software control mode, values written in the **GPIODATA** register are transferred onto the GPIO port pins if the respective pins have been configured as outputs through the **GPIO Direction (GPIODIR)** register (see page 319).

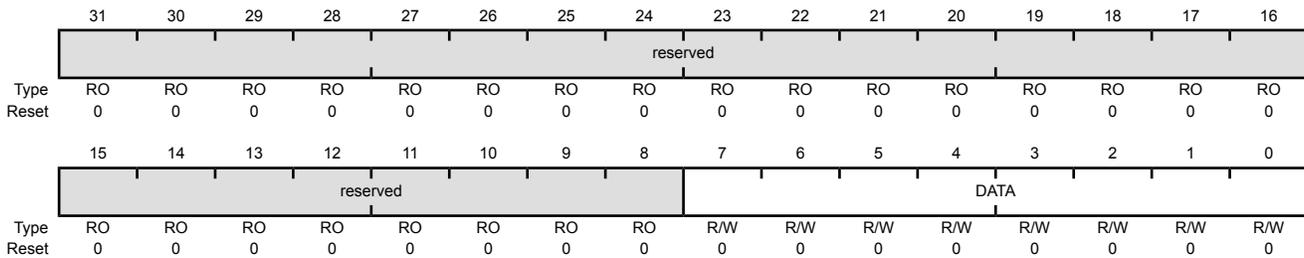
In order to write to **GPIODATA**, the corresponding bits in the mask, resulting from the address bus bits [9:2], must be set. Otherwise, the bit values remain unchanged by the write.

Similarly, the values read from this register are determined for each bit by the mask bit derived from the address used to access the data register, bits [9:2]. Bits that are set in the address mask cause the corresponding bits in **GPIODATA** to be read, and bits that are clear in the address mask cause the corresponding bits in **GPIODATA** to be read as 0, regardless of their value.

A read from **GPIODATA** returns the last bit value written if the respective pins are configured as outputs, or it returns the value on the corresponding input pin when these are configured as inputs. All bits are cleared by a reset.

#### GPIO Data (GPIODATA)

GPIO Port A (APB) base: 0x4000.4000  
 GPIO Port A (AHB) base: 0x4005.8000  
 GPIO Port B (APB) base: 0x4000.5000  
 GPIO Port B (AHB) base: 0x4005.9000  
 GPIO Port C (APB) base: 0x4000.6000  
 GPIO Port C (AHB) base: 0x4005.A000  
 GPIO Port D (APB) base: 0x4000.7000  
 GPIO Port D (AHB) base: 0x4005.B000  
 GPIO Port E (APB) base: 0x4002.4000  
 GPIO Port E (AHB) base: 0x4005.C000  
 GPIO Port F (APB) base: 0x4002.5000  
 GPIO Port F (AHB) base: 0x4005.D000  
 GPIO Port G (APB) base: 0x4002.6000  
 GPIO Port G (AHB) base: 0x4005.E000  
 GPIO Port H (APB) base: 0x4002.7000  
 GPIO Port H (AHB) base: 0x4005.F000  
 GPIO Port J (APB) base: 0x4003.D000  
 GPIO Port J (AHB) base: 0x4006.0000  
 Offset 0x000  
 Type R/W, reset 0x0000.0000



Bit/Field	Name	Type	Reset	Description
31:8	reserved	RO	0x0000.00	Software should not rely on the value of a reserved bit. To provide compatibility with future products, the value of a reserved bit should be preserved across a read-modify-write operation.
7:0	DATA	R/W	0x00	GPIO Data

This register is virtually mapped to 256 locations in the address space. To facilitate the reading and writing of data to these registers by independent drivers, the data read from and written to the registers are masked by the eight address lines [9:2]. Reads from this register return its current state. Writes to this register only affect bits that are not masked by ADDR[9:2] and are configured as outputs. See “Data Register Operation” on page 311 for examples of reads and writes.

## Register 2: GPIO Direction (GPIODIR), offset 0x400

The **GPIODIR** register is the data direction register. Setting a bit in the **GPIODIR** register configures the corresponding pin to be an output, while clearing a bit configures the corresponding pin to be an input. All bits are cleared by a reset, meaning all GPIO pins are inputs by default.

### GPIO Direction (GPIODIR)

GPIO Port A (APB) base: 0x4000.4000  
 GPIO Port A (AHB) base: 0x4005.8000  
 GPIO Port B (APB) base: 0x4000.5000  
 GPIO Port B (AHB) base: 0x4005.9000  
 GPIO Port C (APB) base: 0x4000.6000  
 GPIO Port C (AHB) base: 0x4005.A000  
 GPIO Port D (APB) base: 0x4000.7000  
 GPIO Port D (AHB) base: 0x4005.B000  
 GPIO Port E (APB) base: 0x4002.4000  
 GPIO Port E (AHB) base: 0x4005.C000  
 GPIO Port F (APB) base: 0x4002.5000  
 GPIO Port F (AHB) base: 0x4005.D000  
 GPIO Port G (APB) base: 0x4002.6000  
 GPIO Port G (AHB) base: 0x4005.E000  
 GPIO Port H (APB) base: 0x4002.7000  
 GPIO Port H (AHB) base: 0x4005.F000  
 GPIO Port J (APB) base: 0x4003.D000  
 GPIO Port J (AHB) base: 0x4006.0000  
 Offset 0x400  
 Type R/W, reset 0x0000.0000

	31	30	29	28	27	26	25	24	23	22	21	20	19	18	17	16
	reserved															
Type	RO	RO	RO	RO	RO	RO	RO	RO	RO	RO	RO	RO	RO	RO	RO	RO
Reset	0	0	0	0	0	0	0	0	0	0	0	0	0	0	0	0
	15	14	13	12	11	10	9	8	7	6	5	4	3	2	1	0
	reserved								DIR							
Type	RO	RO	RO	RO	RO	RO	RO	RO	R/W	R/W	R/W	R/W	R/W	R/W	R/W	R/W
Reset	0	0	0	0	0	0	0	0	0	0	0	0	0	0	0	0

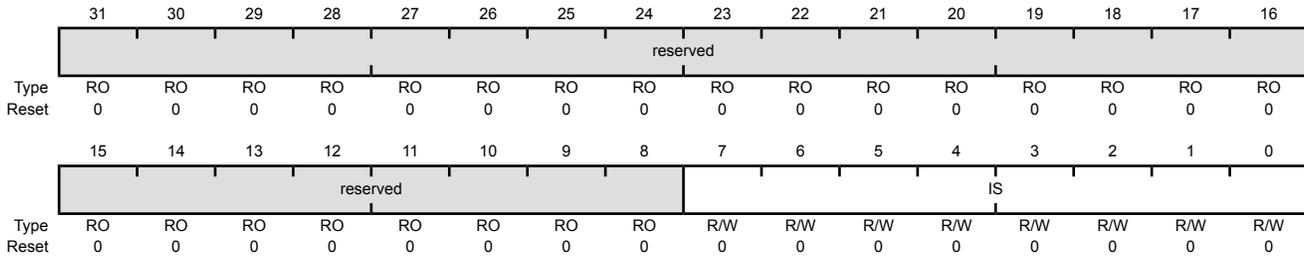
Bit/Field	Name	Type	Reset	Description
31:8	reserved	RO	0x0000.00	Software should not rely on the value of a reserved bit. To provide compatibility with future products, the value of a reserved bit should be preserved across a read-modify-write operation.
7:0	DIR	R/W	0x00	GPIO Data Direction
				Value Description
				0 Corresponding pin is an input.
				1 Corresponding pins is an output.

### Register 3: GPIO Interrupt Sense (GPIOIS), offset 0x404

The **GPIOIS** register is the interrupt sense register. Setting a bit in the **GPIOIS** register configures the corresponding pin to detect levels, while clearing a bit configures the corresponding pin to detect edges. All bits are cleared by a reset.

#### GPIO Interrupt Sense (GPIOIS)

GPIO Port A (APB) base: 0x4000.4000  
 GPIO Port A (AHB) base: 0x4005.8000  
 GPIO Port B (APB) base: 0x4000.5000  
 GPIO Port B (AHB) base: 0x4005.9000  
 GPIO Port C (APB) base: 0x4000.6000  
 GPIO Port C (AHB) base: 0x4005.A000  
 GPIO Port D (APB) base: 0x4000.7000  
 GPIO Port D (AHB) base: 0x4005.B000  
 GPIO Port E (APB) base: 0x4002.4000  
 GPIO Port E (AHB) base: 0x4005.C000  
 GPIO Port F (APB) base: 0x4002.5000  
 GPIO Port F (AHB) base: 0x4005.D000  
 GPIO Port G (APB) base: 0x4002.6000  
 GPIO Port G (AHB) base: 0x4005.E000  
 GPIO Port H (APB) base: 0x4002.7000  
 GPIO Port H (AHB) base: 0x4005.F000  
 GPIO Port J (APB) base: 0x4003.D000  
 GPIO Port J (AHB) base: 0x4006.0000  
 Offset 0x404  
 Type R/W, reset 0x0000.0000



Bit/Field	Name	Type	Reset	Description	
31:8	reserved	RO	0x0000.00	Software should not rely on the value of a reserved bit. To provide compatibility with future products, the value of a reserved bit should be preserved across a read-modify-write operation.	
7:0	IS	R/W	0x00	GPIO Interrupt Sense	
Value Description					
	0	The edge on the corresponding pin is detected (edge-sensitive).			
	1	The level on the corresponding pin is detected (level-sensitive).			



## Register 4: GPIO Interrupt Both Edges (GPIOIBE), offset 0x408

The **GPIOIBE** register allows both edges to cause interrupts. When the corresponding bit in the **GPIO Interrupt Sense (GPIOIS)** register (see page 320) is set to detect edges, setting a bit in the **GPIOIBE** register configures the corresponding pin to detect both rising and falling edges, regardless of the corresponding bit in the **GPIO Interrupt Event (GPIOIEV)** register (see page 322). Clearing a bit configures the pin to be controlled by the **GPIOIEV** register. All bits are cleared by a reset.

### GPIO Interrupt Both Edges (GPIOIBE)

GPIO Port A (APB) base: 0x4000.4000  
 GPIO Port A (AHB) base: 0x4005.8000  
 GPIO Port B (APB) base: 0x4000.5000  
 GPIO Port B (AHB) base: 0x4005.9000  
 GPIO Port C (APB) base: 0x4000.6000  
 GPIO Port C (AHB) base: 0x4005.A000  
 GPIO Port D (APB) base: 0x4000.7000  
 GPIO Port D (AHB) base: 0x4005.B000  
 GPIO Port E (APB) base: 0x4002.4000  
 GPIO Port E (AHB) base: 0x4005.C000  
 GPIO Port F (APB) base: 0x4002.5000  
 GPIO Port F (AHB) base: 0x4005.D000  
 GPIO Port G (APB) base: 0x4002.6000  
 GPIO Port G (AHB) base: 0x4005.E000  
 GPIO Port H (APB) base: 0x4002.7000  
 GPIO Port H (AHB) base: 0x4005.F000  
 GPIO Port J (APB) base: 0x4003.D000  
 GPIO Port J (AHB) base: 0x4006.0000  
 Offset 0x408  
 Type R/W, reset 0x0000.0000

	31	30	29	28	27	26	25	24	23	22	21	20	19	18	17	16
	reserved															
Type	RO	RO	RO	RO	RO	RO	RO	RO	RO	RO	RO	RO	RO	RO	RO	RO
Reset	0	0	0	0	0	0	0	0	0	0	0	0	0	0	0	0
	15	14	13	12	11	10	9	8	7	6	5	4	3	2	1	0
	reserved								IBE							
Type	RO	RO	RO	RO	RO	RO	RO	RO	R/W	R/W	R/W	R/W	R/W	R/W	R/W	R/W
Reset	0	0	0	0	0	0	0	0	0	0	0	0	0	0	0	0

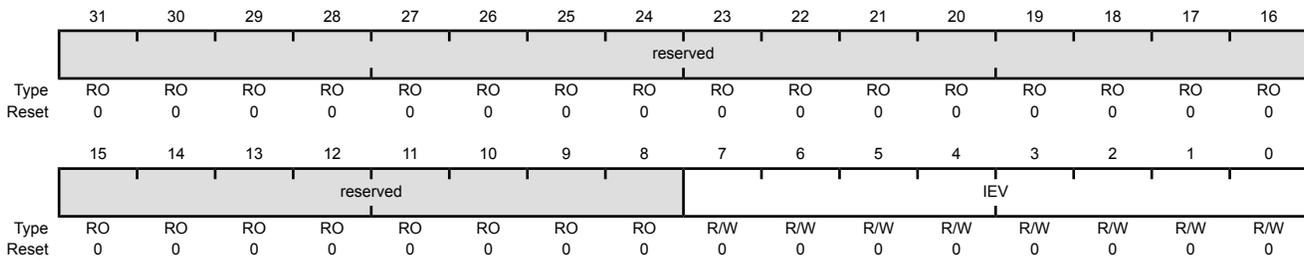
Bit/Field	Name	Type	Reset	Description
31:8	reserved	RO	0x0000.00	Software should not rely on the value of a reserved bit. To provide compatibility with future products, the value of a reserved bit should be preserved across a read-modify-write operation.
7:0	IBE	R/W	0x00	GPIO Interrupt Both Edges
				Value Description
				0 Interrupt generation is controlled by the <b>GPIO Interrupt Event (GPIOIEV)</b> register (see page 322).
				1 Both edges on the corresponding pin trigger an interrupt.

### Register 5: GPIO Interrupt Event (GPIOIEV), offset 0x40C

The **GPIOIEV** register is the interrupt event register. Setting a bit in the **GPIOIEV** register configures the corresponding pin to detect rising edges or high levels, depending on the corresponding bit value in the **GPIO Interrupt Sense (GPIOIS)** register (see page 320). Clearing a bit configures the pin to detect falling edges or low levels, depending on the corresponding bit value in the **GPIOIS** register. All bits are cleared by a reset.

#### GPIO Interrupt Event (GPIOIEV)

GPIO Port A (APB) base: 0x4000.4000  
 GPIO Port A (AHB) base: 0x4005.8000  
 GPIO Port B (APB) base: 0x4000.5000  
 GPIO Port B (AHB) base: 0x4005.9000  
 GPIO Port C (APB) base: 0x4000.6000  
 GPIO Port C (AHB) base: 0x4005.A000  
 GPIO Port D (APB) base: 0x4000.7000  
 GPIO Port D (AHB) base: 0x4005.B000  
 GPIO Port E (APB) base: 0x4002.4000  
 GPIO Port E (AHB) base: 0x4005.C000  
 GPIO Port F (APB) base: 0x4002.5000  
 GPIO Port F (AHB) base: 0x4005.D000  
 GPIO Port G (APB) base: 0x4002.6000  
 GPIO Port G (AHB) base: 0x4005.E000  
 GPIO Port H (APB) base: 0x4002.7000  
 GPIO Port H (AHB) base: 0x4005.F000  
 GPIO Port J (APB) base: 0x4003.D000  
 GPIO Port J (AHB) base: 0x4006.0000  
 Offset 0x40C  
 Type R/W, reset 0x0000.0000



Bit/Field	Name	Type	Reset	Description
31:8	reserved	RO	0x0000.00	Software should not rely on the value of a reserved bit. To provide compatibility with future products, the value of a reserved bit should be preserved across a read-modify-write operation.
7:0	IEV	R/W	0x00	GPIO Interrupt Event
				Value Description
				0 A falling edge or a Low level on the corresponding pin triggers an interrupt.
				1 A rising edge or a High level on the corresponding pin triggers an interrupt.

## Register 6: GPIO Interrupt Mask (GPIOIM), offset 0x410

The **GPIOIM** register is the interrupt mask register. Setting a bit in the **GPIOIM** register allows interrupts that are generated by the corresponding pin to be sent to the interrupt controller on the combined interrupt signal. Clearing a bit prevents an interrupt on the corresponding pin from being sent to the interrupt controller. All bits are cleared by a reset.

### GPIO Interrupt Mask (GPIOIM)

GPIO Port A (APB) base: 0x4000.4000  
 GPIO Port A (AHB) base: 0x4005.8000  
 GPIO Port B (APB) base: 0x4000.5000  
 GPIO Port B (AHB) base: 0x4005.9000  
 GPIO Port C (APB) base: 0x4000.6000  
 GPIO Port C (AHB) base: 0x4005.A000  
 GPIO Port D (APB) base: 0x4000.7000  
 GPIO Port D (AHB) base: 0x4005.B000  
 GPIO Port E (APB) base: 0x4002.4000  
 GPIO Port E (AHB) base: 0x4005.C000  
 GPIO Port F (APB) base: 0x4002.5000  
 GPIO Port F (AHB) base: 0x4005.D000  
 GPIO Port G (APB) base: 0x4002.6000  
 GPIO Port G (AHB) base: 0x4005.E000  
 GPIO Port H (APB) base: 0x4002.7000  
 GPIO Port H (AHB) base: 0x4005.F000  
 GPIO Port J (APB) base: 0x4003.D000  
 GPIO Port J (AHB) base: 0x4006.0000  
 Offset 0x410  
 Type R/W, reset 0x0000.0000

	31	30	29	28	27	26	25	24	23	22	21	20	19	18	17	16
	reserved															
Type	RO	RO	RO	RO	RO	RO	RO	RO	RO	RO	RO	RO	RO	RO	RO	RO
Reset	0	0	0	0	0	0	0	0	0	0	0	0	0	0	0	0
	15	14	13	12	11	10	9	8	7	6	5	4	3	2	1	0
	reserved								IME							
Type	RO	RO	RO	RO	RO	RO	RO	RO	R/W	R/W	R/W	R/W	R/W	R/W	R/W	R/W
Reset	0	0	0	0	0	0	0	0	0	0	0	0	0	0	0	0

Bit/Field	Name	Type	Reset	Description
31:8	reserved	RO	0x0000.00	Software should not rely on the value of a reserved bit. To provide compatibility with future products, the value of a reserved bit should be preserved across a read-modify-write operation.
7:0	IME	R/W	0x00	GPIO Interrupt Mask Enable

#### Value Description

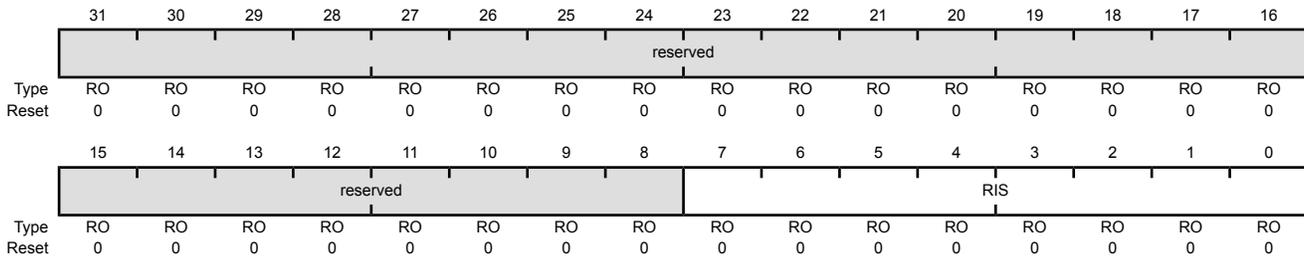
Value	Description
0	The interrupt from the corresponding pin is masked.
1	The interrupt from the corresponding pin is sent to the interrupt controller.

### Register 7: GPIO Raw Interrupt Status (GPIORIS), offset 0x414

The **GPIORIS** register is the raw interrupt status register. A bit in this register is set when an interrupt condition occurs on the corresponding GPIO pin. If the corresponding bit in the **GPIO Interrupt Mask (GPIOIM)** register (see page 323) is set, the interrupt is sent to the interrupt controller. Bits read as zero indicate that corresponding input pins have not initiated an interrupt. A bit in this register can be cleared by writing a 1 to the corresponding bit in the **GPIO Interrupt Clear (GPIOICR)** register.

#### GPIO Raw Interrupt Status (GPIORIS)

GPIO Port A (APB) base: 0x4000.4000  
 GPIO Port A (AHB) base: 0x4005.8000  
 GPIO Port B (APB) base: 0x4000.5000  
 GPIO Port B (AHB) base: 0x4005.9000  
 GPIO Port C (APB) base: 0x4000.6000  
 GPIO Port C (AHB) base: 0x4005.A000  
 GPIO Port D (APB) base: 0x4000.7000  
 GPIO Port D (AHB) base: 0x4005.B000  
 GPIO Port E (APB) base: 0x4002.4000  
 GPIO Port E (AHB) base: 0x4005.C000  
 GPIO Port F (APB) base: 0x4002.5000  
 GPIO Port F (AHB) base: 0x4005.D000  
 GPIO Port G (APB) base: 0x4002.6000  
 GPIO Port G (AHB) base: 0x4005.E000  
 GPIO Port H (APB) base: 0x4002.7000  
 GPIO Port H (AHB) base: 0x4005.F000  
 GPIO Port J (APB) base: 0x4003.D000  
 GPIO Port J (AHB) base: 0x4006.0000  
 Offset 0x414  
 Type RO, reset 0x0000.0000



Bit/Field	Name	Type	Reset	Description
31:8	reserved	RO	0x0000.00	Software should not rely on the value of a reserved bit. To provide compatibility with future products, the value of a reserved bit should be preserved across a read-modify-write operation.
7:0	RIS	RO	0x00	GPIO Interrupt Raw Status
				Value Description
				1 An interrupt condition has occurred on the corresponding pin.
				0 An interrupt condition has not occurred on the corresponding pin.
				A bit is cleared by writing a 1 to the corresponding bit in the <b>GPIOICR</b> register.

## Register 8: GPIO Masked Interrupt Status (GPIOMIS), offset 0x418

The **GPIOMIS** register is the masked interrupt status register. If a bit is set in this register, the corresponding interrupt has triggered an interrupt to the interrupt controller. If a bit is clear, either no interrupt has been generated, or the interrupt is masked.

In addition to providing GPIO functionality, **PB4** can also be used as an external trigger for the ADC. If **PB4** is configured as a non-masked interrupt pin (the appropriate bit of **GPIOIM** is set), an interrupt for Port B is generated, and an external trigger signal is sent to the ADC. If the **ADC Event Multiplexer Select (ADCEMUX)** register is configured to use the external trigger, an ADC conversion is initiated. See page 537.

If no other Port B pins are being used to generate interrupts, the ARM Integrated Nested Vectored Interrupt Controller (NVIC) Interrupt Set Enable (SETNA) register can disable the Port B interrupts, and the ADC interrupt can be used to read back the converted data. Otherwise, the Port B interrupt handler must ignore and clear interrupts on PB4 and wait for the ADC interrupt, or the ADC interrupt must be disabled in the SETNA register and the Port B interrupt handler must poll the ADC registers until the conversion is completed. See the *ARM® Cortex™-M3 Technical Reference Manual* for more information.

**GPIOMIS** is the state of the interrupt after masking.

### GPIO Masked Interrupt Status (GPIOMIS)

GPIO Port A (APB) base: 0x4000.4000  
 GPIO Port A (AHB) base: 0x4005.8000  
 GPIO Port B (APB) base: 0x4000.5000  
 GPIO Port B (AHB) base: 0x4005.9000  
 GPIO Port C (APB) base: 0x4000.6000  
 GPIO Port C (AHB) base: 0x4005.A000  
 GPIO Port D (APB) base: 0x4000.7000  
 GPIO Port D (AHB) base: 0x4005.B000  
 GPIO Port E (APB) base: 0x4002.4000  
 GPIO Port E (AHB) base: 0x4005.C000  
 GPIO Port F (APB) base: 0x4002.5000  
 GPIO Port F (AHB) base: 0x4005.D000  
 GPIO Port G (APB) base: 0x4002.6000  
 GPIO Port G (AHB) base: 0x4005.E000  
 GPIO Port H (APB) base: 0x4002.7000  
 GPIO Port H (AHB) base: 0x4005.F000  
 GPIO Port J (APB) base: 0x4003.D000  
 GPIO Port J (AHB) base: 0x4006.0000  
 Offset 0x418  
 Type RO, reset 0x0000.0000

	31	30	29	28	27	26	25	24	23	22	21	20	19	18	17	16
	reserved															
Type	RO	RO	RO	RO	RO	RO	RO	RO	RO	RO	RO	RO	RO	RO	RO	RO
Reset	0	0	0	0	0	0	0	0	0	0	0	0	0	0	0	0
	15	14	13	12	11	10	9	8	7	6	5	4	3	2	1	0
	reserved								MIS							
Type	RO	RO	RO	RO	RO	RO	RO	RO	RO	RO	RO	RO	RO	RO	RO	RO
Reset	0	0	0	0	0	0	0	0	0	0	0	0	0	0	0	0

Bit/Field	Name	Type	Reset	Description
31:8	reserved	RO	0x0000.00	Software should not rely on the value of a reserved bit. To provide compatibility with future products, the value of a reserved bit should be preserved across a read-modify-write operation.

Bit/Field	Name	Type	Reset	Description
7:0	MIS	RO	0x00	GPIO Masked Interrupt Status
				Value Description
				1 An interrupt condition on the corresponding pin has triggered an interrupt to the interrupt controller.
				0 An interrupt condition on the corresponding pin is masked or has not occurred.
				A bit is cleared by writing a 1 to the corresponding bit in the <b>GPIOICR</b> register.

## Register 9: GPIO Interrupt Clear (GPIOICR), offset 0x41C

The **GPIOICR** register is the interrupt clear register. Writing a 1 to a bit in this register clears the corresponding interrupt bit in the **GPIOIRIS** and **GPIOMIS** registers. Writing a 0 has no effect.

### GPIO Interrupt Clear (GPIOICR)

GPIO Port A (APB) base: 0x4000.4000  
 GPIO Port A (AHB) base: 0x4005.8000  
 GPIO Port B (APB) base: 0x4000.5000  
 GPIO Port B (AHB) base: 0x4005.9000  
 GPIO Port C (APB) base: 0x4000.6000  
 GPIO Port C (AHB) base: 0x4005.A000  
 GPIO Port D (APB) base: 0x4000.7000  
 GPIO Port D (AHB) base: 0x4005.B000  
 GPIO Port E (APB) base: 0x4002.4000  
 GPIO Port E (AHB) base: 0x4005.C000  
 GPIO Port F (APB) base: 0x4002.5000  
 GPIO Port F (AHB) base: 0x4005.D000  
 GPIO Port G (APB) base: 0x4002.6000  
 GPIO Port G (AHB) base: 0x4005.E000  
 GPIO Port H (APB) base: 0x4002.7000  
 GPIO Port H (AHB) base: 0x4005.F000  
 GPIO Port J (APB) base: 0x4003.D000  
 GPIO Port J (AHB) base: 0x4006.0000  
 Offset 0x41C  
 Type W1C, reset 0x0000.0000

	31	30	29	28	27	26	25	24	23	22	21	20	19	18	17	16
	reserved															
Type	RO	RO	RO	RO	RO	RO	RO	RO	RO	RO	RO	RO	RO	RO	RO	RO
Reset	0	0	0	0	0	0	0	0	0	0	0	0	0	0	0	0
	15	14	13	12	11	10	9	8	7	6	5	4	3	2	1	0
	reserved								IC							
Type	RO	RO	RO	RO	RO	RO	RO	RO	W1C	W1C	W1C	W1C	W1C	W1C	W1C	W1C
Reset	0	0	0	0	0	0	0	0	0	0	0	0	0	0	0	0

Bit/Field	Name	Type	Reset	Description
31:8	reserved	RO	0x0000.00	Software should not rely on the value of a reserved bit. To provide compatibility with future products, the value of a reserved bit should be preserved across a read-modify-write operation.
7:0	IC	W1C	0x00	GPIO Interrupt Clear
				Value Description
				1 The corresponding interrupt is cleared.
				0 The corresponding interrupt is unaffected.

**Register 10: GPIO Alternate Function Select (GPIOAFSEL), offset 0x420**

The **GPIOAFSEL** register is the mode control select register. If a bit is clear, the pin is used as a GPIO and is controlled by the GPIO registers. Setting a bit in this register configures the corresponding GPIO line to be controlled by an associated peripheral. Several possible peripheral functions are multiplexed on each GPIO. The **GPIO Port Control (GPIOCTL)** register is used to select one of the possible functions. Table 25-5 on page 1160 details which functions are muxed on each GPIO pin. The reset value for this register is 0x0000.0000 for GPIO ports that are not listed in the table below.

**Important:** All GPIO pins are configured as GPIOs and tri-stated by default (**GPIOAFSEL**=0, **GPIODEN**=0, **GPIOPDR**=0, **GPIOPUR**=0, and **GPIOCTL**=0) with the exception of the pins shown in the table below. A Power-On-Reset ( $\overline{POR}$ ) or asserting  $\overline{RST}$  puts the pins back to their default state.

**Table 9-8. GPIO Pins With Non-Zero Reset Values**

GPIO Pins	Default State	GPIOAFSEL	GPIODEN	GPIOPDR	GPIOPUR	GPIOCTL
PA[1:0]	UART0	1	1	0	0	0x1
PA[5:2]	SSI0	1	1	0	0	0x1
PB[3:2]	I <sup>2</sup> C0	1	1	0	0	0x1
PC[3:0]	JTAG/SWD	1	1	0	1	0x3

**Caution – It is possible to create a software sequence that prevents the debugger from connecting to the Stellaris<sup>®</sup> microcontroller. If the program code loaded into flash immediately changes the JTAG pins to their GPIO functionality, the debugger may not have enough time to connect and halt the controller before the JTAG pin functionality switches. As a result, the debugger may be locked out of the part. This issue can be avoided with a software routine that restores JTAG functionality based on an external or software trigger.**

The GPIO commit control registers provide a layer of protection against accidental programming of critical hardware peripherals. Protection is currently provided for the  $\overline{NMI}$  pin ( $\overline{PB7}$ ) and the four JTAG/SWD pins ( $\overline{PC[3:0]}$ ). Writes to protected bits of the **GPIO Alternate Function Select (GPIOAFSEL)** register (see page 328), **GPIO Pull Up Select (GPIOPUR)** register (see page 334), **GPIO Pull-Down Select (GPIOPDR)** register (see page 336), and **GPIO Digital Enable (GPIODEN)** register (see page 339) are not committed to storage unless the **GPIO Lock (GPIOLOCK)** register (see page 341) has been unlocked and the appropriate bits of the **GPIO Commit (GPIOCR)** register (see page 342) have been set.

When using the I<sup>2</sup>C module, in addition to setting the **GPIOAFSEL** register bits for the I<sup>2</sup>C clock and data pins, the pins should be set to open drain using the **GPIO Open Drain Select (GPIOODR)** register (see examples in “Initialization and Configuration” on page 313).



## GPIO Alternate Function Select (GPIOAFSEL)

GPIO Port A (APB) base: 0x4000.4000  
 GPIO Port A (AHB) base: 0x4005.8000  
 GPIO Port B (APB) base: 0x4000.5000  
 GPIO Port B (AHB) base: 0x4005.9000  
 GPIO Port C (APB) base: 0x4000.6000  
 GPIO Port C (AHB) base: 0x4005.A000  
 GPIO Port D (APB) base: 0x4000.7000  
 GPIO Port D (AHB) base: 0x4005.B000  
 GPIO Port E (APB) base: 0x4002.4000  
 GPIO Port E (AHB) base: 0x4005.C000  
 GPIO Port F (APB) base: 0x4002.5000  
 GPIO Port F (AHB) base: 0x4005.D000  
 GPIO Port G (APB) base: 0x4002.6000  
 GPIO Port G (AHB) base: 0x4005.E000  
 GPIO Port H (APB) base: 0x4002.7000  
 GPIO Port H (AHB) base: 0x4005.F000  
 GPIO Port J (APB) base: 0x4003.D000  
 GPIO Port J (AHB) base: 0x4006.0000

Offset 0x420  
 Type R/W, reset -

	31	30	29	28	27	26	25	24	23	22	21	20	19	18	17	16
	reserved															
Type	RO	RO	RO	RO	RO	RO	RO	RO	RO	RO	RO	RO	RO	RO	RO	RO
Reset	0	0	0	0	0	0	0	0	0	0	0	0	0	0	0	0
	15	14	13	12	11	10	9	8	7	6	5	4	3	2	1	0
	reserved								AFSEL							
Type	RO	RO	RO	RO	RO	RO	RO	RO	R/W	R/W	R/W	R/W	R/W	R/W	R/W	R/W
Reset	0	0	0	0	0	0	0	0	-	-	-	-	-	-	-	-

Bit/Field	Name	Type	Reset	Description
31:8	reserved	RO	0x0000.00	Software should not rely on the value of a reserved bit. To provide compatibility with future products, the value of a reserved bit should be preserved across a read-modify-write operation.
7:0	AFSEL	R/W	-	GPIO Alternate Function Select

## Value Description

- |   |   |
|---|---|
| 0 | The associated pin functions as a GPIO and is controlled by the GPIO registers.                           |
| 1 | The associated pin functions as a peripheral signal and is controlled by the alternate hardware function. |

The reset value for this register is 0x0000.0000 for GPIO ports that are not listed in Table 9-1 on page 305.

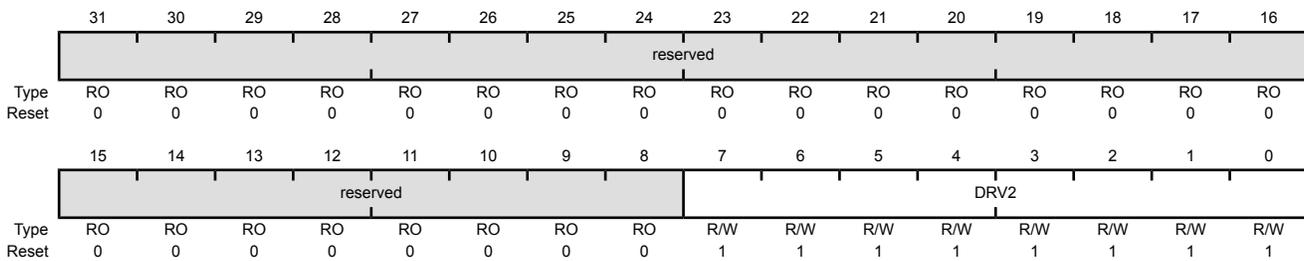
### Register 11: GPIO 2-mA Drive Select (GPIODR2R), offset 0x500

The **GPIODR2R** register is the 2-mA drive control register. Each GPIO signal in the port can be individually configured without affecting the other pads. When setting the **DRV2** bit for a GPIO signal, the corresponding **DRV4** bit in the **GPIODR4R** register and **DRV8** bit in the **GPIODR8R** register are automatically cleared by hardware. By default, all GPIO pins have 2-mA drive.

#### GPIO 2-mA Drive Select (GPIODR2R)

GPIO Port A (APB) base: 0x4000.4000  
 GPIO Port A (AHB) base: 0x4005.8000  
 GPIO Port B (APB) base: 0x4000.5000  
 GPIO Port B (AHB) base: 0x4005.9000  
 GPIO Port C (APB) base: 0x4000.6000  
 GPIO Port C (AHB) base: 0x4005.A000  
 GPIO Port D (APB) base: 0x4000.7000  
 GPIO Port D (AHB) base: 0x4005.B000  
 GPIO Port E (APB) base: 0x4002.4000  
 GPIO Port E (AHB) base: 0x4005.C000  
 GPIO Port F (APB) base: 0x4002.5000  
 GPIO Port F (AHB) base: 0x4005.D000  
 GPIO Port G (APB) base: 0x4002.6000  
 GPIO Port G (AHB) base: 0x4005.E000  
 GPIO Port H (APB) base: 0x4002.7000  
 GPIO Port H (AHB) base: 0x4005.F000  
 GPIO Port J (APB) base: 0x4003.D000  
 GPIO Port J (AHB) base: 0x4006.0000  
 Offset 0x500

Type R/W, reset 0x0000.00FF



Bit/Field	Name	Type	Reset	Description
31:8	reserved	RO	0x0000.00	Software should not rely on the value of a reserved bit. To provide compatibility with future products, the value of a reserved bit should be preserved across a read-modify-write operation.
7:0	DRV2	R/W	0xFF	Output Pad 2-mA Drive Enable

**Value Description**

- 1 The corresponding GPIO pin has 2-mA drive.
- 0 The drive for the corresponding GPIO pin is controlled by the **GPIODR4R** or **GPIODR8R** register.

Setting a bit in either the **GPIODR4** register or the **GPIODR8** register clears the corresponding 2-mA enable bit. The change is effective on the second clock cycle after the write if accessing GPIO via the APB memory aperture. If using AHB access, the change is effective on the next clock cycle.

## Register 12: GPIO 4-mA Drive Select (GPIODR4R), offset 0x504

The **GPIODR4R** register is the 4-mA drive control register. Each GPIO signal in the port can be individually configured without affecting the other pads. When setting the **DRV4** bit for a GPIO signal, the corresponding **DRV2** bit in the **GPIODR2R** register and **DRV8** bit in the **GPIODR8R** register are automatically cleared by hardware.

### GPIO 4-mA Drive Select (GPIODR4R)

GPIO Port A (APB) base: 0x4000.4000  
 GPIO Port A (AHB) base: 0x4005.8000  
 GPIO Port B (APB) base: 0x4000.5000  
 GPIO Port B (AHB) base: 0x4005.9000  
 GPIO Port C (APB) base: 0x4000.6000  
 GPIO Port C (AHB) base: 0x4005.A000  
 GPIO Port D (APB) base: 0x4000.7000  
 GPIO Port D (AHB) base: 0x4005.B000  
 GPIO Port E (APB) base: 0x4002.4000  
 GPIO Port E (AHB) base: 0x4005.C000  
 GPIO Port F (APB) base: 0x4002.5000  
 GPIO Port F (AHB) base: 0x4005.D000  
 GPIO Port G (APB) base: 0x4002.6000  
 GPIO Port G (AHB) base: 0x4005.E000  
 GPIO Port H (APB) base: 0x4002.7000  
 GPIO Port H (AHB) base: 0x4005.F000  
 GPIO Port J (APB) base: 0x4003.D000  
 GPIO Port J (AHB) base: 0x4006.0000  
 Offset 0x504

Type R/W, reset 0x0000.0000

	31	30	29	28	27	26	25	24	23	22	21	20	19	18	17	16
	reserved															
Type	RO	RO	RO	RO	RO	RO	RO	RO	RO	RO	RO	RO	RO	RO	RO	RO
Reset	0	0	0	0	0	0	0	0	0	0	0	0	0	0	0	0
	15	14	13	12	11	10	9	8	7	6	5	4	3	2	1	0
	reserved								DRV4							
Type	RO	RO	RO	RO	RO	RO	RO	RO	R/W	R/W	R/W	R/W	R/W	R/W	R/W	R/W
Reset	0	0	0	0	0	0	0	0	0	0	0	0	0	0	0	0

Bit/Field	Name	Type	Reset	Description
31:8	reserved	RO	0x0000.00	Software should not rely on the value of a reserved bit. To provide compatibility with future products, the value of a reserved bit should be preserved across a read-modify-write operation.
7:0	DRV4	R/W	0x00	Output Pad 4-mA Drive Enable

#### Value Description

Value	Description
1	The corresponding GPIO pin has 4-mA drive.
0	The drive for the corresponding GPIO pin is controlled by the <b>GPIODR2R</b> or <b>GPIODR8R</b> register.

Setting a bit in either the **GPIODR2** register or the **GPIODR8** register clears the corresponding 4-mA enable bit. The change is effective on the second clock cycle after the write if accessing GPIO via the APB memory aperture. If using AHB access, the change is effective on the next clock cycle.

### Register 13: GPIO 8-mA Drive Select (GPIODR8R), offset 0x508

The **GPIODR8R** register is the 8-mA drive control register. Each GPIO signal in the port can be individually configured without affecting the other pads. When setting the **DRV8** bit for a GPIO signal, the corresponding **DRV2** bit in the **GPIODR2R** register and **DRV4** bit in the **GPIODR4R** register are automatically cleared by hardware. The 8-mA setting is also used for high-current operation.

**Note:** There is no configuration difference between 8-mA and high-current operation. The additional current capacity results from a shift in the  $V_{OH}/V_{OL}$  levels. See “Recommended DC Operating Conditions” on page 1205 for further information.

#### GPIO 8-mA Drive Select (GPIODR8R)

GPIO Port A (APB) base: 0x4000.4000  
 GPIO Port A (AHB) base: 0x4005.8000  
 GPIO Port B (APB) base: 0x4000.5000  
 GPIO Port B (AHB) base: 0x4005.9000  
 GPIO Port C (APB) base: 0x4000.6000  
 GPIO Port C (AHB) base: 0x4005.A000  
 GPIO Port D (APB) base: 0x4000.7000  
 GPIO Port D (AHB) base: 0x4005.B000  
 GPIO Port E (APB) base: 0x4002.4000  
 GPIO Port E (AHB) base: 0x4005.C000  
 GPIO Port F (APB) base: 0x4002.5000  
 GPIO Port F (AHB) base: 0x4005.D000  
 GPIO Port G (APB) base: 0x4002.6000  
 GPIO Port G (AHB) base: 0x4005.E000  
 GPIO Port H (APB) base: 0x4002.7000  
 GPIO Port H (AHB) base: 0x4005.F000  
 GPIO Port J (APB) base: 0x4003.D000  
 GPIO Port J (AHB) base: 0x4006.0000  
 Offset 0x508  
 Type R/W, reset 0x0000.0000

	31	30	29	28	27	26	25	24	23	22	21	20	19	18	17	16
	reserved															
Type	RO	RO	RO	RO	RO	RO	RO	RO	RO	RO	RO	RO	RO	RO	RO	RO
Reset	0	0	0	0	0	0	0	0	0	0	0	0	0	0	0	0
	15	14	13	12	11	10	9	8	7	6	5	4	3	2	1	0
	reserved								DRV8							
Type	RO	RO	RO	RO	RO	RO	RO	RO	R/W	R/W	R/W	R/W	R/W	R/W	R/W	R/W
Reset	0	0	0	0	0	0	0	0	0	0	0	0	0	0	0	0

Bit/Field	Name	Type	Reset	Description
31:8	reserved	RO	0x0000.00	Software should not rely on the value of a reserved bit. To provide compatibility with future products, the value of a reserved bit should be preserved across a read-modify-write operation.
7:0	DRV8	R/W	0x00	Output Pad 8-mA Drive Enable

Value	Description
1	The corresponding GPIO pin has 8-mA drive.
0	The drive for the corresponding GPIO pin is controlled by the <b>GPIODR2R</b> or <b>GPIODR4R</b> register.

Setting a bit in either the **GPIODR2** register or the **GPIODR4** register clears the corresponding 8-mA enable bit. The change is effective on the second clock cycle after the write if accessing GPIO via the APB memory aperture. If using AHB access, the change is effective on the next clock cycle.

## Register 14: GPIO Open Drain Select (GPIOODR), offset 0x50C

The **GPIOODR** register is the open drain control register. Setting a bit in this register enables the open-drain configuration of the corresponding GPIO pad. When open-drain mode is enabled, the corresponding bit should also be set in the **GPIO Digital Input Enable (GPIODEN)** register (see page 339). Corresponding bits in the drive strength and slew rate control registers (**GPIODR2R**, **GPIODR4R**, **GPIODR8R**, and **GPIOSLR**) can be set to achieve the desired rise and fall times. The GPIO acts as an open-drain input if the corresponding bit in the **GPIODIR** register is cleared. If open drain is selected while the GPIO is configured as an input, the GPIO will remain an input and the open-drain selection has no effect until the GPIO is changed to an output.

When using the I<sup>2</sup>C module, in addition to configuring the pin to open drain, the **GPIO Alternate Function Select (GPIOAFSEL)** register bits for the I<sup>2</sup>C clock and data pins should be set (see examples in “Initialization and Configuration” on page 313).

### GPIO Open Drain Select (GPIOODR)

GPIO Port A (APB) base: 0x4000.4000  
 GPIO Port A (AHB) base: 0x4005.8000  
 GPIO Port B (APB) base: 0x4000.5000  
 GPIO Port B (AHB) base: 0x4005.9000  
 GPIO Port C (APB) base: 0x4000.6000  
 GPIO Port C (AHB) base: 0x4005.A000  
 GPIO Port D (APB) base: 0x4000.7000  
 GPIO Port D (AHB) base: 0x4005.B000  
 GPIO Port E (APB) base: 0x4002.4000  
 GPIO Port E (AHB) base: 0x4005.C000  
 GPIO Port F (APB) base: 0x4002.5000  
 GPIO Port F (AHB) base: 0x4005.D000  
 GPIO Port G (APB) base: 0x4002.6000  
 GPIO Port G (AHB) base: 0x4005.E000  
 GPIO Port H (APB) base: 0x4002.7000  
 GPIO Port H (AHB) base: 0x4005.F000  
 GPIO Port J (APB) base: 0x4003.D000  
 GPIO Port J (AHB) base: 0x4006.0000  
 Offset 0x50C  
 Type R/W, reset 0x0000.0000

	31	30	29	28	27	26	25	24	23	22	21	20	19	18	17	16
	reserved															
Type	RO	RO	RO	RO	RO	RO	RO	RO	RO	RO	RO	RO	RO	RO	RO	RO
Reset	0	0	0	0	0	0	0	0	0	0	0	0	0	0	0	0
	15	14	13	12	11	10	9	8	7	6	5	4	3	2	1	0
	reserved								ODE							
Type	RO	RO	RO	RO	RO	RO	RO	RO	R/W	R/W	R/W	R/W	R/W	R/W	R/W	R/W
Reset	0	0	0	0	0	0	0	0	0	0	0	0	0	0	0	0

Bit/Field	Name	Type	Reset	Description
31:8	reserved	RO	0x0000.00	Software should not rely on the value of a reserved bit. To provide compatibility with future products, the value of a reserved bit should be preserved across a read-modify-write operation.
7:0	ODE	R/W	0x00	Output Pad Open Drain Enable

#### Value Description

1	The corresponding pin is configured as open drain.
0	The corresponding pin is not configured as open drain.

**Register 15: GPIO Pull-Up Select (GPIOPUR), offset 0x510**

The **GPIOPUR** register is the pull-up control register. When a bit is set, a weak pull-up resistor on the corresponding GPIO signal is enabled. Setting a bit in **GPIOPUR** automatically clears the corresponding bit in the **GPIO Pull-Down Select (GPIOPDR)** register (see page 336). Write access to this register is protected with the **GPIOCR** register. Bits in **GPIOCR** that are cleared prevent writes to the equivalent bit in this register.

**Important:** All GPIO pins are configured as GPIOs and tri-stated by default (**GPIOAFSEL**=0, **GPIODEN**=0, **GPIOPDR**=0, **GPIOPUR**=0, and **GPIOCTL**=0) with the exception of the pins shown in the table below. A Power-On-Reset (**POR**) or asserting **RST** puts the pins back to their default state.

**Table 9-9. GPIO Pins With Non-Zero Reset Values**

GPIO Pins	Default State	GPIOAFSEL	GPIODEN	GPIOPDR	GPIOPUR	GPIOCTL
PA[1:0]	UART0	1	1	0	0	0x1
PA[5:2]	SSI0	1	1	0	0	0x1
PB[3:2]	I <sup>2</sup> C0	1	1	0	0	0x1
PC[3:0]	JTAG/SWD	1	1	0	1	0x3

**Note:** The GPIO commit control registers provide a layer of protection against accidental programming of critical hardware peripherals. Protection is currently provided for the **NMI** pin (**PB7**) and the four JTAG/SWD pins (**PC[3:0]**). Writes to protected bits of the **GPIO Alternate Function Select (GPIOAFSEL)** register (see page 328), **GPIO Pull Up Select (GPIOPUR)** register (see page 334), **GPIO Pull-Down Select (GPIOPDR)** register (see page 336), and **GPIO Digital Enable (GPIODEN)** register (see page 339) are not committed to storage unless the **GPIO Lock (GPIOLOCK)** register (see page 341) has been unlocked and the appropriate bits of the **GPIO Commit (GPIOCR)** register (see page 342) have been set.

## GPIO Pull-Up Select (GPIOPUR)

GPIO Port A (APB) base: 0x4000.4000  
 GPIO Port A (AHB) base: 0x4005.8000  
 GPIO Port B (APB) base: 0x4000.5000  
 GPIO Port B (AHB) base: 0x4005.9000  
 GPIO Port C (APB) base: 0x4000.6000  
 GPIO Port C (AHB) base: 0x4005.A000  
 GPIO Port D (APB) base: 0x4000.7000  
 GPIO Port D (AHB) base: 0x4005.B000  
 GPIO Port E (APB) base: 0x4002.4000  
 GPIO Port E (AHB) base: 0x4005.C000  
 GPIO Port F (APB) base: 0x4002.5000  
 GPIO Port F (AHB) base: 0x4005.D000  
 GPIO Port G (APB) base: 0x4002.6000  
 GPIO Port G (AHB) base: 0x4005.E000  
 GPIO Port H (APB) base: 0x4002.7000  
 GPIO Port H (AHB) base: 0x4005.F000  
 GPIO Port J (APB) base: 0x4003.D000  
 GPIO Port J (AHB) base: 0x4006.0000

Offset 0x510  
 Type R/W, reset -

	31	30	29	28	27	26	25	24	23	22	21	20	19	18	17	16
	reserved															
Type	RO	RO	RO	RO	RO	RO	RO	RO	RO	RO	RO	RO	RO	RO	RO	RO
Reset	0	0	0	0	0	0	0	0	0	0	0	0	0	0	0	0
	15	14	13	12	11	10	9	8	7	6	5	4	3	2	1	0
	reserved								PUE							
Type	RO	RO	RO	RO	RO	RO	RO	RO	R/W	R/W	R/W	R/W	R/W	R/W	R/W	R/W
Reset	0	0	0	0	0	0	0	0	-	-	-	-	-	-	-	-

Bit/Field	Name	Type	Reset	Description
31:8	reserved	RO	0x0000.00	Software should not rely on the value of a reserved bit. To provide compatibility with future products, the value of a reserved bit should be preserved across a read-modify-write operation.
7:0	PUE	R/W	-	Pad Weak Pull-Up Enable

## Value Description

- |   |  |
|---|--|
| 1 | The corresponding pin has a weak pull-up resistor. |
| 0 | The corresponding pin is not affected.             |

Setting a bit in the **GPIOPDR** register clears the corresponding bit in the **GPIOPUR** register. The change is effective on the second clock cycle after the write if accessing GPIO via the APB memory aperture. If using AHB access, the change is effective on the next clock cycle.

The reset value for this register is 0x0000.0000 for GPIO ports that are not listed in Table 9-1 on page 305.

### Register 16: GPIO Pull-Down Select (GPIOPDR), offset 0x514

The **GPIOPDR** register is the pull-down control register. When a bit is set, a weak pull-down resistor on the corresponding GPIO signal is enabled. Setting a bit in **GPIOPDR** automatically clears the corresponding bit in the **GPIO Pull-Up Select (GPIOPUR)** register (see page 334).

**Important:** All GPIO pins are configured as GPIOs and tri-stated by default (**GPIOAFSEL=0**, **GIODEN=0**, **GPIOPDR=0**, **GPIOPUR=0**, and **GPIOCTL=0**) with the exception of the pins shown in the table below. A Power-On-Reset (**POR**) or asserting **RST** puts the pins back to their default state.

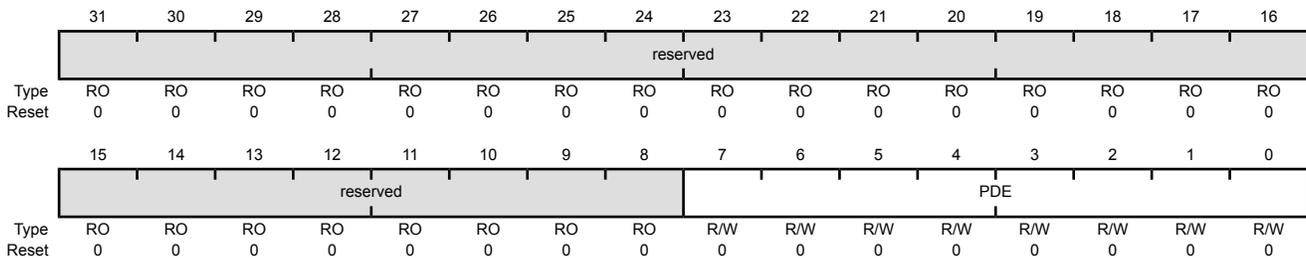
**Table 9-10. GPIO Pins With Non-Zero Reset Values**

GPIO Pins	Default State	GPIOAFSEL	GIODEN	GPIOPDR	GPIOPUR	GPIOCTL
PA[1:0]	UART0	1	1	0	0	0x1
PA[5:2]	SSI0	1	1	0	0	0x1
PB[3:2]	I <sup>2</sup> C0	1	1	0	0	0x1
PC[3:0]	JTAG/SWD	1	1	0	1	0x3

**Note:** The GPIO commit control registers provide a layer of protection against accidental programming of critical hardware peripherals. Protection is currently provided for the **NMI** pin (**PB7**) and the four **JTAG/SWD** pins (**PC[3:0]**). Writes to protected bits of the **GPIO Alternate Function Select (GPIOAFSEL)** register (see page 328), **GPIO Pull Up Select (GPIOPUR)** register (see page 334), **GPIO Pull-Down Select (GPIOPDR)** register (see page 336), and **GPIO Digital Enable (GIODEN)** register (see page 339) are not committed to storage unless the **GPIO Lock (GPIOLOCK)** register (see page 341) has been unlocked and the appropriate bits of the **GPIO Commit (GPIOCR)** register (see page 342) have been set.

#### GPIO Pull-Down Select (GPIOPDR)

GPIO Port A (APB) base: 0x4000.4000  
 GPIO Port A (AHB) base: 0x4005.8000  
 GPIO Port B (APB) base: 0x4000.5000  
 GPIO Port B (AHB) base: 0x4005.9000  
 GPIO Port C (APB) base: 0x4000.6000  
 GPIO Port C (AHB) base: 0x4005.A000  
 GPIO Port D (APB) base: 0x4000.7000  
 GPIO Port D (AHB) base: 0x4005.B000  
 GPIO Port E (APB) base: 0x4002.4000  
 GPIO Port E (AHB) base: 0x4005.C000  
 GPIO Port F (APB) base: 0x4002.5000  
 GPIO Port F (AHB) base: 0x4005.D000  
 GPIO Port G (APB) base: 0x4002.6000  
 GPIO Port G (AHB) base: 0x4005.E000  
 GPIO Port H (APB) base: 0x4002.7000  
 GPIO Port H (AHB) base: 0x4005.F000  
 GPIO Port J (APB) base: 0x4003.D000  
 GPIO Port J (AHB) base: 0x4006.0000  
 Offset 0x514  
 Type R/W, reset 0x0000.0000





---

Bit/Field	Name	Type	Reset	Description
31:8	reserved	RO	0x0000.00	Software should not rely on the value of a reserved bit. To provide compatibility with future products, the value of a reserved bit should be preserved across a read-modify-write operation.

7:0	PDE	R/W	0x00	Pad Weak Pull-Down Enable
-----	-----	-----	------	---------------------------

Value Description

1 The corresponding pin has a weak pull-down resistor.

0 The corresponding pin is not affected.

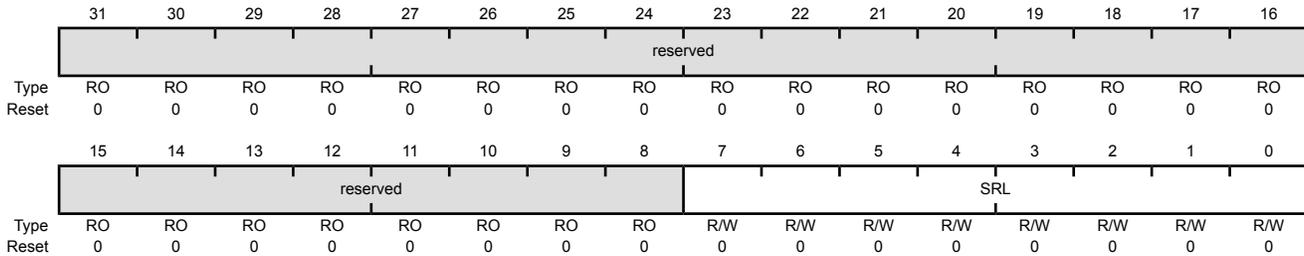
Setting a bit in the **GPIOPUR** register clears the corresponding bit in the **GPIOPDR** register. The change is effective on the second clock cycle after the write if accessing GPIO via the APB memory aperture. If using AHB access, the change is effective on the next clock cycle.

### Register 17: GPIO Slew Rate Control Select (GPIOSLR), offset 0x518

The **GPIOSLR** register is the slew rate control register. Slew rate control is only available when using the 8-mA drive strength option via the **GPIO 8-mA Drive Select (GPIODR8R)** register (see page 332).

#### GPIO Slew Rate Control Select (GPIOSLR)

GPIO Port A (APB) base: 0x4000.4000  
 GPIO Port A (AHB) base: 0x4005.8000  
 GPIO Port B (APB) base: 0x4000.5000  
 GPIO Port B (AHB) base: 0x4005.9000  
 GPIO Port C (APB) base: 0x4000.6000  
 GPIO Port C (AHB) base: 0x4005.A000  
 GPIO Port D (APB) base: 0x4000.7000  
 GPIO Port D (AHB) base: 0x4005.B000  
 GPIO Port E (APB) base: 0x4002.4000  
 GPIO Port E (AHB) base: 0x4005.C000  
 GPIO Port F (APB) base: 0x4002.5000  
 GPIO Port F (AHB) base: 0x4005.D000  
 GPIO Port G (APB) base: 0x4002.6000  
 GPIO Port G (AHB) base: 0x4005.E000  
 GPIO Port H (APB) base: 0x4002.7000  
 GPIO Port H (AHB) base: 0x4005.F000  
 GPIO Port J (APB) base: 0x4003.D000  
 GPIO Port J (AHB) base: 0x4006.0000  
 Offset 0x518  
 Type R/W, reset 0x0000.0000



Bit/Field	Name	Type	Reset	Description	
31:8	reserved	RO	0x0000.00	Software should not rely on the value of a reserved bit. To provide compatibility with future products, the value of a reserved bit should be preserved across a read-modify-write operation.	
7:0	SRL	R/W	0x00	Slew Rate Limit Enable (8-mA drive only)	
Value Description					
	1	Slew rate control is enabled for the corresponding pin.			
	0	Slew rate control is disabled for the corresponding pin.			

**Register 18: GPIO Digital Enable (GPIODEN), offset 0x51C**

**Note:** Pins configured as digital inputs are Schmitt-triggered.

The **GPIODEN** register is the digital enable register. By default, all GPIO signals except those listed below are configured out of reset to be undriven (tristate). Their digital function is disabled; they do not drive a logic value on the pin and they do not allow the pin voltage into the GPIO receiver. To use the pin as a digital input or output (either GPIO or alternate function), the corresponding **GPIODEN** bit must be set.

**Important:** All GPIO pins are configured as GPIOs and tri-stated by default (**GPIOAFSEL**=0, **GPIODEN**=0, **GPIOPDR**=0, **GPIOPUR**=0, and **GPIOPCTL**=0) with the exception of the pins shown in the table below. A Power-On-Reset ( $\overline{POR}$ ) or asserting  $\overline{RST}$  puts the pins back to their default state.

**Table 9-11. GPIO Pins With Non-Zero Reset Values**

GPIO Pins	Default State	GPIOAFSEL	GPIODEN	GPIOPDR	GPIOPUR	GPIOPCTL
PA[1:0]	UART0	1	1	0	0	0x1
PA[5:2]	SSI0	1	1	0	0	0x1
PB[3:2]	I <sup>2</sup> C0	1	1	0	0	0x1
PC[3:0]	JTAG/SWD	1	1	0	1	0x3

**Note:** The GPIO commit control registers provide a layer of protection against accidental programming of critical hardware peripherals. Protection is currently provided for the **NMI** pin (**PB7**) and the four JTAG/SWD pins (**PC[3:0]**). Writes to protected bits of the **GPIO Alternate Function Select (GPIOAFSEL)** register (see page 328), **GPIO Pull Up Select (GPIOPUR)** register (see page 334), **GPIO Pull-Down Select (GPIOPDR)** register (see page 336), and **GPIO Digital Enable (GPIODEN)** register (see page 339) are not committed to storage unless the **GPIO Lock (GPIOLOCK)** register (see page 341) has been unlocked and the appropriate bits of the **GPIO Commit (GPIOCR)** register (see page 342) have been set.

GPIO Digital Enable (GPIODEN)

GPIO Port A (APB) base: 0x4000.4000  
 GPIO Port A (AHB) base: 0x4005.8000  
 GPIO Port B (APB) base: 0x4000.5000  
 GPIO Port B (AHB) base: 0x4005.9000  
 GPIO Port C (APB) base: 0x4000.6000  
 GPIO Port C (AHB) base: 0x4005.A000  
 GPIO Port D (APB) base: 0x4000.7000  
 GPIO Port D (AHB) base: 0x4005.B000  
 GPIO Port E (APB) base: 0x4002.4000  
 GPIO Port E (AHB) base: 0x4005.C000  
 GPIO Port F (APB) base: 0x4002.5000  
 GPIO Port F (AHB) base: 0x4005.D000  
 GPIO Port G (APB) base: 0x4002.6000  
 GPIO Port G (AHB) base: 0x4005.E000  
 GPIO Port H (APB) base: 0x4002.7000  
 GPIO Port H (AHB) base: 0x4005.F000  
 GPIO Port J (APB) base: 0x4003.D000  
 GPIO Port J (AHB) base: 0x4006.0000

Offset 0x51C  
 Type R/W, reset -

	31	30	29	28	27	26	25	24	23	22	21	20	19	18	17	16
	reserved															
Type	RO	RO	RO	RO	RO	RO	RO	RO	RO	RO	RO	RO	RO	RO	RO	RO
Reset	0	0	0	0	0	0	0	0	0	0	0	0	0	0	0	0
	15	14	13	12	11	10	9	8	7	6	5	4	3	2	1	0
	reserved								DEN							
Type	RO	RO	RO	RO	RO	RO	RO	RO	R/W	R/W	R/W	R/W	R/W	R/W	R/W	R/W
Reset	0	0	0	0	0	0	0	0	-	-	-	-	-	-	-	-

Bit/Field	Name	Type	Reset	Description
31:8	reserved	RO	0x0000.00	Software should not rely on the value of a reserved bit. To provide compatibility with future products, the value of a reserved bit should be preserved across a read-modify-write operation.
7:0	DEN	R/W	-	Digital Enable

Value Description

- 0 The digital functions for the corresponding pin are disabled.
- 1 The digital functions for the corresponding pin are enabled.

The reset value for this register is 0x0000.0000 for GPIO ports that are not listed in Table 9-1 on page 305.

## Register 19: GPIO Lock (GPIOLOCK), offset 0x520

The **GPIOLOCK** register enables write access to the **GPIOCR** register (see page 342). Writing 0x4C4F.434B to the **GPIOLOCK** register unlocks the **GPIOCR** register. Writing any other value to the **GPIOLOCK** register re-enables the locked state. Reading the **GPIOLOCK** register returns the lock status rather than the 32-bit value that was previously written. Therefore, when write accesses are disabled, or locked, reading the **GPIOLOCK** register returns 0x0000.0001. When write accesses are enabled, or unlocked, reading the **GPIOLOCK** register returns 0x0000.0000.

### GPIO Lock (GPIOLOCK)

GPIO Port A (APB) base: 0x4000.4000  
 GPIO Port A (AHB) base: 0x4005.8000  
 GPIO Port B (APB) base: 0x4000.5000  
 GPIO Port B (AHB) base: 0x4005.9000  
 GPIO Port C (APB) base: 0x4000.6000  
 GPIO Port C (AHB) base: 0x4005.A000  
 GPIO Port D (APB) base: 0x4000.7000  
 GPIO Port D (AHB) base: 0x4005.B000  
 GPIO Port E (APB) base: 0x4002.4000  
 GPIO Port E (AHB) base: 0x4005.C000  
 GPIO Port F (APB) base: 0x4002.5000  
 GPIO Port F (AHB) base: 0x4005.D000  
 GPIO Port G (APB) base: 0x4002.6000  
 GPIO Port G (AHB) base: 0x4005.E000  
 GPIO Port H (APB) base: 0x4002.7000  
 GPIO Port H (AHB) base: 0x4005.F000  
 GPIO Port J (APB) base: 0x4003.D000  
 GPIO Port J (AHB) base: 0x4006.0000  
 Offset 0x520

Type R/W, reset 0x0000.0001

	31	30	29	28	27	26	25	24	23	22	21	20	19	18	17	16
	LOCK															
Type	R/W	R/W	R/W	R/W	R/W	R/W	R/W	R/W	R/W	R/W	R/W	R/W	R/W	R/W	R/W	R/W
Reset	0	0	0	0	0	0	0	0	0	0	0	0	0	0	0	0
	15	14	13	12	11	10	9	8	7	6	5	4	3	2	1	0
	LOCK															
Type	R/W	R/W	R/W	R/W	R/W	R/W	R/W	R/W	R/W	R/W	R/W	R/W	R/W	R/W	R/W	R/W
Reset	0	0	0	0	0	0	0	0	0	0	0	0	0	0	0	1

Bit/Field	Name	Type	Reset	Description
31:0	LOCK	R/W	0x0000.0001	GPIO Lock

A write of the value 0x4C4F.434B unlocks the **GPIO Commit (GPIOCR)** register for write access. A write of any other value or a write to the **GPIOCR** register reapplies the lock, preventing any register updates.

A read of this register returns the following values:

Value	Description
0x0000.0001	The <b>GPIOCR</b> register is locked and may not be modified.
0x0000.0000	The <b>GPIOCR</b> register is unlocked and may be modified.

### Register 20: GPIO Commit (GPIOCR), offset 0x524

The **GPIOCR** register is the commit register. The value of the **GPIOCR** register determines which bits of the **GPIOAFSEL**, **GPIOPUR**, **GPIOPDR**, and **GPIONEN** registers are committed when a write to these registers is performed. If a bit in the **GPIOCR** register is cleared, the data being written to the corresponding bit in the **GPIOAFSEL**, **GPIOPUR**, **GPIOPDR**, or **GPIONEN** registers cannot be committed and retains its previous value. If a bit in the **GPIOCR** register is set, the data being written to the corresponding bit of the **GPIOAFSEL**, **GPIOPUR**, **GPIOPDR**, or **GPIONEN** registers is committed to the register and reflects the new value.

The contents of the **GPIOCR** register can only be modified if the status in the **GPIOLOCK** register is unlocked. Writes to the **GPIOCR** register are ignored if the status in the **GPIOLOCK** register is locked.

**Important:** This register is designed to prevent accidental programming of the registers that control connectivity to the NMI and JTAG/SWD debug hardware. By initializing the bits of the **GPIOCR** register to 0 for **PB7** and **PC[3:0]**, the NMI and JTAG/SWD debug port can only be converted to GPIOs through a deliberate set of writes to the **GPIOLOCK**, **GPIOCR**, and the corresponding registers.

Because this protection is currently only implemented on the NMI and JTAG/SWD pins on **PB7** and **PC[3:0]**, all of the other bits in the **GPIOCR** registers cannot be written with 0x0. These bits are hardwired to 0x1, ensuring that it is always possible to commit new values to the **GPIOAFSEL**, **GPIOPUR**, **GPIOPDR**, or **GPIONEN** register bits of these other pins.

#### GPIO Commit (GPIOCR)

- GPIO Port A (APB) base: 0x4000.4000
- GPIO Port A (AHB) base: 0x4005.8000
- GPIO Port B (APB) base: 0x4000.5000
- GPIO Port B (AHB) base: 0x4005.9000
- GPIO Port C (APB) base: 0x4000.6000
- GPIO Port C (AHB) base: 0x4005.A000
- GPIO Port D (APB) base: 0x4000.7000
- GPIO Port D (AHB) base: 0x4005.B000
- GPIO Port E (APB) base: 0x4002.4000
- GPIO Port E (AHB) base: 0x4005.C000
- GPIO Port F (APB) base: 0x4002.5000
- GPIO Port F (AHB) base: 0x4005.D000
- GPIO Port G (APB) base: 0x4002.6000
- GPIO Port G (AHB) base: 0x4005.E000
- GPIO Port H (APB) base: 0x4002.7000
- GPIO Port H (AHB) base: 0x4005.F000
- GPIO Port J (APB) base: 0x4003.D000
- GPIO Port J (AHB) base: 0x4006.0000

Offset 0x524  
Type -, reset -

	31	30	29	28	27	26	25	24	23	22	21	20	19	18	17	16
	reserved															
Type	RO	RO	RO	RO	RO	RO	RO	RO	RO	RO	RO	RO	RO	RO	RO	RO
Reset	0	0	0	0	0	0	0	0	0	0	0	0	0	0	0	0
	15	14	13	12	11	10	9	8	7	6	5	4	3	2	1	0
	reserved								CR							
Type	RO	RO	RO	RO	RO	RO	RO	RO	-	-	-	-	-	-	-	-
Reset	0	0	0	0	0	0	0	0	-	-	-	-	-	-	-	-

Bit/Field	Name	Type	Reset	Description
31:8	reserved	RO	0x0000.00	Software should not rely on the value of a reserved bit. To provide compatibility with future products, the value of a reserved bit should be preserved across a read-modify-write operation.
7:0	CR	-	-	GPIO Commit
				Value Description
				1 The corresponding <b>GPIOAFSEL</b> , <b>GPIOPUR</b> , <b>GPIOPDR</b> , or <b>GIODEN</b> bits can be written.
				0 The corresponding <b>GPIOAFSEL</b> , <b>GPIOPUR</b> , <b>GPIOPDR</b> , or <b>GIODEN</b> bits cannot be written.
				<b>Note:</b> The default register type for the <b>GPIOCR</b> register is RO for all GPIO pins with the exception of the <b>NMI</b> pin and the four JTAG/SWD pins ( <b>PB7</b> and <b>PC[3:0]</b> ). These five pins are currently the only GPIOs that are protected by the <b>GPIOCR</b> register. Because of this, the register type for GPIO Port B and GPIO Port C[3:0] is R/W.
				The default reset value for the <b>GPIOCR</b> register is 0x0000.00FF for all GPIO pins, with the exception of the <b>NMI</b> pin and the four JTAG/SWD pins ( <b>PB7</b> and <b>PC[3:0]</b> ). To ensure that the JTAG port is not accidentally programmed as a GPIO, these four pins default to non-committable. To ensure that the <b>NMI</b> pin is not accidentally programmed as the non-maskable interrupt pin, it defaults to non-committable. Because of this, the default reset value of <b>GPIOCR</b> for GPIO Port B is 0x0000.007F while the default reset value of <b>GPIOCR</b> for Port C is 0x0000.00F0.

### Register 21: GPIO Analog Mode Select (GPIOAMSEL), offset 0x528

**Important:** This register is only valid for ports D and E; the corresponding base addresses for the remaining ports are not valid.

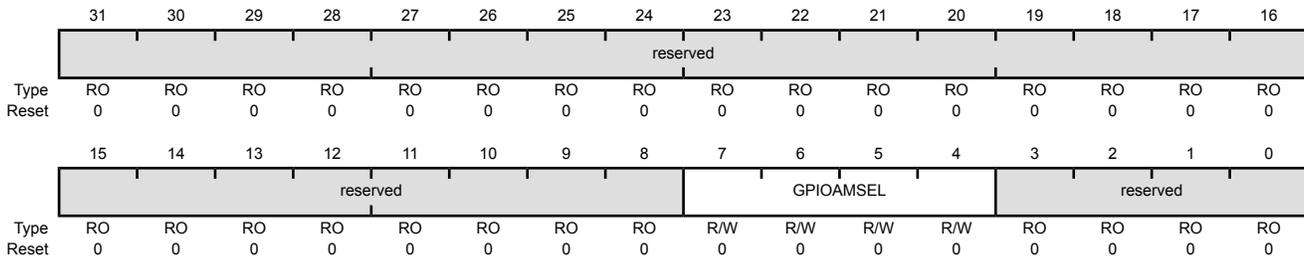
If any pin is to be used as an ADC input, the appropriate bit in **GPIOAMSEL** must be set to disable the analog isolation circuit.

The **GPIOAMSEL** register controls isolation circuits to the analog side of a unified I/O pad. Because the GPIOs may be driven by a 5-V source and affect analog operation, analog circuitry requires isolation from the pins when they are not used in their analog function.

Each bit of this register controls the isolation circuitry for the corresponding GPIO signal. For information on which GPIO pins can be used for ADC functions, refer to Table 25-5 on page 1160.

#### GPIO Analog Mode Select (GPIOAMSEL)

GPIO Port A (APB) base: 0x4000.4000  
 GPIO Port A (AHB) base: 0x4005.8000  
 GPIO Port B (APB) base: 0x4000.5000  
 GPIO Port B (AHB) base: 0x4005.9000  
 GPIO Port C (APB) base: 0x4000.6000  
 GPIO Port C (AHB) base: 0x4005.A000  
 GPIO Port D (APB) base: 0x4000.7000  
 GPIO Port D (AHB) base: 0x4005.B000  
 GPIO Port E (APB) base: 0x4002.4000  
 GPIO Port E (AHB) base: 0x4005.C000  
 GPIO Port F (APB) base: 0x4002.5000  
 GPIO Port F (AHB) base: 0x4005.D000  
 GPIO Port G (APB) base: 0x4002.6000  
 GPIO Port G (AHB) base: 0x4005.E000  
 GPIO Port H (APB) base: 0x4002.7000  
 GPIO Port H (AHB) base: 0x4005.F000  
 GPIO Port J (APB) base: 0x4003.D000  
 GPIO Port J (AHB) base: 0x4006.0000  
 Offset 0x528  
 Type R/W, reset 0x0000.0000



Bit/Field	Name	Type	Reset	Description
31:8	reserved	RO	0x0000.00	Software should not rely on the value of a reserved bit. To provide compatibility with future products, the value of a reserved bit should be preserved across a read-modify-write operation.



Bit/Field	Name	Type	Reset	Description
7:4	GPIOAMSEL	R/W	0x0	<p>GPIO Analog Mode Select</p> <p>Value Description</p> <p>1 The analog function of the pin is enabled, the isolation is disabled, and the pin is capable of analog functions.</p> <p>0 The analog function of the pin is disabled, the isolation is enabled, and the pin is capable of digital functions as specified by the other GPIO configuration registers.</p> <p><b>Note:</b> This register and bits are only valid for GPIO signals that share analog function through a unified I/O pad.</p> <p>The reset state of this register is 0 for all signals.</p>
3:0	reserved	RO	0x0	Software should not rely on the value of a reserved bit. To provide compatibility with future products, the value of a reserved bit should be preserved across a read-modify-write operation.

### Register 22: GPIO Port Control (GPIOCTL), offset 0x52C

The **GPIOCTL** register is used in conjunction with the **GPIOAFSEL** register and selects the specific peripheral signal for each GPIO pin when using the alternate function mode. Most bits in the **GPIOAFSEL** register are cleared on reset, therefore most GPIO pins are configured as GPIOs by default. When a bit is set in the **GPIOAFSEL** register, the corresponding GPIO signal is controlled by an associated peripheral. The **GPIOCTL** register selects one out of a set of peripheral functions for each GPIO, providing additional flexibility in signal definition. For information on the defined encodings for the bit fields in this register, refer to Table 25-5 on page 1160. The reset value for this register is 0x0000.0000 for GPIO ports that are not listed in the table below.

**Important:** All GPIO pins are configured as GPIOs and tri-stated by default (**GPIOAFSEL=0**, **GIODEN=0**, **GPIOPDR=0**, **GPIOPUR=0**, and **GPIOCTL=0**) with the exception of the pins shown in the table below. A Power-On-Reset ( $\overline{POR}$ ) or asserting  $\overline{RST}$  puts the pins back to their default state.

**Table 9-12. GPIO Pins With Non-Zero Reset Values**

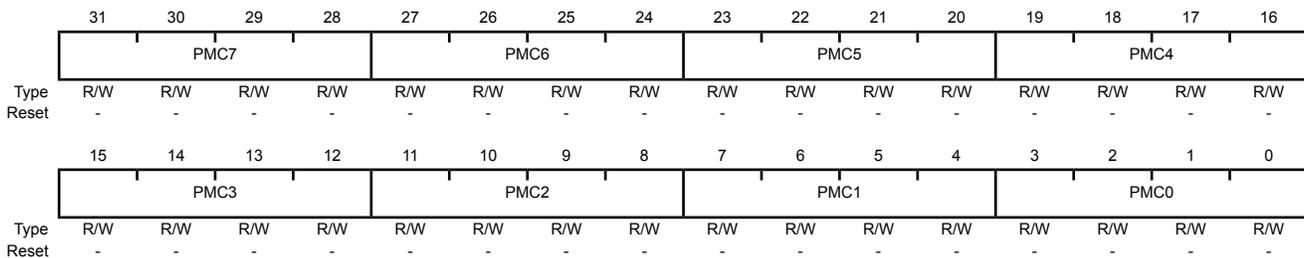
GPIO Pins	Default State	GPIOAFSEL	GIODEN	GPIOPDR	GPIOPUR	GPIOCTL
PA[1:0]	UART0	1	1	0	0	0x1
PA[5:2]	SSI0	1	1	0	0	0x1
PB[3:2]	I <sup>2</sup> C0	1	1	0	0	0x1
PC[3:0]	JTAG/SWD	1	1	0	1	0x3

#### GPIO Port Control (GPIOCTL)

GPIO Port A (APB) base: 0x4000.4000  
 GPIO Port A (AHB) base: 0x4005.8000  
 GPIO Port B (APB) base: 0x4000.5000  
 GPIO Port B (AHB) base: 0x4005.9000  
 GPIO Port C (APB) base: 0x4000.6000  
 GPIO Port C (AHB) base: 0x4005.A000  
 GPIO Port D (APB) base: 0x4000.7000  
 GPIO Port D (AHB) base: 0x4005.B000  
 GPIO Port E (APB) base: 0x4002.4000  
 GPIO Port E (AHB) base: 0x4005.C000  
 GPIO Port F (APB) base: 0x4002.5000  
 GPIO Port F (AHB) base: 0x4005.D000  
 GPIO Port G (APB) base: 0x4002.6000  
 GPIO Port G (AHB) base: 0x4005.E000  
 GPIO Port H (APB) base: 0x4002.7000  
 GPIO Port H (AHB) base: 0x4005.F000  
 GPIO Port J (APB) base: 0x4003.D000  
 GPIO Port J (AHB) base: 0x4006.0000

Offset 0x52C

Type R/W, reset -



---

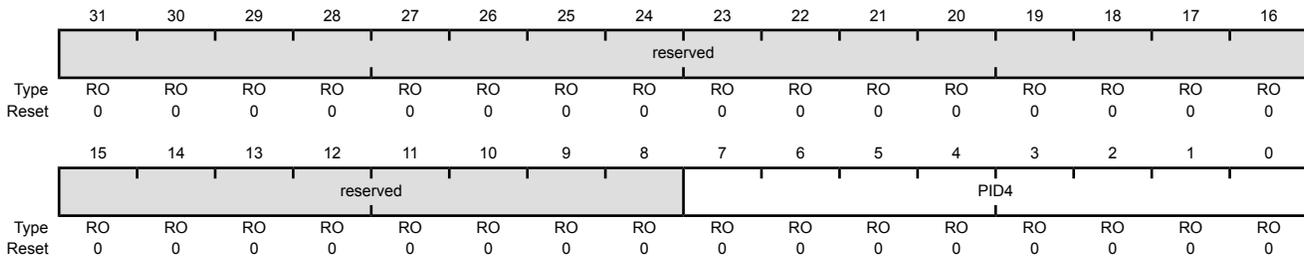
Bit/Field	Name	Type	Reset	Description
31:28	PMC7	R/W	-	Port Mux Control 7 This field controls the configuration for GPIO pin 7.
27:24	PMC6	R/W	-	Port Mux Control 6 This field controls the configuration for GPIO pin 6.
23:20	PMC5	R/W	-	Port Mux Control 5 This field controls the configuration for GPIO pin 5.
19:16	PMC4	R/W	-	Port Mux Control 4 This field controls the configuration for GPIO pin 4.
15:12	PMC3	R/W	-	Port Mux Control 3 This field controls the configuration for GPIO pin 3.
11:8	PMC2	R/W	-	Port Mux Control 2 This field controls the configuration for GPIO pin 2.
7:4	PMC1	R/W	-	Port Mux Control 1 This field controls the configuration for GPIO pin 1.
3:0	PMC0	R/W	-	Port Mux Control 0 This field controls the configuration for GPIO pin 0.

### Register 23: GPIO Peripheral Identification 4 (GPIOPeriphID4), offset 0xFD0

The **GPIOPeriphID4**, **GPIOPeriphID5**, **GPIOPeriphID6**, and **GPIOPeriphID7** registers can conceptually be treated as one 32-bit register; each register contains eight bits of the 32-bit register, used by software to identify the peripheral.

#### GPIO Peripheral Identification 4 (GPIOPeriphID4)

GPIO Port A (APB) base: 0x4000.4000  
 GPIO Port A (AHB) base: 0x4005.8000  
 GPIO Port B (APB) base: 0x4000.5000  
 GPIO Port B (AHB) base: 0x4005.9000  
 GPIO Port C (APB) base: 0x4000.6000  
 GPIO Port C (AHB) base: 0x4005.A000  
 GPIO Port D (APB) base: 0x4000.7000  
 GPIO Port D (AHB) base: 0x4005.B000  
 GPIO Port E (APB) base: 0x4002.4000  
 GPIO Port E (AHB) base: 0x4005.C000  
 GPIO Port F (APB) base: 0x4002.5000  
 GPIO Port F (AHB) base: 0x4005.D000  
 GPIO Port G (APB) base: 0x4002.6000  
 GPIO Port G (AHB) base: 0x4005.E000  
 GPIO Port H (APB) base: 0x4002.7000  
 GPIO Port H (AHB) base: 0x4005.F000  
 GPIO Port J (APB) base: 0x4003.D000  
 GPIO Port J (AHB) base: 0x4006.0000  
 Offset 0xFD0  
 Type RO, reset 0x0000.0000



Bit/Field	Name	Type	Reset	Description
31:8	reserved	RO	0x0000.00	Software should not rely on the value of a reserved bit. To provide compatibility with future products, the value of a reserved bit should be preserved across a read-modify-write operation.
7:0	PID4	RO	0x00	GPIO Peripheral ID Register [7:0]

**Register 24: GPIO Peripheral Identification 5 (GPIOPeriphID5), offset 0xFD4**

The **GPIOPeriphID4**, **GPIOPeriphID5**, **GPIOPeriphID6**, and **GPIOPeriphID7** registers can conceptually be treated as one 32-bit register; each register contains eight bits of the 32-bit register, used by software to identify the peripheral.

## GPIO Peripheral Identification 5 (GPIOPeriphID5)

GPIO Port A (APB) base: 0x4000.4000  
 GPIO Port A (AHB) base: 0x4005.8000  
 GPIO Port B (APB) base: 0x4000.5000  
 GPIO Port B (AHB) base: 0x4005.9000  
 GPIO Port C (APB) base: 0x4000.6000  
 GPIO Port C (AHB) base: 0x4005.A000  
 GPIO Port D (APB) base: 0x4000.7000  
 GPIO Port D (AHB) base: 0x4005.B000  
 GPIO Port E (APB) base: 0x4002.4000  
 GPIO Port E (AHB) base: 0x4005.C000  
 GPIO Port F (APB) base: 0x4002.5000  
 GPIO Port F (AHB) base: 0x4005.D000  
 GPIO Port G (APB) base: 0x4002.6000  
 GPIO Port G (AHB) base: 0x4005.E000  
 GPIO Port H (APB) base: 0x4002.7000  
 GPIO Port H (AHB) base: 0x4005.F000  
 GPIO Port J (APB) base: 0x4003.D000  
 GPIO Port J (AHB) base: 0x4006.0000  
 Offset 0xFD4

Type RO, reset 0x0000.0000

	31	30	29	28	27	26	25	24	23	22	21	20	19	18	17	16
	reserved															
Type	RO	RO	RO	RO	RO	RO	RO	RO	RO	RO	RO	RO	RO	RO	RO	RO
Reset	0	0	0	0	0	0	0	0	0	0	0	0	0	0	0	0
	15	14	13	12	11	10	9	8	7	6	5	4	3	2	1	0
	reserved								PID5							
Type	RO	RO	RO	RO	RO	RO	RO	RO	RO	RO	RO	RO	RO	RO	RO	RO
Reset	0	0	0	0	0	0	0	0	0	0	0	0	0	0	0	0

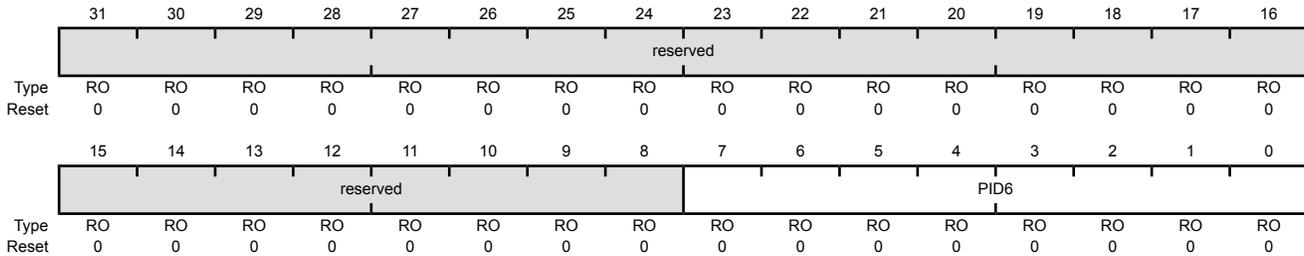
Bit/Field	Name	Type	Reset	Description
31:8	reserved	RO	0x0000.00	Software should not rely on the value of a reserved bit. To provide compatibility with future products, the value of a reserved bit should be preserved across a read-modify-write operation.
7:0	PID5	RO	0x00	GPIO Peripheral ID Register [15:8]

### Register 25: GPIO Peripheral Identification 6 (GPIOPeriphID6), offset 0xFD8

The **GPIOPeriphID4**, **GPIOPeriphID5**, **GPIOPeriphID6**, and **GPIOPeriphID7** registers can conceptually be treated as one 32-bit register; each register contains eight bits of the 32-bit register, used by software to identify the peripheral.

#### GPIO Peripheral Identification 6 (GPIOPeriphID6)

GPIO Port A (APB) base: 0x4000.4000  
 GPIO Port A (AHB) base: 0x4005.8000  
 GPIO Port B (APB) base: 0x4000.5000  
 GPIO Port B (AHB) base: 0x4005.9000  
 GPIO Port C (APB) base: 0x4000.6000  
 GPIO Port C (AHB) base: 0x4005.A000  
 GPIO Port D (APB) base: 0x4000.7000  
 GPIO Port D (AHB) base: 0x4005.B000  
 GPIO Port E (APB) base: 0x4002.4000  
 GPIO Port E (AHB) base: 0x4005.C000  
 GPIO Port F (APB) base: 0x4002.5000  
 GPIO Port F (AHB) base: 0x4005.D000  
 GPIO Port G (APB) base: 0x4002.6000  
 GPIO Port G (AHB) base: 0x4005.E000  
 GPIO Port H (APB) base: 0x4002.7000  
 GPIO Port H (AHB) base: 0x4005.F000  
 GPIO Port J (APB) base: 0x4003.D000  
 GPIO Port J (AHB) base: 0x4006.0000  
 Offset 0xFD8  
 Type RO, reset 0x0000.0000



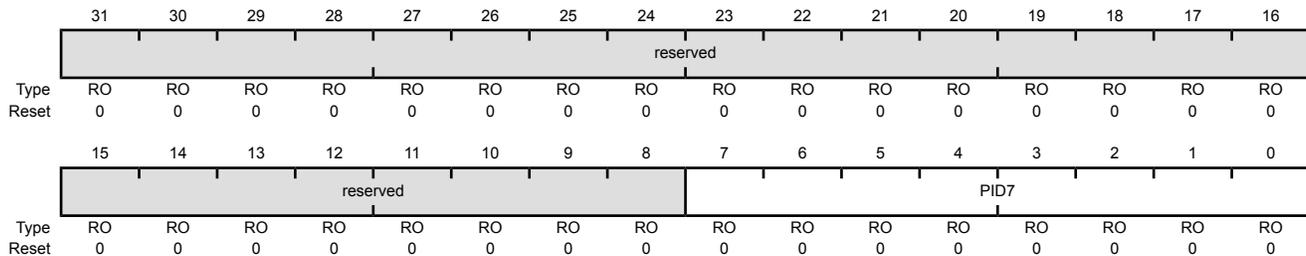
Bit/Field	Name	Type	Reset	Description
31:8	reserved	RO	0x0000.00	Software should not rely on the value of a reserved bit. To provide compatibility with future products, the value of a reserved bit should be preserved across a read-modify-write operation.
7:0	PID6	RO	0x00	GPIO Peripheral ID Register [23:16]

**Register 26: GPIO Peripheral Identification 7 (GPIOPeriphID7), offset 0xFDC**

The **GPIOPeriphID4**, **GPIOPeriphID5**, **GPIOPeriphID6**, and **GPIOPeriphID7** registers can conceptually be treated as one 32-bit register; each register contains eight bits of the 32-bit register, used by software to identify the peripheral.

## GPIO Peripheral Identification 7 (GPIOPeriphID7)

GPIO Port A (APB) base: 0x4000.4000  
 GPIO Port A (AHB) base: 0x4005.8000  
 GPIO Port B (APB) base: 0x4000.5000  
 GPIO Port B (AHB) base: 0x4005.9000  
 GPIO Port C (APB) base: 0x4000.6000  
 GPIO Port C (AHB) base: 0x4005.A000  
 GPIO Port D (APB) base: 0x4000.7000  
 GPIO Port D (AHB) base: 0x4005.B000  
 GPIO Port E (APB) base: 0x4002.4000  
 GPIO Port E (AHB) base: 0x4005.C000  
 GPIO Port F (APB) base: 0x4002.5000  
 GPIO Port F (AHB) base: 0x4005.D000  
 GPIO Port G (APB) base: 0x4002.6000  
 GPIO Port G (AHB) base: 0x4005.E000  
 GPIO Port H (APB) base: 0x4002.7000  
 GPIO Port H (AHB) base: 0x4005.F000  
 GPIO Port J (APB) base: 0x4003.D000  
 GPIO Port J (AHB) base: 0x4006.0000  
 Offset 0xFDC  
 Type RO, reset 0x0000.0000



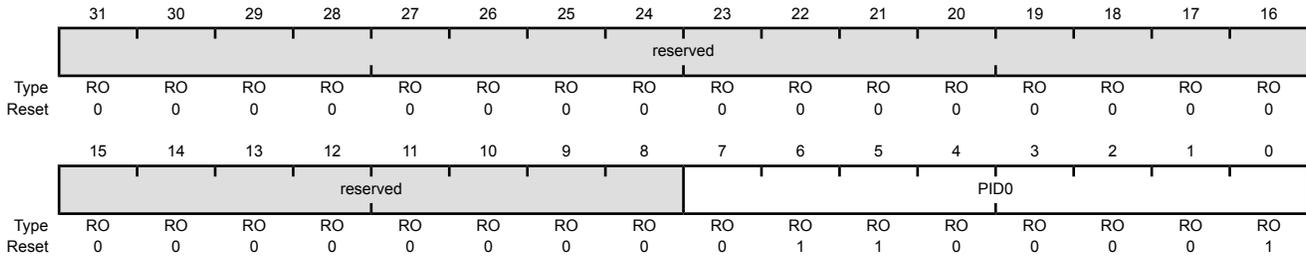
Bit/Field	Name	Type	Reset	Description
31:8	reserved	RO	0x0000.00	Software should not rely on the value of a reserved bit. To provide compatibility with future products, the value of a reserved bit should be preserved across a read-modify-write operation.
7:0	PID7	RO	0x00	GPIO Peripheral ID Register [31:24]

**Register 27: GPIO Peripheral Identification 0 (GPIOPeriphID0), offset 0xFE0**

The **GPIOPeriphID0**, **GPIOPeriphID1**, **GPIOPeriphID2**, and **GPIOPeriphID3** registers can conceptually be treated as one 32-bit register; each register contains eight bits of the 32-bit register, used by software to identify the peripheral.

GPIO Peripheral Identification 0 (GPIOPeriphID0)

GPIO Port A (APB) base: 0x4000.4000  
 GPIO Port A (AHB) base: 0x4005.8000  
 GPIO Port B (APB) base: 0x4000.5000  
 GPIO Port B (AHB) base: 0x4005.9000  
 GPIO Port C (APB) base: 0x4000.6000  
 GPIO Port C (AHB) base: 0x4005.A000  
 GPIO Port D (APB) base: 0x4000.7000  
 GPIO Port D (AHB) base: 0x4005.B000  
 GPIO Port E (APB) base: 0x4002.4000  
 GPIO Port E (AHB) base: 0x4005.C000  
 GPIO Port F (APB) base: 0x4002.5000  
 GPIO Port F (AHB) base: 0x4005.D000  
 GPIO Port G (APB) base: 0x4002.6000  
 GPIO Port G (AHB) base: 0x4005.E000  
 GPIO Port H (APB) base: 0x4002.7000  
 GPIO Port H (AHB) base: 0x4005.F000  
 GPIO Port J (APB) base: 0x4003.D000  
 GPIO Port J (AHB) base: 0x4006.0000  
 Offset 0xFE0  
 Type RO, reset 0x0000.0061



Bit/Field	Name	Type	Reset	Description
31:8	reserved	RO	0x0000.00	Software should not rely on the value of a reserved bit. To provide compatibility with future products, the value of a reserved bit should be preserved across a read-modify-write operation.
7:0	PID0	RO	0x61	GPIO Peripheral ID Register [7:0] Can be used by software to identify the presence of this peripheral.



**Register 28: GPIO Peripheral Identification 1 (GPIOPeriphID1), offset 0xFE4**

The **GPIOPeriphID0**, **GPIOPeriphID1**, **GPIOPeriphID2**, and **GPIOPeriphID3** registers can conceptually be treated as one 32-bit register; each register contains eight bits of the 32-bit register, used by software to identify the peripheral.

## GPIO Peripheral Identification 1 (GPIOPeriphID1)

GPIO Port A (APB) base: 0x4000.4000  
 GPIO Port A (AHB) base: 0x4005.8000  
 GPIO Port B (APB) base: 0x4000.5000  
 GPIO Port B (AHB) base: 0x4005.9000  
 GPIO Port C (APB) base: 0x4000.6000  
 GPIO Port C (AHB) base: 0x4005.A000  
 GPIO Port D (APB) base: 0x4000.7000  
 GPIO Port D (AHB) base: 0x4005.B000  
 GPIO Port E (APB) base: 0x4002.4000  
 GPIO Port E (AHB) base: 0x4005.C000  
 GPIO Port F (APB) base: 0x4002.5000  
 GPIO Port F (AHB) base: 0x4005.D000  
 GPIO Port G (APB) base: 0x4002.6000  
 GPIO Port G (AHB) base: 0x4005.E000  
 GPIO Port H (APB) base: 0x4002.7000  
 GPIO Port H (AHB) base: 0x4005.F000  
 GPIO Port J (APB) base: 0x4003.D000  
 GPIO Port J (AHB) base: 0x4006.0000  
 Offset 0xFE4

Type RO, reset 0x0000.0000

	31	30	29	28	27	26	25	24	23	22	21	20	19	18	17	16
	reserved															
Type	RO	RO	RO	RO	RO	RO	RO	RO	RO	RO	RO	RO	RO	RO	RO	RO
Reset	0	0	0	0	0	0	0	0	0	0	0	0	0	0	0	0
	15	14	13	12	11	10	9	8	7	6	5	4	3	2	1	0
	reserved								PID1							
Type	RO	RO	RO	RO	RO	RO	RO	RO	RO	RO	RO	RO	RO	RO	RO	RO
Reset	0	0	0	0	0	0	0	0	0	0	0	0	0	0	0	0

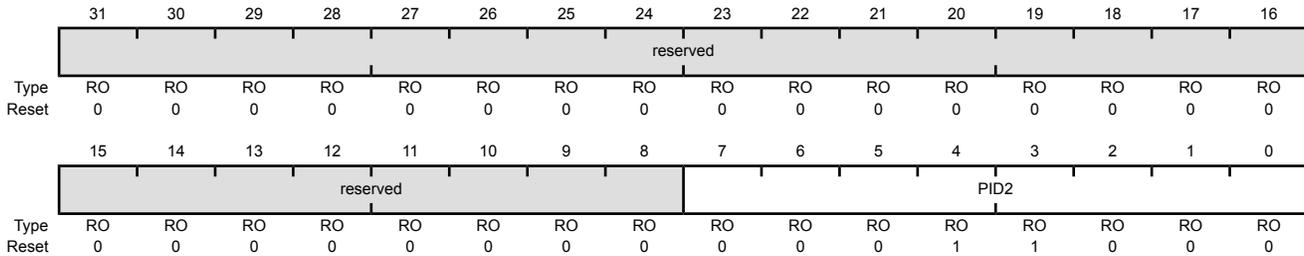
Bit/Field	Name	Type	Reset	Description
31:8	reserved	RO	0x0000.00	Software should not rely on the value of a reserved bit. To provide compatibility with future products, the value of a reserved bit should be preserved across a read-modify-write operation.
7:0	PID1	RO	0x00	GPIO Peripheral ID Register [15:8] Can be used by software to identify the presence of this peripheral.

### Register 29: GPIO Peripheral Identification 2 (GPIOPeriphID2), offset 0xFE8

The **GPIOPeriphID0**, **GPIOPeriphID1**, **GPIOPeriphID2**, and **GPIOPeriphID3** registers can conceptually be treated as one 32-bit register; each register contains eight bits of the 32-bit register, used by software to identify the peripheral.

#### GPIO Peripheral Identification 2 (GPIOPeriphID2)

GPIO Port A (APB) base: 0x4000.4000  
 GPIO Port A (AHB) base: 0x4005.8000  
 GPIO Port B (APB) base: 0x4000.5000  
 GPIO Port B (AHB) base: 0x4005.9000  
 GPIO Port C (APB) base: 0x4000.6000  
 GPIO Port C (AHB) base: 0x4005.A000  
 GPIO Port D (APB) base: 0x4000.7000  
 GPIO Port D (AHB) base: 0x4005.B000  
 GPIO Port E (APB) base: 0x4002.4000  
 GPIO Port E (AHB) base: 0x4005.C000  
 GPIO Port F (APB) base: 0x4002.5000  
 GPIO Port F (AHB) base: 0x4005.D000  
 GPIO Port G (APB) base: 0x4002.6000  
 GPIO Port G (AHB) base: 0x4005.E000  
 GPIO Port H (APB) base: 0x4002.7000  
 GPIO Port H (AHB) base: 0x4005.F000  
 GPIO Port J (APB) base: 0x4003.D000  
 GPIO Port J (AHB) base: 0x4006.0000  
 Offset 0xFE8  
 Type RO, reset 0x0000.0018



Bit/Field	Name	Type	Reset	Description
31:8	reserved	RO	0x0000.00	Software should not rely on the value of a reserved bit. To provide compatibility with future products, the value of a reserved bit should be preserved across a read-modify-write operation.
7:0	PID2	RO	0x18	GPIO Peripheral ID Register [23:16] Can be used by software to identify the presence of this peripheral.

**Register 30: GPIO Peripheral Identification 3 (GPIOPeriphID3), offset 0xFEC**

The **GPIOPeriphID0**, **GPIOPeriphID1**, **GPIOPeriphID2**, and **GPIOPeriphID3** registers can conceptually be treated as one 32-bit register; each register contains eight bits of the 32-bit register, used by software to identify the peripheral.

## GPIO Peripheral Identification 3 (GPIOPeriphID3)

GPIO Port A (APB) base: 0x4000.4000  
 GPIO Port A (AHB) base: 0x4005.8000  
 GPIO Port B (APB) base: 0x4000.5000  
 GPIO Port B (AHB) base: 0x4005.9000  
 GPIO Port C (APB) base: 0x4000.6000  
 GPIO Port C (AHB) base: 0x4005.A000  
 GPIO Port D (APB) base: 0x4000.7000  
 GPIO Port D (AHB) base: 0x4005.B000  
 GPIO Port E (APB) base: 0x4002.4000  
 GPIO Port E (AHB) base: 0x4005.C000  
 GPIO Port F (APB) base: 0x4002.5000  
 GPIO Port F (AHB) base: 0x4005.D000  
 GPIO Port G (APB) base: 0x4002.6000  
 GPIO Port G (AHB) base: 0x4005.E000  
 GPIO Port H (APB) base: 0x4002.7000  
 GPIO Port H (AHB) base: 0x4005.F000  
 GPIO Port J (APB) base: 0x4003.D000  
 GPIO Port J (AHB) base: 0x4006.0000  
 Offset 0xFEC

Type RO, reset 0x0000.0001

	31	30	29	28	27	26	25	24	23	22	21	20	19	18	17	16
	reserved															
Type	RO	RO	RO	RO	RO	RO	RO	RO	RO	RO	RO	RO	RO	RO	RO	RO
Reset	0	0	0	0	0	0	0	0	0	0	0	0	0	0	0	0
	15	14	13	12	11	10	9	8	7	6	5	4	3	2	1	0
	reserved								PID3							
Type	RO	RO	RO	RO	RO	RO	RO	RO	RO	RO	RO	RO	RO	RO	RO	RO
Reset	0	0	0	0	0	0	0	0	0	0	0	0	0	0	0	1

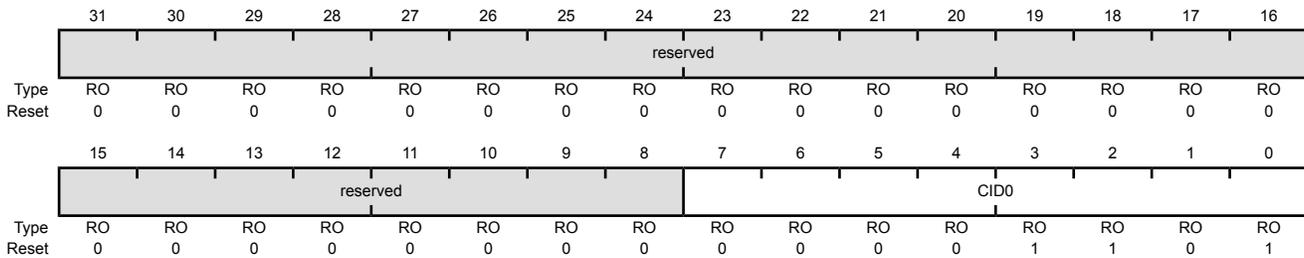
Bit/Field	Name	Type	Reset	Description
31:8	reserved	RO	0x0000.00	Software should not rely on the value of a reserved bit. To provide compatibility with future products, the value of a reserved bit should be preserved across a read-modify-write operation.
7:0	PID3	RO	0x01	GPIO Peripheral ID Register [31:24] Can be used by software to identify the presence of this peripheral.

### Register 31: GPIO PrimeCell Identification 0 (GPIOCellID0), offset 0xFF0

The **GPIOCellID0**, **GPIOCellID1**, **GPIOCellID2**, and **GPIOCellID3** registers are four 8-bit wide registers, that can conceptually be treated as one 32-bit register. The register is used as a standard cross-peripheral identification system.

#### GPIO PrimeCell Identification 0 (GPIOCellID0)

GPIO Port A (APB) base: 0x4000.4000  
 GPIO Port A (AHB) base: 0x4005.8000  
 GPIO Port B (APB) base: 0x4000.5000  
 GPIO Port B (AHB) base: 0x4005.9000  
 GPIO Port C (APB) base: 0x4000.6000  
 GPIO Port C (AHB) base: 0x4005.A000  
 GPIO Port D (APB) base: 0x4000.7000  
 GPIO Port D (AHB) base: 0x4005.B000  
 GPIO Port E (APB) base: 0x4002.4000  
 GPIO Port E (AHB) base: 0x4005.C000  
 GPIO Port F (APB) base: 0x4002.5000  
 GPIO Port F (AHB) base: 0x4005.D000  
 GPIO Port G (APB) base: 0x4002.6000  
 GPIO Port G (AHB) base: 0x4005.E000  
 GPIO Port H (APB) base: 0x4002.7000  
 GPIO Port H (AHB) base: 0x4005.F000  
 GPIO Port J (APB) base: 0x4003.D000  
 GPIO Port J (AHB) base: 0x4006.0000  
 Offset 0xFF0  
 Type RO, reset 0x0000.000D



Bit/Field	Name	Type	Reset	Description
31:8	reserved	RO	0x0000.00	Software should not rely on the value of a reserved bit. To provide compatibility with future products, the value of a reserved bit should be preserved across a read-modify-write operation.
7:0	CID0	RO	0x0D	GPIO PrimeCell ID Register [7:0] Provides software a standard cross-peripheral identification system.

**Register 32: GPIO PrimeCell Identification 1 (GPIOCellID1), offset 0xFF4**

The **GPIOCellID0**, **GPIOCellID1**, **GPIOCellID2**, and **GPIOCellID3** registers are four 8-bit wide registers, that can conceptually be treated as one 32-bit register. The register is used as a standard cross-peripheral identification system.

## GPIO PrimeCell Identification 1 (GPIOCellID1)

GPIO Port A (APB) base: 0x4000.4000  
 GPIO Port A (AHB) base: 0x4005.8000  
 GPIO Port B (APB) base: 0x4000.5000  
 GPIO Port B (AHB) base: 0x4005.9000  
 GPIO Port C (APB) base: 0x4000.6000  
 GPIO Port C (AHB) base: 0x4005.A000  
 GPIO Port D (APB) base: 0x4000.7000  
 GPIO Port D (AHB) base: 0x4005.B000  
 GPIO Port E (APB) base: 0x4002.4000  
 GPIO Port E (AHB) base: 0x4005.C000  
 GPIO Port F (APB) base: 0x4002.5000  
 GPIO Port F (AHB) base: 0x4005.D000  
 GPIO Port G (APB) base: 0x4002.6000  
 GPIO Port G (AHB) base: 0x4005.E000  
 GPIO Port H (APB) base: 0x4002.7000  
 GPIO Port H (AHB) base: 0x4005.F000  
 GPIO Port J (APB) base: 0x4003.D000  
 GPIO Port J (AHB) base: 0x4006.0000  
 Offset 0xFF4  
 Type RO, reset 0x0000.00F0

	31	30	29	28	27	26	25	24	23	22	21	20	19	18	17	16
	reserved															
Type	RO	RO	RO	RO	RO	RO	RO	RO	RO	RO	RO	RO	RO	RO	RO	RO
Reset	0	0	0	0	0	0	0	0	0	0	0	0	0	0	0	0
	15	14	13	12	11	10	9	8	7	6	5	4	3	2	1	0
	reserved								CID1							
Type	RO	RO	RO	RO	RO	RO	RO	RO	RO	RO	RO	RO	RO	RO	RO	RO
Reset	0	0	0	0	0	0	0	0	1	1	1	1	0	0	0	0

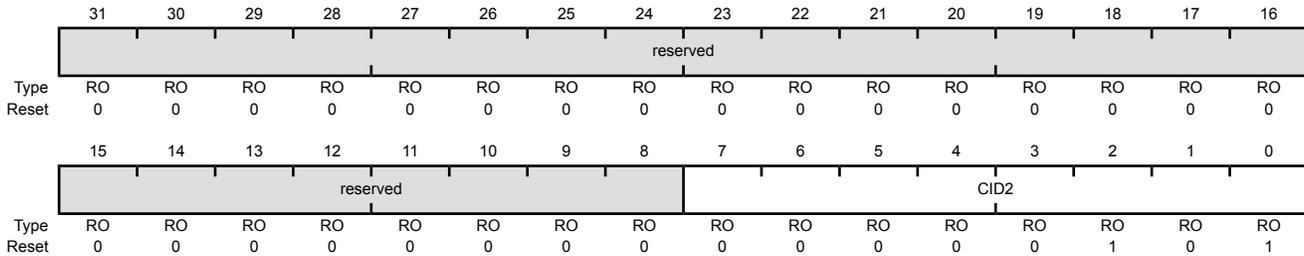
Bit/Field	Name	Type	Reset	Description
31:8	reserved	RO	0x0000.00	Software should not rely on the value of a reserved bit. To provide compatibility with future products, the value of a reserved bit should be preserved across a read-modify-write operation.
7:0	CID1	RO	0xF0	GPIO PrimeCell ID Register [15:8] Provides software a standard cross-peripheral identification system.

### Register 33: GPIO PrimeCell Identification 2 (GPIOCellID2), offset 0xFF8

The **GPIOCellID0**, **GPIOCellID1**, **GPIOCellID2**, and **GPIOCellID3** registers are four 8-bit wide registers, that can conceptually be treated as one 32-bit register. The register is used as a standard cross-peripheral identification system.

#### GPIO PrimeCell Identification 2 (GPIOCellID2)

GPIO Port A (APB) base: 0x4000.4000  
 GPIO Port A (AHB) base: 0x4005.8000  
 GPIO Port B (APB) base: 0x4000.5000  
 GPIO Port B (AHB) base: 0x4005.9000  
 GPIO Port C (APB) base: 0x4000.6000  
 GPIO Port C (AHB) base: 0x4005.A000  
 GPIO Port D (APB) base: 0x4000.7000  
 GPIO Port D (AHB) base: 0x4005.B000  
 GPIO Port E (APB) base: 0x4002.4000  
 GPIO Port E (AHB) base: 0x4005.C000  
 GPIO Port F (APB) base: 0x4002.5000  
 GPIO Port F (AHB) base: 0x4005.D000  
 GPIO Port G (APB) base: 0x4002.6000  
 GPIO Port G (AHB) base: 0x4005.E000  
 GPIO Port H (APB) base: 0x4002.7000  
 GPIO Port H (AHB) base: 0x4005.F000  
 GPIO Port J (APB) base: 0x4003.D000  
 GPIO Port J (AHB) base: 0x4006.0000  
 Offset 0xFF8  
 Type RO, reset 0x0000.0005



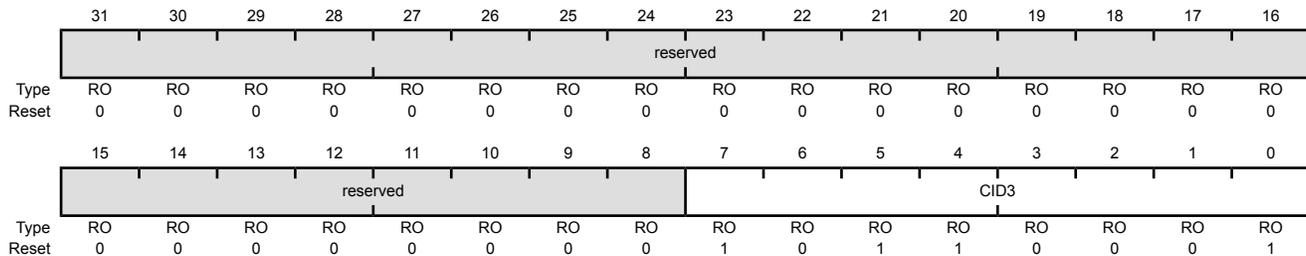
Bit/Field	Name	Type	Reset	Description
31:8	reserved	RO	0x0000.00	Software should not rely on the value of a reserved bit. To provide compatibility with future products, the value of a reserved bit should be preserved across a read-modify-write operation.
7:0	CID2	RO	0x05	GPIO PrimeCell ID Register [23:16] Provides software a standard cross-peripheral identification system.

**Register 34: GPIO PrimeCell Identification 3 (GPIOCellID3), offset 0xFFC**

The **GPIOCellID0**, **GPIOCellID1**, **GPIOCellID2**, and **GPIOCellID3** registers are four 8-bit wide registers, that can conceptually be treated as one 32-bit register. The register is used as a standard cross-peripheral identification system.

## GPIO PrimeCell Identification 3 (GPIOCellID3)

GPIO Port A (APB) base: 0x4000.4000  
 GPIO Port A (AHB) base: 0x4005.8000  
 GPIO Port B (APB) base: 0x4000.5000  
 GPIO Port B (AHB) base: 0x4005.9000  
 GPIO Port C (APB) base: 0x4000.6000  
 GPIO Port C (AHB) base: 0x4005.A000  
 GPIO Port D (APB) base: 0x4000.7000  
 GPIO Port D (AHB) base: 0x4005.B000  
 GPIO Port E (APB) base: 0x4002.4000  
 GPIO Port E (AHB) base: 0x4005.C000  
 GPIO Port F (APB) base: 0x4002.5000  
 GPIO Port F (AHB) base: 0x4005.D000  
 GPIO Port G (APB) base: 0x4002.6000  
 GPIO Port G (AHB) base: 0x4005.E000  
 GPIO Port H (APB) base: 0x4002.7000  
 GPIO Port H (AHB) base: 0x4005.F000  
 GPIO Port J (APB) base: 0x4003.D000  
 GPIO Port J (AHB) base: 0x4006.0000  
 Offset 0xFFC  
 Type RO, reset 0x0000.00B1



Bit/Field	Name	Type	Reset	Description
31:8	reserved	RO	0x0000.00	Software should not rely on the value of a reserved bit. To provide compatibility with future products, the value of a reserved bit should be preserved across a read-modify-write operation.
7:0	CID3	RO	0xB1	GPIO PrimeCell ID Register [31:24] Provides software a standard cross-peripheral identification system.

## 10 External Peripheral Interface (EPI)

The External Peripheral Interface is a high-speed parallel bus for external peripherals or memory. It has several modes of operation to interface gluelessly to many types of external devices. The External Peripheral Interface is similar to a standard microprocessor address/data bus, except that it must typically be connected to just one type of external device. Enhanced capabilities include  $\mu$ DMA support, clocking control and support for external FIFO buffers.

The EPI has the following features:

- 8/16/32-bit dedicated parallel bus for external peripherals and memory
- Memory interface supports contiguous memory access independent of data bus width, thus enabling code execution directly from SDRAM, SRAM and Flash memory
- Blocking and non-blocking reads
- Separates processor from timing details through use of an internal write FIFO
- Efficient transfers using Micro Direct Memory Access Controller ( $\mu$ DMA)
  - Separate channels for read and write
  - Read channel request asserted by programmable levels on the internal non-blocking read FIFO (NBRFIFO)
  - Write channel request asserted by empty on the internal write FIFO (WFIFO)

The EPI supports three primary functional modes: Synchronous Dynamic Random Access Memory (SDRAM) mode, Traditional Host-Bus mode, and General-Purpose mode. The EPI module also provides custom GPIOs; however, unlike regular GPIOs, the EPI module uses a FIFO in the same way as a communication mechanism and is speed-controlled using clocking.

- Synchronous Dynamic Random Access Memory (SDRAM)
  - Supports x16 (single data rate) SDRAM at up to 50 MHz
  - Supports low-cost SDRAMs up to 64 MB (512 megabits)
  - Includes automatic refresh and access to all banks/rows
  - Includes a Sleep/Standby mode to keep contents active with minimal power draw
  - Multiplexed address/data interface for reduced pin count
- Host-bus
  - Traditional x8 and x16 MCU bus interface capabilities
  - Similar device compatibility options as PIC, ATmega, 8051, and others
  - Access to SRAM, NOR Flash memory, and other devices, with up to 1 MB of addressing in unmultiplexed mode and 256 MB in multiplexed mode (512 MB in Host-Bus 16 mode with no byte selects)

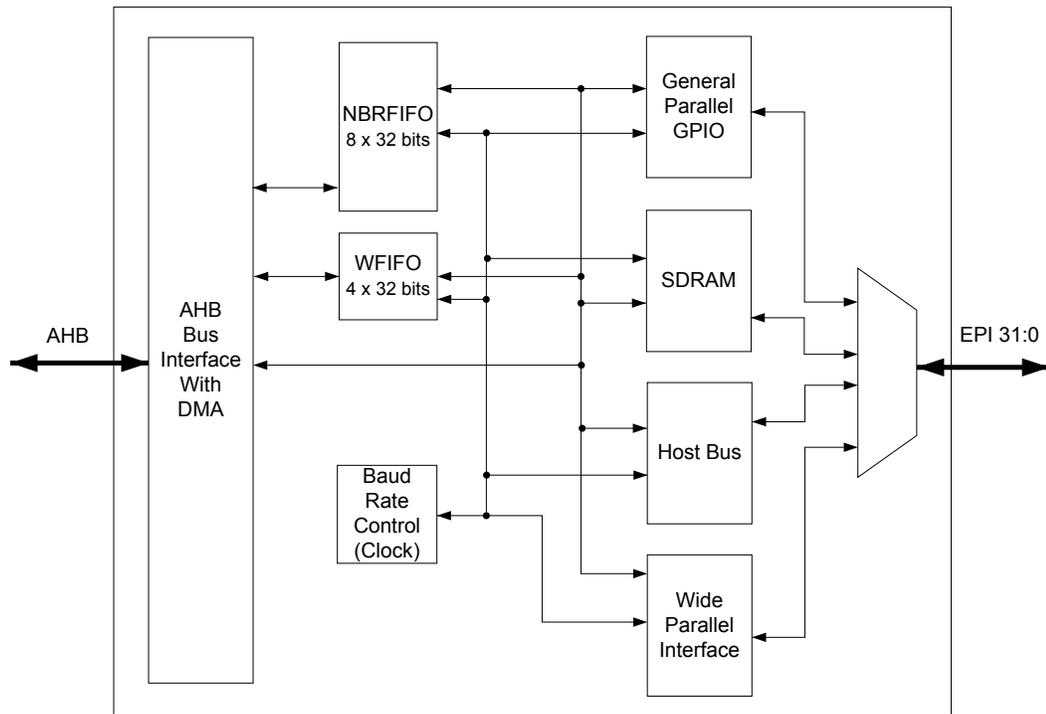


- Support of both muxed and de-muxed address and data
- Access to a range of devices supporting the non-address FIFO x8 and x16 interface variant, with support for external FIFO (XFIFO) EMPTY and FULL signals
- Speed controlled, with read and write data wait-state counters
- Chip select modes include ALE, CSn, Dual CSn and ALE with dual CSn
- Manual chip-enable (or use extra address pins)
- General Purpose
  - Wide parallel interfaces for fast communications with CPLDs and FPGAs
  - Data widths up to 32-bits
  - Data rates up to 150 MB/second
  - Optional “address” sizes from 4 bits to 20 bits
  - Optional clock output, read/write strobes, framing (with counter-based size), and clock-enable input
- General parallel GPIO
  - 1 to 32 bits, FIFOed with speed control
  - Useful for custom peripherals or for digital data acquisition and actuator controls

## 10.1 EPI Block Diagram

Figure 10-1 on page 362 provides a block diagram of a Stellaris® EPI module.

Figure 10-1. EPI Block Diagram



## 10.2 Signal Description

Table 10-1 on page 362 and Table 10-2 on page 363 list the external signals of the EPI controller and describe the function of each. The EPI controller signals are alternate functions for GPIO signals and default to be GPIO signals at reset. The column in the table below titled "Pin Mux/Pin Assignment" lists the GPIO pin placement for the EPI signals. The `AFSEL` bit in the **GPIO Alternate Function Select (GPIOAFSEL)** register (page 328) should be set to choose the EPI controller function. The number in parentheses is the encoding that must be programmed into the `PMCn` field in the **GPIO Port Control (GPIOPCTL)** register (page 346) to assign the EPI signals to the specified GPIO port pins. For more information on configuring GPIOs, see "General-Purpose Input/Outputs (GPIOs)" on page 304.

Table 10-1. Signals for External Peripheral Interface (100LQFP)

Pin Name	Pin Number	Pin Mux / Pin Assignment	Pin Type	Buffer Type <sup>a</sup>	Description
EPI0S0	83	PH3 (8)	I/O	TTL	EPI module 0 signal 0.
EPI0S1	84	PH2 (8)	I/O	TTL	EPI module 0 signal 1.
EPI0S2	25	PC4 (8)	I/O	TTL	EPI module 0 signal 2.
EPI0S3	24	PC5 (8)	I/O	TTL	EPI module 0 signal 3.
EPI0S4	23	PC6 (8)	I/O	TTL	EPI module 0 signal 4.
EPI0S5	22	PC7 (8)	I/O	TTL	EPI module 0 signal 5.
EPI0S6	86	PH0 (8)	I/O	TTL	EPI module 0 signal 6.
EPI0S7	85	PH1 (8)	I/O	TTL	EPI module 0 signal 7.
EPI0S8	74	PE0 (8)	I/O	TTL	EPI module 0 signal 8.
EPI0S9	75	PE1 (8)	I/O	TTL	EPI module 0 signal 9.

**Table 10-1. Signals for External Peripheral Interface (100LQFP) (continued)**

Pin Name	Pin Number	Pin Mux / Pin Assignment	Pin Type	Buffer Type <sup>a</sup>	Description
EPI0S10	76	PH4 (8)	I/O	TTL	EPI module 0 signal 10.
EPI0S11	63	PH5 (8)	I/O	TTL	EPI module 0 signal 11.
EPI0S12	42	PF4 (8)	I/O	TTL	EPI module 0 signal 12.
EPI0S13	19	PG0 (8)	I/O	TTL	EPI module 0 signal 13.
EPI0S14	18	PG1 (8)	I/O	TTL	EPI module 0 signal 14.
EPI0S15	41	PF5 (8)	I/O	TTL	EPI module 0 signal 15.
EPI0S16	14	PJ0 (8)	I/O	TTL	EPI module 0 signal 16.
EPI0S17	87	PJ1 (8)	I/O	TTL	EPI module 0 signal 17.
EPI0S18	39	PJ2 (8)	I/O	TTL	EPI module 0 signal 18.
EPI0S19	50 97	PJ3 (8) PD4 (10)	I/O	TTL	EPI module 0 signal 19.
EPI0S20	12	PD2 (8)	I/O	TTL	EPI module 0 signal 20.
EPI0S21	13	PD3 (8)	I/O	TTL	EPI module 0 signal 21.
EPI0S22	91	PB5 (8)	I/O	TTL	EPI module 0 signal 22.
EPI0S23	92	PB4 (8)	I/O	TTL	EPI module 0 signal 23.
EPI0S24	95	PE2 (8)	I/O	TTL	EPI module 0 signal 24.
EPI0S25	96	PE3 (8)	I/O	TTL	EPI module 0 signal 25.
EPI0S26	62	PH6 (8)	I/O	TTL	EPI module 0 signal 26.
EPI0S27	15	PH7 (8)	I/O	TTL	EPI module 0 signal 27.
EPI0S28	52 98	PJ4 (8) PD5 (10)	I/O	TTL	EPI module 0 signal 28.
EPI0S29	53 99	PJ5 (8) PD6 (10)	I/O	TTL	EPI module 0 signal 29.
EPI0S30	54 100	PJ6 (8) PD7 (10)	I/O	TTL	EPI module 0 signal 30.
EPI0S31	36	PG7 (9)	I/O	TTL	EPI module 0 signal 31.

a. The TTL designation indicates the pin has TTL-compatible voltage levels.

**Table 10-2. Signals for External Peripheral Interface (108BGA)**

Pin Name	Pin Number	Pin Mux / Pin Assignment	Pin Type	Buffer Type <sup>a</sup>	Description
EPI0S0	D10	PH3 (8)	I/O	TTL	EPI module 0 signal 0.
EPI0S1	D11	PH2 (8)	I/O	TTL	EPI module 0 signal 1.
EPI0S2	L1	PC4 (8)	I/O	TTL	EPI module 0 signal 2.
EPI0S3	M1	PC5 (8)	I/O	TTL	EPI module 0 signal 3.
EPI0S4	M2	PC6 (8)	I/O	TTL	EPI module 0 signal 4.
EPI0S5	L2	PC7 (8)	I/O	TTL	EPI module 0 signal 5.
EPI0S6	C9	PH0 (8)	I/O	TTL	EPI module 0 signal 6.
EPI0S7	C8	PH1 (8)	I/O	TTL	EPI module 0 signal 7.
EPI0S8	B11	PE0 (8)	I/O	TTL	EPI module 0 signal 8.
EPI0S9	A12	PE1 (8)	I/O	TTL	EPI module 0 signal 9.
EPI0S10	B10	PH4 (8)	I/O	TTL	EPI module 0 signal 10.

Table 10-2. Signals for External Peripheral Interface (108BGA) (continued)

Pin Name	Pin Number	Pin Mux / Pin Assignment	Pin Type	Buffer Type <sup>a</sup>	Description
EPI0S11	F10	PH5 (8)	I/O	TTL	EPI module 0 signal 11.
EPI0S12	K4	PF4 (8)	I/O	TTL	EPI module 0 signal 12.
EPI0S13	K1	PG0 (8)	I/O	TTL	EPI module 0 signal 13.
EPI0S14	K2	PG1 (8)	I/O	TTL	EPI module 0 signal 14.
EPI0S15	K3	PF5 (8)	I/O	TTL	EPI module 0 signal 15.
EPI0S16	F3	PJ0 (8)	I/O	TTL	EPI module 0 signal 16.
EPI0S17	B6	PJ1 (8)	I/O	TTL	EPI module 0 signal 17.
EPI0S18	K6	PJ2 (8)	I/O	TTL	EPI module 0 signal 18.
EPI0S19	M10 B5	PJ3 (8) PD4 (10)	I/O	TTL	EPI module 0 signal 19.
EPI0S20	H2	PD2 (8)	I/O	TTL	EPI module 0 signal 20.
EPI0S21	H1	PD3 (8)	I/O	TTL	EPI module 0 signal 21.
EPI0S22	B7	PB5 (8)	I/O	TTL	EPI module 0 signal 22.
EPI0S23	A6	PB4 (8)	I/O	TTL	EPI module 0 signal 23.
EPI0S24	A4	PE2 (8)	I/O	TTL	EPI module 0 signal 24.
EPI0S25	B4	PE3 (8)	I/O	TTL	EPI module 0 signal 25.
EPI0S26	G3	PH6 (8)	I/O	TTL	EPI module 0 signal 26.
EPI0S27	H3	PH7 (8)	I/O	TTL	EPI module 0 signal 27.
EPI0S28	K11 C6	PJ4 (8) PD5 (10)	I/O	TTL	EPI module 0 signal 28.
EPI0S29	K12 A3	PJ5 (8) PD6 (10)	I/O	TTL	EPI module 0 signal 29.
EPI0S30	L10 A2	PJ6 (8) PD7 (10)	I/O	TTL	EPI module 0 signal 30.
EPI0S31	C10	PG7 (9)	I/O	TTL	EPI module 0 signal 31.

a. The TTL designation indicates the pin has TTL-compatible voltage levels.

### 10.3 Functional Description

The EPI controller provides a glueless, programmable interface to a variety of common external peripherals such as SDRAM, Host Bus x8 and x16 devices, RAM, NOR Flash memory, CPLDs and FPGAs. In addition, the EPI controller provides custom GPIO that can use a FIFO with speed control by using either the internal write FIFO (WFIFO) or the non-blocking read FIFO (NBRFIFO). The WFIFO can hold 4 words of data that are written to the external interface at the rate controlled by the **EPI Main Baud Rate (EPIBAUD)** register. The NBRFIFO can hold 8 words of data and samples at the rate controlled by the **EPIBAUD** register. The EPI controller provides predictable operation and thus has an advantage over regular GPIO which has more variable timing due to on-chip bus arbitration and delays across bus bridges. Blocking reads stall the CPU until the transaction completes. Non-blocking reads are performed in the background and allow the processor to continue operation. In addition, write data can also be stored in the WFIFO to allow multiple writes with no stalls.

Main read and write operations can be performed in subsets of the range 0x6000.0000 to 0xDFFF.FFFF. A read from an address mapped location uses the offset and size to control the address and size of the external operation. When performing a multi-value load, the read is done as a burst (when available) to maximize performance. A write to an address mapped location uses

the offset and size to control the address and size of the external operation. When performing a multi-value store, the write is done as a burst (when available) to maximize performance.

NAND Flash memory (x8) can be read natively. Automatic programming support is not provided; programming must be done by the user following the manufacturer's protocol. Automatic page ECC is also not supported, but can be performed in software.

### 10.3.1 Non-Blocking Reads

The EPI Controller supports a special kind of read called a non-blocking read, also referred to as a posted read. Where a normal read stalls the processor or  $\mu$ DMA until the data is returned, a non-blocking read is performed in the background.

A non-blocking read is configured by writing the start address into a **EPIRADDRn** register, the size per transaction into a **EPIRSIZEn** register, and then the count of operations into a **EPIRPSTDn** register. After each read is completed, the result is written into the NBRFIFO and the **EPIRADDRn** register is incremented by the size (1, 2, or 4).

If the NBRFIFO is filled, then the reads pause until space is made available. The NBRFIFO can be configured to interrupt the processor or trigger the  $\mu$ DMA based on fullness using the **EPIFIFOLVL** register. By using the trigger/interrupt method, the  $\mu$ DMA (or processor) can keep space available in the NBRFIFO and allow the reads to continue unimpeded.

When performing non-blocking reads, the SDRAM controller issues two additional read transactions after the burst request is terminated. The data for these additional transfers is discarded. This situation is transparent to the user other than the additional EPI bus activity and can safely be ignored.

Two non-blocking read register sets are available to allow sequencing and ping-pong use. When one completes, the other then activates. So, for example, if 20 words are to be read from 0x100 and 10 words from 0x200, the **EPIRPSTD0** register can be set up with the read from 0x100 (with a count of 20), and the **EPIRPSTD1** register can be set up with the read from 0x200 (with a count of 10). When **EPIRPSTD0** finishes (count goes to 0), the **EPIRPSTD1** register then starts its operation. The NBRFIFO has then passed 30 values. When used with the  $\mu$ DMA, it may transfer 30 values (simple sequence), or the primary/alternate model may be used to handle the first 20 in one way and the second 10 in another. It is also possible to reload the **EPIRPSTD0** register when it is finished (and the **EPIRPSTD1** register is active); thereby, keeping the interface constantly busy.

To cancel a non-blocking read, the **EPIRPSTDn** register is cleared. Care must be taken, however if the register set was active to drain away any values read into the NBRFIFO and ensure that any read in progress is allowed to complete.

To ensure that the cancel is complete, the following algorithm is used (using the **EPIRPSTD0** register for example):

```
EPIRPSTD0 = 0;
while ((EPISTAT & 0x11) == 0x10)
; // we are active and busy
// if here, then other one is active or interface no longer busy
cnt = (EPIRADDR0 – original_address) / EPIRSIZE0; // count of values read
cnt -= values_read_so_far;
// cnt is now number left in FIFO
while (cnt--)
```

```
value = EPIREADFIFO; // drain
```

The above algorithm can be optimized in code; however, the important point is to wait for the cancel to complete because the external interface could have been in the process of reading a value when the cancel came in, and it must be allowed to complete.

### 10.3.2 DMA Operation

The  $\mu$ DMA can be used to efficiently transfer data from and to the NBRFIFO and the WFIFO. The  $\mu$ DMA has one channel for write and one for read. The write channel copies values to the WFIFO when the WFIFO is at the level specified by the **EPI FIFO Level Selects (EPIFIFOLVL)** register. The non-blocking read channel copies values from the NBRFIFO when the NBRFIFO is at the level specified by the **EPIFIFOLVL** register. For non-blocking reads, the start address, the size per transaction, and the count of elements must be programmed in the  $\mu$ DMA. Note that both non-blocking read register sets can be used, and they fill the NBRFIFO such that one runs to completion, then the next one starts (they do not interleave).

For blocking reads, the  $\mu$ DMA software channel (or another unused channel) is used for memory-to-memory transfers (or memory to peripheral, where some other peripheral is used). In this situation, the  $\mu$ DMA stalls until the read is complete and is not able to service another channel until the read is done. As a result, the arbitration size should normally be programmed to one access at a time. The  $\mu$ DMA controller can also transfer from and to the NBRFIFO and the WFIFO using the  $\mu$ DMA software channel in memory mode, however, the  $\mu$ DMA is stalled once the NBRFIFO is empty or the WFIFO is full. Note that when the  $\mu$ DMA controller is stalled, the core continues operation. See “Micro Direct Memory Access ( $\mu$ DMA)” on page 246 for more information on configuring the  $\mu$ DMA.

## 10.4 Initialization and Configuration

To enable and initialize the EPI controller, the following steps are necessary:

1. Enable the EPI module using the **RCGC1** register. See page 181.
2. Enable the clock to the appropriate GPIO module via the **RCGC2** register. See page 193. To find out which GPIO port to enable, refer to Table 10-1 on page 362 or Table 10-2 on page 363.
3. Set the GPIO **AFSEL** bits for the appropriate pins. See page 328. To determine which GPIOs to configure, see Table 25-4 on page 1151.
4. Configure the GPIO current level and/or slew rate as specified for the mode selected. See page 330 and page 338.
5. Configure the **PMC<sub>n</sub>** fields in the **GPIOPCTL** register to assign the EPI signals to the appropriate pins. See page 346 and Table 25-5 on page 1160.
6. Select the mode for the EPI block to SDRAM, HB8, HB16, or general parallel use, using the **MODE** field in the **EPI Configuration (EPICFG)** register. Set the mode-specific details (if needed) using the appropriate mode configuration **EPI xxx Configuration (EPIxxxCFG)** and **EPI xxx Configuration 2 (EPIxxxCFG2)** registers. Set the **EPI Main Baud Rate (EPIBAUD)** register if the baud rate must be slower than the system clock rate.
7. Configure the address mapping using the **EPI Address Map (EPIADDRMAP)** register. The selected start address and range is dependent on the type of external device and maximum address (as appropriate). For example, for a 512-megabit SDRAM, program the **ERADR** field to 0x1 for address 0x6000.0000 or 0x2 for address 0x8000.0000; and program the **ERSZ** field to

0x3 for 256 MB. If using General-Purpose mode and no address at all, program the `EPADR` field to 0x1 for address 0xA000.0000 or 0x2 for address 0xC000.0000; and program the `EPSZ` field to 0x0 for 256 bytes.

8. To read or write directly, use the mapped address area (configured with the **EPIADDRMAP** register). Up to 4 or 5 writes can be performed at once without blocking. Each read is blocked until the value is retrieved.
9. To perform a non-blocking read, see “Non-Blocking Reads” on page 365.

The following sub-sections describe the initialization and configuration for each of the modes of operation. Care must be taken to initialize everything properly to ensure correct operation. Control of the GPIO states is also important, as changes may cause the external device to interpret pin states as actions or commands (see “Register Descriptions” on page 317). Normally, a pull-up or pull-down is needed on the board to at least control the chip-select or chip-enable as the Stellaris® GPIOs come out of reset in tri-state.

### 10.4.1 SDRAM Mode

When activating the SDRAM mode, it is important to consider a few points:

1. Generally, it takes over 100  $\mu$ s from when the mode is activated to when the first operation is allowed. The SDRAM controller begins the SDRAM initialization sequence as soon as the mode is selected and enabled via the **EPICFG** register. It is important that the GPIOs are properly configured before the SDRAM mode is enabled, as the EPI controller is relying on the GPIO block's ability to drive the pins immediately. As part of the initialization sequence, the **LOAD MODE REGISTER** command is automatically sent to the SDRAM with a value of 0x27, which sets a CAS latency of 2 and a full page burst length.
2. The `INITSEQ` bit in the **EPI Status (EPISTAT)** register can be checked to determine when the initialization sequence is complete.
3. When using a frequency range and/or refresh value other than the default value, it is important to configure the `FREQ` and `RFSH` fields in the **EPI SDRAM Configuration (EPISDRAMCFG)** register shortly after activating the mode. After the 100- $\mu$ s startup time, the EPI block must be configured properly to keep the SDRAM contents stable.
4. The `SLEEP` bit in the **EPISDRAMCFG** register may be configured to put the SDRAM into a low-power self-refreshing state. It is important to note that the SDRAM mode must not be disabled once enabled, or else the SDRAM is no longer clocked and the contents are lost.

The `SIZE` field of the **EPISDRAMCFG** register must be configured correctly based on the amount of SDRAM in the system.

The `FREQ` field must be configured according to the value that represents the range being used. Based on the range selected, the number of external clocks used between certain operations (for example, **PRECHARGE** or **ACTIVATE**) is determined. If a higher frequency is given than is used, then the only downside is that the peripheral is slower (uses more cycles for these delays). If a lower frequency is given, incorrect operation occurs.

See “External Peripheral Interface (EPI)” on page 1213 for timing details for the SDRAM mode.

#### 10.4.1.1 External Signal Connections

Table 10-3 on page 368 defines how EPI module signals should be connected to SDRAMs. The table applies when using a x16 SDRAM up to 512 megabits. Note that the EPI signals must use

8-mA drive when interfacing to SDRAM, see page 332. Any unused EPI controller signals can be used as GPIOs or another alternate function.

**Table 10-3. EPI SDRAM Signal Connections**

EPI Signal	SDRAM Signal <sup>a</sup>	
EPI0S0	A0	D0
EPI0S1	A1	D1
EPI0S2	A2	D2
EPI0S3	A3	D3
EPI0S4	A4	D4
EPI0S5	A5	D5
EPI0S6	A6	D6
EPI0S7	A7	D7
EPI0S8	A8	D8
EPI0S9	A9	D9
EPI0S10	A10	D10
EPI0S11	A11	D11
EPI0S12	A12 <sup>b</sup>	D12
EPI0S13	BA0	D13
EPI0S14	BA1	D14
EPI0S15	D15	
EPI0S16	DQML	
EPI0S17	DQMH	
EPI0S18	CASn	
EPI0S19	RASn	
EPI0S20-EPI0S27	not used	
EPI0S28	WEn	
EPI0S29	CSn	
EPI0S30	CKE	
EPI0S31	CLK	

a. If 2 signals are listed, connect the EPI signal to both pins.

b. Only for 256/512 megabit SDRAMs

### 10.4.1.2 Refresh Configuration

The refresh count is based on the external clock speed and the number of rows per bank as well as the refresh period. The `RFSH` field represents how many external clock cycles remain before an AUTO-REFRESH is required. The normal formula is:

$$RFSH = (\tau_{Refresh\_us} / number\_rows) / ext\_clock\_period$$

A refresh period is normally 64 ms, or 64000  $\mu$ s. The number of rows is normally 4096 or 8192. The `ext_clock_period` is a value expressed in  $\mu$ sec and is derived by dividing 1000 by the clock speed expressed in MHz. So, 50 MHz is  $1000/50=20$  ns, or 0.02  $\mu$ s. A typical SDRAM is 4096 rows per bank if the system clock is running at 50 MHz with an **EPIBAUD** register value of 0:

$$RFSH = (64000/4096) / 0.02 = 15.625 \mu s / 0.02 \mu s = 781.25$$



The default value in the `RFSH` field is 750 decimal or 0x2EE to allow for a margin of safety and providing 15  $\mu$ s per refresh. It is important to note that this number should always be smaller or equal to what is required by the above equation. For example, if running the external clock at 25 MHz (40 ns per clock period), 390 is the highest number that may be used. Note that the external clock may be 25 MHz when the system clock is 25 MHz or when the system clock is 50 MHz and configuring the `COUNT0` field in the **EPIBAUD** register to 1 (divide by 2).

If a number larger than allowed is used, the SDRAM is not refreshed often enough, and data is lost.

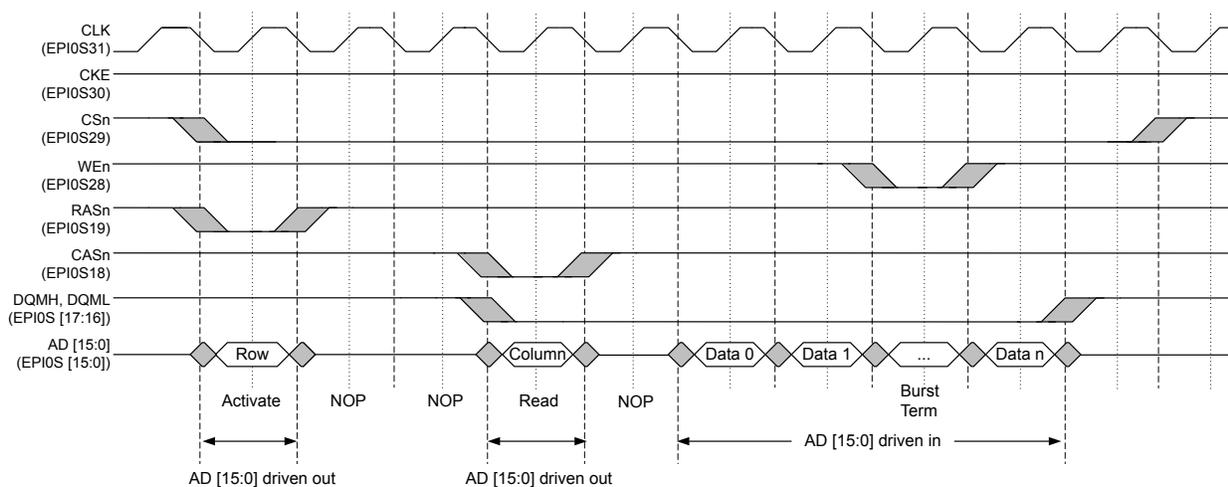
### 10.4.1.3 Bus Interface Speed

The EPI Controller SDRAM interface can operate up to 50 MHz. The `COUNT0` field in the **EPIBAUD** register configures the speed of the EPI clock. For system clock (SysClk) speeds up to 50 MHz, the `COUNT0` field can be 0x0000, and the SDRAM interface can run at the same speed as SysClk. However, if SysClk is running at higher speeds, the bus interface can run only as fast as half speed, and the `COUNT0` field must be configured to at least 0x0001.

### 10.4.1.4 Non-Blocking Read Cycle

Figure 10-2 on page 369 shows a non-blocking read cycle of  $n$  halfwords;  $n$  can be any number greater than or equal to 1. The cycle begins with the Activate command and the row address on the `EPIOS[15:0]` signals. With the programmed CAS latency of 2, the Read command with the column address on the `EPIOS[15:0]` signals follows after 2 clock cycles. Following one more NOP cycle, data is read in on the `EPIOS[15:0]` signals on every rising clock edge. The Burst Terminate command is issued during the cycle when the next-to-last halfword is read in. The `DQMH` and `DQML` signals are deasserted after the last halfword of data is received; the `CSn` signal deasserts on the following clock cycle, signaling the end of the read cycle. At least one clock period of inactivity separates any two SDRAM cycles.

Figure 10-2. SDRAM Non-Blocking Read Cycle

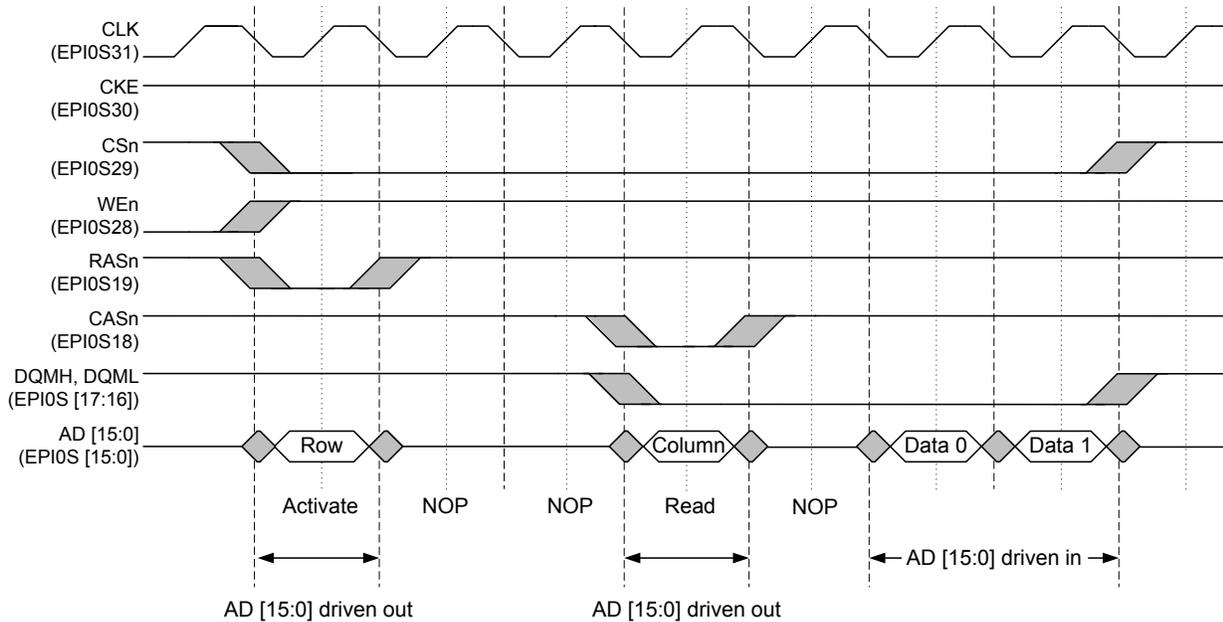


### 10.4.1.5 Normal Read Cycle

Figure 10-3 on page 370 shows a normal read cycle of  $n$  halfwords;  $n$  can be 1 or 2. The cycle begins with the Activate command and the row address on the `EPIOS[15:0]` signals. With the programmed CAS latency of 2, the Read command with the column address on the `EPIOS[15:0]` signals follows after 2 clock cycles. Following one more NOP cycle, data is read in on the `EPIOS[15:0]` signals on every rising clock edge. The `DQMH`, `DQML`, and `CSn` signals are deasserted after the last

halfword of data is received, signaling the end of the cycle. At least one clock period of inactivity separates any two SDRAM cycles.

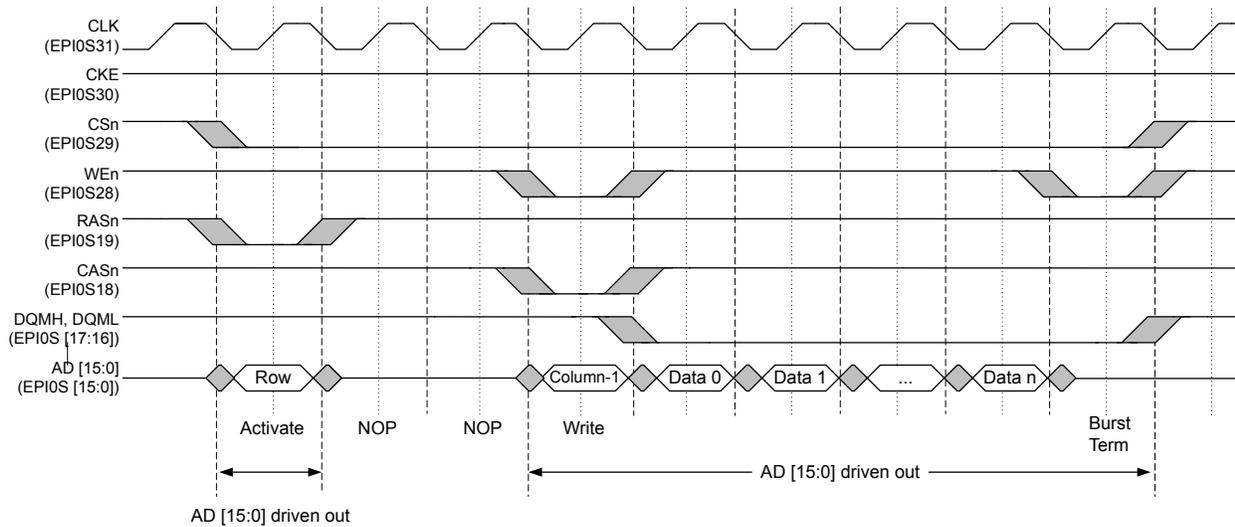
**Figure 10-3. SDRAM Normal Read Cycle**



#### 10.4.1.6 Write Cycle

Figure 10-4 on page 371 shows a write cycle of  $n$  halfwords;  $n$  can be any number greater than or equal to 1. The cycle begins with the Activate command and the row address on the  $EPIOS[15:0]$  signals. With the programmed CAS latency of 2, the Write command with the column address on the  $EPIOS[15:0]$  signals follows after 2 clock cycles. When writing to SDRAMs, the Write command is presented with the first halfword of data. Because the address lines and the data lines are multiplexed, the column address is modified to be (programmed address - 1). During the Write command, the DQMH and DQML signals are high, so no data is written to the SDRAM. On the next clock, the DQMH and DQML signals are asserted, and the data associated with the programmed address is written. The Burst Terminate command occurs during the clock cycle following the write of the last halfword of data. The WEn, DQMH, DQML, and CSn signals are deasserted after the last halfword of data is received, signaling the end of the access. At least one clock period of inactivity separates any two SDRAM cycles.

Figure 10-4. SDRAM Write Cycle



## 10.4.2 Host Bus Mode

Host Bus supports the traditional 8-bit and 16-bit interfaces popularized by the 8051 devices and SRAM devices. This interface is asynchronous and uses strobe pins to control activity.

### 10.4.2.1 Control Pins

The main three strobes are ALE (Address latch enable), WRn (write), and RDn (sometimes called OEn, used for read). Note that the timings are designed for older logic and so are hold-time vs. setup-time specific. To ensure proper operation on this bus, the EPI block uses two system clocks per transition to allow significant skewing of control vs. data signals. So, for example, ALE rises one EPI clock before ADDR/DATA is asserted. Likewise, ALE falls (latch point) one EPI clock before DATA changes or tri-states. The same approach is used for the WRn and RDn/OEn strobes. The polarity of the read and write strobes can be active high or active low by clearing or setting the RDHIGH and WRHIGH bits in the **EPI Host-Bus n Configuration 2 (EPIHBnCFG2)** register.

The ALE can be changed to an active-low chip select signal, CSn, through the **EPIHBnCFG2** register. The ALE is best used for Host-Bus muxed mode in which EPI address and data pins are shared. All Host-Bus accesses have an address phase followed by a data phase. The ALE indicates to an external latch to capture the address then hold it until the data phase. CSn is best used for Host-Bus unmuxed mode in which EPI address and data pins are separate. The CSn indicates when the address and data phases of a read or write access is occurring. Both the ALE and the CSn modes can be enhanced to access two external devices using settings in the **EPIHBnCFG2** register. Wait states can be added to the data phase of the access using the WRWS and RDWS bits in the **EPIHBnCFG2** register.

For FIFO mode, the ALE is not used, and two input holds are optionally supported to gate input and output to what the XFIFO can handle.

Host-Bus 8 and Host-Bus 16 modes are very configurable. The user has the ability to connect 1 or 2 external devices to the EPI signals as well as control whether byte select signals are provided in HB16 mode. These capabilities depend on the configuration of the MODE field in the **EPIHBnCFG** register, the CSCFG field in the **EPIHBnCFG2** register, and the BSEL bit in the **EPIHB16CFG** register.

If one of the Dual-Chip-Select modes is selected ( $CSCFG=0x2$  or  $0x3$  in the **EPIHBnCFG2** register), both chip selects can share the peripheral or the memory space, or one chip select can use the peripheral space and the other can use the memory space. In the **EPIADDRMAP** register, if the  $EPADR$  field is not  $0x0$  and the  $ERADR$  field is  $0x0$ , then the address specified by  $EPADR$  is used for both chip selects, with  $CS0n$  being asserted when the MSB of the address range is 0 and  $CS1n$  being asserted when the MSB of the address range is 1. If the  $ERADR$  field is not  $0x0$  and the  $EPADR$  field is  $0x0$ , then the address specified by  $ERADR$  is used for both chip selects, with the MSB performing the same delineation. If both the  $EPADR$  and the  $ERADR$  are not  $0x0$ , then  $CS0n$  is asserted for the address range defined by  $EPADR$  and  $CS1n$  is asserted for the address range defined by  $ERADR$ . If the  $CSBAUD$  bit in the **EPIHBnCFG2** register is set, the 2 chip selects can use different clock frequencies. If the  $CSBAUD$  bit is clear, both chip selects use the clock frequency, wait states, and strobe polarity defined for  $CS0n$ .

When  $BSEL=1$  in the **EPIHB16CFG** register, byte select signals are provided, so byte-sized data can be read and written at any address, however these signals reduce the available address width by 2 pins. The byte select signals are active low.  $BSEL0n$  corresponds to the LSB of the halfword, and  $BSEL1n$  corresponds to the MSB of the halfword.

When  $BSEL=0$ , byte reads and writes at odd addresses only act on the even byte, and byte writes at even addresses write invalid values into the odd byte. As a result, accesses should be made as half-words (16-bits) or words (32-bits). In C/C++, programmers should use only short int and long int for accesses. Also, because data accesses in HB16 mode with no byte selects are on 2-byte boundaries, the available address space is doubled. For example, 28 bits of address accesses 512 MB in this mode. Table 10-4 on page 372 shows the capabilities of the HB8 and HB16 modes as well as the available address bits with the possible combinations of these bits.

Although the  $EPI0S31$  signal can be configured for the EPI clock signal in Host-Bus mode, it is not required and should be configured as a GPIO to reduce EMI in the system.

**Table 10-4. Capabilities of Host Bus 8 and Host Bus 16 Modes**

Host Bus Type	MODE	CSCFG	Max # of External Devices	BSEL	Byte Access	Available Address
HB8	0x0	0x0, 0x1	1	N/A	Always	28 bits
HB8	0x0	0x2	2	N/A	Always	27 bits
HB8	0x0	0x3	2	N/A	Always	26 bits
HB8	0x1	0x0, 0x1	1	N/A	Always	20 bits
HB8	0x1	0x2	2	N/A	Always	19 bits
HB8	0x1	0x3	2	N/A	Always	18 bits
HB8	0x3	0x1	1	N/A	Always	none
HB8	0x3	0x3	2	N/A	Always	none
HB16	0x0	0x0, 0x1	1	0	No	28 bits <sup>a</sup>
HB16	0x0	0x0, 0x1	1	1	Yes	26 bits
HB16	0x0	0x2	2	0	No	27 bits <sup>a</sup>
HB16	0x0	0x2	2	1	Yes	25 bits
HB16	0x0	0x3	2	0	No	26 bits <sup>a</sup>
HB16	0x0	0x3	2	1	Yes	24 bits
HB16	0x1	0x0, 0x1	1	0	No	12 bits <sup>a</sup>
HB16	0x1	0x0, 0x1	1	1	Yes	10 bits
HB16	0x1	0x2	2	0	No	11 bits <sup>a</sup>

**Table 10-4. Capabilities of Host Bus 8 and Host Bus 16 Modes (continued)**

Host Bus Type	MODE	CSCFG	Max # of External Devices	BSEL	Byte Access	Available Address
HB16	0x1	0x2	2	1	Yes	9 bits
HB16	0x1	0x3	2	0	No	10 bits <sup>a</sup>
HB16	0x1	0x3	2	1	Yes	8 bits
HB16	0x3	0x1	1	0	No	none
HB16	0x3	0x1	1	1	Yes	none
HB16	0x3	0x3	2	0	No	none
HB16	0x3	0x3	2	1	Yes	none

a. If byte selects are not used, data accesses are on 2-byte boundaries. As a result, the available address space is doubled.

Table 10-5 on page 373 shows how the EPI[31:0] signals function while in Host-Bus 8 mode. Notice that the signal configuration changes based on the address/data mode selected by the MODE field in the **EPIHB8CFG2** register and on the chip select configuration selected by the CSCFG field in the same register. Any unused EPI controller signals can be used as GPIOs or another alternate function.

**Table 10-5. EPI Host-Bus 8 Signal Connections**

EPI Signal	CSCFG	HB8 Signal (MODE =ADMUX)	HB8 Signal (MODE =ADNOMUX (Cont. Read))	HB8 Signal (MODE =XFIFO)
EPI0S0	X <sup>a</sup>	AD0	D0	D0
EPI0S1	X	AD1	D1	D1
EPI0S2	X	AD2	D2	D2
EPI0S3	X	AD3	D3	D3
EPI0S4	X	AD4	D4	D4
EPI0S5	X	AD5	D5	D5
EPI0S6	X	AD6	D6	D6
EPI0S7	X	AD7	D7	D7
EPI0S8	X	A8	A0	-
EPI0S9	X	A9	A1	-
EPI0S10	X	A10	A2	-
EPI0S11	X	A11	A3	-
EPI0S12	X	A12	A4	-
EPI0S13	X	A13	A5	-
EPI0S14	X	A14	A6	-
EPI0S15	X	A15	A7	-
EPI0S16	X	A16	A8	-
EPI0S17	X	A17	A9	-
EPI0S18	X	A18	A10	-
EPI0S19	X	A19	A11	-
EPI0S20	X	A20	A12	-
EPI0S21	X	A21	A13	-
EPI0S22	X	A22	A14	-

Table 10-5. EPI Host-Bus 8 Signal Connections (continued)

EPI Signal	CSCFG	HB8 Signal (MODE =ADMUX)	HB8 Signal (MODE =ADNOMUX (Cont. Read))	HB8 Signal (MODE =XFIFO)
EPI0S23	X	A23	A15	-
EPI0S24	X	A24	A16	-
EPI0S25	0x0	A25 <sup>b</sup>	A17	-
	0x1			-
	0x2			CS1n
	0x3			-
EPI0S26	0x0	A26	A18	FEMPTY
	0x1			
	0x2			
	0x3	CS0n	CS0n	
EPI0S27	0x0	A27	A19	FFULL
	0x1			
	0x2	CSn1	CSn1	
	0x3			
EPI0S28	X	RDn/OEn	RDn/OEn	RDn
EPI0S29	X	WRn	WRn	WRn
EPI0S30	0x0	ALE	ALE	-
	0x1	CSn	CSn	CSn
	0x2	CS0n	CS0n	CS0n
	0x3	ALE	ALE	-
EPI0S31	X	Clock <sup>c</sup>	Clock <sup>c</sup>	Clock <sup>c</sup>

a. "X" indicates the state of this field is a don't care.

b. When an entry straddles several row, the signal configuration is the same for all rows.

c. The clock signal is not required for this mode and has unspecified timing relationships to other signals.

Table 10-6 on page 374 shows how the EPI[31:0] signals function while in Host-Bus 16 mode. Notice that the signal configuration changes based on the address/data mode selected by the MODE field in the EPIHB16CFG2 register, on the chip select configuration selected by the CSCFG field in the same register, and on whether byte selects are used as configured by the BSEL bit in the EPIHB16CFG register. Any unused EPI controller signals can be used as GPIOs or another alternate function.

Table 10-6. EPI Host-Bus 16 Signal Connections

EPI Signal	CSCFG	BSEL	HB16 Signal (MODE =ADMUX)	HB16 Signal (MODE =ADNOMUX (Cont. Read))	HB16 Signal (MODE =XFIFO)
EPI0S0	X <sup>a</sup>	X	AD0	D0	D0
EPI0S1	X	X	AD1	D1	D1
EPI0S2	X	X	AD2	D2	D2
EPI0S3	X	X	AD3	D3	D3
EPI0S4	X	X	AD4	D4	D4
EPI0S5	X	X	AD5	D5	D5

Table 10-6. EPI Host-Bus 16 Signal Connections (continued)

EPI Signal	CSCFG	BSEL	HB16 Signal (MODE =ADMUX)	HB16 Signal (MODE =ADNOMUX (Cont. Read))	HB16 Signal (MODE =XFIFO)																																																																
EPI0S6	X	X	AD6	D6	D6																																																																
EPI0S7	X	X	AD7	D7	D7																																																																
EPI0S8	X	X	AD8	D8	D8																																																																
EPI0S9	X	X	AD9	D9	D9																																																																
EPI0S10	X	X	AD10	D10	D10																																																																
EPI0S11	X	X	AD11	D11	D11																																																																
EPI0S12	X	X	AD12	D12	D12																																																																
EPI0S13	X	X	AD13	D13	D13																																																																
EPI0S14	X	X	AD14	D14	D14																																																																
EPI0S15	X	X	AD15	D15	D15																																																																
EPI0S16	X	X	A16	A0 <sup>b</sup>	-																																																																
EPI0S17	X	X	A17	A1	-																																																																
EPI0S18	X	X	A18	A2	-																																																																
EPI0S19	X	X	A19	A3	-																																																																
EPI0S20	X	X	A20	A4	-																																																																
EPI0S21	X	X	A21	A5	-																																																																
EPI0S22	X	X	A22	A6	-																																																																
EPI0S23	X <sup>c</sup>	0	A23	A7	-																																																																
		1				EPI0S24	0x0	0	A24	A8	-	1	0x1	0	1	0x2	0	1	0x3	0	BSEL0n	BSEL0n	1	EPI0S25	0x0	X	A25	A9	-	0x1	0x2	0	A25	A9	CS1n	1	BSEL0n	BSEL0n	0x3	0	A25	A9	--	1	BSEL1n	BSEL1n	EPI0S26	0x0	0	A26	A10	FEMPTY	1	BSEL0n	BSEL0n	0x1	0	A26	A10	1	BSEL0n	BSEL0n	0x2	0	A26	A10	1	BSEL1n	BSEL1n
EPI0S24	0x0	0	A24	A8	-																																																																
		1																																																																			
	0x1	0																																																																			
		1																																																																			
	0x2	0																																																																			
		1																																																																			
0x3	0	BSEL0n	BSEL0n																																																																		
	1																																																																				
EPI0S25	0x0	X	A25	A9	-																																																																
		0x1																																																																			
	0x2	0	A25	A9	CS1n																																																																
		1	BSEL0n	BSEL0n																																																																	
	0x3	0	A25	A9	--																																																																
1		BSEL1n	BSEL1n																																																																		
EPI0S26	0x0	0	A26	A10	FEMPTY																																																																
		1	BSEL0n	BSEL0n																																																																	
	0x1	0	A26	A10																																																																	
		1	BSEL0n	BSEL0n																																																																	
	0x2	0	A26	A10																																																																	
		1	BSEL1n	BSEL1n																																																																	
	0x3	X	CS0n	CS0n																																																																	

Table 10-6. EPI Host-Bus 16 Signal Connections (continued)

EPI Signal	CSCFG	BSEL	HB16 Signal (MODE =ADMUX)	HB16 Signal (MODE =ADNOMUX (Cont. Read))	HB16 Signal (MODE =XFIFO)
EPI0S27	0x0	0	A27	A11	FFULL
		1	BSEL1n	BSEL1n	
	0x1	0	A27	A11	
		1	BSEL1n	BSEL1n	
	0x2	X	CS1n	CS1n	
0x3	X				
EPI0S28	X	X	RDn/OEn	RDn/OEn	RDn
EPI0S29	X	X	WRn	WRn	WRn
EPI0S30	0x0	X	ALE	ALE	-
	0x1	X	CSn	CSn	CSn
	0x2	X	CS0n	CS0n	CS0n
	0x3	X	ALE	ALE	-
EPI0S31	X	X	Clock <sup>d</sup>	Clock <sup>d</sup>	Clock <sup>d</sup>

a. "X" indicates the state of this field is a don't care.

b. In this mode, half-word accesses are used. AO is the LSB of the address and is equivalent to the system A1 address.

c. When an entry straddles several row, the signal configuration is the same for all rows.

d. The clock signal is not required for this mode and has unspecified timing relationships to other signals.

### 10.4.2.2 Speed of Transactions

The `COUNT0` field in the **EPIBAUD** register must be configured to set the main transaction rate based on what the slave device can support (including wiring considerations). The main control transitions are normally  $\frac{1}{2}$  the baud rate (`COUNT0 = 1`) because the EPI block forces data vs. control to change on alternating clocks. When using dual chip-selects, each chip select can access the bus using differing baud rates by setting the `CSBAUD` bit in the **EPIHBnCFG2** register. In this case, the `COUNT0` field controls the `CS0n` transactions, and the `COUNT1` field controls the `CS1n` transactions.

Additionally, the Host-Bus mode provides read and write wait states for the data portion to support different classes of device. These wait states stretch the data period (hold the rising edge of data strobe) and may be used in all four sub-modes. The wait states are set using the `WRWS` and `RDWS` bits in the **EPI Host-Bus n Configuration (EPIHBnCFG)** register.

### 10.4.2.3 Sub-Modes of Host Bus 8/16

The EPI controller supports four variants of the Host-Bus model using 8 or 16 bits of data in all four cases. The four sub-modes are selected using the `MODE` bits in the **EPIHBnCFG** register, and are:

1. Address and data are muxed. This scheme is used by many 8051 devices, some Microchip PIC parts, and some ATmega parts. When used for standard SRAMs, a latch must be used between the microcontroller and the SRAM. This sub-mode is provided for compatibility with existing devices that support data transfers without a latch (for example, LCD controllers or CPLDs). In general, the de-muxed sub-mode should normally be used. The ALE configuration should be used in this mode, as all Host-Bus accesses have an address phase followed by a data phase. The ALE indicates to an external latch to capture the address then hold until the data phase. The ALE configuration is controlled by configuring the `CSCFG` field to be 0x0 in the **EPIHBnCFG2** register. The ALE can be enhanced to access two external devices with the addition of two separate `CSn` signals. By configuring the `CSCFG` field in the to be 0x3 in the **EPIHBnCFG2**



register, `EPI0S30` functions as ALE, `EPI0S27` functions as CS1n, and `EPI0S26` functions as CS0n. The CSn is best used for Host-Bus unmuxed mode which EPI address and data pins are separate. The CSn indicates when the address and data phases of a read or write access are occurring.

2. Address and data are separate with 8 or 16 bits of data and up to 20 bits of address (1 MB). This scheme is used by more modern 8051 devices, as well as some PIC and ATmega parts. This mode is generally used with real SRAMs, many EEPROMs, and many NOR Flash memory devices. Note that there is no hardware command write support for Flash memory devices; this mode should only be used for Flash memory devices programmed at manufacturing time. If a Flash memory device must be written and does not support a direct programming model, the command mechanism must be performed in software. The CSn configuration should be used in this mode. The CSn signal indicates when the address and data phases of a read or write access is occurring. The CSn configuration is controlled by configuring the `CSCFG` field to be 0x1 in the **EPIHBnCFG2** register.
3. Continuous read mode where address and data are separate. This sub-mode is used for real SRAMs which can be read more quickly by only changing the address (and not using RDn/OEn strobing). In this sub-mode, reads are performed by keeping the read mode selected (output enable is asserted) and then changing the address pins. The data pins are changed by the SRAM after the address pins change. For example, to read data from address 0x100 and then 0x101, the EPI controller asserts the output-enable signal and then configures the address pins to 0x100; the EPI controller then captures what is on the data pins and increments A0 to 1 (so the address is now 0x101); the EPI controller then captures what is on the data pins. Note that this mode consumes higher power because the SRAM must continuously drive the data pins. This mode is not practical in HB16 mode for normal SRAMs because there are generally not enough address bits available.
4. FIFO mode uses 8 or 16 bits of data, removes ALE and address pins and optionally adds external XFIFO FULL/EMPTY flag inputs. This scheme is used by many devices, such as radios, communication devices (including USB2 devices), and some FPGA configurations (FIFO through block RAM). This sub-mode provides the data side of the normal Host-Bus interface, but is paced by the FIFO control signals. It is important to consider that the XFIFO FULL/EMPTY control signals may stall the interface and could have an impact on blocking read latency from the processor or  $\mu$ DMA.

The `WORD` bit in the **EPIHBnCFG2** register can be set to use memory more efficiently. By default, the EPI controller uses data bits [7:0] for Host-Bus 8 accesses or bits [15:0] for Host-Bus 16 accesses. When the `WORD` bit is set, the EPI controller can automatically route bytes of data onto the correct byte lanes such that data can be stored in bits [31:8] (HB8) or [31:16] (HB16). In addition, for the three modes above (1, 2, 4) that the Host-Bus 16 mode supports, byte select signals can be optionally implemented by setting the `BSEL` bit in the **EPIHB16CFG** register.

See “External Peripheral Interface (EPI)” on page 1213 for timing details for the Host-Bus mode.

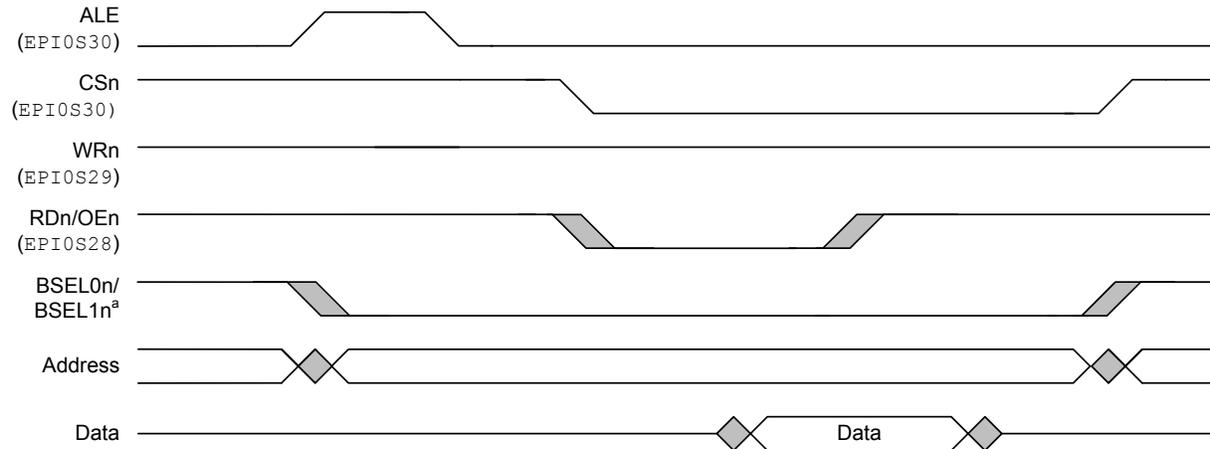
#### 10.4.2.4 Bus Operation

Bus operation is the same in Host-Bus 8 and Host-Bus 16 modes and is asynchronous. Timing diagrams show both ALE and CSn operation, but only one signal or the other is used in all modes except for ALE with dual chip selects mode (`CSCFG` field is 0x3 in the **EPIHBnCFG2** register). Address and data on write cycles are held after the CSn signal is deasserted. The optional HB16 byte select signals have the same timing as the address signals. If wait states are required in the bus access, they can be inserted during the data phase of the access using the `WRWS` and `RDWS`

bits in the **EPIHBnCFG2** register. Each wait state adds 2 EPI clock cycles to the duration of the WRn or RDn strobe.

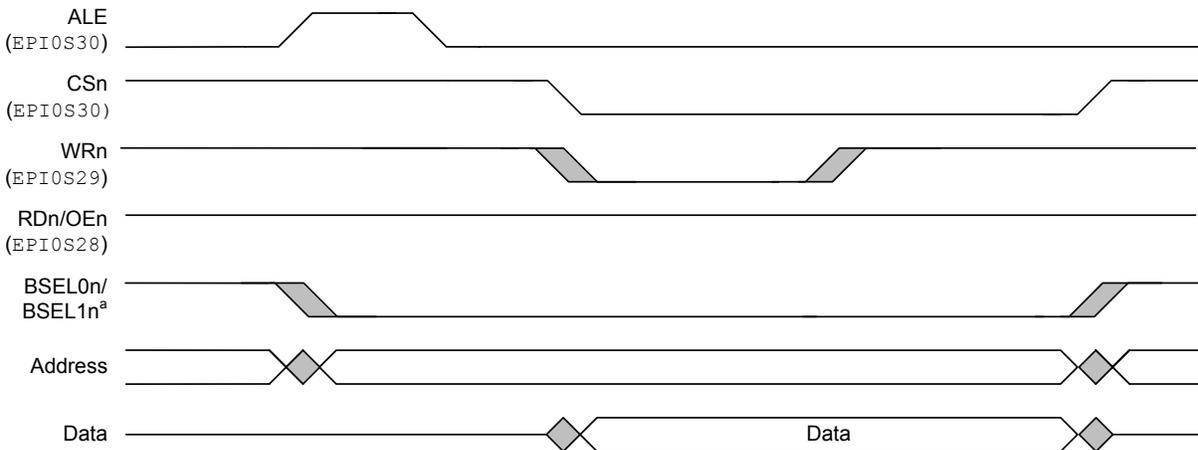
Figure 10-5 on page 378 shows a basic Host-Bus read cycle. Figure 10-6 on page 378 shows a basic Host-Bus write cycle. Both of these figures show address and data signals in the non-multiplexed mode (**MODE** field is 0x1 in the **EPIHBnCFG** register).

**Figure 10-5. Host-Bus Read Cycle, MODE = 0x1, WRHIGH = 1, RDHIGH = 1**



<sup>a</sup> BSEL0n and BSEL1n are available in Host-Bus 16 mode only.

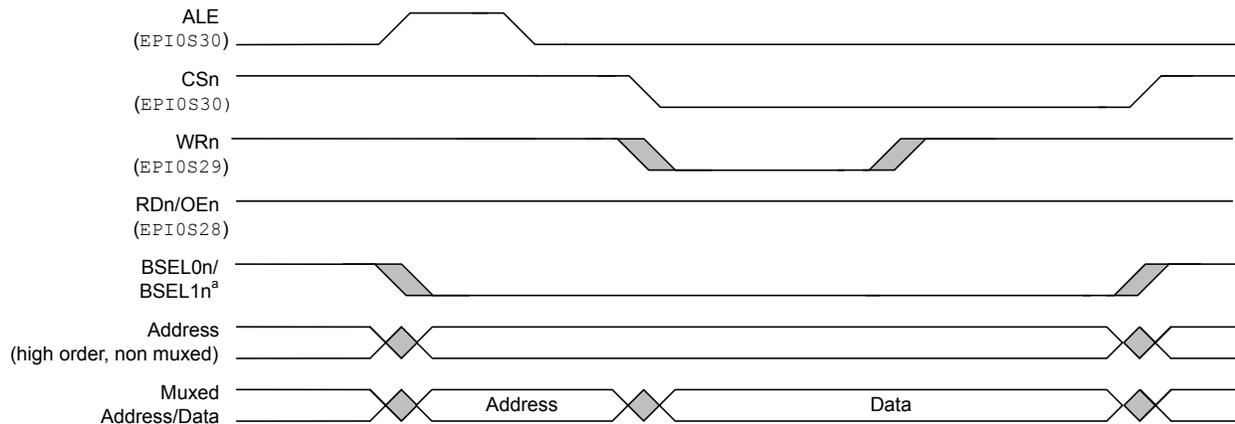
**Figure 10-6. Host-Bus Write Cycle, MODE = 0x1, WRHIGH = 1, RDHIGH = 1**



<sup>a</sup> BSEL0n and BSEL1n are available in Host-Bus 16 mode only.

Figure 10-7 on page 379 shows a write cycle with the address and data signals multiplexed (**MODE** field is 0x0 in the **EPIHBnCFG** register). A read cycle would look similar, with the RDn strobe being asserted along with CSn and data being latched on the rising edge of RDn.

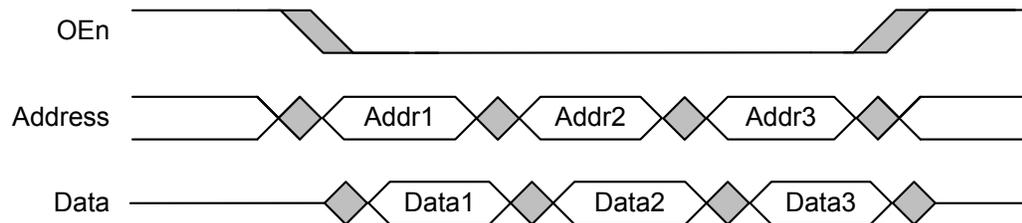
**Figure 10-7. Host-Bus Write Cycle with Multiplexed Address and Data, MODE = 0x0, WRHIGH = 1, RDHIGH = 1**



<sup>a</sup> BSEL0n and BSEL1n are available in Host-Bus 16 mode only.

Figure 10-8 on page 379 shows continuous read mode accesses. In this mode, reads are performed by keeping the read mode selected (output enable is asserted) and then changing the address pins. The data pins are changed by the SRAM after the address pins change.

**Figure 10-8. Continuous Read Mode Accesses**



FIFO mode accesses are the same as normal read and write accesses, except that the ALE signal and address pins are not present. Two input signals can be used to indicate when the XFIFO is full or empty to gate transactions and avoid overruns and underruns. The FFULL and FEMPTY signals are synchronized and must be recognized as asserted by the microcontroller for 2 system clocks before they affect transaction status. The MAXWAIT field in the **EPIHBnCFG** register defines the maximum number of EPI clocks to wait while the FEMPTY or FFULL signal is holding off a transaction. Figure 10-9 on page 380 shows how the FEMPTY signal should respond to a write and read from the XFIFO. Figure 10-10 on page 380 shows how the FEMPTY and FFULL signals should respond to 2 writes and 1 read from an external FIFO that contains two entries.

Figure 10-9. Write Followed by Read to External FIFO

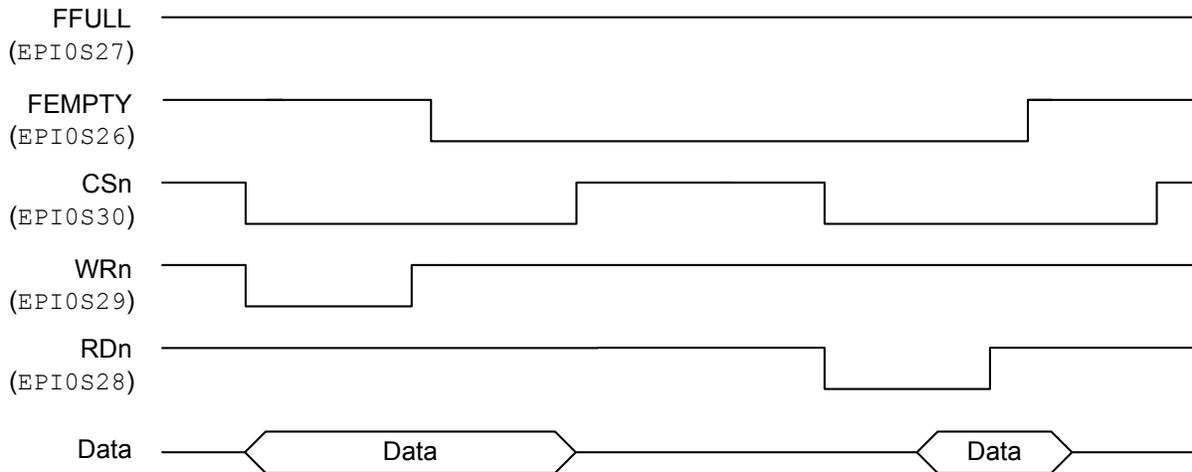
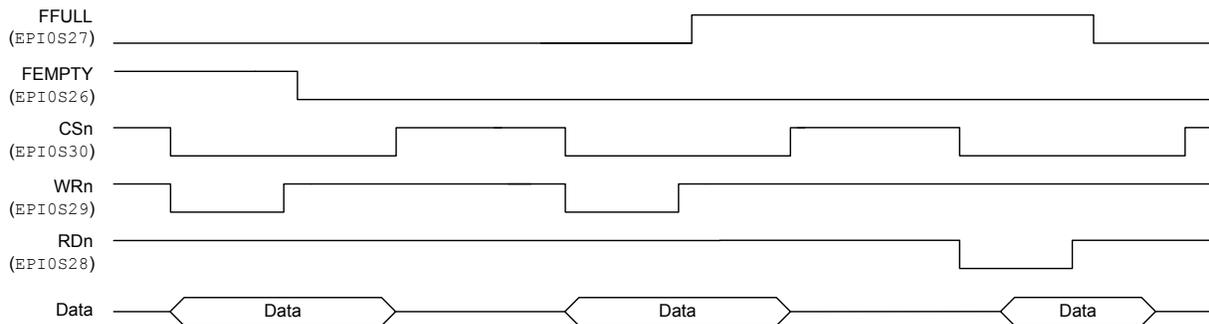


Figure 10-10. Two-Entry FIFO



### 10.4.3 General-Purpose Mode

The **General-Purpose Mode Configuration (EPIGPCFG)** register is used to configure the control, data, and address pins, if used. Any unused EPI controller signals can be used as GPIOs or another alternate function. The general-purpose configuration can be used for custom interfaces with FPGAs, CPLDs, and digital data acquisition and actuator control.

**Important:** The **RD2CYC** bit in the **EPIGPCFG** register must be set at all times in General-Purpose mode to ensure proper operation.

General-Purpose mode is designed for three general types of use:

- Extremely high-speed clocked interfaces to FPGAs and CPLDs. Three sizes of data and optional address are supported. Framing and clock-enable functions permit more optimized interfaces.
- General parallel GPIO. From 1 to 32 pins may be written or read, with the speed precisely controlled by the **EPIBAUD** register baud rate (when used with the **WFIFO** and/or the **NBRFIFO**) or by the rate of accesses from software or  $\mu$ DMA. Examples of this type of use include:
  - Reading 20 sensors at fixed time periods by configuring 20 pins to be inputs, configuring the **COUNT0** field in the **EPIBAUD** register to some divider, and then using non-blocking reads.

- Implementing a very wide ganged PWM/PCM with fixed frequency for driving actuators, LEDs, etc.
- Implementing SDIO 4-bit mode where commands are driven or captured on 6 pins with fixed timing, fed by the  $\mu$ DMA.
- General custom interfaces of any speed.

The configuration allows for choice of an output clock (free-running or gated), a framing signal (with frame size), a ready input (to stretch transactions), a read and write strobe, an address (of varying sizes), and data (of varying sizes). Additionally, provisions are made for separating data and address phases.

The interface has the following optional features:

- Use of the EPI clock output is controlled by the `CLKPIN` bit in the **EPIGPCFG** register. Unlocked uses include general-purpose I/O and asynchronous interfaces (optionally using RD and WR strobes). Clocked interfaces allow for higher speeds and are much easier to connect to FPGAs and CPLDs (which usually include input clocks).
- EPI clock, if used, may be free running or gated depending on the `CLKGATE` bit in the **EPIGPCFG** register. A free-running EPI clock requires another method for determining when data is live, such as the frame pin or RD/WR strobes. A gated clock approach uses a setup-time model in which the EPI clock controls when transactions are starting and stopping. The gated clock is held high until a new transaction is started and goes high at the end of the cycle where RD/WR/FRAME and address (and data if write) are emitted.
- Use of the ready input (iRDY) from the external device is controlled by the `RDYEN` bit in the **EPIGPCFG** register. The iRDY signal uses `EPIOS27` and may only be used with a free-running clock. iRDY gates transactions, no matter what state they are in. When iRDY is deasserted, the transaction is held off from completing.
- Use of the frame output (FRAME) is controlled by the `FRMPIN` bit in the **EPIGPCFG** register. The frame pin may be used whether the clock is output or not, and whether the clock is free running or not. It may also be used along with the iRDY signal. The frame may be a pulse (one clock) or may be 50/50 split across the frame size (controlled by the `FRM50` bit in the **EPIGPCFG** register). The frame count (the size of the frame as specified by the `FRMCNT` field in the **EPIGPCFG** register) may be between 1 and 15 clocks for pulsed and between 2 and 30 clocks for 50/50. The frame pin counts transactions and not clocks; a transaction is any clock where the RD or WR strobe is high (if used). So, if the `FRMCNT` bit is set, then the frame pin pulses every other transaction; if 2-cycle reads and writes are used, it pulses every other address phase. `FRM50` must be used with this in mind as it may hold state for many clocks waiting for the next transaction.
- Use of the RD and WR outputs is controlled by the `RW` bit in the **EPIGPCFG** register. For interfaces where the direction is known (in advance, related to frame size, or other means), these strobes are not needed. For most other interfaces, RD and WR are used so the external peripheral knows what transaction is taking place, and if any transaction is taking place.
- Separation of address/request and data phases may be used on writes using the `WR2CYC` bit in the **EPIGPCFG** register. This configuration allows the external peripheral extra time to act. Address and data phases must be separated on reads, and the `RD2CYC` bit in the **EPIGPCFG** register must be set. When configured to use an address as specified by the `ASIZE` field in the **EPIGPCFG** register, the address is emitted on the with the RD strobe (first cycle) and data is

expected to be returned on the next cycle (when RD is not asserted). If no address is used, then RD is asserted on the first cycle and data is captured on the second cycle (when RD is not asserted), allowing more setup time for data.

For writes, the output may be in one or two cycles. In the two-cycle case, the address (if any) is emitted on the first cycle with the WR strobe and the data is emitted on the second cycle (with WR not asserted). Although split address and write data phases are not normally needed for logic reasons, it may be useful to make read and write timings match. If 2-cycle reads or writes are used, the RW bit is automatically set.

- Address may be emitted (controlled by the ASIZE field in the **EPIGPCFG** register). The address may be up to 4 bits (16 possible values), up to 12 bits (4096 possible values), or up to 20 bits (1 M possible values). Size of address limits size of data, for example, 4 bits of address support up to 24 bits data. 4-bit address uses EPIOS[27:24]; 12-bit address uses EPIOS[27:16]; 20-bit address uses EPIOS[27:8]. The address signals may be used by the external peripheral as an address, code (command), or for other unrelated uses (such as a chip enable). If the chosen address/data combination does not use all of the EPI signals, the unused pins can be used as GPIOs or for other functions. For example, when using a 4-bit address with an 8-bit data, the pins assigned to EPIS0[23:8] can be assigned to other functions.
- Data may be 8 bits, 16 bits, 24 bits, or 32 bits (controlled by the DSIZE field in the **EPIGPCFG** register). 32-bit data cannot be used with address or EPI clock or any other signal. 24-bit data can only be used with 4-bit address or no address. 32-bit data requires that either the WR2CYC bit or the RD2CYC bit in the **EPIGPCFG** register is set.
- Memory can be used more efficiently by using the Word Access Mode. By default, the EPI controller uses data bits [7:0] when the DSIZE field in the **EPIGPCFG** register is 0x0; data bits [15:0] when the DSIZE field is 0x1; data bits [23:0] when the DSIZE field is 0x2; and data bits [31:0] when the DSIZE field is 0x3. When the WORD bit in the **EPIGPCFG2** register is set, the EPI controller automatically routes bytes of data onto the correct byte lanes such that data can be stored in bits [31:8] for DSIZE=0x0 and bits [31:16] for DSIZE=0x1.
- When using the EPI controller as a GPIO interface, writes are FIFOed (up to 4 can be held at any time), and up to 32 pins are changed using the **EPIBAUD** clock rate specified by COUNT0. As a result, output pin control can be very precisely controlled as a function of time. By contrast, when writing to normal GPIOs, writes can only occur 8-bits at a time and take up to two clock cycles to complete. In addition, the write itself may be further delayed by the bus due to  $\mu$ DMA or draining of a previous write. With both GPIO and the EPI controller, reads may be performed directly, in which case the current pin states are read back. With the EPI controller, the non-blocking interface may also be used to perform reads based on a fixed time rule via the **EPIBAUD** clock rate.

Table 10-7 on page 382 shows how the EPIOS[31:0] signals function while in General-Purpose mode. Notice that the address connections vary depending on the data-width restrictions of the external peripheral.

**Table 10-7. EPI General Purpose Signal Connections**

EPI Signal	General-Purpose Signal (D8, A20)	General- Purpose Signal (D16, A12)	General- Purpose Signal (D24, A4)	General- Purpose Signal (D32)
EPIOS0	D0	D0	D0	D0
EPIOS1	D1	D1	D1	D1
EPIOS2	D2	D2	D2	D2

Table 10-7. EPI General Purpose Signal Connections (*continued*)

EPI Signal	General-Purpose Signal (D8, A20)	General- Purpose Signal (D16, A12)	General- Purpose Signal (D24, A4)	General- Purpose Signal (D32)
EPI0S3	D3	D3	D3	D3
EPI0S4	D4	D4	D4	D4
EPI0S5	D5	D5	D5	D5
EPI0S6	D6	D6	D6	D6
EPI0S7	D7	D7	D7	D7
EPI0S8	A0	D8	D8	D8
EPI0S9	A1	D9	D9	D9
EPI0S10	A2	D10	D10	D10
EPI0S11	A3	D11	D11	D11
EPI0S12	A4	D12	D12	D12
EPI0S13	A5	D13	D13	D13
EPI0S14	A6	D14	D14	D14
EPI0S15	A7	D15	D15	D15
EPI0S16	A8	A0 <sup>a</sup>	D16	D16
EPI0S17	A9	A1	D17	D17
EPI0S18	A10	A2	D18	D18
EPI0S19	A11	A3	D19	D19
EPI0S20	A12	A4	D20	D20
EPI0S21	A13	A5	D21	D21
EPI0S22	A14	A6	D22	D22
EPI0S23	A15	A7	D23	D23
EPI0S24	A16	A8	A0 <sup>b</sup>	D24
EPI0S25	A17	A9	A1	D25
EPI0S26	A18	A10	A2	D26
EPI0S27	A19/iRDY <sup>c</sup>	A11/iRDY <sup>c</sup>	A3/iRDY <sup>c</sup>	D27
EPI0S28	WR	WR	WR	D28
EPI0S29	RD	RD	RD	D29
EPI0S30	Frame	Frame	Frame	D30
EPI0S31	Clock	Clock	Clock	D31

a. In this mode, half-word accesses are used. A0 is the LSB of the address and is equivalent to the system A1 address.

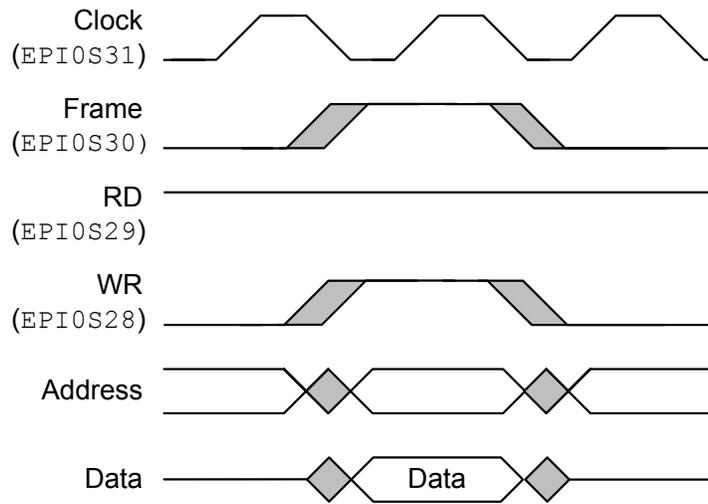
b. In this mode, word accesses are used. A0 is the LSB of the address and is equivalent to the system A2 address.

c. This signal is iRDY if the RDYEN bit in the **EPIGPCFG** register is set.

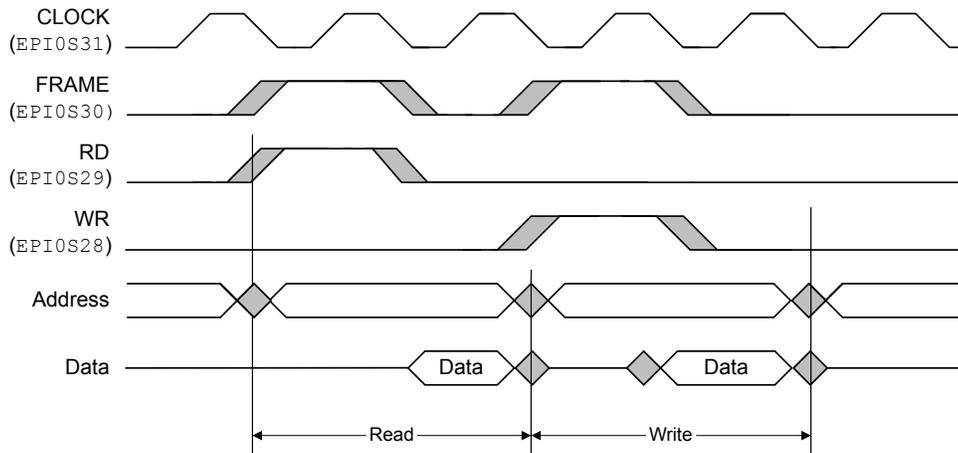
### 10.4.3.1 Bus Operation

A basic access is 1 EPI clock for write cycles and 2 EPI clocks for read cycles. An additional EPI clock can be inserted into a write cycle by setting the WR2CYC bit in the **EPIGPCFG** register. Note that the RD2CYC bit must always be set in the **EPIGPCFG** register. If the iRDY signal is deasserted, further transactions are held off until the iRDY signal is asserted again.

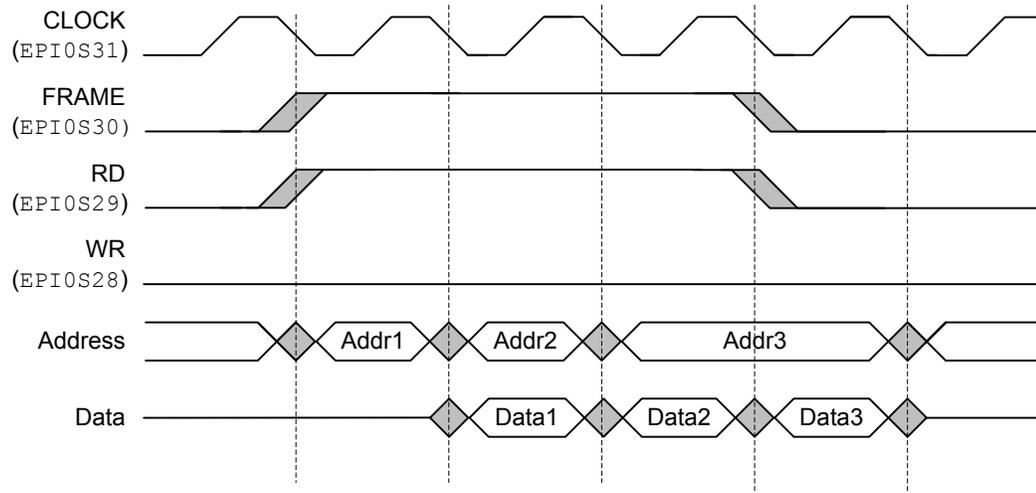
**Figure 10-11. Single-Cycle Write Access, FRM50=0, FRMCNT=0, WRCYC=0**



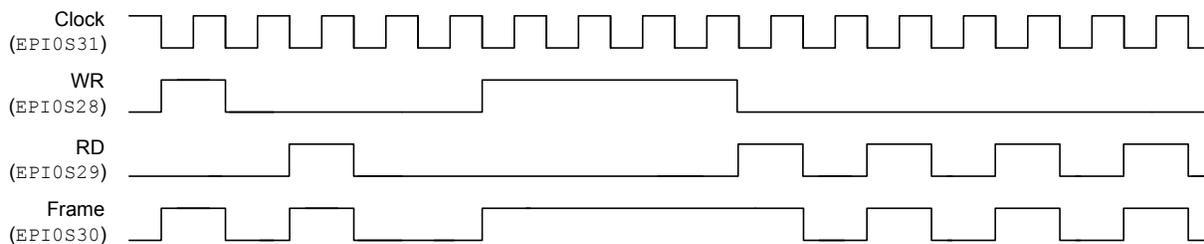
**Figure 10-12. Two-Cycle Read, Write Accesses, FRM50=0, FRMCNT=0, RDCYC=1, WRCYC=1**



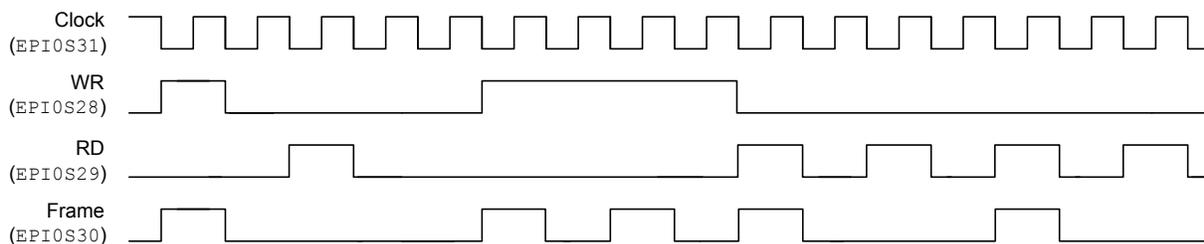


**Figure 10-13. Read Accesses, FRM50=0, FRMCNT=0, RDCYC=1****FRAME Signal Operation**

The operation of the FRAME signal is controlled by the FRMCNT and FRM50 bits. When FRM50 is clear, the FRAME signal is high whenever the WR or RD strobe is high. When FRMCNT is clear, the FRAME signal is simply the logical OR of the WR and RD strobes so the FRAME signal is high during every read or write access, see Figure 10-14 on page 385.

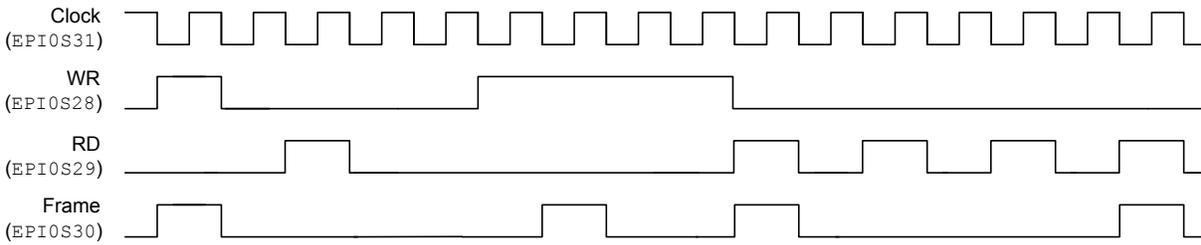
**Figure 10-14. FRAME Signal Operation, FRM50=0 and FRMCNT=0**

If the FRMCNT field is 0x1, then the FRAME signal pulses high during every other read or write access, see Figure 10-15 on page 385.

**Figure 10-15. FRAME Signal Operation, FRM50=0 and FRMCNT=1**

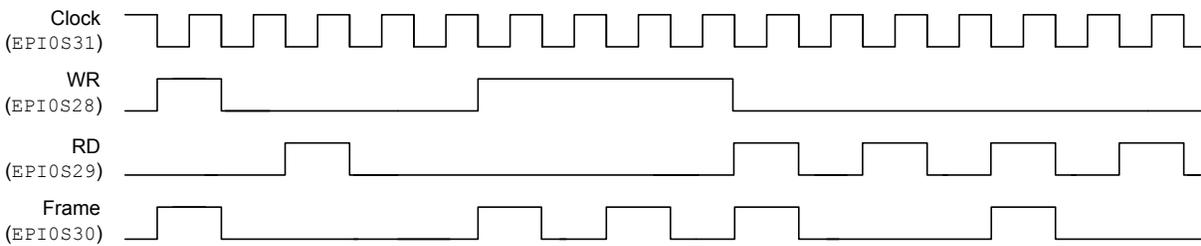
If the FRMCNT field is 0x2 and FRM50 is clear, then the FRAME signal pulses high during every third access, and so on for every value of FRMCNT, see Figure 10-16 on page 386.

**Figure 10-16. FRAME Signal Operation, FRM50=0 and FRMCNT=2**



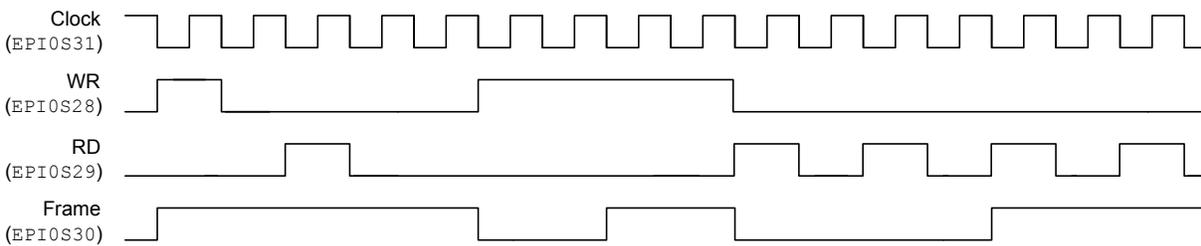
When  $FRM50$  is set, the FRAME signal transitions on the rising edge of either the WR or RD strobes. When  $FRMCNT=0$ , the FRAME signal transitions on the rising edge of WR or RD for every access, see Figure 10-17 on page 386.

**Figure 10-17. FRAME Signal Operation, FRM50=1 and FRMCNT=0**



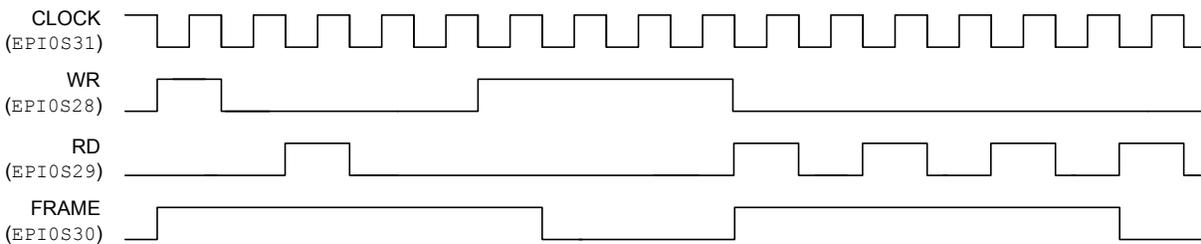
When  $FRMCNT=1$ , the FRAME signal transitions on the rising edge of the WR or RD strobes for every other access, see Figure 10-18 on page 386.

**Figure 10-18. FRAME Signal Operation, FRM50=1 and FRMCNT=1**



When  $FRMCNT=2$ , the FRAME signal transitions the rising edge of the WR or RD strobes for every third access, and so on for every value of  $FRMCNT$ , see Figure 10-19 on page 386.

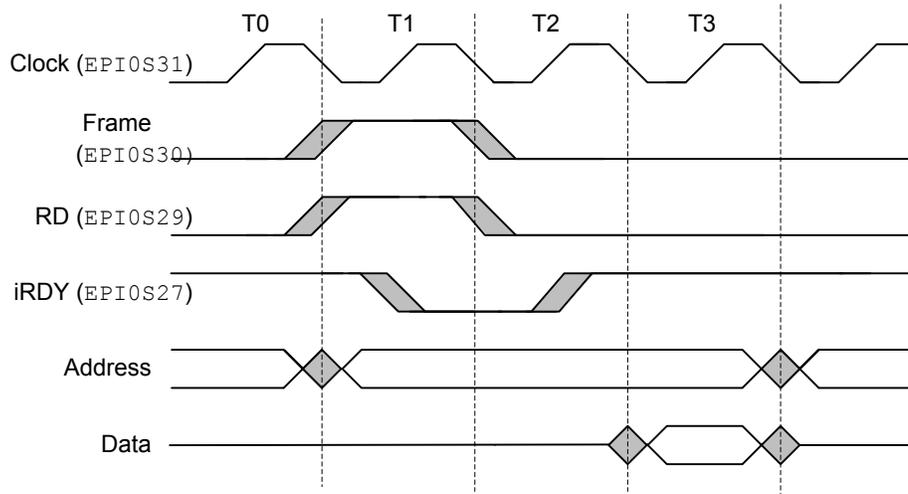
**Figure 10-19. FRAME Signal Operation, FRM50=1 and FRMCNT=2**



### iRDY Signal Operation

The ready input (iRDY) from the external device is enabled by the `RDYEN` bit in the `EPIGPCFG` register. iRDY is input on `EPIOS27` and may only be used with a free-running clock (`CLKGATE` is clear). iRDY is sampled on the falling edge of the EPI clock and gates transactions, no matter what state they are in. Figure 10-20 on page 387 shows the iRDY signal being recognized as deasserted on the falling edge of T1. The `FRAME`, `RD`, Address, Data signals behave as they would during a normal transaction in T1. T2 is the frozen state, and signals are held in this state until iRDY is recognized as asserted again. At the falling edge of T2, when iRDY is asserted again, the cycle continues and completes in T3.

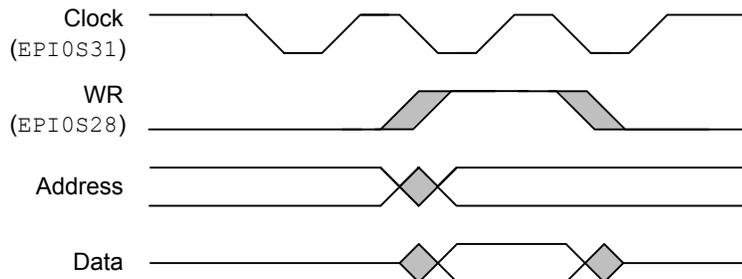
**Figure 10-20. iRDY Signal Operation, `FRM50=0`, `FRMCNT=0`, and `RD2CYC=1`**

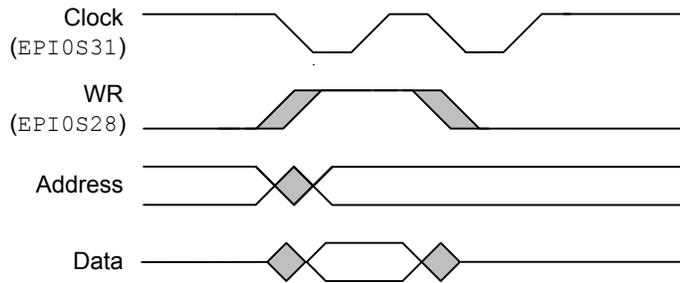


### EPI Clock Operation

If the `CLKGATE` bit in the `EPIGPCFG` register is clear, the EPI clock always toggles when General-purpose mode is enabled. If `CLKGATE` is set, the clock is output only when a transaction is occurring, otherwise the clock is held high. If the `WR2CYC` bit is clear, the EPI clock begins toggling 1 cycle before the `WR` strobe goes high. If the `WR2CYC` bit is set, the EPI clock begins toggling when the `WR` strobe goes high. The clock stops toggling after the first rising edge after the `WR` strobe is deasserted. The `RD` strobe operates in the same manner as the `WR` strobe when the `WR2CYC` bit is set, as the `RD2CYC` bit must always be set. See Figure 10-21 on page 387 and Figure 10-22 on page 388.

**Figure 10-21. EPI Clock Operation, `CLKGATE=1`, `WR2CYC=0`**



**Figure 10-22. EPI Clock Operation, CLKGATE=1, WR2CYC=1**

## 10.5 Register Map

Table 10-8 on page 388 lists the EPI registers. The offset listed is a hexadecimal increment to the register's address, relative to the base address of 0x400D.0000. Note that the EPI controller clock must be enabled before the registers can be programmed (see page 181).

**Note:** A back-to-back write followed by a read of the same register reads the value that written by the first write access, not the value from the second write access. (This situation only occurs when the processor core attempts this action, the  $\mu$ DMA does not do this.). To read back what was just written, another instruction must be generated between the write and read. Read-write does not have this issue, so use of read-write for clear of error interrupt cause is not affected.

**Table 10-8. External Peripheral Interface (EPI) Register Map**

Offset	Name	Type	Reset	Description	See page
0x000	EPICFG	R/W	0x0000.0000	EPI Configuration	390
0x004	EPIBAUD	R/W	0x0000.0000	EPI Main Baud Rate	392
0x010	EPISDRAMCFG	R/W	0x42EE.0000	EPI SDRAM Configuration	394
0x010	EPIHB8CFG	R/W	0x0000.0000	EPI Host-Bus 8 Configuration	396
0x010	EPIHB16CFG	R/W	0x0000.0000	EPI Host-Bus 16 Configuration	400
0x010	EPIGPCFG	R/W	0x0000.0000	EPI General-Purpose Configuration	404
0x014	EPIHB8CFG2	R/W	0x0000.0000	EPI Host-Bus 8 Configuration 2	409
0x014	EPIHB16CFG2	R/W	0x0000.0000	EPI Host-Bus 16 Configuration 2	411
0x014	EPIGPCFG2	R/W	0x0000.0000	EPI General-Purpose Configuration 2	413
0x01C	EPIADDRMAP	R/W	0x0000.0000	EPI Address Map	414
0x020	EPIRSIZE0	R/W	0x0000.0003	EPI Read Size 0	416
0x024	EPIRADDR0	R/W	0x0000.0000	EPI Read Address 0	417
0x028	EPIRPSTD0	R/W	0x0000.0000	EPI Non-Blocking Read Data 0	418
0x030	EPIRSIZE1	R/W	0x0000.0003	EPI Read Size 1	416
0x034	EPIRADDR1	R/W	0x0000.0000	EPI Read Address 1	417
0x038	EPIRPSTD1	R/W	0x0000.0000	EPI Non-Blocking Read Data 1	418

**Table 10-8. External Peripheral Interface (EPI) Register Map (continued)**

Offset	Name	Type	Reset	Description	See page
0x060	EPISTAT	RO	0x0000.0000	EPI Status	420
0x06C	EPIRFIFOCNT	RO	-	EPI Read FIFO Count	422
0x070	EPIREADFIFO	RO	-	EPI Read FIFO	423
0x074	EPIREADFIFO1	RO	-	EPI Read FIFO Alias 1	423
0x078	EPIREADFIFO2	RO	-	EPI Read FIFO Alias 2	423
0x07C	EPIREADFIFO3	RO	-	EPI Read FIFO Alias 3	423
0x080	EPIREADFIFO4	RO	-	EPI Read FIFO Alias 4	423
0x084	EPIREADFIFO5	RO	-	EPI Read FIFO Alias 5	423
0x088	EPIREADFIFO6	RO	-	EPI Read FIFO Alias 6	423
0x08C	EPIREADFIFO7	RO	-	EPI Read FIFO Alias 7	423
0x200	EPIFIFOLVL	R/W	0x0000.0033	EPI FIFO Level Selects	424
0x204	EPIWFIFOCNT	RO	0x0000.0004	EPI Write FIFO Count	426
0x210	EPIIM	R/W	0x0000.0000	EPI Interrupt Mask	427
0x214	EPIRIS	RO	0x0000.0004	EPI Raw Interrupt Status	428
0x218	EPIMIS	RO	0x0000.0000	EPI Masked Interrupt Status	430
0x21C	EPIEISC	R/W1C	0x0000.0000	EPI Error Interrupt Status and Clear	431

## 10.6 Register Descriptions

This section lists and describes the EPI registers, in numerical order by address offset.

## Register 1: EPI Configuration (EPICFG), offset 0x000

**Important:** The `MODE` field determines which configuration register is accessed for offsets 0x010 and 0x014. Any write to the **EPICFG** register resets the register contents at offsets 0x010 and 0x014.

The configuration register is used to enable the block, select a mode, and select the basic pin use (based on the mode). Note that attempting to program an undefined `MODE` field clears the `BLKEN` bit and disables the EPI controller.

### EPI Configuration (EPICFG)

Base 0x400D.0000  
 Offset 0x000  
 Type R/W, reset 0x0000.0000

	31	30	29	28	27	26	25	24	23	22	21	20	19	18	17	16	
	reserved																
Type	RO	RO	RO	RO	RO	RO	RO	RO	RO	RO	RO	RO	RO	RO	RO	RO	
Reset	0	0	0	0	0	0	0	0	0	0	0	0	0	0	0	0	
	15	14	13	12	11	10	9	8	7	6	5	4	3	2	1	0	
	reserved												BLKEN	MODE			
Type	RO	RO	RO	RO	RO	RO	RO	RO	RO	RO	RO	RO	R/W	R/W	R/W	R/W	
Reset	0	0	0	0	0	0	0	0	0	0	0	0	0	0	0	0	

Bit/Field	Name	Type	Reset	Description
31:5	reserved	RO	0x0000.000	Software should not rely on the value of a reserved bit. To provide compatibility with future products, the value of a reserved bit should be preserved across a read-modify-write operation.
4	BLKEN	R/W	0	Block Enable
				Value Description
				1 The EPI controller is enabled.
				0 The EPI controller is disabled.

Bit/Field	Name	Type	Reset	Description
3:0	MODE	R/W	0x0	Mode Select
				Value Description
			0x0	General Purpose General-Purpose mode. Control, address, and data pins are configured using the <b>EPIGPCFG</b> and <b>EPIGPCFG2</b> registers.
			0x1	SDRAM Supports SDR SDRAM. Control, address, and data pins are configured using the <b>EPISDRAMCFG</b> register.
			0x2	8-Bit Host-Bus (HB8) Host-bus 8-bit interface (also known as the MCU interface). Control, address, and data pins are configured using the <b>EPIHB8CFG</b> and <b>EPIHB8CFG2</b> registers.
			0x3	16-Bit Host-Bus (HB16) Host-bus 16-bit interface (standard SRAM). Control, address, and data pins are configured using the <b>EPIHB16CFG</b> and <b>EPIHB16CFG2</b> registers.
			0x3-0xF	Reserved

### Register 2: EPI Main Baud Rate (EPIBAUD), offset 0x004

The system clock is used internally to the EPI Controller. The baud rate counter can be used to divide the system clock down to control the speed on the external interface. If the mode selected emits an external EPI clock, this register defines the EPI clock emitted. If the mode selected does not use an EPI clock, this register controls the speed of changes on the external interface. Care must be taken to program this register properly so that the speed of the external bus corresponds to the speed of the external peripheral and puts acceptable current load on the pins. COUNT0 is the bit field used in all modes except in HB8 and HB16 modes with dual chip selects when different baud rates are selected, see page 409. If different baud rates are used, COUNT0 is associated with the address range specified by CS0 and COUNT1 is associated with the address range specified by CS1.

The COUNTn field is not a straight divider or count. The EPI Clock on EPI0S31 is related to the COUNTn field and the system clock as follows:

If COUNTn = 0,

$$EPIClockFreq = SystemClockFreq$$

otherwise:

$$EPIClockFreq = \frac{SystemClockFreq}{\left( \left\lfloor \frac{COUNTn}{2} \right\rfloor + 1 \right) \times 2}$$

where the symbol around COUNTn/2 is the floor operator, meaning the largest integer less than or equal to COUNTn/2.

So, for example, a COUNTn of 0x0001 results in a clock rate of 1/2(system clock); a COUNTn of 0x0002 or 0x0003 results in a clock rate of 1/4(system clock).

#### EPI Main Baud Rate (EPIBAUD)

Base 0x400D.0000  
 Offset 0x004  
 Type R/W, reset 0x0000.0000

	31	30	29	28	27	26	25	24	23	22	21	20	19	18	17	16
	COUNT1															
Type	RO	RO	RO	RO	RO	RO	RO	RO	RO	RO	RO	RO	RO	RO	RO	RO
Reset	0	0	0	0	0	0	0	0	0	0	0	0	0	0	0	0
	15	14	13	12	11	10	9	8	7	6	5	4	3	2	1	0
	COUNT0															
Type	R/W	R/W	R/W	R/W	R/W	R/W	R/W	R/W	R/W	R/W	R/W	R/W	R/W	R/W	R/W	R/W
Reset	0	0	0	0	0	0	0	0	0	0	0	0	0	0	0	0



---

Bit/Field	Name	Type	Reset	Description
31:16	COUNT1	RO	0x0000	<p>Baud Rate Counter 1</p> <p>This bit field is only valid when the <code>CSCFG</code> field is 0x2 or 0x3 and the <code>CSBAUD</code> bit is set in the <b>EPIHBnCFG2</b> register.</p> <p>This bit field contains a counter used to divide the system clock by the count. The maximum frequency for the external EPI clock is 50 MHz.</p> <p>A count of 0 means the system clock is used as is.</p>
15:0	COUNT0	R/W	0x0000	<p>Baud Rate Counter 0</p> <p>This bit field contains a counter used to divide the system clock by the count. The maximum frequency for the external EPI clock is 50 MHz.</p> <p>A count of 0 means the system clock is used as is.</p>

### Register 3: EPI SDRAM Configuration (EPISDRAMCFG), offset 0x010

**Important:** The `MODE` field in the `EPICFG` register determines which configuration register is accessed for offsets 0x010 and 0x014.

To access `EPISDRAMCFG`, the `MODE` field must be 0x1.

The SDRAM Configuration register is used to specify several parameters for the SDRAM controller. Note that this register is reset when the `MODE` field in the `EPICFG` register is changed. If another mode is selected and the SDRAM mode is selected again, the values must be reinitialized.

The SDRAM interface designed to interface to x16 SDR SDRAMs of 64 MHz or higher, with the address and data pins overlapped (wire ORed on the board). See Table 10-3 on page 368 for pin assignments.

#### EPI SDRAM Configuration (EPISDRAMCFG)

Base 0x400D.0000  
 Offset 0x010  
 Type R/W, reset 0x42EE.0000

	31	30	29	28	27	26	25	24	23	22	21	20	19	18	17	16
	FREQ		reserved			RFSH										
Type	R/W	R/W	RO	RO	RO	R/W	R/W	R/W	R/W	R/W	R/W	R/W	R/W	R/W	R/W	R/W
Reset	0	1	0	0	0	0	1	0	1	1	1	0	1	1	1	0
	15	14	13	12	11	10	9	8	7	6	5	4	3	2	1	0
	reserved						SLEEP	reserved							SIZE	
Type	RO	RO	RO	RO	RO	RO	R/W	RO	RO	RO	RO	RO	RO	RO	R/W	R/W
Reset	0	0	0	0	0	0	0	0	0	0	0	0	0	0	0	0

Bit/Field	Name	Type	Reset	Description										
31:30	FREQ	R/W	0x1	Frequency Range  This field configures the frequency range of the system clock. This field must be configured correctly to ensure proper operation. This field does not affect the refresh counting, which is configured separately using the <code>RFSH</code> field (and is based on system clock rate and number of rows per bank). The ranges are:  <table border="0"> <tr> <td>Value</td> <td>Description</td> </tr> <tr> <td>0x0</td> <td>0 - 15 MHz</td> </tr> <tr> <td>0x1</td> <td>15 - 30 MHz</td> </tr> <tr> <td>0x2</td> <td>30 - 50 MHz</td> </tr> <tr> <td>0x3</td> <td>50 - 100 MHz</td> </tr> </table>	Value	Description	0x0	0 - 15 MHz	0x1	15 - 30 MHz	0x2	30 - 50 MHz	0x3	50 - 100 MHz
Value	Description													
0x0	0 - 15 MHz													
0x1	15 - 30 MHz													
0x2	30 - 50 MHz													
0x3	50 - 100 MHz													
29:27	reserved	RO	0x0	Software should not rely on the value of a reserved bit. To provide compatibility with future products, the value of a reserved bit should be preserved across a read-modify-write operation.										
26:16	RFSH	R/W	0x2EE	Refresh Counter  This field contains the refresh counter in system clocks. The reset value of 0x2EE provides a refresh period of 64 ms when using a 50 MHz clock.										
15:10	reserved	RO	0x0	Software should not rely on the value of a reserved bit. To provide compatibility with future products, the value of a reserved bit should be preserved across a read-modify-write operation.										

Bit/Field	Name	Type	Reset	Description
9	SLEEP	R/W	0	<p>Sleep Mode</p> <p>Value Description</p> <p>1 The SDRAM is put into low power state, but is self-refreshed.</p> <p>0 No effect.</p>
8:2	reserved	RO	0x00	Software should not rely on the value of a reserved bit. To provide compatibility with future products, the value of a reserved bit should be preserved across a read-modify-write operation.
1:0	SIZE	R/W	0x0	<p>Size of SDRAM</p> <p>The value of this field affects address pins and behavior.</p> <p>Value Description</p> <p>0x0 64 megabits (8MB)</p> <p>0x1 128 megabits (16MB)</p> <p>0x2 256 megabits (32MB)</p> <p>0x3 512 megabits (64MB)</p>

## Register 4: EPI Host-Bus 8 Configuration (EPIHB8CFG), offset 0x010

**Important:** The `MODE` field in the `EPICFG` register determines which configuration register is accessed for offsets 0x010 and 0x014.

To access `EPIHB8CFG`, the `MODE` field must be 0x2.

The Host Bus 8 Configuration register is activated when the HB8 mode is selected. The HB8 mode supports muxed address/data (overlay of lower 8 address and all 8 data pins), separated address/data, and address-less FIFO mode. Note that this register is reset when the `MODE` field in the `EPICFG` register is changed. If another mode is selected and the HB8 mode is selected again, the values must be reinitialized.

This mode is intended to support SRAMs, Flash memory (read), FIFOs, CPLDs/FPGAs, and devices with an MCU/HostBus slave or 8-bit FIFO interface support.

Refer to Table 10-5 on page 373 for information on signal configuration controlled by this register and the `EPIHB8CFG2` register.

If less address pins are required, the corresponding `AFSEL` bit (page 328) should not be enabled so the EPI controller does not drive those pins, and they are available as standard GPIOs.

There is no direct chip enable (CE) model. Instead, CE can be handled in one of three ways:

1. Manually control via GPIOs.
2. Associate one or more upper address pins to CE. Because CE is normally CEn, lower addresses are not used. For example, if pins `EPI0S27` and `EPI0S26` are used for Device 1 and 0 respectively, then address 0x6800.0000 accesses Device 0 (Device 1 has its CEn high), and 0x6400.0000 accesses Device 1 (Device 0 has its CEn high). The pull-up behavior on the corresponding GPIOs must be properly configured to ensure that the pins are disabled when the interface is not in use.
3. With certain SRAMs, the ALE can be used as CEn because the address remains stable after the ALE strobe. The subsequent `WRn` or `RDn` signals write or read when ALE is low thus providing CEn functionality.

### EPI Host-Bus 8 Configuration (EPIHB8CFG)

Base 0x400D.0000  
 Offset 0x010  
 Type R/W, reset 0x0000.0000

	31	30	29	28	27	26	25	24	23	22	21	20	19	18	17	16
	reserved								XFFEN	XFEEN	WRHIGH	RDHIGH	reserved			
Type	RO	RO	RO	RO	RO	RO	RO	RO	R/W	R/W	R/W	R/W	RO	RO	RO	RO
Reset	0	0	0	0	0	0	0	0	0	0	0	0	0	0	0	0
	15	14	13	12	11	10	9	8	7	6	5	4	3	2	1	0
	MAXWAIT								WRWS		RDWS		reserved		MODE	
Type	R/W	R/W	R/W	R/W	R/W	R/W	R/W	R/W	R/W	R/W	R/W	R/W	RO	RO	R/W	R/W
Reset	0	0	0	0	0	0	0	0	0	0	0	0	0	0	0	0

Bit/Field	Name	Type	Reset	Description
31:24	reserved	RO	0x00	Software should not rely on the value of a reserved bit. To provide compatibility with future products, the value of a reserved bit should be preserved across a read-modify-write operation.

Bit/Field	Name	Type	Reset	Description
23	XFFEN	R/W	0	External FIFO FULL Enable  Value Description 1 An external FIFO full signal can be used to control write cycles. If this bit is set and the FFULL full signal is high, XFIFO writes are stalled. 0 No effect.
22	XFEEN	R/W	0	External FIFO EMPTY Enable  Value Description 1 An external FIFO empty signal can be used to control read cycles. If this bit is set and the FEMPTY signal is high, XFIFO reads are stalled. 0 No effect.
21	WRHIGH	R/W	0	WRITE Strobe Polarity  Value Description 1 The WRITE strobe is WRn (active low). 0 The WRITE strobe is WR (active high).  If both CS0n and CS1n are enabled (the CSCFG field in the <b>EPIHB8CFG2</b> register is 0x2 or 0x3), the programmed write strobe polarity is used for both CS0n and CS1n accesses.
20	RDHIGH	R/W	0	READ Strobe Polarity  Value Description 1 The READ strobe is RDn (active low). 0 The READ strobe is RD (active high).  If both CS0n and CS1n are enabled (the CSCFG field in the <b>EPIHB8CFG2</b> register is 0x2 or 0x3), the programmed read strobe polarity is used for both CS0n and CS1n accesses.
19:16	reserved	RO	0x0	Software should not rely on the value of a reserved bit. To provide compatibility with future products, the value of a reserved bit should be preserved across a read-modify-write operation.
15:8	MAXWAIT	R/W	0x00	Maximum Wait  This field defines the maximum number of external clocks to wait while an external FIFO ready signal is holding off a transaction (FFULL and FEMPTY).  When this field is clear, the transaction is held off forever.  <b>Note:</b> When the <b>MODE</b> field is configured to be 0x2 and the <b>BLKEN</b> bit is set in the <b>EPICFG</b> register, enabling HB8 mode, this field defaults to 0xFF.

Bit/Field	Name	Type	Reset	Description
7:6	WRWS	R/W	0x0	<p>Write Wait States</p> <p>This field adds wait states to the data phase (the address phase is not affected). The effect is to delay the rising edge of WRn (or the falling edge of WR). Each wait state adds 2 EPI clock cycles to the access time.</p> <p>Value Description</p> <p>0x0 No wait states.</p> <p>0x1 1 wait state.</p> <p>0x2 2 wait states.</p> <p>0x3 3 wait states.</p> <p>This field is used in conjunction with the <b>EPIBAUD</b> register.</p> <p>If both CS0n and CS1n are enabled (the <b>CSCFG</b> field in the <b>EPIHB8CFG2</b> register is 0x2 or 0x3), the same number of wait states is added to both CS0n and CS1n accesses.</p>
5:4	RDWS	R/W	0x0	<p>Read Wait States</p> <p>This field adds wait states to the data phase (the address phase is not affected). The effect is to delay the rising edge of RDn/Oen (or the falling edge of RD). Each wait state adds 2 EPI clock cycles to the access time.</p> <p>Value Description</p> <p>0x0 No wait states.</p> <p>0x1 1 wait state.</p> <p>0x2 2 wait states.</p> <p>0x3 3 wait states.</p> <p>This field is used in conjunction with the <b>EPIBAUD</b> register.</p> <p>If both CS0n and CS1n are enabled (the <b>CSCFG</b> field in the <b>EPIHB8CFG2</b> register is 0x2 or 0x3), the same number of wait states is added to both CS0n and CS1n accesses.</p>
3:2	reserved	RO	0x0	<p>Software should not rely on the value of a reserved bit. To provide compatibility with future products, the value of a reserved bit should be preserved across a read-modify-write operation.</p>

Bit/Field	Name	Type	Reset	Description
1:0	MODE	R/W	0x0	<p>Host Bus Sub-Mode</p> <p>This field determines which of four Host Bus 8 sub-modes to use. Sub-mode use is determined by the connected external peripheral. See Table 10-5 on page 373 for information on how this bit field affects the operation of the EPI signals.</p> <p>Value Description</p> <p>0x0 ADMUX – AD[7:0] Data and Address are muxed.</p> <p>0x1 ADNONMUX – D[7:0] Data and address are separate.</p> <p>0x2 Continuous Read - D[7:0] This mode is the same as ADNONMUX, but uses address switch for multiple reads instead of OEn strobing.</p> <p>0x3 XFIFO – D[7:0] This mode adds XFIFO controls with sense of XFIFO full and XFIFO empty. This mode uses no address or ALE.</p>

## Register 5: EPI Host-Bus 16 Configuration (EPIHB16CFG), offset 0x010

**Important:** The `MODE` field in the `EPICFG` register determines which configuration register is accessed for offsets 0x010 and 0x014.

To access `EPIHB16CFG`, the `MODE` field must be 0x3.

The Host Bus 16 sub-configuration register is activated when the HB16 mode is selected. The HB16 mode supports muxed address/data (overlay of lower 16 address and all 16 data pins), separated address/data, and address-less FIFO mode. Note that this register is reset when the `MODE` field in the `EPICFG` register is changed. If another mode is selected and the HB16 mode is selected again, the values must be reinitialized.

This mode is intended to support SRAMs, Flash memory (read), FIFOs, and CPLDs/FPGAs, and devices with an MCU/HostBus slave or 16-bit FIFO interface support.

Refer to Table 10-6 on page 374 for information on signal configuration controlled by this register and the `EPIHB16CFG2` register.

If less address pins are required, the corresponding `AFSEL` bit (page 328) should not be enabled so the EPI controller does not drive those pins, and they are available as standard GPIOs.

There is no direct chip enable (CE) model. Instead, CE can be handled in one of three ways:

1. Manually control via GPIOs.
2. Associate one or more upper address pins to CE. Because CE is normally CEn, lower addresses are not used. For example, if pins `EPI0S27` and `EPI0S26` are used for Device 1 and 0 respectively, then address 0x6800.0000 accesses Device 0 (Device 1 has its CEn high), and 0x6400.0000 accesses Device 1 (Device 0 has its CEn high). The pull-up behavior on the corresponding GPIOs must be properly configured to ensure that the pins are disabled when the interface is not in use.
3. With certain SRAMs, the ALE can be used as CEn because the address remains stable after the ALE strobe. The subsequent WRn or RDn signals write or read when ALE is low thus providing CEn functionality.

### EPI Host-Bus 16 Configuration (EPIHB16CFG)

Base 0x400D.0000  
 Offset 0x010  
 Type R/W, reset 0x0000.0000

	31	30	29	28	27	26	25	24	23	22	21	20	19	18	17	16
	reserved								XFFEN	XFEEN	WRHIGH	RDHIGH	reserved			
Type	RO	RO	RO	RO	RO	RO	RO	RO	R/W	R/W	R/W	R/W	RO	RO	RO	RO
Reset	0	0	0	0	0	0	0	0	0	0	0	0	0	0	0	0
	15	14	13	12	11	10	9	8	7	6	5	4	3	2	1	0
	MAXWAIT								WRWS		RDWS		reserved	BSEL	MODE	
Type	R/W	R/W	R/W	R/W	R/W	R/W	R/W	R/W	R/W	R/W	R/W	R/W	RO	R/W	R/W	R/W
Reset	0	0	0	0	0	0	0	0	0	0	0	0	0	0	0	0

Bit/Field	Name	Type	Reset	Description
31:24	reserved	RO	0x00	Software should not rely on the value of a reserved bit. To provide compatibility with future products, the value of a reserved bit should be preserved across a read-modify-write operation.



Bit/Field	Name	Type	Reset	Description
23	XFFEN	R/W	0	External FIFO FULL Enable  Value Description 1 An external FIFO full signal can be used to control write cycles. If this bit is set and the FFULL signal is high, XFIFO writes are stalled. 0 No effect.
22	XFEEN	R/W	0	External FIFO EMPTY Enable  Value Description 1 An external FIFO empty signal can be used to control read cycles. If this bit is set and the FEMPTY signal is high, XFIFO reads are stalled. 0 No effect.
21	WRHIGH	R/W	0	WRITE Strobe Polarity  Value Description 1 The WRITE strobe is WRn (active low). 0 The WRITE strobe is WR (active high).  If both CS0n and CS1n are enabled (the CSCFG field in the <b>EPIHB16CFG2</b> register is 0x2 or 0x3), the programmed write strobe polarity is used for both CS0n and CS1n accesses.
20	RDHIGH	R/W	0	READ Strobe Polarity  Value Description 1 The READ strobe is RDn (active low). 0 The READ strobe is RD (active high).  If both CS0n and CS1n are enabled (the CSCFG field in the <b>EPIHB16CFG2</b> register is 0x2 or 0x3), the programmed read strobe polarity is used for both CS0n and CS1n accesses.
19:16	reserved	RO	0x0	Software should not rely on the value of a reserved bit. To provide compatibility with future products, the value of a reserved bit should be preserved across a read-modify-write operation.
15:8	MAXWAIT	R/W	0x00	Maximum Wait  This field defines the maximum number of external clocks to wait while an external FIFO ready signal is holding off a transaction (FFULL and FEMPTY).  When this field is clear, the transaction is held off forever.  <b>Note:</b> When the MODE field is configured to be 0x3 and the BLKEN bit is set in the EPICFG register, enabling HB16 mode, this field defaults to 0xFF.

Bit/Field	Name	Type	Reset	Description
7:6	WRWS	R/W	0x0	<p>Write Wait States</p> <p>This field adds wait states to the data phase (the address phase is not affected). The effect is to delay the rising edge of WRn (or the falling edge of WR). Each wait state adds 2 EPI clock cycles to the access time.</p> <p>Value Description</p> <p>0x0 No wait states.</p> <p>0x1 1 wait state.</p> <p>0x2 2 wait states.</p> <p>0x3 3 wait states.</p> <p>This field is used in conjunction with the <b>EPIBAUD</b> register.</p> <p>If both CS0n and CS1n are enabled (the <b>CSCFG</b> field in the <b>EPIHB16CFG2</b> register is 0x2 or 0x3), the same number of wait states is added to both CS0n and CS1n accesses.</p>
5:4	RDWS	R/W	0x0	<p>Read Wait States</p> <p>This field adds wait states to the data phase (the address phase is not affected). The effect is to delay the rising edge of RDn/Oen (or the falling edge of RD). Each wait state adds 2 EPI clock cycles to the access time.</p> <p>Value Description</p> <p>0x0 No wait states.</p> <p>0x1 1 wait state.</p> <p>0x2 2 wait states.</p> <p>0x3 3 wait states.</p> <p>This field is used in conjunction with the <b>EPIBAUD</b> register.</p> <p>If both CS0n and CS1n are enabled (the <b>CSCFG</b> field in the <b>EPIHB16CFG2</b> register is 0x2 or 0x3), the same number of wait states is added to both CS0n and CS1n accesses.</p>
3	reserved	RO	0	<p>Software should not rely on the value of a reserved bit. To provide compatibility with future products, the value of a reserved bit should be preserved across a read-modify-write operation.</p>
2	BSEL	R/W	0	<p>Byte Select Configuration</p> <p>This bit enables byte select operation.</p> <p>Value Description</p> <p>0 No Byte Selects</p> <p>Data is read and written as 16 bits.</p> <p>1 Enable Byte Selects</p> <p>Two EPI signals function as byte select signals to allow 8-bit transfers. See Table 10-6 on page 374 for details on which EPI signals are used.</p>

Bit/Field	Name	Type	Reset	Description
1:0	MODE	R/W	0x0	<p>Host Bus Sub-Mode</p> <p>This field determines which of three Host Bus 16 sub-modes to use. Sub-mode use is determined by the connected external peripheral. See Table 10-6 on page 374 for information on how this bit field affects the operation of the EPI signals.</p> <p>Value Description</p> <p>0x0 ADMUX – AD[15:0] Data and Address are muxed.</p> <p>0x1 ADNONMUX – D[15:0] Data and address are separate. This mode is not practical in HB16 mode for normal peripherals because there are generally not enough address bits available.</p> <p>0x2 Continuous Read - D[15:0] This mode is the same as ADNONMUX, but uses address switch for multiple reads instead of OEn strobing. This mode is not practical in HB16 mode for normal SRAMs because there are generally not enough address bits available.</p> <p>0x3 XFIFO – D[15:0] This mode adds XFIFO controls with sense of XFIFO full and XFIFO empty. This mode uses no address or ALE.</p>

## Register 6: EPI General-Purpose Configuration (EPIGPCFG), offset 0x010

**Important:** The `MODE` field in the `EPICFG` register determines which configuration register is accessed for offsets 0x010 and 0x014.

To access `EPIGPCFG`, the `MODE` field must be 0x0.

The `RD2CYC` bit must be set at all times in General-Purpose mode to ensure proper operation.

The General-Purpose configuration register is used to configure the control, data, and address pins. This mode can be used for custom interfaces with FPGAs, CPLDs, and for digital data acquisition and actuator control. Note that this register is reset when the `MODE` field in the `EPICFG` register is changed. If another mode is selected and the General-purpose mode is selected again, the register the values must be reinitialized.

This mode is designed for 3 general types of use:

- Extremely high-speed clocked interfaces to FPGAs and CPLDs, with 3 sizes of data and optional address. Framing and clock-enable permit more optimized interfaces.
- General parallel GPIO. From 1 to 32 pins may be written or read, with the speed precisely controlled by the baud rate in the `EPIBAUD` register (when used with the `NBRFIFO` and/or the `WFIFO`) or by rate of accesses from software or  $\mu$ DMA.
- General custom interfaces of any speed.

The configuration allows for choice of an output clock (free running or gated), a framing signal (with frame size), a ready input (to stretch transactions), read and write strobes, address of varying sizes, and data of varying sizes. Additionally, provisions are made for splitting address and data phases on the external interface.

### EPI General-Purpose Configuration (EPIGPCFG)

Base 0x400D.0000  
Offset 0x010  
Type R/W, reset 0x0000.0000

	31	30	29	28	27	26	25	24	23	22	21	20	19	18	17	16
	CLKPIN	CLKGATE	reserved	RDYEN	FRMPIN	FRM50	FRMCNT			RW	reserved	WR2CYC	RD2CYC	reserved		
Type	R/W	R/W	RO	R/W	R/W	R/W	R/W	R/W	R/W	R/W	R/W	RO	R/W	R/W	RO	RO
Reset	0	0	0	0	0	0	0	0	0	0	0	0	0	0	0	0
	15	14	13	12	11	10	9	8	7	6	5	4	3	2	1	0
	MAXWAIT							reserved		ASIZE		reserved		DSIZE		
Type	R/W	R/W	R/W	R/W	R/W	R/W	R/W	R/W	RO	RO	R/W	R/W	RO	RO	R/W	R/W
Reset	0	0	0	0	0	0	0	0	0	0	0	0	0	0	0	0

Bit/Field	Name	Type	Reset	Description
31	CLKPIN	R/W	0	Clock Pin

Value	Description
1	<code>EPIOS31</code> functions as the EPI clock output.
0	No clock output.

The EPI clock is generated from the `COUNT0` field in the `EPIBAUD` register (as is the system clock which is divided down from it).

Bit/Field	Name	Type	Reset	Description
30	CLKGATE	R/W	0	<p>Clock Gated</p> <p>Value Description</p> <p>1 The EPI clock is output only when there is data to write or read (current transaction); otherwise the EPI clock is held low.</p> <p>0 The EPI clock is free running.</p> <p>Note that <code>EPIOS27</code> is an <code>iRDY</code> signal if <code>RDYEN</code> is set. <code>CLKGATE</code> is ignored if <code>CLKPIN</code> is 0 or if the <code>COUNT0</code> field in the <code>EPIBAUD</code> register is cleared.</p>
29	reserved	RO	0	Software should not rely on the value of a reserved bit. To provide compatibility with future products, the value of a reserved bit should be preserved across a read-modify-write operation.
28	RDYEN	R/W	0	<p>Ready Enable</p> <p>Value Description</p> <p>1 The external peripheral drives an <code>iRDY</code> signal into pin <code>EPIOS27</code>.</p> <p>0 The external peripheral does not drive an <code>iRDY</code> signal and is assumed to be ready always.</p> <p>The ready enable signal may only be used with a free-running EPI clock (<code>CLKGATE=0</code>).</p> <p>The external <code>iRDY</code> signal is sampled on the falling edge of the EPI clock. Setup and hold times must be met to ensure registration on the next falling EPI clock edge.</p> <p>This bit is ignored if <code>CLKPIN</code> is 0 or <code>CLKGATE</code> is 1.</p>
27	FRMPIN	R/W	0	<p>Framing Pin</p> <p>Value Description</p> <p>1 A framing signal is output on <code>EPIOS30</code>.</p> <p>0 No framing signal is output.</p> <p>Framing has no impact on data itself, but forms a context for the external peripheral. When used with a free-running EPI clock, the <code>FRAME</code> signal forms the valid signal. When used with a gated EPI clock, it is usually used to form a frame size.</p>
26	FRM50	R/W	0	<p>50/50 Frame</p> <p>Value Description</p> <p>1 The <code>FRAME</code> signal is output as 50/50 duty cycle using count (see <code>FRMCNT</code>).</p> <p>0 The <code>FRAME</code> signal is output as a single pulse, and then held low for the count.</p> <p>This bit is ignored if <code>FRMPIN</code> is 0.</p>

Bit/Field	Name	Type	Reset	Description						
25:22	FRMCNT	R/W	0x0	<p>Frame Count</p> <p>This field specifies the size of the frame in EPI clocks. The frame counter is used to determine the frame size. The count is FRMCNT+1. So, a FRMCNT of 0 forms a pure transaction valid signal (held high during transactions, low otherwise).</p> <p>A FRMCNT of 0 with FRM50 set inverts the FRAME signal on each transaction. A FRMCNT of 1 means the FRAME signal is inverted every other transaction; a value of 15 means every sixteenth transaction.</p> <p>If FRM50 is set, the frame is held high for FRMCNT+1 transactions, then held low for that many transactions, and so on.</p> <p>If FRM50 is clear, the frame is pulsed high for one EPI clock and then low for FRMCNT EPI clocks.</p> <p>This field is ignored if FRMPIN is 0.</p>						
21	RW	R/W	0	<p>Read and Write</p> <table border="0"> <thead> <tr> <th>Value</th> <th>Description</th> </tr> </thead> <tbody> <tr> <td>1</td> <td>RD and WR strobes are asserted on EPI0S29 and EPI0S28. RD is asserted high on the rising edge of the EPI clock when a read is being performed. WR is asserted high on the rising edge of the EPI clock when a write is being performed</td> </tr> <tr> <td>0</td> <td>RD and WR strobes are not output.</td> </tr> </tbody> </table> <p>This bit is forced to 1 when RD2CYC and/or WR2CYC is 1.</p>	Value	Description	1	RD and WR strobes are asserted on EPI0S29 and EPI0S28. RD is asserted high on the rising edge of the EPI clock when a read is being performed. WR is asserted high on the rising edge of the EPI clock when a write is being performed	0	RD and WR strobes are not output.
Value	Description									
1	RD and WR strobes are asserted on EPI0S29 and EPI0S28. RD is asserted high on the rising edge of the EPI clock when a read is being performed. WR is asserted high on the rising edge of the EPI clock when a write is being performed									
0	RD and WR strobes are not output.									
20	reserved	RO	0	<p>Software should not rely on the value of a reserved bit. To provide compatibility with future products, the value of a reserved bit should be preserved across a read-modify-write operation.</p>						
19	WR2CYC	R/W	0	<p>2-Cycle Writes</p> <table border="0"> <thead> <tr> <th>Value</th> <th>Description</th> </tr> </thead> <tbody> <tr> <td>1</td> <td>Writes are two EPI clock cycles long, with address on one EPI clock cycle (with the WR strobe asserted) and data written on the following EPI clock cycle (with WR strobe de-asserted). The next address (if any) is in the cycle following.</td> </tr> <tr> <td>0</td> <td>Data is output on the same EPI clock cycle as the address.</td> </tr> </tbody> </table> <p>When this bit is set, then the RW bit is forced to be set.</p>	Value	Description	1	Writes are two EPI clock cycles long, with address on one EPI clock cycle (with the WR strobe asserted) and data written on the following EPI clock cycle (with WR strobe de-asserted). The next address (if any) is in the cycle following.	0	Data is output on the same EPI clock cycle as the address.
Value	Description									
1	Writes are two EPI clock cycles long, with address on one EPI clock cycle (with the WR strobe asserted) and data written on the following EPI clock cycle (with WR strobe de-asserted). The next address (if any) is in the cycle following.									
0	Data is output on the same EPI clock cycle as the address.									
18	RD2CYC	R/W	0	<p>2-Cycle Reads</p> <table border="0"> <thead> <tr> <th>Value</th> <th>Description</th> </tr> </thead> <tbody> <tr> <td>1</td> <td>Reads are two EPI clock cycles, with address on one EPI clock cycle (with the RD strobe asserted) and data captured on the following EPI clock cycle (with the RD strobe de-asserted). The next address (if any) is in the cycle following.</td> </tr> <tr> <td>0</td> <td>Data is captured on the EPI clock cycle with READ strobe asserted.</td> </tr> </tbody> </table> <p>When this bit is set, then the RW bit is forced to be set.</p> <p><b>Caution – This bit must be set at all times in General-Purpose mode to ensure proper operation.</b></p>	Value	Description	1	Reads are two EPI clock cycles, with address on one EPI clock cycle (with the RD strobe asserted) and data captured on the following EPI clock cycle (with the RD strobe de-asserted). The next address (if any) is in the cycle following.	0	Data is captured on the EPI clock cycle with READ strobe asserted.
Value	Description									
1	Reads are two EPI clock cycles, with address on one EPI clock cycle (with the RD strobe asserted) and data captured on the following EPI clock cycle (with the RD strobe de-asserted). The next address (if any) is in the cycle following.									
0	Data is captured on the EPI clock cycle with READ strobe asserted.									

Bit/Field	Name	Type	Reset	Description										
17:16	reserved	RO	0x0	Software should not rely on the value of a reserved bit. To provide compatibility with future products, the value of a reserved bit should be preserved across a read-modify-write operation.										
15:8	MAXWAIT	R/W	0x00	<p>Maximum Wait</p> <p>This field defines the maximum number of EPI clocks to wait while the iRDY signal (see RDYEN) is holding off a transaction. If this field is 0, the transaction is held forever. If the maximum wait of 255 clocks (MAXWAIT=0xFF) is exceeded, an error interrupt occurs and the transaction is aborted/ignored.</p> <p><b>Note:</b> When the MODE field is configured to be 0x0 and the BLKEN bit is set in the EPICFG register, enabling General-Purpose mode, this field defaults to 0xFF.</p>										
7:6	reserved	RO	0x0	Software should not rely on the value of a reserved bit. To provide compatibility with future products, the value of a reserved bit should be preserved across a read-modify-write operation.										
5:4	ASIZE	R/W	0x0	<p>Address Bus Size</p> <p>This field defines the size of the address bus. The address can be up to 4-bits wide with a 24-bit data bus, up to 12-bits wide with a 16-bit data bus, and up to 20-bits wide with an 8-bit data bus. If the full address bus is not used, use the least significant address bits. Any unused address bits can be used as GPIOs by clearing the AFSEL bit for the corresponding GPIOs. Also, if RDYEN is 1, then the address sizes are 1 smaller (3, 11, 19).</p> <p>The values are:</p> <table border="1"> <thead> <tr> <th>Value</th> <th>Description</th> </tr> </thead> <tbody> <tr> <td>0x0</td> <td>No address</td> </tr> <tr> <td>0x1</td> <td>Up to 4 bits wide.</td> </tr> <tr> <td>0x2</td> <td>Up to 12 bits wide. This size cannot be used with 24-bit data.</td> </tr> <tr> <td>0x3</td> <td>Up to 20 bits wide. This size cannot be used with data sizes other than 8.</td> </tr> </tbody> </table>	Value	Description	0x0	No address	0x1	Up to 4 bits wide.	0x2	Up to 12 bits wide. This size cannot be used with 24-bit data.	0x3	Up to 20 bits wide. This size cannot be used with data sizes other than 8.
Value	Description													
0x0	No address													
0x1	Up to 4 bits wide.													
0x2	Up to 12 bits wide. This size cannot be used with 24-bit data.													
0x3	Up to 20 bits wide. This size cannot be used with data sizes other than 8.													
3:2	reserved	RO	0x0	Software should not rely on the value of a reserved bit. To provide compatibility with future products, the value of a reserved bit should be preserved across a read-modify-write operation.										

Bit/Field	Name	Type	Reset	Description										
1:0	DSIZE	R/W	0x0	<p>Size of Data Bus</p> <p>This field defines the size of the data bus (starting at <code>EPI0S0</code>). Subsets of these numbers can be created by clearing the <code>AFSEL</code> bit for the corresponding GPIOs. Note that size 32 may not be used with clock, frame, address, or other control.</p> <p>The values are:</p> <table><thead><tr><th>Value</th><th>Description</th></tr></thead><tbody><tr><td>0x0</td><td>8 Bits Wide (<code>EPI0S0</code> to <code>EPI0S7</code>)</td></tr><tr><td>0x1</td><td>16 Bits Wide (<code>EPI0S0</code> to <code>EPI0S15</code>)</td></tr><tr><td>0x2</td><td>24 Bits Wide (<code>EPI0S0</code> to <code>EPI0S23</code>)</td></tr><tr><td>0x3</td><td>32 Bits Wide (<code>EPI0S0</code> to <code>EPI0S31</code>)</td></tr></tbody></table> <p>This size may not be used with an EPI clock. This value is normally used for acquisition input and actuator control as well as other general-purpose uses that require 32 bits per direction.</p>	Value	Description	0x0	8 Bits Wide ( <code>EPI0S0</code> to <code>EPI0S7</code> )	0x1	16 Bits Wide ( <code>EPI0S0</code> to <code>EPI0S15</code> )	0x2	24 Bits Wide ( <code>EPI0S0</code> to <code>EPI0S23</code> )	0x3	32 Bits Wide ( <code>EPI0S0</code> to <code>EPI0S31</code> )
Value	Description													
0x0	8 Bits Wide ( <code>EPI0S0</code> to <code>EPI0S7</code> )													
0x1	16 Bits Wide ( <code>EPI0S0</code> to <code>EPI0S15</code> )													
0x2	24 Bits Wide ( <code>EPI0S0</code> to <code>EPI0S23</code> )													
0x3	32 Bits Wide ( <code>EPI0S0</code> to <code>EPI0S31</code> )													



## Register 7: EPI Host-Bus 8 Configuration 2 (EPIHB8CFG2), offset 0x014

**Important:** The `MODE` field in the `EPICFG` register determines which configuration register is accessed for offsets 0x010 and 0x014.

To access `EPIHB8CFG2`, the `MODE` field must be 0x2.

This register is used to configure operation while in Host-Bus 8 mode. Note that this register is reset when the `MODE` field in the `EPICFG` register is changed. If another mode is selected and the Host-Bus 8 mode is selected again, the values must be reinitialized.

### EPI Host-Bus 8 Configuration 2 (EPIHB8CFG2)

Base 0x400D.0000

Offset 0x014

Type R/W, reset 0x0000.0000

	31	30	29	28	27	26	25	24	23	22	21	20	19	18	17	16
	WORD	reserved				CSBAUD	CSCFG			reserved						
Type	R/W	RO	RO	RO	RO	R/W	R/W	R/W	RO	RO	RO	RO	RO	RO	RO	RO
Reset	0	0	0	0	0	0	0	0	0	0	0	0	0	0	0	0
	15	14	13	12	11	10	9	8	7	6	5	4	3	2	1	0
	reserved															
Type	RO	RO	RO	RO	RO	RO	RO	RO	RO	RO	RO	RO	RO	RO	RO	RO
Reset	0	0	0	0	0	0	0	0	0	0	0	0	0	0	0	0

Bit/Field	Name	Type	Reset	Description				
31	WORD	R/W	0	<p>Word Access Mode</p> <p>By default, the EPI controller uses data bits [7:0] for Host-Bus 8 accesses. When using Word Access mode, the EPI controller can automatically route bytes of data onto the correct byte lanes such that data can be stored in bits [31:8]. When <code>WORD</code> is set, short and long variables can be used in C programs.</p> <p>Value Description</p> <table border="0"> <tr> <td>0</td> <td>Word Access mode is disabled.</td> </tr> <tr> <td>1</td> <td>Word Access mode is enabled.</td> </tr> </table>	0	Word Access mode is disabled.	1	Word Access mode is enabled.
0	Word Access mode is disabled.							
1	Word Access mode is enabled.							
30:27	reserved	RO	0x0	Software should not rely on the value of a reserved bit. To provide compatibility with future products, the value of a reserved bit should be preserved across a read-modify-write operation.				
26	CSBAUD	R/W	0	<p>Chip Select Baud Rate</p> <p>Value Description</p> <table border="0"> <tr> <td>0</td> <td>Same Baud Rate</td> </tr> <tr> <td>1</td> <td>Different Baud Rates</td> </tr> </table> <p>CS0n uses the baud rate for the external bus that is defined by the <code>COUNT0</code> field in the <code>EPIBAUD</code> register. CSn1 uses the baud rate defined by the <code>COUNT1</code> field in the <code>EPIBAUD</code> register.</p>	0	Same Baud Rate	1	Different Baud Rates
0	Same Baud Rate							
1	Different Baud Rates							

Bit/Field	Name	Type	Reset	Description
25:24	CSCFG	R/W	0x0	<p>Chip Select Configuration</p> <p>Value Description</p> <p>0x0 ALE Configuration</p> <p>EPIOS30 is used as an address latch (ALE). When using this mode, the address and data should be muxed (HB8MODE field in the <b>EPIHB8CFG</b> register should be configured to 0x0). If needed, the address can be latched by external logic.</p> <p>0x1 CSn Configuration</p> <p>EPIOS30 is used as a Chip Select (CSn). When using this mode, the address and data should not be muxed (HB8MODE field in the <b>EPIHB8CFG</b> register should be configured to 0x1). In this mode, the WR signal (EPIOS29) and the RD signal (EPIOS28) are used to latch the address when CSn is low.</p> <p>0x2 Dual CSn Configuration</p> <p>EPIOS30 is used as CS0n and EPIOS27 is used as CS1n. Whether CS0n or CS1n is asserted is determined by the most significant address bit for a respective external address map. This configuration can be used for a RAM bank split between 2 devices as well as when using both an external RAM and an external peripheral.</p> <p>0x3 ALE with Dual CSn Configuration</p> <p>EPIOS30 is used as address latch (ALE), EPIOS27 is used as CS1n, and EPIOS26 is used as CS0n. Whether CS0n or CS1n is asserted is determined by the most significant address bit for a respective external address map.</p>
23:0	reserved	RO	0x0	Software should not rely on the value of a reserved bit. To provide compatibility with future products, the value of a reserved bit should be preserved across a read-modify-write operation.

## Register 8: EPI Host-Bus 16 Configuration 2 (EPIHB16CFG2), offset 0x014

**Important:** The `MODE` field in the `EPICFG` register determines which configuration register is accessed for offsets 0x010 and 0x014.

To access `EPIHB16CFG2`, the `MODE` field must be 0x3.

This register is used to configure operation while in Host-Bus 16 mode. Note that this register is reset when the `MODE` field in the `EPICFG` register is changed. If another mode is selected and the Host-Bus 16 mode is selected again, the values must be reinitialized.

### EPI Host-Bus 16 Configuration 2 (EPIHB16CFG2)

Base 0x400D.0000

Offset 0x014

Type R/W, reset 0x0000.0000

	31	30	29	28	27	26	25	24	23	22	21	20	19	18	17	16
	WORD	reserved				CSBAUD	CSCFG			reserved						
Type	R/W	RO	RO	RO	RO	R/W	R/W	R/W	RO	RO	RO	RO	RO	RO	RO	RO
Reset	0	0	0	0	0	0	0	0	0	0	0	0	0	0	0	0
	15	14	13	12	11	10	9	8	7	6	5	4	3	2	1	0
	reserved															
Type	RO	RO	RO	RO	RO	RO	RO	RO	RO	RO	RO	RO	RO	RO	RO	RO
Reset	0	0	0	0	0	0	0	0	0	0	0	0	0	0	0	0

Bit/Field	Name	Type	Reset	Description				
31	WORD	R/W	0	<p>Word Access Mode</p> <p>By default, the EPI controller uses data bits [15:0] for Host-Bus 16 accesses. When using Word Access mode, the EPI controller can automatically route bytes of data onto the correct byte lanes such that data can be stored in bits [31:16]. When <code>WORD</code> is set, long variables can be used in C programs.</p> <p>Value Description</p> <table border="0"> <tr> <td>0</td> <td>Word Access mode is disabled.</td> </tr> <tr> <td>1</td> <td>Word Access mode is enabled.</td> </tr> </table>	0	Word Access mode is disabled.	1	Word Access mode is enabled.
0	Word Access mode is disabled.							
1	Word Access mode is enabled.							
30:27	reserved	RO	0x0	Software should not rely on the value of a reserved bit. To provide compatibility with future products, the value of a reserved bit should be preserved across a read-modify-write operation.				
26	CSBAUD	R/W	0	<p>Chip Select Baud Rate</p> <p>Value Description</p> <table border="0"> <tr> <td>0</td> <td>Same Baud Rate</td> </tr> <tr> <td>1</td> <td>Different Baud Rates</td> </tr> </table> <p>CS0n uses the baud rate for the external bus that is defined by the <code>COUNT0</code> field in the <code>EPIBAUD</code> register. CS1n uses the baud rate defined by the <code>COUNT1</code> field in the <code>EPIBAUD</code> register.</p>	0	Same Baud Rate	1	Different Baud Rates
0	Same Baud Rate							
1	Different Baud Rates							

Bit/Field	Name	Type	Reset	Description
25:24	CSCFG	R/W	0x0	<p>Chip Select Configuration</p> <p>This field controls the chip select options, including an ALE format, a single chip select, two chip selects, and an ALE combined with two chip selects.</p> <p>Value Description</p> <p>0x0 ALE Configuration</p> <p>EPI0S30 is used as an address latch (ALE). When using this mode, the address and data should be muxed (HB816MODE field in the <b>EPIHB16CFG</b> register should be configured to 0x0). If needed, the address can be latched by external logic.</p> <p>0x1 CSn Configuration</p> <p>EPI0S30 is used as a Chip Select (CSn). When using this mode, the address and data should not be muxed (HB816MODE field in the <b>EPIHB16CFG</b> register should be configured to 0x1). In this mode, the WR signal (EPI0S29) and the RD signal (EPI0S28) are used to latch the address when CSn is low.</p> <p>0x2 Dual CSn Configuration</p> <p>EPI0S30 is used as CS0n and EPI0S27 is used as CS1n. Whether CS0n or CS1n is asserted is determined by the most significant address bit for a respective external address map. This configuration can be used for a RAM bank split between 2 devices as well as when using both an external RAM and an external peripheral.</p> <p>0x3 ALE with Dual CSn Configuration</p> <p>EPI0S30 is used as address latch (ALE), EPI0S27 is used as CS1n, and EPI0S26 is used as CS0n. Whether CS0n or CS1n is asserted is determined by the most significant address bit for a respective external address map.</p>
23:0	reserved	RO	0x0	<p>Software should not rely on the value of a reserved bit. To provide compatibility with future products, the value of a reserved bit should be preserved across a read-modify-write operation.</p>

## Register 9: EPI General-Purpose Configuration 2 (EPIGPCFG2), offset 0x014

**Important:** The `MODE` field in the `EPICFG` register determines which configuration register is accessed for offsets 0x010 and 0x014.

To access `EPIGPCFG2`, the `MODE` field must be 0x0.

This register is used to configure operation while in General-Purpose mode. Note that this register is reset when the `MODE` field in the `EPICFG` register is changed. If another mode is selected and the General-Purpose mode is selected again, the values must be reinitialized.

### EPI General-Purpose Configuration 2 (EPIGPCFG2)

Base 0x400D.0000

Offset 0x014

Type R/W, reset 0x0000.0000

	31	30	29	28	27	26	25	24	23	22	21	20	19	18	17	16
	WORD	reserved														
Type	R/W	RO	RO	RO	RO	RO	RO	RO	RO	RO	RO	RO	RO	RO	RO	RO
Reset	0	0	0	0	0	0	0	0	0	0	0	0	0	0	0	0
	15	14	13	12	11	10	9	8	7	6	5	4	3	2	1	0
	reserved															
Type	RO	RO	RO	RO	RO	RO	RO	RO	RO	RO	RO	RO	RO	RO	RO	RO
Reset	0	0	0	0	0	0	0	0	0	0	0	0	0	0	0	0

Bit/Field	Name	Type	Reset	Description						
31	WORD	R/W	0x0	<p>Word Access Mode</p> <p>By default, the EPI controller uses data bits [7:0] when the <code>DSIZE</code> field in the <code>EPIGPCFG</code> register is 0x0; data bits [15:0] when the <code>DSIZE</code> field is 0x1; data bits [23:0] when the <code>DSIZE</code> field is 0x2; and data bits [31:0] when the <code>DSIZE</code> field is 0x3.</p> <p>When using Word Access mode, the EPI controller can automatically route bytes of data onto the correct byte lanes such that data can be stored in bits [31:8] for <code>DSIZE</code>=0x0 and bits [31:16] for <code>DSIZE</code>=0x1. For <code>DSIZE</code>=0x2 or 0x3, this bit must be clear.</p> <table border="0"> <tr> <td>Value</td> <td>Description</td> </tr> <tr> <td>0</td> <td>Word Access mode is disabled.</td> </tr> <tr> <td>1</td> <td>Word Access mode is enabled.</td> </tr> </table>	Value	Description	0	Word Access mode is disabled.	1	Word Access mode is enabled.
Value	Description									
0	Word Access mode is disabled.									
1	Word Access mode is enabled.									
30:0	reserved	RO	0x000.0000	Software should not rely on the value of a reserved bit. To provide compatibility with future products, the value of a reserved bit should be preserved across a read-modify-write operation.						

### Register 10: EPI Address Map (EPIADDRMAP), offset 0x01C

This register enables address mapping. The EPI controller can directly address memory and peripherals. In addition, the EPI controller supports address mapping to allow indirect accesses in the External RAM and External Peripheral areas.

If the external device is a peripheral, including a FIFO or a directly addressable device, the `EPSZ` and `EPADR` bit fields should be configured for the address space. If the external device is SDRAM, SRAM, or NOR Flash memory, the `ERADR` and `ERSZ` bit fields should be configured for the address space.

If one of the Dual-Chip-Select modes is selected (`CSCFG=0x2` or `0x3` in the `EPIHBnCFG2` register), both chip selects can share the peripheral or the memory space, or one chip select can use the peripheral space and the other can use the memory space. If the `EPADR` field is not `0x0` and the `ERADR` field is `0x0`, then the address specified by `EPADR` is used for both chip selects, with `CS0n` being asserted when the MSB of the address range is 0 and `CS1n` being asserted when the MSB of the address range is 1. If the `ERADR` field is not `0x0` and the `EPADR` field is `0x0`, then the address specified by `ERADR` is used for both chip selects, with the MSB performing the same delineation. If both the `EPADR` and the `ERADR` are not `0x0`, then `CS0n` is asserted for the address range defined by `EPADR` and `CS1n` is asserted for the address range defined by `ERADR`.

#### EPI Address Map (EPIADDRMAP)

Base 0x400D.0000  
 Offset 0x01C  
 Type R/W, reset 0x0000.0000

	31	30	29	28	27	26	25	24	23	22	21	20	19	18	17	16
	reserved															
Type	RO	RO	RO	RO	RO	RO	RO	RO	RO	RO	RO	RO	RO	RO	RO	RO
Reset	0	0	0	0	0	0	0	0	0	0	0	0	0	0	0	0
	15	14	13	12	11	10	9	8	7	6	5	4	3	2	1	0
	reserved								EPSZ		EPADR		ERSZ		ERADR	
Type	RO	RO	RO	RO	RO	RO	RO	RO	R/W	R/W	R/W	R/W	R/W	R/W	R/W	R/W
Reset	0	0	0	0	0	0	0	0	0	0	0	0	0	0	0	0

Bit/Field	Name	Type	Reset	Description
31:8	reserved	RO	0x0000.00	Software should not rely on the value of a reserved bit. To provide compatibility with future products, the value of a reserved bit should be preserved across a read-modify-write operation.
7:6	EPSZ	R/W	0x0	External Peripheral Size  This field selects the size of the external peripheral. If the size of the external peripheral is larger, a bus fault occurs. If the size of the external peripheral is smaller, it wraps (upper address bits unused).  <b>Note:</b> When not using byte selects in Host-Bus 16, data is accessed on 2-byte boundaries. As a result, the available address space is double the amount shown below.

Value	Description
0x0	256 bytes; lower address range: 0x00 to 0xFF
0x1	64 KB; lower address range: 0x0000 to 0xFFFF
0x2	16 MB; lower address range: 0x00.0000 to 0xFF.FFFF
0x3	256 MB; lower address range: 0x000.0000 to 0xFFF.FFFF

Bit/Field	Name	Type	Reset	Description
5:4	EPADR	R/W	0x0	<p>External Peripheral Address</p> <p>This field selects address mapping for the external peripheral area.</p> <p>Value Description</p> <p>0x0 Not mapped</p> <p>0x1 At 0xA000.0000</p> <p>0x2 At 0xC000.0000</p> <p>0x3 reserved</p>
3:2	ERSZ	R/W	0x0	<p>External RAM Size</p> <p>This field selects the size of mapped RAM. If the size of the external memory is larger, a bus fault occurs. If the size of the external memory is smaller, it wraps (upper address bits unused):</p> <p>Value Description</p> <p>0x0 256 bytes; lower address range: 0x00 to 0xFF</p> <p>0x1 64 KB; lower address range: 0x0000 to 0xFFFF</p> <p>0x2 16 MB; lower address range: 0x00.0000 to 0xFF.FFFF</p> <p>0x3 256 MB; lower address range: 0x000.0000 to 0xFFF.FFFF</p>
1:0	ERADR	R/W	0x0	<p>External RAM Address</p> <p>Selects address mapping for external RAM area:</p> <p>Value Description</p> <p>0x0 Not mapped</p> <p>0x1 At 0x6000.0000</p> <p>0x2 At 0x8000.0000</p> <p>0x3 reserved</p>

**Register 11: EPI Read Size 0 (EPIRSIZE0), offset 0x020**

**Register 12: EPI Read Size 1 (EPIRSIZE1), offset 0x030**

This register selects the size of transactions when performing non-blocking reads with the **EPIRPSTDn** registers. This size affects how the external address is incremented.

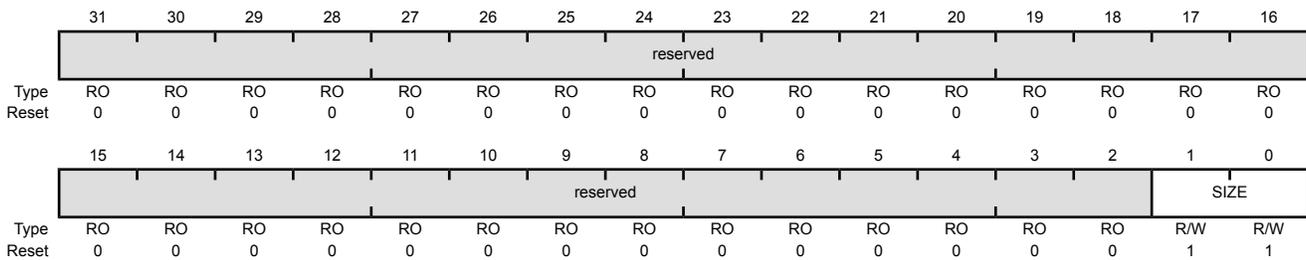
The **SIZE** field must match the external data width as configured in the **EPIHBnCFG** or **EPIGPCFG** register.

SDRAM mode uses a 16-bit data interface. If **SIZE** is 0x1, data is returned on the least significant bits (D[7:0]), and the remaining bits D[31:8] are all zeros, therefore the data on bits D[15:8] is lost. If **SIZE** is 0x2, data is returned on the least significant bits (D[15:0]), and the remaining bits D[31:16] are all zeros.

Note that changing this register while a read is active has an unpredictable effect.

**EPI Read Size 0 (EPIRSIZE0)**

Base 0x400D.0000  
 Offset 0x020  
 Type R/W, reset 0x0000.0003



Bit/Field	Name	Type	Reset	Description
31:2	reserved	RO	0x0000.000	Software should not rely on the value of a reserved bit. To provide compatibility with future products, the value of a reserved bit should be preserved across a read-modify-write operation.
1:0	SIZE	R/W	0x3	Current Size
	Value	Description		
	0x0	reserved		
	0x1	Byte (8 bits)		
	0x2	Half-word (16 bits)		
	0x3	Word (32 bits)		



**Register 13: EPI Read Address 0 (EPIRADDR0), offset 0x024****Register 14: EPI Read Address 1 (EPIRADDR1), offset 0x034**

This register holds the current address value. When performing non-blocking reads via the **EPIRPSTDn** registers, this register's value forms the address (when used by the mode). That is, when an **EPIRPSTDn** register is written with a non-0 value, this register is used as the first address. After each read, it is incremented by the size specified by the corresponding **EPIRSIZEn** register. Thus at the end of a read, this register contains the next address for the next read. For example, if the last read was 0x20, and the size is word, then the register contains 0x24. When a non-blocking read is cancelled, this register contains the next address that would have been read had it not been cancelled. For example, if reading by bytes and 0x103 had been read but not 0x104, this register contains 0x104. In this manner, the system can determine the number of values in the NBRFIFO to drain.

Note that changing this register while a read is active has an unpredictable effect due to race condition.

**EPI Read Address 0 (EPIRADDR0)**

Base 0x400D.0000

Offset 0x024

Type R/W, reset 0x0000.0000

	31	30	29	28	27	26	25	24	23	22	21	20	19	18	17	16
	reserved			ADDR												
Type	RO	RO	RO	R/W	R/W	R/W	R/W	R/W	R/W	R/W	R/W	R/W	R/W	R/W	R/W	R/W
Reset	0	0	0	0	0	0	0	0	0	0	0	0	0	0	0	0
	15	14	13	12	11	10	9	8	7	6	5	4	3	2	1	0
	ADDR															
Type	R/W	R/W	R/W	R/W	R/W	R/W	R/W	R/W	R/W	R/W	R/W	R/W	R/W	R/W	R/W	R/W
Reset	0	0	0	0	0	0	0	0	0	0	0	0	0	0	0	0

Bit/Field	Name	Type	Reset	Description
31:29	reserved	RO	0x0	Software should not rely on the value of a reserved bit. To provide compatibility with future products, the value of a reserved bit should be preserved across a read-modify-write operation.
28:0	ADDR	R/W	0x000.0000	Current Address Next address to read.

**Register 15: EPI Non-Blocking Read Data 0 (EPIRPSTD0), offset 0x028**

**Register 16: EPI Non-Blocking Read Data 1 (EPIRPSTD1), offset 0x038**

This register sets up a non-blocking read via the external interface. A non-blocking read is started by writing to this register with the count (other than 0). Clearing this register terminates an active non-blocking read as well as cancelling any that are pending. This register should always be cleared before writing a value other than 0; failure to do so can cause improper operation.

The first address is based on the corresponding **EPIADDRn** register. The address register is incremented by the size specified by the **EPIRSIZEn** register after each read. If the size is less than a word, only the least significant bits of data are filled into the NBRFIFO; the most significant bits are cleared.

Note that all three registers may be written using one STM instruction, such as with a structure copy in C/C++.

The data may be read from the **EPIREADFIFO** register after the read cycle is completed. The interrupt mechanism is normally used to trigger the FIFO reads via ISR or  $\mu$ DMA.

If the countdown has not reached 0 and the NBRFIFO is full, the external interface waits until a NBRFIFO entry becomes available to continue.

Note: if a blocking read or write is performed through the address mapped area (at 0x6000.0000 through 0xDFFF.FFFF), any current non-blocking read is paused (at the next safe boundary), and the blocking request is inserted. After completion of any blocking reads or writes, the non-blocking reads continue from where they were paused.

The other way to read data is via the address mapped locations (see the **EPIADDRMAP** register), but this method is blocking (core or  $\mu$ DMA waits until result is returned).

To cancel a non-blocking read, clear this register. To make sure that all values read are drained from the NBRFIFO, the **EPISTAT** register must be consulted to be certain that bits **NBRBUSY** and **ACTIVE** are cleared. One of these registers should not be cleared until either the other **EPIRPSTDn** register becomes active or the external interface is not busy. At that point, the corresponding **EPIADDRn** register indicates how many values were read.

EPI Non-Blocking Read Data 0 (EPIRPSTD0)

Base 0x400D.0000  
 Offset 0x028  
 Type R/W, reset 0x0000.0000

	31	30	29	28	27	26	25	24	23	22	21	20	19	18	17	16
	reserved															
Type	RO	RO	RO	RO	RO	RO	RO	RO	RO	RO	RO	RO	RO	RO	RO	RO
Reset	0	0	0	0	0	0	0	0	0	0	0	0	0	0	0	0
	15	14	13	12	11	10	9	8	7	6	5	4	3	2	1	0
	reserved			POSTCNT												
Type	RO	RO	RO	R/W	R/W	R/W	R/W	R/W	R/W	R/W	R/W	R/W	R/W	R/W	R/W	R/W
Reset	0	0	0	0	0	0	0	0	0	0	0	0	0	0	0	0

Bit/Field	Name	Type	Reset	Description
31:13	reserved	RO	0x0000.0	Software should not rely on the value of a reserved bit. To provide compatibility with future products, the value of a reserved bit should be preserved across a read-modify-write operation.

---

Bit/Field	Name	Type	Reset	Description
12:0	POSTCNT	R/W	0x000	<p>Post Count</p> <p>A write of a non-zero value starts a read operation for that count. Note that it is the software's responsibility to handle address wraparound.</p> <p>Reading this register provides the current count.</p> <p>A write of 0 cancels a non-blocking read (whether active now or pending).</p> <p>Prior to writing a non-zero value, this register must first be cleared.</p>

### Register 17: EPI Status (EPISTAT), offset 0x060

This register indicates which non-blocking read register is currently active; it also indicates whether the external interface is busy performing a write or non-blocking read (it cannot be performing a blocking read, as the bus would be blocked and as a result, this register could not be accessed).

This register is useful for determining which non-blocking read register is active when both are loaded with values and when implementing sequencing or sharing.

This register is also useful when canceling non-blocking reads, as it shows how many values were read by the canceled side.

#### EPI Status (EPISTAT)

Base 0x400D.0000  
 Offset 0x060  
 Type RO, reset 0x0000.0000

	31	30	29	28	27	26	25	24	23	22	21	20	19	18	17	16
	reserved															
Type	RO	RO	RO	RO	RO	RO	RO	RO	RO	RO	RO	RO	RO	RO	RO	RO
Reset	0	0	0	0	0	0	0	0	0	0	0	0	0	0	0	0
	15	14	13	12	11	10	9	8	7	6	5	4	3	2	1	0
	reserved						CELOW	XFFULL	XFEMPTY	INITSEQ	WBUSY	NBRBUSY	reserved			ACTIVE
Type	RO	RO	RO	RO	RO	RO	RO	RO	RO	RO	RO	RO	RO	RO	RO	RO
Reset	0	0	0	0	0	0	0	0	0	0	0	0	0	0	0	0

Bit/Field	Name	Type	Reset	Description
31:10	reserved	RO	0x0000.00	Software should not rely on the value of a reserved bit. To provide compatibility with future products, the value of a reserved bit should be preserved across a read-modify-write operation.
9	CELOW	RO	0	<p>Clock Enable Low</p> <p>This bit provides information on the clock status when in general-purpose mode and the RDYEN bit is set.</p> <p>Value Description</p> <p>1 The external device is gating the clock (iRDY is low).                      Attempts to read or write in this situation are stalled until the clock is enabled or the counter times out as specified by the MAXWAIT field.</p> <p>0 The external device is not gating the clock.</p>
8	XFFULL	RO	0	<p>External FIFO Full</p> <p>This bit provides information on the XFIFO when in the FIFO sub-mode of the Host Bus n mode with the XFFEN bit set in the EPIHBnCFG register. The EPIOS26 signal reflects the status of this bit.</p> <p>Value Description</p> <p>1 The XFIFO is signaling as full (the FIFO full signal is high).                      Attempts to write in this case are stalled until the XFIFO full signal goes low or the counter times out as specified by the MAXWAIT field.</p> <p>0 The external device is not gating the clock.</p>

Bit/Field	Name	Type	Reset	Description
7	XFEMPTY	RO	0	<p>External FIFO Empty</p> <p>This bit provides information on the XFIFO when in the FIFO sub-mode of the Host Bus n mode with the <i>XFEEN</i> bit set in the <b>EPIHBnCFG</b> register. The <i>EPIOS27</i> signal reflects the status of this bit.</p> <p>Value Description</p> <p>1 The XFIFO is signaling as empty (the FIFO empty signal is high). Attempts to read in this case are stalled until the XFIFO empty signal goes low or the counter times out as specified by the <i>MAXWAIT</i> field.</p> <p>0 The external device is not gating the clock.</p>
6	INITSEQ	RO	0	<p>Initialization Sequence</p> <p>Value Description</p> <p>1 The SDRAM interface is running through the wakeup period (greater than 100 <math>\mu</math>s). If an attempt is made to read or write the SDRAM during this period, the access is held off until the wakeup period is complete.</p> <p>0 The SDRAM interface is not in the wakeup period.</p>
5	WBUSY	RO	0	<p>Write Busy</p> <p>Value Description</p> <p>1 The external interface is performing a write.</p> <p>0 The external interface is not performing a write.</p>
4	NBRBUSY	RO	0	<p>Non-Blocking Read Busy</p> <p>Value Description</p> <p>1 The external interface is performing a non-blocking read, or if the non-blocking read is paused due to a write.</p> <p>0 The external interface is not performing a non-blocking read.</p>
3:1	reserved	RO	0x0	<p>Software should not rely on the value of a reserved bit. To provide compatibility with future products, the value of a reserved bit should be preserved across a read-modify-write operation.</p>
0	ACTIVE	RO	0	<p>Register Active</p> <p>Value Description</p> <p>1 The <b>EPIRPSTD1</b> register is active.</p> <p>0 If <i>NBRBUSY</i> is set, the <b>EPIRPSTD0</b> register is active. If the <i>NBRBUSY</i> bit is clear, then neither <b>EPIRPSTDx</b> register is active.</p>

**Register 18: EPI Read FIFO Count (EPIRFIFOCNT), offset 0x06C**

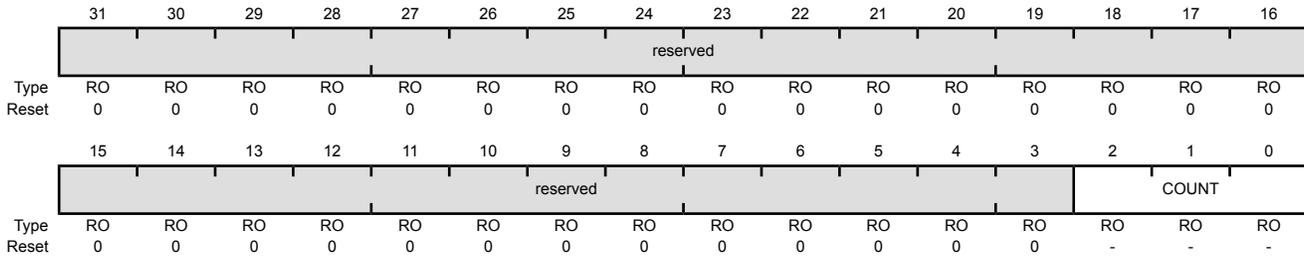
This register returns the number of values in the NBRFIFO (the data in the NBRFIFO can be read via the **EPIREADFIFO** register). A race is possible, but that only means that more values may come in after this register has been read.

EPI Read FIFO Count (EPIRFIFOCNT)

Base 0x400D.0000

Offset 0x06C

Type RO, reset -



Bit/Field	Name	Type	Reset	Description
31:3	reserved	RO	0x0000.000	Software should not rely on the value of a reserved bit. To provide compatibility with future products, the value of a reserved bit should be preserved across a read-modify-write operation.
2:0	COUNT	RO	-	FIFO Count Number of filled entries in the NBRFIFO.

**Register 19: EPI Read FIFO (EPIREADFIFO), offset 0x070**

**Register 20: EPI Read FIFO Alias 1 (EPIREADFIFO1), offset 0x074**

**Register 21: EPI Read FIFO Alias 2 (EPIREADFIFO2), offset 0x078**

**Register 22: EPI Read FIFO Alias 3 (EPIREADFIFO3), offset 0x07C**

**Register 23: EPI Read FIFO Alias 4 (EPIREADFIFO4), offset 0x080**

**Register 24: EPI Read FIFO Alias 5 (EPIREADFIFO5), offset 0x084**

**Register 25: EPI Read FIFO Alias 6 (EPIREADFIFO6), offset 0x088**

**Register 26: EPI Read FIFO Alias 7 (EPIREADFIFO7), offset 0x08C**

**Important:** Use caution when reading this register. Performing a read may change bit status.

This register returns the contents of the NBRFIFO or 0 if the NBRFIFO is empty. Each read returns the data that is at the top of the NBRFIFO, and then empties that value from the NBRFIFO. The alias registers can be used with the LDMIA instruction for more efficient operation (for up to 8 registers). See *ARM® Cortex™-M3 Technical Reference Manual* for more information on the LDMIA instruction.

#### EPI Read FIFO (EPIREADFIFO)

Base 0x400D.0000

Offset 0x070

Type RO, reset -

	31	30	29	28	27	26	25	24	23	22	21	20	19	18	17	16
	DATA															
Type	RO	RO	RO	RO	RO	RO	RO	RO	RO	RO	RO	RO	RO	RO	RO	RO
Reset	-	-	-	-	-	-	-	-	-	-	-	-	-	-	-	-
	15	14	13	12	11	10	9	8	7	6	5	4	3	2	1	0
	DATA															
Type	RO	RO	RO	RO	RO	RO	RO	RO	RO	RO	RO	RO	RO	RO	RO	RO
Reset	-	-	-	-	-	-	-	-	-	-	-	-	-	-	-	-

Bit/Field	Name	Type	Reset	Description
31:0	DATA	RO	-	Reads Data

This field contains the data that is at the top of the NBRFIFO. After being read, the NBRFIFO entry is removed.

### Register 27: EPI FIFO Level Selects (EPIFIFOLVL), offset 0x200

This register allows selection of the FIFO levels which trigger an interrupt to the interrupt controller or, more efficiently, a DMA request to the  $\mu$ DMA. The NBRFIFO select triggers on fullness such that it triggers on match or above (more full). The WFIFO triggers on emptiness such that it triggers on match or below (less entries).

It should be noted that the FIFO triggers are not identical to other such FIFOs in Stellaris<sup>®</sup> peripherals. In particular, empty and full triggers are provided to avoid wait states when using blocking operations.

The settings in this register are only meaningful if the  $\mu$ DMA is active or the interrupt is enabled.

Additionally, this register allows protection against writes stalling and notification of performing blocking reads which stall for extra time due to preceding writes. The two functions behave in a non-orthogonal way because read and write are not orthogonal.

The write error bit configures the system such that an attempted write to an already full WFIFO abandons the write and signals an error interrupt to prevent accidental latencies due to stalling writes.

The read error bit configures the system such that after a read has been stalled due to any preceding writes in the WFIFO, the error interrupt is generated. Note that the excess stall is not prevented, but an interrupt is generated after the fact to notify that it has happened.

#### EPI FIFO Level Selects (EPIFIFOLVL)

Base 0x400D.0000  
Offset 0x200  
Type R/W, reset 0x0000.0033

	31	30	29	28	27	26	25	24	23	22	21	20	19	18	17	16
	reserved														WFERR	RSERR
Type	RO	RO	RO	RO	RO	RO	RO	RO	RO	RO	RO	RO	RO	RO	R/W	R/W
Reset	0	0	0	0	0	0	0	0	0	0	0	0	0	0	0	0
	15	14	13	12	11	10	9	8	7	6	5	4	3	2	1	0
	reserved								WRFIFO			reserved	RDFIFO			
Type	RO	RO	RO	RO	RO	RO	RO	RO	RO	R/W	R/W	R/W	RO	R/W	R/W	R/W
Reset	0	0	0	0	0	0	0	0	0	0	1	1	0	0	1	1

Bit/Field	Name	Type	Reset	Description
31:18	reserved	RO	0x000	Software should not rely on the value of a reserved bit. To provide compatibility with future products, the value of a reserved bit should be preserved across a read-modify-write operation.
17	WFERR	R/W	0	Write Full Error
				Value Description
				1 This bit enables the Write Full error interrupt (WTFULL in the <b>EPIIC</b> register) to be generated when a write is attempted and the WFIFO is full. The write stalls until a WFIFO entry becomes available.
				0 The Write Full error interrupt is disabled. Writes are stalled when the WFIFO is full until a space becomes available but an error is not generated. Note that the Cortex-M3 write buffer may hide that stall if no other memory transactions are attempted during that time.



Bit/Field	Name	Type	Reset	Description
16	RSERR	R/W	0	<p>Read Stall Error</p> <p>Value Description</p> <p>1 This bit enables the Read Stalled error interrupt (<code>RSTALL</code> in the <b>EPIIC</b> register) to be generated when a read is attempted and the WFIFO is not empty. The read is still stalled during the time the WFIFO drains, but this error notifies the application that this excess delay has occurred.</p> <p>0 The Read Stalled error interrupt is disabled. Reads behave as normal and are stalled until any preceding writes have completed and the read has returned a result.</p> <p>Note that the configuration of this bit has no effect on non-blocking reads.</p>
15:7	reserved	RO	0x00	Software should not rely on the value of a reserved bit. To provide compatibility with future products, the value of a reserved bit should be preserved across a read-modify-write operation.
6:4	WRFIFO	R/W	0x3	<p>Write FIFO</p> <p>This field configures the trigger point for the WFIFO.</p> <p>Value Description</p> <p>0x0 Trigger when there are 1 to 4 spaces available in the WFIFO.</p> <p>0x1 reserved</p> <p>0x2 Trigger when there are 1 to 3 spaces available in the WFIFO.</p> <p>0x3 Trigger when there are 1 to 2 spaces available in the WFIFO.</p> <p>0x4 Trigger when there is 1 space available in the WFIFO.</p> <p>0x5-0x7 reserved</p>
3	reserved	RO	0	Software should not rely on the value of a reserved bit. To provide compatibility with future products, the value of a reserved bit should be preserved across a read-modify-write operation.
2:0	RDFIFO	R/W	0x3	<p>Read FIFO</p> <p>This field configures the trigger point for the NBRFIFO.</p> <p>Value Description</p> <p>0x0 reserved</p> <p>0x1 Trigger when there are 1 or more entries in the NBRFIFO.</p> <p>0x2 Trigger when there are 2 or more entries in the NBRFIFO.</p> <p>0x3 Trigger when there are 4 or more entries in the NBRFIFO.</p> <p>0x4 Trigger when there are 6 or more entries in the NBRFIFO.</p> <p>0x5 Trigger when there are 7 or more entries in the NBRFIFO.</p> <p>0x6 Trigger when there are 8 entries in the NBRFIFO.</p> <p>0x7 reserved</p>

### Register 28: EPI Write FIFO Count (EPIWFIFOCNT), offset 0x204

This register contains the number of slots currently available in the WFIFO. This register may be used for polled writes to avoid stalling and for blocking reads to avoid excess stalling (due to undrained writes). An example use for writes may be:

```
for (idx = 0; idx < cnt; idx++) {
while (EPIWFIFOCNT == 0) ;
*ext_ram = *mydata++;
}
```

The above code ensures that writes to the address mapped location do not occur unless the WFIFO has room. Although polling makes the code wait (spinning in the loop), it does not prevent interrupts being serviced due to bus stalling.

#### EPI Write FIFO Count (EPIWFIFOCNT)

Base 0x400D.0000  
 Offset 0x204  
 Type RO, reset 0x0000.0004

	31	30	29	28	27	26	25	24	23	22	21	20	19	18	17	16
	reserved															
Type	RO	RO	RO	RO	RO	RO	RO	RO	RO	RO	RO	RO	RO	RO	RO	RO
Reset	0	0	0	0	0	0	0	0	0	0	0	0	0	0	0	0
	15	14	13	12	11	10	9	8	7	6	5	4	3	2	1	0
	reserved													WTAV		
Type	RO	RO	RO	RO	RO	RO	RO	RO	RO	RO	RO	RO	RO	RO	RO	RO
Reset	0	0	0	0	0	0	0	0	0	0	0	0	0	0	1	0

Bit/Field	Name	Type	Reset	Description
31:3	reserved	RO	0x0000.000	Software should not rely on the value of a reserved bit. To provide compatibility with future products, the value of a reserved bit should be preserved across a read-modify-write operation.
2:0	WTAV	RO	0x4	Available Write Transactions  The number of write transactions available in the WFIFO.  When clear, a write is stalled waiting for a slot to become free (from a preceding write completing).

**Register 29: EPI Interrupt Mask (EPIIM), offset 0x210**

This register is the interrupt mask set or clear register. For each interrupt source (read, write, and error), a mask value of 1 allows the interrupt source to trigger an interrupt to the interrupt controller; a mask value of 0 prevents the interrupt source from triggering an interrupt.

Note that interrupt masking has no effect on  $\mu$ DMA, which operates off the raw source of the read and write interrupts.

**EPI Interrupt Mask (EPIIM)**

Base 0x400D.0000

Offset 0x210

Type R/W, reset 0x0000.0000

	31	30	29	28	27	26	25	24	23	22	21	20	19	18	17	16	
	reserved																
Type	RO	RO	RO	RO	RO	RO	RO	RO	RO	RO	RO	RO	RO	RO	RO	RO	
Reset	0	0	0	0	0	0	0	0	0	0	0	0	0	0	0	0	
	15	14	13	12	11	10	9	8	7	6	5	4	3	2	1	0	
	reserved													WRIM	RDIM	ERRIM	
Type	RO	RO	RO	RO	RO	RO	RO	RO	RO	RO	RO	RO	RO	RO	R/W	R/W	R/W
Reset	0	0	0	0	0	0	0	0	0	0	0	0	0	0	0	0	0

Bit/Field	Name	Type	Reset	Description
31:3	reserved	RO	0x0000.000	Software should not rely on the value of a reserved bit. To provide compatibility with future products, the value of a reserved bit should be preserved across a read-modify-write operation.
2	WRIM	R/W	0	Write Interrupt Mask  Value Description 1 <b>WRRIS</b> in the <b>EPIRIS</b> register is not masked and can trigger an interrupt to the interrupt controller. 0 <b>WRRIS</b> in the <b>EPIRIS</b> register is masked and does not cause an interrupt.
1	RDIM	R/W	0	Read Interrupt Mask  Value Description 1 <b>RDRIS</b> in the <b>EPIRIS</b> register is not masked and can trigger an interrupt to the interrupt controller. 0 <b>RDRIS</b> in the <b>EPIRIS</b> register is masked and does not cause an interrupt.
0	ERRIM	R/W	0	Error Interrupt Mask  Value Description 1 <b>ERRIS</b> in the <b>EPIRIS</b> register is not masked and can trigger an interrupt to the interrupt controller. 0 <b>ERRIS</b> in the <b>EPIRIS</b> register is masked and does not cause an interrupt.

### Register 30: EPI Raw Interrupt Status (EPIRIS), offset 0x214

This register is the raw interrupt status register. On a read, it gives the current state of each interrupt source. A write has no effect.

Note that raw status for read and write is set or cleared based on FIFO fullness as controlled by **EPIFIFOLVL**.

Raw status for error is held until the error is cleared by writing to the **EPIIC** register.

#### EPI Raw Interrupt Status (EPIRIS)

Base 0x400D.0000  
 Offset 0x214  
 Type RO, reset 0x0000.0004

	31	30	29	28	27	26	25	24	23	22	21	20	19	18	17	16
	reserved															
Type	RO	RO	RO	RO	RO	RO	RO	RO	RO	RO	RO	RO	RO	RO	RO	RO
Reset	0	0	0	0	0	0	0	0	0	0	0	0	0	0	0	0
	15	14	13	12	11	10	9	8	7	6	5	4	3	2	1	0
	reserved													WRRIS	RDRIS	ERRIS
Type	RO	RO	RO	RO	RO	RO	RO	RO	RO	RO	RO	RO	RO	RO	RO	RO
Reset	0	0	0	0	0	0	0	0	0	0	0	0	0	1	0	0

Bit/Field	Name	Type	Reset	Description
31:3	reserved	RO	0x0000.000	Software should not rely on the value of a reserved bit. To provide compatibility with future products, the value of a reserved bit should be preserved across a read-modify-write operation.
2	WRRIS	RO	1	Write Raw Interrupt Status  Value Description 1 The number of available entries in the WFIFO is within the range specified by the trigger level (the <code>WRFIFO</code> field in the <b>EPIFIFOLVL</b> register). 0 The number of available entries in the WFIFO is above the range specified by the trigger level.  This bit is cleared when the level in the WFIFO is above the trigger point programmed by the <code>WRFIFO</code> field.
1	RDRIS	RO	0	Read Raw Interrupt Status  Value Description 1 The number of valid entries in the NBRFIFO is within the range specified by the trigger level (the <code>RDFIFO</code> field in the <b>EPIFIFOLVL</b> register). 0 The number of valid entries in the NBRFIFO is below the range specified by the trigger level.  This bit is cleared when the level in the NBRFIFO is below the trigger point programmed by the <code>RDFIFO</code> field.

Bit/Field	Name	Type	Reset	Description				
0	ERRRIS	RO	0	<p>Error Raw Interrupt Status</p> <p>The error interrupt occurs in the following situations:</p> <ul style="list-style-type: none"> <li>■ <b>WFIFO Full.</b> For a full WFIFO to generate an error interrupt, the <code>WFERR</code> bit in the <b>EPIFIFOLVL</b> register must be set.</li> <li>■ <b>Read Stalled.</b> For a stalled read to generate an error interrupt, the <code>RSERR</code> bit in the <b>EPIFIFOLVL</b> register must be set.</li> <li>■ <b>Timeout.</b> If the <code>MAXWAIT</code> field in the <b>EPIGPCFG</b> register is configured to a value other than 0, a timeout error occurs when <code>iRDY</code> or <code>XFIFO</code> not-ready signals hold a transaction for more than the count in the <code>MAXWAIT</code> field.</li> </ul> <p>Value Description</p> <table border="0"> <tr> <td>1</td> <td>A WFIFO Full, a Read Stalled, or a Timeout error has occurred.</td> </tr> <tr> <td>0</td> <td>An error has not occurred.</td> </tr> </table> <p>To determine which error occurred, read the status of the <b>EPI Error Interrupt Status and Clear (EPIEISC)</b> register. This bit is cleared by writing a 1 to the bit in the <b>EPIEISC</b> register that caused the interrupt.</p>	1	A WFIFO Full, a Read Stalled, or a Timeout error has occurred.	0	An error has not occurred.
1	A WFIFO Full, a Read Stalled, or a Timeout error has occurred.							
0	An error has not occurred.							

### Register 31: EPI Masked Interrupt Status (EPIMIS), offset 0x218

This register is the masked interrupt status register. On read, it gives the current state of each interrupt source (read, write, and error) after being masked via the **EPIIM** register. A write has no effect.

The values returned are the ANDing of the **EPIIM** and **EPIRIS** registers. If a bit is set in this register, the interrupt is sent to the interrupt controller.

#### EPI Masked Interrupt Status (EPIMIS)

Base 0x400D.0000  
 Offset 0x218  
 Type RO, reset 0x0000.0000

	31	30	29	28	27	26	25	24	23	22	21	20	19	18	17	16
	reserved															
Type	RO	RO	RO	RO	RO	RO	RO	RO	RO	RO	RO	RO	RO	RO	RO	RO
Reset	0	0	0	0	0	0	0	0	0	0	0	0	0	0	0	0
	15	14	13	12	11	10	9	8	7	6	5	4	3	2	1	0
	reserved													WRMIS	RDMIS	ERRMIS
Type	RO	RO	RO	RO	RO	RO	RO	RO	RO	RO	RO	RO	RO	RO	RO	RO
Reset	0	0	0	0	0	0	0	0	0	0	0	0	0	0	0	0

Bit/Field	Name	Type	Reset	Description
31:3	reserved	RO	0x0000.000	Software should not rely on the value of a reserved bit. To provide compatibility with future products, the value of a reserved bit should be preserved across a read-modify-write operation.
2	WRMIS	RO	0	Write Masked Interrupt Status  Value Description 1 The number of available entries in the WFIFO is within the range specified by the trigger level (the <b>WRFIFO</b> field in the <b>EPIFIFOLVL</b> register) and the <b>WRIM</b> bit in the <b>EPIIM</b> register is set, triggering an interrupt to the interrupt controller. 0 The number of available entries in the WFIFO is above the range specified by the trigger level or the interrupt is masked.
1	RDMIS	RO	0	Read Masked Interrupt Status  Value Description 1 The number of valid entries in the NBRFIFO is within the range specified by the trigger level (the <b>RDFIFO</b> field in the <b>EPIFIFOLVL</b> register) and the <b>RDIM</b> bit in the <b>EPIIM</b> register is set, triggering an interrupt to the interrupt controller. 0 The number of valid entries in the NBRFIFO is below the range specified by the trigger level or the interrupt is masked.
0	ERRMIS	RO	0	Error Masked Interrupt Status  Value Description 1 A WFIFO Full, a Read Stalled, or a Timeout error has occurred and the <b>ERIM</b> bit in the <b>EPIIM</b> register is set, triggering an interrupt to the interrupt controller. 0 An error has not occurred or the interrupt is masked.

## Register 32: EPI Error Interrupt Status and Clear (EPIEISC), offset 0x21C

This register is used to clear a pending error interrupt. If any of these bits are set, the `ERRRIS` bit in the `EPIRIS` register is set, and an EPI controller error is sent to the interrupt controller if the `ERIM` bit in the `EPIIM` register is set. Clearing any defined bit has no effect; setting a bit clears the error source and the raw error returns to 0. Note that writing to this register and reading back immediately (pipelined by the processor) returns the old register contents. One cycle is needed between write and read.

### EPI Error Interrupt Status and Clear (EPIEISC)

Base 0x400D.0000

Offset 0x21C

Type R/W1C, reset 0x0000.0000

	31	30	29	28	27	26	25	24	23	22	21	20	19	18	17	16
	reserved															
Type	RO	RO	RO	RO	RO	RO	RO	RO	RO	RO	RO	RO	RO	RO	RO	RO
Reset	0	0	0	0	0	0	0	0	0	0	0	0	0	0	0	0
	15	14	13	12	11	10	9	8	7	6	5	4	3	2	1	0
	reserved													WTFULL	RSTALL	TOUT
Type	RO	RO	RO	RO	RO	RO	RO	RO	RO	RO	RO	RO	RO	R/W1C	R/W1C	R/W1C
Reset	0	0	0	0	0	0	0	0	0	0	0	0	0	0	0	0

Bit/Field	Name	Type	Reset	Description
31:3	reserved	RO	0x0000.000	Software should not rely on the value of a reserved bit. To provide compatibility with future products, the value of a reserved bit should be preserved across a read-modify-write operation.
2	WTFULL	R/W1C	0	Write FIFO Full Error  Value Description 1 The <code>WFERR</code> bit is enabled and a write is stalled due to the <code>WFIFO</code> being full. 0 The <code>WFERR</code> bit is not enabled or no writes are stalled.  Writing a 1 to this bit clears it and the <code>WFERR</code> bit in the <code>EPIFIFOLVL</code> register.
1	RSTALL	R/W1C	0	Read Stalled Error  Value Description 1 The <code>RSERR</code> bit is enabled and a pending read is stalled due to writes in the <code>WFIFO</code> . 0 The <code>RSERR</code> bit is not enabled or no pending reads are stalled.  Writing a 1 to this bit clears it and the <code>RSERR</code> bit in the <code>EPIFIFOLVL</code> register.

Bit/Field	Name	Type	Reset	Description
0	TOUT	R/W1C	0	<p>Timeout Error</p> <p>This bit is the timeout error source. The timeout error occurs when the iRDY or XFIFO not-ready signals hold a transaction for more than the count in the <code>MAXWAIT</code> field (when not 0).</p> <p>Value Description</p> <p>1 A timeout error has occurred.</p> <p>0 No timeout error has occurred.</p> <p>Writing a 1 to bit this clears it.</p>



## 11 General-Purpose Timers

Programmable timers can be used to count or time external events that drive the Timer input pins. The Stellaris® General-Purpose Timer Module (GPTM) contains four GPTM blocks (Timer 0, Timer 1, Timer 2, and Timer 3). Each GPTM block provides two 16-bit timers/counters (referred to as Timer A and Timer B) that can be configured to operate independently as timers or event counters, or configured to operate as one 32-bit timer or one 32-bit Real-Time Clock (RTC). Timers can also be used to trigger  $\mu$ DMA transfers.

In addition, timers can be used to trigger analog-to-digital conversions (ADC). The ADC trigger signals from all of the general-purpose timers are ORed together before reaching the ADC module, so only one timer should be used to trigger ADC events.

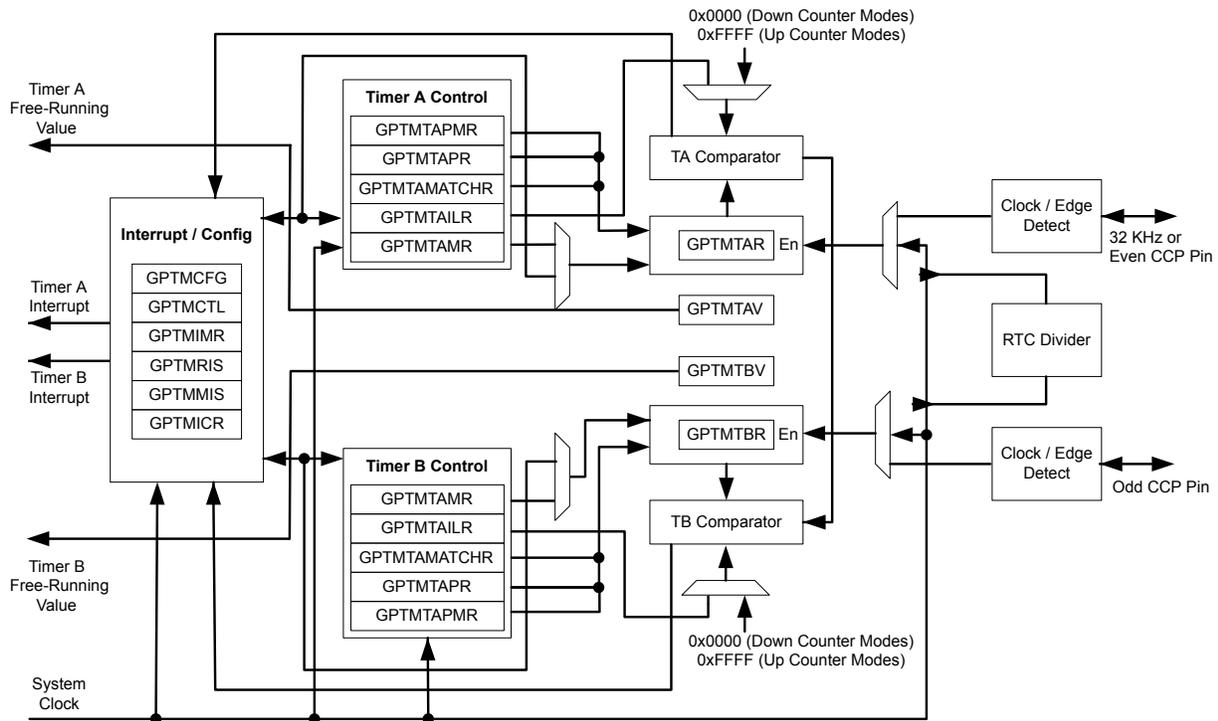
The GPT Module is one timing resource available on the Stellaris® microcontrollers. Other timer resources include the System Timer (SysTick) (see “System Timer (SysTick)” on page 80) and the PWM timer in the PWM module (see “PWM Timer” on page 1032).

The General-Purpose Timer Module (GPTM) contains four GPTM blocks with the following functional options:

- Count up or down
- 16- or 32-bit programmable one-shot timer
- 16- or 32-bit programmable periodic timer
- 16-bit general-purpose timer with an 8-bit prescaler
- 32-bit Real-Time Clock (RTC) when using an external 32.768-KHz clock as the input
- Eight Capture Compare PWM pins (CCP)
- Daisy chaining of timer modules to allow a single timer to initiate multiple timing events
- ADC event trigger
- User-enabled stalling when the controller asserts CPU Halt flag during debug (excluding RTC mode)
- 16-bit input-edge count- or time-capture modes
- 16-bit PWM mode with software-programmable output inversion of the PWM signal
- Ability to determine the elapsed time between the assertion of the timer interrupt and entry into the interrupt service routine.
- Efficient transfers using Micro Direct Memory Access Controller ( $\mu$ DMA)
  - Dedicated channel for each timer
  - Burst request generated on timer interrupt

## 11.1 Block Diagram

Figure 11-1. GPTM Module Block Diagram



**Note:** In Figure 11-1 on page 434, the specific Capture Compare PWM (CCP) pins available depend on the Stellaris<sup>®</sup> device. See Table 11-1 on page 434 for the available CCP pins and their timer assignments

Table 11-1. Available CCP Pins

Timer	16-Bit Up/Down Counter	Even CCP Pin	Odd CCP Pin
Timer 0	Timer A	CCP0	-
	Timer B	-	CCP1
Timer 1	Timer A	CCP2	-
	Timer B	-	CCP3
Timer 2	Timer A	CCP4	-
	Timer B	-	CCP5
Timer 3	Timer A	CCP6	-
	Timer B	-	CCP7

## 11.2 Signal Description

Table 11-2 on page 435 and Table 11-3 on page 436 list the external signals of the GP Timer module and describe the function of each. The GP Timer signals are alternate functions for some GPIO signals and default to be GPIO signals at reset. The column in the table below titled "Pin Mux/Pin Assignment" lists the possible GPIO pin placements for these GP Timer signals. The AFSEL bit in the **GPIO Alternate Function Select (GPIOAFSEL)** register (page 328) should be set to choose

the GP Timer function. The number in parentheses is the encoding that must be programmed into the  $PMC_n$  field in the **GPIO Port Control (GPIOPCTL)** register (page 346) to assign the GP Timer signal to the specified GPIO port pin. For more information on configuring GPIOs, see “General-Purpose Input/Outputs (GPIOs)” on page 304.

**Table 11-2. Signals for General-Purpose Timers (100LQFP)**

Pin Name	Pin Number	Pin Mux / Pin Assignment	Pin Type	Buffer Type <sup>a</sup>	Description
CCP0	13	PD3 (4)	I/O	TTL	Capture/Compare/PWM 0.
	22	PC7 (4)			
	23	PC6 (6)			
	39	PJ2 (9)			
	42	PF4 (1)			
	55	PJ7 (10)			
	66	PB0 (1)			
	72	PB2 (5)			
	91	PB5 (4)			
	97	PD4 (1)			
CCP1	24	PC5 (1)	I/O	TTL	Capture/Compare/PWM 1.
	25	PC4 (9)			
	34	PA6 (2)			
	54	PJ6 (10)			
	67	PB1 (4)			
	90	PB6 (1)			
	96	PE3 (1)			
	100	PD7 (3)			
CCP2	6	PE4 (6)	I/O	TTL	Capture/Compare/PWM 2.
	11	PD1 (10)			
	25	PC4 (5)			
	41	PF5 (1)			
	53	PJ5 (10)			
	67	PB1 (1)			
	75	PE1 (4)			
	91	PB5 (6)			
	95	PE2 (5)			
98	PD5 (1)				
CCP3	6	PE4 (1)	I/O	TTL	Capture/Compare/PWM 3.
	23	PC6 (1)			
	24	PC5 (5)			
	35	PA7 (7)			
	61	PF1 (10)			
	72	PB2 (4)			
	74	PE0 (3)			
	97	PD4 (2)			
CCP4	22	PC7 (1)	I/O	TTL	Capture/Compare/PWM 4.
	25	PC4 (6)			
	35	PA7 (2)			
	52	PJ4 (10)			
	95	PE2 (1)			
	98	PD5 (2)			
CCP5	5	PE5 (1)	I/O	TTL	Capture/Compare/PWM 5.
	12	PD2 (4)			
	25	PC4 (1)			
	36	PG7 (8)			
	90	PB6 (6)			
	91	PB5 (2)			

Table 11-2. Signals for General-Purpose Timers (100LQFP) (continued)

Pin Name	Pin Number	Pin Mux / Pin Assignment	Pin Type	Buffer Type <sup>a</sup>	Description
CCP6	10	PD0 (6)	I/O	TTL	Capture/Compare/PWM 6.
	12	PD2 (2)			
	50	PJ3 (10)			
	75	PE1 (5)			
	86	PH0 (1)			
	91	PB5 (3)			
CCP7	11	PD1 (6)	I/O	TTL	Capture/Compare/PWM 7.
	13	PD3 (2)			
	85	PH1 (1)			
	90	PB6 (2)			
	96	PE3 (5)			

a. The TTL designation indicates the pin has TTL-compatible voltage levels.

Table 11-3. Signals for General-Purpose Timers (108BGA)

Pin Name	Pin Number	Pin Mux / Pin Assignment	Pin Type	Buffer Type <sup>a</sup>	Description
CCP0	H1	PD3 (4)	I/O	TTL	Capture/Compare/PWM 0.
	L2	PC7 (4)			
	M2	PC6 (6)			
	K6	PJ2 (9)			
	K4	PF4 (1)			
	L12	PJ7 (10)			
	E12	PB0 (1)			
	A11	PB2 (5)			
	B7	PB5 (4)			
	B5	PD4 (1)			
CCP1	M1	PC5 (1)	I/O	TTL	Capture/Compare/PWM 1.
	L1	PC4 (9)			
	L6	PA6 (2)			
	L10	PJ6 (10)			
	D12	PB1 (4)			
	A7	PB6 (1)			
	B4	PE3 (1)			
A2	PD7 (3)				
CCP2	B2	PE4 (6)	I/O	TTL	Capture/Compare/PWM 2.
	G2	PD1 (10)			
	L1	PC4 (5)			
	K3	PF5 (1)			
	K12	PJ5 (10)			
	D12	PB1 (1)			
	A12	PE1 (4)			
	B7	PB5 (6)			
	A4	PE2 (5)			
C6	PD5 (1)				
CCP3	B2	PE4 (1)	I/O	TTL	Capture/Compare/PWM 3.
	M2	PC6 (1)			
	M1	PC5 (5)			
	M6	PA7 (7)			
	H12	PF1 (10)			
	A11	PB2 (4)			
	B11	PE0 (3)			
	B5	PD4 (2)			

Table 11-3. Signals for General-Purpose Timers (108BGA) (continued)

Pin Name	Pin Number	Pin Mux / Pin Assignment	Pin Type	Buffer Type <sup>a</sup>	Description
CCP4	L2 L1 M6 K11 A4 C6	PC7 (1) PC4 (6) PA7 (2) PJ4 (10) PE2 (1) PD5 (2)	I/O	TTL	Capture/Compare/PWM 4.
CCP5	B3 H2 L1 C10 A7 B7	PE5 (1) PD2 (4) PC4 (1) PG7 (8) PB6 (6) PB5 (2)	I/O	TTL	Capture/Compare/PWM 5.
CCP6	G1 H2 M10 A12 C9 B7	PD0 (6) PD2 (2) PJ3 (10) PE1 (5) PH0 (1) PB5 (3)	I/O	TTL	Capture/Compare/PWM 6.
CCP7	G2 H1 C8 A7 B4	PD1 (6) PD3 (2) PH1 (1) PB6 (2) PE3 (5)	I/O	TTL	Capture/Compare/PWM 7.

a. The TTL designation indicates the pin has TTL-compatible voltage levels.

## 11.3 Functional Description

The main components of each GPTM block are two free-running 16-bit up/down counters (referred to as Timer A and Timer B), two 16-bit match registers, two prescaler match registers, two 16-bit shadow registers, and two 16-bit load/initialization registers and their associated control functions. The exact functionality of each GPTM is controlled by software and configured through the register interface.

Software configures the GPTM using the **GPTM Configuration (GPTMCFG)** register (see page 450), the **GPTM Timer A Mode (GPTMTAMR)** register (see page 451), and the **GPTM Timer B Mode (GPTMTBMR)** register (see page 453). When in one of the 32-bit modes, the timer can only act as a 32-bit timer. However, when configured in 16-bit mode, the GPTM can have its two 16-bit timers configured in any combination of the 16-bit modes.

### 11.3.1 GPTM Reset Conditions

After reset has been applied to the GPTM module, the module is in an inactive state, and all control registers are cleared and in their default states. Counters Timer A and Timer B are initialized to 0xFFFF, along with their corresponding load registers: the **GPTM Timer A Interval Load (GPTMTAILR)** register (see page 468) and the **GPTM Timer B Interval Load (GPTMTBILR)** register (see page 469) and shadow registers: the **GPTM Timer A Value (GPTMTAV)** register (see page 479) and the **GPTM Timer B Value (GPTMTBV)** register (see page 480). The prescale counters are initialized to 0x00: the **GPTM Timer A Prescale (GPTMTAPR)** register (see page 472) and the **GPTM Timer B Prescale (GPTMTBPR)** register (see page 473).

### 11.3.2 32-Bit Timer Operating Modes

This section describes the three GPTM 32-bit timer modes (One-Shot, Periodic, and RTC) and their configurations.

The GPTM is placed into 32-bit mode by writing a 0x0 (One-Shot/Periodic 32-bit timer mode) or a 0x1 (RTC mode) to the `GPTMCFG` bit field in the **GPTM Configuration (GPTMCFG)** register. In both configurations, certain GPTM registers are concatenated to form pseudo 32-bit registers. These registers include:

- **GPTM Timer A Interval Load (GPTMTAILR)** register [15:0], see page 468
- **GPTM Timer B Interval Load (GPTMTBILR)** register [15:0], see page 469
- **GPTM Timer A (GPTMTAR)** register [15:0], see page 476
- **GPTM Timer B (GPTMTBR)** register [15:0], see page 477
- **GPTM Timer A Value (GPTMTAV)** register [15:0], see page 479
- **GPTM Timer B Value (GPTMTBV)** register [15:0], see page 480

In the 32-bit modes, the GPTM translates a 32-bit write access to **GPTMTAILR** into a write access to both **GPTMTAILR** and **GPTMTBILR**. The resulting word ordering for such a write operation is:

```
GPTMTBILR[15:0]:GPTMTAILR[15:0]
```

Likewise, a 32-bit read access to **GPTMTAR** returns the value:

```
GPTMTBR[15:0]:GPTMTAR[15:0]
```

A 32-bit read access to **GPTMTAV** returns the value:

```
GPTMTBV[15:0]:GPTMTAV[15:0]
```

#### 11.3.2.1 32-Bit One-Shot/Periodic Timer Mode

In 32-bit one-shot and periodic timer modes, the concatenated versions of the Timer A and Timer B registers are configured as a 32-bit up or down counter. The selection of one-shot or periodic mode is determined by the value written to the `TAMR` field of the **GPTM Timer A Mode (GPTMTAMR)** register (see page 451); there is no need to write to the **GPTM Timer B Mode (GPTMTBMR)** register. The timer is configured to count up or down using the `TACDIR` bit in the **GPTMTAMR** register.

When software sets the `TAEN` bit in the **GPTM Control (GPTMCTL)** register (see page 455), the timer begins counting up from 0x0000.0000 or down from its preloaded value. Alternatively, if the `TAWOT` bit is set in the **GPTMTAMR** register, once the `TAEN` bit is set, the timer waits for a trigger to begin counting (see “Wait-for-Trigger Mode” on page 444).

When the timer is counting down and it reaches the time-out event (0x0000.0000), the timer reloads its start value from the concatenated **GPTMTAILR** on the next cycle. When the timer is counting up and it reaches the time-out event (the value in the concatenated **GPTMTAILR**), the timer starts counting again from 0x0000.0000 on the next cycle. If configured to be a one-shot timer, the timer stops counting and clears the `TAEN` bit in the **GPTMCTL** register. If configured as a periodic timer, it continues counting. In periodic, snap-shot mode (`TASNAPS` bit in the **GPTMTAMR** register is set), the actual free-running value of the timer at the time-out event is loaded into the **GPTMTAR** register. In this manner, software can determine the time elapsed from the interrupt assertion to the ISR entry.

In addition to reloading the count value, the GPTM generates interrupts and triggers when it reaches the time-out event. The GPTM sets the `TATORIS` bit in the **GPTM Raw Interrupt Status (GPTMRIS)** register (see page 460), and holds it until it is cleared by writing the **GPTM Interrupt Clear (GPTMICR)** register (see page 466). If the time-out interrupt is enabled in the **GPTM Interrupt Mask (GPTIMR)** register (see page 458), the GPTM also sets the `TATOMIS` bit in the **GPTM Masked Interrupt Status (GPTMMIS)** register (see page 463). By setting the `TAMIE` bit in the **GPTMTAMR** register, an interrupt can also be generated when the Timer A value equals the value loaded into the **GPTM Timer A Match (GPTMTAMATCH)** register. This interrupt has the same status, masking, and clearing functions as the time-out interrupt. The ADC trigger is enabled by setting the `TAOTE` bit in **GPTMCTL**. The  $\mu$ DMA trigger is enabled by configuring and enabling the appropriate  $\mu$ DMA channel. See “Channel Configuration” on page 250.

If software updates the **GPTMTAILR** register while the counter is counting down, the counter loads the new value on the next clock cycle and continues counting down from the new value. If software updates the **GPTM Timer A Value (GPTMTAV)** register while the counter is counting up or down, the counter loads the new value on the next clock cycle and continues counting from the new value.

If the `TASTALL` bit in the **GPTMCTL** register is set, the timer freezes counting while the processor is halted by the debugger. The timer resumes counting when the processor resumes execution.

### 11.3.2.2 32-Bit Real-Time Clock Timer Mode

In Real-Time Clock (RTC) mode, the concatenated versions of the Timer A and Timer B registers are configured as a 32-bit up-counter. When RTC mode is selected for the first time after reset, the counter is loaded with a value of `0x0000.0001`. All subsequent load values must be written to the **GPTM Timer A Interval Load (GPTMTAILR)** register (see page 468).

The input clock on an even CCP input is required to be 32.768 KHz in RTC mode. The clock signal is then divided down to a 1-Hz rate and is passed along to the input of the 32-bit counter.

When software writes the `TAEN` bit in the **GPTMCTL** register, the counter starts counting up from its preloaded value of `0x0000.0001`. When the current count value matches the preloaded value in the **GPTMTAMATCHR** register, the GPTM asserts the `RTCRES` bit in **GPTMRIS** and continues counting until either a hardware reset, or it is disabled by software (clearing the `TAEN` bit). When the timer value reaches `0xFFFF.FFFF`, the timer rolls over and continues counting up from `0x0`. If the RTC interrupt is enabled in **GPTIMR**, the GPTM also sets the `RTCMIS` bit in **GPTMISR** and generates a controller interrupt. The status flags are cleared by writing the `RTCCINT` bit in **GPTMICR**.

In addition to generating interrupts, a  $\mu$ DMA trigger can be generated. The  $\mu$ DMA trigger is enabled by configuring and enabling the appropriate  $\mu$ DMA channel. See “Channel Configuration” on page 250.

If the `TASTALL` and/or `TBSTALL` bits in the **GPTMCTL** register are set, the timer does not freeze if the `RTCEN` bit is set in **GPTMCTL**.

### 11.3.3 16-Bit Timer Operating Modes

The GPTM is placed into global 16-bit mode by writing a value of `0x4` to the **GPTM Configuration (GPTMCFG)** register (see page 450). This section describes each of the GPTM 16-bit modes of operation. Timer A and Timer B have identical modes, so a single description is given using an `n` to reference both.

#### 11.3.3.1 16-Bit One-Shot/Periodic Timer Mode

In 16-bit one-shot and periodic timer modes, the timer is configured as a 16-bit up or down-counter with an optional 8-bit prescaler that effectively extends the counting range of the timer to 24 bits. The selection of one-shot or periodic mode is determined by the value written to the `TnMR` field of the **GPTMTnMR** register. The optional prescaler is loaded into the **GPTM Timer n Prescale**

(**GPTMTnPR**) register. The timer is configured to count up or down using the **TnCDIR** bit in the **GPTMTnMR** register.

When software sets the **TnEN** bit in the **GPTMCTL** register, the timer begins counting up from 0x0000.0000 or down from its preloaded value. Alternatively, if the **TnWOT** bit is set in the **GPTMTnMR** register, once the **TnEN** bit is set, the timer waits for a trigger to begin counting (see “Wait-for-Trigger Mode” on page 444).

When the timer is counting down and it reaches the time-out event (0x0000), the timer reloads its start value from the concatenated **GPTMTnILR** and **GPTMTnPR** on the next cycle. When the timer is counting up and it reaches the time-out event (the value in the **GPTMTnILR**), the timer starts counting again from 0x0000 on the next cycle. If configured to be a one-shot timer, the timer stops counting and clears the **TnEN** bit in the **GPTMCTL** register. If configured as a periodic timer, it continues counting. In periodic, snap-shot mode, (**TnSNAPS** bit in the **GPTMTnMR** register is set), the actual free-running value of the timer at the time-out event is loaded into the **GPTMTAR** register. In this manner, software can determine the time elapsed from the interrupt assertion to the ISR entry.

In addition to reloading the count value, the timer generates interrupts and triggers when it reaches the time-out event. The GPTM sets the **TnTORIS** bit in the **GPTMRIS** register, and holds it until it is cleared by writing the **GPTMICR** register. If the time-out interrupt is enabled in **GPTIMR**, the GPTM also sets the **TnTOMIS** bit in **GPTMISR** and generates a controller interrupt. By setting the **TnMIE** bit in the **GPTMTnMR** register, an interrupt can also be generated when the timer value equals the value loaded into the **GPTM Timer n Match (GPTMTnMATCH)** register. This interrupt has the same status, masking, and clearing functions as the time-out interrupt. The ADC trigger is enabled by setting the **TnOTE** bit in the **GPTMCTL** register. The  $\mu$ DMA trigger is enabled by configuring and enabling the appropriate  $\mu$ DMA channel. See “Channel Configuration” on page 250.

If software updates the **GPTMTnILR** register while the counter is counting down, the counter loads the new value on the next clock cycle and continues counting down from the new value. If software updates the **GPTM Timer n Value (GPTMTnV)** register while the counter is counting up or down, the counter loads the new value on the next clock cycle and continues counting from the new value.

If the **TnSTALL** bit in the **GPTMCTL** register is set, the timer freezes counting while the processor is halted by the debugger. The timer resumes counting when the processor resumes execution.

The following example shows a variety of configurations for a 16-bit free-running timer while using the prescaler. All values assume an 80-MHz clock with  $T_c=12.5$  ns (clock period).

**Table 11-4. 16-Bit Timer With Prescaler Configurations**

Prescale	#Clock ( $T_c$ ) <sup>a</sup>	Max Time	Units
00000000	1	0.8192	mS
00000001	2	1.6384	mS
00000010	3	2.4576	mS
-----	--	--	--
11111101	254	208.0768	mS
11111110	255	208.896	mS
11111111	256	209.7152	mS

a.  $T_c$  is the clock period.

### 11.3.3.2 Input Edge-Count Mode

**Note:** For rising-edge detection, the input signal must be High for at least two system clock periods following the rising edge. Similarly, for falling-edge detection, the input signal must be Low



for at least two system clock periods following the falling edge. Based on this criteria, the maximum input frequency for edge detection is 1/4 of the system frequency.

In Edge-Count mode, the timer is configured as a 24-bit down-counter with the MSB stored in the **GPTM Timer n Prescale (GPTMTnPR)** register and the remaining 16 bits in the **GPTMTnILR** register. In this mode, the timer is capable of capturing three types of events: rising edge, falling edge, or both. To place the timer in Edge-Count mode, the  $TnCMR$  bit of the **GPTMTnMR** register must be cleared. The type of edge that the timer counts is determined by the  $TnEVENT$  fields of the **GPTMCTL** register. During initialization, the **GPTM Timer n Match (GPTMTnMATCHR)** register is configured so that the difference between the value in the **GPTMTnILR** register and the **GPTMTnMATCHR** register equals the number of edge events that must be counted.

When software writes the  $TnEN$  bit in the **GPTM Control (GPTMCTL)** register, the timer is enabled for event capture. Each input event on the **CCP** pin decrements the counter by 1 until the event count matches **GPTMTnMATCHR**. When the counts match, the GPTM asserts the  $CnMRIS$  bit in the **GPTMRIS** register (and the  $CnMMIS$  bit, if the interrupt is not masked).

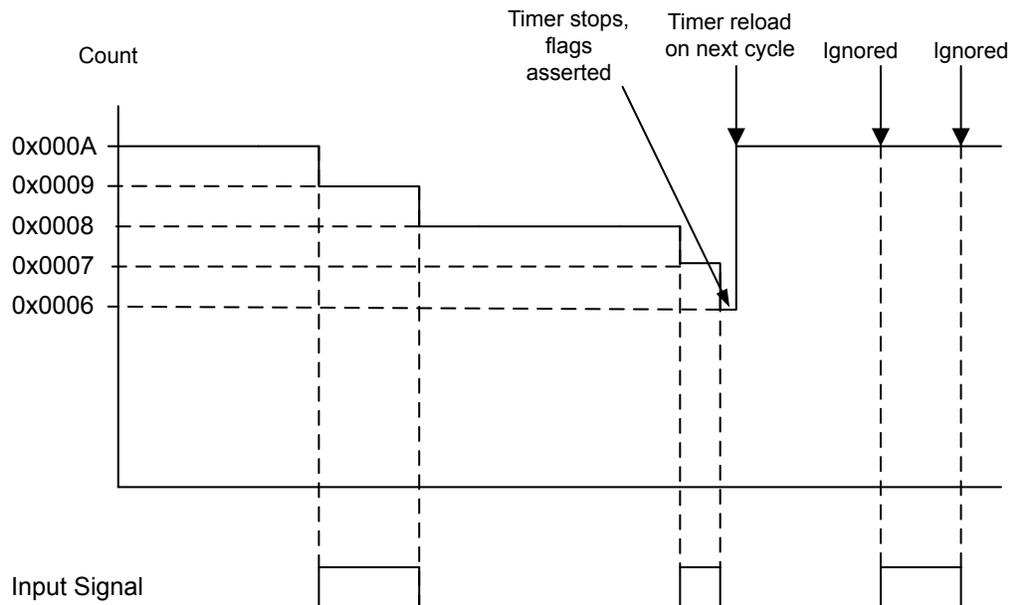
In addition to generating interrupts, a  $\mu$ DMA trigger can be generated. The  $\mu$ DMA trigger is enabled by configuring and enabling the appropriate  $\mu$ DMA channel. See “Channel Configuration” on page 250.

The counter is then reloaded using the value in **GPTMTnILR**, and stopped because the GPTM automatically clears the  $TnEN$  bit in the **GPTMCTL** register. Once the event count has been reached, all further events are ignored until  $TnEN$  is re-enabled by software.

Figure 11-2 on page 441 shows how Input Edge-Count mode works. In this case, the timer start value is set to **GPTMnILR** = 0x000A and the match value is set to **GPTMnMATCHR** = 0x0006 so that four edge events are counted. The counter is configured to detect both edges of the input signal.

Note that the last two edges are not counted since the timer automatically clears the  $TnEN$  bit after the current count matches the value in the **GPTMnMR** register.

**Figure 11-2. 16-Bit Input Edge-Count Mode Example**



### 11.3.3.3 16-Bit Input Edge-Time Mode

**Note:** For rising-edge detection, the input signal must be High for at least two system clock periods following the rising edge. Similarly, for falling edge detection, the input signal must be Low for at least two system clock periods following the falling edge. Based on this criteria, the maximum input frequency for edge detection is 1/4 of the system frequency.

The prescaler is not available in 16-Bit Input Edge-Time mode.

In Edge-Time mode, the timer is configured as a 16-bit free-running down-counter. In this mode, the timer is initialized to the value loaded in the **GPTMTnILR** register (or 0xFFFF at reset). In this mode, the timer is capable of capturing three types of events: rising edge, falling edge, or both. The timer is placed into Edge-Time mode by setting the **TnCMR** bit in the **GPTMTnMR** register, and the type of event that the timer captures is determined by the **TnEVENT** fields of the **GPTMCnTL** register.

When software writes the **TnEN** bit in the **GPTMCTL** register, the timer is enabled for event capture. When the selected input event is detected, the current **Tn** counter value is captured in the **GPTMTnR** register and is available to be read by the microcontroller. The GPTM then asserts the **CnERIS** bit (and the **CnEMIS** bit, if the interrupt is not masked). The **GPTMTnV** is the free-running value of the timer and can be read to determine the time that elapsed between the interrupt assertion and the entry into the ISR.

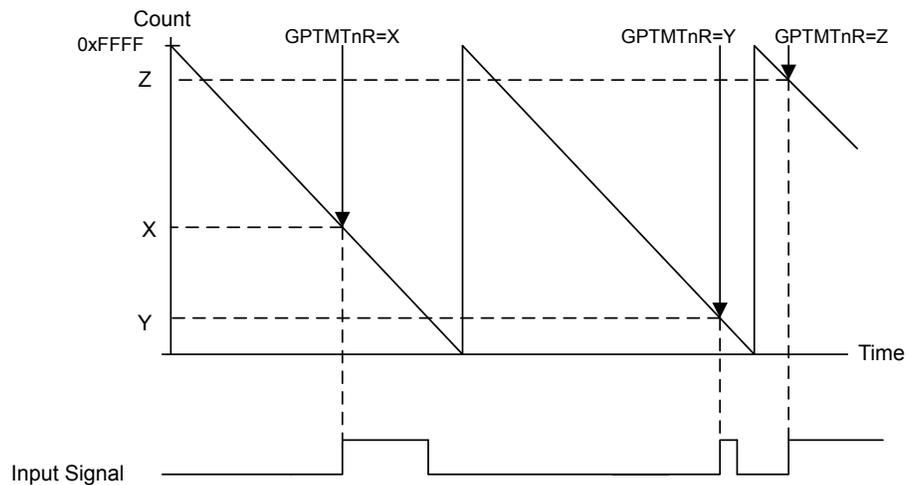
In addition to generating interrupts, a  $\mu$ DMA trigger can be generated. The  $\mu$ DMA trigger is enabled by configuring and enabling the appropriate  $\mu$ DMA channel. See “Channel Configuration” on page 250.

After an event has been captured, the timer does not stop counting. It continues to count until the **TnEN** bit is cleared. When the timer reaches the 0x0000 state, it is reloaded with the value from the **GPTMnILR** register.

Figure 11-3 on page 443 shows how input edge timing mode works. In the diagram, it is assumed that the start value of the timer is the default value of 0xFFFF, and the timer is configured to capture rising edge events.

Each time a rising edge event is detected, the current count value is loaded into the **GPTMTnR** register, and is held there until another rising edge is detected (at which point the new count value is loaded into **GPTMTnR**).

Figure 11-3. 16-Bit Input Edge-Time Mode Example



#### 11.3.3.4 16-Bit PWM Mode

**Note:** The prescaler is not available in 16-Bit PWM mode.

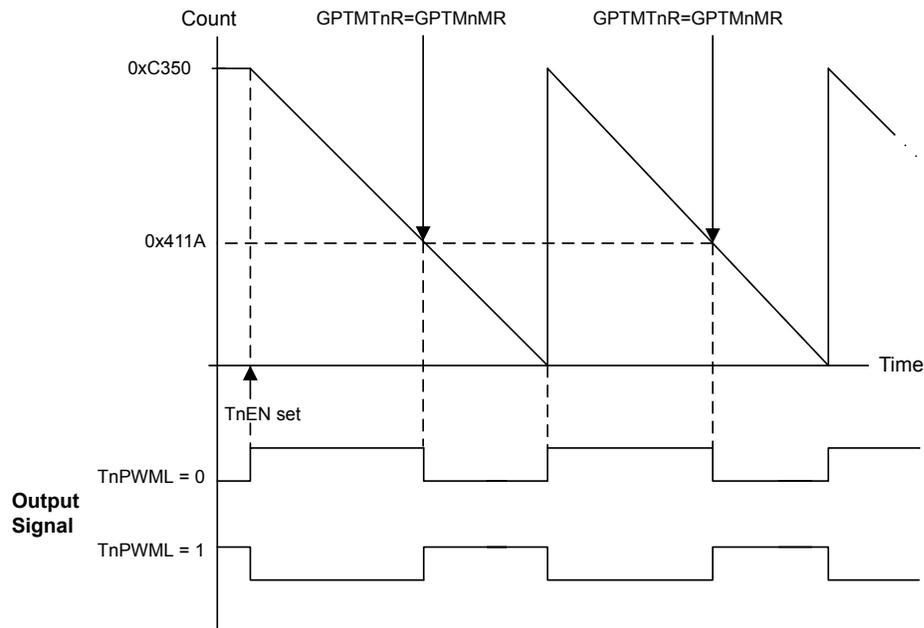
The GPTM supports a simple PWM generation mode. In PWM mode, the timer is configured as a down-counter with a start value (and thus period) defined by **GPTMTnILR**. In this mode, the PWM frequency and period are synchronous events and therefore guaranteed to be glitch free. PWM mode is enabled with the **GPTMTnMR** register by setting the  $T_nAMS$  bit to 0x1, the  $T_nCMR$  bit to 0x0, and the  $T_nMR$  field to 0x2.

When software writes the  $T_nEN$  bit in the **GPTMCTL** register, the counter begins counting down until it reaches the 0x0000 state. On the next counter cycle, the counter reloads its start value from **GPTMTnILR** and continues counting until disabled by software clearing the  $T_nEN$  bit in the **GPTMCTL** register. No interrupts or status bits are asserted in PWM mode.

The output PWM signal asserts when the counter is at the value of the **GPTMTnILR** register (its start state), and is deasserted when the counter value equals the value in the **GPTM Timer n Match Register (GPTMnMATCHR)**. Software has the capability of inverting the output PWM signal by setting the  $T_nPWML$  bit in the **GPTMCTL** register.

Figure 11-4 on page 444 shows how to generate an output PWM with a 1-ms period and a 66% duty cycle assuming a 50-MHz input clock and  $T_nPWML = 0$  (duty cycle would be 33% for the  $T_nPWML = 1$  configuration). For this example, the start value is **GPTMnILR=0xC350** and the match value is **GPTMnMR=0x411A**.

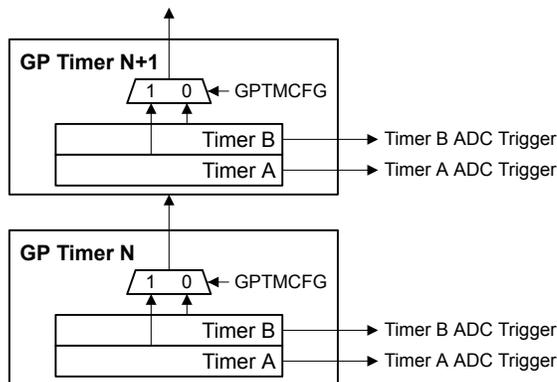
Figure 11-4. 16-Bit PWM Mode Example



### 11.3.3.5 Wait-for-Trigger Mode

The Wait-for-Trigger mode allows daisy chaining of the timer modules such that once configured, a single timer can initiate multiple timing events using the Timer triggers. Wait-for-Trigger mode is enabled by setting the  $TnWOT$  bit in the **GPTMTnMR** register. When the  $TnWOT$  bit is set, Timer N+1 does not begin counting until the timer in the previous position in the daisy chain (Timer N) reaches its time-out event. The daisy chain is configured such that GPTM1 always follows GPTM0, GPTM2 follows GPTM1, and so on. If Timer A is in 32-bit mode (controlled by the  $GPTMCFG$  bit in the **GPTMCFG** register), it triggers Timer A in the next module. If Timer A is in 16-bit mode, it triggers Timer B in the same module, and Timer B triggers Timer A in the next module. Care must be taken that the  $TAWOT$  bit is never set in GPTM0. Figure 11-5 on page 444 shows how the  $GPTMCFG$  bit affects the daisy chain. This function is valid for both one-shot and periodic modes.

Figure 11-5. Timer Daisy Chain



### 11.3.4 DMA Operation

The timers each have a dedicated  $\mu$ DMA channel and can provide a request signal to the  $\mu$ DMA controller. The request is a burst type and occurs whenever a timer raw interrupt condition occurs. The arbitration size of the  $\mu$ DMA transfer should be set to the amount of data that should be transferred whenever a timer event occurs.

For example, to transfer 256 items, 8 items at a time every 10 ms, configure a timer to generate a periodic timeout at 10 ms. Configure the  $\mu$ DMA transfer for a total of 256 items, with a burst size of 8 items. Each time the timer times out, the  $\mu$ DMA controller transfers 8 items, until all 256 items have been transferred.

No other special steps are needed to enable Timers for  $\mu$ DMA operation. Refer to “Micro Direct Memory Access ( $\mu$ DMA)” on page 246 for more details about programming the  $\mu$ DMA controller.

## 11.4 Initialization and Configuration

To use the general-purpose timers, the peripheral clock must be enabled by setting the `TIMER0`, `TIMER1`, `TIMER2`, and `TIMER3` bits in the **RCGC1** register (see page 181). If using any CCP pins, the clock to the appropriate GPIO module must be enabled via the **RCGC2** register in the System Control module (see page 193). To find out which GPIO port to enable, refer to Table 25-4 on page 1151. Configure the `PMCn` fields in the **GPIOPCTL** register to assign the CCP signals to the appropriate pins (see page 346 and Table 25-5 on page 1160).

This section shows module initialization and configuration examples for each of the supported timer modes.

### 11.4.1 32-Bit One-Shot/Periodic Timer Mode

The GPTM is configured for 32-bit One-Shot and Periodic modes by the following sequence:

1. Ensure the timer is disabled (the `TAEN` bit in the **GPTMCTL** register is cleared) before making any changes.
2. Write the **GPTM Configuration Register (GPTMCFG)** with a value of `0x0000.0000`.
3. Configure the `TAMR` field in the **GPTM Timer A Mode Register (GPTMTAMR)**:
  - a. Write a value of `0x1` for One-Shot mode.
  - b. Write a value of `0x2` for Periodic mode.
4. Optionally configure the `TASNAPS`, `TAWOT`, `TAMTE`, and `TACDIR` bits in the **GPTMTAMR** register to select whether to capture the value of the free-running timer at time-out, use an external trigger to start counting, configure an additional trigger or interrupt, and count up or down.
5. Load the start value into the **GPTM Timer A Interval Load Register (GPTMTAILR)**.
6. If interrupts are required, set the appropriate bits in the **GPTM Interrupt Mask Register (GPTMIMR)**.
7. Set the `TAEN` bit in the **GPTMCTL** register to enable the timer and start counting.
8. Poll the **GPTMRIS** register or wait for the interrupt to be generated (if enabled). In both cases, the status flags are cleared by writing a 1 to the appropriate bit of the **GPTM Interrupt Clear Register (GPTMICR)**.

If the `TAMIE` bit in the **GPTMTAMR** register is set, the `RTCRES` bit in the **GPTMRIS** register is set, and the timer continues counting. In One-Shot mode, the timer stops counting after the time-out event. To re-enable the timer, repeat the sequence. A timer configured in Periodic mode reloads the timer and continues counting after the time-out event.

### 11.4.2 32-Bit Real-Time Clock (RTC) Mode

To use the RTC mode, the timer must have a 32.768-KHz input signal on an even CCP input. To enable the RTC feature, follow these steps:

1. Ensure the timer is disabled (the `TAEN` bit is cleared) before making any changes.
2. Write the **GPTM Configuration Register (GPTMCFG)** with a value of `0x0000.0001`.
3. Write the match value to the **GPTM Timer A Match Register (GPTMTAMATCHR)**.
4. Set/clear the `RTCEN` bit in the **GPTM Control Register (GPTMCTL)** as needed.
5. If interrupts are required, set the `RTCIM` bit in the **GPTM Interrupt Mask Register (GPTMIMR)**.
6. Set the `TAEN` bit in the **GPTMCTL** register to enable the timer and start counting.

When the timer count equals the value in the **GPTMTAMATCHR** register, the counter is re-loaded with `0x0000.0000` and begins counting. If an interrupt is enabled, it does not have to be cleared.

### 11.4.3 16-Bit One-Shot/Periodic Timer Mode

A timer is configured for 16-bit One-Shot and Periodic modes by the following sequence:

1. Ensure the timer is disabled (the `TnEN` bit is cleared) before making any changes.
2. Write the **GPTM Configuration Register (GPTMCFG)** with a value of `0x0000.0004`.
3. Set the `TnMR` field in the **GPTM Timer Mode (GPTMTnMR)** register:
  - a. Write a value of `0x1` for One-Shot mode.
  - b. Write a value of `0x2` for Periodic mode.
4. Optionally configure the `TnSNAPS`, `TnWOT`, `TnMTE` and `TnCDIR` bits in the **GPTMTnMR** register to select whether to capture the value of the free-running timer at time-out, use an external trigger to start counting, configure an additional trigger or interrupt, and count up or down.
5. If a prescaler is to be used, write the prescale value to the **GPTM Timer n Prescale Register (GPTMTnPR)**.
6. Load the start value into the **GPTM Timer Interval Load Register (GPTMTnILR)**.
7. If interrupts are required, set the appropriate bit in the **GPTM Interrupt Mask Register (GPTMIMR)**.
8. Set the `TnEN` bit in the **GPTM Control Register (GPTMCTL)** to enable the timer and start counting.

9. Poll the **GPTMRIS** register or wait for the interrupt to be generated (if enabled). In both cases, the status flags are cleared by writing a 1 to the appropriate bit of the **GPTM Interrupt Clear Register (GPTMICR)**.

If the  $TnMIE$  bit in the **GPTMTnMR** register is set, the  $RTCRES$  bit in the **GPTMRIS** register is set, and the timer continues counting. In One-Shot mode, the timer stops counting after the time-out event. To re-enable the timer, repeat the sequence. A timer configured in Periodic mode reloads the timer and continues counting after the time-out event.

#### 11.4.4 Input Edge-Count Mode

A timer is configured to Input Edge-Count mode by the following sequence:

1. Ensure the timer is disabled (the  $TnEN$  bit is cleared) before making any changes.
2. Write the **GPTM Configuration (GPTMCFG)** register with a value of 0x0000.0004.
3. In the **GPTM Timer Mode (GPTMTnMR)** register, write the  $TnCMR$  field to 0x0 and the  $TnMR$  field to 0x3.
4. Configure the type of event(s) that the timer captures by writing the  $TnEVENT$  field of the **GPTM Control (GPTMCTL)** register.
5. If a prescaler is to be used, write the prescale value to the **GPTM Timer n Prescale Register (GPTMTnPR)**.
6. Load the timer start value into the **GPTM Timer n Interval Load (GPTMTnILR)** register.
7. Load the event count into the **GPTM Timer n Match (GPTMTnMATCHR)** register.
8. If interrupts are required, set the  $CnMIM$  bit in the **GPTM Interrupt Mask (GPTMIMR)** register.
9. Set the  $TnEN$  bit in the **GPTMCTL** register to enable the timer and begin waiting for edge events.
10. Poll the  $CnMRIS$  bit in the **GPTMRIS** register or wait for the interrupt to be generated (if enabled). In both cases, the status flags are cleared by writing a 1 to the  $CnMCINT$  bit of the **GPTM Interrupt Clear (GPTMICR)** register.

In Input Edge-Count Mode, the timer stops after the programmed number of edge events has been detected. To re-enable the timer, ensure that the  $TnEN$  bit is cleared and repeat step 4 on page 447 through step 9 on page 447.

#### 11.4.5 16-Bit Input Edge Timing Mode

A timer is configured to Input Edge Timing mode by the following sequence:

1. Ensure the timer is disabled (the  $TnEN$  bit is cleared) before making any changes.
2. Write the **GPTM Configuration (GPTMCFG)** register with a value of 0x0000.0004.
3. In the **GPTM Timer Mode (GPTMTnMR)** register, write the  $TnCMR$  field to 0x1 and the  $TnMR$  field to 0x3.
4. Configure the type of event that the timer captures by writing the  $TnEVENT$  field of the **GPTM Control (GPTMCTL)** register.

5. If a prescaler is to be used, write the prescale value to the **GPTM Timer n Prescale Register (GPTMTnPR)**.
6. Load the timer start value into the **GPTM Timer n Interval Load (GPTMTnILR)** register.
7. If interrupts are required, set the `CnEIM` bit in the **GPTM Interrupt Mask (GPTMIMR)** register.
8. Set the `TnEN` bit in the **GPTM Control (GPTMCTL)** register to enable the timer and start counting.
9. Poll the `CnERIS` bit in the **GPTMRIS** register or wait for the interrupt to be generated (if enabled). In both cases, the status flags are cleared by writing a 1 to the `CnECINT` bit of the **GPTM Interrupt Clear (GPTMICR)** register. The time at which the event happened can be obtained by reading the **GPTM Timer n (GPTMTnR)** register.

In Input Edge Timing mode, the timer continues running after an edge event has been detected, but the timer interval can be changed at any time by writing the **GPTMTnILR** register. The change takes effect at the next cycle after the write.

#### 11.4.6 16-Bit PWM Mode

A timer is configured to PWM mode using the following sequence:

1. Ensure the timer is disabled (the `TnEN` bit is cleared) before making any changes.
2. Write the **GPTM Configuration (GPTMCFG)** register with a value of 0x0000.0004.
3. In the **GPTM Timer Mode (GPTMTnMR)** register, set the `TnAMS` bit to 0x1, the `TnCMR` bit to 0x0, and the `TnMR` field to 0x2.
4. Configure the output state of the PWM signal (whether or not it is inverted) in the `TnEVENT` field of the **GPTM Control (GPTMCTL)** register.
5. Load the timer start value into the **GPTM Timer n Interval Load (GPTMTnILR)** register.
6. Load the **GPTM Timer n Match (GPTMTnMATCHR)** register with the match value.
7. Set the `TnEN` bit in the **GPTM Control (GPTMCTL)** register to enable the timer and begin generation of the output PWM signal.

In PWM Timing mode, the timer continues running after the PWM signal has been generated. The PWM period can be adjusted at any time by writing the **GPTMTnILR** register, and the change takes effect at the next cycle after the write.

### 11.5 Register Map

Table 11-5 on page 449 lists the GPTM registers. The offset listed is a hexadecimal increment to the register's address, relative to that timer's base address:

- Timer0: 0x4003.0000
- Timer1: 0x4003.1000
- Timer2: 0x4003.2000
- Timer3: 0x4003.3000

Note that the GP Timer module clock must be enabled before the registers can be programmed (see page 181).



Table 11-5. Timers Register Map

Offset	Name	Type	Reset	Description	See page
0x000	GPTMCFG	R/W	0x0000.0000	GPTM Configuration	450
0x004	GPTMTAMR	R/W	0x0000.0000	GPTM Timer A Mode	451
0x008	GPTMTBMR	R/W	0x0000.0000	GPTM Timer B Mode	453
0x00C	GPTMCTL	R/W	0x0000.0000	GPTM Control	455
0x018	GPTMIMR	R/W	0x0000.0000	GPTM Interrupt Mask	458
0x01C	GPTMRIS	RO	0x0000.0000	GPTM Raw Interrupt Status	460
0x020	GPTMMIS	RO	0x0000.0000	GPTM Masked Interrupt Status	463
0x024	GPTMICR	W1C	0x0000.0000	GPTM Interrupt Clear	466
0x028	GPTMTAILR	R/W	0xFFFF.FFFF	GPTM Timer A Interval Load	468
0x02C	GPTMTBILR	R/W	0x0000.FFFF	GPTM Timer B Interval Load	469
0x030	GPTMTAMATCHR	R/W	0xFFFF.FFFF	GPTM Timer A Match	470
0x034	GPTMTBMATCHR	R/W	0x0000.FFFF	GPTM Timer B Match	471
0x038	GPTMTAPR	R/W	0x0000.0000	GPTM Timer A Prescale	472
0x03C	GPTMTBPR	R/W	0x0000.0000	GPTM Timer B Prescale	473
0x040	GPTMTAPMR	R/W	0x0000.0000	GPTM TimerA Prescale Match	474
0x044	GPTMTBPMR	R/W	0x0000.0000	GPTM TimerB Prescale Match	475
0x048	GPTMTAR	RO	0xFFFF.FFFF	GPTM Timer A	476
0x04C	GPTMTBR	RO	0x0000.FFFF	GPTM Timer B	477
0x050	GPTMTAV	RW	0xFFFF.FFFF	GPTM Timer A Value	479
0x054	GPTMTBV	RW	0x0000.FFFF	GPTM Timer B Value	480

## 11.6 Register Descriptions

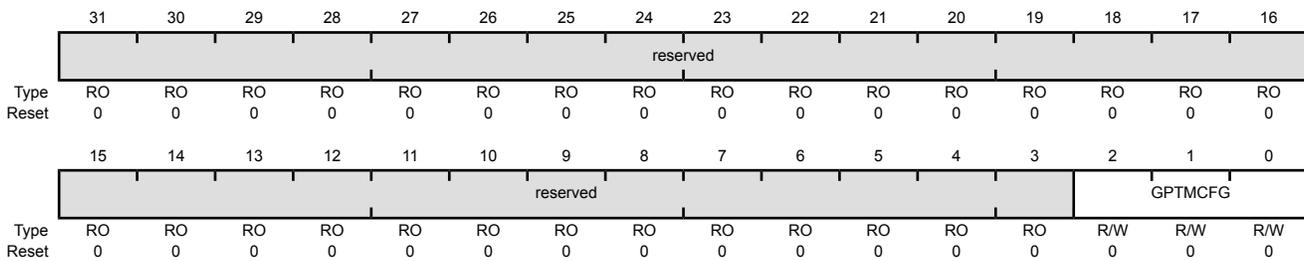
The remainder of this section lists and describes the GPTM registers, in numerical order by address offset.

### Register 1: GPTM Configuration (GPTMCFG), offset 0x000

This register configures the global operation of the GPTM module. The value written to this register determines whether the GPTM is in 32- or 16-bit mode.

#### GPTM Configuration (GPTMCFG)

Timer0 base: 0x4003.0000  
 Timer1 base: 0x4003.1000  
 Timer2 base: 0x4003.2000  
 Timer3 base: 0x4003.3000  
 Offset 0x000  
 Type R/W, reset 0x0000.0000



Bit/Field	Name	Type	Reset	Description
31:3	reserved	RO	0x0000.000	Software should not rely on the value of a reserved bit. To provide compatibility with future products, the value of a reserved bit should be preserved across a read-modify-write operation.
2:0	GPTMCFG	R/W	0x0	GPTM Configuration

The GPTMCFG values are defined as follows:

Value	Description
0x0	32-bit timer configuration.
0x1	32-bit real-time clock (RTC) counter configuration.
0x2	Reserved
0x3	Reserved
0x4	16-bit timer configuration. The function is controlled by bits 1:0 of GPTMTAMR and GPTMTBMR.

## Register 2: GPTM Timer A Mode (GPTMTAMR), offset 0x004

This register configures the GPTM based on the configuration selected in the **GPTMCFG** register. When in 16-bit PWM mode, set the **TAAMS** bit, clear the **TACMR** bit, and configure the **TAMR** field to 0x2.

In 16-bit timer configuration, **TAMR** controls the 16-bit timer modes for Timer A. In 32-bit timer configuration, this register controls the mode, and the contents of **GPTMTBMR** are ignored.

### GPTM Timer A Mode (GPTMTAMR)

Timer0 base: 0x4003.0000  
 Timer1 base: 0x4003.1000  
 Timer2 base: 0x4003.2000  
 Timer3 base: 0x4003.3000  
 Offset 0x004  
 Type R/W, reset 0x0000.0000

	31	30	29	28	27	26	25	24	23	22	21	20	19	18	17	16
	reserved															
Type	RO	RO	RO	RO	RO	RO	RO	RO	RO	RO	RO	RO	RO	RO	RO	RO
Reset	0	0	0	0	0	0	0	0	0	0	0	0	0	0	0	0
	15	14	13	12	11	10	9	8	7	6	5	4	3	2	1	0
	reserved								TASNAPS	TAWOT	TAMIE	TACDIR	TAAMS	TACMR	TAMR	
Type	RO	RO	RO	RO	RO	RO	RO	RO	R/W	R/W	R/W	R/W	R/W	R/W	R/W	R/W
Reset	0	0	0	0	0	0	0	0	0	0	0	0	0	0	0	0

Bit/Field	Name	Type	Reset	Description
31:8	reserved	RO	0x0000.00	Software should not rely on the value of a reserved bit. To provide compatibility with future products, the value of a reserved bit should be preserved across a read-modify-write operation.
7	TASNAPS	R/W	0	GPTM Timer A Snap-Shot Mode  Value Description 0 Snap-shot mode is disabled. 1 If Timer A is configured in the periodic mode, the actual free-running value of Timer A is loaded at the time-out event into the <b>GPTM Timer A (GPTMTAR)</b> register.
6	TAWOT	R/W	0	GPTM Timer A Wait-on-Trigger  Value Description 0 Timer A begins counting as soon as it is enabled. 1 If Timer A is enabled ( <b>TAEN</b> is set in the <b>GPTMCTL</b> register), Timer A does not begin counting until it receives a trigger from the timer in the previous position in the daisy chain, see Figure 11-5 on page 444. This function is valid for both one-shot and periodic modes.

This bit must be clear for GP Timer Module 0, Timer A.

Bit/Field	Name	Type	Reset	Description
5	TAMIE	R/W	0	<p>GPTM Timer A Match Interrupt Enable</p> <p>Value Description</p> <p>0 The match interrupt is disabled.</p> <p>1 An interrupt is generated when the match value in the <b>GPTMTAMATCHR</b> register is reached in the one-shot and periodic modes.</p>
4	TACDIR	R/W	0	<p>GPTM Timer A Count Direction</p> <p>Value Description</p> <p>0 The timer counts down.</p> <p>1 When in one-shot or periodic mode, the timer counts up. When counting up, the timer starts from a value of 0x0000.</p> <p>When in 16-bit PWM or 32-bit RTC mode, this bit must be clear; if this bit is set, unpredictable behavior results.</p>
3	TAAMS	R/W	0	<p>GPTM Timer A Alternate Mode Select</p> <p>The <b>TAAMS</b> values are defined as follows:</p> <p>Value Description</p> <p>0 Capture mode is enabled.</p> <p>1 PWM mode is enabled.</p> <p><b>Note:</b> To enable PWM mode, you must also clear the <b>TACMR</b> bit and configure the <b>TAMR</b> field to 0x2.</p>
2	TACMR	R/W	0	<p>GPTM Timer A Capture Mode</p> <p>The <b>TACMR</b> values are defined as follows:</p> <p>Value Description</p> <p>0 Edge-Count mode</p> <p>1 Edge-Time mode</p>
1:0	TAMR	R/W	0x0	<p>GPTM Timer A Mode</p> <p>The <b>TAMR</b> values are defined as follows:</p> <p>Value Description</p> <p>0x0 Reserved</p> <p>0x1 One-Shot Timer mode</p> <p>0x2 Periodic Timer mode</p> <p>0x3 Capture mode</p> <p>The Timer mode is based on the timer configuration defined by bits 2:0 in the <b>GPTMCFG</b> register (16-or 32-bit).</p>

### Register 3: GPTM Timer B Mode (GPTMTBMR), offset 0x008

This register configures the GPTM based on the configuration selected in the **GPTMCFG** register. When in 16-bit PWM mode, set the **TBAMS** bit, clear the **TBCMR** bit, and configure the **TBMR** field to 0x2.

In 16-bit timer configuration, these bits control the 16-bit timer modes for Timer B. In 32-bit timer configuration, this register's contents are ignored, and **GPTMTAMR** is used.

#### GPTM Timer B Mode (GPTMTBMR)

Timer0 base: 0x4003.0000  
 Timer1 base: 0x4003.1000  
 Timer2 base: 0x4003.2000  
 Timer3 base: 0x4003.3000  
 Offset 0x008  
 Type R/W, reset 0x0000.0000

	31	30	29	28	27	26	25	24	23	22	21	20	19	18	17	16
	reserved															
Type	RO	RO	RO	RO	RO	RO	RO	RO	RO	RO	RO	RO	RO	RO	RO	RO
Reset	0	0	0	0	0	0	0	0	0	0	0	0	0	0	0	0
	15	14	13	12	11	10	9	8	7	6	5	4	3	2	1	0
	reserved								TBSNAPS	TBWOT	TBMIE	TBCDIR	TBAMS	TBCMR	TBMR	
Type	RO	RO	RO	RO	RO	RO	RO	RO	R/W	R/W	R/W	R/W	R/W	R/W	R/W	R/W
Reset	0	0	0	0	0	0	0	0	0	0	0	0	0	0	0	0

Bit/Field	Name	Type	Reset	Description
31:8	reserved	RO	0x0000.00	Software should not rely on the value of a reserved bit. To provide compatibility with future products, the value of a reserved bit should be preserved across a read-modify-write operation.
7	TBSNAPS	R/W	0	GPTM Timer B Snap-Shot Mode  Value Description 0 Snap-shot mode is disabled. 1 If Timer B is configured in the periodic mode, the actual free-running value of Timer B is loaded at the time-out event into the <b>GPTM Timer B (GPTMTBR)</b> register.
6	TBWOT	R/W	0	GPTM Timer B Wait-on-Trigger  Value Description 0 Timer B begins counting as soon as it is enabled. 1 If Timer B is enabled ( <b>TBEN</b> is set in the <b>GPTMCTL</b> register), Timer B does not begin counting until it receives an it receives a trigger from the timer in the previous position in the daisy chain. See Figure 11-5 on page 444. This function is valid for both one-shot and periodic modes.

Bit/Field	Name	Type	Reset	Description
5	TBMIE	R/W	0	<p>GPTM Timer B Match Interrupt Enable</p> <p>Value Description</p> <p>0 The match interrupt is disabled.</p> <p>1 An interrupt is generated when the match value in the <b>GPTMTBMATCHR</b> register is reached in the one-shot and periodic modes.</p>
4	TBCDIR	R/W	0	<p>GPTM Timer B Count Direction</p> <p>Value Description</p> <p>0 The timer counts down.</p> <p>1 When in one-shot or periodic mode, the timer counts up. When counting up, the timer starts from a value of 0x0000.</p> <p>When in 16-bit PWM or 32-bit RTC mode, this bit must be clear; if this bit is set, unpredictable behavior results.</p>
3	TBAMS	R/W	0	<p>GPTM Timer B Alternate Mode Select</p> <p>The <b>TBAMS</b> values are defined as follows:</p> <p>Value Description</p> <p>0 Capture mode is enabled.</p> <p>1 PWM mode is enabled.</p> <p><b>Note:</b> To enable PWM mode, you must also clear the <b>TBCMR</b> bit and set the <b>TBMR</b> field to 0x2.</p>
2	TBCMR	R/W	0	<p>GPTM Timer B Capture Mode</p> <p>The <b>TBCMR</b> values are defined as follows:</p> <p>Value Description</p> <p>0 Edge-Count mode</p> <p>1 Edge-Time mode</p>
1:0	TBMR	R/W	0x0	<p>GPTM Timer B Mode</p> <p>The <b>TBMR</b> values are defined as follows:</p> <p>Value Description</p> <p>0x0 Reserved</p> <p>0x1 One-Shot Timer mode</p> <p>0x2 Periodic Timer mode</p> <p>0x3 Capture mode</p> <p>The timer mode is based on the timer configuration defined by bits 2:0 in the <b>GPTMCFG</b> register.</p>

## Register 4: GPTM Control (GPTMCTL), offset 0x00C

This register is used alongside the **GPTMCFG** and **GMTMTnMR** registers to fine-tune the timer configuration, and to enable other features such as timer stall and the output trigger. The output trigger can be used to initiate transfers on the ADC module.

### GPTM Control (GPTMCTL)

Timer0 base: 0x4003.0000  
 Timer1 base: 0x4003.1000  
 Timer2 base: 0x4003.2000  
 Timer3 base: 0x4003.3000  
 Offset 0x00C  
 Type R/W, reset 0x0000.0000

	31	30	29	28	27	26	25	24	23	22	21	20	19	18	17	16
	reserved															
Type	RO	RO	RO	RO	RO	RO	RO	RO	RO	RO	RO	RO	RO	RO	RO	RO
Reset	0	0	0	0	0	0	0	0	0	0	0	0	0	0	0	0
	15	14	13	12	11	10	9	8	7	6	5	4	3	2	1	0
	reserved	TBPWML	TBOTE	reserved	TBEVENT	TBSTALL	TBEN	reserved	TAPWML	TAOTE	RTCEN	TAEVENT	TASTALL	TAEN		
Type	RO	R/W	R/W	RO	R/W	R/W	R/W	R/W	RO	R/W	R/W	R/W	R/W	R/W	R/W	R/W
Reset	0	0	0	0	0	0	0	0	0	0	0	0	0	0	0	0

Bit/Field	Name	Type	Reset	Description						
31:15	reserved	RO	0x0000	Software should not rely on the value of a reserved bit. To provide compatibility with future products, the value of a reserved bit should be preserved across a read-modify-write operation.						
14	TBPWML	R/W	0	GPTM Timer B PWM Output Level  The <b>TBPWML</b> values are defined as follows:  <table border="1"> <thead> <tr> <th>Value</th> <th>Description</th> </tr> </thead> <tbody> <tr> <td>0</td> <td>Output is unaffected.</td> </tr> <tr> <td>1</td> <td>Output is inverted.</td> </tr> </tbody> </table>	Value	Description	0	Output is unaffected.	1	Output is inverted.
Value	Description									
0	Output is unaffected.									
1	Output is inverted.									
13	TBOTE	R/W	0	GPTM Timer B Output Trigger Enable  The <b>TBOTE</b> values are defined as follows:  <table border="1"> <thead> <tr> <th>Value</th> <th>Description</th> </tr> </thead> <tbody> <tr> <td>0</td> <td>The output Timer B ADC trigger is disabled.</td> </tr> <tr> <td>1</td> <td>The output Timer B ADC trigger is enabled.</td> </tr> </tbody> </table> <p>In addition, the ADC must be enabled and the timer selected as a trigger source with the <b>EMn</b> bit in the <b>ADCEMUX</b> register (see page 537).</p>	Value	Description	0	The output Timer B ADC trigger is disabled.	1	The output Timer B ADC trigger is enabled.
Value	Description									
0	The output Timer B ADC trigger is disabled.									
1	The output Timer B ADC trigger is enabled.									
12	reserved	RO	0	Software should not rely on the value of a reserved bit. To provide compatibility with future products, the value of a reserved bit should be preserved across a read-modify-write operation.						

Bit/Field	Name	Type	Reset	Description										
11:10	TBEVENT	R/W	0x0	<p>GPTM Timer B Event Mode</p> <p>The TBEVENT values are defined as follows:</p> <table border="1"> <thead> <tr> <th>Value</th> <th>Description</th> </tr> </thead> <tbody> <tr> <td>0x0</td> <td>Positive edge</td> </tr> <tr> <td>0x1</td> <td>Negative edge</td> </tr> <tr> <td>0x2</td> <td>Reserved</td> </tr> <tr> <td>0x3</td> <td>Both edges</td> </tr> </tbody> </table>	Value	Description	0x0	Positive edge	0x1	Negative edge	0x2	Reserved	0x3	Both edges
Value	Description													
0x0	Positive edge													
0x1	Negative edge													
0x2	Reserved													
0x3	Both edges													
9	TBSTALL	R/W	0	<p>GPTM Timer B Stall Enable</p> <p>The TBSTALL values are defined as follows:</p> <table border="1"> <thead> <tr> <th>Value</th> <th>Description</th> </tr> </thead> <tbody> <tr> <td>0</td> <td>Timer B continues counting while the processor is halted by the debugger.</td> </tr> <tr> <td>1</td> <td>Timer B freezes counting while the processor is halted by the debugger.</td> </tr> </tbody> </table> <p>If the processor is executing normally, the TBSTALL bit is ignored.</p>	Value	Description	0	Timer B continues counting while the processor is halted by the debugger.	1	Timer B freezes counting while the processor is halted by the debugger.				
Value	Description													
0	Timer B continues counting while the processor is halted by the debugger.													
1	Timer B freezes counting while the processor is halted by the debugger.													
8	TBEN	R/W	0	<p>GPTM Timer B Enable</p> <p>The TBEN values are defined as follows:</p> <table border="1"> <thead> <tr> <th>Value</th> <th>Description</th> </tr> </thead> <tbody> <tr> <td>0</td> <td>Timer B is disabled.</td> </tr> <tr> <td>1</td> <td>Timer B is enabled and begins counting or the capture logic is enabled based on the <b>GPTMCFG</b> register.</td> </tr> </tbody> </table>	Value	Description	0	Timer B is disabled.	1	Timer B is enabled and begins counting or the capture logic is enabled based on the <b>GPTMCFG</b> register.				
Value	Description													
0	Timer B is disabled.													
1	Timer B is enabled and begins counting or the capture logic is enabled based on the <b>GPTMCFG</b> register.													
7	reserved	RO	0	Software should not rely on the value of a reserved bit. To provide compatibility with future products, the value of a reserved bit should be preserved across a read-modify-write operation.										
6	TAPWML	R/W	0	<p>GPTM Timer A PWM Output Level</p> <p>The TAPWML values are defined as follows:</p> <table border="1"> <thead> <tr> <th>Value</th> <th>Description</th> </tr> </thead> <tbody> <tr> <td>0</td> <td>Output is unaffected.</td> </tr> <tr> <td>1</td> <td>Output is inverted.</td> </tr> </tbody> </table>	Value	Description	0	Output is unaffected.	1	Output is inverted.				
Value	Description													
0	Output is unaffected.													
1	Output is inverted.													
5	TAOTE	R/W	0	<p>GPTM Timer A Output Trigger Enable</p> <p>The TAOTE values are defined as follows:</p> <table border="1"> <thead> <tr> <th>Value</th> <th>Description</th> </tr> </thead> <tbody> <tr> <td>0</td> <td>The output Timer A ADC trigger is disabled.</td> </tr> <tr> <td>1</td> <td>The output Timer A ADC trigger is enabled.</td> </tr> </tbody> </table> <p>In addition, the ADC must be enabled and the timer selected as a trigger source with the EMn bit in the <b>ADCEMUX</b> register (see page 537).</p>	Value	Description	0	The output Timer A ADC trigger is disabled.	1	The output Timer A ADC trigger is enabled.				
Value	Description													
0	The output Timer A ADC trigger is disabled.													
1	The output Timer A ADC trigger is enabled.													



Bit/Field	Name	Type	Reset	Description										
4	RTCEN	R/W	0	<p>GPTM RTC Enable</p> <p>The <code>RTCEN</code> values are defined as follows:</p> <table border="1"> <thead> <tr> <th>Value</th> <th>Description</th> </tr> </thead> <tbody> <tr> <td>0</td> <td>RTC counting is disabled.</td> </tr> <tr> <td>1</td> <td>RTC counting is enabled.</td> </tr> </tbody> </table>	Value	Description	0	RTC counting is disabled.	1	RTC counting is enabled.				
Value	Description													
0	RTC counting is disabled.													
1	RTC counting is enabled.													
3:2	TAEVENT	R/W	0x0	<p>GPTM Timer A Event Mode</p> <p>The <code>TAEVENT</code> values are defined as follows:</p> <table border="1"> <thead> <tr> <th>Value</th> <th>Description</th> </tr> </thead> <tbody> <tr> <td>0x0</td> <td>Positive edge</td> </tr> <tr> <td>0x1</td> <td>Negative edge</td> </tr> <tr> <td>0x2</td> <td>Reserved</td> </tr> <tr> <td>0x3</td> <td>Both edges</td> </tr> </tbody> </table>	Value	Description	0x0	Positive edge	0x1	Negative edge	0x2	Reserved	0x3	Both edges
Value	Description													
0x0	Positive edge													
0x1	Negative edge													
0x2	Reserved													
0x3	Both edges													
1	TASTALL	R/W	0	<p>GPTM Timer A Stall Enable</p> <p>The <code>TASTALL</code> values are defined as follows:</p> <table border="1"> <thead> <tr> <th>Value</th> <th>Description</th> </tr> </thead> <tbody> <tr> <td>0</td> <td>Timer A continues counting while the processor is halted by the debugger.</td> </tr> <tr> <td>1</td> <td>Timer A freezes counting while the processor is halted by the debugger.</td> </tr> </tbody> </table> <p>If the processor is executing normally, the <code>TASTALL</code> bit is ignored.</p>	Value	Description	0	Timer A continues counting while the processor is halted by the debugger.	1	Timer A freezes counting while the processor is halted by the debugger.				
Value	Description													
0	Timer A continues counting while the processor is halted by the debugger.													
1	Timer A freezes counting while the processor is halted by the debugger.													
0	TAEN	R/W	0	<p>GPTM Timer A Enable</p> <p>The <code>TAEN</code> values are defined as follows:</p> <table border="1"> <thead> <tr> <th>Value</th> <th>Description</th> </tr> </thead> <tbody> <tr> <td>0</td> <td>Timer A is disabled.</td> </tr> <tr> <td>1</td> <td>Timer A is enabled and begins counting or the capture logic is enabled based on the <code>GPTMCFG</code> register.</td> </tr> </tbody> </table>	Value	Description	0	Timer A is disabled.	1	Timer A is enabled and begins counting or the capture logic is enabled based on the <code>GPTMCFG</code> register.				
Value	Description													
0	Timer A is disabled.													
1	Timer A is enabled and begins counting or the capture logic is enabled based on the <code>GPTMCFG</code> register.													

### Register 5: GPTM Interrupt Mask (GPTMIMR), offset 0x018

This register allows software to enable/disable GPTM controller-level interrupts. Setting a bit enables the corresponding interrupt, while clearing a bit disables it.

#### GPTM Interrupt Mask (GPTMIMR)

Timer0 base: 0x4003.0000  
 Timer1 base: 0x4003.1000  
 Timer2 base: 0x4003.2000  
 Timer3 base: 0x4003.3000  
 Offset 0x018  
 Type R/W, reset 0x0000.0000

	31	30	29	28	27	26	25	24	23	22	21	20	19	18	17	16	
	reserved																
Type	RO	RO	RO	RO	RO	RO	RO	RO	RO	RO	RO	RO	RO	RO	RO	RO	
Reset	0	0	0	0	0	0	0	0	0	0	0	0	0	0	0	0	
	15	14	13	12	11	10	9	8	7	6	5	4	3	2	1	0	
	reserved				TBMIM	CBEIM	CBMIM	TBTOIM	reserved				TAMIM	RTCIM	CAEIM	CAMIM	TATOIM
Type	RO	RO	RO	RO	R/W	R/W	R/W	R/W	RO	RO	RO	R/W	R/W	R/W	R/W	R/W	
Reset	0	0	0	0	0	0	0	0	0	0	0	0	0	0	0	0	

Bit/Field	Name	Type	Reset	Description
31:12	reserved	RO	0x0000.0	Software should not rely on the value of a reserved bit. To provide compatibility with future products, the value of a reserved bit should be preserved across a read-modify-write operation.
11	TBMIM	R/W	0	GPTM Timer B Mode Match Interrupt Mask The TBMIM values are defined as follows: Value Description 0 Interrupt is disabled. 1 Interrupt is enabled.
10	CBEIM	R/W	0	GPTM Capture B Event Interrupt Mask The CBEIM values are defined as follows: Value Description 0 Interrupt is disabled. 1 Interrupt is enabled.
9	CBMIM	R/W	0	GPTM Capture B Match Interrupt Mask The CBMIM values are defined as follows: Value Description 0 Interrupt is disabled. 1 Interrupt is enabled.

Bit/Field	Name	Type	Reset	Description
8	TBTOIM	R/W	0	GPTM Timer B Time-Out Interrupt Mask The TBTOIM values are defined as follows:  Value Description 0 Interrupt is disabled. 1 Interrupt is enabled.
7:5	reserved	RO	0x0	Software should not rely on the value of a reserved bit. To provide compatibility with future products, the value of a reserved bit should be preserved across a read-modify-write operation.
4	TAMIM	R/W	0	GPTM Timer A Mode Match Interrupt Mask The TAMIM values are defined as follows:  Value Description 0 Interrupt is disabled. 1 Interrupt is enabled.
3	RTCIM	R/W	0	GPTM RTC Interrupt Mask The RTCIM values are defined as follows:  Value Description 0 Interrupt is disabled. 1 Interrupt is enabled.
2	CAEIM	R/W	0	GPTM Capture A Event Interrupt Mask The CAEIM values are defined as follows:  Value Description 0 Interrupt is disabled. 1 Interrupt is enabled.
1	CAMIM	R/W	0	GPTM Capture A Match Interrupt Mask The CAMIM values are defined as follows:  Value Description 0 Interrupt is disabled. 1 Interrupt is enabled.
0	TATOIM	R/W	0	GPTM Timer A Time-Out Interrupt Mask The TATOIM values are defined as follows:  Value Description 0 Interrupt is disabled. 1 Interrupt is enabled.

## Register 6: GPTM Raw Interrupt Status (GPTMRIS), offset 0x01C

This register shows the state of the GPTM's internal interrupt signal. These bits are set whether or not the interrupt is masked in the **GPTMIMR** register. Each bit can be cleared by writing a 1 to its corresponding bit in **GPTMICR**.

### GPTM Raw Interrupt Status (GPTMRIS)

Timer0 base: 0x4003.0000  
 Timer1 base: 0x4003.1000  
 Timer2 base: 0x4003.2000  
 Timer3 base: 0x4003.3000  
 Offset 0x01C  
 Type RO, reset 0x0000.0000

	31	30	29	28	27	26	25	24	23	22	21	20	19	18	17	16	
	reserved																
Type	RO	RO	RO	RO	RO	RO	RO	RO	RO	RO	RO	RO	RO	RO	RO	RO	
Reset	0	0	0	0	0	0	0	0	0	0	0	0	0	0	0	0	
	15	14	13	12	11	10	9	8	7	6	5	4	3	2	1	0	
	reserved				TBMRIS	CBERIS	CBMRIS	TBTORIS	reserved				TAMRIS	RTCRIS	CAERIS	CAMRIS	TATORIS
Type	RO	RO	RO	RO	R/W	RO	RO	RO	RO	RO	RO	R/W	RO	RO	RO	RO	
Reset	0	0	0	0	0	0	0	0	0	0	0	0	0	0	0	0	

Bit/Field	Name	Type	Reset	Description
31:12	reserved	RO	0x0000.0	Software should not rely on the value of a reserved bit. To provide compatibility with future products, the value of a reserved bit should be preserved across a read-modify-write operation.
11	TBMRIS	R/W	0	GPTM Timer B Mode Match Raw Interrupt  Value Description 1 The <b>TBMIE</b> bit is set in the <b>GPTMTBMR</b> register, and the match value in the <b>GPTMTBMATCHR</b> register has been reached when in the one-shot and periodic modes. 0 The match value has not been reached.  This bit is cleared by writing a 1 to the <b>TBMCINT</b> bit in the <b>GPTMICR</b> register.
10	CBERIS	RO	0	GPTM Capture B Event Raw Interrupt  Value Description 1 The Capture B event has occurred. 0 The Capture B event has not occurred.  This bit is cleared by writing a 1 to the <b>CBECINT</b> bit in the <b>GPTMICR</b> register.
9	CBMRIS	RO	0	GPTM Capture B Match Raw Interrupt  Value Description 1 The Capture B match has occurred. 0 The Capture B match has not occurred.  This bit is cleared by writing a 1 to the <b>CBMCINT</b> bit in the <b>GPTMICR</b> register.

Bit/Field	Name	Type	Reset	Description
8	TBTORIS	RO	0	<p>GPTM Timer B Time-Out Raw Interrupt</p> <p>Value Description</p> <p>1 Timer B has timed out.</p> <p>0 Timer B has not timed out.</p> <p>This bit is cleared by writing a 1 to the TBTOCINT bit in the <b>GPTMICR</b> register.</p>
7:5	reserved	RO	0x0	Software should not rely on the value of a reserved bit. To provide compatibility with future products, the value of a reserved bit should be preserved across a read-modify-write operation.
4	TAMRIS	R/W	0	<p>GPTM Timer A Mode Match Raw Interrupt</p> <p>Value Description</p> <p>1 The TAMIE bit is set in the <b>GPTMTAMR</b> register, and the match value in the <b>GPTMTAMATCHR</b> register has been reached when in the one-shot and periodic modes.</p> <p>0 The match value has not been reached.</p> <p>This bit is cleared by writing a 1 to the TAMCINT bit in the <b>GPTMICR</b> register.</p>
3	RTCRIS	RO	0	<p>GPTM RTC Raw Interrupt</p> <p>Value Description</p> <p>1 The RTC event has occurred.</p> <p>0 The RTC event has not occurred.</p> <p>This bit is cleared by writing a 1 to the RTCCINT bit in the <b>GPTMICR</b> register.</p>
2	CAERIS	RO	0	<p>GPTM Capture A Event Raw Interrupt</p> <p>Value Description</p> <p>1 The Capture A event has occurred.</p> <p>0 The Capture A event has not occurred.</p> <p>This bit is cleared by writing a 1 to the CAECINT bit in the <b>GPTMICR</b> register.</p>
1	CAMRIS	RO	0	<p>GPTM Capture A Match Raw Interrupt</p> <p>Value Description</p> <p>1 The Capture A match has occurred.</p> <p>0 The Capture A match has not occurred.</p> <p>This bit is cleared by writing a 1 to the CAMCINT bit in the <b>GPTMICR</b> register.</p>

Bit/Field	Name	Type	Reset	Description
0	TATORIS	RO	0	GPTM Timer A Time-Out Raw Interrupt
				Value Description
				1 Timer A has timed out.
				0 Timer A has not timed out.
				This bit is cleared by writing a 1 to the TATOCINT bit in the <b>GPTMICR</b> register.

## Register 7: GPTM Masked Interrupt Status (GPTMMIS), offset 0x020

This register show the state of the GPTM's controller-level interrupt. If an interrupt is unmasked in **GPTMIMR**, and there is an event that causes the interrupt to be asserted, the corresponding bit is set in this register. All bits are cleared by writing a 1 to the corresponding bit in **GPTMICR**.

### GPTM Masked Interrupt Status (GPTMMIS)

Timer0 base: 0x4003.0000  
 Timer1 base: 0x4003.1000  
 Timer2 base: 0x4003.2000  
 Timer3 base: 0x4003.3000  
 Offset 0x020  
 Type RO, reset 0x0000.0000

	31	30	29	28	27	26	25	24	23	22	21	20	19	18	17	16	
	reserved																
Type	RO	RO	RO	RO	RO	RO	RO	RO	RO	RO	RO	RO	RO	RO	RO	RO	
Reset	0	0	0	0	0	0	0	0	0	0	0	0	0	0	0	0	
	15	14	13	12	11	10	9	8	7	6	5	4	3	2	1	0	
	reserved				TBMMIS	CBEMIS	CBMMIS	TBTOMIS	reserved				TAMMIS	RTCMIS	CAEMIS	CAMMIS	TATOMIS
Type	RO	RO	RO	RO	R/W	RO	RO	RO	RO	RO	RO	R/W	RO	RO	RO	RO	
Reset	0	0	0	0	0	0	0	0	0	0	0	0	0	0	0	0	

Bit/Field	Name	Type	Reset	Description
31:12	reserved	RO	0x0000.0	Software should not rely on the value of a reserved bit. To provide compatibility with future products, the value of a reserved bit should be preserved across a read-modify-write operation.
11	TBMMIS	R/W	0	GPTM Timer B Mode Match Masked Interrupt  Value Description 1 An unmasked Timer B Mode Match interrupt has occurred. 0 A Timer B Mode Match interrupt has not occurred or is masked.  This bit is cleared by writing a 1 to the <code>TBMCINT</code> bit in the <b>GPTMICR</b> register.
10	CBEMIS	RO	0	GPTM Capture B Event Masked Interrupt  Value Description 1 An unmasked Capture B event interrupt has occurred. 0 A Capture B event interrupt has not occurred or is masked.  This bit is cleared by writing a 1 to the <code>CBECINT</code> bit in the <b>GPTMICR</b> register.

Bit/Field	Name	Type	Reset	Description
9	CBMMIS	RO	0	<p>GPTM Capture B Match Masked Interrupt</p> <p>Value Description</p> <p>1 An unmasked Capture B Match interrupt has occurred.</p> <p>0 A Capture B Mode Match interrupt has not occurred or is masked.</p> <p>This bit is cleared by writing a 1 to the CBMCINT bit in the <b>GPTMICR</b> register.</p>
8	TBTOMIS	RO	0	<p>GPTM Timer B Time-Out Masked Interrupt</p> <p>Value Description</p> <p>1 An unmasked Timer B Time-Out interrupt has occurred.</p> <p>0 A Timer B Time-Out interrupt has not occurred or is masked.</p> <p>This bit is cleared by writing a 1 to the TBTOCINT bit in the <b>GPTMICR</b> register.</p>
7:5	reserved	RO	0x0	Software should not rely on the value of a reserved bit. To provide compatibility with future products, the value of a reserved bit should be preserved across a read-modify-write operation.
4	TAMMIS	R/W	0	<p>GPTM Timer A Mode Match Masked Interrupt</p> <p>Value Description</p> <p>1 An unmasked Timer A Mode Match interrupt has occurred.</p> <p>0 A Timer A Mode Match interrupt has not occurred or is masked.</p> <p>This bit is cleared by writing a 1 to the TAMCINT bit in the <b>GPTMICR</b> register.</p>
3	RTCMIS	RO	0	<p>GPTM RTC Masked Interrupt</p> <p>Value Description</p> <p>1 An unmasked RTC event interrupt has occurred.</p> <p>0 An RTC event interrupt has not occurred or is masked.</p> <p>This bit is cleared by writing a 1 to the RTCCINT bit in the <b>GPTMICR</b> register.</p>
2	CAEMIS	RO	0	<p>GPTM Capture A Event Masked Interrupt</p> <p>Value Description</p> <p>1 An unmasked Capture A event interrupt has occurred.</p> <p>0 A Capture A event interrupt has not occurred or is masked.</p> <p>This bit is cleared by writing a 1 to the CAECINT bit in the <b>GPTMICR</b> register.</p>



Bit/Field	Name	Type	Reset	Description
1	CAMMIS	RO	0	<p>GPTM Capture A Match Masked Interrupt</p> <p>Value Description</p> <p>1 An unmasked Capture A Match interrupt has occurred.</p> <p>0 A Capture A Mode Match interrupt has not occurred or is masked.</p> <p>This bit is cleared by writing a 1 to the CAMCINT bit in the <b>GPTMICR</b> register.</p>
0	TATOMIS	RO	0	<p>GPTM Timer A Time-Out Masked Interrupt</p> <p>Value Description</p> <p>1 An unmasked Timer A Time-Out interrupt has occurred.</p> <p>0 A Timer A Time-Out interrupt has not occurred or is masked.</p> <p>This bit is cleared by writing a 1 to the TATOCINT bit in the <b>GPTMICR</b> register.</p>

## Register 8: GPTM Interrupt Clear (GPTMICR), offset 0x024

This register is used to clear the status bits in the **GPTMRIS** and **GPTMMIS** registers. Writing a 1 to a bit clears the corresponding bit in the **GPTMRIS** and **GPTMMIS** registers.

### GPTM Interrupt Clear (GPTMICR)

Timer0 base: 0x4003.0000  
 Timer1 base: 0x4003.1000  
 Timer2 base: 0x4003.2000  
 Timer3 base: 0x4003.3000  
 Offset 0x024  
 Type W1C, reset 0x0000.0000

	31	30	29	28	27	26	25	24	23	22	21	20	19	18	17	16
	reserved															
Type	RO	RO	RO	RO	RO	RO	RO	RO	RO	RO	RO	RO	RO	RO	RO	RO
Reset	0	0	0	0	0	0	0	0	0	0	0	0	0	0	0	0
	15	14	13	12	11	10	9	8	7	6	5	4	3	2	1	0
	reserved				TBMCINT	CBECINT	CBMCINT	TBTOCINT	reserved			TAMCINT	RTCCINT	CAECINT	CAMCINT	TATOCINT
Type	RO	RO	RO	RO	W1C	W1C	W1C	W1C	RO	RO	RO	W1C	W1C	W1C	W1C	W1C
Reset	0	0	0	0	0	0	0	0	0	0	0	0	0	0	0	0

Bit/Field	Name	Type	Reset	Description
31:12	reserved	RO	0x0000.0	Software should not rely on the value of a reserved bit. To provide compatibility with future products, the value of a reserved bit should be preserved across a read-modify-write operation.
11	TBMCINT	W1C	0	GPTM Timer B Mode Match Interrupt Clear  Writing a 1 to this bit clears the <b>TBMRIS</b> bit in the <b>GPTMRIS</b> register and the <b>TBMMIS</b> bit in the <b>GPTMMIS</b> register.
10	CBECINT	W1C	0	GPTM Capture B Event Interrupt Clear  Writing a 1 to this bit clears the <b>CBERIS</b> bit in the <b>GPTMRIS</b> register and the <b>CBEMIS</b> bit in the <b>GPTMMIS</b> register.
9	CBMCINT	W1C	0	GPTM Capture B Match Interrupt Clear  Writing a 1 to this bit clears the <b>CBMRIS</b> bit in the <b>GPTMRIS</b> register and the <b>CBMMIS</b> bit in the <b>GPTMMIS</b> register.
8	TBTOCINT	W1C	0	GPTM Timer B Time-Out Interrupt Clear  Writing a 1 to this bit clears the <b>TBTORIS</b> bit in the <b>GPTMRIS</b> register and the <b>TBTOMIS</b> bit in the <b>GPTMMIS</b> register.
7:5	reserved	RO	0x0	Software should not rely on the value of a reserved bit. To provide compatibility with future products, the value of a reserved bit should be preserved across a read-modify-write operation.
4	TAMCINT	W1C	0	GPTM Timer A Mode Match Interrupt Clear  Writing a 1 to this bit clears the <b>TAMRIS</b> bit in the <b>GPTMRIS</b> register and the <b>TAMMIS</b> bit in the <b>GPTMMIS</b> register.
3	RTCCINT	W1C	0	GPTM RTC Interrupt Clear  Writing a 1 to this bit clears the <b>RTC RIS</b> bit in the <b>GPTMRIS</b> register and the <b>RTCMIS</b> bit in the <b>GPTMMIS</b> register.

---

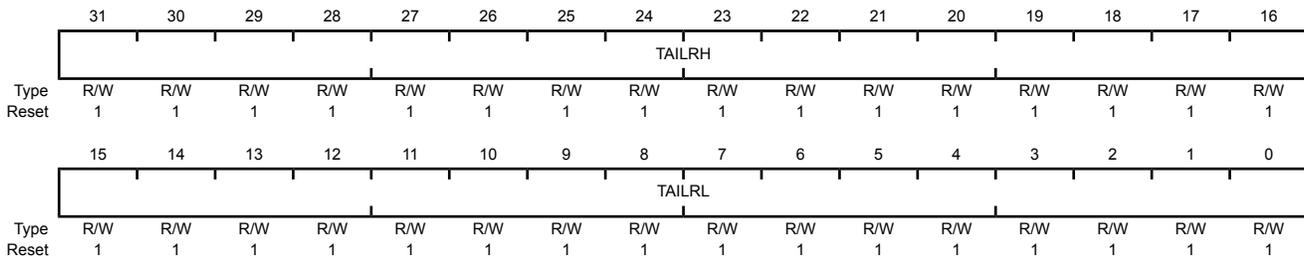
Bit/Field	Name	Type	Reset	Description
2	CAECINT	W1C	0	GPTM Capture A Event Interrupt Clear Writing a 1 to this bit clears the CAERIS bit in the <b>GPTMRIS</b> register and the CAEMIS bit in the <b>GPTMMIS</b> register.
1	CAMCINT	W1C	0	GPTM Capture A Match Interrupt Clear Writing a 1 to this bit clears the CAMRIS bit in the <b>GPTMRIS</b> register and the CAMMIS bit in the <b>GPTMMIS</b> register.
0	TATOCINT	W1C	0	GPTM Timer A Time-Out Raw Interrupt Writing a 1 to this bit clears the TATORIS bit in the <b>GPTMRIS</b> register and the TATOMIS bit in the <b>GPTMMIS</b> register.

### Register 9: GPTM Timer A Interval Load (GPTMTAILR), offset 0x028

When the timer is counting down, this register is used to load the starting count value into the timer. When the timer is counting up, this register sets the upper bound for When GPTM is configured to one of the 32-bit modes, **GPTMTAILR** appears as a 32-bit register (the upper 16-bits correspond to the contents of the **GPTM Timer B Interval Load (GPTMTBILR)** register). In 16-bit mode, the upper 16 bits of this register read as 0s and have no effect on the state of **GPTMTBILR**.

#### GPTM Timer A Interval Load (GPTMTAILR)

Timer0 base: 0x4003.0000  
 Timer1 base: 0x4003.1000  
 Timer2 base: 0x4003.2000  
 Timer3 base: 0x4003.3000  
 Offset 0x028  
 Type R/W, reset 0xFFFF.FFFF



Bit/Field	Name	Type	Reset	Description
31:16	TAILRH	R/W	0xFFFF	GPTM Timer A Interval Load Register High  When configured for 32-bit mode via the <b>GPTMCFG</b> register, the <b>GPTM Timer B Interval Load (GPTMTBILR)</b> register loads this value on a write. A read returns the current value of <b>GPTMTBILR</b> .  In 16-bit mode, this field reads as 0 and does not have an effect on the state of <b>GPTMTBILR</b> .
15:0	TAILRL	R/W	0xFFFF	GPTM Timer A Interval Load Register Low  For both 16- and 32-bit modes, writing this field loads the counter for Timer A. A read returns the current value of <b>GPTMTAILR</b> .

**Register 10: GPTM Timer B Interval Load (GPTMTBILR), offset 0x02C**

This register is used to load the starting count value into Timer B. When the GPTM is configured to a 32-bit mode, **GPTMTBILR** returns the current value of Timer B and ignores writes.

**GPTM Timer B Interval Load (GPTMTBILR)**

Timer0 base: 0x4003.0000  
 Timer1 base: 0x4003.1000  
 Timer2 base: 0x4003.2000  
 Timer3 base: 0x4003.3000  
 Offset 0x02C  
 Type R/W, reset 0x0000.FFFF

	31	30	29	28	27	26	25	24	23	22	21	20	19	18	17	16
	reserved															
Type	RO	RO	RO	RO	RO	RO	RO	RO	RO	RO	RO	RO	RO	RO	RO	RO
Reset	0	0	0	0	0	0	0	0	0	0	0	0	0	0	0	0
	15	14	13	12	11	10	9	8	7	6	5	4	3	2	1	0
	TBILRL															
Type	R/W	R/W	R/W	R/W	R/W	R/W	R/W	R/W	R/W	R/W	R/W	R/W	R/W	R/W	R/W	R/W
Reset	1	1	1	1	1	1	1	1	1	1	1	1	1	1	1	1

Bit/Field	Name	Type	Reset	Description
31:16	reserved	RO	0x0000	Software should not rely on the value of a reserved bit. To provide compatibility with future products, the value of a reserved bit should be preserved across a read-modify-write operation.
15:0	TBILRL	R/W	0xFFFF	GPTM Timer B Interval Load Register

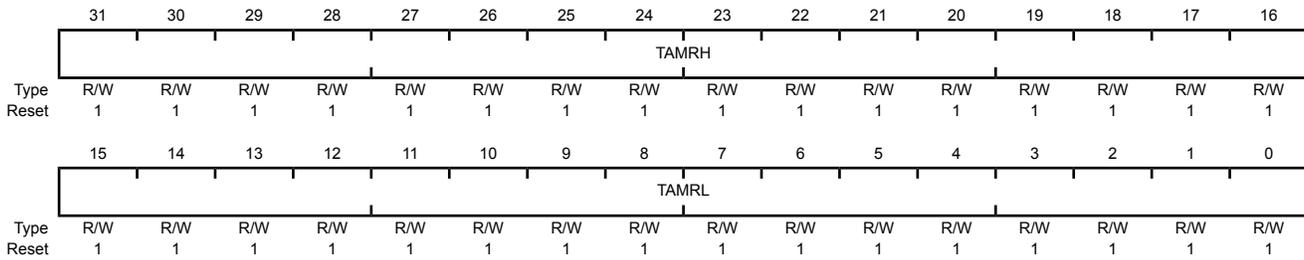
When the GPTM is not configured as a 32-bit timer, a write to this field updates **GPTMTBILR**. In 32-bit mode, writes are ignored, and reads return the current value of **GPTMTBILR**.

### Register 11: GPTM Timer A Match (GPTMTAMATCHR), offset 0x030

This register is loaded with a match value. Interrupts can be generated when the timer value is equal to the value in this register in one-shot or periodic mode. In Edge-Count mode, this register along with **GPTMTAILR**, determines how many edge events are counted. The total number of edge events counted is equal to the value in **GPTMTAILR** minus this value.

#### GPTM Timer A Match (GPTMTAMATCHR)

Timer0 base: 0x4003.0000  
 Timer1 base: 0x4003.1000  
 Timer2 base: 0x4003.2000  
 Timer3 base: 0x4003.3000  
 Offset 0x030  
 Type R/W, reset 0xFFFF.FFFF



Bit/Field	Name	Type	Reset	Description
31:16	TAMRH	R/W	0xFFFF	<p>GPTM Timer A Match Register High</p> <p>When the timer is configured for 32-bit mode via the <b>GPTMCFG</b> register, this value is compared to the upper half of <b>GPTMTAR</b> to determine match events.</p> <p>In 16-bit mode, this field reads as 0 and does not have an effect on the state of <b>GPTMTBMATCHR</b>.</p>
15:0	TAMRL	R/W	0xFFFF	<p>GPTM Timer A Match Register Low</p> <p>When the timer is configured for 32-bit mode via the <b>GPTMCFG</b> register, this value is compared to the lower half of <b>GPTMTAR</b>, to determine match events.</p> <p>When the timer is configured for 16-bit mode via the <b>GPTMCFG</b> register, this value is compared to <b>GPTMTAR</b> to determine match events.</p> <p>When configured for Edge-Count mode, this value along with <b>GPTMTAILR</b>, determines how many edge events are counted. The total number of edge events counted is equal to the value in <b>GPTMTAILR</b> minus this value.</p> <p>When configured for PWM mode, this value along with <b>GPTMTAILR</b>, determines the duty cycle of the output PWM signal.</p>

## Register 12: GPTM Timer B Match (GPTMTBMATCHR), offset 0x034

This register is loaded with a match value. Interrupts can be generated when the timer value is equal to the value in this register in one-shot or periodic mode. In Edge-Count mode, this register along with **GPTMTAILR**, determines how many edge events are counted. The total number of edge events counted is equal to the value in **GPTMTAILR** minus this value.

### GPTM Timer B Match (GPTMTBMATCHR)

Timer0 base: 0x4003.0000  
 Timer1 base: 0x4003.1000  
 Timer2 base: 0x4003.2000  
 Timer3 base: 0x4003.3000  
 Offset 0x034  
 Type R/W, reset 0x0000.FFFF

	31	30	29	28	27	26	25	24	23	22	21	20	19	18	17	16
	reserved															
Type	RO	RO	RO	RO	RO	RO	RO	RO	RO	RO	RO	RO	RO	RO	RO	RO
Reset	0	0	0	0	0	0	0	0	0	0	0	0	0	0	0	0
	15	14	13	12	11	10	9	8	7	6	5	4	3	2	1	0
	TBMRL															
Type	R/W	R/W	R/W	R/W	R/W	R/W	R/W	R/W	R/W	R/W	R/W	R/W	R/W	R/W	R/W	R/W
Reset	1	1	1	1	1	1	1	1	1	1	1	1	1	1	1	1

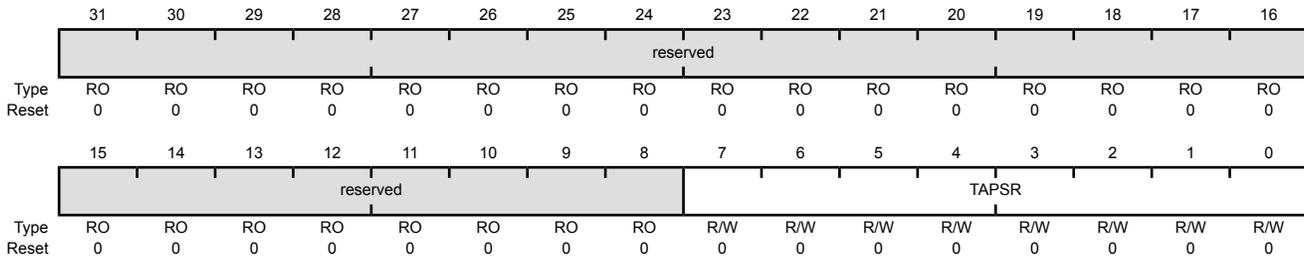
Bit/Field	Name	Type	Reset	Description
31:16	reserved	RO	0x0000	Software should not rely on the value of a reserved bit. To provide compatibility with future products, the value of a reserved bit should be preserved across a read-modify-write operation.
15:0	TBMRL	R/W	0xFFFF	GPTM Timer B Match Register Low  When the timer is configured for 16-bit mode via the <b>GPTMCFG</b> register, this value is compared to <b>GPTMTBR</b> to determine match events.  When configured for Edge-Count mode, this value along with <b>GPTMTBILR</b> , determines how many edge events are counted. The total number of edge events counted is equal to the value in <b>GPTMTBILR</b> minus this value.  When configured for PWM mode, this value along with <b>GPTMTBILR</b> , determines the duty cycle of the output PWM signal.

### Register 13: GPTM Timer A Prescale (GPTMTAPR), offset 0x038

This register allows software to extend the range of the 16-bit timers in periodic and one-shot modes. In Edge-Count mode, this register is the MSB of the 24-bit count value.

#### GPTM Timer A Prescale (GPTMTAPR)

Timer0 base: 0x4003.0000  
 Timer1 base: 0x4003.1000  
 Timer2 base: 0x4003.2000  
 Timer3 base: 0x4003.3000  
 Offset 0x038  
 Type R/W, reset 0x0000.0000



Bit/Field	Name	Type	Reset	Description
31:8	reserved	RO	0x0000.00	Software should not rely on the value of a reserved bit. To provide compatibility with future products, the value of a reserved bit should be preserved across a read-modify-write operation.
7:0	TAPSR	R/W	0x00	GPTM Timer A Prescale  The register loads this value on a write. A read returns the current value of the register.  Refer to Table 11-4 on page 440 for more details and an example.



**Register 14: GPTM Timer B Prescale (GPTMTBPR), offset 0x03C**

This register allows software to extend the range of the 16-bit timers in periodic and one-shot modes. In Edge-Count mode, this register is the MSB of the 24-bit count value.

**GPTM Timer B Prescale (GPTMTBPR)**

Timer0 base: 0x4003.0000  
 Timer1 base: 0x4003.1000  
 Timer2 base: 0x4003.2000  
 Timer3 base: 0x4003.3000  
 Offset 0x03C  
 Type R/W, reset 0x0000.0000

	31	30	29	28	27	26	25	24	23	22	21	20	19	18	17	16
	reserved															
Type	RO	RO	RO	RO	RO	RO	RO	RO	RO	RO	RO	RO	RO	RO	RO	RO
Reset	0	0	0	0	0	0	0	0	0	0	0	0	0	0	0	0
	15	14	13	12	11	10	9	8	7	6	5	4	3	2	1	0
	reserved								TBPSR							
Type	RO	RO	RO	RO	RO	RO	RO	RO	R/W	R/W	R/W	R/W	R/W	R/W	R/W	R/W
Reset	0	0	0	0	0	0	0	0	0	0	0	0	0	0	0	0

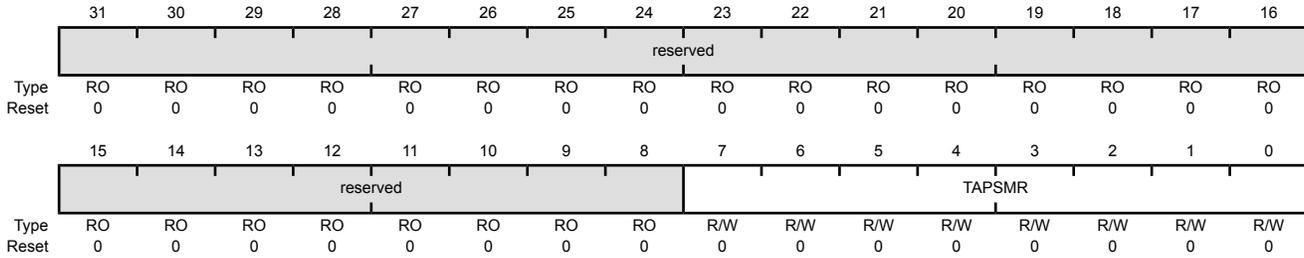
Bit/Field	Name	Type	Reset	Description
31:8	reserved	RO	0x0000.00	Software should not rely on the value of a reserved bit. To provide compatibility with future products, the value of a reserved bit should be preserved across a read-modify-write operation.
7:0	TBPSR	R/W	0x00	GPTM Timer B Prescale  The register loads this value on a write. A read returns the current value of this register.  Refer to Table 11-4 on page 440 for more details and an example.

### Register 15: GPTM TimerA Prescale Match (GPTMTAPMR), offset 0x040

This register effectively extends the range of **GPTMTAMATCHR** to 24 bits when operating in 16-bit one-shot or periodic mode.

#### GPTM TimerA Prescale Match (GPTMTAPMR)

Timer0 base: 0x4003.0000  
 Timer1 base: 0x4003.1000  
 Timer2 base: 0x4003.2000  
 Timer3 base: 0x4003.3000  
 Offset 0x040  
 Type R/W, reset 0x0000.0000



Bit/Field	Name	Type	Reset	Description
31:8	reserved	RO	0x00	Software should not rely on the value of a reserved bit. To provide compatibility with future products, the value of a reserved bit should be preserved across a read-modify-write operation.
7:0	TAPSMR	R/W	0x00	GPTM TimerA Prescale Match  This value is used alongside <b>GPTMTAMATCHR</b> to detect timer match events while using a prescaler.

**Register 16: GPTM TimerB Prescale Match (GPTMTBPMR), offset 0x044**

This register effectively extends the range of **GPTMTBMATCHR** to 24 bits when operating in 16-bit one-shot or periodic mode.

## GPTM TimerB Prescale Match (GPTMTBPMR)

Timer0 base: 0x4003.0000  
 Timer1 base: 0x4003.1000  
 Timer2 base: 0x4003.2000  
 Timer3 base: 0x4003.3000  
 Offset 0x044  
 Type R/W, reset 0x0000.0000

	31	30	29	28	27	26	25	24	23	22	21	20	19	18	17	16
	reserved															
Type	RO	RO	RO	RO	RO	RO	RO	RO	RO	RO	RO	RO	RO	RO	RO	RO
Reset	0	0	0	0	0	0	0	0	0	0	0	0	0	0	0	0
	15	14	13	12	11	10	9	8	7	6	5	4	3	2	1	0
	reserved								TBPSMR							
Type	RO	RO	RO	RO	RO	RO	RO	RO	R/W	R/W	R/W	R/W	R/W	R/W	R/W	R/W
Reset	0	0	0	0	0	0	0	0	0	0	0	0	0	0	0	0

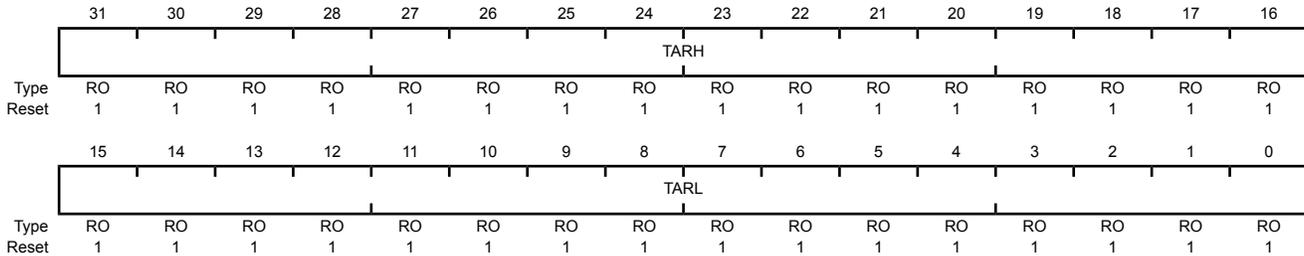
Bit/Field	Name	Type	Reset	Description
31:8	reserved	RO	0x00	Software should not rely on the value of a reserved bit. To provide compatibility with future products, the value of a reserved bit should be preserved across a read-modify-write operation.
7:0	TBPSMR	R/W	0x00	GPTM TimerB Prescale Match  This value is used alongside <b>GPTMTBMATCHR</b> to detect timer match events while using a prescaler.

### Register 17: GPTM Timer A (GPTMTAR), offset 0x048

This register shows the current value of the Timer A counter in all cases except for Input Edge-Count mode. When in this mode, this register contains the time at which the last edge event took place. Also in Input Edge-Count mode, bits 23:16 contain the upper 8 bits of the count.

#### GPTM Timer A (GPTMTAR)

Timer0 base: 0x4003.0000  
 Timer1 base: 0x4003.1000  
 Timer2 base: 0x4003.2000  
 Timer3 base: 0x4003.3000  
 Offset 0x048  
 Type RO, reset 0xFFFF.FFFF



Bit/Field	Name	Type	Reset	Description
31:16	TARH	RO	0xFFFF	GPTM Timer A Register High  If the <b>GPTMCFG</b> is in a 32-bit mode, Timer B value is read. If the <b>GPTMCFG</b> is in a 16-bit mode, this is read as zero.
15:0	TARL	RO	0xFFFF	GPTM Timer A Register Low  A read returns the current value of the <b>GPTM Timer A Count Register</b> , except in Input Edge-Count mode, when it returns the timestamp from the last edge event.

## Register 18: GPTM Timer B (GPTMTBR), offset 0x04C

This register shows the current value of the Timer B counter in all cases except for Input Edge-Count mode. When in this mode, this register contains the time at which the last edge event took place. Also in Input Edge-Count mode, bits 23:16 contain the upper 8 bits of the count.

### Input Edge-Count Mode

#### GPTM Timer B (GPTMTBR)

Timer0 base: 0x4003.0000  
 Timer1 base: 0x4003.1000  
 Timer2 base: 0x4003.2000  
 Timer3 base: 0x4003.3000  
 Offset 0x04C  
 Type RO, reset 0x0000.FFFF

	31	30	29	28	27	26	25	24	23	22	21	20	19	18	17	16
	reserved								TBRL							
Type	RO	RO	RO	RO	RO	RO	RO	RO	RO	RO	RO	RO	RO	RO	RO	RO
Reset	0	0	0	0	0	0	0	0	1	1	1	1	1	1	1	1
	15	14	13	12	11	10	9	8	7	6	5	4	3	2	1	0
	TBRL															
Type	RO	RO	RO	RO	RO	RO	RO	RO	RO	RO	RO	RO	RO	RO	RO	RO
Reset	1	1	1	1	1	1	1	1	1	1	1	1	1	1	1	1

Bit/Field	Name	Type	Reset	Description
31:24	reserved	RO	0x00	Software should not rely on the value of a reserved bit. To provide compatibility with future products, the value of a reserved bit should be preserved across a read-modify-write operation.
23:0	TBRL	RO	0xFF.FFFF	GPTM Timer B

A read returns the current value of the **GPTM Timer B Count Register**, except in Input Edge-Count mode, when it returns the timestamp from the last edge event.

### All Modes Except Input Edge-Count Mode

#### GPTM Timer B (GPTMTBR)

Timer0 base: 0x4003.0000  
 Timer1 base: 0x4003.1000  
 Timer2 base: 0x4003.2000  
 Timer3 base: 0x4003.3000  
 Offset 0x04C  
 Type RO, reset 0x0000.FFFF

	31	30	29	28	27	26	25	24	23	22	21	20	19	18	17	16
	reserved															
Type	RO	RO	RO	RO	RO	RO	RO	RO	RO	RO	RO	RO	RO	RO	RO	RO
Reset	0	0	0	0	0	0	0	0	0	0	0	0	0	0	0	0
	15	14	13	12	11	10	9	8	7	6	5	4	3	2	1	0
	TBRL															
Type	RO	RO	RO	RO	RO	RO	RO	RO	RO	RO	RO	RO	RO	RO	RO	RO
Reset	1	1	1	1	1	1	1	1	1	1	1	1	1	1	1	1

Bit/Field	Name	Type	Reset	Description
31:16	reserved	RO	0x0000	Software should not rely on the value of a reserved bit. To provide compatibility with future products, the value of a reserved bit should be preserved across a read-modify-write operation.
15:0	TBRL	RO	0xFFFF	GPTM Timer B  A read returns the current value of the <b>GPTM Timer B Count Register</b> , except in Input Edge-Count mode, when it returns the timestamp from the last edge event.

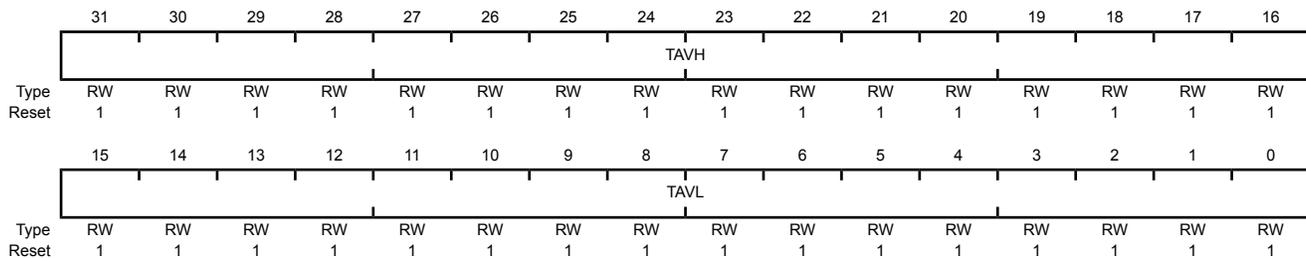
## Register 19: GPTM Timer A Value (GPTMTAV), offset 0x050

When read, this register shows the current, free-running value of Timer A in all modes. Software can use this value to determine the time elapsed between an interrupt and the ISR entry. When written, the value written into this register is loaded into the **GPTMAR** register on the next clock cycle. In Input Edge-Count mode, bits 23:16 contain the upper 8 bits of the count.

**Note:** The GPTMTAV register cannot be written in Edge-Count mode.

### GPTM Timer A Value (GPTMTAV)

Timer0 base: 0x4003.0000  
 Timer1 base: 0x4003.1000  
 Timer2 base: 0x4003.2000  
 Timer3 base: 0x4003.3000  
 Offset 0x050  
 Type RW, reset 0xFFFF.FFFF



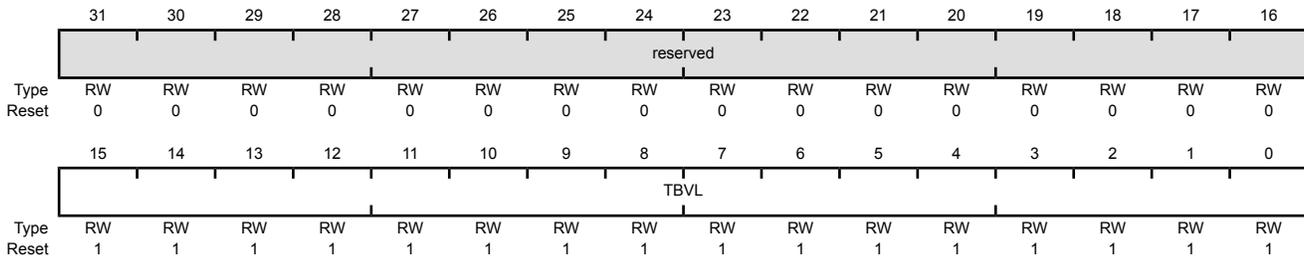
Bit/Field	Name	Type	Reset	Description
31:16	TAVH	RW	0xFFFF	GPTM Timer A Value High  When configured for 32-bit mode via the <b>GPTMCFG</b> register, the <b>GPTM Timer B Value (GPTMTBV)</b> register loads this value on a write. A read returns the current value of <b>GPTMTBR</b> .  In 16-bit mode, this field reads as 0 and does not have an effect on the state of <b>GPTMTBR</b> .
15:0	TAVL	RW	0xFFFF	GPTM Timer A Register Low  For both 16- and 32-bit modes, writing this field loads the counter for Timer A. A read returns the current value of <b>GPTMTAR</b> .

### Register 20: GPTM Timer B Value (GPTMTBV), offset 0x054

When read, this register shows the current, free-running value of Timer B in all modes. Software can use this value to determine the time elapsed between an interrupt and the ISR entry. When written, the value written into this register is loaded into the **GPTMBR** register on the next clock cycle. In Input Edge-Count mode, bits 23:16 contain the upper 8 bits of the count.

#### GPTM Timer B Value (GPTMTBV)

Timer0 base: 0x4003.0000  
 Timer1 base: 0x4003.1000  
 Timer2 base: 0x4003.2000  
 Timer3 base: 0x4003.3000  
 Offset 0x054  
 Type RW, reset 0x0000.FFFF



Bit/Field	Name	Type	Reset	Description
31:16	reserved	RW	0x0000	Software should not rely on the value of a reserved bit. To provide compatibility with future products, the value of a reserved bit should be preserved across a read-modify-write operation.
15:0	TBVL	RW	0xFFFF	GPTM Timer B Register  For 16-bit mode, writing this field loads the counter for Timer B. A read returns the current value of <b>GPTMTBR</b> .  In 32-bit mode, writing this field loads the upper 16 bits of the <b>GPTMAR</b> , and reads return the current value of the upper 16 bits of <b>GPTMTAR</b> .



## 12 Watchdog Timers

A watchdog timer can generate a nonmaskable interrupt (NMI) or a reset when a time-out value is reached. The watchdog timer is used to regain control when a system has failed due to a software error or due to the failure of an external device to respond in the expected way. The LM3S9B96 microcontroller has two Watchdog Timer Modules, one module is clocked by the system clock (Watchdog Timer 0) and the other is clocked by the PIOSC (Watchdog Timer 1). The two modules are identical except that WDT1 is in a different clock domain, and therefore requires synchronizers. As a result, WDT1 has a bit defined in the **Watchdog Timer Control (WDTCTL)** register to indicate when a write to a WDT1 register is complete. Software can use this bit to ensure that the previous access has completed before starting the next access.

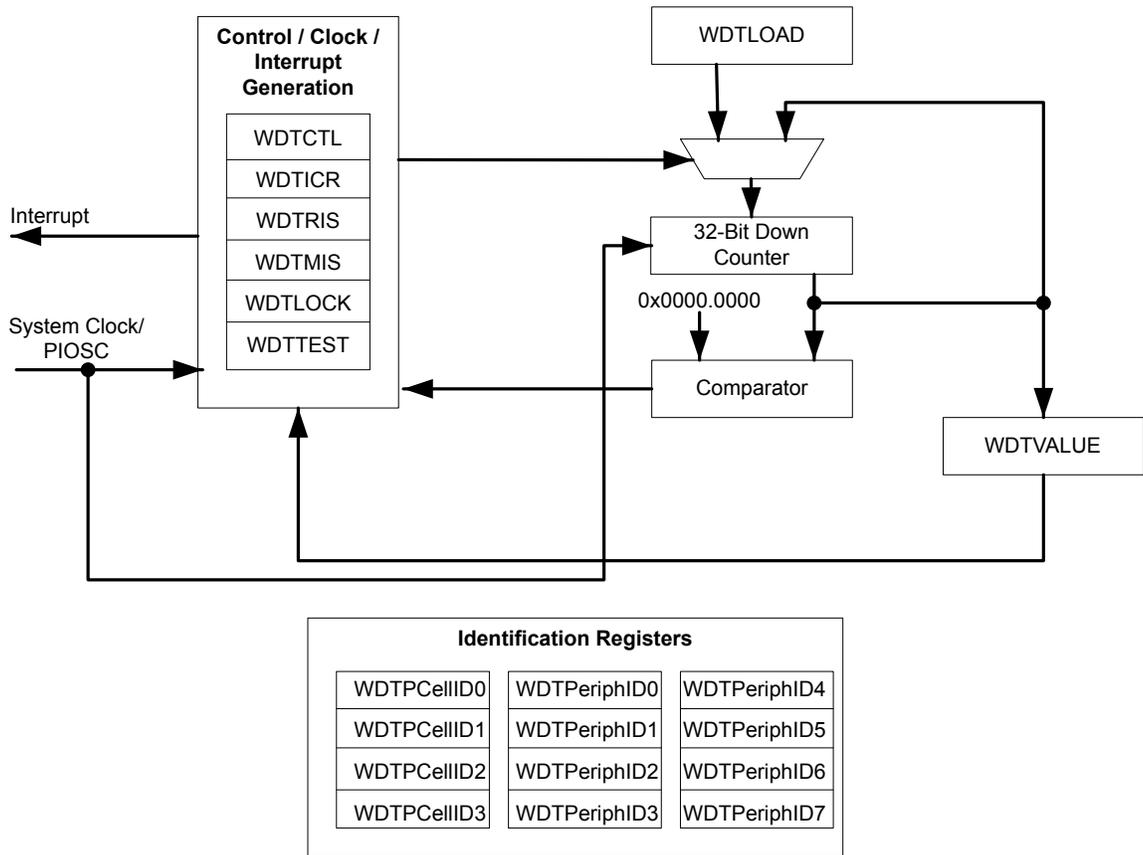
The Stellaris® LM3S9B96 controller has two Watchdog Timer modules with the following features:

- 32-bit down counter with a programmable load register
- Separate watchdog clock with an enable
- Programmable interrupt generation logic with interrupt masking
- Lock register protection from runaway software
- Reset generation logic with an enable/disable
- User-enabled stalling when the microcontroller asserts the CPU Halt flag during debug

The Watchdog Timer can be configured to generate an interrupt to the controller on its first time-out, and to generate a reset signal on its second time-out. Once the Watchdog Timer has been configured, the lock register can be written to prevent the timer configuration from being inadvertently altered.

## 12.1 Block Diagram

Figure 12-1. WDT Module Block Diagram



## 12.2 Functional Description

The Watchdog Timer module generates the first time-out signal when the 32-bit counter reaches the zero state after being enabled; enabling the counter also enables the watchdog timer interrupt. After the first time-out event, the 32-bit counter is re-loaded with the value of the **Watchdog Timer Load (WDTLOAD)** register, and the timer resumes counting down from that value. Once the Watchdog Timer has been configured, the **Watchdog Timer Lock (WDTLOCK)** register is written, which prevents the timer configuration from being inadvertently altered by software.

If the timer counts down to its zero state again before the first time-out interrupt is cleared, and the reset signal has been enabled by setting the `RESEN` bit in the **WDTCTL** register, the Watchdog timer asserts its reset signal to the system. If the interrupt is cleared before the 32-bit counter reaches its second time-out, the 32-bit counter is loaded with the value in the **WDTLOAD** register, and counting resumes from that value.

If **WDTLOAD** is written with a new value while the Watchdog Timer counter is counting, then the counter is loaded with the new value and continues counting.

Writing to **WDTLOAD** does not clear an active interrupt. An interrupt must be specifically cleared by writing to the **Watchdog Interrupt Clear (WDTICR)** register.

The Watchdog module interrupt and reset generation can be enabled or disabled as required. When the interrupt is re-enabled, the 32-bit counter is preloaded with the load register value and not its last state.

### 12.2.1 Register Access Timing

Because the Watchdog Timer 1 module has an independent clocking domain, its registers must be written with a timing gap between accesses. Software must guarantee that this delay is inserted between back-to-back writes to WDT1 registers or between a write followed by a read to the registers. The timing for back-to-back reads from the WDT1 module has no restrictions. The **WRC** bit in the **Watchdog Control (WDTCTL)** register for WDT1 indicates that the required timing gap has elapsed. This bit is cleared on a write operation and set once the write completes, indicating to software that another write or read may be started safely. Software should poll **WDTCTL** for **WRC=1** prior to accessing another register. Note that WDT0 does not have this restriction as it runs off the system clock.

## 12.3 Initialization and Configuration

To use the WDT, its peripheral clock must be enabled by setting the **WDT** bit in the **RCGC0** register, see page 173.

The Watchdog Timer is configured using the following sequence:

1. Load the **WDTLOAD** register with the desired timer load value.
2. If WDT1, wait for the **WRC** bit in the **WDTCTL** register to be set.
3. If the Watchdog is configured to trigger system resets, set the **RESEN** bit in the **WDTCTL** register.
4. If WDT1, wait for the **WRC** bit in the **WDTCTL** register to be set.
5. Set the **INTEN** bit in the **WDTCTL** register to enable the Watchdog and lock the control register.

If software requires that all of the watchdog registers are locked, the Watchdog Timer module can be fully locked by writing any value to the **WDTLOCK** register. To unlock the Watchdog Timer, write a value of 0x1ACC.E551.

## 12.4 Register Map

Table 12-1 on page 484 lists the Watchdog registers. The offset listed is a hexadecimal increment to the register's address, relative to the Watchdog Timer base address:

- WDT0: 0x4000.0000
- WDT1: 0x4000.1000

Note that the Watchdog Timer module clock must be enabled before the registers can be programmed (see page 173).

**Table 12-1. Watchdog Timers Register Map**

Offset	Name	Type	Reset	Description	See page
0x000	WDTLOAD	R/W	0xFFFF.FFFF	Watchdog Load	485
0x004	WDTVALUE	RO	0xFFFF.FFFF	Watchdog Value	486
0x008	WDTCTL	R/W	0x0000.0000 (WDT0) 0x8000.0000 (WDT1)	Watchdog Control	487
0x00C	WDTICR	WO	-	Watchdog Interrupt Clear	489
0x010	WDTRIS	RO	0x0000.0000	Watchdog Raw Interrupt Status	490
0x014	WDTMIS	RO	0x0000.0000	Watchdog Masked Interrupt Status	491
0x418	WDTTEST	R/W	0x0000.0000	Watchdog Test	492
0xC00	WDTLOCK	R/W	0x0000.0000	Watchdog Lock	493
0xFD0	WDTPeriphID4	RO	0x0000.0000	Watchdog Peripheral Identification 4	494
0xFD4	WDTPeriphID5	RO	0x0000.0000	Watchdog Peripheral Identification 5	495
0xFD8	WDTPeriphID6	RO	0x0000.0000	Watchdog Peripheral Identification 6	496
0xFDC	WDTPeriphID7	RO	0x0000.0000	Watchdog Peripheral Identification 7	497
0xFE0	WDTPeriphID0	RO	0x0000.0005	Watchdog Peripheral Identification 0	498
0xFE4	WDTPeriphID1	RO	0x0000.0018	Watchdog Peripheral Identification 1	499
0xFE8	WDTPeriphID2	RO	0x0000.0018	Watchdog Peripheral Identification 2	500
0xFEC	WDTPeriphID3	RO	0x0000.0001	Watchdog Peripheral Identification 3	501
0xFF0	WDTPrimeCellID0	RO	0x0000.000D	Watchdog PrimeCell Identification 0	502
0xFF4	WDTPrimeCellID1	RO	0x0000.00F0	Watchdog PrimeCell Identification 1	503
0xFF8	WDTPrimeCellID2	RO	0x0000.0006	Watchdog PrimeCell Identification 2	504
0xFFC	WDTPrimeCellID3	RO	0x0000.00B1	Watchdog PrimeCell Identification 3	505

## 12.5 Register Descriptions

The remainder of this section lists and describes the WDT registers, in numerical order by address offset.

**Register 1: Watchdog Load (WDTLOAD), offset 0x000**

This register is the 32-bit interval value used by the 32-bit counter. When this register is written, the value is immediately loaded and the counter restarts counting down from the new value. If the **WDTLOAD** register is loaded with 0x0000.0000, an interrupt is immediately generated.

**Watchdog Load (WDTLOAD)**

WDT0 base: 0x4000.0000

WDT1 base: 0x4000.1000

Offset 0x000

Type R/W, reset 0xFFFF.FFFF

	31	30	29	28	27	26	25	24	23	22	21	20	19	18	17	16
	WDTLOAD															
Type	R/W	R/W	R/W	R/W	R/W	R/W	R/W	R/W	R/W	R/W	R/W	R/W	R/W	R/W	R/W	R/W
Reset	1	1	1	1	1	1	1	1	1	1	1	1	1	1	1	1
	15	14	13	12	11	10	9	8	7	6	5	4	3	2	1	0
	WDTLOAD															
Type	R/W	R/W	R/W	R/W	R/W	R/W	R/W	R/W	R/W	R/W	R/W	R/W	R/W	R/W	R/W	R/W
Reset	1	1	1	1	1	1	1	1	1	1	1	1	1	1	1	1

Bit/Field	Name	Type	Reset	Description
31:0	WDTLOAD	R/W	0xFFFF.FFFF	Watchdog Load Value

## Register 2: Watchdog Value (WDTVALUE), offset 0x004

This register contains the current count value of the timer.

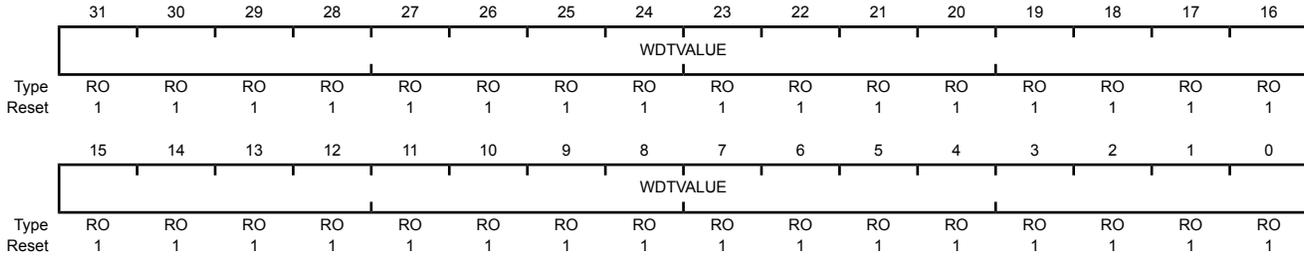
### Watchdog Value (WDTVALUE)

WDT0 base: 0x4000.0000

WDT1 base: 0x4000.1000

Offset 0x004

Type RO, reset 0xFFFF.FFFF



Bit/Field	Name	Type	Reset	Description
31:0	WDTVALUE	RO	0xFFFF.FFFF	Watchdog Value Current value of the 32-bit down counter.

### Register 3: Watchdog Control (WDTCTL), offset 0x008

This register is the watchdog control register. The watchdog timer can be configured to generate a reset signal (on second time-out) or an interrupt on time-out.

When the watchdog interrupt has been enabled, all subsequent writes to the control register are ignored. The only mechanism that can re-enable writes is a hardware reset.

**Important:** Because the Watchdog Timer 1 module has an independent clocking domain, its registers must be written with a timing gap between accesses. Software must guarantee that this delay is inserted between back-to-back writes to WDT1 registers or between a write followed by a read to the registers. The timing for back-to-back reads from the WDT1 module has no restrictions. The `WRC` bit in the **Watchdog Control (WDTCTL)** register for WDT1 indicates that the required timing gap has elapsed. This bit is cleared on a write operation and set once the write completes, indicating to software that another write or read may be started safely. Software should poll **WDTCTL** for `WRC=1` prior to accessing another register. Note that WDT0 does not have this restriction as it runs off the system clock and therefore does not have a `WRC` bit.

#### Watchdog Control (WDTCTL)

WDT0 base: 0x4000.0000

WDT1 base: 0x4000.1000

Offset 0x008

Type R/W, reset 0x0000.0000 (WDT0) and 0x8000.0000 (WDT1)

	31	30	29	28	27	26	25	24	23	22	21	20	19	18	17	16
	WRC	reserved														
Type	RO	RO	RO	RO	RO	RO	RO	RO	RO	RO	RO	RO	RO	RO	RO	RO
Reset	1	0	0	0	0	0	0	0	0	0	0	0	0	0	0	0
	15	14	13	12	11	10	9	8	7	6	5	4	3	2	1	0
	reserved														RESEN	INTEN
Type	RO	RO	RO	RO	RO	RO	RO	RO	RO	RO	RO	RO	RO	RO	R/W	R/W
Reset	0	0	0	0	0	0	0	0	0	0	0	0	0	0	0	0

Bit/Field	Name	Type	Reset	Description
31	WRC	RO	1	Write Complete
				The <code>WRC</code> values are defined as follows:
				Value Description
				0 A write access to one of the WDT1 registers is in progress.
				1 A write access is not in progress, and WDT1 registers can be read or written.
				<b>Note:</b> This bit is reserved for WDT0 and has a reset value of 0.
30:2	reserved	RO	0x000.000	Software should not rely on the value of a reserved bit. To provide compatibility with future products, the value of a reserved bit should be preserved across a read-modify-write operation.

Bit/Field	Name	Type	Reset	Description
1	RESEN	R/W	0	Watchdog Reset Enable The RESEN values are defined as follows:  Value Description 0 Disabled. 1 Enable the Watchdog module reset output.
0	INTEN	R/W	0	Watchdog Interrupt Enable The INTEN values are defined as follows:  Value Description 0 Interrupt event disabled (once this bit is set, it can only be cleared by a hardware reset). 1 Interrupt event enabled. Once enabled, all writes are ignored.



**Register 4: Watchdog Interrupt Clear (WDTICR), offset 0x00C**

This register is the interrupt clear register. A write of any value to this register clears the Watchdog interrupt and reloads the 32-bit counter from the **WDTLOAD** register. Value for a read or reset is indeterminate.

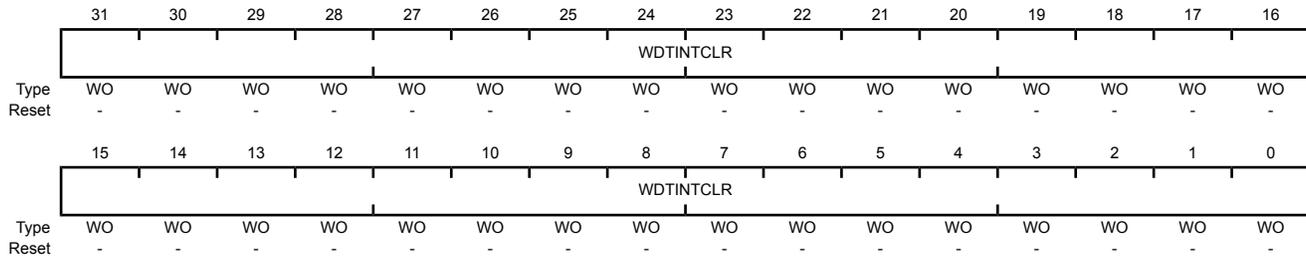
**Watchdog Interrupt Clear (WDTICR)**

WDT0 base: 0x4000.0000

WDT1 base: 0x4000.1000

Offset 0x00C

Type WO, reset -



Bit/Field	Name	Type	Reset	Description
31:0	WDTINTCLR	WO	-	Watchdog Interrupt Clear

### Register 5: Watchdog Raw Interrupt Status (WDTRIS), offset 0x010

This register is the raw interrupt status register. Watchdog interrupt events can be monitored via this register if the controller interrupt is masked.

#### Watchdog Raw Interrupt Status (WDTRIS)

WDT0 base: 0x4000.0000  
 WDT1 base: 0x4000.1000  
 Offset 0x010  
 Type RO, reset 0x0000.0000

	31	30	29	28	27	26	25	24	23	22	21	20	19	18	17	16
	reserved															
Type	RO	RO	RO	RO	RO	RO	RO	RO	RO	RO	RO	RO	RO	RO	RO	RO
Reset	0	0	0	0	0	0	0	0	0	0	0	0	0	0	0	0
	15	14	13	12	11	10	9	8	7	6	5	4	3	2	1	0
	reserved															WDTRIS
Type	RO	RO	RO	RO	RO	RO	RO	RO	RO	RO	RO	RO	RO	RO	RO	RO
Reset	0	0	0	0	0	0	0	0	0	0	0	0	0	0	0	0

Bit/Field	Name	Type	Reset	Description
31:1	reserved	RO	0x0000.000	Software should not rely on the value of a reserved bit. To provide compatibility with future products, the value of a reserved bit should be preserved across a read-modify-write operation.
0	WDTRIS	RO	0	Watchdog Raw Interrupt Status

Value	Description
1	A watchdog time-out event has occurred.
0	The watchdog has not timed out.

**Register 6: Watchdog Masked Interrupt Status (WDTMIS), offset 0x014**

This register is the masked interrupt status register. The value of this register is the logical AND of the raw interrupt bit and the Watchdog interrupt enable bit.

**Watchdog Masked Interrupt Status (WDTMIS)**

WDT0 base: 0x4000.0000

WDT1 base: 0x4000.1000

Offset 0x014

Type RO, reset 0x0000.0000

	31	30	29	28	27	26	25	24	23	22	21	20	19	18	17	16
	reserved															
Type	RO	RO	RO	RO	RO	RO	RO	RO	RO	RO	RO	RO	RO	RO	RO	RO
Reset	0	0	0	0	0	0	0	0	0	0	0	0	0	0	0	0
	15	14	13	12	11	10	9	8	7	6	5	4	3	2	1	0
	reserved															WDTMIS
Type	RO	RO	RO	RO	RO	RO	RO	RO	RO	RO	RO	RO	RO	RO	RO	RO
Reset	0	0	0	0	0	0	0	0	0	0	0	0	0	0	0	0

Bit/Field	Name	Type	Reset	Description
31:1	reserved	RO	0x0000.000	Software should not rely on the value of a reserved bit. To provide compatibility with future products, the value of a reserved bit should be preserved across a read-modify-write operation.
0	WDTMIS	RO	0	Watchdog Masked Interrupt Status
				Value Description
				1 A watchdog time-out event has been signalled to the interrupt controller.
				0 The watchdog has not timed out or the watchdog timer interrupt is masked.

### Register 7: Watchdog Test (WDTTEST), offset 0x418

This register provides user-enabled stalling when the microcontroller asserts the CPU halt flag during debug.

#### Watchdog Test (WDTTEST)

WDT0 base: 0x4000.0000  
 WDT1 base: 0x4000.1000  
 Offset 0x418  
 Type R/W, reset 0x0000.0000

	31	30	29	28	27	26	25	24	23	22	21	20	19	18	17	16
	reserved															
Type	RO	RO	RO	RO	RO	RO	RO	RO	RO	RO	RO	RO	RO	RO	RO	RO
Reset	0	0	0	0	0	0	0	0	0	0	0	0	0	0	0	0
	15	14	13	12	11	10	9	8	7	6	5	4	3	2	1	0
	reserved							STALL	reserved							
Type	RO	RO	RO	RO	RO	RO	RO	R/W	RO	RO	RO	RO	RO	RO	RO	RO
Reset	0	0	0	0	0	0	0	0	0	0	0	0	0	0	0	0

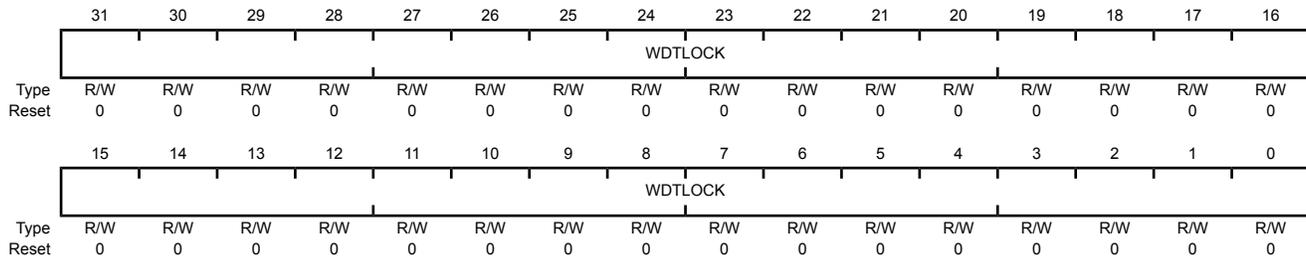
Bit/Field	Name	Type	Reset	Description
31:9	reserved	RO	0x0000.00	Software should not rely on the value of a reserved bit. To provide compatibility with future products, the value of a reserved bit should be preserved across a read-modify-write operation.
8	STALL	R/W	0	Watchdog Stall Enable
				Value Description 1 If the microcontroller is stopped with a debugger, the watchdog timer stops counting. Once the microcontroller is restarted, the watchdog timer resumes counting. 0 The watchdog timer continues counting if the microcontroller is stopped with a debugger.
7:0	reserved	RO	0x00	Software should not rely on the value of a reserved bit. To provide compatibility with future products, the value of a reserved bit should be preserved across a read-modify-write operation.

## Register 8: Watchdog Lock (WDTLOCK), offset 0xC00

Writing 0x1ACC.E551 to the **WDTLOCK** register enables write access to all other registers. Writing any other value to the **WDTLOCK** register re-enables the locked state for register writes to all the other registers. Reading the **WDTLOCK** register returns the lock status rather than the 32-bit value written. Therefore, when write accesses are disabled, reading the **WDTLOCK** register returns 0x0000.0001 (when locked; otherwise, the returned value is 0x0000.0000 (unlocked)).

### Watchdog Lock (WDTLOCK)

WDT0 base: 0x4000.0000  
 WDT1 base: 0x4000.1000  
 Offset 0xC00  
 Type R/W, reset 0x0000.0000



Bit/Field	Name	Type	Reset	Description
31:0	WDTLOCK	R/W	0x0000.0000	Watchdog Lock

A write of the value 0x1ACC.E551 unlocks the watchdog registers for write access. A write of any other value reapplies the lock, preventing any register updates.

A read of this register returns the following values:

Value	Description
0x0000.0001	Locked
0x0000.0000	Unlocked

### Register 9: Watchdog Peripheral Identification 4 (WDTPeriphID4), offset 0xFD0

The **WDTPeriphIDn** registers are hard-coded and the fields within the register determine the reset value.

#### Watchdog Peripheral Identification 4 (WDTPeriphID4)

WDT0 base: 0x4000.0000  
 WDT1 base: 0x4000.1000  
 Offset 0xFD0  
 Type RO, reset 0x0000.0000

	31	30	29	28	27	26	25	24	23	22	21	20	19	18	17	16
	reserved															
Type	RO	RO	RO	RO	RO	RO	RO	RO	RO	RO	RO	RO	RO	RO	RO	RO
Reset	0	0	0	0	0	0	0	0	0	0	0	0	0	0	0	0
	15	14	13	12	11	10	9	8	7	6	5	4	3	2	1	0
	reserved								PID4							
Type	RO	RO	RO	RO	RO	RO	RO	RO	RO	RO	RO	RO	RO	RO	RO	RO
Reset	0	0	0	0	0	0	0	0	0	0	0	0	0	0	0	0

Bit/Field	Name	Type	Reset	Description
31:8	reserved	RO	0x0000.00	Software should not rely on the value of a reserved bit. To provide compatibility with future products, the value of a reserved bit should be preserved across a read-modify-write operation.
7:0	PID4	RO	0x00	WDT Peripheral ID Register [7:0]

## Register 10: Watchdog Peripheral Identification 5 (WDTPeriphID5), offset 0xFD4

The **WDTPeriphIDn** registers are hard-coded and the fields within the register determine the reset value.

### Watchdog Peripheral Identification 5 (WDTPeriphID5)

WDT0 base: 0x4000.0000

WDT1 base: 0x4000.1000

Offset 0xFD4

Type RO, reset 0x0000.0000

	31	30	29	28	27	26	25	24	23	22	21	20	19	18	17	16
	reserved															
Type	RO	RO	RO	RO	RO	RO	RO	RO	RO	RO	RO	RO	RO	RO	RO	RO
Reset	0	0	0	0	0	0	0	0	0	0	0	0	0	0	0	0
	15	14	13	12	11	10	9	8	7	6	5	4	3	2	1	0
	reserved								PID5							
Type	RO	RO	RO	RO	RO	RO	RO	RO	RO	RO	RO	RO	RO	RO	RO	RO
Reset	0	0	0	0	0	0	0	0	0	0	0	0	0	0	0	0

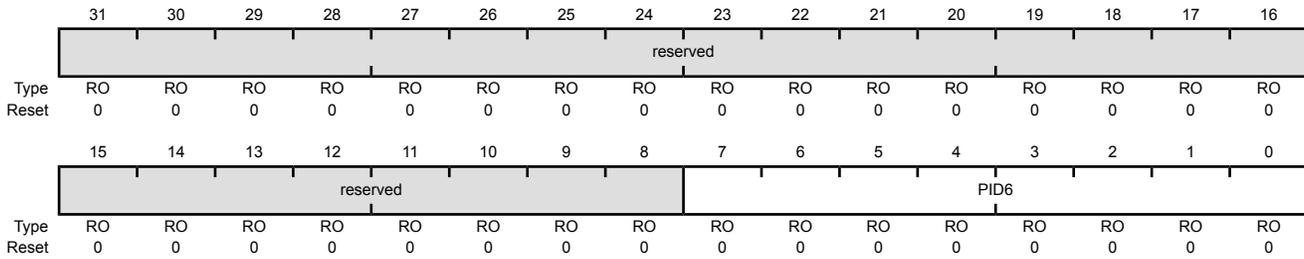
Bit/Field	Name	Type	Reset	Description
31:8	reserved	RO	0x0000.00	Software should not rely on the value of a reserved bit. To provide compatibility with future products, the value of a reserved bit should be preserved across a read-modify-write operation.
7:0	PID5	RO	0x00	WDT Peripheral ID Register [15:8]

### Register 11: Watchdog Peripheral Identification 6 (WDTPeriphID6), offset 0xFD8

The **WDTPeriphIDn** registers are hard-coded and the fields within the register determine the reset value.

#### Watchdog Peripheral Identification 6 (WDTPeriphID6)

WDT0 base: 0x4000.0000  
 WDT1 base: 0x4000.1000  
 Offset 0xFD8  
 Type RO, reset 0x0000.0000



Bit/Field	Name	Type	Reset	Description
31:8	reserved	RO	0x0000.00	Software should not rely on the value of a reserved bit. To provide compatibility with future products, the value of a reserved bit should be preserved across a read-modify-write operation.
7:0	PID6	RO	0x00	WDT Peripheral ID Register [23:16]



## Register 12: Watchdog Peripheral Identification 7 (WDTPeriphID7), offset 0xFDC

The **WDTPeriphIDn** registers are hard-coded and the fields within the register determine the reset value.

### Watchdog Peripheral Identification 7 (WDTPeriphID7)

WDT0 base: 0x4000.0000

WDT1 base: 0x4000.1000

Offset 0xFDC

Type RO, reset 0x0000.0000

	31	30	29	28	27	26	25	24	23	22	21	20	19	18	17	16
	reserved															
Type	RO	RO	RO	RO	RO	RO	RO	RO	RO	RO	RO	RO	RO	RO	RO	RO
Reset	0	0	0	0	0	0	0	0	0	0	0	0	0	0	0	0
	15	14	13	12	11	10	9	8	7	6	5	4	3	2	1	0
	reserved								PID7							
Type	RO	RO	RO	RO	RO	RO	RO	RO	RO	RO	RO	RO	RO	RO	RO	RO
Reset	0	0	0	0	0	0	0	0	0	0	0	0	0	0	0	0

Bit/Field	Name	Type	Reset	Description
31:8	reserved	RO	0x0000.00	Software should not rely on the value of a reserved bit. To provide compatibility with future products, the value of a reserved bit should be preserved across a read-modify-write operation.
7:0	PID7	RO	0x00	WDT Peripheral ID Register [31:24]

### Register 13: Watchdog Peripheral Identification 0 (WDTPeriphID0), offset 0xFE0

The **WDTPeriphIDn** registers are hard-coded and the fields within the register determine the reset value.

#### Watchdog Peripheral Identification 0 (WDTPeriphID0)

WDT0 base: 0x4000.0000  
 WDT1 base: 0x4000.1000  
 Offset 0xFE0  
 Type RO, reset 0x0000.0005

	31	30	29	28	27	26	25	24	23	22	21	20	19	18	17	16
	reserved															
Type	RO	RO	RO	RO	RO	RO	RO	RO	RO	RO	RO	RO	RO	RO	RO	RO
Reset	0	0	0	0	0	0	0	0	0	0	0	0	0	0	0	0
	15	14	13	12	11	10	9	8	7	6	5	4	3	2	1	0
	reserved								PID0							
Type	RO	RO	RO	RO	RO	RO	RO	RO	RO	RO	RO	RO	RO	RO	RO	RO
Reset	0	0	0	0	0	0	0	0	0	0	0	0	0	1	0	1

Bit/Field	Name	Type	Reset	Description
31:8	reserved	RO	0x0000.00	Software should not rely on the value of a reserved bit. To provide compatibility with future products, the value of a reserved bit should be preserved across a read-modify-write operation.
7:0	PID0	RO	0x05	Watchdog Peripheral ID Register [7:0]

## Register 14: Watchdog Peripheral Identification 1 (WDTPeriphID1), offset 0xFE4

The **WDTPeriphIDn** registers are hard-coded and the fields within the register determine the reset value.

### Watchdog Peripheral Identification 1 (WDTPeriphID1)

WDT0 base: 0x4000.0000

WDT1 base: 0x4000.1000

Offset 0xFE4

Type RO, reset 0x0000.0018

	31	30	29	28	27	26	25	24	23	22	21	20	19	18	17	16
	reserved															
Type	RO	RO	RO	RO	RO	RO	RO	RO	RO	RO	RO	RO	RO	RO	RO	RO
Reset	0	0	0	0	0	0	0	0	0	0	0	0	0	0	0	0
	15	14	13	12	11	10	9	8	7	6	5	4	3	2	1	0
	reserved								PID1							
Type	RO	RO	RO	RO	RO	RO	RO	RO	RO	RO	RO	RO	RO	RO	RO	RO
Reset	0	0	0	0	0	0	0	0	0	0	0	1	1	0	0	0

Bit/Field	Name	Type	Reset	Description
31:8	reserved	RO	0x0000.00	Software should not rely on the value of a reserved bit. To provide compatibility with future products, the value of a reserved bit should be preserved across a read-modify-write operation.
7:0	PID1	RO	0x18	Watchdog Peripheral ID Register [15:8]

## Register 15: Watchdog Peripheral Identification 2 (WDTPeriphID2), offset 0xFE8

The **WDTPeriphIDn** registers are hard-coded and the fields within the register determine the reset value.

### Watchdog Peripheral Identification 2 (WDTPeriphID2)

WDT0 base: 0x4000.0000

WDT1 base: 0x4000.1000

Offset 0xFE8

Type RO, reset 0x0000.0018

	31	30	29	28	27	26	25	24	23	22	21	20	19	18	17	16
	reserved															
Type	RO	RO	RO	RO	RO	RO	RO	RO	RO	RO	RO	RO	RO	RO	RO	RO
Reset	0	0	0	0	0	0	0	0	0	0	0	0	0	0	0	0
	15	14	13	12	11	10	9	8	7	6	5	4	3	2	1	0
	reserved								PID2							
Type	RO	RO	RO	RO	RO	RO	RO	RO	RO	RO	RO	RO	RO	RO	RO	RO
Reset	0	0	0	0	0	0	0	0	0	0	0	0	1	1	0	0

Bit/Field	Name	Type	Reset	Description
31:8	reserved	RO	0x0000.00	Software should not rely on the value of a reserved bit. To provide compatibility with future products, the value of a reserved bit should be preserved across a read-modify-write operation.
7:0	PID2	RO	0x18	Watchdog Peripheral ID Register [23:16]

## Register 16: Watchdog Peripheral Identification 3 (WDTPeriphID3), offset 0xFEC

The **WDTPeriphIDn** registers are hard-coded and the fields within the register determine the reset value.

### Watchdog Peripheral Identification 3 (WDTPeriphID3)

WDT0 base: 0x4000.0000

WDT1 base: 0x4000.1000

Offset 0xFEC

Type RO, reset 0x0000.0001

	31	30	29	28	27	26	25	24	23	22	21	20	19	18	17	16
	reserved															
Type	RO	RO	RO	RO	RO	RO	RO	RO	RO	RO	RO	RO	RO	RO	RO	RO
Reset	0	0	0	0	0	0	0	0	0	0	0	0	0	0	0	0
	15	14	13	12	11	10	9	8	7	6	5	4	3	2	1	0
	reserved								PID3							
Type	RO	RO	RO	RO	RO	RO	RO	RO	RO	RO	RO	RO	RO	RO	RO	RO
Reset	0	0	0	0	0	0	0	0	0	0	0	0	0	0	0	1

Bit/Field	Name	Type	Reset	Description
31:8	reserved	RO	0x0000.00	Software should not rely on the value of a reserved bit. To provide compatibility with future products, the value of a reserved bit should be preserved across a read-modify-write operation.
7:0	PID3	RO	0x01	Watchdog Peripheral ID Register [31:24]

### Register 17: Watchdog PrimeCell Identification 0 (WDTPCellID0), offset 0xFF0

The **WDTPCellIDn** registers are hard-coded and the fields within the register determine the reset value.

#### Watchdog PrimeCell Identification 0 (WDTPCellID0)

WDT0 base: 0x4000.0000  
 WDT1 base: 0x4000.1000  
 Offset 0xFF0  
 Type RO, reset 0x0000.000D

	31	30	29	28	27	26	25	24	23	22	21	20	19	18	17	16
	reserved															
Type	RO	RO	RO	RO	RO	RO	RO	RO	RO	RO	RO	RO	RO	RO	RO	RO
Reset	0	0	0	0	0	0	0	0	0	0	0	0	0	0	0	0
	15	14	13	12	11	10	9	8	7	6	5	4	3	2	1	0
	reserved								CID0							
Type	RO	RO	RO	RO	RO	RO	RO	RO	RO	RO	RO	RO	RO	RO	RO	RO
Reset	0	0	0	0	0	0	0	0	0	0	0	0	1	1	0	1

Bit/Field	Name	Type	Reset	Description
31:8	reserved	RO	0x0000.00	Software should not rely on the value of a reserved bit. To provide compatibility with future products, the value of a reserved bit should be preserved across a read-modify-write operation.
7:0	CID0	RO	0x0D	Watchdog PrimeCell ID Register [7:0]

**Register 18: Watchdog PrimeCell Identification 1 (WDTPCellID1), offset 0xFF4**

The **WDTPCellIDn** registers are hard-coded and the fields within the register determine the reset value.

## Watchdog PrimeCell Identification 1 (WDTPCellID1)

WDT0 base: 0x4000.0000

WDT1 base: 0x4000.1000

Offset 0xFF4

Type RO, reset 0x0000.00F0

	31	30	29	28	27	26	25	24	23	22	21	20	19	18	17	16
	reserved															
Type	RO	RO	RO	RO	RO	RO	RO	RO	RO	RO	RO	RO	RO	RO	RO	RO
Reset	0	0	0	0	0	0	0	0	0	0	0	0	0	0	0	0
	15	14	13	12	11	10	9	8	7	6	5	4	3	2	1	0
	reserved								CID1							
Type	RO	RO	RO	RO	RO	RO	RO	RO	RO	RO	RO	RO	RO	RO	RO	RO
Reset	0	0	0	0	0	0	0	0	1	1	1	1	0	0	0	0

Bit/Field	Name	Type	Reset	Description
31:8	reserved	RO	0x0000.00	Software should not rely on the value of a reserved bit. To provide compatibility with future products, the value of a reserved bit should be preserved across a read-modify-write operation.
7:0	CID1	RO	0xF0	Watchdog PrimeCell ID Register [15:8]

### Register 19: Watchdog PrimeCell Identification 2 (WDTPCellID2), offset 0xFF8

The **WDTPCellIDn** registers are hard-coded and the fields within the register determine the reset value.

#### Watchdog PrimeCell Identification 2 (WDTPCellID2)

WDT0 base: 0x4000.0000  
 WDT1 base: 0x4000.1000  
 Offset 0xFF8  
 Type RO, reset 0x0000.0006

	31	30	29	28	27	26	25	24	23	22	21	20	19	18	17	16
	reserved															
Type	RO	RO	RO	RO	RO	RO	RO	RO	RO	RO	RO	RO	RO	RO	RO	RO
Reset	0	0	0	0	0	0	0	0	0	0	0	0	0	0	0	0
	15	14	13	12	11	10	9	8	7	6	5	4	3	2	1	0
	reserved								CID2							
Type	RO	RO	RO	RO	RO	RO	RO	RO	RO	RO	RO	RO	RO	RO	RO	RO
Reset	0	0	0	0	0	0	0	0	0	0	0	0	0	1	1	0

Bit/Field	Name	Type	Reset	Description
31:8	reserved	RO	0x0000.00	Software should not rely on the value of a reserved bit. To provide compatibility with future products, the value of a reserved bit should be preserved across a read-modify-write operation.
7:0	CID2	RO	0x06	Watchdog PrimeCell ID Register [23:16]



**Register 20: Watchdog PrimeCell Identification 3 (WDTPCellID3), offset 0xFFC**

The **WDTPCellIDn** registers are hard-coded and the fields within the register determine the reset value.

## Watchdog PrimeCell Identification 3 (WDTPCellID3)

WDT0 base: 0x4000.0000

WDT1 base: 0x4000.1000

Offset 0xFFC

Type RO, reset 0x0000.00B1

	31	30	29	28	27	26	25	24	23	22	21	20	19	18	17	16
	reserved															
Type	RO	RO	RO	RO	RO	RO	RO	RO	RO	RO	RO	RO	RO	RO	RO	RO
Reset	0	0	0	0	0	0	0	0	0	0	0	0	0	0	0	0
	15	14	13	12	11	10	9	8	7	6	5	4	3	2	1	0
	reserved								CID3							
Type	RO	RO	RO	RO	RO	RO	RO	RO	RO	RO	RO	RO	RO	RO	RO	RO
Reset	0	0	0	0	0	0	0	0	1	0	1	1	0	0	0	1

Bit/Field	Name	Type	Reset	Description
31:8	reserved	RO	0x0000.00	Software should not rely on the value of a reserved bit. To provide compatibility with future products, the value of a reserved bit should be preserved across a read-modify-write operation.
7:0	CID3	RO	0xB1	Watchdog PrimeCell ID Register [31:24]

## 13 Analog-to-Digital Converter (ADC)

An analog-to-digital converter (ADC) is a peripheral that converts a continuous analog voltage to a discrete digital number. Two identical converter units are included, which share sixteen input channels.

The Stellaris<sup>®</sup> ADC module features 10-bit conversion resolution and supports sixteen input channels, plus an internal temperature sensor. The ADC module contains four programmable sequencers allowing the sampling of multiple analog input sources without controller intervention. Each sample sequencer provides flexible programming with fully configurable input source, trigger events, interrupt generation, and sequencer priority. A digital comparator function is included which allows the conversion value to be diverted to a digital comparator module. The digital comparator module provides digital comparator. Each digital comparator evaluates the ADC conversion value against its two user-defined values to determine the operational range of the signal. The trigger source for ADC0 and ADC1 may be independent or the two ADC units may operate from the same trigger source and operate on the same or different inputs. A phase shifter can delay the start of sampling by a specified phase angle. When using both ADC modules, it is possible to configure the converters to start the conversions coincidentally or within a relative phase from each other, see “Sample Phase Control” on page 511.

The Stellaris<sup>®</sup> LM3S9B96 microcontroller provides two ADC modules with the following features:

- Sixteen analog input channels
- Single-ended and differential-input configurations
- On-chip internal temperature sensor
- Maximum sample rate of one million samples/second
- Optional phase shift in sample time programmable from 22.5° to 337.5°
- Four programmable sample conversion sequencers from one to eight entries long, with corresponding conversion result FIFOs
- Flexible trigger control
  - Controller (software)
  - Timers
  - Analog Comparators
  - PWM
  - GPIO
- Hardware averaging of up to 64 samples for improved accuracy
- Digital comparison unit providing sixteen digital comparators
- Converter uses an internal 3-V reference or an external reference
- Power and ground for the analog circuitry is separate from the digital power and ground
- Efficient transfers using Micro Direct Memory Access Controller (μDMA)

- Dedicated channel for each sample sequencer
- ADC module uses burst requests for DMA

## 13.1 Block Diagram

The Stellaris® microcontroller contains two identical Analog-to-Digital Converter units. These two modules, ADC0 and ADC1, share the same sixteen analog input channels. Each ADC module operates independently and can therefore execute different sample sequences, sample any of the analog input channels at any time, and generate different interrupts and triggers. Figure 13-1 on page 507 shows how the two modules are connected to analog inputs and the system bus.

Figure 13-1. Implementation of Two ADC Blocks

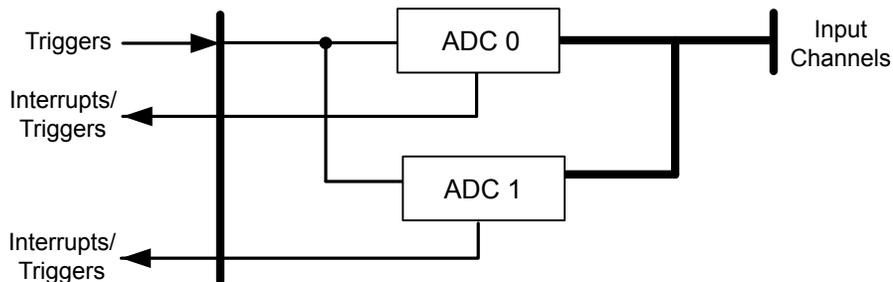
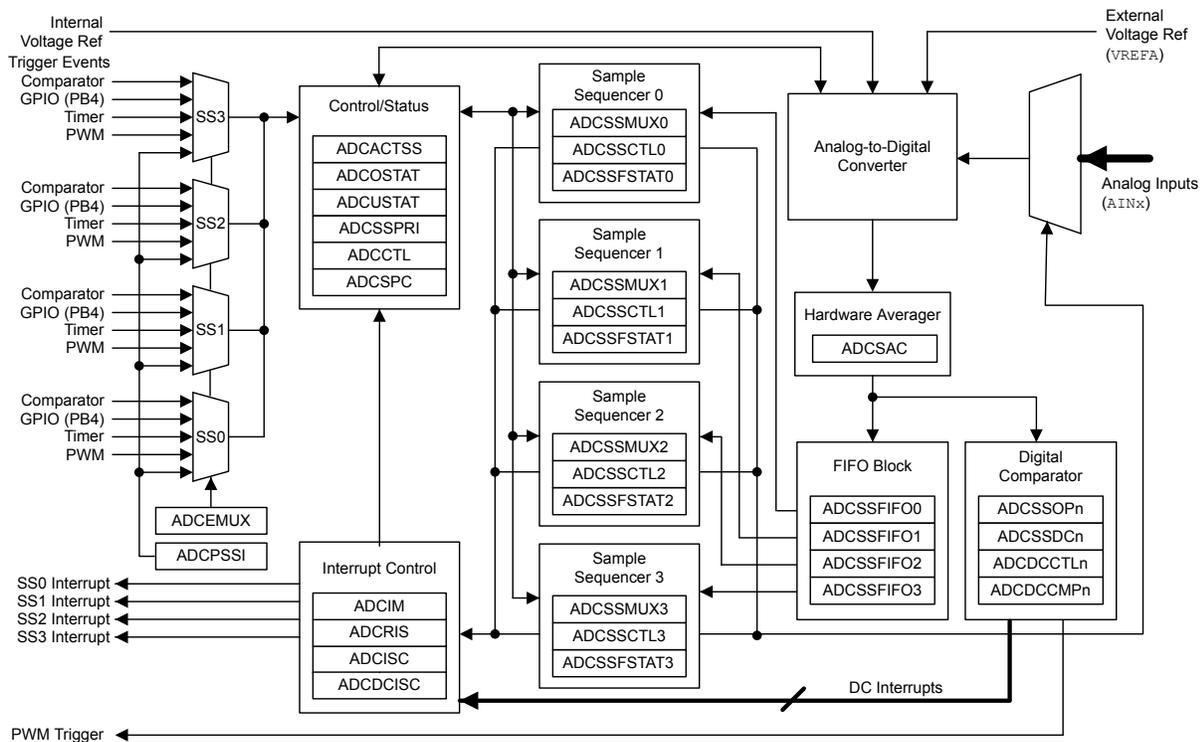


Figure 13-2 on page 507 provides details on the internal configuration of the ADC controls and data registers.

Figure 13-2. ADC Module Block Diagram



## 13.2 Signal Description

Table 13-1 on page 508 and Table 13-2 on page 508 list the external signals of the ADC module and describe the function of each. The ADC signals are analog functions for some GPIO signals. The column in the table below titled "Pin Mux/Pin Assignment" lists the GPIO pin placement for the ADC signals. Note that when a pin is used as an ADC input, the appropriate bit in the **GPIO Analog Mode Select (GPIOAMSEL)** register must be set to disable the analog isolation circuit, and the appropriate bit in the **GPIO Digital Enable (GPIODEN)** register must be clear to disable digital function. For more information on configuring GPIOs, see "General-Purpose Input/Outputs (GPIOs)" on page 304.

**Table 13-1. Signals for ADC (100LQFP)**

Pin Name	Pin Number	Pin Mux / Pin Assignment	Pin Type	Buffer Type <sup>a</sup>	Description
AIN0	1	PE7	I	Analog	Analog-to-digital converter input 0.
AIN1	2	PE6	I	Analog	Analog-to-digital converter input 1.
AIN2	5	PE5	I	Analog	Analog-to-digital converter input 2.
AIN3	6	PE4	I	Analog	Analog-to-digital converter input 3.
AIN4	100	PD7	I	Analog	Analog-to-digital converter input 4.
AIN5	99	PD6	I	Analog	Analog-to-digital converter input 5.
AIN6	98	PD5	I	Analog	Analog-to-digital converter input 6.
AIN7	97	PD4	I	Analog	Analog-to-digital converter input 7.
AIN8	96	PE3	I	Analog	Analog-to-digital converter input 8.
AIN9	95	PE2	I	Analog	Analog-to-digital converter input 9.
AIN10	92	PB4	I	Analog	Analog-to-digital converter input 10.
AIN11	91	PB5	I	Analog	Analog-to-digital converter input 11.
AIN12	13	PD3	I	Analog	Analog-to-digital converter input 12.
AIN13	12	PD2	I	Analog	Analog-to-digital converter input 13.
AIN14	11	PD1	I	Analog	Analog-to-digital converter input 14.
AIN15	10	PD0	I	Analog	Analog-to-digital converter input 15.
VREFA	90	PB6	I	Analog	This input provides a reference voltage used to specify the input voltage at which the ADC converts to a maximum value. In other words, the voltage that is applied to VREFA is the voltage with which an AIN <sub>n</sub> signal is converted to 1023. The VREFA input is limited to the range specified in Table 27-2 on page 1205.

a. The TTL designation indicates the pin has TTL-compatible voltage levels.

**Table 13-2. Signals for ADC (108BGA)**

Pin Name	Pin Number	Pin Mux / Pin Assignment	Pin Type	Buffer Type <sup>a</sup>	Description
AIN0	B1	PE7	I	Analog	Analog-to-digital converter input 0.
AIN1	A1	PE6	I	Analog	Analog-to-digital converter input 1.
AIN2	B3	PE5	I	Analog	Analog-to-digital converter input 2.
AIN3	B2	PE4	I	Analog	Analog-to-digital converter input 3.
AIN4	A2	PD7	I	Analog	Analog-to-digital converter input 4.
AIN5	A3	PD6	I	Analog	Analog-to-digital converter input 5.
AIN6	C6	PD5	I	Analog	Analog-to-digital converter input 6.

Table 13-2. Signals for ADC (108BGA) (continued)

Pin Name	Pin Number	Pin Mux / Pin Assignment	Pin Type	Buffer Type <sup>a</sup>	Description
AIN7	B5	PD4	I	Analog	Analog-to-digital converter input 7.
AIN8	B4	PE3	I	Analog	Analog-to-digital converter input 8.
AIN9	A4	PE2	I	Analog	Analog-to-digital converter input 9.
AIN10	A6	PB4	I	Analog	Analog-to-digital converter input 10.
AIN11	B7	PB5	I	Analog	Analog-to-digital converter input 11.
AIN12	H1	PD3	I	Analog	Analog-to-digital converter input 12.
AIN13	H2	PD2	I	Analog	Analog-to-digital converter input 13.
AIN14	G2	PD1	I	Analog	Analog-to-digital converter input 14.
AIN15	G1	PD0	I	Analog	Analog-to-digital converter input 15.
VREFA	A7	PB6	I	Analog	This input provides a reference voltage used to specify the input voltage at which the ADC converts to a maximum value. In other words, the voltage that is applied to VREFA is the voltage with which an AIN <sub>n</sub> signal is converted to 1023. The VREFA input is limited to the range specified in Table 27-2 on page 1205.

a. The TTL designation indicates the pin has TTL-compatible voltage levels.

## 13.3 Functional Description

The Stellaris® ADC collects sample data by using a programmable sequence-based approach instead of the traditional single or double-sampling approaches found on many ADC modules. Each *sample sequence* is a fully programmed series of consecutive (back-to-back) samples, allowing the ADC to collect data from multiple input sources without having to be re-configured or serviced by the processor. The programming of each sample in the sample sequence includes parameters such as the input source and mode (differential versus single-ended input), interrupt generation on sample completion, and the indicator for the last sample in the sequence. In addition, the  $\mu$ DMA can be used to more efficiently move data from the sample sequencers without CPU intervention.

### 13.3.1 Sample Sequencers

The sampling control and data capture is handled by the sample sequencers. All of the sequencers are identical in implementation except for the number of samples that can be captured and the depth of the FIFO. Table 13-3 on page 509 shows the maximum number of samples that each sequencer can capture and its corresponding FIFO depth. In this implementation, each FIFO entry is a 32-bit word, with the lower 10 bits containing the conversion result.

Table 13-3. Samples and FIFO Depth of Sequencers

Sequencer	Number of Samples	Depth of FIFO
SS3	1	1
SS2	4	4
SS1	4	4
SS0	8	8

For a given sample sequence, each sample is defined by two 4-bit nibbles in the **ADC Sample Sequence Input Multiplexer Select (ADCSSMUX<sub>n</sub>)** and **ADC Sample Sequence Control (ADCSSCTL<sub>n</sub>)** registers, where "n" corresponds to the sequence number. The **ADCSSMUX<sub>n</sub>**

nibbles select the input pin, while the **ADCSSCTLn** nibbles contain the sample control bits corresponding to parameters such as temperature sensor selection, interrupt enable, end of sequence, and differential input mode. Sample sequencers are enabled by setting the respective **ASENn** bit in the **ADC Active Sample Sequencer (ADCACTSS)** register and should be configured before being enabled. Sampling is then initiated by setting the **SSn** bit in the **ADC Processor Sample Sequence Initiate (ADCPSSI)** register. In addition, sample sequences may be initiated on multiple ADC modules simultaneously using the **GSYNC** and **SYNCWAIT** bits in the **ADCPSSI** register during the configuration of each ADC module. For more information on using these bits, refer to page 546.

When configuring a sample sequence, multiple uses of the same input pin within the same sequence is allowed. In the **ADCSSCTLn** register, the **IE<sub>n</sub>** bits can be set for any combination of samples, allowing interrupts to be generated after every sample in the sequence if necessary. Also, the **END** bit can be set at any point within a sample sequence. For example, if Sequencer 0 is used, the **END** bit can be set in the nibble associated with the fifth sample, allowing Sequencer 0 to complete execution of the sample sequence after the fifth sample.

After a sample sequence completes execution, the result data can be retrieved from the **ADC Sample Sequence Result FIFO (ADCSSFIFOn)** registers. The FIFOs are simple circular buffers that read a single address to "pop" result data. For software debug purposes, the positions of the FIFO head and tail pointers are visible in the **ADC Sample Sequence FIFO Status (ADCSSFSTATn)** registers along with **FULL** and **EMPTY** status flags. Overflow and underflow conditions are monitored using the **ADCSTAT** and **ADCUSTAT** registers.

### 13.3.2 Module Control

Outside of the sample sequencers, the remainder of the control logic is responsible for tasks such as:

- Interrupt generation
- DMA operation
- Sequence prioritization
- Trigger configuration
- Comparator configuration
- External voltage reference
- Sample phase control

Most of the ADC control logic runs at the ADC clock rate of 14-18 MHz. The internal ADC divider is configured for 16-MHz operation automatically by hardware when the system **XTAL** is selected.

#### 13.3.2.1 Interrupts

The register configurations of the sample sequencers and digital comparators dictate which events generate raw interrupts, but do not have control over whether the interrupt is actually sent to the interrupt controller. The ADC module's interrupt signals are controlled by the state of the **MASK** bits in the **ADC Interrupt Mask (ADCIM)** register. Interrupt status can be viewed at two locations: the **ADC Raw Interrupt Status (ADCRIS)** register, which shows the raw status of the various interrupt signals; and the **ADC Interrupt Status and Clear (ADCISC)** register, which shows active interrupts that are enabled by the **ADCIM** register. Sequencer interrupts are cleared by writing a 1 to the corresponding **IN** bit in **ADCISC**. Digital comparator interrupts are cleared by writing a 1 to the **ADC Digital Comparator Interrupt Status and Clear (ADCDCISC)** register.

### 13.3.2.2 DMA Operation

The ADC module provides a request signal from each sample sequencer to the associated dedicated channel of the  $\mu$ DMA controller. This configuration allows each sample sequencer to operate independently and transfer data without processor intervention or reconfiguration. The ADC does not support single transfer requests. A burst transfer request is asserted when the interrupt bit for the sample sequence is set ( $\text{IE}$  bit in the **ADCSSCTLn** register is set).

The arbitration size of the  $\mu$ DMA transfer must be a power of 2, and the associated  $\text{IE}$  bits in the **ADSSCTLn** register must be set. For example, if the  $\mu$ DMA channel of SS0 has an arbitration size of four, the  $\text{IE3}$  bit (4th sample) and the  $\text{IE7}$  bit (8th sample) must be set. Thus the  $\mu$ DMA request occurs every time 4 samples have been acquired. No other special steps are needed to enable the ADC module for  $\mu$ DMA operation.

Refer to the “Micro Direct Memory Access ( $\mu$ DMA)” on page 246 for more details about programming the  $\mu$ DMA controller.

### 13.3.2.3 Prioritization

When sampling events (triggers) happen concurrently, they are prioritized for processing by the values in the **ADC Sample Sequencer Priority (ADCSSPRI)** register. Valid priority values are in the range of 0-3, with 0 being the highest priority and 3 being the lowest. Multiple active sample sequencer units with the same priority do not provide consistent results, so software must ensure that all active sample sequencer units have a unique priority value.

### 13.3.2.4 Sampling Events

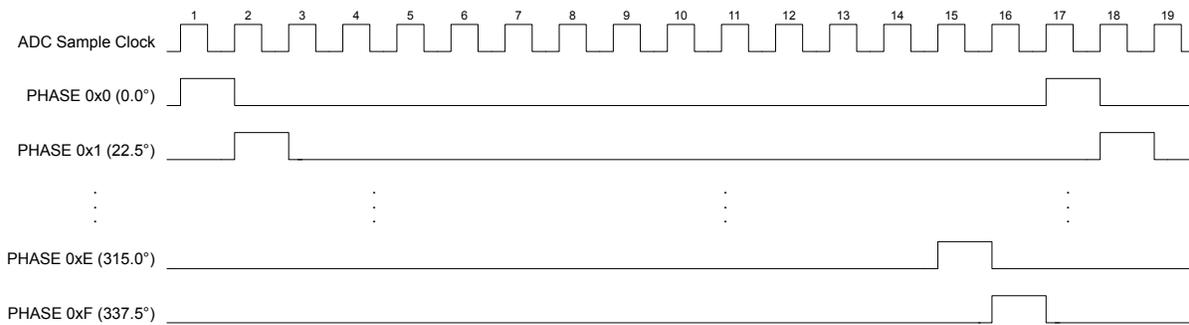
Sample triggering for each sample sequencer is defined in the **ADC Event Multiplexer Select (ADCEMUX)** register. Trigger sources include processor (default), analog comparators, an external signal on GPIO  $\text{PB4}$ , a GP Timer, PWM2, and continuous sampling. Software can initiate sampling by setting the  $\text{SSx}$  bits in the **ADC Processor Sample Sequence Initiate (ADCPSSI)** register.

Care must be taken when using the continuous sampling trigger. If a sequencer's priority is too high, it is possible to starve other lower priority sequencers.

### 13.3.2.5 Sample Phase Control

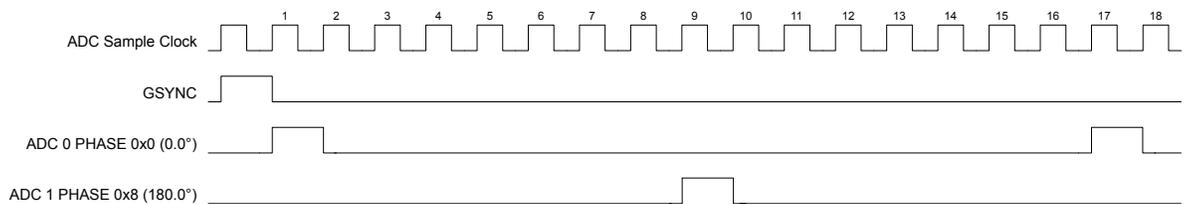
The trigger source for ADC0 and ADC1 may be independent or the two ADC units may operate from the same trigger source and operate on the same or different inputs. If the converters are running at the same sample rate, they may be configured to start the conversions coincidentally or with one of 15 different discrete phases relative to each other. The sample time can be delayed from the standard sampling time in  $22.5^\circ$  increments up to  $337.5^\circ$  using the **ADC Sample Phase Control (ADCSPC)** register. Figure 13-3 on page 512 shows an example of various phase relationships at a 1 Msps rate.

Figure 13-3. ADC Sample Phases



This feature can be used to double the sampling rate of an input. Both ADC module 0 and ADC module 1 can be programmed to sample the same input. ADC module 0 could sample at the standard position (the `PHASE` field in the `ADCSPC` register is `0x0`). ADC module 1 can be configured to sample at 180° (`PHASE = 0x8`). The two modules can be synchronized using the `GSYNC` and `SYNCWAIT` bits in the **ADC Processor Sample Sequence Initiate (ADCPSSI)** register. Software could then combine the results from the two modules to create a sample rate of two million samples/second at 16 MHz as shown in Figure 13-4 on page 512.

Figure 13-4. Doubling the ADC Sample Rate

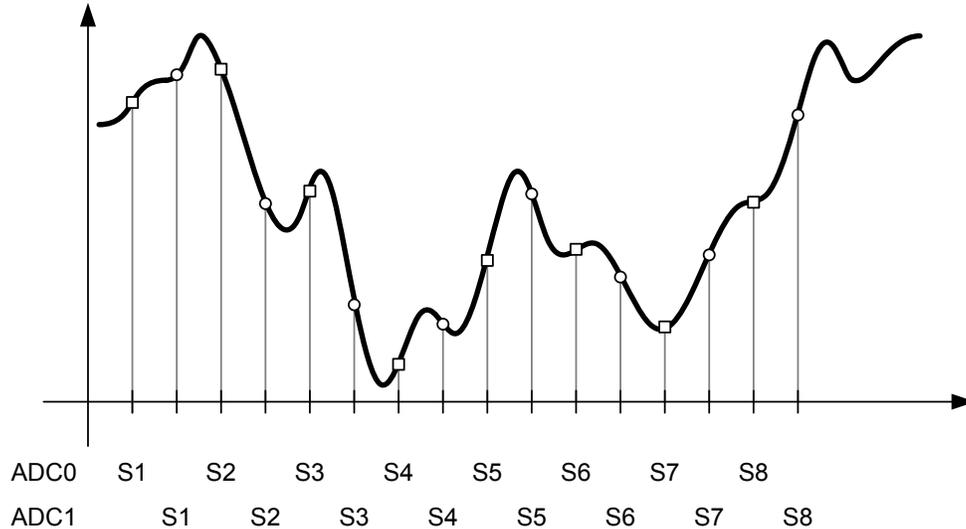


Using the `ADCSPC` register, ADC0 and ADC1 may provide a number of interesting applications:

- Coincident sampling of different signals. The sample sequence steps run coincidentally in both converters.
  - ADC Module 0, `ADCSPC = 0x0`, sampling `AIN0`
  - ADC Module 1, `ADCSPC = 0x0`, sampling `AIN1`
- Skewed sampling of the same signal. The sample sequence steps are 1/2 of an ADC clock (500  $\mu$ s for a 1Ms/s ADC) out of phase with each other. This configuration doubles the conversion bandwidth of a single input when software combines the results as shown in Figure 13-5 on page 513.
  - ADC Module 0, `ADCSPC = 0x0`, sampling `AIN0`
  - ADC Module 1, `ADCSPC = 0x8`, sampling `AIN0`



Figure 13-5. Skewed Sampling



### 13.3.2.6 External Voltage Reference

An external reference voltage may be provided to serve as the ADC voltage bias. The  $V_{REF}$  bit in the **ADC Control (ADCCTL)** register specifies whether to use the internal or external reference. The ADC conversion value saturates to 0x3FF at the external voltage reference value. The  $V_{REFA}$  specification defines the useful range for the external voltage reference, see Table 27-25 on page 1219. Ground is always used as the reference level for the minimum conversion value. Care must be taken to supply a reference voltage of acceptable quality.

### 13.3.3 Hardware Sample Averaging Circuit

Higher precision results can be generated using the hardware averaging circuit, however, the improved results are at the cost of throughput. Up to 64 samples can be accumulated and averaged to form a single data entry in the sequencer FIFO. Throughput is decreased proportionally to the number of samples in the averaging calculation. For example, if the averaging circuit is configured to average 16 samples, the throughput is decreased by a factor of 16.

By default the averaging circuit is off, and all data from the converter passes through to the sequencer FIFO. The averaging hardware is controlled by the **ADC Sample Averaging Control (ADCSAC)** register (see page 548). A single averaging circuit has been implemented, thus all input channels receive the same amount of averaging whether they are single-ended or differential.

### 13.3.4 Analog-to-Digital Converter

The Analog-to-Digital Converter (ADC) module uses a Successive Approximation Register (SAR) architecture to deliver a 10-bit, low-power, high-precision conversion value. The successive-approximation algorithm uses a current mode D/A converter to achieve lower settling time, resulting in higher conversion speeds for the A/D converter. In addition, built-in sample-and-hold circuitry with offset-calibration circuitry improves conversion accuracy. The ADC must be run from the PLL or a 14- to 18-MHz clock source.

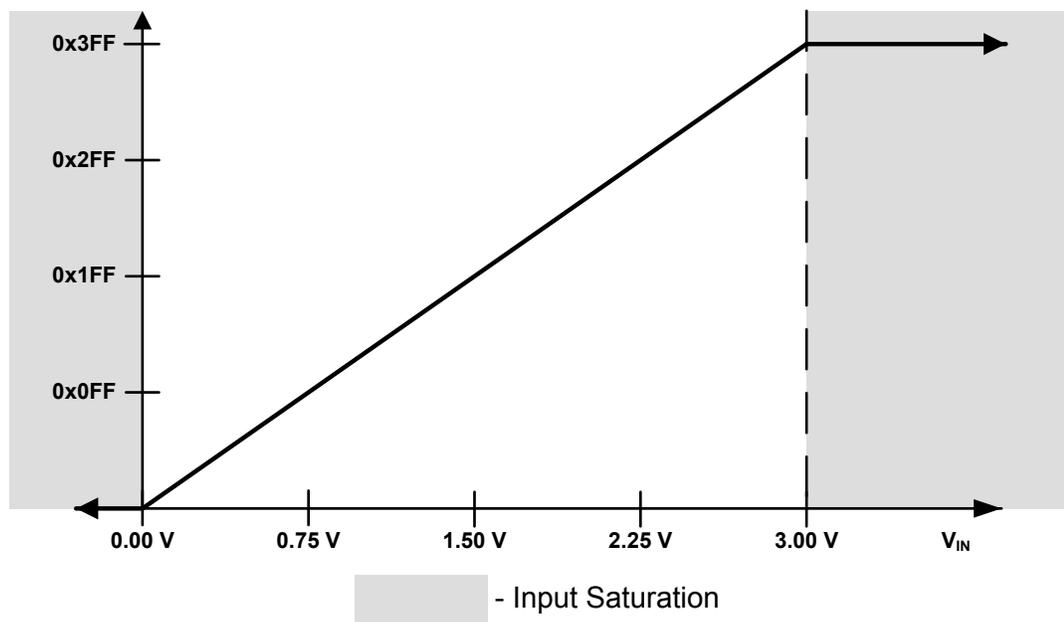
The ADC operates from both the 3.3-V analog and 1.2-V digital power supplies. Integrated shutdown modes are available to reduce power consumption when ADC conversions are not required. The analog inputs are connected to the ADC through custom pads and specially balanced input paths

to minimize the distortion on the inputs. Detailed information on the ADC power supplies and analog inputs can be found in “Analog-to-Digital Converter” on page 1218.

#### 13.3.4.1 Internal Voltage Reference

The band-gap circuitry generates an internal 3.0 V reference that can be used by the ADC to produce a conversion value from the selected analog input. The range of this conversion value is from 0x000 to 0x3FF. In single-ended-input mode, the 0x000 value corresponds to an analog input voltage of 0.0 V; the 0x3FF value corresponds to an analog input voltage of 3.0 V. This configuration results in a resolution of approximately 2.9 mV per ADC code. While the analog input pads can handle voltages beyond this range, the ADC conversions saturate in under-voltage and over-voltage cases. Figure 13-6 on page 514 shows the ADC conversion function of the analog inputs.

**Figure 13-6. Internal Voltage Conversion Result**

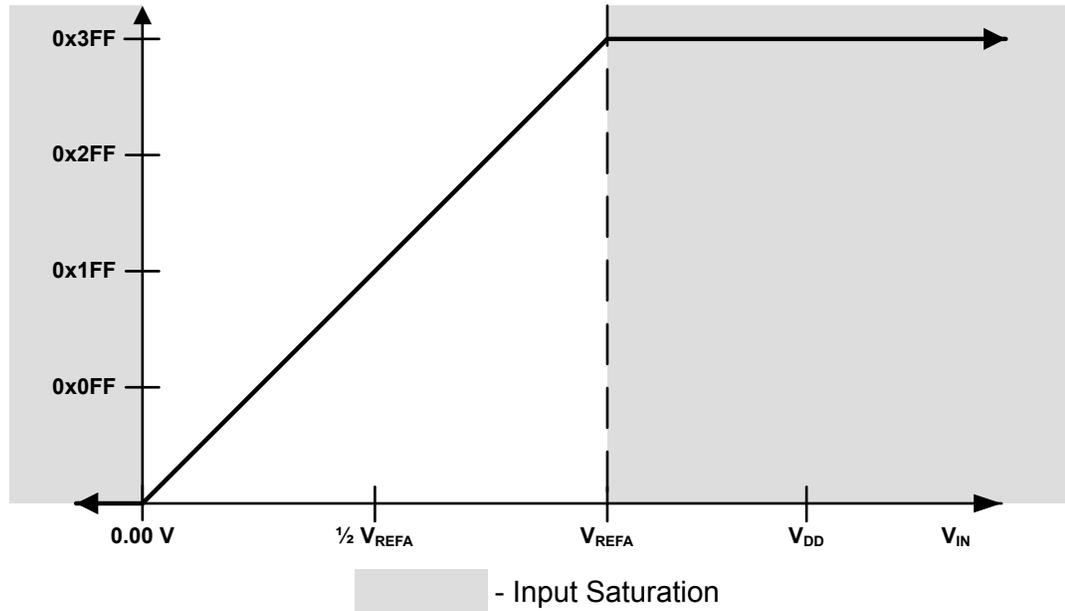


#### 13.3.4.2 External Voltage Reference

The ADC can use an external voltage reference to produce the conversion value from the selected analog input by setting the  $V_{REF}$  bit in the **ADC Control (ADCCTL)** register. The  $V_{REF}$  bit specifies whether to use the internal or external reference. While the range of the conversion value remains the same (0x000 to 0x3FF), the analog voltage associated with the 0x3FF value corresponds to the value of the external voltage reference when using the 3.0-V setting and three times the external voltage reference when using the 1.0-V setting, resulting in a smaller voltage resolution per ADC code. Analog input voltages above the external voltage reference saturate to 0x3FF while those below 0.0 V continue to saturate at 0x000. Figure 13-7 on page 515 shows the ADC conversion function of the analog inputs when using an external voltage reference.

The external voltage reference can be more accurate than the internal reference by using a high-precision source or trimming the source.

Figure 13-7. External Voltage Conversion Result



### 13.3.5 Differential Sampling

In addition to traditional single-ended sampling, the ADC module supports differential sampling of two analog input channels. To enable differential sampling, software must set the  $D_n$  bit in the **ADCSSCTL0n** register in a step's configuration nibble.

When a sequence step is configured for differential sampling, the input pair to sample must be configured in the **ADCSSMUXn** register. Differential pair 0 samples analog inputs 0 and 1; differential pair 1 samples analog inputs 2 and 3; and so on (see Table 13-4 on page 515). The ADC does not support other differential pairings such as analog input 0 with analog input 3.

**Table 13-4. Differential Sampling Pairs**

Differential Pair	Analog Inputs
0	0 and 1
1	2 and 3
2	4 and 5
3	6 and 7
4	8 and 9
5	10 and 11
6	12 and 13
7	14 and 15

The voltage sampled in differential mode is the difference between the odd and even channels:

$$\Delta V \text{ (differential voltage)} = V_{IN\_EVEN} \text{ (even channel)} - V_{IN\_ODD} \text{ (odd channel)}, \text{ therefore:}$$

- If  $\Delta V = 0$ , then the conversion result = 0x1FF

- If  $\Delta V > 0$ , then the conversion result  $> 0x1FF$  (range is  $0x1FF-0x3FF$ )
- If  $\Delta V < 0$ , then the conversion result  $< 0x1FF$  (range is  $0-0x1FF$ )

The differential pairs assign polarities to the analog inputs: the even-numbered input is always positive, and the odd-numbered input is always negative. In order for a valid conversion result to appear, the negative input must be in the range of  $\pm 1.5$  V of the positive input. If an analog input is greater than 3 V or less than 0 V (the valid range for analog inputs), the input voltage is clipped, meaning it appears as either 3 V or 0 V, respectively, to the ADC.

Figure 13-8 on page 516 shows an example of the negative input centered at 1.5 V. In this configuration, the differential range spans from -1.5 V to 1.5 V. Figure 13-9 on page 517 shows an example where the negative input is centered at -0.75 V, meaning inputs on the positive input saturate past a differential voltage of -0.75 V since the input voltage is less than 0 V. Figure 13-10 on page 517 shows an example of the negative input centered at 2.25 V, where inputs on the positive channel saturate past a differential voltage of 0.75 V since the input voltage would be greater than 3 V.

**Figure 13-8. Differential Sampling Range,  $V_{IN\_ODD} = 1.5$  V**

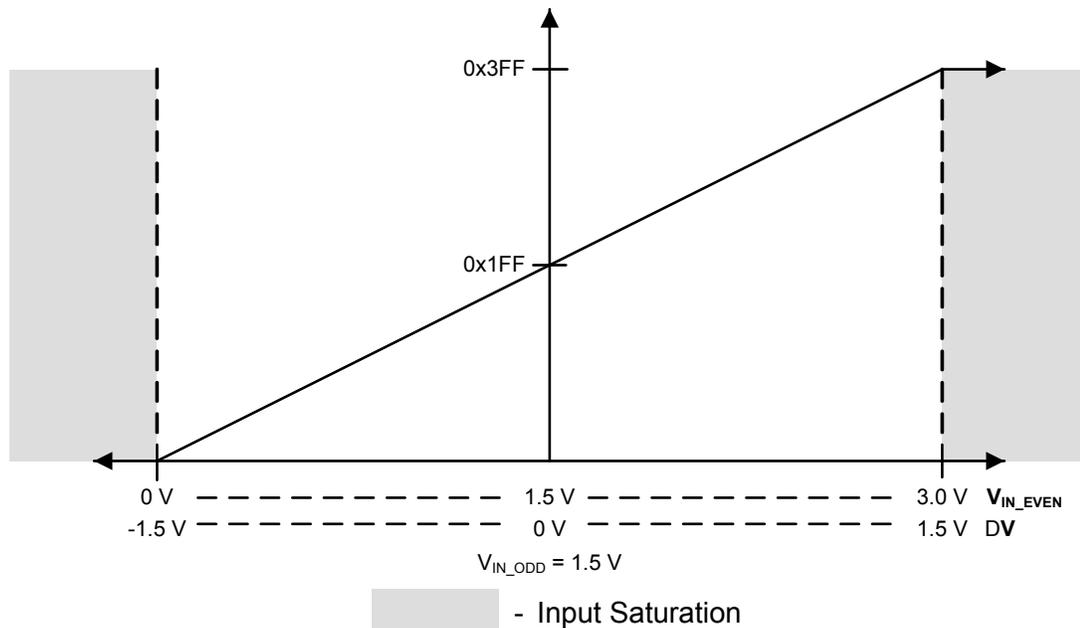


Figure 13-9. Differential Sampling Range,  $V_{IN\_ODD} = 0.75\text{ V}$

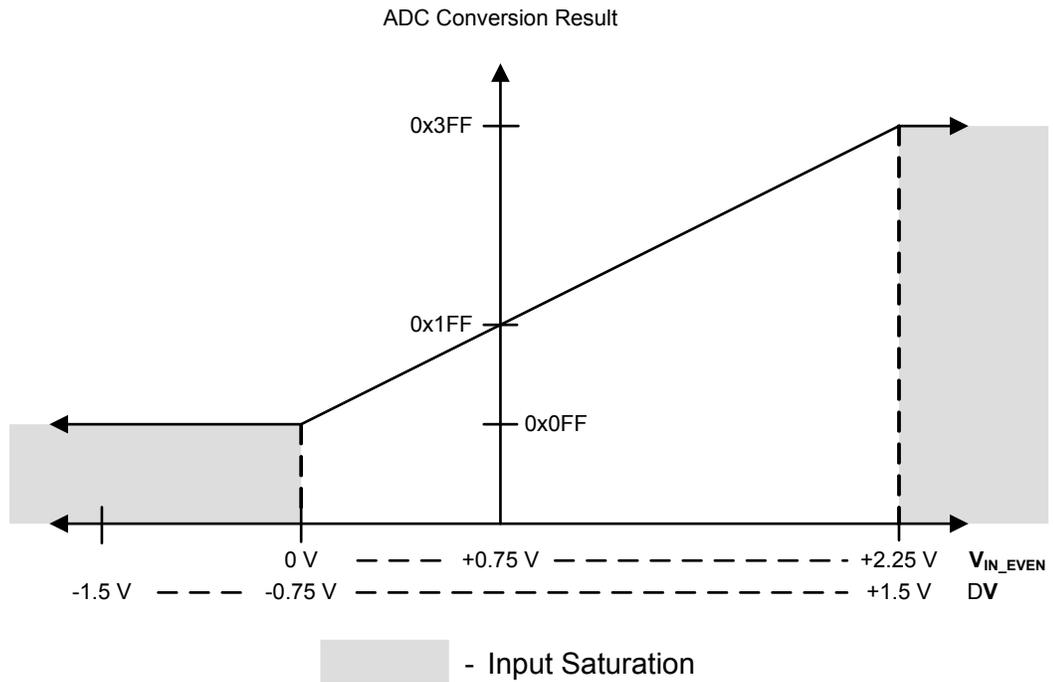
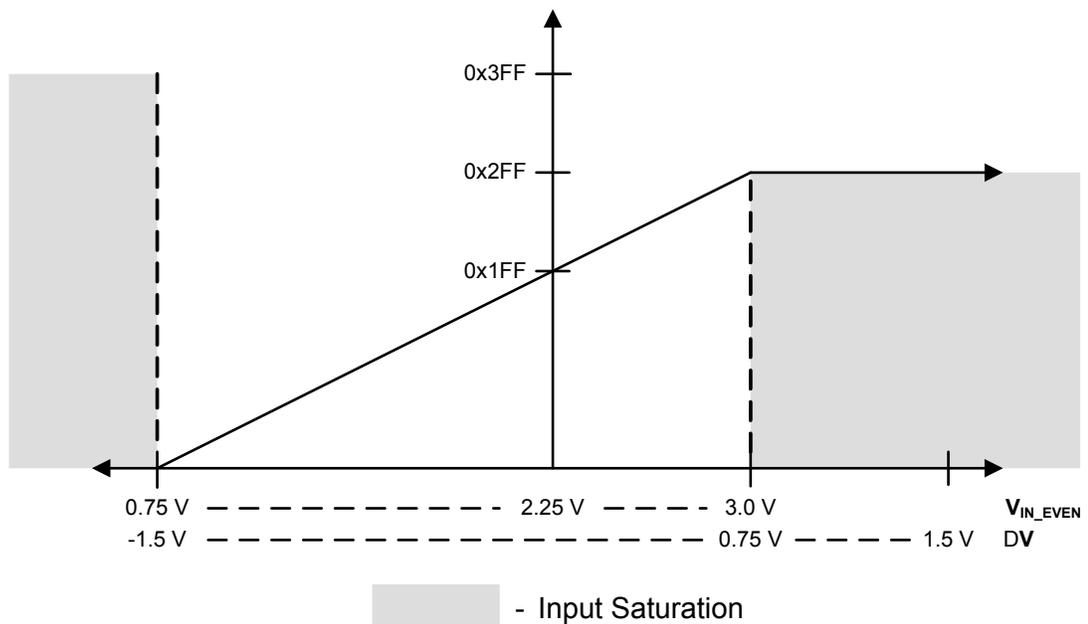


Figure 13-10. Differential Sampling Range,  $V_{IN\_ODD} = 2.25\text{ V}$



### 13.3.6 Internal Temperature Sensor

The temperature sensor's primary purpose is to notify the system that the internal temperature is too high or low for reliable operation.

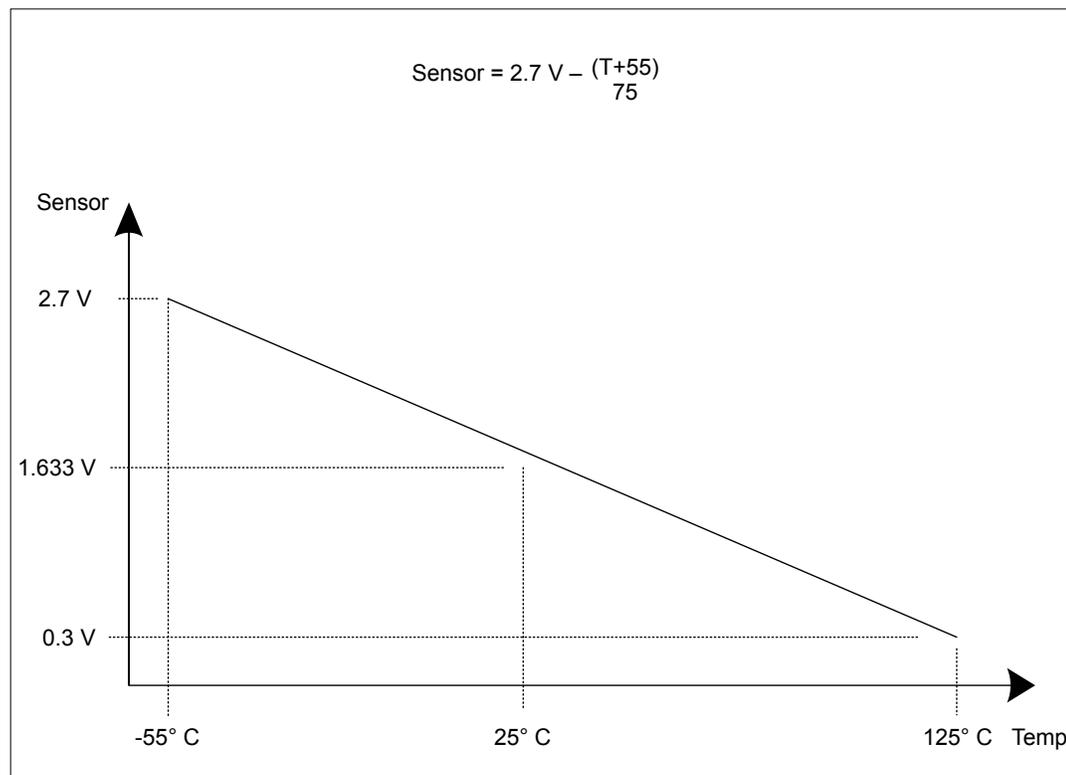
The temperature sensor does not have a separate enable, because it also contains the bandgap reference and must always be enabled. The reference is supplied to other analog modules; not just the ADC.

The internal temperature sensor provides an analog temperature reading as well as a reference voltage. The voltage at the output terminal *SENSO* is given by the following equation:

$$SENSO = 2.7 - ((T + 55) / 75)$$

This relation is shown in Figure 13-11 on page 518.

**Figure 13-11. Internal Temperature Sensor Characteristic**



The temperature reading from the temperature sensor can also be given as a function of the ADC value. The following formula calculates temperature (in °C) based on the ADC reading:

$$\text{Temperature} = 147.5 - ((225 \times \text{ADC}) / 1023)$$

### 13.3.7 Digital Comparator Unit

An ADC is commonly used to sample an external signal and to monitor its value to ensure that it remains in a given range. To automate this monitoring procedure and reduce the amount of processor overhead that is required, digital comparators are provided. Conversions from the ADC that are sent to the digital comparators are compared against the user programmable limits in the **ADC Digital Comparator Range (ADCDCMPn)** registers. If the observed signal moves out of the acceptable range, a processor interrupt can be generated and/or a trigger can be sent to the PWM module.

The digital comparators four operational modes (Once, Always, Hysteresis Once, Hysteresis Always) can be applied to three separate regions (low band, mid band, high band) as defined by the user.

### 13.3.7.1 Output Functions

ADC conversions can either be stored in the ADC Sample Sequence FIFOs or compared using the digital comparator resources as defined by the  $S_nDCOP$  bits in the **ADC Sample Sequence n Operation (ADCSSOPn)** register. These selected ADC conversions are used by their respective digital comparator to monitor the external signal. Each comparator has two possible output functions: processor interrupts and triggers.

Each function has its own state machine to track the monitored signal. Even though the interrupt and trigger functions can be enabled individually or both at the same time, the same conversion data is used by each function to determine if the right conditions have been met to assert the associated output.

#### *Interrupts*

The digital comparator interrupt function is enabled by setting the  $CIE$  bit in the **ADC Digital Comparator Control (ADCDCCTLn)** register. This bit enables the interrupt function state machine to start monitoring the incoming ADC conversions. When the appropriate set of conditions is met, and the  $DCONSS_x$  bit is set in the **ADCIM** register, an interrupt is sent to the interrupt controller.

#### *Triggers*

The digital comparator trigger function is enabled by setting the  $CTE$  bit in the **ADCDCCTLn** register. This bit enables the trigger function state machine to start monitoring the incoming ADC conversions. When the appropriate set of conditions is met, the corresponding digital comparator trigger to the PWM module is asserted.

### 13.3.7.2 Operational Modes

Four operational modes are provided to support a broad range of applications and multiple possible signaling requirements: Always, Once, Hysteresis Always, and Hysteresis Once. The operational mode is selected using the  $CIM$  or  $CTM$  field in the **ADCDCCTLn** register.

#### *Always Mode*

In the Always operational mode, the associated interrupt or trigger is asserted whenever the ADC conversion value meets its comparison criteria. The result is a string of assertions on the interrupt or trigger while the conversions are within the appropriate range.

#### *Once Mode*

In the Once operational mode, the associated interrupt or trigger is asserted whenever the ADC conversion value meets its comparison criteria, and the previous ADC conversion value did not. The result is a single assertion of the interrupt or trigger when the conversions are within the appropriate range.

#### *Hysteresis-Always Mode*

The Hysteresis-Always operational mode can only be used in conjunction with the low-band or high-band regions because the mid-band region must be crossed and the opposite region entered to clear the hysteresis condition. In the Hysteresis-Always mode, the associated interrupt or trigger is asserted in the following cases: 1) the ADC conversion value meets its comparison criteria or 2) a previous ADC conversion value has met the comparison criteria, and the hysteresis condition has

not been cleared by entering the opposite region. The result is a string of assertions on the interrupt or trigger that continue until the opposite region is entered.

#### **Hysteresis-Once Mode**

The Hysteresis-Once operational mode can only be used in conjunction with the low-band or high-band regions because the mid-band region must be crossed and the opposite region entered to clear the hysteresis condition. In the Hysteresis-Once mode, the associated interrupt or trigger is asserted only when the ADC conversion value meets its comparison criteria, the hysteresis condition is clear, and the previous ADC conversion did not meet the comparison criteria. The result is a single assertion on the interrupt or trigger.

### **13.3.7.3 Function Ranges**

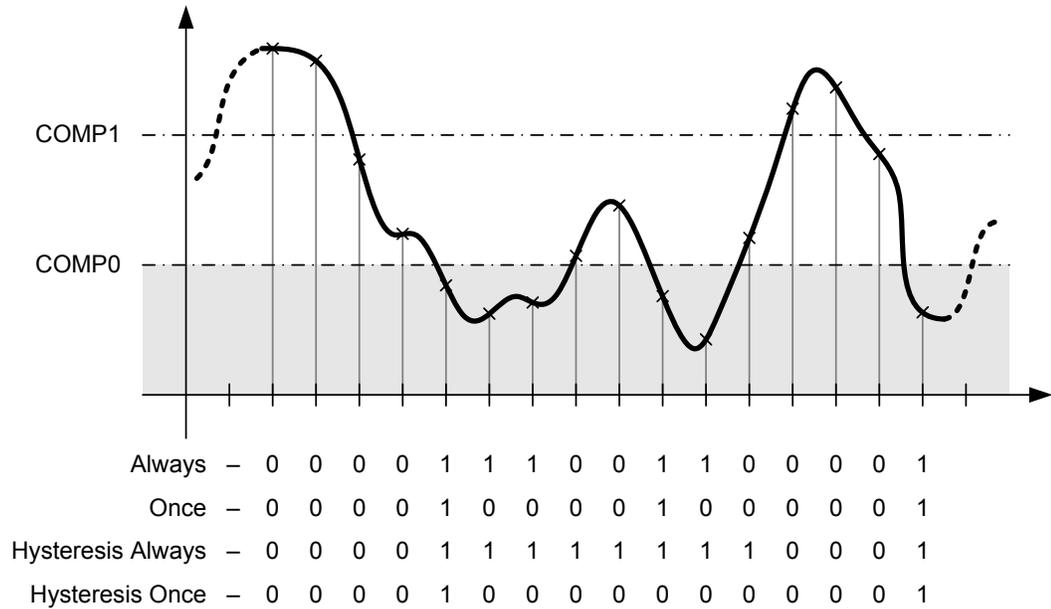
The two comparison values, `COMP0` and `COMP1`, in the **ADC Digital Comparator Range (ADCDCMPn)** register effectively break the conversion area into three distinct regions. These regions are referred to as the low-band (less than or equal to `COMP0`), mid-band (greater than `COMP0` but less than or equal to `COMP1`), and high-band (greater than `COMP1`) regions. `COMP0` and `COMP1` may be programmed to the same value, effectively creating two regions, but `COMP1` must always be greater than or equal to the value of `COMP0`. A `COMP1` value that is less than `COMP0` generates unpredictable results.

#### **Low-Band Operation**

To operate in the low-band region, either the `CIC` field or the `CTC` field in the **ADCDCCTLn** register must be programmed to `0x0`. This setting causes interrupts or triggers to be generated in the low-band region as defined by the programmed operational mode. An example of the state of the interrupt/trigger signal in the low-band region for each of the operational modes is shown in Figure 13-12 on page 521. Note that a "0" in a column following the operational mode name (Always, Once, Hysteresis Always, and Hysteresis Once) indicates that the interrupt or trigger signal is de-asserted and a "1" indicates that the signal is asserted.



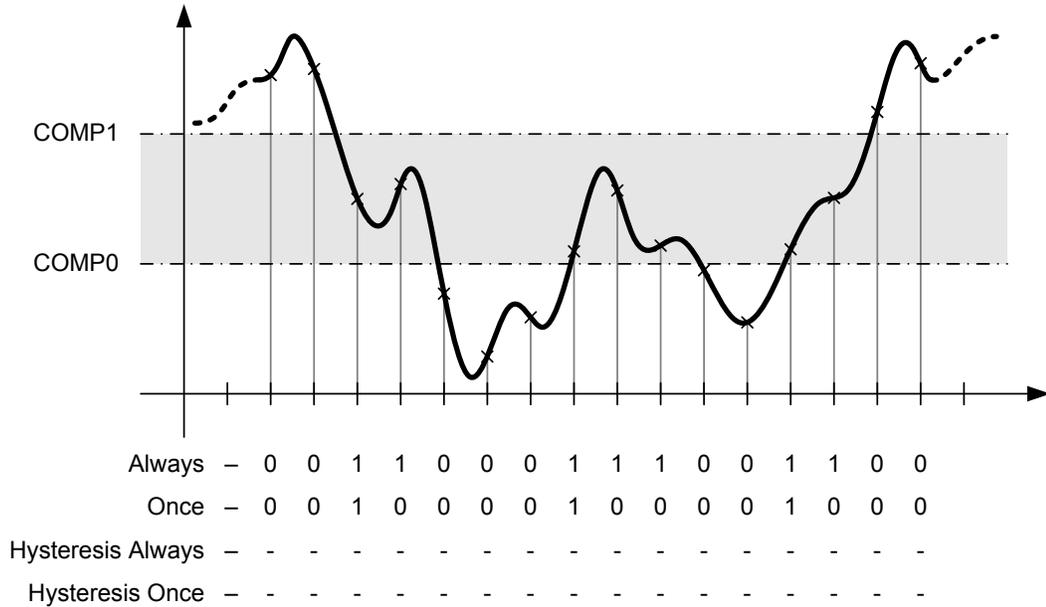
Figure 13-12. Low-Band Operation (CIC=0x0 and/or CTC=0x0)



### Mid-Band Operation

To operate in the mid-band region, either the `CIC` field or the `CTC` field in the `ADCDCCTLn` register must be programmed to `0x1`. This setting causes interrupts or triggers to be generated in the mid-band region according the operation mode. Only the Always and Once operational modes are available in the mid-band region. An example of the state of the interrupt/trigger signal in the mid-band region for each of the allowed operational modes is shown in Figure 13-13 on page 522. Note that a "0" in a column following the operational mode name (Always or Once) indicates that the interrupt or trigger signal is de-asserted and a "1" indicates that the signal is asserted.

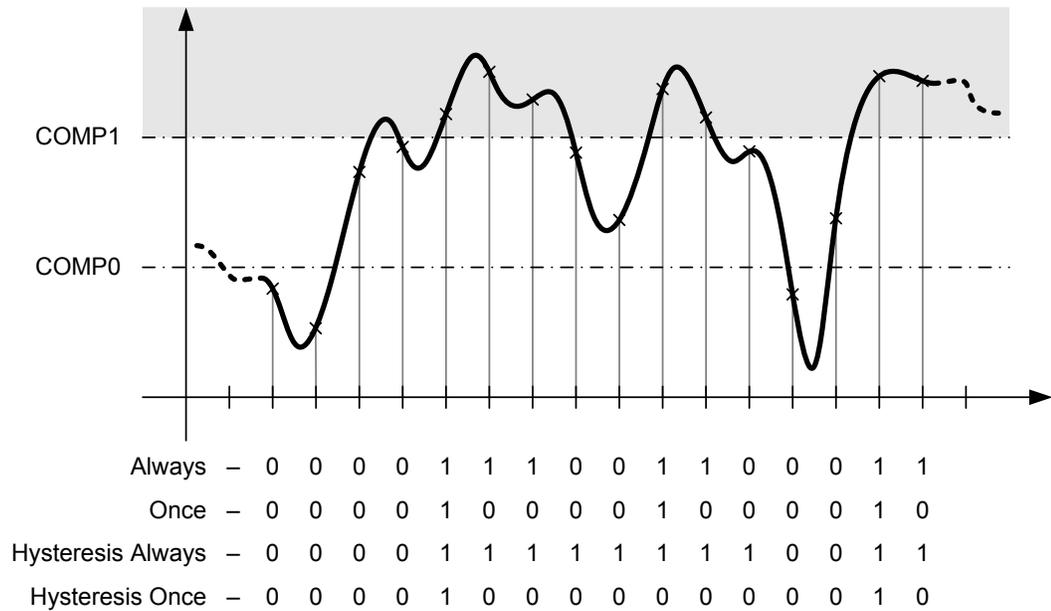
Figure 13-13. Mid-Band Operation (CIC=0x1 and/or CTC=0x1)



**High-Band Operation**

To operate in the high-band region, either the `CIC` field or the `CTC` field in the `ADCDCCTLn` register must be programmed to 0x3. This setting causes interrupts or triggers to be generated in the high-band region according the operation mode. An example of the state of the interrupt/trigger signal in the high-band region for each of the allowed operational modes is shown in Figure 13-14 on page 523. Note that a "0" in a column following the operational mode name (Always, Once, Hysteresis Always, and Hysteresis Once) indicates that the interrupt or trigger signal is de-asserted and a "1" indicates that the signal is asserted.

Figure 13-14. High-Band Operation (CIC=0x3 and/or CTC=0x3)



## 13.4 Initialization and Configuration

In order for the ADC module to be used, the PLL must be enabled and programmed to a supported crystal frequency in the **RCC** register (see page 129). Using unsupported frequencies can cause faulty operation in the ADC module.

### 13.4.1 Module Initialization

Initialization of the ADC module is a simple process with very few steps: enabling the clock to the ADC, disabling the analog isolation circuit associated with all inputs that are to be used, and reconfiguring the sample sequencer priorities (if needed).

The initialization sequence for the ADC is as follows:

1. Enable the ADC clock by writing a value of 0x0001.0000 to the **RCGC0** register (see page 173).
2. Enable the clock to the appropriate GPIO module via the **RCGC2** register (see page 193). To find out which GPIO port to enable, refer to Table 25-5 on page 1160.
3. Set the GPIO **AFSEL** bits for the ADC input pins (see page 328). To determine which GPIOs to configure, see Table 25-4 on page 1151.
4. Configure the **PMCn** fields in the **GPIOPCTL** register to assign the **AINx** and **VREFA** signals to the appropriate pins (see page 346 and Table 25-5 on page 1160).
5. Disable the analog isolation circuit for all ADC input pins that are to be used by writing a 1 to the appropriate bits of the **GPIOAMSEL** register (see page 344) in the associated GPIO block.

6. If required by the application, reconfigure the sample sequencer priorities in the **ADCSSPRI** register. The default configuration has Sample Sequencer 0 with the highest priority and Sample Sequencer 3 as the lowest priority.

### 13.4.2 Sample Sequencer Configuration

Configuration of the sample sequencers is slightly more complex than the module initialization because each sample sequencer is completely programmable.

The configuration for each sample sequencer should be as follows:

1. Ensure that the sample sequencer is disabled by clearing the corresponding **ASEN<sub>n</sub>** bit in the **ADCACTSS** register. Programming of the sample sequencers is allowed without having them enabled. Disabling the sequencer during programming prevents erroneous execution if a trigger event were to occur during the configuration process.
2. Configure the trigger event for the sample sequencer in the **ADCEMUX** register.
3. For each sample in the sample sequence, configure the corresponding input source in the **ADCSSMUX<sub>n</sub>** register.
4. For each sample in the sample sequence, configure the sample control bits in the corresponding nibble in the **ADCSSCTL<sub>n</sub>** register. When programming the last nibble, ensure that the **END** bit is set. Failure to set the **END** bit causes unpredictable behavior.
5. If interrupts are to be used, set the corresponding **MASK** bit in the **ADCIM** register.
6. Enable the sample sequencer logic by setting the corresponding **ASEN<sub>n</sub>** bit in the **ADCACTSS** register.

## 13.5 Register Map

Table 13-5 on page 524 lists the ADC registers. The offset listed is a hexadecimal increment to the register's address, relative to that ADC module's base address of:

- ADC0: 0x4003.8000
- ADC1: 0x4003.9000

Note that the ADC module clock must be enabled before the registers can be programmed (see page 173).

**Table 13-5. ADC Register Map**

Offset	Name	Type	Reset	Description	See page
0x000	ADCACTSS	R/W	0x0000.0000	ADC Active Sample Sequencer	527
0x004	ADCRIS	RO	0x0000.0000	ADC Raw Interrupt Status	528
0x008	ADCIM	R/W	0x0000.0000	ADC Interrupt Mask	530
0x00C	ADCISC	R/W1C	0x0000.0000	ADC Interrupt Status and Clear	532
0x010	ADCOSTAT	R/W1C	0x0000.0000	ADC Overflow Status	535
0x014	ADCEMUX	R/W	0x0000.0000	ADC Event Multiplexer Select	537

Table 13-5. ADC Register Map (continued)

Offset	Name	Type	Reset	Description	See page
0x018	ADCUSTAT	R/W1C	0x0000.0000	ADC Underflow Status	542
0x020	ADCSSPRI	R/W	0x0000.3210	ADC Sample Sequencer Priority	543
0x024	ADCSPC	R/W	0x0000.0000	ADC Sample Phase Control	545
0x028	ADCPSSI	R/W	-	ADC Processor Sample Sequence Initiate	546
0x030	ADCACSAC	R/W	0x0000.0000	ADC Sample Averaging Control	548
0x034	ADCDCISC	R/W1C	0x0000.0000	ADC Digital Comparator Interrupt Status and Clear	549
0x038	ADCCTL	R/W	0x0000.0000	ADC Control	551
0x040	ADCSSMUX0	R/W	0x0000.0000	ADC Sample Sequence Input Multiplexer Select 0	552
0x044	ADCSSCTL0	R/W	0x0000.0000	ADC Sample Sequence Control 0	554
0x048	ADCSSFIFO0	RO	-	ADC Sample Sequence Result FIFO 0	557
0x04C	ADCSSFSTAT0	RO	0x0000.0100	ADC Sample Sequence FIFO 0 Status	558
0x050	ADCSSOP0	R/W	0x0000.0000	ADC Sample Sequence 0 Operation	560
0x054	ADCSSDC0	R/W	0x0000.0000	ADC Sample Sequence 0 Digital Comparator Select	562
0x060	ADCSSMUX1	R/W	0x0000.0000	ADC Sample Sequence Input Multiplexer Select 1	564
0x064	ADCSSCTL1	R/W	0x0000.0000	ADC Sample Sequence Control 1	565
0x068	ADCSSFIFO1	RO	-	ADC Sample Sequence Result FIFO 1	557
0x06C	ADCSSFSTAT1	RO	0x0000.0100	ADC Sample Sequence FIFO 1 Status	558
0x070	ADCSSOP1	R/W	0x0000.0000	ADC Sample Sequence 1 Operation	567
0x074	ADCSSDC1	R/W	0x0000.0000	ADC Sample Sequence 1 Digital Comparator Select	568
0x080	ADCSSMUX2	R/W	0x0000.0000	ADC Sample Sequence Input Multiplexer Select 2	564
0x084	ADCSSCTL2	R/W	0x0000.0000	ADC Sample Sequence Control 2	565
0x088	ADCSSFIFO2	RO	-	ADC Sample Sequence Result FIFO 2	557
0x08C	ADCSSFSTAT2	RO	0x0000.0100	ADC Sample Sequence FIFO 2 Status	558
0x090	ADCSSOP2	R/W	0x0000.0000	ADC Sample Sequence 2 Operation	567
0x094	ADCSSDC2	R/W	0x0000.0000	ADC Sample Sequence 2 Digital Comparator Select	568
0x0A0	ADCSSMUX3	R/W	0x0000.0000	ADC Sample Sequence Input Multiplexer Select 3	570
0x0A4	ADCSSCTL3	R/W	0x0000.0002	ADC Sample Sequence Control 3	571
0x0A8	ADCSSFIFO3	RO	-	ADC Sample Sequence Result FIFO 3	557
0x0AC	ADCSSFSTAT3	RO	0x0000.0100	ADC Sample Sequence FIFO 3 Status	558
0x0B0	ADCSSOP3	R/W	0x0000.0000	ADC Sample Sequence 3 Operation	572
0x0B4	ADCSSDC3	R/W	0x0000.0000	ADC Sample Sequence 3 Digital Comparator Select	573
0xD00	ADCDCRIC	R/W	0x0000.0000	ADC Digital Comparator Reset Initial Conditions	574

Table 13-5. ADC Register Map (continued)

Offset	Name	Type	Reset	Description	See page
0xE00	ADCDCCTL0	R/W	0x0000.0000	ADC Digital Comparator Control 0	579
0xE04	ADCDCCTL1	R/W	0x0000.0000	ADC Digital Comparator Control 1	579
0xE08	ADCDCCTL2	R/W	0x0000.0000	ADC Digital Comparator Control 2	579
0xE0C	ADCDCCTL3	R/W	0x0000.0000	ADC Digital Comparator Control 3	579
0xE10	ADCDCCTL4	R/W	0x0000.0000	ADC Digital Comparator Control 4	579
0xE14	ADCDCCTL5	R/W	0x0000.0000	ADC Digital Comparator Control 5	579
0xE18	ADCDCCTL6	R/W	0x0000.0000	ADC Digital Comparator Control 6	579
0xE1C	ADCDCCTL7	R/W	0x0000.0000	ADC Digital Comparator Control 7	579
0xE40	ADCDCCMP0	R/W	0x0000.0000	ADC Digital Comparator Range 0	583
0xE44	ADCDCCMP1	R/W	0x0000.0000	ADC Digital Comparator Range 1	583
0xE48	ADCDCCMP2	R/W	0x0000.0000	ADC Digital Comparator Range 2	583
0xE4C	ADCDCCMP3	R/W	0x0000.0000	ADC Digital Comparator Range 3	583
0xE50	ADCDCCMP4	R/W	0x0000.0000	ADC Digital Comparator Range 4	583
0xE54	ADCDCCMP5	R/W	0x0000.0000	ADC Digital Comparator Range 5	583
0xE58	ADCDCCMP6	R/W	0x0000.0000	ADC Digital Comparator Range 6	583
0xE5C	ADCDCCMP7	R/W	0x0000.0000	ADC Digital Comparator Range 7	583

## 13.6 Register Descriptions

The remainder of this section lists and describes the ADC registers, in numerical order by address offset.

**Register 1: ADC Active Sample Sequencer (ADCACTSS), offset 0x000**

This register controls the activation of the sample sequencers. Each sample sequencer can be enabled or disabled independently.

**ADC Active Sample Sequencer (ADCACTSS)**

ADC0 base: 0x4003.8000

ADC1 base: 0x4003.9000

Offset 0x000

Type R/W, reset 0x0000.0000

	31	30	29	28	27	26	25	24	23	22	21	20	19	18	17	16	
	reserved																
Type	RO	RO	RO	RO	RO	RO	RO	RO	RO	RO	RO	RO	RO	RO	RO	RO	
Reset	0	0	0	0	0	0	0	0	0	0	0	0	0	0	0	0	
	15	14	13	12	11	10	9	8	7	6	5	4	3	2	1	0	
	reserved												ASEN3	ASEN2	ASEN1	ASEN0	
Type	RO	RO	RO	RO	RO	RO	RO	RO	RO	RO	RO	RO	RO	R/W	R/W	R/W	R/W
Reset	0	0	0	0	0	0	0	0	0	0	0	0	0	0	0	0	0

Bit/Field	Name	Type	Reset	Description
31:4	reserved	RO	0x0000.000	Software should not rely on the value of a reserved bit. To provide compatibility with future products, the value of a reserved bit should be preserved across a read-modify-write operation.
3	ASEN3	R/W	0	ADC SS3 Enable  Value Description 1 Sample Sequencer 3 is enabled. 0 Sample Sequencer 3 is disabled.
2	ASEN2	R/W	0	ADC SS2 Enable  Value Description 1 Sample Sequencer 2 is enabled. 0 Sample Sequencer 2 is disabled.
1	ASEN1	R/W	0	ADC SS1 Enable  Value Description 1 Sample Sequencer 1 is enabled. 0 Sample Sequencer 1 is disabled.
0	ASEN0	R/W	0	ADC SS0 Enable  Value Description 1 Sample Sequencer 0 is enabled. 0 Sample Sequencer 0 is disabled.

## Register 2: ADC Raw Interrupt Status (ADCRIS), offset 0x004

This register shows the status of the raw interrupt signal of each sample sequencer. These bits may be polled by software to look for interrupt conditions without sending the interrupts to the interrupt controller.

### ADC Raw Interrupt Status (ADCRIS)

ADC0 base: 0x4003.8000  
 ADC1 base: 0x4003.9000  
 Offset 0x004  
 Type RO, reset 0x0000.0000

	31	30	29	28	27	26	25	24	23	22	21	20	19	18	17	16
	reserved															INRDC
Type	RO	RO	RO	RO	RO	RO	RO	RO	RO	RO	RO	RO	RO	RO	RO	RO
Reset	0	0	0	0	0	0	0	0	0	0	0	0	0	0	0	0
	15	14	13	12	11	10	9	8	7	6	5	4	3	2	1	0
	reserved												INR3	INR2	INR1	INR0
Type	RO	RO	RO	RO	RO	RO	RO	RO	RO	RO	RO	RO	RO	RO	RO	RO
Reset	0	0	0	0	0	0	0	0	0	0	0	0	0	0	0	0

Bit/Field	Name	Type	Reset	Description
31:17	reserved	RO	0x000	Software should not rely on the value of a reserved bit. To provide compatibility with future products, the value of a reserved bit should be preserved across a read-modify-write operation.
16	INRDC	RO	0	Digital Comparator Raw Interrupt Status  Value Description 1 At least one bit in the <b>ADCDCISC</b> register is set, meaning that a digital comparator interrupt has occurred. 0 All bits in the <b>ADCDCISC</b> register are clear.
15:4	reserved	RO	0x000	Software should not rely on the value of a reserved bit. To provide compatibility with future products, the value of a reserved bit should be preserved across a read-modify-write operation.
3	INR3	RO	0	SS3 Raw Interrupt Status  Value Description 1 A sample has completed conversion and the respective <b>ADCSSCTL3 IEn</b> bit is set, enabling a raw interrupt. 0 An interrupt has not occurred.  This bit is cleared by writing a 1 to the <b>IN3</b> bit in the <b>ADCISC</b> register.
2	INR2	RO	0	SS2 Raw Interrupt Status  Value Description 1 A sample has completed conversion and the respective <b>ADCSSCTL2 IEn</b> bit is set, enabling a raw interrupt. 0 An interrupt has not occurred.  This bit is cleared by writing a 1 to the <b>IN2</b> bit in the <b>ADCISC</b> register.



Bit/Field	Name	Type	Reset	Description
1	INR1	RO	0	<p>SS1 Raw Interrupt Status</p> <p>Value Description</p> <p>1 A sample has completed conversion and the respective <b>ADCSSCTL1</b> <math>I_{En}</math> bit is set, enabling a raw interrupt.</p> <p>0 An interrupt has not occurred.</p> <p>This bit is cleared by writing a 1 to the <math>IN1</math> bit in the <b>ADCISC</b> register.</p>
0	INR0	RO	0	<p>SS0 Raw Interrupt Status</p> <p>Value Description</p> <p>1 A sample has completed conversion and the respective <b>ADCSSCTL0</b> <math>I_{En}</math> bit is set, enabling a raw interrupt.</p> <p>0 An interrupt has not occurred.</p> <p>This bit is cleared by writing a 1 to the <math>IN0</math> bit in the <b>ADCISC</b> register.</p>

### Register 3: ADC Interrupt Mask (ADCIM), offset 0x008

This register controls whether the sample sequencer and digital comparator raw interrupt signals are sent to the interrupt controller. Each raw interrupt signal can be masked independently. Only a single DCONSS<sub>n</sub> bit should be set at any given time. Setting more than one of these bits results in the INRDC bit from the ADCRIS register being masked, and no interrupt is generated on any of the sample sequencer interrupt lines.

#### ADC Interrupt Mask (ADCIM)

ADC0 base: 0x4003.8000  
 ADC1 base: 0x4003.9000  
 Offset 0x008  
 Type R/W, reset 0x0000.0000

	31	30	29	28	27	26	25	24	23	22	21	20	19	18	17	16
	reserved												DCONSS3	DCONSS2	DCONSS1	DCONSS0
Type	RO	RO	RO	RO	RO	RO	RO	RO	RO	RO	RO	RO	R/W	R/W	R/W	R/W
Reset	0	0	0	0	0	0	0	0	0	0	0	0	0	0	0	0
	15	14	13	12	11	10	9	8	7	6	5	4	3	2	1	0
	reserved												MASK3	MASK2	MASK1	MASK0
Type	RO	RO	RO	RO	RO	RO	RO	RO	RO	RO	RO	RO	R/W	R/W	R/W	R/W
Reset	0	0	0	0	0	0	0	0	0	0	0	0	0	0	0	0

Bit/Field	Name	Type	Reset	Description
31:20	reserved	RO	0x000	Software should not rely on the value of a reserved bit. To provide compatibility with future products, the value of a reserved bit should be preserved across a read-modify-write operation.
19	DCONSS3	R/W	0	Digital Comparator Interrupt on SS3  Value Description 1 The raw interrupt signal from the digital comparators (INRDC bit in the ADCRIS register) is sent to the interrupt controller on the SS3 interrupt line. 0 The status of the digital comparators does not affect the SS3 interrupt status.
18	DCONSS2	R/W	0	Digital Comparator Interrupt on SS2  Value Description 1 The raw interrupt signal from the digital comparators (INRDC bit in the ADCRIS register) is sent to the interrupt controller on the SS2 interrupt line. 0 The status of the digital comparators does not affect the SS2 interrupt status.
17	DCONSS1	R/W	0	Digital Comparator Interrupt on SS1  Value Description 1 The raw interrupt signal from the digital comparators (INRDC bit in the ADCRIS register) is sent to the interrupt controller on the SS1 interrupt line. 0 The status of the digital comparators does not affect the SS1 interrupt status.

Bit/Field	Name	Type	Reset	Description
16	DCONSS0	R/W	0	Digital Comparator Interrupt on SS0  Value Description 1 The raw interrupt signal from the digital comparators ( <i>INRDC</i> bit in the <b>ADCRIS</b> register) is sent to the interrupt controller on the SS0 interrupt line. 0 The status of the digital comparators does not affect the SS0 interrupt status.
15:4	reserved	RO	0x000	Software should not rely on the value of a reserved bit. To provide compatibility with future products, the value of a reserved bit should be preserved across a read-modify-write operation.
3	MASK3	R/W	0	SS3 Interrupt Mask  Value Description 1 The raw interrupt signal from Sample Sequencer 3 ( <b>ADCRIS</b> register <i>INR3</i> bit) is sent to the interrupt controller. 0 The status of Sample Sequencer 3 does not affect the SS3 interrupt status.
2	MASK2	R/W	0	SS2 Interrupt Mask  Value Description 1 The raw interrupt signal from Sample Sequencer 2 ( <b>ADCRIS</b> register <i>INR2</i> bit) is sent to the interrupt controller. 0 The status of Sample Sequencer 2 does not affect the SS2 interrupt status.
1	MASK1	R/W	0	SS1 Interrupt Mask  Value Description 1 The raw interrupt signal from Sample Sequencer 1 ( <b>ADCRIS</b> register <i>INR1</i> bit) is sent to the interrupt controller. 0 The status of Sample Sequencer 1 does not affect the SS1 interrupt status.
0	MASK0	R/W	0	SS0 Interrupt Mask  Value Description 1 The raw interrupt signal from Sample Sequencer 0 ( <b>ADCRIS</b> register <i>INR0</i> bit) is sent to the interrupt controller. 0 The status of Sample Sequencer 0 does not affect the SS0 interrupt status.

### Register 4: ADC Interrupt Status and Clear (ADCISC), offset 0x00C

This register provides the mechanism for clearing sample sequencer interrupt conditions and shows the status of interrupts generated by the sample sequencers and the digital comparators which have been sent to the interrupt controller. When read, each bit field is the logical AND of the respective **INR** and **MASK** bits. Sample sequencer interrupts are cleared by writing a 1 to the corresponding bit position. Digital comparator interrupts are cleared by writing a 1 to the appropriate bits in the **ADCDCISC** register. If software is polling the **ADCRIS** instead of generating interrupts, the sample sequence **INR<sub>n</sub>** bits are still cleared via the **ADCISC** register, even if the **IN<sub>n</sub>** bit is not set.

#### ADC Interrupt Status and Clear (ADCISC)

ADC0 base: 0x4003.8000  
 ADC1 base: 0x4003.9000  
 Offset 0x00C  
 Type R/W1C, reset 0x0000.0000

	31	30	29	28	27	26	25	24	23	22	21	20	19	18	17	16
	reserved												DCINSS3	DCINSS2	DCINSS1	DCINSS0
Type	RO	RO	RO	RO	RO	RO	RO	RO	RO	RO	RO	RO	RO	RO	RO	RO
Reset	0	0	0	0	0	0	0	0	0	0	0	0	0	0	0	0
	15	14	13	12	11	10	9	8	7	6	5	4	3	2	1	0
	reserved												IN3	IN2	IN1	IN0
Type	RO	RO	RO	RO	RO	RO	RO	RO	RO	RO	RO	RO	R/W1C	R/W1C	R/W1C	R/W1C
Reset	0	0	0	0	0	0	0	0	0	0	0	0	0	0	0	0

Bit/Field	Name	Type	Reset	Description
31:20	reserved	RO	0x000	Software should not rely on the value of a reserved bit. To provide compatibility with future products, the value of a reserved bit should be preserved across a read-modify-write operation.
19	DCINSS3	RO	0	Digital Comparator Interrupt Status on SS3  Value Description 1 Both the <b>INRDC</b> bit in the <b>ADCRIS</b> register and the <b>DCONSS3</b> bit in the <b>ADCIM</b> register are set, providing a level-base interrupt to the interrupt controller. 0 No interrupt has occurred or the interrupt is masked.  This bit is cleared by writing a 1 to it. Clearing this bit also clears the <b>INRDC</b> bit in the <b>ADCRIS</b> register.
18	DCINSS2	RO	0	Digital Comparator Interrupt Status on SS2  Value Description 1 Both the <b>INRDC</b> bit in the <b>ADCRIS</b> register and the <b>DCONSS2</b> bit in the <b>ADCIM</b> register are set, providing a level-base interrupt to the interrupt controller. 0 No interrupt has occurred or the interrupt is masked.  This bit is cleared by writing a 1 to it. Clearing this bit also clears the <b>INRDC</b> bit in the <b>ADCRIS</b> register.

Bit/Field	Name	Type	Reset	Description
17	DCINSS1	RO	0	<p>Digital Comparator Interrupt Status on SS1</p> <p>Value Description</p> <p>1 Both the <code>INRDC</code> bit in the <b>ADCRIS</b> register and the <code>DCONSS1</code> bit in the <b>ADCIM</b> register are set, providing a level-base interrupt to the interrupt controller.</p> <p>0 No interrupt has occurred or the interrupt is masked.</p> <p>This bit is cleared by writing a 1 to it. Clearing this bit also clears the <code>INRDC</code> bit in the <b>ADCRIS</b> register.</p>
16	DCINSS0	RO	0	<p>Digital Comparator Interrupt Status on SS0</p> <p>Value Description</p> <p>1 Both the <code>INRDC</code> bit in the <b>ADCRIS</b> register and the <code>DCONSS0</code> bit in the <b>ADCIM</b> register are set, providing a level-base interrupt to the interrupt controller.</p> <p>0 No interrupt has occurred or the interrupt is masked.</p> <p>This bit is cleared by writing a 1 to it. Clearing this bit also clears the <code>INRDC</code> bit in the <b>ADCRIS</b> register.</p>
15:4	reserved	RO	0x000	Software should not rely on the value of a reserved bit. To provide compatibility with future products, the value of a reserved bit should be preserved across a read-modify-write operation.
3	IN3	R/W1C	0	<p>SS3 Interrupt Status and Clear</p> <p>Value Description</p> <p>1 Both the <code>INR3</code> bit in the <b>ADCRIS</b> register and the <code>MASK3</code> bit in the <b>ADCIM</b> register are set, providing a level-based interrupt to the interrupt controller.</p> <p>0 No interrupt has occurred or the interrupt is masked.</p> <p>This bit is cleared by writing a 1. Clearing this bit also clears the <code>INR3</code> bit in the <b>ADCRIS</b> register.</p>
2	IN2	R/W1C	0	<p>SS2 Interrupt Status and Clear</p> <p>Value Description</p> <p>1 Both the <code>INR2</code> bit in the <b>ADCRIS</b> register and the <code>MASK2</code> bit in the <b>ADCIM</b> register are set, providing a level-based interrupt to the interrupt controller.</p> <p>0 No interrupt has occurred or the interrupt is masked.</p> <p>This bit is cleared by writing a 1. Clearing this bit also clears the <code>INR2</code> bit in the <b>ADCRIS</b> register.</p>

Bit/Field	Name	Type	Reset	Description
1	IN1	R/W1C	0	<p>SS1 Interrupt Status and Clear</p> <p>Value Description</p> <p>1 Both the <code>INR1</code> bit in the <b>ADCRIS</b> register and the <code>MASK1</code> bit in the <b>ADCIM</b> register are set, providing a level-based interrupt to the interrupt controller.</p> <p>0 No interrupt has occurred or the interrupt is masked.</p> <p>This bit is cleared by writing a 1. Clearing this bit also clears the <code>INR1</code> bit in the <b>ADCRIS</b> register.</p>
0	IN0	R/W1C	0	<p>SS0 Interrupt Status and Clear</p> <p>Value Description</p> <p>1 Both the <code>INR0</code> bit in the <b>ADCRIS</b> register and the <code>MASK0</code> bit in the <b>ADCIM</b> register are set, providing a level-based interrupt to the interrupt controller.</p> <p>0 No interrupt has occurred or the interrupt is masked.</p> <p>This bit is cleared by writing a 1. Clearing this bit also clears the <code>INR0</code> bit in the <b>ADCRIS</b> register.</p>

## Register 5: ADC Overflow Status (ADCOSTAT), offset 0x010

This register indicates overflow conditions in the sample sequencer FIFOs. Once the overflow condition has been handled by software, the condition can be cleared by writing a 1 to the corresponding bit position.

### ADC Overflow Status (ADCOSTAT)

ADC0 base: 0x4003.8000  
 ADC1 base: 0x4003.9000  
 Offset 0x010  
 Type R/W1C, reset 0x0000.0000

	31	30	29	28	27	26	25	24	23	22	21	20	19	18	17	16	
	reserved																
Type	RO	RO	RO	RO	RO	RO	RO	RO	RO	RO	RO	RO	RO	RO	RO	RO	
Reset	0	0	0	0	0	0	0	0	0	0	0	0	0	0	0	0	
	15	14	13	12	11	10	9	8	7	6	5	4	3	2	1	0	
	reserved												OV3	OV2	OV1	OV0	
Type	RO	RO	RO	RO	RO	RO	RO	RO	RO	RO	RO	RO	RO	R/W1C	R/W1C	R/W1C	R/W1C
Reset	0	0	0	0	0	0	0	0	0	0	0	0	0	0	0	0	0

Bit/Field	Name	Type	Reset	Description
31:4	reserved	RO	0x0000.000	Software should not rely on the value of a reserved bit. To provide compatibility with future products, the value of a reserved bit should be preserved across a read-modify-write operation.
3	OV3	R/W1C	0	SS3 FIFO Overflow  Value Description 1 The FIFO for Sample Sequencer 3 has hit an overflow condition, meaning that the FIFO is full and a write was requested. When an overflow is detected, the most recent write is dropped. 0 The FIFO has not overflowed.  This bit is cleared by writing a 1.
2	OV2	R/W1C	0	SS2 FIFO Overflow  Value Description 1 The FIFO for Sample Sequencer 2 has hit an overflow condition, meaning that the FIFO is full and a write was requested. When an overflow is detected, the most recent write is dropped. 0 The FIFO has not overflowed.  This bit is cleared by writing a 1.
1	OV1	R/W1C	0	SS1 FIFO Overflow  Value Description 1 The FIFO for Sample Sequencer 1 has hit an overflow condition, meaning that the FIFO is full and a write was requested. When an overflow is detected, the most recent write is dropped. 0 The FIFO has not overflowed.  This bit is cleared by writing a 1.

Bit/Field	Name	Type	Reset	Description
0	OV0	R/W1C	0	SS0 FIFO Overflow
				Value Description
				1 The FIFO for Sample Sequencer 0 has hit an overflow condition, meaning that the FIFO is full and a write was requested. When an overflow is detected, the most recent write is dropped.
				0 The FIFO has not overflowed.
				This bit is cleared by writing a 1.



**Register 6: ADC Event Multiplexer Select (ADCEMUX), offset 0x014**

The **ADCEMUX** selects the event (trigger) that initiates sampling for each sample sequencer. Each sample sequencer can be configured with a unique trigger source.

## ADC Event Multiplexer Select (ADCEMUX)

ADC0 base: 0x4003.8000

ADC1 base: 0x4003.9000

Offset 0x014

Type R/W, reset 0x0000.0000

	31	30	29	28	27	26	25	24	23	22	21	20	19	18	17	16
	reserved															
Type	RO	RO	RO	RO	RO	RO	RO	RO	RO	RO	RO	RO	RO	RO	RO	RO
Reset	0	0	0	0	0	0	0	0	0	0	0	0	0	0	0	0
	15	14	13	12	11	10	9	8	7	6	5	4	3	2	1	0
	EM3				EM2				EM1				EM0			
Type	R/W	R/W	R/W	R/W	R/W	R/W	R/W	R/W	R/W	R/W	R/W	R/W	R/W	R/W	R/W	R/W
Reset	0	0	0	0	0	0	0	0	0	0	0	0	0	0	0	0

Bit/Field	Name	Type	Reset	Description
31:16	reserved	RO	0x0000	Software should not rely on the value of a reserved bit. To provide compatibility with future products, the value of a reserved bit should be preserved across a read-modify-write operation.

Bit/Field	Name	Type	Reset	Description																																												
15:12	EM3	R/W	0x0	<p>SS3 Trigger Select</p> <p>This field selects the trigger source for Sample Sequencer 3.</p> <p>The valid configurations for this field are:</p> <table border="1"> <thead> <tr> <th>Value</th> <th>Event</th> </tr> </thead> <tbody> <tr> <td>0x0</td> <td>Processor (default)</td> </tr> <tr> <td>0x1</td> <td>Analog Comparator 0</td> </tr> <tr> <td>0x2</td> <td>Analog Comparator 1</td> </tr> <tr> <td>0x3</td> <td>Analog Comparator 2</td> </tr> <tr> <td>0x4</td> <td>External (GPIO PB4)</td> </tr> <tr> <td></td> <td> <p><b>Note:</b> PB4 can be used to trigger the ADC. However, the PB4/AIN10 pin cannot be used as both a GPIO and an analog input.</p> </td> </tr> <tr> <td>0x5</td> <td>Timer</td> </tr> <tr> <td></td> <td> <p>In addition, the trigger must be enabled with the TnOTE bit in the <b>GPTMCTL</b> register (see page 455).</p> </td> </tr> <tr> <td>0x6</td> <td>PWM0</td> </tr> <tr> <td></td> <td> <p>The PWM module 0 trigger can be configured with the <b>PWM0 Interrupt and Trigger Enable (PWM0INTEN)</b> register, see page 1072.</p> </td> </tr> <tr> <td>0x7</td> <td>PWM1</td> </tr> <tr> <td></td> <td> <p>The PWM module 1 trigger can be configured with the <b>PWM1INTEN</b> register, see page 1072.</p> </td> </tr> <tr> <td>0x8</td> <td>PWM2</td> </tr> <tr> <td></td> <td> <p>The PWM module 2 trigger can be configured with the <b>PWM2INTEN</b> register, see page 1072.</p> </td> </tr> <tr> <td>0x9</td> <td>PWM3</td> </tr> <tr> <td></td> <td> <p>The PWM module 3 trigger can be configured with the <b>PWM3INTEN</b> register, see page 1072.</p> </td> </tr> <tr> <td>0xA-0xE</td> <td>reserved</td> <td></td> <td></td> <td></td> </tr> <tr> <td>0xF</td> <td>Always (continuously sample)</td> <td></td> <td></td> <td></td> </tr> </tbody> </table>	Value	Event	0x0	Processor (default)	0x1	Analog Comparator 0	0x2	Analog Comparator 1	0x3	Analog Comparator 2	0x4	External (GPIO PB4)		<p><b>Note:</b> PB4 can be used to trigger the ADC. However, the PB4/AIN10 pin cannot be used as both a GPIO and an analog input.</p>	0x5	Timer		<p>In addition, the trigger must be enabled with the TnOTE bit in the <b>GPTMCTL</b> register (see page 455).</p>	0x6	PWM0		<p>The PWM module 0 trigger can be configured with the <b>PWM0 Interrupt and Trigger Enable (PWM0INTEN)</b> register, see page 1072.</p>	0x7	PWM1		<p>The PWM module 1 trigger can be configured with the <b>PWM1INTEN</b> register, see page 1072.</p>	0x8	PWM2		<p>The PWM module 2 trigger can be configured with the <b>PWM2INTEN</b> register, see page 1072.</p>	0x9	PWM3		<p>The PWM module 3 trigger can be configured with the <b>PWM3INTEN</b> register, see page 1072.</p>	0xA-0xE	reserved				0xF	Always (continuously sample)			
Value	Event																																															
0x0	Processor (default)																																															
0x1	Analog Comparator 0																																															
0x2	Analog Comparator 1																																															
0x3	Analog Comparator 2																																															
0x4	External (GPIO PB4)																																															
	<p><b>Note:</b> PB4 can be used to trigger the ADC. However, the PB4/AIN10 pin cannot be used as both a GPIO and an analog input.</p>																																															
0x5	Timer																																															
	<p>In addition, the trigger must be enabled with the TnOTE bit in the <b>GPTMCTL</b> register (see page 455).</p>																																															
0x6	PWM0																																															
	<p>The PWM module 0 trigger can be configured with the <b>PWM0 Interrupt and Trigger Enable (PWM0INTEN)</b> register, see page 1072.</p>																																															
0x7	PWM1																																															
	<p>The PWM module 1 trigger can be configured with the <b>PWM1INTEN</b> register, see page 1072.</p>																																															
0x8	PWM2																																															
	<p>The PWM module 2 trigger can be configured with the <b>PWM2INTEN</b> register, see page 1072.</p>																																															
0x9	PWM3																																															
	<p>The PWM module 3 trigger can be configured with the <b>PWM3INTEN</b> register, see page 1072.</p>																																															
0xA-0xE	reserved																																															
0xF	Always (continuously sample)																																															

Bit/Field	Name	Type	Reset	Description												
11:8	EM2	R/W	0x0	<p>SS2 Trigger Select</p> <p>This field selects the trigger source for Sample Sequencer 2.</p> <p>The valid configurations for this field are:</p> <table border="1"> <thead> <tr> <th>Value</th> <th>Event</th> </tr> </thead> <tbody> <tr> <td>0x0</td> <td>Processor (default)</td> </tr> <tr> <td>0x1</td> <td>Analog Comparator 0</td> </tr> <tr> <td>0x2</td> <td>Analog Comparator 1</td> </tr> <tr> <td>0x3</td> <td>Analog Comparator 2</td> </tr> <tr> <td>0x4</td> <td>External (GPIO PB4)</td> </tr> </tbody> </table> <p><b>Note:</b> PB4 can be used to trigger the ADC. However, the PB4/AIN10 pin cannot be used as both a GPIO and an analog input.</p>	Value	Event	0x0	Processor (default)	0x1	Analog Comparator 0	0x2	Analog Comparator 1	0x3	Analog Comparator 2	0x4	External (GPIO PB4)
Value	Event															
0x0	Processor (default)															
0x1	Analog Comparator 0															
0x2	Analog Comparator 1															
0x3	Analog Comparator 2															
0x4	External (GPIO PB4)															
			0x5	<p>Timer</p> <p>In addition, the trigger must be enabled with the TnOTE bit in the <b>GPTMCTL</b> register (see page 455).</p>												
			0x6	<p>PWM0</p> <p>The PWM module 0 trigger can be configured with the <b>PWM0 Interrupt and Trigger Enable (PWM0INTEN)</b> register, see page 1072.</p>												
			0x7	<p>PWM1</p> <p>The PWM module 1 trigger can be configured with the <b>PWM1INTEN</b> register, see page 1072.</p>												
			0x8	<p>PWM2</p> <p>The PWM module 2 trigger can be configured with the <b>PWM2INTEN</b> register, see page 1072.</p>												
			0x9	<p>PWM3</p> <p>The PWM module 3 trigger can be configured with the <b>PWM3INTEN</b> register, see page 1072.</p>												
			0xA-0xE	reserved												
			0xF	Always (continuously sample)												

Bit/Field	Name	Type	Reset	Description																																												
7:4	EM1	R/W	0x0	<p>SS1 Trigger Select</p> <p>This field selects the trigger source for Sample Sequencer 1.</p> <p>The valid configurations for this field are:</p> <table border="1"> <thead> <tr> <th>Value</th> <th>Event</th> </tr> </thead> <tbody> <tr> <td>0x0</td> <td>Processor (default)</td> </tr> <tr> <td>0x1</td> <td>Analog Comparator 0</td> </tr> <tr> <td>0x2</td> <td>Analog Comparator 1</td> </tr> <tr> <td>0x3</td> <td>Analog Comparator 2</td> </tr> <tr> <td>0x4</td> <td>External (GPIO PB4)</td> </tr> <tr> <td></td> <td><b>Note:</b> PB4 can be used to trigger the ADC. However, the PB4/AIN10 pin cannot be used as both a GPIO and an analog input.</td> </tr> <tr> <td>0x5</td> <td>Timer</td> </tr> <tr> <td></td> <td>In addition, the trigger must be enabled with the TnOTE bit in the <b>GPTMCTL</b> register (see page 455).</td> </tr> <tr> <td>0x6</td> <td>PWM0</td> </tr> <tr> <td></td> <td>The PWM module 0 trigger can be configured with the <b>PWM0 Interrupt and Trigger Enable (PWM0INTEN)</b> register, see page 1072.</td> </tr> <tr> <td>0x7</td> <td>PWM1</td> </tr> <tr> <td></td> <td>The PWM module 1 trigger can be configured with the <b>PWM1INTEN</b> register, see page 1072.</td> </tr> <tr> <td>0x8</td> <td>PWM2</td> </tr> <tr> <td></td> <td>The PWM module 2 trigger can be configured with the <b>PWM2INTEN</b> register, see page 1072.</td> </tr> <tr> <td>0x9</td> <td>PWM3</td> </tr> <tr> <td></td> <td>The PWM module 3 trigger can be configured with the <b>PWM3INTEN</b> register, see page 1072.</td> </tr> <tr> <td>0xA-0xE</td> <td>reserved</td> <td></td> <td></td> <td></td> </tr> <tr> <td>0xF</td> <td>Always (continuously sample)</td> <td></td> <td></td> <td></td> </tr> </tbody> </table>	Value	Event	0x0	Processor (default)	0x1	Analog Comparator 0	0x2	Analog Comparator 1	0x3	Analog Comparator 2	0x4	External (GPIO PB4)		<b>Note:</b> PB4 can be used to trigger the ADC. However, the PB4/AIN10 pin cannot be used as both a GPIO and an analog input.	0x5	Timer		In addition, the trigger must be enabled with the TnOTE bit in the <b>GPTMCTL</b> register (see page 455).	0x6	PWM0		The PWM module 0 trigger can be configured with the <b>PWM0 Interrupt and Trigger Enable (PWM0INTEN)</b> register, see page 1072.	0x7	PWM1		The PWM module 1 trigger can be configured with the <b>PWM1INTEN</b> register, see page 1072.	0x8	PWM2		The PWM module 2 trigger can be configured with the <b>PWM2INTEN</b> register, see page 1072.	0x9	PWM3		The PWM module 3 trigger can be configured with the <b>PWM3INTEN</b> register, see page 1072.	0xA-0xE	reserved				0xF	Always (continuously sample)			
Value	Event																																															
0x0	Processor (default)																																															
0x1	Analog Comparator 0																																															
0x2	Analog Comparator 1																																															
0x3	Analog Comparator 2																																															
0x4	External (GPIO PB4)																																															
	<b>Note:</b> PB4 can be used to trigger the ADC. However, the PB4/AIN10 pin cannot be used as both a GPIO and an analog input.																																															
0x5	Timer																																															
	In addition, the trigger must be enabled with the TnOTE bit in the <b>GPTMCTL</b> register (see page 455).																																															
0x6	PWM0																																															
	The PWM module 0 trigger can be configured with the <b>PWM0 Interrupt and Trigger Enable (PWM0INTEN)</b> register, see page 1072.																																															
0x7	PWM1																																															
	The PWM module 1 trigger can be configured with the <b>PWM1INTEN</b> register, see page 1072.																																															
0x8	PWM2																																															
	The PWM module 2 trigger can be configured with the <b>PWM2INTEN</b> register, see page 1072.																																															
0x9	PWM3																																															
	The PWM module 3 trigger can be configured with the <b>PWM3INTEN</b> register, see page 1072.																																															
0xA-0xE	reserved																																															
0xF	Always (continuously sample)																																															

Bit/Field	Name	Type	Reset	Description												
3:0	EM0	R/W	0x0	<p>SS0 Trigger Select</p> <p>This field selects the trigger source for Sample Sequencer 0</p> <p>The valid configurations for this field are:</p> <table border="1"> <thead> <tr> <th>Value</th> <th>Event</th> </tr> </thead> <tbody> <tr> <td>0x0</td> <td>Processor (default)</td> </tr> <tr> <td>0x1</td> <td>Analog Comparator 0</td> </tr> <tr> <td>0x2</td> <td>Analog Comparator 1</td> </tr> <tr> <td>0x3</td> <td>Analog Comparator 2</td> </tr> <tr> <td>0x4</td> <td>External (GPIO PB4)</td> </tr> </tbody> </table> <p><b>Note:</b> PB4 can be used to trigger the ADC. However, the PB4/AIN10 pin cannot be used as both a GPIO and an analog input.</p>	Value	Event	0x0	Processor (default)	0x1	Analog Comparator 0	0x2	Analog Comparator 1	0x3	Analog Comparator 2	0x4	External (GPIO PB4)
Value	Event															
0x0	Processor (default)															
0x1	Analog Comparator 0															
0x2	Analog Comparator 1															
0x3	Analog Comparator 2															
0x4	External (GPIO PB4)															
				<p>0x5 Timer</p> <p>In addition, the trigger must be enabled with the TnOTE bit in the <b>GPTMCTL</b> register (see page 455).</p>												
				<p>0x6 PWM0</p> <p>The PWM module 0 trigger can be configured with the <b>PWM0 Interrupt and Trigger Enable (PWM0INTEN)</b> register, see page 1072.</p>												
				<p>0x7 PWM1</p> <p>The PWM module 1 trigger can be configured with the <b>PWM1INTEN</b> register, see page 1072.</p>												
				<p>0x8 PWM2</p> <p>The PWM module 2 trigger can be configured with the <b>PWM2INTEN</b> register, see page 1072.</p>												
				<p>0x9 PWM3</p> <p>The PWM module 3 trigger can be configured with the <b>PWM3INTEN</b> register, see page 1072.</p>												
				<p>0xA-0xE reserved</p>												
				<p>0xF Always (continuously sample)</p>												

### Register 7: ADC Underflow Status (ADCUSTAT), offset 0x018

This register indicates underflow conditions in the sample sequencer FIFOs. The corresponding underflow condition is cleared by writing a 1 to the relevant bit position.

#### ADC Underflow Status (ADCUSTAT)

ADC0 base: 0x4003.8000  
 ADC1 base: 0x4003.9000  
 Offset 0x018  
 Type R/W1C, reset 0x0000.0000

	31	30	29	28	27	26	25	24	23	22	21	20	19	18	17	16	
	reserved																
Type	RO	RO	RO	RO	RO	RO	RO	RO	RO	RO	RO	RO	RO	RO	RO	RO	
Reset	0	0	0	0	0	0	0	0	0	0	0	0	0	0	0	0	
	15	14	13	12	11	10	9	8	7	6	5	4	3	2	1	0	
	reserved												UV3	UV2	UV1	UV0	
Type	RO	RO	RO	RO	RO	RO	RO	RO	RO	RO	RO	RO	RO	R/W1C	R/W1C	R/W1C	R/W1C
Reset	0	0	0	0	0	0	0	0	0	0	0	0	0	0	0	0	0

Bit/Field	Name	Type	Reset	Description						
31:4	reserved	RO	0x0000.000	Software should not rely on the value of a reserved bit. To provide compatibility with future products, the value of a reserved bit should be preserved across a read-modify-write operation.						
3	UV3	R/W1C	0	<p>SS3 FIFO Underflow</p> <p>The valid configurations for this field are shown below. This bit is cleared by writing a 1.</p> <table border="1"> <thead> <tr> <th>Value</th> <th>Description</th> </tr> </thead> <tbody> <tr> <td>1</td> <td>The FIFO for the Sample Sequencer has hit an underflow condition, meaning that the FIFO is empty and a read was requested. The problematic read does not move the FIFO pointers, and 0s are returned.</td> </tr> <tr> <td>0</td> <td>The FIFO has not underflowed.</td> </tr> </tbody> </table>	Value	Description	1	The FIFO for the Sample Sequencer has hit an underflow condition, meaning that the FIFO is empty and a read was requested. The problematic read does not move the FIFO pointers, and 0s are returned.	0	The FIFO has not underflowed.
Value	Description									
1	The FIFO for the Sample Sequencer has hit an underflow condition, meaning that the FIFO is empty and a read was requested. The problematic read does not move the FIFO pointers, and 0s are returned.									
0	The FIFO has not underflowed.									
2	UV2	R/W1C	0	<p>SS2 FIFO Underflow</p> <p>The valid configurations are the same as those for the UV3 field. This bit is cleared by writing a 1.</p>						
1	UV1	R/W1C	0	<p>SS1 FIFO Underflow</p> <p>The valid configurations are the same as those for the UV3 field. This bit is cleared by writing a 1.</p>						
0	UV0	R/W1C	0	<p>SS0 FIFO Underflow</p> <p>The valid configurations are the same as those for the UV3 field. This bit is cleared by writing a 1.</p>						

## Register 8: ADC Sample Sequencer Priority (ADCSSPRI), offset 0x020

This register sets the priority for each of the sample sequencers. Out of reset, Sequencer 0 has the highest priority, and Sequencer 3 has the lowest priority. When reconfiguring sequence priorities, each sequence must have a unique priority for the ADC to operate properly.

### ADC Sample Sequencer Priority (ADCSSPRI)

ADC0 base: 0x4003.8000  
 ADC1 base: 0x4003.9000  
 Offset 0x020  
 Type R/W, reset 0x0000.3210

	31	30	29	28	27	26	25	24	23	22	21	20	19	18	17	16
	reserved															
Type	RO	RO	RO	RO	RO	RO	RO	RO	RO	RO	RO	RO	RO	RO	RO	RO
Reset	0	0	0	0	0	0	0	0	0	0	0	0	0	0	0	0
	15	14	13	12	11	10	9	8	7	6	5	4	3	2	1	0
	reserved		SS3		reserved		SS2		reserved		SS1		reserved		SS0	
Type	RO	RO	R/W	R/W	RO	RO	R/W	R/W	RO	RO	R/W	R/W	RO	RO	R/W	R/W
Reset	0	0	1	1	0	0	1	0	0	0	0	1	0	0	0	0

Bit/Field	Name	Type	Reset	Description
31:14	reserved	RO	0x0000.0	Software should not rely on the value of a reserved bit. To provide compatibility with future products, the value of a reserved bit should be preserved across a read-modify-write operation.
13:12	SS3	R/W	0x3	SS3 Priority  This field contains a binary-encoded value that specifies the priority encoding of Sample Sequencer 3. A priority encoding of 0x0 is highest and 0x3 is lowest. The priorities assigned to the sequencers must be uniquely mapped. The ADC may not operate properly if two or more fields are equal.
11:10	reserved	RO	0x0	Software should not rely on the value of a reserved bit. To provide compatibility with future products, the value of a reserved bit should be preserved across a read-modify-write operation.
9:8	SS2	R/W	0x2	SS2 Priority  This field contains a binary-encoded value that specifies the priority encoding of Sample Sequencer 2. A priority encoding of 0x0 is highest and 0x3 is lowest. The priorities assigned to the sequencers must be uniquely mapped. The ADC may not operate properly if two or more fields are equal.
7:6	reserved	RO	0x0	Software should not rely on the value of a reserved bit. To provide compatibility with future products, the value of a reserved bit should be preserved across a read-modify-write operation.
5:4	SS1	R/W	0x1	SS1 Priority  This field contains a binary-encoded value that specifies the priority encoding of Sample Sequencer 1. A priority encoding of 0x0 is highest and 0x3 is lowest. The priorities assigned to the sequencers must be uniquely mapped. The ADC may not operate properly if two or more fields are equal.
3:2	reserved	RO	0x0	Software should not rely on the value of a reserved bit. To provide compatibility with future products, the value of a reserved bit should be preserved across a read-modify-write operation.

Bit/Field	Name	Type	Reset	Description
1:0	SS0	R/W	0x0	SS0 Priority  This field contains a binary-encoded value that specifies the priority encoding of Sample Sequencer 0. A priority encoding of 0x0 is highest and 0x3 is lowest. The priorities assigned to the sequencers must be uniquely mapped. The ADC may not operate properly if two or more fields are equal.



## Register 9: ADC Sample Phase Control (ADCSPC), offset 0x024

This register allows the ADC module to sample at one of 16 different discrete phases from 0.0° through 337.5°. For example, the sample rate could be effectively doubled by sampling a signal using one ADC module configured with the standard sample time and the second ADC module configured with a 180.0° phase lag.

**Note:** Care should be taken when the PHASE field is non-zero, as the resulting delay in sampling the AIN<sub>x</sub> input may result in undesirable system consequences. Designers should carefully consider the impact of this delay.

### ADC Sample Phase Control (ADCSPC)

ADC0 base: 0x4003.8000

ADC1 base: 0x4003.9000

Offset 0x024

Type R/W, reset 0x0000.0000

	31	30	29	28	27	26	25	24	23	22	21	20	19	18	17	16
	reserved															
Type	RO	RO	RO	RO	RO	RO	RO	RO	RO	RO	RO	RO	RO	RO	RO	RO
Reset	0	0	0	0	0	0	0	0	0	0	0	0	0	0	0	0
	15	14	13	12	11	10	9	8	7	6	5	4	3	2	1	0
	reserved												PHASE			
Type	RO	RO	RO	RO	RO	RO	RO	RO	RO	RO	RO	RO	R/W	R/W	R/W	R/W
Reset	0	0	0	0	0	0	0	0	0	0	0	0	0	0	0	0

Bit/Field	Name	Type	Reset	Description
31:4	reserved	RO	0x0000.000	Software should not rely on the value of a reserved bit. To provide compatibility with future products, the value of a reserved bit should be preserved across a read-modify-write operation.
3:0	PHASE	R/W	0x0	Phase Difference This field selects the sample phase difference from the standard sample time.
				Value Description
				0x0 ADC sample lags by 0.0°
				0x1 ADC sample lags by 22.5°
				0x2 ADC sample lags by 45.0°
				0x3 ADC sample lags by 67.5°
				0x4 ADC sample lags by 90.0°
				0x5 ADC sample lags by 112.5°
				0x6 ADC sample lags by 135.0°
				0x7 ADC sample lags by 157.5°
				0x8 ADC sample lags by 180.0°
				0x9 ADC sample lags by 202.5°
				0xA ADC sample lags by 225.0°
				0xB ADC sample lags by 247.5°
				0xC ADC sample lags by 270.0°
				0xD ADC sample lags by 292.5°
				0xE ADC sample lags by 315.0°
				0xF ADC sample lags by 337.5°

### Register 10: ADC Processor Sample Sequence Initiate (ADCPSSI), offset 0x028

This register provides a mechanism for application software to initiate sampling in the sample sequencers. Sample sequences can be initiated individually or in any combination. When multiple sequences are triggered simultaneously, the priority encodings in **ADCSSPRI** dictate execution order.

This register also provides a means to configure and then initiate concurrent sampling on all ADC modules. To do this, the first ADC module should be configured. The **ADCPSSI** register for that module should then be written. The appropriate **SS** bits should be set along with the **SYNCWAIT** bit. Additional ADC modules should then be configured following the same procedure. Once the final ADC module is configured, its **ADCPSSI** register should be written with the appropriate **SS** bits set along with the **GSYNC** bit. All of the ADC modules then begin concurrent sampling according to their configuration.

#### ADC Processor Sample Sequence Initiate (ADCPSSI)

ADC0 base: 0x4003.8000  
 ADC1 base: 0x4003.9000  
 Offset 0x028  
 Type R/W, reset -

	31	30	29	28	27	26	25	24	23	22	21	20	19	18	17	16	
	GSYNC	reserved				SYNCWAIT	reserved										
Type	R/W	RO	RO	RO	R/W	RO	RO	RO	RO	RO	RO	RO	RO	RO	RO	RO	
Reset	0	0	0	0	0	0	0	0	0	0	0	0	0	0	0	0	
	15	14	13	12	11	10	9	8	7	6	5	4	3	2	1	0	
	reserved												SS3	SS2	SS1	SS0	
Type	RO	RO	RO	RO	RO	RO	RO	RO	RO	RO	RO	RO	RO	WO	WO	WO	WO
Reset	0	0	0	0	0	0	0	0	0	0	0	0	0	-	-	-	-

Bit/Field	Name	Type	Reset	Description
31	GSYNC	R/W	0	Global Synchronize
				Value Description
				1 This bit initiates sampling in multiple ADC modules at the same time. Any ADC module that has been initialized by setting an <b>SS<sub>n</sub></b> bit and the <b>SYNCWAIT</b> bit starts sampling once this bit is written.
				0 This bit is cleared once sampling has been initiated.
30:28	reserved	RO	0x0	Software should not rely on the value of a reserved bit. To provide compatibility with future products, the value of a reserved bit should be preserved across a read-modify-write operation.
27	SYNCWAIT	R/W	0	Synchronize Wait
				Value Description
				1 This bit allows the sample sequences to be initiated, but delays sampling until the <b>GSYNC</b> bit is set.
				0 Sampling begins when a sample sequence has been initiated.
26:4	reserved	RO	0x0000.0	Software should not rely on the value of a reserved bit. To provide compatibility with future products, the value of a reserved bit should be preserved across a read-modify-write operation.

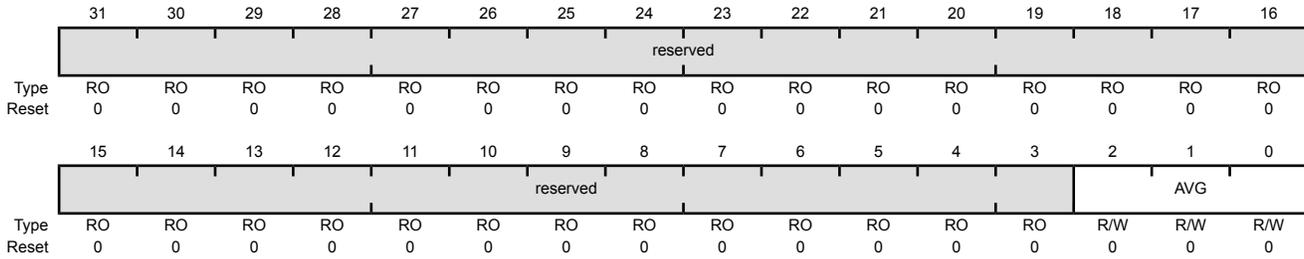
Bit/Field	Name	Type	Reset	Description
3	SS3	WO	-	<p>SS3 Initiate</p> <p>Value Description</p> <p>1 Begin sampling on Sample Sequencer 3, if the sequencer is enabled in the <b>ADCACTSS</b> register.</p> <p>0 No effect.</p> <p>Only a write by software is valid; a read of this register returns no meaningful data.</p>
2	SS2	WO	-	<p>SS2 Initiate</p> <p>Value Description</p> <p>1 Begin sampling on Sample Sequencer 2, if the sequencer is enabled in the <b>ADCACTSS</b> register.</p> <p>0 No effect.</p> <p>Only a write by software is valid; a read of this register returns no meaningful data.</p>
1	SS1	WO	-	<p>SS1 Initiate</p> <p>Value Description</p> <p>1 Begin sampling on Sample Sequencer 1, if the sequencer is enabled in the <b>ADCACTSS</b> register.</p> <p>0 No effect.</p> <p>Only a write by software is valid; a read of this register returns no meaningful data.</p>
0	SS0	WO	-	<p>SS0 Initiate</p> <p>Value Description</p> <p>1 Begin sampling on Sample Sequencer 0, if the sequencer is enabled in the <b>ADCACTSS</b> register.</p> <p>0 No effect.</p> <p>Only a write by software is valid; a read of this register returns no meaningful data.</p>

### Register 11: ADC Sample Averaging Control (ADCSAC), offset 0x030

This register controls the amount of hardware averaging applied to conversion results. The final conversion result stored in the FIFO is averaged from  $2^{AVG}$  consecutive ADC samples at the specified ADC speed. If AVG is 0, the sample is passed directly through without any averaging. If AVG=6, then 64 consecutive ADC samples are averaged to generate one result in the sequencer FIFO. An AVG = 7 provides unpredictable results.

#### ADC Sample Averaging Control (ADCSAC)

ADC0 base: 0x4003.8000  
 ADC1 base: 0x4003.9000  
 Offset 0x030  
 Type R/W, reset 0x0000.0000



Bit/Field	Name	Type	Reset	Description
31:3	reserved	RO	0x0000.000	Software should not rely on the value of a reserved bit. To provide compatibility with future products, the value of a reserved bit should be preserved across a read-modify-write operation.
2:0	AVG	R/W	0x0	Hardware Averaging Control  Specifies the amount of hardware averaging that will be applied to ADC samples. The AVG field can be any value between 0 and 6. Entering a value of 7 creates unpredictable results.

Value	Description
0x0	No hardware oversampling
0x1	2x hardware oversampling
0x2	4x hardware oversampling
0x3	8x hardware oversampling
0x4	16x hardware oversampling
0x5	32x hardware oversampling
0x6	64x hardware oversampling
0x7	reserved

## Register 12: ADC Digital Comparator Interrupt Status and Clear (ADCDCISC), offset 0x034

This register provides status and acknowledgement of digital comparator interrupts. One bit is provided for each comparator.

### ADC Digital Comparator Interrupt Status and Clear (ADCDCISC)

ADC0 base: 0x4003.8000

ADC1 base: 0x4003.9000

Offset 0x034

Type R/W1C, reset 0x0000.0000

	31	30	29	28	27	26	25	24	23	22	21	20	19	18	17	16
	reserved															
Type	RO	RO	RO	RO	RO	RO	RO	RO	RO	RO	RO	RO	RO	RO	RO	RO
Reset	0	0	0	0	0	0	0	0	0	0	0	0	0	0	0	0
	15	14	13	12	11	10	9	8	7	6	5	4	3	2	1	0
	reserved								DCINT7	DCINT6	DCINT5	DCINT4	DCINT3	DCINT2	DCINT1	DCINT0
Type	RO	RO	RO	RO	RO	RO	RO	RO	R/W1C	R/W1C	R/W1C	R/W1C	R/W1C	R/W1C	R/W1C	R/W1C
Reset	0	0	0	0	0	0	0	0	0	0	0	0	0	0	0	0

Bit/Field	Name	Type	Reset	Description
31:8	reserved	RO	0x0000.00	Software should not rely on the value of a reserved bit. To provide compatibility with future products, the value of a reserved bit should be preserved across a read-modify-write operation.
7	DCINT7	R/W1C	0	Digital Comparator 7 Interrupt Status and Clear  Value Description 1 Digital Comparator 7 has generated an interrupt. 0 No interrupt.  This bit is cleared by writing a 1.
6	DCINT6	R/W1C	0	Digital Comparator 6 Interrupt Status and Clear  Value Description 1 Digital Comparator 6 has generated an interrupt. 0 No interrupt.  This bit is cleared by writing a 1.
5	DCINT5	R/W1C	0	Digital Comparator 5 Interrupt Status and Clear  Value Description 1 Digital Comparator 5 has generated an interrupt. 0 No interrupt.  This bit is cleared by writing a 1.

Bit/Field	Name	Type	Reset	Description
4	DCINT4	R/W1C	0	Digital Comparator 4 Interrupt Status and Clear  Value Description 1 Digital Comparator 4 has generated an interrupt. 0 No interrupt.  This bit is cleared by writing a 1.
3	DCINT3	R/W1C	0	Digital Comparator 3 Interrupt Status and Clear  Value Description 1 Digital Comparator 3 has generated an interrupt. 0 No interrupt.  This bit is cleared by writing a 1.
2	DCINT2	R/W1C	0	Digital Comparator 2 Interrupt Status and Clear  Value Description 1 Digital Comparator 2 has generated an interrupt. 0 No interrupt.  This bit is cleared by writing a 1.
1	DCINT1	R/W1C	0	Digital Comparator 1 Interrupt Status and Clear  Value Description 1 Digital Comparator 1 has generated an interrupt. 0 No interrupt.  This bit is cleared by writing a 1.
0	DCINT0	R/W1C	0	Digital Comparator 0 Interrupt Status and Clear  Value Description 1 Digital Comparator 0 has generated an interrupt. 0 No interrupt.  This bit is cleared by writing a 1.

**Register 13: ADC Control (ADCCTL), offset 0x038**

This register selects the voltage reference.

**ADC Control (ADCCTL)**

ADC0 base: 0x4003.8000

ADC1 base: 0x4003.9000

Offset 0x038

Type R/W, reset 0x0000.0000

	31	30	29	28	27	26	25	24	23	22	21	20	19	18	17	16
	reserved															
Type	RO	RO	RO	RO	RO	RO	RO	RO	RO	RO	RO	RO	RO	RO	RO	RO
Reset	0	0	0	0	0	0	0	0	0	0	0	0	0	0	0	0
	15	14	13	12	11	10	9	8	7	6	5	4	3	2	1	0
	reserved															VREF
Type	RO	RO	RO	RO	RO	RO	RO	RO	RO	RO	RO	RO	RO	RO	RO	R/W
Reset	0	0	0	0	0	0	0	0	0	0	0	0	0	0	0	0

Bit/Field	Name	Type	Reset	Description
31:1	reserved	RO	0x0000.000	Software should not rely on the value of a reserved bit. To provide compatibility with future products, the value of a reserved bit should be preserved across a read-modify-write operation.
0	VREF	R/W	0	Voltage Reference Select

Value Description

- |   |  |
|---|--|
| 1 | The external VREFA input is the voltage reference. |
| 0 | The internal reference as the voltage reference.   |

### Register 14: ADC Sample Sequence Input Multiplexer Select 0 (ADCSSMUX0), offset 0x040

This register defines the analog input configuration for each sample in a sequence executed with Sample Sequencer 0. This register is 32 bits wide and contains information for eight possible samples.

#### ADC Sample Sequence Input Multiplexer Select 0 (ADCSSMUX0)

ADC0 base: 0x4003.8000  
 ADC1 base: 0x4003.9000  
 Offset 0x040  
 Type R/W, reset 0x0000.0000

	31	30	29	28	27	26	25	24	23	22	21	20	19	18	17	16
	MUX7				MUX6				MUX5				MUX4			
Type	R/W	R/W	R/W	R/W	R/W	R/W	R/W	R/W	R/W	R/W	R/W	R/W	R/W	R/W	R/W	R/W
Reset	0	0	0	0	0	0	0	0	0	0	0	0	0	0	0	0
	15	14	13	12	11	10	9	8	7	6	5	4	3	2	1	0
	MUX3				MUX2				MUX1				MUX0			
Type	R/W	R/W	R/W	R/W	R/W	R/W	R/W	R/W	R/W	R/W	R/W	R/W	R/W	R/W	R/W	R/W
Reset	0	0	0	0	0	0	0	0	0	0	0	0	0	0	0	0

Bit/Field	Name	Type	Reset	Description
31:28	MUX7	R/W	0x0	8th Sample Input Select  The MUX7 field is used during the eighth sample of a sequence executed with the sample sequencer. It specifies which of the analog inputs is sampled for the analog-to-digital conversion. The value set here indicates the corresponding pin, for example, a value of 0x1 indicates the input is AIN1.
27:24	MUX6	R/W	0x0	7th Sample Input Select  The MUX6 field is used during the seventh sample of a sequence executed with the sample sequencer. It specifies which of the analog inputs is sampled for the analog-to-digital conversion.
23:20	MUX5	R/W	0x0	6th Sample Input Select  The MUX5 field is used during the sixth sample of a sequence executed with the sample sequencer. It specifies which of the analog inputs is sampled for the analog-to-digital conversion.
19:16	MUX4	R/W	0x0	5th Sample Input Select  The MUX4 field is used during the fifth sample of a sequence executed with the sample sequencer. It specifies which of the analog inputs is sampled for the analog-to-digital conversion.
15:12	MUX3	R/W	0x0	4th Sample Input Select  The MUX3 field is used during the fourth sample of a sequence executed with the sample sequencer. It specifies which of the analog inputs is sampled for the analog-to-digital conversion.
11:8	MUX2	R/W	0x0	3rd Sample Input Select  The MUX2 field is used during the third sample of a sequence executed with the sample sequencer. It specifies which of the analog inputs is sampled for the analog-to-digital conversion.



---

Bit/Field	Name	Type	Reset	Description
7:4	MUX1	R/W	0x0	2nd Sample Input Select  The MUX1 field is used during the second sample of a sequence executed with the sample sequencer. It specifies which of the analog inputs is sampled for the analog-to-digital conversion.
3:0	MUX0	R/W	0x0	1st Sample Input Select  The MUX0 field is used during the first sample of a sequence executed with the sample sequencer. It specifies which of the analog inputs is sampled for the analog-to-digital conversion.

### Register 15: ADC Sample Sequence Control 0 (ADCSSCTL0), offset 0x044

This register contains the configuration information for each sample for a sequence executed with a sample sequencer. When configuring a sample sequence, the `END` bit must be set for the final sample, whether it be after the first sample, eighth sample, or any sample in between. This register is 32 bits wide and contains information for eight possible samples.

#### ADC Sample Sequence Control 0 (ADCSSCTL0)

ADC0 base: 0x4003.8000  
 ADC1 base: 0x4003.9000  
 Offset 0x044  
 Type R/W, reset 0x0000.0000

	31	30	29	28	27	26	25	24	23	22	21	20	19	18	17	16
	TS7	IE7	END7	D7	TS6	IE6	END6	D6	TS5	IE5	END5	D5	TS4	IE4	END4	D4
Type	R/W	R/W	R/W	R/W	R/W	R/W	R/W	R/W	R/W	R/W	R/W	R/W	R/W	R/W	R/W	R/W
Reset	0	0	0	0	0	0	0	0	0	0	0	0	0	0	0	0
	15	14	13	12	11	10	9	8	7	6	5	4	3	2	1	0
	TS3	IE3	END3	D3	TS2	IE2	END2	D2	TS1	IE1	END1	D1	TS0	IE0	END0	D0
Type	R/W	R/W	R/W	R/W	R/W	R/W	R/W	R/W	R/W	R/W	R/W	R/W	R/W	R/W	R/W	R/W
Reset	0	0	0	0	0	0	0	0	0	0	0	0	0	0	0	0

Bit/Field	Name	Type	Reset	Description
31	TS7	R/W	0	8th Sample Temp Sensor Select
				Value Description
				1 The temperature sensor is read during the eighth sample of the sample sequence.
				0 The input pin specified by the <b>ADCSSMUXn</b> register is read during the eighth sample of the sample sequence.
30	IE7	R/W	0	8th Sample Interrupt Enable
				Value Description
				1 The raw interrupt signal ( <code>INR0</code> bit) is asserted at the end of the eighth sample's conversion. If the <code>MASK0</code> bit in the <b>ADCIM</b> register is set, the interrupt is promoted to the interrupt controller.
				0 The raw interrupt is not asserted to the interrupt controller.
				It is legal to have multiple samples within a sequence generate interrupts.
29	END7	R/W	0	8th Sample is End of Sequence
				Value Description
				1 The eighth sample is the last sample of the sequence.
				0 Another sample in the sequence is the final sample.
				It is possible to end the sequence on any sample position. Software must set an <code>ENDn</code> bit somewhere within the sequence. Samples defined after the sample containing a set <code>ENDn</code> bit are not requested for conversion even though the fields may be non-zero.

Bit/Field	Name	Type	Reset	Description
28	D7	R/W	0	8th Sample Diff Input Select  Value Description 1 The analog input is differentially sampled. The corresponding <b>ADCSSMUXn</b> nibble must be set to the pair number "i", where the paired inputs are "2i and 2i+1". 0 The analog inputs are not differentially sampled.  Because the temperature sensor does not have a differential option, this bit must not be set when the <b>TS7</b> bit is set.
27	TS6	R/W	0	7th Sample Temp Sensor Select Same definition as <b>TS7</b> but used during the seventh sample.
26	IE6	R/W	0	7th Sample Interrupt Enable Same definition as <b>IE7</b> but used during the seventh sample.
25	END6	R/W	0	7th Sample is End of Sequence Same definition as <b>END7</b> but used during the seventh sample.
24	D6	R/W	0	7th Sample Diff Input Select Same definition as <b>D7</b> but used during the seventh sample.
23	TS5	R/W	0	6th Sample Temp Sensor Select Same definition as <b>TS7</b> but used during the sixth sample.
22	IE5	R/W	0	6th Sample Interrupt Enable Same definition as <b>IE7</b> but used during the sixth sample.
21	END5	R/W	0	6th Sample is End of Sequence Same definition as <b>END7</b> but used during the sixth sample.
20	D5	R/W	0	6th Sample Diff Input Select Same definition as <b>D7</b> but used during the sixth sample.
19	TS4	R/W	0	5th Sample Temp Sensor Select Same definition as <b>TS7</b> but used during the fifth sample.
18	IE4	R/W	0	5th Sample Interrupt Enable Same definition as <b>IE7</b> but used during the fifth sample.
17	END4	R/W	0	5th Sample is End of Sequence Same definition as <b>END7</b> but used during the fifth sample.
16	D4	R/W	0	5th Sample Diff Input Select Same definition as <b>D7</b> but used during the fifth sample.
15	TS3	R/W	0	4th Sample Temp Sensor Select Same definition as <b>TS7</b> but used during the fourth sample.

Bit/Field	Name	Type	Reset	Description
14	IE3	R/W	0	4th Sample Interrupt Enable Same definition as IE7 but used during the fourth sample.
13	END3	R/W	0	4th Sample is End of Sequence Same definition as END7 but used during the fourth sample.
12	D3	R/W	0	4th Sample Diff Input Select Same definition as D7 but used during the fourth sample.
11	TS2	R/W	0	3rd Sample Temp Sensor Select Same definition as TS7 but used during the third sample.
10	IE2	R/W	0	3rd Sample Interrupt Enable Same definition as IE7 but used during the third sample.
9	END2	R/W	0	3rd Sample is End of Sequence Same definition as END7 but used during the third sample.
8	D2	R/W	0	3rd Sample Diff Input Select Same definition as D7 but used during the third sample.
7	TS1	R/W	0	2nd Sample Temp Sensor Select Same definition as TS7 but used during the second sample.
6	IE1	R/W	0	2nd Sample Interrupt Enable Same definition as IE7 but used during the second sample.
5	END1	R/W	0	2nd Sample is End of Sequence Same definition as END7 but used during the second sample.
4	D1	R/W	0	2nd Sample Diff Input Select Same definition as D7 but used during the second sample.
3	TS0	R/W	0	1st Sample Temp Sensor Select Same definition as TS7 but used during the first sample.
2	IE0	R/W	0	1st Sample Interrupt Enable Same definition as IE7 but used during the first sample.
1	END0	R/W	0	1st Sample is End of Sequence Same definition as END7 but used during the first sample.
0	D0	R/W	0	1st Sample Diff Input Select Same definition as D7 but used during the first sample.

**Register 16: ADC Sample Sequence Result FIFO 0 (ADCSSFIFO0), offset 0x048**

**Register 17: ADC Sample Sequence Result FIFO 1 (ADCSSFIFO1), offset 0x068**

**Register 18: ADC Sample Sequence Result FIFO 2 (ADCSSFIFO2), offset 0x088**

**Register 19: ADC Sample Sequence Result FIFO 3 (ADCSSFIFO3), offset 0x0A8**

**Important:** Use caution when reading this register. Performing a read may change bit status.

This register contains the conversion results for samples collected with the sample sequencer (the **ADCSSFIFO0** register is used for Sample Sequencer 0, **ADCSSFIFO1** for Sequencer 1, **ADCSSFIFO2** for Sequencer 2, and **ADCSSFIFO3** for Sequencer 3). Reads of this register return conversion result data in the order sample 0, sample 1, and so on, until the FIFO is empty. If the FIFO is not properly handled by software, overflow and underflow conditions are registered in the **ADCOSTAT** and **ADCUSTAT** registers.

#### ADC Sample Sequence Result FIFO 0 (ADCSSFIFO0)

ADC0 base: 0x4003.8000

ADC1 base: 0x4003.9000

Offset 0x048

Type RO, reset -

	31	30	29	28	27	26	25	24	23	22	21	20	19	18	17	16
	reserved															
Type	RO	RO	RO	RO	RO	RO	RO	RO	RO	RO	RO	RO	RO	RO	RO	RO
Reset	0	0	0	0	0	0	0	0	0	0	0	0	0	0	0	0
	15	14	13	12	11	10	9	8	7	6	5	4	3	2	1	0
	reserved						DATA									
Type	RO	RO	RO	RO	RO	RO	RO	RO	RO	RO	RO	RO	RO	RO	RO	RO
Reset	0	0	0	0	0	0	-	-	-	-	-	-	-	-	-	-

Bit/Field	Name	Type	Reset	Description
31:10	reserved	RO	0x0000.00	Software should not rely on the value of a reserved bit. To provide compatibility with future products, the value of a reserved bit should be preserved across a read-modify-write operation.
9:0	DATA	RO	-	Conversion Result Data

**Register 20: ADC Sample Sequence FIFO 0 Status (ADCSSFSTAT0), offset 0x04C**

**Register 21: ADC Sample Sequence FIFO 1 Status (ADCSSFSTAT1), offset 0x06C**

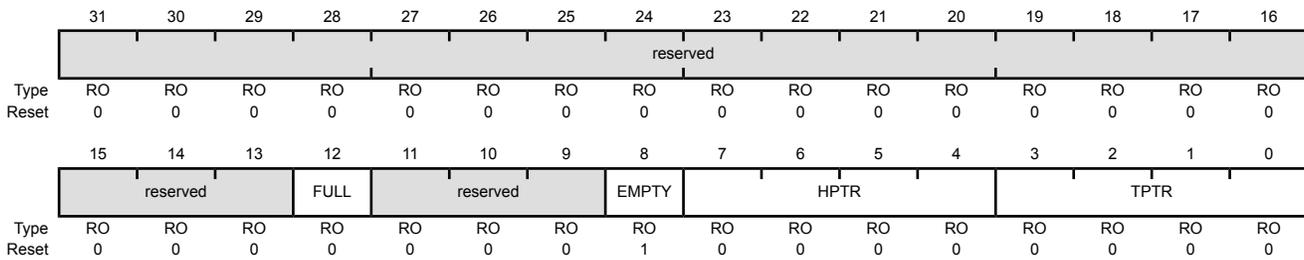
**Register 22: ADC Sample Sequence FIFO 2 Status (ADCSSFSTAT2), offset 0x08C**

**Register 23: ADC Sample Sequence FIFO 3 Status (ADCSSFSTAT3), offset 0x0AC**

This register provides a window into the sample sequencer, providing full/empty status information as well as the positions of the head and tail pointers. The reset value of 0x100 indicates an empty FIFO. The **ADCSSFSTAT0** register provides status on FIFO0, which has 8 entries; **ADCSSFSTAT1** on FIFO1, which has 4 entries; **ADCSSFSTAT2** on FIFO2, which has 4 entries; and **ADCSSFSTAT3** on FIFO3 which has a single entry.

ADC Sample Sequence FIFO 0 Status (ADCSSFSTAT0)

ADC0 base: 0x4003.8000  
 ADC1 base: 0x4003.9000  
 Offset 0x04C  
 Type RO, reset 0x0000.0100



Bit/Field	Name	Type	Reset	Description
31:13	reserved	RO	0x0000.0	Software should not rely on the value of a reserved bit. To provide compatibility with future products, the value of a reserved bit should be preserved across a read-modify-write operation.
12	FULL	RO	0	FIFO Full  Value Description 1 The FIFO is currently full. 0 The FIFO is not currently full.
11:9	reserved	RO	0x0	Software should not rely on the value of a reserved bit. To provide compatibility with future products, the value of a reserved bit should be preserved across a read-modify-write operation.
8	EMPTY	RO	1	FIFO Empty  Value Description 1 The FIFO is currently empty. 0 The FIFO is not currently empty.

---

Bit/Field	Name	Type	Reset	Description
7:4	HPTR	RO	0x0	FIFO Head Pointer  This field contains the current "head" pointer index for the FIFO, that is, the next entry to be written.
3:0	TPTR	RO	0x0	FIFO Tail Pointer  This field contains the current "tail" pointer index for the FIFO, that is, the next entry to be read.

## Register 24: ADC Sample Sequence 0 Operation (ADCSSOP0), offset 0x050

This register determines whether the sample from the given conversion on Sample Sequence 0 is saved in the Sample Sequence FIFO0 or sent to the digital comparator unit.

### ADC Sample Sequence 0 Operation (ADCSSOP0)

ADC0 base: 0x4003.8000  
 ADC1 base: 0x4003.9000  
 Offset 0x050  
 Type R/W, reset 0x0000.0000

	31	30	29	28	27	26	25	24	23	22	21	20	19	18	17	16
	reserved			S7DCOP	reserved			S6DCOP	reserved			S5DCOP	reserved			S4DCOP
Type	RO	RO	RO	R/W	RO	RO	RO	R/W	RO	RO	RO	R/W	RO	RO	RO	R/W
Reset	0	0	0	0	0	0	0	0	0	0	0	0	0	0	0	0
	15	14	13	12	11	10	9	8	7	6	5	4	3	2	1	0
	reserved			S3DCOP	reserved			S2DCOP	reserved			S1DCOP	reserved			S0DCOP
Type	RO	RO	RO	R/W	RO	RO	RO	R/W	RO	RO	RO	R/W	RO	RO	RO	R/W
Reset	0	0	0	0	0	0	0	0	0	0	0	0	0	0	0	0

Bit/Field	Name	Type	Reset	Description
31:29	reserved	RO	0x0	Software should not rely on the value of a reserved bit. To provide compatibility with future products, the value of a reserved bit should be preserved across a read-modify-write operation.
28	S7DCOP	R/W	0	Sample 7 Digital Comparator Operation  Value Description 1 The eighth sample is sent to the digital comparator unit specified by the <i>S7DCSEL</i> bit in the <b>ADCSSDC0</b> register, and the value is not written to the FIFO. 0 The eighth sample is saved in Sample Sequence FIFO0.
27:25	reserved	RO	0x0	Software should not rely on the value of a reserved bit. To provide compatibility with future products, the value of a reserved bit should be preserved across a read-modify-write operation.
24	S6DCOP	R/W	0	Sample 6 Digital Comparator Operation  Same definition as <i>S7DCOP</i> but used during the seventh sample.
23:21	reserved	RO	0x0	Software should not rely on the value of a reserved bit. To provide compatibility with future products, the value of a reserved bit should be preserved across a read-modify-write operation.
20	S5DCOP	R/W	0	Sample 5 Digital Comparator Operation  Same definition as <i>S7DCOP</i> but used during the sixth sample.
19:17	reserved	RO	0x0	Software should not rely on the value of a reserved bit. To provide compatibility with future products, the value of a reserved bit should be preserved across a read-modify-write operation.
16	S4DCOP	R/W	0	Sample 4 Digital Comparator Operation  Same definition as <i>S7DCOP</i> but used during the fifth sample.



Bit/Field	Name	Type	Reset	Description
15:13	reserved	RO	0x0	Software should not rely on the value of a reserved bit. To provide compatibility with future products, the value of a reserved bit should be preserved across a read-modify-write operation.
12	S3DCOP	R/W	0	Sample 3 Digital Comparator Operation Same definition as S7DCOP but used during the fourth sample.
11:9	reserved	RO	0x0	Software should not rely on the value of a reserved bit. To provide compatibility with future products, the value of a reserved bit should be preserved across a read-modify-write operation.
8	S2DCOP	R/W	0	Sample 2 Digital Comparator Operation Same definition as S7DCOP but used during the third sample.
7:5	reserved	RO	0x0	Software should not rely on the value of a reserved bit. To provide compatibility with future products, the value of a reserved bit should be preserved across a read-modify-write operation.
4	S1DCOP	R/W	0	Sample 1 Digital Comparator Operation Same definition as S7DCOP but used during the second sample.
3:1	reserved	RO	0x0	Software should not rely on the value of a reserved bit. To provide compatibility with future products, the value of a reserved bit should be preserved across a read-modify-write operation.
0	S0DCOP	R/W	0	Sample 0 Digital Comparator Operation Same definition as S7DCOP but used during the first sample.

## Register 25: ADC Sample Sequence 0 Digital Comparator Select (ADCSSDC0), offset 0x054

This register determines which digital comparator receives the sample from the given conversion on Sample Sequence 0, if the corresponding  $S_nDCOP$  bit in the **ADCSSOP0** register is set.

### ADC Sample Sequence 0 Digital Comparator Select (ADCSSDC0)

ADC0 base: 0x4003.8000  
 ADC1 base: 0x4003.9000  
 Offset 0x054  
 Type R/W, reset 0x0000.0000

	31	30	29	28	27	26	25	24	23	22	21	20	19	18	17	16
	S7DCSEL				S6DCSEL				S5DCSEL				S4DCSEL			
Type	R/W	R/W	R/W	R/W	R/W	R/W	R/W	R/W	R/W	R/W	R/W	R/W	R/W	R/W	R/W	R/W
Reset	0	0	0	0	0	0	0	0	0	0	0	0	0	0	0	0
	15	14	13	12	11	10	9	8	7	6	5	4	3	2	1	0
	S3DCSEL				S2DCSEL				S1DCSEL				S0DCSEL			
Type	R/W	R/W	R/W	R/W	R/W	R/W	R/W	R/W	R/W	R/W	R/W	R/W	R/W	R/W	R/W	R/W
Reset	0	0	0	0	0	0	0	0	0	0	0	0	0	0	0	0

Bit/Field	Name	Type	Reset	Description																		
31:28	S7DCSEL	R/W	0x0	<p>Sample 7 Digital Comparator Select</p> <p>When the <math>S7DCOP</math> bit in the <b>ADCSSOP0</b> register is set, this field indicates which digital comparator unit (and its associated set of control registers) receives the eighth sample from Sample Sequencer 0.</p> <p><b>Note:</b> Values not listed are reserved.</p> <table border="1"> <thead> <tr> <th>Value</th> <th>Description</th> </tr> </thead> <tbody> <tr><td>0x0</td><td>Digital Comparator Unit 0 (<b>ADCDCOMP0</b> and <b>ADCCCTL0</b>)</td></tr> <tr><td>0x1</td><td>Digital Comparator Unit 1 (<b>ADCDCOMP1</b> and <b>ADCCCTL1</b>)</td></tr> <tr><td>0x2</td><td>Digital Comparator Unit 2 (<b>ADCDCOMP2</b> and <b>ADCCCTL2</b>)</td></tr> <tr><td>0x3</td><td>Digital Comparator Unit 3 (<b>ADCDCOMP3</b> and <b>ADCCCTL3</b>)</td></tr> <tr><td>0x4</td><td>Digital Comparator Unit 4 (<b>ADCDCOMP4</b> and <b>ADCCCTL4</b>)</td></tr> <tr><td>0x5</td><td>Digital Comparator Unit 5 (<b>ADCDCOMP5</b> and <b>ADCCCTL5</b>)</td></tr> <tr><td>0x6</td><td>Digital Comparator Unit 6 (<b>ADCDCOMP6</b> and <b>ADCCCTL6</b>)</td></tr> <tr><td>0x7</td><td>Digital Comparator Unit 7 (<b>ADCDCOMP7</b> and <b>ADCCCTL7</b>)</td></tr> </tbody> </table>	Value	Description	0x0	Digital Comparator Unit 0 ( <b>ADCDCOMP0</b> and <b>ADCCCTL0</b> )	0x1	Digital Comparator Unit 1 ( <b>ADCDCOMP1</b> and <b>ADCCCTL1</b> )	0x2	Digital Comparator Unit 2 ( <b>ADCDCOMP2</b> and <b>ADCCCTL2</b> )	0x3	Digital Comparator Unit 3 ( <b>ADCDCOMP3</b> and <b>ADCCCTL3</b> )	0x4	Digital Comparator Unit 4 ( <b>ADCDCOMP4</b> and <b>ADCCCTL4</b> )	0x5	Digital Comparator Unit 5 ( <b>ADCDCOMP5</b> and <b>ADCCCTL5</b> )	0x6	Digital Comparator Unit 6 ( <b>ADCDCOMP6</b> and <b>ADCCCTL6</b> )	0x7	Digital Comparator Unit 7 ( <b>ADCDCOMP7</b> and <b>ADCCCTL7</b> )
Value	Description																					
0x0	Digital Comparator Unit 0 ( <b>ADCDCOMP0</b> and <b>ADCCCTL0</b> )																					
0x1	Digital Comparator Unit 1 ( <b>ADCDCOMP1</b> and <b>ADCCCTL1</b> )																					
0x2	Digital Comparator Unit 2 ( <b>ADCDCOMP2</b> and <b>ADCCCTL2</b> )																					
0x3	Digital Comparator Unit 3 ( <b>ADCDCOMP3</b> and <b>ADCCCTL3</b> )																					
0x4	Digital Comparator Unit 4 ( <b>ADCDCOMP4</b> and <b>ADCCCTL4</b> )																					
0x5	Digital Comparator Unit 5 ( <b>ADCDCOMP5</b> and <b>ADCCCTL5</b> )																					
0x6	Digital Comparator Unit 6 ( <b>ADCDCOMP6</b> and <b>ADCCCTL6</b> )																					
0x7	Digital Comparator Unit 7 ( <b>ADCDCOMP7</b> and <b>ADCCCTL7</b> )																					
27:24	S6DCSEL	R/W	0x0	<p>Sample 6 Digital Comparator Select</p> <p>This field has the same encodings as <math>S7DCSEL</math> but is used during the seventh sample.</p>																		
23:20	S5DCSEL	R/W	0x0	<p>Sample 5 Digital Comparator Select</p> <p>This field has the same encodings as <math>S7DCSEL</math> but is used during the sixth sample.</p>																		
19:16	S4DCSEL	R/W	0x0	<p>Sample 4 Digital Comparator Select</p> <p>This field has the same encodings as <math>S7DCSEL</math> but is used during the fifth sample.</p>																		

---

Bit/Field	Name	Type	Reset	Description
15:12	S3DCSEL	R/W	0x0	Sample 3 Digital Comparator Select This field has the same encodings as S7DCSEL but is used during the fourth sample.
11:8	S2DCSEL	R/W	0x0	Sample 2 Digital Comparator Select This field has the same encodings as S7DCSEL but is used during the third sample.
7:4	S1DCSEL	R/W	0x0	Sample 1 Digital Comparator Select This field has the same encodings as S7DCSEL but is used during the second sample.
3:0	S0DCSEL	R/W	0x0	Sample 0 Digital Comparator Select This field has the same encodings as S7DCSEL but is used during the first sample.

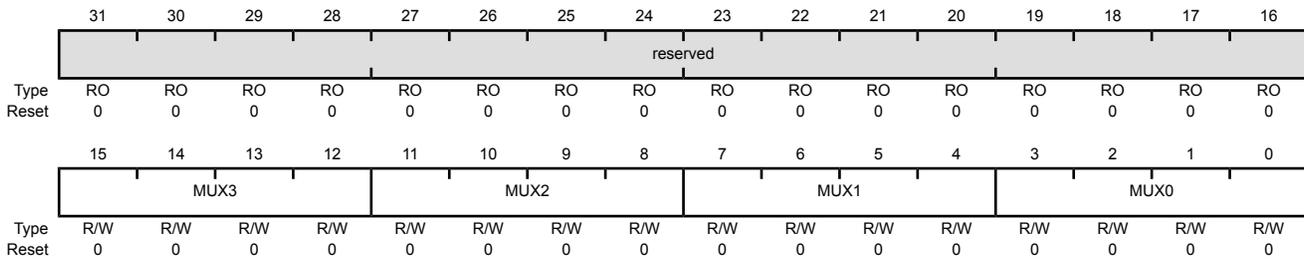
**Register 26: ADC Sample Sequence Input Multiplexer Select 1 (ADCSSMUX1), offset 0x060**

**Register 27: ADC Sample Sequence Input Multiplexer Select 2 (ADCSSMUX2), offset 0x080**

This register defines the analog input configuration for each sample in a sequence executed with Sample Sequencer 1 or 2. These registers are 16 bits wide and contain information for four possible samples. See the **ADCSSMUX0** register on page 552 for detailed bit descriptions. The **ADCSSMUX1** register affects Sample Sequencer 1 and the **ADCSSMUX2** register affects Sample Sequencer 2.

ADC Sample Sequence Input Multiplexer Select 1 (ADCSSMUX1)

ADC0 base: 0x4003.8000  
 ADC1 base: 0x4003.9000  
 Offset 0x060  
 Type R/W, reset 0x0000.0000



Bit/Field	Name	Type	Reset	Description
31:16	reserved	RO	0x0000	Software should not rely on the value of a reserved bit. To provide compatibility with future products, the value of a reserved bit should be preserved across a read-modify-write operation.
15:12	MUX3	R/W	0x0	4th Sample Input Select
11:8	MUX2	R/W	0x0	3rd Sample Input Select
7:4	MUX1	R/W	0x0	2nd Sample Input Select
3:0	MUX0	R/W	0x0	1st Sample Input Select

**Register 28: ADC Sample Sequence Control 1 (ADCSSCTL1), offset 0x064****Register 29: ADC Sample Sequence Control 2 (ADCSSCTL2), offset 0x084**

These registers contain the configuration information for each sample for a sequence executed with Sample Sequencer 1 or 2. When configuring a sample sequence, the **END** bit must be set for the final sample, whether it be after the first sample, fourth sample, or any sample in between. These registers are 16-bits wide and contain information for four possible samples. See the **ADCSSCTL0** register on page 554 for detailed bit descriptions. The **ADCSSCTL1** register configures Sample Sequencer 1 and the **ADCSSCTL2** register configures Sample Sequencer 2.

## ADC Sample Sequence Control 1 (ADCSSCTL1)

ADC0 base: 0x4003.8000  
 ADC1 base: 0x4003.9000  
 Offset 0x064  
 Type R/W, reset 0x0000.0000

	31	30	29	28	27	26	25	24	23	22	21	20	19	18	17	16
	reserved															
Type	RO	RO	RO	RO	RO	RO	RO	RO	RO	RO	RO	RO	RO	RO	RO	RO
Reset	0	0	0	0	0	0	0	0	0	0	0	0	0	0	0	0
	15	14	13	12	11	10	9	8	7	6	5	4	3	2	1	0
	TS3	IE3	END3	D3	TS2	IE2	END2	D2	TS1	IE1	END1	D1	TS0	IE0	END0	D0
Type	R/W	R/W	R/W	R/W	R/W	R/W	R/W	R/W	R/W	R/W	R/W	R/W	R/W	R/W	R/W	R/W
Reset	0	0	0	0	0	0	0	0	0	0	0	0	0	0	0	0

Bit/Field	Name	Type	Reset	Description
31:16	reserved	RO	0x0000	Software should not rely on the value of a reserved bit. To provide compatibility with future products, the value of a reserved bit should be preserved across a read-modify-write operation.
15	TS3	R/W	0	4th Sample Temp Sensor Select Same definition as <b>TS7</b> but used during the fourth sample.
14	IE3	R/W	0	4th Sample Interrupt Enable Same definition as <b>IE7</b> but used during the fourth sample.
13	END3	R/W	0	4th Sample is End of Sequence Same definition as <b>END7</b> but used during the fourth sample.
12	D3	R/W	0	4th Sample Diff Input Select Same definition as <b>D7</b> but used during the fourth sample.
11	TS2	R/W	0	3rd Sample Temp Sensor Select Same definition as <b>TS7</b> but used during the third sample.
10	IE2	R/W	0	3rd Sample Interrupt Enable Same definition as <b>IE7</b> but used during the third sample.
9	END2	R/W	0	3rd Sample is End of Sequence Same definition as <b>END7</b> but used during the third sample.
8	D2	R/W	0	3rd Sample Diff Input Select Same definition as <b>D7</b> but used during the third sample.

Bit/Field	Name	Type	Reset	Description
7	TS1	R/W	0	2nd Sample Temp Sensor Select Same definition as TS7 but used during the second sample.
6	IE1	R/W	0	2nd Sample Interrupt Enable Same definition as IE7 but used during the second sample.
5	END1	R/W	0	2nd Sample is End of Sequence Same definition as END7 but used during the second sample.
4	D1	R/W	0	2nd Sample Diff Input Select Same definition as D7 but used during the second sample.
3	TS0	R/W	0	1st Sample Temp Sensor Select Same definition as TS7 but used during the first sample.
2	IE0	R/W	0	1st Sample Interrupt Enable Same definition as IE7 but used during the first sample.
1	END0	R/W	0	1st Sample is End of Sequence Same definition as END7 but used during the first sample.
0	D0	R/W	0	1st Sample Diff Input Select Same definition as D7 but used during the first sample.

**Register 30: ADC Sample Sequence 1 Operation (ADCSSOP1), offset 0x070****Register 31: ADC Sample Sequence 2 Operation (ADCSSOP2), offset 0x090**

This register determines whether the sample from the given conversion on Sample Sequence n is saved in the Sample Sequence n FIFO or sent to the digital comparator unit. The **ADCSSOP1** register controls Sample Sequencer 1 and the **ADCSSOP2** register controls Sample Sequencer 2.

## ADC Sample Sequence 1 Operation (ADCSSOP1)

ADC0 base: 0x4003.8000  
 ADC1 base: 0x4003.9000  
 Offset 0x070  
 Type R/W, reset 0x0000.0000

	31	30	29	28	27	26	25	24	23	22	21	20	19	18	17	16
	reserved															
Type	RO	RO	RO	RO	RO	RO	RO	RO	RO	RO	RO	RO	RO	RO	RO	RO
Reset	0	0	0	0	0	0	0	0	0	0	0	0	0	0	0	0
	15	14	13	12	11	10	9	8	7	6	5	4	3	2	1	0
	reserved			S3DCOP	reserved			S2DCOP	reserved			S1DCOP	reserved			S0DCOP
Type	RO	RO	RO	R/W	RO	RO	RO	R/W	RO	RO	RO	R/W	RO	RO	RO	R/W
Reset	0	0	0	0	0	0	0	0	0	0	0	0	0	0	0	0

Bit/Field	Name	Type	Reset	Description
31:13	reserved	RO	0x0000.0	Software should not rely on the value of a reserved bit. To provide compatibility with future products, the value of a reserved bit should be preserved across a read-modify-write operation.
12	S3DCOP	R/W	0	Sample 3 Digital Comparator Operation  Value Description 1 The fourth sample is sent to the digital comparator unit specified by the <b>S3DCSEL</b> bit in the <b>ADCSSDC0n</b> register, and the value is not written to the FIFO. 0 The fourth sample is saved in Sample Sequence FIFO.
11:9	reserved	RO	0x0	Software should not rely on the value of a reserved bit. To provide compatibility with future products, the value of a reserved bit should be preserved across a read-modify-write operation.
8	S2DCOP	R/W	0	Sample 2 Digital Comparator Operation  Same definition as <b>S3DCOP</b> but used during the third sample.
7:5	reserved	RO	0x0	Software should not rely on the value of a reserved bit. To provide compatibility with future products, the value of a reserved bit should be preserved across a read-modify-write operation.
4	S1DCOP	R/W	0	Sample 1 Digital Comparator Operation  Same definition as <b>S3DCOP</b> but used during the second sample.
3:1	reserved	RO	0x0	Software should not rely on the value of a reserved bit. To provide compatibility with future products, the value of a reserved bit should be preserved across a read-modify-write operation.
0	S0DCOP	R/W	0	Sample 0 Digital Comparator Operation  Same definition as <b>S3DCOP</b> but used during the first sample.

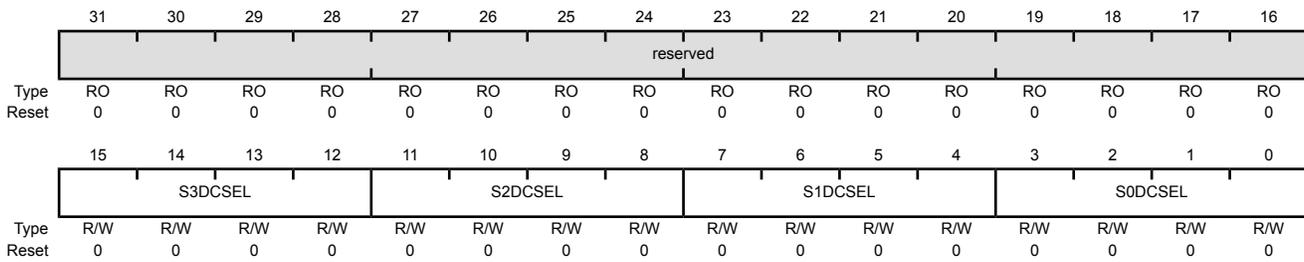
**Register 32: ADC Sample Sequence 1 Digital Comparator Select (ADCSSDC1), offset 0x074**

**Register 33: ADC Sample Sequence 2 Digital Comparator Select (ADCSSDC2), offset 0x094**

These registers determine which digital comparator receives the sample from the given conversion on Sample Sequence n if the corresponding  $S_nDCOP$  bit in the **ADCSSOPn** register is set. The **ADCSSDC1** register controls the selection for Sample Sequencer 1 and the **ADCSSDC2** register controls the selection for Sample Sequencer 2.

ADC Sample Sequence 1 Digital Comparator Select (ADCSSDC1)

ADC0 base: 0x4003.8000  
 ADC1 base: 0x4003.9000  
 Offset 0x074  
 Type R/W, reset 0x0000.0000



Bit/Field	Name	Type	Reset	Description																		
31:16	reserved	RO	0x0000	Software should not rely on the value of a reserved bit. To provide compatibility with future products, the value of a reserved bit should be preserved across a read-modify-write operation.																		
15:12	S3DCSEL	R/W	0x0	<p>Sample 3 Digital Comparator Select</p> <p>When the <math>S3DCOP</math> bit in the <b>ADCSSOPn</b> register is set, this field indicates which digital comparator unit (and its associated set of control registers) receives the eighth sample from Sample Sequencer n.</p> <p><b>Note:</b> Values not listed are reserved.</p> <table border="1"> <thead> <tr> <th>Value</th> <th>Description</th> </tr> </thead> <tbody> <tr><td>0x0</td><td>Digital Comparator Unit 0 (<b>ADCDCOMP0</b> and <b>ADCCCTL0</b>)</td></tr> <tr><td>0x1</td><td>Digital Comparator Unit 1 (<b>ADCDCOMP1</b> and <b>ADCCCTL1</b>)</td></tr> <tr><td>0x2</td><td>Digital Comparator Unit 2 (<b>ADCDCOMP2</b> and <b>ADCCCTL2</b>)</td></tr> <tr><td>0x3</td><td>Digital Comparator Unit 3 (<b>ADCDCOMP3</b> and <b>ADCCCTL3</b>)</td></tr> <tr><td>0x4</td><td>Digital Comparator Unit 4 (<b>ADCDCOMP4</b> and <b>ADCCCTL4</b>)</td></tr> <tr><td>0x5</td><td>Digital Comparator Unit 5 (<b>ADCDCOMP5</b> and <b>ADCCCTL5</b>)</td></tr> <tr><td>0x6</td><td>Digital Comparator Unit 6 (<b>ADCDCOMP6</b> and <b>ADCCCTL6</b>)</td></tr> <tr><td>0x7</td><td>Digital Comparator Unit 7 (<b>ADCDCOMP7</b> and <b>ADCCCTL7</b>)</td></tr> </tbody> </table>	Value	Description	0x0	Digital Comparator Unit 0 ( <b>ADCDCOMP0</b> and <b>ADCCCTL0</b> )	0x1	Digital Comparator Unit 1 ( <b>ADCDCOMP1</b> and <b>ADCCCTL1</b> )	0x2	Digital Comparator Unit 2 ( <b>ADCDCOMP2</b> and <b>ADCCCTL2</b> )	0x3	Digital Comparator Unit 3 ( <b>ADCDCOMP3</b> and <b>ADCCCTL3</b> )	0x4	Digital Comparator Unit 4 ( <b>ADCDCOMP4</b> and <b>ADCCCTL4</b> )	0x5	Digital Comparator Unit 5 ( <b>ADCDCOMP5</b> and <b>ADCCCTL5</b> )	0x6	Digital Comparator Unit 6 ( <b>ADCDCOMP6</b> and <b>ADCCCTL6</b> )	0x7	Digital Comparator Unit 7 ( <b>ADCDCOMP7</b> and <b>ADCCCTL7</b> )
Value	Description																					
0x0	Digital Comparator Unit 0 ( <b>ADCDCOMP0</b> and <b>ADCCCTL0</b> )																					
0x1	Digital Comparator Unit 1 ( <b>ADCDCOMP1</b> and <b>ADCCCTL1</b> )																					
0x2	Digital Comparator Unit 2 ( <b>ADCDCOMP2</b> and <b>ADCCCTL2</b> )																					
0x3	Digital Comparator Unit 3 ( <b>ADCDCOMP3</b> and <b>ADCCCTL3</b> )																					
0x4	Digital Comparator Unit 4 ( <b>ADCDCOMP4</b> and <b>ADCCCTL4</b> )																					
0x5	Digital Comparator Unit 5 ( <b>ADCDCOMP5</b> and <b>ADCCCTL5</b> )																					
0x6	Digital Comparator Unit 6 ( <b>ADCDCOMP6</b> and <b>ADCCCTL6</b> )																					
0x7	Digital Comparator Unit 7 ( <b>ADCDCOMP7</b> and <b>ADCCCTL7</b> )																					
11:8	S2DCSEL	R/W	0x0	<p>Sample 2 Digital Comparator Select</p> <p>This field has the same encodings as <b>S3DCSEL</b> but is used during the third sample.</p>																		



---

Bit/Field	Name	Type	Reset	Description
7:4	S1DCSEL	R/W	0x0	Sample 1 Digital Comparator Select This field has the same encodings as S3DCSEL but is used during the second sample.
3:0	S0DCSEL	R/W	0x0	Sample 0 Digital Comparator Select This field has the same encodings as S3DCSEL but is used during the first sample.

### Register 34: ADC Sample Sequence Input Multiplexer Select 3 (ADCSSMUX3), offset 0x0A0

This register defines the analog input configuration for the sample executed with Sample Sequencer 3. This register is 4 bits wide and contains information for one possible sample. See the **ADCSSMUX0** register on page 552 for detailed bit descriptions.

#### ADC Sample Sequence Input Multiplexer Select 3 (ADCSSMUX3)

ADC0 base: 0x4003.8000  
 ADC1 base: 0x4003.9000  
 Offset 0x0A0  
 Type R/W, reset 0x0000.0000

	31	30	29	28	27	26	25	24	23	22	21	20	19	18	17	16
	reserved															
Type	RO	RO	RO	RO	RO	RO	RO	RO	RO	RO	RO	RO	RO	RO	RO	RO
Reset	0	0	0	0	0	0	0	0	0	0	0	0	0	0	0	0
	15	14	13	12	11	10	9	8	7	6	5	4	3	2	1	0
	reserved												MUX0			
Type	RO	RO	RO	RO	RO	RO	RO	RO	RO	RO	RO	RO	R/W	R/W	R/W	R/W
Reset	0	0	0	0	0	0	0	0	0	0	0	0	0	0	0	0

Bit/Field	Name	Type	Reset	Description
31:4	reserved	RO	0x0000.000	Software should not rely on the value of a reserved bit. To provide compatibility with future products, the value of a reserved bit should be preserved across a read-modify-write operation.
3:0	MUX0	R/W	0	1st Sample Input Select

**Register 35: ADC Sample Sequence Control 3 (ADCSSCTL3), offset 0x0A4**

This register contains the configuration information for a sample executed with Sample Sequencer 3. The `END0` bit is always set as this sequencer can execute only one sample. This register is 4 bits wide and contains information for one possible sample. See the `ADCSSCTL0` register on page 554 for detailed bit descriptions.

## ADC Sample Sequence Control 3 (ADCSSCTL3)

ADC0 base: 0x4003.8000  
 ADC1 base: 0x4003.9000  
 Offset 0x0A4  
 Type R/W, reset 0x0000.0002

	31	30	29	28	27	26	25	24	23	22	21	20	19	18	17	16	
	reserved																
Type	RO	RO	RO	RO	RO	RO	RO	RO	RO	RO	RO	RO	RO	RO	RO	RO	
Reset	0	0	0	0	0	0	0	0	0	0	0	0	0	0	0	0	
	15	14	13	12	11	10	9	8	7	6	5	4	3	2	1	0	
	reserved												TS0	IE0	END0	D0	
Type	RO	RO	RO	RO	RO	RO	RO	RO	RO	RO	RO	RO	RO	R/W	R/W	R/W	R/W
Reset	0	0	0	0	0	0	0	0	0	0	0	0	0	0	0	1	0

Bit/Field	Name	Type	Reset	Description
31:4	reserved	RO	0x0000.000	Software should not rely on the value of a reserved bit. To provide compatibility with future products, the value of a reserved bit should be preserved across a read-modify-write operation.
3	TS0	R/W	0	1st Sample Temp Sensor Select Same definition as <code>TS7</code> but used during the first sample.
2	IE0	R/W	0	1st Sample Interrupt Enable Same definition as <code>IE7</code> but used during the first sample.
1	END0	R/W	1	1st Sample is End of Sequence Same definition as <code>END7</code> but used during the first sample. Because this sequencer has only one entry, this bit must be set.
0	D0	R/W	0	1st Sample Diff Input Select Same definition as <code>D7</code> but used during the first sample.

### Register 36: ADC Sample Sequence 3 Operation (ADCSSOP3), offset 0x0B0

This register determines whether the sample from the given conversion on Sample Sequence 3 is saved in the Sample Sequence 3 FIFO or sent to the digital comparator unit.

#### ADC Sample Sequence 3 Operation (ADCSSOP3)

ADC0 base: 0x4003.8000  
 ADC1 base: 0x4003.9000  
 Offset 0x0B0  
 Type R/W, reset 0x0000.0000

	31	30	29	28	27	26	25	24	23	22	21	20	19	18	17	16	
	reserved																
Type	RO	RO	RO	RO	RO	RO	RO	RO	RO	RO	RO	RO	RO	RO	RO	RO	
Reset	0	0	0	0	0	0	0	0	0	0	0	0	0	0	0	0	
	15	14	13	12	11	10	9	8	7	6	5	4	3	2	1	0	
	reserved															S0DCOP	
Type	RO	RO	RO	RO	RO	RO	RO	RO	RO	RO	RO	RO	RO	RO	RO	RO	R/W
Reset	0	0	0	0	0	0	0	0	0	0	0	0	0	0	0	0	0

Bit/Field	Name	Type	Reset	Description
31:1	reserved	RO	0x0000.000	Software should not rely on the value of a reserved bit. To provide compatibility with future products, the value of a reserved bit should be preserved across a read-modify-write operation.
0	S0DCOP	R/W	0	Sample 0 Digital Comparator Operation
				Value Description
				1 The sample is sent to the digital comparator unit specified by the S0DCSEL bit in the <b>ADCSSDC03</b> register, and the value is not written to the FIFO.
				0 The sample is saved in Sample Sequence FIFO3.

## Register 37: ADC Sample Sequence 3 Digital Comparator Select (ADCSSDC3), offset 0x0B4

This register determines which digital comparator receives the sample from the given conversion on Sample Sequence 3 if the corresponding  $S_{nDCOP}$  bit in the **ADCSSOP3** register is set.

### ADC Sample Sequence 3 Digital Comparator Select (ADCSSDC3)

ADC0 base: 0x4003.8000  
 ADC1 base: 0x4003.9000  
 Offset 0x0B4  
 Type R/W, reset 0x0000.0000

	31	30	29	28	27	26	25	24	23	22	21	20	19	18	17	16
	reserved															
Type	RO	RO	RO	RO	RO	RO	RO	RO	RO	RO	RO	RO	RO	RO	RO	RO
Reset	0	0	0	0	0	0	0	0	0	0	0	0	0	0	0	0
	15	14	13	12	11	10	9	8	7	6	5	4	3	2	1	0
	reserved												S0DCSEL			
Type	RO	RO	RO	RO	RO	RO	RO	RO	RO	RO	RO	RO	R/W	R/W	R/W	R/W
Reset	0	0	0	0	0	0	0	0	0	0	0	0	0	0	0	0

Bit/Field	Name	Type	Reset	Description
31:4	reserved	RO	0x0000.000	Software should not rely on the value of a reserved bit. To provide compatibility with future products, the value of a reserved bit should be preserved across a read-modify-write operation.
3:0	S0DCSEL	R/W	0x0	Sample 0 Digital Comparator Select

When the  $S_{0DCOP}$  bit in the **ADCSSOP3** register is set, this field indicates which digital comparator unit (and its associated set of control registers) receives the sample from Sample Sequencer 3.

**Note:** Values not listed are reserved.

Value	Description
0x0	Digital Comparator Unit 0 ( <b>ADCDCOMP0</b> and <b>ADCCCTL0</b> )
0x1	Digital Comparator Unit 1 ( <b>ADCDCOMP1</b> and <b>ADCCCTL1</b> )
0x2	Digital Comparator Unit 2 ( <b>ADCDCOMP2</b> and <b>ADCCCTL2</b> )
0x3	Digital Comparator Unit 3 ( <b>ADCDCOMP3</b> and <b>ADCCCTL3</b> )
0x4	Digital Comparator Unit 4 ( <b>ADCDCOMP4</b> and <b>ADCCCTL4</b> )
0x5	Digital Comparator Unit 5 ( <b>ADCDCOMP5</b> and <b>ADCCCTL5</b> )
0x6	Digital Comparator Unit 6 ( <b>ADCDCOMP6</b> and <b>ADCCCTL6</b> )
0x7	Digital Comparator Unit 7 ( <b>ADCDCOMP7</b> and <b>ADCCCTL7</b> )

### Register 38: ADC Digital Comparator Reset Initial Conditions (ADCDCRIC), offset 0xD00

This register provides the ability to reset any of the digital comparator interrupt or trigger functions back to their initial conditions. Resetting these functions ensures that the data that is being used by the interrupt and trigger functions in the digital comparator unit is not stale.

#### ADC Digital Comparator Reset Initial Conditions (ADCDCRIC)

ADC0 base: 0x4003.8000  
 ADC1 base: 0x4003.9000  
 Offset 0xD00  
 Type R/W, reset 0x0000.0000

	31	30	29	28	27	26	25	24	23	22	21	20	19	18	17	16
	reserved								DCTRIG7	DCTRIG6	DCTRIG5	DCTRIG4	DCTRIG3	DCTRIG2	DCTRIG1	DCTRIG0
Type	RO	RO	RO	RO	RO	RO	RO	RO	R/W	R/W	R/W	R/W	R/W	R/W	R/W	R/W
Reset	0	0	0	0	0	0	0	0	0	0	0	0	0	0	0	0
	15	14	13	12	11	10	9	8	7	6	5	4	3	2	1	0
	reserved								DCINT7	DCINT6	DCINT5	DCINT4	DCINT3	DCINT2	DCINT1	DCINT0
Type	RO	RO	RO	RO	RO	RO	RO	RO	R/W	R/W	R/W	R/W	R/W	R/W	R/W	R/W
Reset	0	0	0	0	0	0	0	0	0	0	0	0	0	0	0	0

Bit/Field	Name	Type	Reset	Description
31:24	reserved	RO	0x00	Software should not rely on the value of a reserved bit. To provide compatibility with future products, the value of a reserved bit should be preserved across a read-modify-write operation.
23	DCTRIG7	R/W	0	<p>Digital Comparator Trigger 7</p> <p>Value Description</p> <p>1 Resets the Digital Comparator 7 trigger unit to its initial conditions.</p> <p>0 No effect.</p> <p>When the trigger has been cleared, this bit is automatically cleared.</p> <p>Because the digital comparators use the current and previous ADC conversion values to determine when to assert the trigger, it is important to reset the digital comparator to initial conditions when starting a new sequence so that stale data is not used.</p>
22	DCTRIG6	R/W	0	<p>Digital Comparator Trigger 6</p> <p>Value Description</p> <p>1 Resets the Digital Comparator 6 trigger unit to its initial conditions.</p> <p>0 No effect.</p> <p>When the trigger has been cleared, this bit is automatically cleared.</p> <p>Because the digital comparators use the current and previous ADC conversion values to determine when to assert the trigger, it is important to reset the digital comparator to initial conditions when starting a new sequence so that stale data is not used.</p>

Bit/Field	Name	Type	Reset	Description
21	DCTRIG5	R/W	0	<p>Digital Comparator Trigger 5</p> <p>Value Description</p> <p>1 Resets the Digital Comparator 5 trigger unit to its initial conditions.</p> <p>0 No effect.</p> <p>When the trigger has been cleared, this bit is automatically cleared.</p> <p>Because the digital comparators use the current and previous ADC conversion values to determine when to assert the trigger, it is important to reset the digital comparator to initial conditions when starting a new sequence so that stale data is not used.</p>
20	DCTRIG4	R/W	0	<p>Digital Comparator Trigger 4</p> <p>Value Description</p> <p>1 Resets the Digital Comparator 4 trigger unit to its initial conditions.</p> <p>0 No effect.</p> <p>When the trigger has been cleared, this bit is automatically cleared.</p> <p>Because the digital comparators use the current and previous ADC conversion values to determine when to assert the trigger, it is important to reset the digital comparator to initial conditions when starting a new sequence so that stale data is not used.</p>
19	DCTRIG3	R/W	0	<p>Digital Comparator Trigger 3</p> <p>Value Description</p> <p>1 Resets the Digital Comparator 3 trigger unit to its initial conditions.</p> <p>0 No effect.</p> <p>When the trigger has been cleared, this bit is automatically cleared.</p> <p>Because the digital comparators use the current and previous ADC conversion values to determine when to assert the trigger, it is important to reset the digital comparator to initial conditions when starting a new sequence so that stale data is not used.</p>
18	DCTRIG2	R/W	0	<p>Digital Comparator Trigger 2</p> <p>Value Description</p> <p>1 Resets the Digital Comparator 2 trigger unit to its initial conditions.</p> <p>0 No effect.</p> <p>When the trigger has been cleared, this bit is automatically cleared.</p> <p>Because the digital comparators use the current and previous ADC conversion values to determine when to assert the trigger, it is important to reset the digital comparator to initial conditions when starting a new sequence so that stale data is not used.</p>

Bit/Field	Name	Type	Reset	Description
17	DCTRIG1	R/W	0	<p>Digital Comparator Trigger 1</p> <p>Value Description</p> <p>1 Resets the Digital Comparator 1 trigger unit to its initial conditions.</p> <p>0 No effect.</p> <p>When the trigger has been cleared, this bit is automatically cleared.</p> <p>Because the digital comparators use the current and previous ADC conversion values to determine when to assert the trigger, it is important to reset the digital comparator to initial conditions when starting a new sequence so that stale data is not used.</p>
16	DCTRIG0	R/W	0	<p>Digital Comparator Trigger 0</p> <p>Value Description</p> <p>1 Resets the Digital Comparator 0 trigger unit to its initial conditions.</p> <p>0 No effect.</p> <p>When the trigger has been cleared, this bit is automatically cleared.</p> <p>Because the digital comparators use the current and previous ADC conversion values to determine when to assert the trigger, it is important to reset the digital comparator to initial conditions when starting a new sequence so that stale data is not used.</p>
15:8	reserved	RO	0x00	<p>Software should not rely on the value of a reserved bit. To provide compatibility with future products, the value of a reserved bit should be preserved across a read-modify-write operation.</p>
7	DCINT7	R/W	0	<p>Digital Comparator Interrupt 7</p> <p>Value Description</p> <p>1 Resets the Digital Comparator 7 interrupt unit to its initial conditions.</p> <p>0 No effect.</p> <p>When the interrupt has been cleared, this bit is automatically cleared.</p> <p>Because the digital comparators use the current and previous ADC conversion values to determine when to assert the interrupt, it is important to reset the digital comparator to initial conditions when starting a new sequence so that stale data is not used.</p>



Bit/Field	Name	Type	Reset	Description
6	DCINT6	R/W	0	<p>Digital Comparator Interrupt 6</p> <p>Value Description</p> <p>1 Resets the Digital Comparator 6 interrupt unit to its initial conditions.</p> <p>0 No effect.</p> <p>When the interrupt has been cleared, this bit is automatically cleared.</p> <p>Because the digital comparators use the current and previous ADC conversion values to determine when to assert the interrupt, it is important to reset the digital comparator to initial conditions when starting a new sequence so that stale data is not used.</p>
5	DCINT5	R/W	0	<p>Digital Comparator Interrupt 5</p> <p>Value Description</p> <p>1 Resets the Digital Comparator 5 interrupt unit to its initial conditions.</p> <p>0 No effect.</p> <p>When the interrupt has been cleared, this bit is automatically cleared.</p> <p>Because the digital comparators use the current and previous ADC conversion values to determine when to assert the interrupt, it is important to reset the digital comparator to initial conditions when starting a new sequence so that stale data is not used.</p>
4	DCINT4	R/W	0	<p>Digital Comparator Interrupt 4</p> <p>Value Description</p> <p>1 Resets the Digital Comparator 4 interrupt unit to its initial conditions.</p> <p>0 No effect.</p> <p>When the interrupt has been cleared, this bit is automatically cleared.</p> <p>Because the digital comparators use the current and previous ADC conversion values to determine when to assert the interrupt, it is important to reset the digital comparator to initial conditions when starting a new sequence so that stale data is not used.</p>
3	DCINT3	R/W	0	<p>Digital Comparator Interrupt 3</p> <p>Value Description</p> <p>1 Resets the Digital Comparator 3 interrupt unit to its initial conditions.</p> <p>0 No effect.</p> <p>When the interrupt has been cleared, this bit is automatically cleared.</p> <p>Because the digital comparators use the current and previous ADC conversion values to determine when to assert the interrupt, it is important to reset the digital comparator to initial conditions when starting a new sequence so that stale data is not used.</p>

Bit/Field	Name	Type	Reset	Description
2	DCINT2	R/W	0	<p>Digital Comparator Interrupt 2</p> <p>Value Description</p> <p>1 Resets the Digital Comparator 2 interrupt unit to its initial conditions.</p> <p>0 No effect.</p> <p>When the interrupt has been cleared, this bit is automatically cleared.</p> <p>Because the digital comparators use the current and previous ADC conversion values to determine when to assert the interrupt, it is important to reset the digital comparator to initial conditions when starting a new sequence so that stale data is not used.</p>
1	DCINT1	R/W	0	<p>Digital Comparator Interrupt 1</p> <p>Value Description</p> <p>1 Resets the Digital Comparator 1 interrupt unit to its initial conditions.</p> <p>0 No effect.</p> <p>When the interrupt has been cleared, this bit is automatically cleared.</p> <p>Because the digital comparators use the current and previous ADC conversion values to determine when to assert the interrupt, it is important to reset the digital comparator to initial conditions when starting a new sequence so that stale data is not used.</p>
0	DCINT0	R/W	0	<p>Digital Comparator Interrupt 0</p> <p>Value Description</p> <p>1 Resets the Digital Comparator 0 interrupt unit to its initial conditions.</p> <p>0 No effect.</p> <p>When the interrupt has been cleared, this bit is automatically cleared.</p> <p>Because the digital comparators use the current and previous ADC conversion values to determine when to assert the interrupt, it is important to reset the digital comparator to initial conditions when starting a new sequence so that stale data is not used.</p>

**Register 39: ADC Digital Comparator Control 0 (ADCDCCTL0), offset 0xE00**

**Register 40: ADC Digital Comparator Control 1 (ADCDCCTL1), offset 0xE04**

**Register 41: ADC Digital Comparator Control 2 (ADCDCCTL2), offset 0xE08**

**Register 42: ADC Digital Comparator Control 3 (ADCDCCTL3), offset 0xE0C**

**Register 43: ADC Digital Comparator Control 4 (ADCDCCTL4), offset 0xE10**

**Register 44: ADC Digital Comparator Control 5 (ADCDCCTL5), offset 0xE14**

**Register 45: ADC Digital Comparator Control 6 (ADCDCCTL6), offset 0xE18**

**Register 46: ADC Digital Comparator Control 7 (ADCDCCTL7), offset 0xE1C**

This register provides the comparison encodings that generate an interrupt or PWM trigger.

#### ADC Digital Comparator Control 0 (ADCDCCTL0)

ADC0 base: 0x4003.8000

ADC1 base: 0x4003.9000

Offset 0xE00

Type R/W, reset 0x0000.0000

	31	30	29	28	27	26	25	24	23	22	21	20	19	18	17	16		
	reserved																	
Type	RO	RO	RO	RO	RO	RO	RO	RO	RO	RO	RO	RO	RO	RO	RO	RO		
Reset	0	0	0	0	0	0	0	0	0	0	0	0	0	0	0	0		
	15	14	13	12	11	10	9	8	7	6	5	4	3	2	1	0		
	reserved			CTE	CTC			CTM			reserved			CIE	CIC		CIM	
Type	RO	RO	RO	R/W	R/W	R/W	R/W	R/W	RO	RO	RO	R/W	R/W	R/W	R/W	R/W		
Reset	0	0	0	0	0	0	0	0	0	0	0	0	0	0	0	0		

Bit/Field	Name	Type	Reset	Description
31:13	reserved	RO	0x0000.0	Software should not rely on the value of a reserved bit. To provide compatibility with future products, the value of a reserved bit should be preserved across a read-modify-write operation.
12	CTE	R/W	0	Comparison Trigger Enable
				Value Description
			1	Enables the trigger function state machine. The ADC conversion data is used to determine if a trigger should be generated according to the programming of the CTC and CTM fields.
			0	Disables the trigger function state machine. ADC conversion data is ignored by the trigger function.

Bit/Field	Name	Type	Reset	Description
11:10	CTC	R/W	0x0	<p>Comparison Trigger Condition</p> <p>This field specifies the operational region in which a trigger is generated when the ADC conversion data is compared against the values of <code>COMP0</code> and <code>COMP1</code>. The <code>COMP0</code> and <code>COMP1</code> fields are defined in the <b>ADCDCMPx</b> registers.</p> <p>Value Description</p> <p>0x0 Low Band  <math>ADC\ Data &lt; COMP0\ and &lt; COMP1</math></p> <p>0x1 Mid Band  <math>COMP0 \leq ADC\ Data &lt; COMP1</math></p> <p>0x2 reserved</p> <p>0x3 High Band  <math>COMP0 \leq COMP1 \leq ADC\ Data</math></p>
9:8	CTM	R/W	0x0	<p>Comparison Trigger Mode</p> <p>This field specifies the mode by which the trigger comparison is made.</p> <p>Value Description</p> <p>0x0 Always  This mode generates a trigger every time the ADC conversion data falls within the selected operational region.</p> <p>0x1 Once  This mode generates a trigger the first time that the ADC conversion data enters the selected operational region.</p> <p>0x2 Hysteresis Always  This mode generates a trigger when the ADC conversion data falls within the selected operational region and continues to generate the trigger until the hysteresis condition is cleared by entering the opposite operational region.  Note that the hysteresis modes are only defined for <code>CTC</code> encodings of 0x0 and 0x3.</p> <p>0x3 Hysteresis Once  This mode generates a trigger the first time that the ADC conversion data falls within the selected operational region. No additional triggers are generated until the hysteresis condition is cleared by entering the opposite operational region.  Note that the hysteresis modes are only defined for <code>CTC</code> encodings of 0x0 and 0x3.</p>
7:5	reserved	RO	0x0	<p>Software should not rely on the value of a reserved bit. To provide compatibility with future products, the value of a reserved bit should be preserved across a read-modify-write operation.</p>

Bit/Field	Name	Type	Reset	Description
4	CIE	R/W	0	<p>Comparison Interrupt Enable</p> <p>Value Description</p> <p>1 Enables the comparison interrupt. The ADC conversion data is used to determine if an interrupt should be generated according to the programming of the CIE and CIM fields.</p> <p>0 Disables the comparison interrupt. ADC conversion data has no effect on interrupt generation.</p>
3:2	CIC	R/W	0x0	<p>Comparison Interrupt Condition</p> <p>This field specifies the operational region in which an interrupt is generated when the ADC conversion data is compared against the values of COMP0 and COMP1. The COMP0 and COMP1 fields are defined in the ADCDCMPx registers.</p> <p>Value Description</p> <p>0x0 Low Band ADC Data &lt; COMP0 and &lt; COMP1</p> <p>0x1 Mid Band COMP0 ≤ ADC Data &lt; COMP1</p> <p>0x2 reserved</p> <p>0x3 High Band COMP0 &lt; COMP1 ≤ ADC Data</p>

Bit/Field	Name	Type	Reset	Description
1:0	CIM	R/W	0x0	<p>Comparison Interrupt Mode</p> <p>This field specifies the mode by which the interrupt comparison is made.</p> <p>Value Description</p> <p>0x0 Always</p> <p>This mode generates an interrupt every time the ADC conversion data falls within the selected operational region.</p> <p>0x1 Once</p> <p>This mode generates an interrupt the first time that the ADC conversion data enters the selected operational region.</p> <p>0x2 Hysteresis Always</p> <p>This mode generates an interrupt when the ADC conversion data falls within the selected operational region and continues to generate the interrupt until the hysteresis condition is cleared by entering the opposite operational region.</p> <p>Note that the hysteresis modes are only defined for CTC encodings of 0x0 and 0x3.</p> <p>0x3 Hysteresis Once</p> <p>This mode generates an interrupt the first time that the ADC conversion data falls within the selected operational region. No additional interrupts are generated until the hysteresis condition is cleared by entering the opposite operational region.</p> <p>Note that the hysteresis modes are only defined for CTC encodings of 0x0 and 0x3.</p>

**Register 47: ADC Digital Comparator Range 0 (ADCDCMP0), offset 0xE40**

**Register 48: ADC Digital Comparator Range 1 (ADCDCMP1), offset 0xE44**

**Register 49: ADC Digital Comparator Range 2 (ADCDCMP2), offset 0xE48**

**Register 50: ADC Digital Comparator Range 3 (ADCDCMP3), offset 0xE4C**

**Register 51: ADC Digital Comparator Range 4 (ADCDCMP4), offset 0xE50**

**Register 52: ADC Digital Comparator Range 5 (ADCDCMP5), offset 0xE54**

**Register 53: ADC Digital Comparator Range 6 (ADCDCMP6), offset 0xE58**

**Register 54: ADC Digital Comparator Range 7 (ADCDCMP7), offset 0xE5C**

This register defines the comparison values that are used to determine if the ADC conversion data falls in the appropriate operating region.

**Note:** The value in the COMP1 field must be greater than or equal to the value in the COMP0 field or unexpected results can occur.

#### ADC Digital Comparator Range 0 (ADCDCMP0)

ADC0 base: 0x4003.8000

ADC1 base: 0x4003.9000

Offset 0xE40

Type R/W, reset 0x0000.0000

	31	30	29	28	27	26	25	24	23	22	21	20	19	18	17	16
	reserved						COMP1									
Type	RO	RO	RO	RO	RO	RO	R/W	R/W	R/W	R/W	R/W	R/W	R/W	R/W	R/W	R/W
Reset	0	0	0	0	0	0	0	0	0	0	0	0	0	0	0	0
	15	14	13	12	11	10	9	8	7	6	5	4	3	2	1	0
	reserved						COMP0									
Type	RO	RO	RO	RO	RO	RO	R/W	R/W	R/W	R/W	R/W	R/W	R/W	R/W	R/W	R/W
Reset	0	0	0	0	0	0	0	0	0	0	0	0	0	0	0	0

Bit/Field	Name	Type	Reset	Description
31:26	reserved	RO	0x0	Software should not rely on the value of a reserved bit. To provide compatibility with future products, the value of a reserved bit should be preserved across a read-modify-write operation.
25:16	COMP1	R/W	0x000	Compare 1  The value in this field is compared against the ADC conversion data. The result of the comparison is used to determine if the data lies within the high-band region.  Note that the value of COMP1 must be greater than or equal to the value of COMP0.
15:10	reserved	RO	0x0	Software should not rely on the value of a reserved bit. To provide compatibility with future products, the value of a reserved bit should be preserved across a read-modify-write operation.
9:0	COMP0	R/W	0x000	Compare 0  The value in this field is compared against the ADC conversion data. The result of the comparison is used to determine if the data lies within the low-band region.

## 14 Universal Asynchronous Receivers/Transmitters (UARTs)

The Stellaris<sup>®</sup> LM3S9B96 controller includes three Universal Asynchronous Receiver/Transmitter (UART) with the following features:

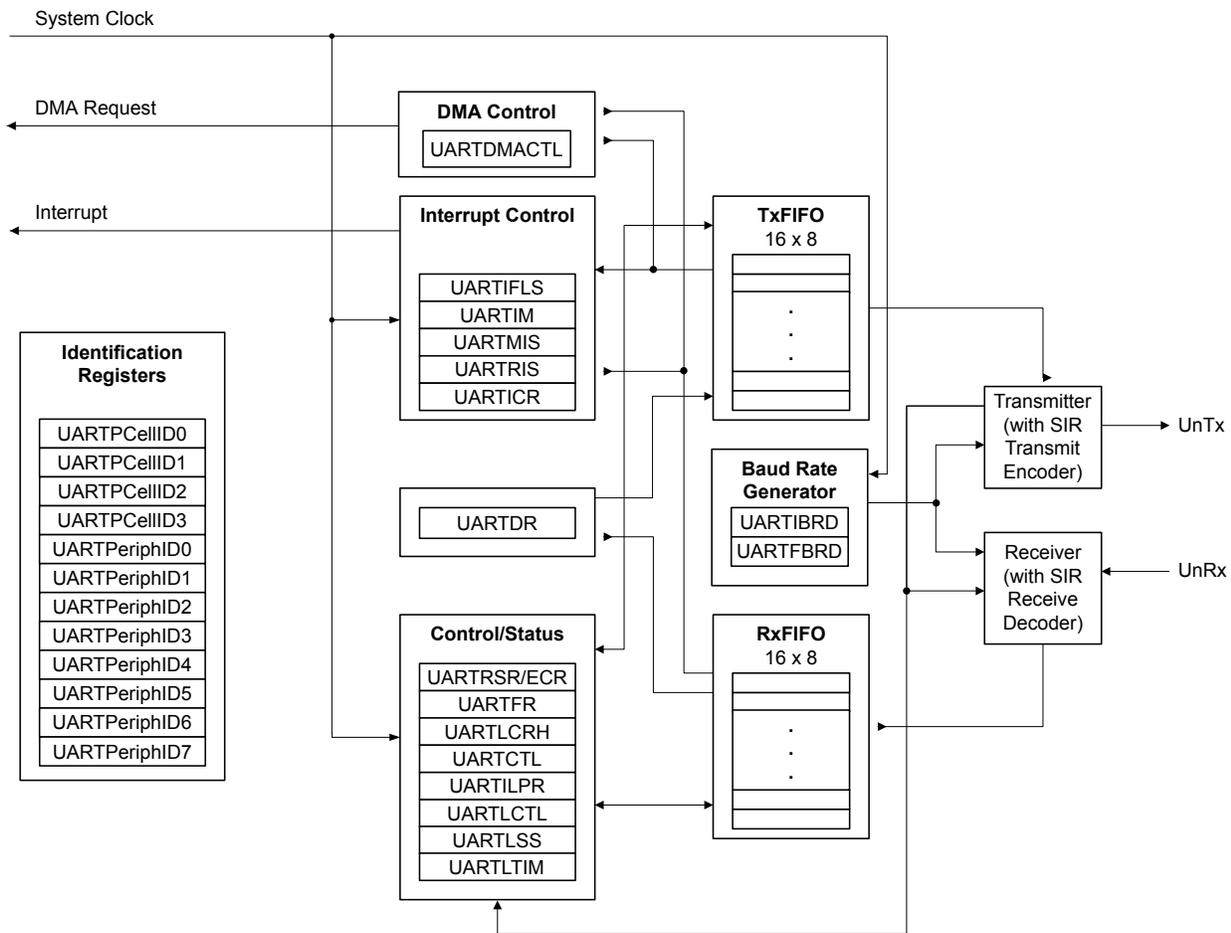
- Programmable baud-rate generator allowing speeds up to 5 Mbps for regular speed (divide by 16) and 10 Mbps for high speed (divide by 8)
- Separate 16x8 transmit (TX) and receive (RX) FIFOs to reduce CPU interrupt service loading
- Programmable FIFO length, including 1-byte deep operation providing conventional double-buffered interface
- FIFO trigger levels of 1/8, 1/4, 1/2, 3/4, and 7/8
- Standard asynchronous communication bits for start, stop, and parity
- False-start bit detection
- Line-break generation and detection
- Fully programmable serial interface characteristics
  - 5, 6, 7, or 8 data bits
  - Even, odd, stick, or no-parity bit generation/detection
  - 1 or 2 stop bit generation
- IrDA serial-IR (SIR) encoder/decoder providing
  - Programmable use of IrDA Serial Infrared (SIR) or UART input/output
  - Support of IrDA SIR encoder/decoder functions for data rates up to 115.2 Kbps half-duplex
  - Support of normal 3/16 and low-power (1.41-2.23  $\mu$ s) bit durations
  - Programmable internal clock generator enabling division of reference clock by 1 to 256 for low-power mode bit duration
- Support for communication with ISO 7816 smart cards
- Full modem handshake support (on UART1)
- LIN protocol support
- Standard FIFO-level and End-of-Transmission interrupts
- Efficient transfers using Micro Direct Memory Access Controller ( $\mu$ DMA)
  - Separate channels for transmit and receive



- Receive single request asserted when data is in the FIFO; burst request asserted at programmed FIFO level
- Transmit single request asserted when there is space in the FIFO; burst request asserted at programmed FIFO level

## 14.1 Block Diagram

Figure 14-1. UART Module Block Diagram



## 14.2 Signal Description

Table 14-1 on page 586 and Table 14-2 on page 586 list the external signals of the UART module and describe the function of each. The UART signals are alternate functions for some GPIO signals and default to be GPIO signals at reset, with the exception of the U0Rx and U0Tx pins which default to the UART function. The column in the table below titled "Pin Mux/Pin Assignment" lists the possible GPIO pin placements for these UART signals. The AFSEL bit in the **GPIO Alternate Function Select (GPIOAFSEL)** register (page 328) should be set to choose the UART function. The number in parentheses is the encoding that must be programmed into the PMCn field in the **GPIO Port Control (GPIOCTL)** register (page 346) to assign the UART signal to the specified GPIO port pin. For more information on configuring GPIOs, see "General-Purpose Input/Outputs (GPIOs)" on page 304.

Table 14-1. Signals for UART (100LQFP)

Pin Name	Pin Number	Pin Mux / Pin Assignment	Pin Type	Buffer Type <sup>a</sup>	Description
U0Rx	26	PA0 (1)	I	TTL	UART module 0 receive. When in IrDA mode, this signal has IrDA modulation.
U0Tx	27	PA1 (1)	O	TTL	UART module 0 transmit. When in IrDA mode, this signal has IrDA modulation.
U1CTS	2 10 34 50	PE6 (9) PD0 (9) PA6 (9) PJ3 (9)	I	TTL	UART module 1 Clear To Send modem status input signal.
U1DCD	1 11 35 52	PE7 (9) PD1 (9) PA7 (9) PJ4 (9)	I	TTL	UART module 1 Data Carrier Detect modem status input signal.
U1DSR	47 53	PF0 (9) PJ5 (9)	I	TTL	UART module 1 Data Set Ready modem output control line.
U1DTR	55 100	PJ7 (9) PD7 (9)	O	TTL	UART module 1 Data Terminal Ready modem status input signal.
U1RI	97	PD4 (9)	I	TTL	UART module 1 Ring Indicator modem status input signal.
U1RTS	54 61	PJ6 (9) PF1 (9)	O	TTL	UART module 1 Request to Send modem output control line.
U1Rx	10 12 23 26 66 92	PD0 (5) PD2 (1) PC6 (5) PA0 (9) PB0 (5) PB4 (7)	I	TTL	UART module 1 receive. When in IrDA mode, this signal has IrDA modulation.
U1Tx	11 13 22 27 67 91	PD1 (5) PD3 (1) PC7 (5) PA1 (9) PB1 (5) PB5 (7)	O	TTL	UART module 1 transmit. When in IrDA mode, this signal has IrDA modulation.
U2Rx	10 19 92 98	PD0 (4) PG0 (1) PB4 (4) PD5 (9)	I	TTL	UART module 2 receive. When in IrDA mode, this signal has IrDA modulation.
U2Tx	6 11 18 99	PE4 (5) PD1 (4) PG1 (1) PD6 (9)	O	TTL	UART module 2 transmit. When in IrDA mode, this signal has IrDA modulation.

a. The TTL designation indicates the pin has TTL-compatible voltage levels.

Table 14-2. Signals for UART (108BGA)

Pin Name	Pin Number	Pin Mux / Pin Assignment	Pin Type	Buffer Type <sup>a</sup>	Description
U0Rx	L3	PA0 (1)	I	TTL	UART module 0 receive. When in IrDA mode, this signal has IrDA modulation.
U0Tx	M3	PA1 (1)	O	TTL	UART module 0 transmit. When in IrDA mode, this signal has IrDA modulation.

Table 14-2. Signals for UART (108BGA) (continued)

Pin Name	Pin Number	Pin Mux / Pin Assignment	Pin Type	Buffer Type <sup>a</sup>	Description
U1CTS	A1 G1 L6 M10	PE6 (9) PD0 (9) PA6 (9) PJ3 (9)	I	TTL	UART module 1 Clear To Send modem status input signal.
U1DCD	B1 G2 M6 K11	PE7 (9) PD1 (9) PA7 (9) PJ4 (9)	I	TTL	UART module 1 Data Carrier Detect modem status input signal.
U1DSR	M9 K12	PF0 (9) PJ5 (9)	I	TTL	UART module 1 Data Set Ready modem output control line.
U1DTR	L12 A2	PJ7 (9) PD7 (9)	O	TTL	UART module 1 Data Terminal Ready modem status input signal.
U1RI	B5	PD4 (9)	I	TTL	UART module 1 Ring Indicator modem status input signal.
U1RTS	L10 H12	PJ6 (9) PF1 (9)	O	TTL	UART module 1 Request to Send modem output control line.
U1Rx	G1 H2 M2 L3 E12 A6	PD0 (5) PD2 (1) PC6 (5) PA0 (9) PB0 (5) PB4 (7)	I	TTL	UART module 1 receive. When in IrDA mode, this signal has IrDA modulation.
U1Tx	G2 H1 L2 M3 D12 B7	PD1 (5) PD3 (1) PC7 (5) PA1 (9) PB1 (5) PB5 (7)	O	TTL	UART module 1 transmit. When in IrDA mode, this signal has IrDA modulation.
U2Rx	G1 K1 A6 C6	PD0 (4) PG0 (1) PB4 (4) PD5 (9)	I	TTL	UART module 2 receive. When in IrDA mode, this signal has IrDA modulation.
U2Tx	B2 G2 K2 A3	PE4 (5) PD1 (4) PG1 (1) PD6 (9)	O	TTL	UART module 2 transmit. When in IrDA mode, this signal has IrDA modulation.

a. The TTL designation indicates the pin has TTL-compatible voltage levels.

### 14.3 Functional Description

Each Stellaris® UART performs the functions of parallel-to-serial and serial-to-parallel conversions. It is similar in functionality to a 16C550 UART, but is not register compatible.

The UART is configured for transmit and/or receive via the TXE and RXE bits of the **UART Control (UARTCTL)** register (see page 611). Transmit and receive are both enabled out of reset. Before any control registers are programmed, the UART must be disabled by clearing the UARTEEN bit in **UARTCTL**. If the UART is disabled during a TX or RX operation, the current transaction is completed prior to the UART stopping.

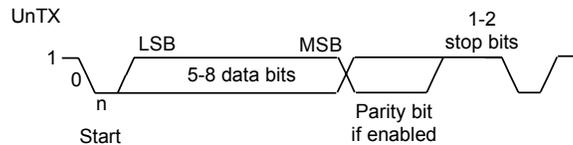
The UART module also includes a serial IR (SIR) encoder/decoder block that can be connected to an infrared transceiver to implement an IrDA SIR physical layer. The SIR function is programmed using the **UARTCTL** register.

### 14.3.1 Transmit/Receive Logic

The transmit logic performs parallel-to-serial conversion on the data read from the transmit FIFO. The control logic outputs the serial bit stream beginning with a start bit and followed by the data bits (LSB first), parity bit, and the stop bits according to the programmed configuration in the control registers. See Figure 14-2 on page 588 for details.

The receive logic performs serial-to-parallel conversion on the received bit stream after a valid start pulse has been detected. Overrun, parity, frame error checking, and line-break detection are also performed, and their status accompanies the data that is written to the receive FIFO.

**Figure 14-2. UART Character Frame**



### 14.3.2 Baud-Rate Generation

The baud-rate divisor is a 22-bit number consisting of a 16-bit integer and a 6-bit fractional part. The number formed by these two values is used by the baud-rate generator to determine the bit period. Having a fractional baud-rate divider allows the UART to generate all the standard baud rates.

The 16-bit integer is loaded through the **UART Integer Baud-Rate Divisor (UARTIBRD)** register (see page 607) and the 6-bit fractional part is loaded with the **UART Fractional Baud-Rate Divisor (UARTFBRD)** register (see page 608). The baud-rate divisor (BRD) has the following relationship to the system clock (where *BRDI* is the integer part of the BRD and *BRDF* is the fractional part, separated by a decimal place.)

$$BRD = BRDI + BRDF = \text{UARTSysClk} / (\text{ClkDiv} * \text{Baud Rate})$$

where *UARTSysClk* is the system clock connected to the UART, and *ClkDiv* is either 16 (if HSE in **UARTCTL** is clear) or 8 (if HSE is set).

The 6-bit fractional number (that is to be loaded into the *DIVFRAC* bit field in the **UARTFBRD** register) can be calculated by taking the fractional part of the baud-rate divisor, multiplying it by 64, and adding 0.5 to account for rounding errors:

$$\text{UARTFBRD}[\text{DIVFRAC}] = \text{integer}(\text{BRDF} * 64 + 0.5)$$

The UART generates an internal baud-rate reference clock at 8x or 16x the baud-rate (referred to as *Baud8* and *Baud16*, depending on the setting of the HSE bit (bit 5) in **UARTCTL**). This reference clock is divided by 8 or 16 to generate the transmit clock, and is used for error detection during receive operations.

Along with the **UART Line Control, High Byte (UARTLCRH)** register (see page 609), the **UARTIBRD** and **UARTFBRD** registers form an internal 30-bit register. This internal register is only updated when a write operation to **UARTLCRH** is performed, so any changes to the baud-rate divisor must be followed by a write to the **UARTLCRH** register for the changes to take effect.

To update the baud-rate registers, there are four possible sequences:

- **UARTIBRD** write, **UARTFBRD** write, and **UARTLCRH** write
- **UARTFBRD** write, **UARTIBRD** write, and **UARTLCRH** write

- **UARTIBRD** write and **UARTLCRH** write
- **UARTFBRD** write and **UARTLCRH** write

### 14.3.3 Data Transmission

Data received or transmitted is stored in two 16-byte FIFOs, though the receive FIFO has an extra four bits per character for status information. For transmission, data is written into the transmit FIFO. If the UART is enabled, it causes a data frame to start transmitting with the parameters indicated in the **UARTLCRH** register. Data continues to be transmitted until there is no data left in the transmit FIFO. The **BUSY** bit in the **UART Flag (UARTFR)** register (see page 603) is asserted as soon as data is written to the transmit FIFO (that is, if the FIFO is non-empty) and remains asserted while data is being transmitted. The **BUSY** bit is negated only when the transmit FIFO is empty, and the last character has been transmitted from the shift register, including the stop bits. The UART can indicate that it is busy even though the UART may no longer be enabled.

When the receiver is idle (the  $UnRx$  signal is continuously 1), and the data input goes Low (a start bit has been received), the receive counter begins running and data is sampled on the eighth cycle of **Baud16** or fourth cycle of **Baud8** depending on the setting of the **HSE** bit (bit 5) in **UARTCTL** (described in “Transmit/Receive Logic” on page 588).

The start bit is valid if the  $UnRx$  signal is still low on the eighth cycle of **Baud16** (**HSE** clear) or the fourth cycle of **Baud 8** (**HSE** set), otherwise a false start bit is detected and is ignored. Start bit errors can be viewed in the **UART Receive Status (UARTSR)** register (see page 600). If the start bit was valid, successive data bits are sampled on every 16th cycle of **Baud16** or 8th cycle of **Baud8** (that is, one bit period later) according to the programmed length of the data characters and value of the **HSE** bit in **UARTCTL**. The parity bit is then checked if parity mode is enabled. Data length and parity are defined in the **UARTLCRH** register.

Lastly, a valid stop bit is confirmed if the  $UnRx$  signal is High, otherwise a framing error has occurred. When a full word is received, the data is stored in the receive FIFO along with any error bits associated with that word.

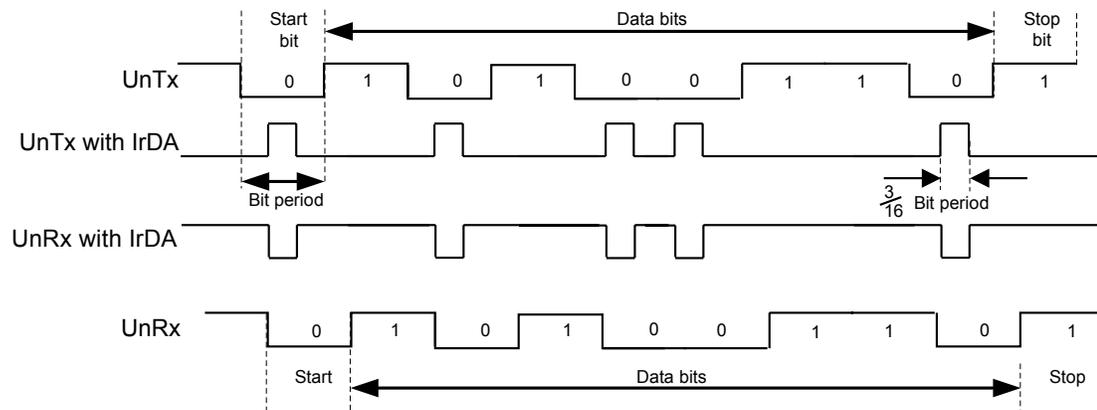
### 14.3.4 Serial IR (SIR)

The UART peripheral includes an IrDA serial-IR (SIR) encoder/decoder block. The IrDA SIR block provides functionality that converts between an asynchronous UART data stream and a half-duplex serial SIR interface. No analog processing is performed on-chip. The role of the SIR block is to provide a digital encoded output and decoded input to the UART. When enabled, the SIR block uses the  $UnTx$  and  $UnRx$  pins for the SIR protocol. These signals should be connected to an infrared transceiver to implement an IrDA SIR physical layer link. The SIR block can receive and transmit, but it is only half-duplex so it cannot do both at the same time. Transmission must be stopped before data can be received. The IrDA SIR physical layer specifies a minimum 10-ms delay between transmission and reception. The SIR block has two modes of operation:

- In normal IrDA mode, a zero logic level is transmitted as a high pulse of 3/16th duration of the selected baud rate bit period on the output pin, while logic one levels are transmitted as a static LOW signal. These levels control the driver of an infrared transmitter, sending a pulse of light for each zero. On the reception side, the incoming light pulses energize the photo transistor base of the receiver, pulling its output LOW and driving the UART input pin LOW.
- In low-power IrDA mode, the width of the transmitted infrared pulse is set to three times the period of the internally generated **IrLPBaud16** signal (1.63  $\mu$ s, assuming a nominal 1.8432 MHz frequency) by changing the appropriate bit in the **UARTCR** register. See page 606 for more information on IrDA low-power pulse-duration configuration.

Figure 14-3 on page 590 shows the UART transmit and receive signals, with and without IrDA modulation.

**Figure 14-3. IrDA Data Modulation**



In both normal and low-power IrDA modes:

- During transmission, the UART data bit is used as the base for encoding
- During reception, the decoded bits are transferred to the UART receive logic

The IrDA SIR physical layer specifies a half-duplex communication link, with a minimum 10-ms delay between transmission and reception. This delay must be generated by software because it is not automatically supported by the UART. The delay is required because the infrared receiver electronics might become biased or even saturated from the optical power coupled from the adjacent transmitter LED. This delay is known as latency or receiver setup time.

### 14.3.5 ISO 7816 Support

The UART offers basic support to allow communication with an ISO 7816 smartcard. When bit 3 (*SMART*) of the **UARTCTL** register is set, the *UnTx* signal is used as a bit clock, and the *UnRx* signal is used as the half-duplex communication line connected to the smartcard. A GPIO signal can be used to generate the reset signal to the smartcard. The remaining smartcard signals should be provided by the system design.

When using ISO 7816 mode, the **UARTLCRH** register must be set to transmit 8-bit words (*WLEN* bits 6:5 configured to 0x3) with EVEN parity (*PEN* set and *EPS* set). In this mode, the UART automatically uses 2 stop bits, and the *STP2* bit of the **UARTLCRH** register is ignored.

If a parity error is detected during transmission, *UnRx* is pulled Low during the second stop bit. In this case, the UART aborts the transmission, flushes the transmit FIFO and discards any data it contains, and raises a parity error interrupt, allowing software to detect the problem and initiate retransmission of the affected data. Note that the UART does not support automatic retransmission in this case.

### 14.3.6 Modem Handshake Support

This section describes how to configure and use the modem status signals for UART1 when connected as a DTE (data terminal equipment) or as a DCE (data communications equipment). In general, a modem is a DCE and a computing device that connects to a modem is the DTE.

### 14.3.6.1 Signaling

The status signals provided by UART1 differ based on whether the UART is used as a DTE or DCE. When used as a DTE, the modem status signals are defined as:

- $\overline{\text{UICTS}}$  is Clear To Send
- $\overline{\text{UIDSR}}$  is Data Set Ready
- $\overline{\text{UIDCD}}$  is Data Carrier Detect
- $\overline{\text{UIRI}}$  is Ring Indicator
- $\overline{\text{UIRTS}}$  is Request To Send
- $\overline{\text{UIDTR}}$  is Data Terminal Ready

When used as a DCE, the the modem status signals are defined as:

- $\overline{\text{UICTS}}$  is Request To Send
- $\overline{\text{UIDSR}}$  is Data Terminal Ready
- $\overline{\text{UIRTS}}$  is Clear To Send
- $\overline{\text{UIDTR}}$  is Data Set Ready

Note that the support for DCE functions Data Carrier Detect and Ring Indicator are not provided. If these signals are required, their function can be emulated by using a general-purpose I/O signal and providing software support.

### 14.3.6.2 Flow Control Methods

Flow control can be accomplished by either hardware or software. The following sections describe the different methods.

#### **Hardware Flow Control (RTS/CTS)**

Hardware flow control between two devices is accomplished by connecting the  $\overline{\text{UIRTS}}$  output to the Clear-To-Send input on the receiving device, and connecting the Request-To-Send output on the receiving device to the  $\overline{\text{UICTS}}$  input.

The  $\overline{\text{UICTS}}$  input controls the transmitter. The transmitter may only transmit data when the  $\overline{\text{UICTS}}$  input is asserted. The  $\overline{\text{UIRTS}}$  output signal indicates the state of the receive FIFO.  $\overline{\text{UICTS}}$  remains asserted until the preprogrammed watermark level is reached, indicating that the Receive FIFO has no space to store additional characters.

The **UARTCTL** register bits 15 (**CTSEN**) and 14 (**RTSEN**) specify the flow control mode as shown in Table 14-3 on page 591.

**Table 14-3. Flow Control Mode**

CTSEN	RTSEN	Description
1	1	RTS and CTS flow control enabled
1	0	Only CTS flow control enabled
0	1	Only RTS flow control enabled

**Table 14-3. Flow Control Mode (continued)**

CTSEN	RTSEN	Description
0	0	Both RTS and CTS flow control disabled

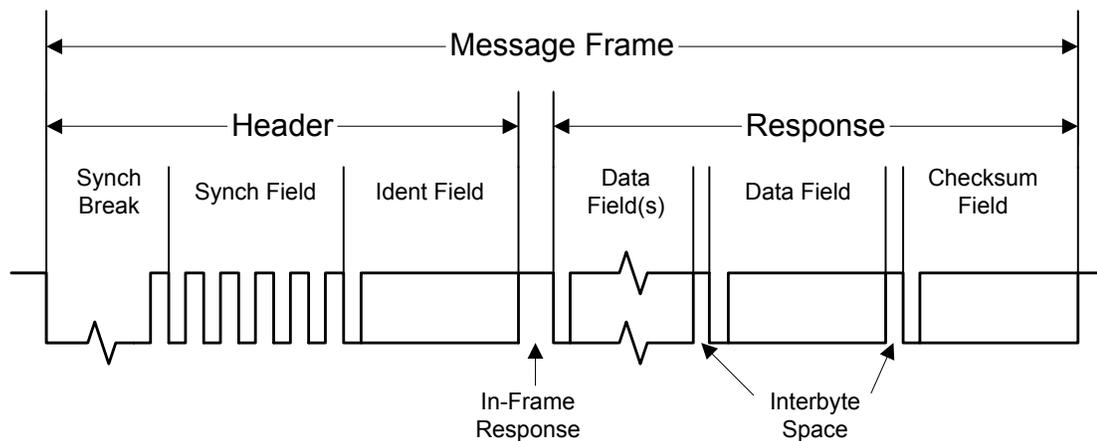
Note that when `RTSEN` is 1, software cannot modify the  $\overline{UIRTS}$  output value through the `UARTCTL` register Request to Send (`RTS`) bit, and the status of the `RTS` bit should be ignored.

#### Software Flow Control (Modem Status Interrupts)

Software flow control between two devices is accomplished by using interrupts to indicate the status of the UART. Interrupts may be generated for `UIDSR`, `UIDCD`, `UICTS`, and `UIRI` using the `UARTIM` bits 3 through 0 respectively. The raw and masked interrupt status may be checked using the `UARTRIS` and `UARTMIS` register. These interrupts may be cleared using the `UARTICR` register.

### 14.3.7 LIN Support

The UART module offers hardware support for the LIN protocol as either a master or a slave. The LIN mode is enabled by setting the `LIN` bit in the `UARTCTL` register. A LIN message is identified by the use of a Sync Break at the beginning of the message. The Sync Break is a transmission of a series of 0s. The Sync Break is followed by the Sync data field (0x55). Figure 14-4 on page 592 illustrates the structure of a LIN message.

**Figure 14-4. LIN Message**


The UART should be configured as followed to operate in LIN mode:

1. Configure the UART for 1 start bit, 8 data bits, no parity, and 1 stop bit. Enable the Transmit FIFO.
2. Set the `LIN` bit in the `UARTCTL` register.

When preparing to send a LIN message, the TXFIFO should contain the Sync data (0x55) at FIFO location 0 and the Identifier data at location 1, followed by the data to be transmitted, and with the checksum in the final FIFO entry.



### 14.3.7.1 LIN Master

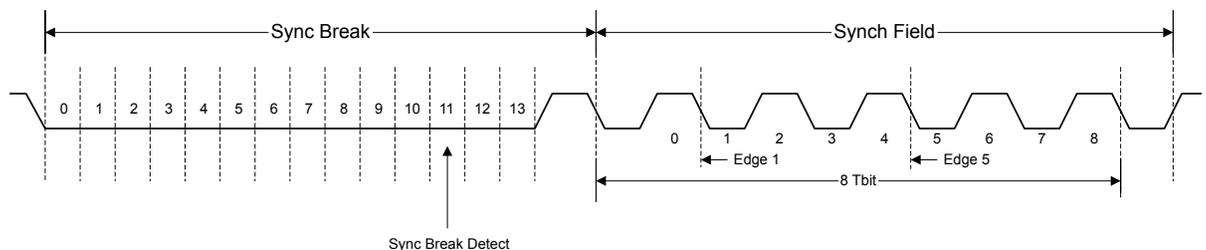
The UART is enabled to be the LIN master by setting the `MASTER` bit in the `UARTLCTL` register. The length of the Sync Break is programmable using the `BLEN` field in the `UARTLCTL` register and can be 13-16 bits (baud clock cycles).

### 14.3.7.2 LIN Slave

The LIN UART slave is required to adjust its baud rate to that of the LIN master. In slave mode, the LIN UART recognizes the Sync Break, which must be at least 13 bits in duration. A timer is provided to capture timing data on the 1st and 5th falling edges of the Sync field so that the baud rate can be adjusted to match the master.

After detecting a Sync Break, the UART waits for the synchronization field. The first falling edge generates an interrupt using the `LME1RIS` bit in the `UARTRIS` register, and the timer value is captured and stored in the `UARTLSS` register (`T1`). On the fifth falling edge, a second interrupt is generated using the `LME5RIS` bit in the `UARTRIS` register, and the timer value is captured again (`T2`). The actual baud rate can be calculated using  $(T2-T1)/8$ , and the local baud rate should be adjusted as needed. Figure 14-5 on page 593 illustrates the synchronization field.

**Figure 14-5. LIN Synchronization Field**



### 14.3.8 FIFO Operation

The UART has two 16-entry FIFOs; one for transmit and one for receive. Both FIFOs are accessed via the **UART Data (UARTDR)** register (see page 598). Read operations of the `UARTDR` register return a 12-bit value consisting of 8 data bits and 4 error flags while write operations place 8-bit data in the transmit FIFO.

Out of reset, both FIFOs are disabled and act as 1-byte-deep holding registers. The FIFOs are enabled by setting the `FEN` bit in `UARTLCRH` (page 609).

FIFO status can be monitored via the **UART Flag (UARTFR)** register (see page 603) and the **UART Receive Status (UARTRSR)** register. Hardware monitors empty, full and overrun conditions. The `UARTFR` register contains empty and full flags (`TXFE`, `TXFF`, `RXFE`, and `RXFF` bits), and the `UARTRSR` register shows overrun status via the `OE` bit.

The trigger points at which the FIFOs generate interrupts is controlled via the **UART Interrupt FIFO Level Select (UARTIFLS)** register (see page 615). Both FIFOs can be individually configured to trigger interrupts at different levels. Available configurations include  $\frac{1}{8}$ ,  $\frac{1}{4}$ ,  $\frac{1}{2}$ ,  $\frac{3}{4}$ , and  $\frac{7}{8}$ . For example, if the  $\frac{1}{4}$  option is selected for the receive FIFO, the UART generates a receive interrupt after 4 data bytes are received. Out of reset, both FIFOs are configured to trigger an interrupt at the  $\frac{1}{2}$  mark.

### 14.3.9 Interrupts

The UART can generate interrupts when the following conditions are observed:

- Overrun Error
- Break Error
- Parity Error
- Framing Error
- Receive Timeout
- Transmit (when condition defined in the `TXIFLSEL` bit in the **UARTIFLS** register is met, or if the `EOT` bit in **UARTCTRL** is set, when the last bit of all transmitted data leaves the serializer)
- Receive (when condition defined in the `RXIFLSEL` bit in the **UARTIFLS** register is met)

All of the interrupt events are ORed together before being sent to the interrupt controller, so the UART can only generate a single interrupt request to the controller at any given time. Software can service multiple interrupt events in a single interrupt service routine by reading the **UART Masked Interrupt Status (UARTMIS)** register (see page 625).

The interrupt events that can trigger a controller-level interrupt are defined in the **UART Interrupt Mask (UARTIM)** register (see page 617) by setting the corresponding `IM` bits. If interrupts are not used, the raw interrupt status is always visible via the **UART Raw Interrupt Status (UARTRIS)** register (see page 621).

Interrupts are always cleared (for both the **UARTMIS** and **UARTRIS** registers) by writing a 1 to the corresponding bit in the **UART Interrupt Clear (UARTICR)** register (see page 628).

The receive timeout interrupt is asserted when the receive FIFO is not empty, and no further data is received over a 32-bit period. The receive timeout interrupt is cleared either when the FIFO becomes empty through reading all the data (or by reading the holding register), or when a 1 is written to the corresponding bit in the **UARTICR** register.

### 14.3.10 Loopback Operation

The UART can be placed into an internal loopback mode for diagnostic or debug work by setting the `LBE` bit in the **UARTCTL** register (see page 611). In loopback mode, data transmitted on the `UnTx` output is received on the `UnRx` input.

### 14.3.11 DMA Operation

The UART provides an interface to the  $\mu$ DMA controller with separate channels for transmit and receive. The DMA operation of the UART is enabled through the **UART DMA Control (UARTDMACTL)** register. When DMA operation is enabled, the UART asserts a DMA request on the receive or transmit channel when the associated FIFO can transfer data. For the receive channel, a single transfer request is asserted whenever any data is in the receive FIFO. A burst transfer request is asserted whenever the amount of data in the receive FIFO is at or above the FIFO trigger level configured in the **UARTIFLS** register. For the transmit channel, a single transfer request is asserted whenever there is at least one empty location in the transmit FIFO. The burst request is asserted whenever the transmit FIFO contains fewer characters than the FIFO trigger level. The single and burst DMA transfer requests are handled automatically by the  $\mu$ DMA controller depending on how the DMA channel is configured.

To enable DMA operation for the receive channel, set the `RXDMAE` bit of the **DMA Control (UARTDMACTL)** register. To enable DMA operation for the transmit channel, set the `TXDMAE` bit of the **UARTDMACTL** register. The UART can also be configured to stop using DMA for the receive

channel if a receive error occurs. If the `DMAERR` bit of the `UARTDMACR` register is set and a receive error occurs, the DMA receive requests are automatically disabled. This error condition can be cleared by clearing the appropriate UART error interrupt.

If DMA is enabled, then the  $\mu$ DMA controller triggers an interrupt when a transfer is complete. The interrupt occurs on the UART interrupt vector. Therefore, if interrupts are used for UART operation and DMA is enabled, the UART interrupt handler must be designed to handle the  $\mu$ DMA completion interrupt.

See “Micro Direct Memory Access ( $\mu$ DMA)” on page 246 for more details about programming the  $\mu$ DMA controller.

## 14.4 Initialization and Configuration

To enable and initialize the UART, the following steps are necessary:

1. The peripheral clock must be enabled by setting the `UART0`, `UART1`, or `UART2` bits in the `RCGC1` register (see page 181).
2. The clock to the appropriate GPIO module must be enabled via the `RCGC2` register in the System Control module (see page 193).
3. Set the GPIO `AFSEL` bits for the appropriate pins (see page 328). To determine which GPIOs to configure, see Table 25-4 on page 1151.
4. Configure the GPIO current level and/or slew rate as specified for the mode selected (see page 330 and page 338).
5. Configure the `PMCn` fields in the `GPIOPCTL` register to assign the UART signals to the appropriate pins (see page 346 and Table 25-5 on page 1160).

To use the UARTs, the peripheral clock must be enabled by setting the `UART0`, `UART1`, or `UART2` bits in the `RCGC1` register (see page 181). In addition, the clock to the appropriate GPIO module must be enabled via the `RCGC2` register in the System Control module (see page 193). To find out which GPIO port to enable, refer to Table 25-5 on page 1160.

This section discusses the steps that are required to use a UART module. For this example, the UART clock is assumed to be 20 MHz, and the desired UART configuration is:

- 115200 baud rate
- Data length of 8 bits
- One stop bit
- No parity
- FIFOs disabled
- No interrupts

The first thing to consider when programming the UART is the baud-rate divisor (BRD), because the `UARTIBRD` and `UARTFBRD` registers must be written before the `UARTLCRH` register. Using the equation described in “Baud-Rate Generation” on page 588, the BRD can be calculated:

$$\text{BRD} = 20,000,000 / (16 * 115,200) = 10.8507$$

which means that the `DIVINT` field of the `UARTIBRD` register (see page 607) should be set to 10 decimal or `0xA`. The value to be loaded into the `UARTFBRD` register (see page 608) is calculated by the equation:

$$\text{UARTFBRD}[\text{DIVFRAC}] = \text{integer}(0.8507 * 64 + 0.5) = 54$$

With the BRD values in hand, the UART configuration is written to the module in the following order:

1. Disable the UART by clearing the `UARTEN` bit in the `UARTCTL` register.
2. Write the integer portion of the BRD to the `UARTIBRD` register.
3. Write the fractional portion of the BRD to the `UARTFBRD` register.
4. Write the desired serial parameters to the `UARTLCRH` register (in this case, a value of `0x0000.0060`).
5. Optionally, configure the  $\mu$ DMA channel (see “Micro Direct Memory Access ( $\mu$ DMA)” on page 246) and enable the DMA option(s) in the `UARTDMACTL` register.
6. Enable the UART by setting the `UARTEN` bit in the `UARTCTL` register.

## 14.5 Register Map

Table 14-4 on page 596 lists the UART registers. The offset listed is a hexadecimal increment to the register’s address, relative to that UART’s base address:

- UART0: `0x4000.C000`
- UART1: `0x4000.D000`
- UART2: `0x4000.E000`

Note that the UART module clock must be enabled before the registers can be programmed (see page 181).

**Note:** The UART must be disabled (see the `UARTEN` bit in the `UARTCTL` register on page 611) before any of the control registers are reprogrammed. When the UART is disabled during a TX or RX operation, the current transaction is completed prior to the UART stopping.

**Table 14-4. UART Register Map**

Offset	Name	Type	Reset	Description	See page
0x000	UARTDR	R/W	0x0000.0000	UART Data	598
0x004	UARTRSR/UARTECR	R/W	0x0000.0000	UART Receive Status/Error Clear	600
0x018	UARTFR	RO	0x0000.0090	UART Flag	603
0x020	UARTILPR	R/W	0x0000.0000	UART IrDA Low-Power Register	606
0x024	UARTIBRD	R/W	0x0000.0000	UART Integer Baud-Rate Divisor	607
0x028	UARTFBRD	R/W	0x0000.0000	UART Fractional Baud-Rate Divisor	608
0x02C	UARTLCRH	R/W	0x0000.0000	UART Line Control	609
0x030	UARTCTL	R/W	0x0000.0300	UART Control	611
0x034	UARTIFLS	R/W	0x0000.0012	UART Interrupt FIFO Level Select	615

Table 14-4. UART Register Map (continued)

Offset	Name	Type	Reset	Description	See page
0x038	UARTIM	R/W	0x0000.0000	UART Interrupt Mask	617
0x03C	UARTRIS	RO	0x0000.000F	UART Raw Interrupt Status	621
0x040	UARTMIS	RO	0x0000.0000	UART Masked Interrupt Status	625
0x044	UARTICR	W1C	0x0000.0000	UART Interrupt Clear	628
0x048	UARTDMACTL	R/W	0x0000.0000	UART DMA Control	630
0x090	UARTLCTL	R/W	0x0000.0000	UART LIN Control	631
0x094	UARTLSS	RO	0x0000.0000	UART LIN Snap Shot	632
0x098	UARTLTIM	RO	0x0000.0000	UART LIN Timer	633
0xFD0	UARTPeriphID4	RO	0x0000.0000	UART Peripheral Identification 4	634
0xFD4	UARTPeriphID5	RO	0x0000.0000	UART Peripheral Identification 5	635
0xFD8	UARTPeriphID6	RO	0x0000.0000	UART Peripheral Identification 6	636
0xFDC	UARTPeriphID7	RO	0x0000.0000	UART Peripheral Identification 7	637
0xFE0	UARTPeriphID0	RO	0x0000.0060	UART Peripheral Identification 0	638
0xFE4	UARTPeriphID1	RO	0x0000.0000	UART Peripheral Identification 1	639
0xFE8	UARTPeriphID2	RO	0x0000.0018	UART Peripheral Identification 2	640
0xFEC	UARTPeriphID3	RO	0x0000.0001	UART Peripheral Identification 3	641
0xFF0	UARTPCellID0	RO	0x0000.000D	UART PrimeCell Identification 0	642
0xFF4	UARTPCellID1	RO	0x0000.00F0	UART PrimeCell Identification 1	643
0xFF8	UARTPCellID2	RO	0x0000.0005	UART PrimeCell Identification 2	644
0xFFC	UARTPCellID3	RO	0x0000.00B1	UART PrimeCell Identification 3	645

## 14.6 Register Descriptions

The remainder of this section lists and describes the UART registers, in numerical order by address offset.

## Register 1: UART Data (UARTDR), offset 0x000

**Important:** Use caution when reading this register. Performing a read may change bit status.

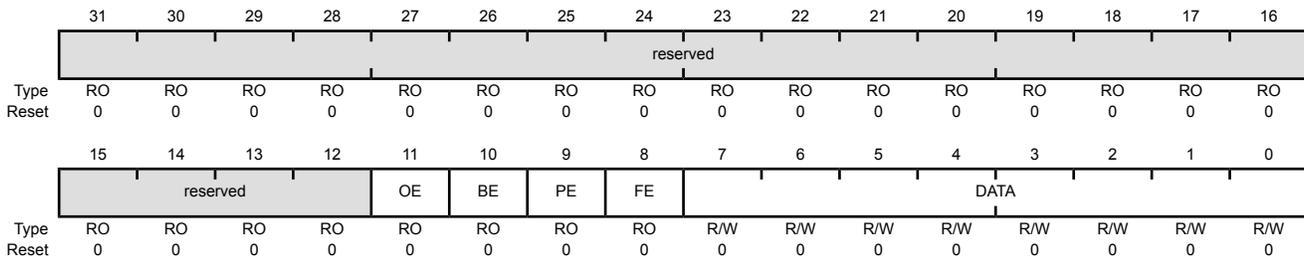
This register is the data register (the interface to the FIFOs).

For transmitted data, if the FIFO is enabled, data written to this location is pushed onto the transmit FIFO. If the FIFO is disabled, data is stored in the transmitter holding register (the bottom word of the transmit FIFO). A write to this register initiates a transmission from the UART.

For received data, if the FIFO is enabled, the data byte and the 4-bit status (break, frame, parity, and overrun) is pushed onto the 12-bit wide receive FIFO. If the FIFO is disabled, the data byte and status are stored in the receiving holding register (the bottom word of the receive FIFO). The received data can be retrieved by reading this register.

### UART Data (UARTDR)

UART0 base: 0x4000.C000  
 UART1 base: 0x4000.D000  
 UART2 base: 0x4000.E000  
 Offset 0x000  
 Type R/W, reset 0x0000.0000



Bit/Field	Name	Type	Reset	Description
31:12	reserved	RO	0x0000.0	Software should not rely on the value of a reserved bit. To provide compatibility with future products, the value of a reserved bit should be preserved across a read-modify-write operation.
11	OE	RO	0	UART Overrun Error
				Value Description
				1 New data was received when the FIFO was full, resulting in data loss.
				0 No data has been lost due to a FIFO overrun.
10	BE	RO	0	UART Break Error
				Value Description
				1 A break condition has been detected, indicating that the receive data input was held Low for longer than a full-word transmission time (defined as start, data, parity, and stop bits).
				0 No break condition has occurred
				In FIFO mode, this error is associated with the character at the top of the FIFO. When a break occurs, only one 0 character is loaded into the FIFO. The next character is only enabled after the received data input goes to a 1 (marking state), and the next valid start bit is received.

Bit/Field	Name	Type	Reset	Description
9	PE	RO	0	<p>UART Parity Error</p> <p>Value Description</p> <p>1 The parity of the received data character does not match the parity defined by bits 2 and 7 of the <b>UARTLCRH</b> register.</p> <p>0 No parity error has occurred</p> <p>In FIFO mode, this error is associated with the character at the top of the FIFO.</p>
8	FE	RO	0	<p>UART Framing Error</p> <p>Value Description</p> <p>1 The received character does not have a valid stop bit (a valid stop bit is 1).</p> <p>0 No framing error has occurred</p>
7:0	DATA	R/W	0x00	<p>Data Transmitted or Received</p> <p>Data that is to be transmitted via the UART is written to this field.</p> <p>When read, this field contains the data that was received by the UART.</p>

## Register 2: UART Receive Status/Error Clear (UARTRSR/UARTECR), offset 0x004

The **UARTRSR/UARTECR** register is the receive status register/error clear register.

In addition to the **UARTDR** register, receive status can also be read from the **UARTRSR** register. If the status is read from this register, then the status information corresponds to the entry read from **UARTDR** prior to reading **UARTRSR**. The status information for overrun is set immediately when an overrun condition occurs.

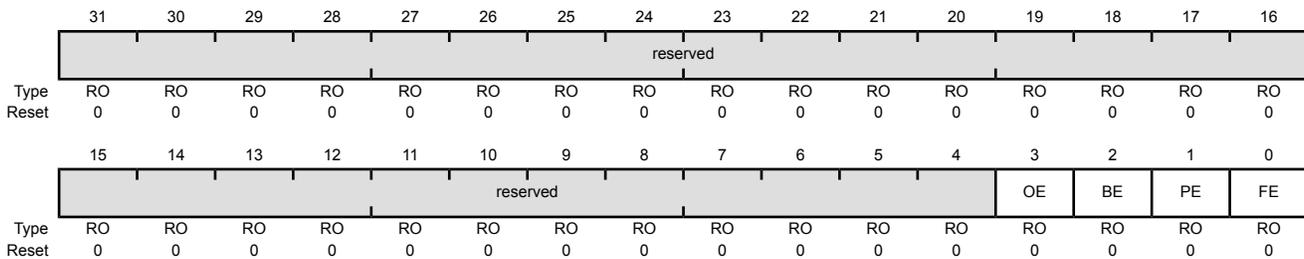
The **UARTRSR** register cannot be written.

A write of any value to the **UARTECR** register clears the framing, parity, break, and overrun errors. All the bits are cleared on reset.

### Read-Only Status Register

#### UART Receive Status/Error Clear (UARTRSR/UARTECR)

UART0 base: 0x4000.C000  
 UART1 base: 0x4000.D000  
 UART2 base: 0x4000.E000  
 Offset 0x004  
 Type RO, reset 0x0000.0000



Bit/Field	Name	Type	Reset	Description
31:4	reserved	RO	0x0000.000	Software should not rely on the value of a reserved bit. To provide compatibility with future products, the value of a reserved bit should be preserved across a read-modify-write operation.
3	OE	RO	0	UART Overrun Error
				Value Description
				1 New data was received when the FIFO was full, resulting in data loss.
				0 No data has been lost due to a FIFO overrun.
				This bit is cleared by a write to <b>UARTECR</b> .
				The FIFO contents remain valid because no further data is written when the FIFO is full, only the contents of the shift register are overwritten. The CPU must read the data in order to empty the FIFO.

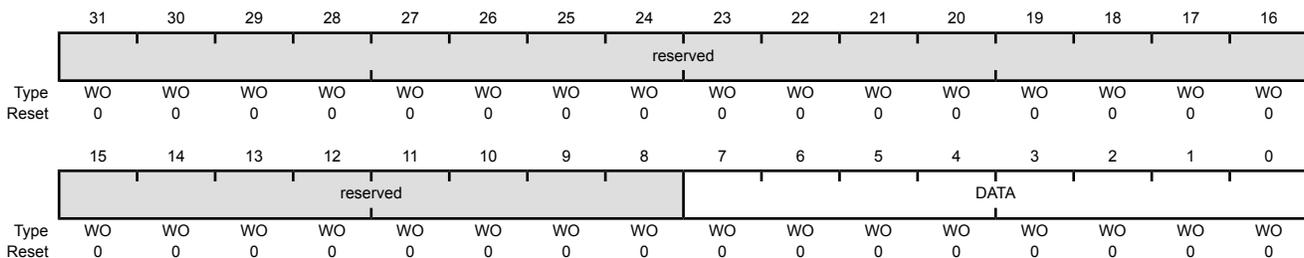


Bit/Field	Name	Type	Reset	Description
2	BE	RO	0	<p>UART Break Error</p> <p>Value Description</p> <p>1 A break condition has been detected, indicating that the receive data input was held Low for longer than a full-word transmission time (defined as start, data, parity, and stop bits).</p> <p>0 No break condition has occurred</p> <p>This bit is cleared to 0 by a write to <b>UARTECR</b>.</p> <p>In FIFO mode, this error is associated with the character at the top of the FIFO. When a break occurs, only one 0 character is loaded into the FIFO. The next character is only enabled after the receive data input goes to a 1 (marking state) and the next valid start bit is received.</p>
1	PE	RO	0	<p>UART Parity Error</p> <p>Value Description</p> <p>1 The parity of the received data character does not match the parity defined by bits 2 and 7 of the <b>UARTLCRH</b> register.</p> <p>0 No parity error has occurred</p> <p>This bit is cleared to 0 by a write to <b>UARTECR</b>.</p>
0	FE	RO	0	<p>UART Framing Error</p> <p>Value Description</p> <p>1 The received character does not have a valid stop bit (a valid stop bit is 1).</p> <p>0 No framing error has occurred</p> <p>This bit is cleared to 0 by a write to <b>UARTECR</b>.</p> <p>In FIFO mode, this error is associated with the character at the top of the FIFO.</p>

### Write-Only Error Clear Register

#### UART Receive Status/Error Clear (UARTRSR/UARTECR)

UART0 base: 0x4000.C000  
 UART1 base: 0x4000.D000  
 UART2 base: 0x4000.E000  
 Offset 0x004  
 Type WO, reset 0x0000.0000



Bit/Field	Name	Type	Reset	Description
31:8	reserved	WO	0x0000.00	Software should not rely on the value of a reserved bit. To provide compatibility with future products, the value of a reserved bit should be preserved across a read-modify-write operation.
7:0	DATA	WO	0x00	Error Clear A write to this register of any data clears the framing, parity, break, and overrun flags.

### Register 3: UART Flag (UARTFR), offset 0x018

The **UARTFR** register is the flag register. After reset, the **TXFF**, **RXFF**, and **BUSY** bits are 0, and **TXFE** and **RXFE** bits are 1. The **RI**, **DCD**, **DSR** and **CTS** bits indicate the modem status.

Note that bits [8,2:0] are only implemented on UART1. These bits are reserved on UART0 and UART2.

#### UART Flag (UARTFR)

UART0 base: 0x4000.C000  
 UART1 base: 0x4000.D000  
 UART2 base: 0x4000.E000  
 Offset 0x018  
 Type RO, reset 0x0000.0090

	31	30	29	28	27	26	25	24	23	22	21	20	19	18	17	16
	reserved															
Type	RO	RO	RO	RO	RO	RO	RO	RO	RO	RO	RO	RO	RO	RO	RO	RO
Reset	0	0	0	0	0	0	0	0	0	0	0	0	0	0	0	0
	15	14	13	12	11	10	9	8	7	6	5	4	3	2	1	0
	reserved							RI	TXFE	RXFF	TXFF	RXFE	BUSY	DCD	DSR	CTS
Type	RO	RO	RO	RO	RO	RO	RO	RO	RO	RO	RO	RO	RO	RO	RO	RO
Reset	0	0	0	0	0	0	0	0	1	0	0	1	0	0	0	0

Bit/Field	Name	Type	Reset	Description
31:9	reserved	RO	0x0000.00	Software should not rely on the value of a reserved bit. To provide compatibility with future products, the value of a reserved bit should be preserved across a read-modify-write operation.
8	RI	RO	0	Ring Indicator  Value Description 1 The <b>URI</b> signal is asserted. 0 The <b>URI</b> signal is not asserted.  This bit is implemented only on UART1 and is reserved for UART0 and UART2.
7	TXFE	RO	1	UART Transmit FIFO Empty  The meaning of this bit depends on the state of the <b>FEN</b> bit in the <b>UARTLCRH</b> register.  Value Description 1 If the FIFO is disabled ( <b>FEN</b> is 0), the transmit holding register is empty. If the FIFO is enabled ( <b>FEN</b> is 1), the transmit FIFO is empty. 0 The transmitter has data to transmit.

Bit/Field	Name	Type	Reset	Description
6	RXFF	RO	0	<p>UART Receive FIFO Full</p> <p>The meaning of this bit depends on the state of the <code>FEN</code> bit in the <b>UARTLCRH</b> register.</p> <p>Value Description</p> <p>1 If the FIFO is disabled (<code>FEN</code> is 0), the receive holding register is full.</p> <p>If the FIFO is enabled (<code>FEN</code> is 1), the receive FIFO is full.</p> <p>0 The receiver can receive data.</p>
5	TXFF	RO	0	<p>UART Transmit FIFO Full</p> <p>The meaning of this bit depends on the state of the <code>FEN</code> bit in the <b>UARTLCRH</b> register.</p> <p>Value Description</p> <p>1 If the FIFO is disabled (<code>FEN</code> is 0), the transmit holding register is full.</p> <p>If the FIFO is enabled (<code>FEN</code> is 1), the transmit FIFO is full.</p> <p>0 The transmitter is not full.</p>
4	RXFE	RO	1	<p>UART Receive FIFO Empty</p> <p>The meaning of this bit depends on the state of the <code>FEN</code> bit in the <b>UARTLCRH</b> register.</p> <p>Value Description</p> <p>1 If the FIFO is disabled (<code>FEN</code> is 0), the receive holding register is empty.</p> <p>If the FIFO is enabled (<code>FEN</code> is 1), the receive FIFO is empty.</p> <p>0 The receiver is not empty.</p>
3	BUSY	RO	0	<p>UART Busy</p> <p>Value Description</p> <p>1 The UART is busy transmitting data. This bit remains set until the complete byte, including all stop bits, has been sent from the shift register.</p> <p>0 The UART is not busy.</p> <p>This bit is set as soon as the transmit FIFO becomes non-empty (regardless of whether UART is enabled).</p>
2	DCD	RO	0	<p>Data Carrier Detect</p> <p>Value Description</p> <p>1 The <code>U1DCD</code> signal is asserted.</p> <p>0 The <code>U1DCD</code> signal is not asserted.</p> <p>This bit is implemented only on UART1 and is reserved for UART0 and UART2.</p>

---

Bit/Field	Name	Type	Reset	Description
1	DSR	RO	0	Data Set Ready  Value Description 1 The U1DSR signal is asserted. 0 The U1DSR signal is not asserted.  This bit is implemented only on UART1 and is reserved for UART0 and UART2.
0	CTS	RO	0	Clear To Send  Value Description 1 The U1CTS signal is asserted. 0 The U1CTS signal is not asserted.  This bit is implemented only on UART1 and is reserved for UART0 and UART2.

### Register 4: UART IrDA Low-Power Register (UARTILPR), offset 0x020

The **UARTILPR** register stores the 8-bit low-power counter divisor value used to derive the low-power SIR pulse width clock by dividing down the system clock (SysClk). All the bits are cleared when reset.

The internal  $F_{IrLPBaud16}$  clock is generated by dividing down SysClk according to the low-power divisor value written to **UARTILPR**. The duration of SIR pulses generated when low-power mode is enabled is three times the period of the  $F_{IrLPBaud16}$  clock. The low-power divisor value is calculated as follows:

$$ILPDVSR = SysClk / F_{IrLPBaud16}$$

where  $F_{IrLPBaud16}$  is nominally 1.8432 MHz.

The divisor must be programmed such that  $1.42 \text{ MHz} < F_{IrLPBaud16} < 2.12 \text{ MHz}$ , resulting in a low-power pulse duration of 1.41–2.11  $\mu\text{s}$  (three times the period of  $F_{IrLPBaud16}$ ). The minimum frequency of  $F_{IrLPBaud16}$  ensures that pulses less than one period of  $F_{IrLPBaud16}$  are rejected, but pulses greater than 1.4  $\mu\text{s}$  are accepted as valid pulses.

**Note:** Zero is an illegal value. Programming a zero value results in no  $F_{IrLPBaud16}$  pulses being generated.

#### UART IrDA Low-Power Register (UARTILPR)

UART0 base: 0x4000.C000  
 UART1 base: 0x4000.D000  
 UART2 base: 0x4000.E000  
 Offset 0x020  
 Type R/W, reset 0x0000.0000

	31	30	29	28	27	26	25	24	23	22	21	20	19	18	17	16
	reserved															
Type	RO	RO	RO	RO	RO	RO	RO	RO	RO	RO	RO	RO	RO	RO	RO	RO
Reset	0	0	0	0	0	0	0	0	0	0	0	0	0	0	0	0
	15	14	13	12	11	10	9	8	7	6	5	4	3	2	1	0
	reserved								ILPDVSR							
Type	RO	RO	RO	RO	RO	RO	RO	RO	R/W	R/W	R/W	R/W	R/W	R/W	R/W	R/W
Reset	0	0	0	0	0	0	0	0	0	0	0	0	0	0	0	0

Bit/Field	Name	Type	Reset	Description
31:8	reserved	RO	0x0000.00	Software should not rely on the value of a reserved bit. To provide compatibility with future products, the value of a reserved bit should be preserved across a read-modify-write operation.
7:0	ILPDVSR	R/W	0x00	IrDA Low-Power Divisor  This field contains the 8-bit low-power divisor value.

## Register 5: UART Integer Baud-Rate Divisor (UARTIBRD), offset 0x024

The **UARTIBRD** register is the integer part of the baud-rate divisor value. All the bits are cleared on reset. The minimum possible divide ratio is 1 (when **UARTIBRD**=0), in which case the **UARTFBRD** register is ignored. When changing the **UARTIBRD** register, the new value does not take effect until transmission/reception of the current character is complete. Any changes to the baud-rate divisor must be followed by a write to the **UARTLCRH** register. See “Baud-Rate Generation” on page 588 for configuration details.

### UART Integer Baud-Rate Divisor (UARTIBRD)

UART0 base: 0x4000.C000  
 UART1 base: 0x4000.D000  
 UART2 base: 0x4000.E000  
 Offset 0x024  
 Type R/W, reset 0x0000.0000

	31	30	29	28	27	26	25	24	23	22	21	20	19	18	17	16
	reserved															
Type	RO	RO	RO	RO	RO	RO	RO	RO	RO	RO	RO	RO	RO	RO	RO	RO
Reset	0	0	0	0	0	0	0	0	0	0	0	0	0	0	0	0
	15	14	13	12	11	10	9	8	7	6	5	4	3	2	1	0
	DIVINT															
Type	R/W	R/W	R/W	R/W	R/W	R/W	R/W	R/W	R/W	R/W	R/W	R/W	R/W	R/W	R/W	R/W
Reset	0	0	0	0	0	0	0	0	0	0	0	0	0	0	0	0

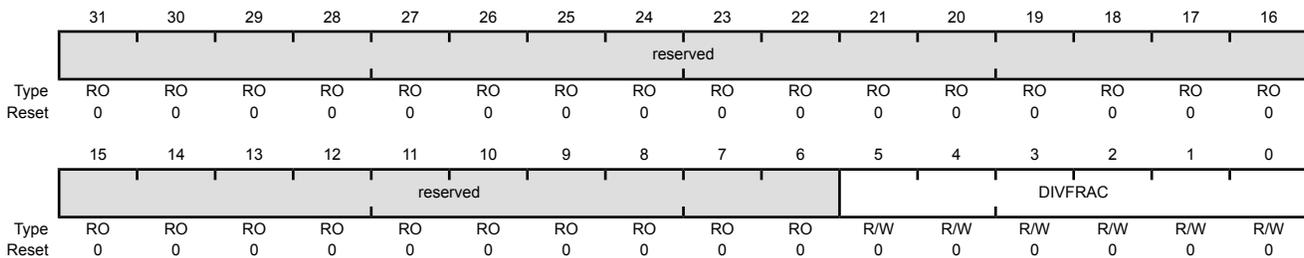
Bit/Field	Name	Type	Reset	Description
31:16	reserved	RO	0x0000	Software should not rely on the value of a reserved bit. To provide compatibility with future products, the value of a reserved bit should be preserved across a read-modify-write operation.
15:0	DIVINT	R/W	0x0000	Integer Baud-Rate Divisor

**Register 6: UART Fractional Baud-Rate Divisor (UARTFBRD), offset 0x028**

The **UARTFBRD** register is the fractional part of the baud-rate divisor value. All the bits are cleared on reset. When changing the **UARTFBRD** register, the new value does not take effect until transmission/reception of the current character is complete. Any changes to the baud-rate divisor must be followed by a write to the **UARTLCRH** register. See “Baud-Rate Generation” on page 588 for configuration details.

UART Fractional Baud-Rate Divisor (UARTFBRD)

UART0 base: 0x4000.C000  
 UART1 base: 0x4000.D000  
 UART2 base: 0x4000.E000  
 Offset 0x028  
 Type R/W, reset 0x0000.0000



Bit/Field	Name	Type	Reset	Description
31:6	reserved	RO	0x0000.000	Software should not rely on the value of a reserved bit. To provide compatibility with future products, the value of a reserved bit should be preserved across a read-modify-write operation.
5:0	DIVFRAC	R/W	0x0	Fractional Baud-Rate Divisor



## Register 7: UART Line Control (UARTLCRH), offset 0x02C

The **UARTLCRH** register is the line control register. Serial parameters such as data length, parity, and stop bit selection are implemented in this register.

When updating the baud-rate divisor (**UARTIBRD** and/or **UARTIFRD**), the **UARTLCRH** register must also be written. The write strobe for the baud-rate divisor registers is tied to the **UARTLCRH** register.

### UART Line Control (UARTLCRH)

UART0 base: 0x4000.C000  
 UART1 base: 0x4000.D000  
 UART2 base: 0x4000.E000  
 Offset 0x02C  
 Type R/W, reset 0x0000.0000

	31	30	29	28	27	26	25	24	23	22	21	20	19	18	17	16
	reserved															
Type	RO	RO	RO	RO	RO	RO	RO	RO	RO	RO	RO	RO	RO	RO	RO	RO
Reset	0	0	0	0	0	0	0	0	0	0	0	0	0	0	0	0
	15	14	13	12	11	10	9	8	7	6	5	4	3	2	1	0
	reserved								SPS	WLEN		FEN	STP2	EPS	PEN	BRK
Type	RO	RO	RO	RO	RO	RO	RO	RO	R/W	R/W	R/W	R/W	R/W	R/W	R/W	R/W
Reset	0	0	0	0	0	0	0	0	0	0	0	0	0	0	0	0

Bit/Field	Name	Type	Reset	Description										
31:8	reserved	RO	0x0000.00	Software should not rely on the value of a reserved bit. To provide compatibility with future products, the value of a reserved bit should be preserved across a read-modify-write operation.										
7	SPS	R/W	0	UART Stick Parity Select  When bits 1, 2, and 7 of <b>UARTLCRH</b> are set, the parity bit is transmitted and checked as a 0. When bits 1 and 7 are set and 2 is cleared, the parity bit is transmitted and checked as a 1.  When this bit is cleared, stick parity is disabled.										
6:5	WLEN	R/W	0x0	UART Word Length  The bits indicate the number of data bits transmitted or received in a frame as follows:  <table border="1"> <thead> <tr> <th>Value</th> <th>Description</th> </tr> </thead> <tbody> <tr> <td>0x0</td> <td>5 bits (default)</td> </tr> <tr> <td>0x1</td> <td>6 bits</td> </tr> <tr> <td>0x2</td> <td>7 bits</td> </tr> <tr> <td>0x3</td> <td>8 bits</td> </tr> </tbody> </table>	Value	Description	0x0	5 bits (default)	0x1	6 bits	0x2	7 bits	0x3	8 bits
Value	Description													
0x0	5 bits (default)													
0x1	6 bits													
0x2	7 bits													
0x3	8 bits													
4	FEN	R/W	0	UART Enable FIFOs  <table border="1"> <thead> <tr> <th>Value</th> <th>Description</th> </tr> </thead> <tbody> <tr> <td>1</td> <td>The transmit and receive FIFO buffers are enabled (FIFO mode).</td> </tr> <tr> <td>0</td> <td>The FIFOs are disabled (Character mode). The FIFOs become 1-byte-deep holding registers.</td> </tr> </tbody> </table>	Value	Description	1	The transmit and receive FIFO buffers are enabled (FIFO mode).	0	The FIFOs are disabled (Character mode). The FIFOs become 1-byte-deep holding registers.				
Value	Description													
1	The transmit and receive FIFO buffers are enabled (FIFO mode).													
0	The FIFOs are disabled (Character mode). The FIFOs become 1-byte-deep holding registers.													

Bit/Field	Name	Type	Reset	Description
3	STP2	R/W	0	<p>UART Two Stop Bits Select</p> <p>Value Description</p> <p>1 Two stop bits are transmitted at the end of a frame. The receive logic does not check for two stop bits being received.</p> <p>When in 7816 smartcard mode (the <code>SMART</code> bit is set in the <code>UARTCTL</code> register), the number of stop bits is forced to 2.</p> <p>0 One stop bit is transmitted at the end of a frame.</p>
2	EPS	R/W	0	<p>UART Even Parity Select</p> <p>Value Description</p> <p>1 Even parity generation and checking is performed during transmission and reception, which checks for an even number of 1s in data and parity bits.</p> <p>0 Odd parity is performed, which checks for an odd number of 1s.</p> <p>This bit has no effect when parity is disabled by the <code>PEN</code> bit.</p>
1	PEN	R/W	0	<p>UART Parity Enable</p> <p>Value Description</p> <p>1 Parity checking and generation is enabled.</p> <p>0 Parity is disabled and no parity bit is added to the data frame.</p>
0	BRK	R/W	0	<p>UART Send Break</p> <p>Value Description</p> <p>1 A Low level is continually output on the <code>UnTx</code> signal, after completing transmission of the current character. For the proper execution of the break command, software must set this bit for at least two frames (character periods).</p> <p>0 Normal use.</p>

## Register 8: UART Control (UARTCTL), offset 0x030

The **UARTCTL** register is the control register. All the bits are cleared on reset except for the Transmit Enable (**TXE**) and Receive Enable (**RXE**) bits, which are set.

To enable the UART module, the **UARTEN** bit must be set. If software requires a configuration change in the module, the **UARTEN** bit must be cleared before the configuration changes are written. If the UART is disabled during a transmit or receive operation, the current transaction is completed prior to the UART stopping.

Note that bits [15:14,11:10] are only implemented on UART1. These bits are reserved on UART0 and UART2.

**Note:** The **UARTCTL** register should not be changed while the UART is enabled or else the results are unpredictable. The following sequence is recommended for making changes to the **UARTCTL** register.

1. Disable the UART.
2. Wait for the end of transmission or reception of the current character.
3. Flush the transmit FIFO by clearing bit 4 (**FEN**) in the line control register (**UARTLCRH**).
4. Reprogram the control register.
5. Enable the UART.

### UART Control (UARTCTL)

UART0 base: 0x4000.C000  
 UART1 base: 0x4000.D000  
 UART2 base: 0x4000.E000  
 Offset 0x030  
 Type R/W, reset 0x0000.0300

	31	30	29	28	27	26	25	24	23	22	21	20	19	18	17	16
	reserved															
Type	RO	RO	RO	RO	RO	RO	RO	RO	RO	RO	RO	RO	RO	RO	RO	RO
Reset	0	0	0	0	0	0	0	0	0	0	0	0	0	0	0	0
	15	14	13	12	11	10	9	8	7	6	5	4	3	2	1	0
	CTSEN	RTSEN	reserved	RTS	DTR	RXE	TXE	LBE	LIN	HSE	EOT	SMART	SIRLP	SIREN	UARTEN	
Type	R/W	R/W	RO	RO	R/W	R/W	R/W	R/W	R/W	R/W	R/W	R/W	R/W	R/W	R/W	R/W
Reset	0	0	0	0	0	0	1	1	0	0	0	0	0	0	0	0

Bit/Field	Name	Type	Reset	Description
31:16	reserved	RO	0x0000	Software should not rely on the value of a reserved bit. To provide compatibility with future products, the value of a reserved bit should be preserved across a read-modify-write operation.

Bit/Field	Name	Type	Reset	Description
15	CTSEN	R/W	0	<p>Enable Clear To Send</p> <p>Value Description</p> <p>1 CTS hardware flow control is enabled. Data is only transmitted when the <code>U1CTS</code> signal is asserted.</p> <p>0 CTS hardware flow control is disabled.</p> <p>This bit is implemented only on UART1 and is reserved for UART0 and UART2.</p>
14	RTSEN	R/W	0	<p>Enable Request to Send</p> <p>Value Description</p> <p>1 RTS hardware flow control is enabled. Data is only requested (by asserting <code>U1RTS</code>) when the receive FIFO has available entries.</p> <p>0 RTS hardware flow control is disabled.</p> <p>This bit is implemented only on UART1 and is reserved for UART0 and UART2.</p>
13:12	reserved	RO	0	<p>Software should not rely on the value of a reserved bit. To provide compatibility with future products, the value of a reserved bit should be preserved across a read-modify-write operation.</p>
11	RTS	R/W	0	<p>Request to Send</p> <p>When <code>RTSEN</code> is clear, the status of this bit is reflected on the <code>U1RTS</code> signal. If <code>RTSEN</code> is set, this bit is ignored on a write and should be ignored on read.</p> <p>This bit is implemented only on UART1 and is reserved for UART0 and UART2.</p>
10	DTR	R/W	0	<p>Data Terminal Ready</p> <p>This bit sets the state of the <code>U1DTR</code> output.</p> <p>This bit is implemented only on UART1 and is reserved for UART0 and UART2.</p>
9	RXE	R/W	1	<p>UART Receive Enable</p> <p>Value Description</p> <p>1 The receive section of the UART is enabled.</p> <p>0 The receive section of the UART is disabled.</p> <p>If the UART is disabled in the middle of a receive, it completes the current character before stopping.</p> <p><b>Note:</b> To enable reception, the <code>UARTEN</code> bit must also be set.</p>

Bit/Field	Name	Type	Reset	Description
8	TXE	R/W	1	<p>UART Transmit Enable</p> <p>Value Description</p> <p>1 The transmit section of the UART is enabled.</p> <p>0 The transmit section of the UART is disabled.</p> <p>If the UART is disabled in the middle of a transmission, it completes the current character before stopping.</p> <p><b>Note:</b> To enable transmission, the <code>UARTEN</code> bit must also be set.</p>
7	LBE	R/W	0	<p>UART Loop Back Enable</p> <p>Value Description</p> <p>1 The <code>UnTx</code> path is fed through the <code>UnRx</code> path.</p> <p>0 Normal operation.</p>
6	LIN	R/W	0	<p>LIN Mode Enable</p> <p>Value Description</p> <p>1 The UART operates in LIN mode.</p> <p>0 Normal operation.</p>
5	HSE	R/W	0	<p>High-Speed Enable</p> <p>Value Description</p> <p>1 The UART is clocked using the system clock divided by 8.</p> <p>0 The UART is clocked using the system clock divided by 16.</p> <p><b>Note:</b> System clock used is also dependent on the baud-rate divisor configuration (see page 607) and page 608).</p>
4	EOT	R/W	0	<p>End of Transmission</p> <p>This bit determines the behavior of the <code>TXRIS</code> bit in the <code>UARTRIS</code> register.</p> <p>Value Description</p> <p>1 The <code>TXRIS</code> bit is set only after all transmitted data, including stop bits, have cleared the serializer.</p> <p>0 The <code>TXRIS</code> bit is set when the transmit FIFO condition specified in <code>UARTIFLS</code> is met.</p>

Bit/Field	Name	Type	Reset	Description
3	SMART	R/W	0	<p>ISO 7816 Smart Card Support</p> <p>Value Description</p> <p>1 The UART operates in Smart Card mode.</p> <p>0 Normal operation.</p> <p>The application must ensure that it sets 8-bit word length (<i>WLEN</i> set to 0x3) and even parity (<i>PEN</i> set to 1, <i>EPS</i> set to 1, <i>SPS</i> set to 0) in <b>UARTLCRH</b> when using ISO 7816 mode.</p> <p>In this mode, the value of the <i>STP2</i> bit in <b>UARTLCRH</b> is ignored and the number of stop bits is forced to 2. Note that the UART does not support automatic retransmission on parity errors. If a parity error is detected on transmission, all further transmit operations are aborted and software must handle retransmission of the affected byte or message.</p>
2	SIRLP	R/W	0	<p>UART SIR Low-Power Mode</p> <p>This bit selects the IrDA encoding mode.</p> <p>Value Description</p> <p>1 The UART operates in SIR Low-Power mode. Low-level bits are transmitted with a pulse width which is 3 times the period of the <i>IrLPAud16</i> input signal, regardless of the selected bit rate.</p> <p>0 Low-level bits are transmitted as an active High pulse with a width of 3/16th of the bit period.</p> <p>Setting this bit uses less power, but might reduce transmission distances. See page 606 for more information.</p>
1	SIREN	R/W	0	<p>UART SIR Enable</p> <p>Value Description</p> <p>1 The IrDA SIR block is enabled, and the UART will transmit and receive data using SIR protocol.</p> <p>0 Normal operation.</p>
0	UARTEN	R/W	0	<p>UART Enable</p> <p>Value Description</p> <p>1 The UART is enabled.</p> <p>0 The UART is disabled.</p> <p>If the UART is disabled in the middle of transmission or reception, it completes the current character before stopping.</p>

## Register 9: UART Interrupt FIFO Level Select (UARTIFLS), offset 0x034

The **UARTIFLS** register is the interrupt FIFO level select register. You can use this register to define the FIFO level at which the **TXRIS** and **RXRIS** bits in the **UARTRIS** register are triggered.

The interrupts are generated based on a transition through a level rather than being based on the level. That is, the interrupts are generated when the fill level progresses through the trigger level. For example, if the receive trigger level is set to the half-way mark, the interrupt is triggered as the module is receiving the 9th character.

Out of reset, the **TXIFLSEL** and **RXIFLSEL** bits are configured so that the FIFOs trigger an interrupt at the half-way mark.

### UART Interrupt FIFO Level Select (UARTIFLS)

UART0 base: 0x4000.C000  
 UART1 base: 0x4000.D000  
 UART2 base: 0x4000.E000  
 Offset 0x034  
 Type R/W, reset 0x0000.0012

	31	30	29	28	27	26	25	24	23	22	21	20	19	18	17	16
	reserved															
Type	RO	RO	RO	RO	RO	RO	RO	RO	RO	RO	RO	RO	RO	RO	RO	RO
Reset	0	0	0	0	0	0	0	0	0	0	0	0	0	0	0	0
	15	14	13	12	11	10	9	8	7	6	5	4	3	2	1	0
	reserved										RXIFLSEL			TXIFLSEL		
Type	RO	RO	RO	RO	RO	RO	RO	RO	RO	RO	R/W	R/W	R/W	R/W	R/W	R/W
Reset	0	0	0	0	0	0	0	0	0	0	0	1	0	0	1	0

Bit/Field	Name	Type	Reset	Description
31:6	reserved	RO	0x0000.00	Software should not rely on the value of a reserved bit. To provide compatibility with future products, the value of a reserved bit should be preserved across a read-modify-write operation.
5:3	RXIFLSEL	R/W	0x2	UART Receive Interrupt FIFO Level Select

The trigger points for the receive interrupt are as follows:

Value	Description
0x0	RX FIFO $\geq \frac{1}{8}$ full
0x1	RX FIFO $\geq \frac{1}{4}$ full
0x2	RX FIFO $\geq \frac{1}{2}$ full (default)
0x3	RX FIFO $\geq \frac{3}{4}$ full
0x4	RX FIFO $\geq \frac{7}{8}$ full
0x5-0x7	Reserved

Bit/Field	Name	Type	Reset	Description
2:0	TXIFLSEL	R/W	0x2	UART Transmit Interrupt FIFO Level Select The trigger points for the transmit interrupt are as follows:  Value    Description 0x0    TX FIFO $\leq$ $\frac{1}{8}$ full 0x1    TX FIFO $\leq$ $\frac{1}{4}$ full 0x2    TX FIFO $\leq$ $\frac{1}{2}$ full (default) 0x3    TX FIFO $\leq$ $\frac{3}{4}$ full 0x4    TX FIFO $\leq$ $\frac{7}{8}$ full 0x5-0x7 Reserved  <b>Note:</b> If the EOT bit in <b>UARTCTL</b> is set (see page 611), the transmit interrupt is generated once the FIFO is completely empty and all data including stop bits have left the transmit serializer. In this case, the setting of TXIFLSEL is ignored.



## Register 10: UART Interrupt Mask (UARTIM), offset 0x038

The **UARTIM** register is the interrupt mask set/clear register.

On a read, this register gives the current value of the mask on the relevant interrupt. Setting a bit allows the corresponding raw interrupt signal to be routed to the interrupt controller. Clearing a bit prevents the raw interrupt signal from being sent to the interrupt controller.

Note that bits [3:0] are only implemented on UART1. These bits are reserved on UART0 and UART2.

### UART Interrupt Mask (UARTIM)

UART0 base: 0x4000.C000  
 UART1 base: 0x4000.D000  
 UART2 base: 0x4000.E000  
 Offset 0x038  
 Type R/W, reset 0x0000.0000

	31	30	29	28	27	26	25	24	23	22	21	20	19	18	17	16
	reserved															
Type	RO	RO	RO	RO	RO	RO	RO	RO	RO	RO	RO	RO	RO	RO	RO	RO
Reset	0	0	0	0	0	0	0	0	0	0	0	0	0	0	0	0
	15	14	13	12	11	10	9	8	7	6	5	4	3	2	1	0
	LME5IM	LME1IM	LMSBIM	reserved	reserved	OEIM	BEIM	PEIM	FEIM	RTIM	TXIM	RXIM	DSRIM	DCDIM	CTSIM	RIIM
Type	R/W	R/W	R/W	RO	RO	R/W	R/W	R/W	R/W	R/W	R/W	R/W	R/W	R/W	R/W	R/W
Reset	0	0	0	0	0	0	0	0	0	0	0	0	0	0	0	0

Bit/Field	Name	Type	Reset	Description
31:16	reserved	RO	0x0000	Software should not rely on the value of a reserved bit. To provide compatibility with future products, the value of a reserved bit should be preserved across a read-modify-write operation.
15	LME5IM	R/W	0	LIN Mode Edge 5 Interrupt Mask  Value Description 1 An interrupt is sent to the interrupt controller when the <b>LME5RIS</b> bit in the <b>UARTRIS</b> register is set. 0 The <b>LME5RIS</b> interrupt is suppressed and not sent to the interrupt controller.
14	LME1IM	R/W	0	LIN Mode Edge 1 Interrupt Mask  Value Description 1 An interrupt is sent to the interrupt controller when the <b>LME1RIS</b> bit in the <b>UARTRIS</b> register is set. 0 The <b>LME1RIS</b> interrupt is suppressed and not sent to the interrupt controller.
13	LMSBIM	R/W	0	LIN Mode Sync Break Interrupt Mask  Value Description 1 An interrupt is sent to the interrupt controller when the <b>LMSBRIS</b> bit in the <b>UARTRIS</b> register is set. 0 The <b>LMSBRIS</b> interrupt is suppressed and not sent to the interrupt controller.

Bit/Field	Name	Type	Reset	Description
12:11	reserved	RO	0x0	Software should not rely on the value of a reserved bit. To provide compatibility with future products, the value of a reserved bit should be preserved across a read-modify-write operation.
10	OEIM	R/W	0	<p>UART Overrun Error Interrupt Mask</p> <p>Value Description</p> <p>1 An interrupt is sent to the interrupt controller when the <code>OERIS</code> bit in the <b>UARTRIS</b> register is set.</p> <p>0 The <code>OERIS</code> interrupt is suppressed and not sent to the interrupt controller.</p>
9	BEIM	R/W	0	<p>UART Break Error Interrupt Mask</p> <p>Value Description</p> <p>1 An interrupt is sent to the interrupt controller when the <code>BERIS</code> bit in the <b>UARTRIS</b> register is set.</p> <p>0 The <code>BERIS</code> interrupt is suppressed and not sent to the interrupt controller.</p>
8	PEIM	R/W	0	<p>UART Parity Error Interrupt Mask</p> <p>Value Description</p> <p>1 An interrupt is sent to the interrupt controller when the <code>PERIS</code> bit in the <b>UARTRIS</b> register is set.</p> <p>0 The <code>PERIS</code> interrupt is suppressed and not sent to the interrupt controller.</p>
7	FEIM	R/W	0	<p>UART Framing Error Interrupt Mask</p> <p>Value Description</p> <p>1 An interrupt is sent to the interrupt controller when the <code>FERIS</code> bit in the <b>UARTRIS</b> register is set.</p> <p>0 The <code>FERIS</code> interrupt is suppressed and not sent to the interrupt controller.</p>
6	RTIM	R/W	0	<p>UART Receive Time-Out Interrupt Mask</p> <p>Value Description</p> <p>1 An interrupt is sent to the interrupt controller when the <code>RTRIS</code> bit in the <b>UARTRIS</b> register is set.</p> <p>0 The <code>RTRIS</code> interrupt is suppressed and not sent to the interrupt controller.</p>

Bit/Field	Name	Type	Reset	Description
5	TXIM	R/W	0	<p>UART Transmit Interrupt Mask</p> <p>Value Description</p> <p>1 An interrupt is sent to the interrupt controller when the <code>TXRIS</code> bit in the <b>UARTRIS</b> register is set.</p> <p>0 The <code>TXRIS</code> interrupt is suppressed and not sent to the interrupt controller.</p>
4	RXIM	R/W	0	<p>UART Receive Interrupt Mask</p> <p>Value Description</p> <p>1 An interrupt is sent to the interrupt controller when the <code>RXRIS</code> bit in the <b>UARTRIS</b> register is set.</p> <p>0 The <code>RXRIS</code> interrupt is suppressed and not sent to the interrupt controller.</p>
3	DSRIM	R/W	0	<p>UART Data Set Ready Modem Interrupt Mask</p> <p>Value Description</p> <p>1 An interrupt is sent to the interrupt controller when the <code>DSRRIS</code> bit in the <b>UARTRIS</b> register is set.</p> <p>0 The <code>DSRRIS</code> interrupt is suppressed and not sent to the interrupt controller.</p> <p>This bit is implemented only on UART1 and is reserved for UART0 and UART2.</p>
2	DCDIM	R/W	0	<p>UART Data Carrier Detect Modem Interrupt Mask</p> <p>Value Description</p> <p>1 An interrupt is sent to the interrupt controller when the <code>DCDRIS</code> bit in the <b>UARTRIS</b> register is set.</p> <p>0 The <code>DCDRIS</code> interrupt is suppressed and not sent to the interrupt controller.</p> <p>This bit is implemented only on UART1 and is reserved for UART0 and UART2.</p>
1	CTSIM	R/W	0	<p>UART Clear to Send Modem Interrupt Mask</p> <p>Value Description</p> <p>1 An interrupt is sent to the interrupt controller when the <code>CTSRIS</code> bit in the <b>UARTRIS</b> register is set.</p> <p>0 The <code>CTSRIS</code> interrupt is suppressed and not sent to the interrupt controller.</p> <p>This bit is implemented only on UART1 and is reserved for UART0 and UART2.</p>

Bit/Field	Name	Type	Reset	Description
0	RIM	R/W	0	UART Ring Indicator Modem Interrupt Mask
				Value Description
			1	An interrupt is sent to the interrupt controller when the <code>RIRIS</code> bit in the <b>UARTRIS</b> register is set.
			0	The <code>RIRIS</code> interrupt is suppressed and not sent to the interrupt controller.
				This bit is implemented only on UART1 and is reserved for UART0 and UART2.

## Register 11: UART Raw Interrupt Status (UARTRIS), offset 0x03C

The **UARTRIS** register is the raw interrupt status register. On a read, this register gives the current raw status value of the corresponding interrupt. A write has no effect.

Note that bits [3:0] are only implemented on UART1. These bits are reserved on UART0 and UART2.

### UART Raw Interrupt Status (UARTRIS)

UART0 base: 0x4000.C000  
 UART1 base: 0x4000.D000  
 UART2 base: 0x4000.E000  
 Offset 0x03C  
 Type RO, reset 0x0000.000F

	31	30	29	28	27	26	25	24	23	22	21	20	19	18	17	16
	reserved															
Type	RO	RO	RO	RO	RO	RO	RO	RO	RO	RO	RO	RO	RO	RO	RO	RO
Reset	0	0	0	0	0	0	0	0	0	0	0	0	0	0	0	0
	15	14	13	12	11	10	9	8	7	6	5	4	3	2	1	0
	LME5RIS	LME1RIS	LMSBRIS	reserved	OERIS	BERIS	PERIS	FERIS	RTRIS	TXRIS	RXRIS	DSRRIS	DCDRIS	CTSRIS	RIRIS	
Type	RO	RO	RO	RO	RO	RO	RO	RO	RO	RO	RO	RO	RO	RO	RO	RO
Reset	0	0	0	0	0	0	0	0	0	0	0	0	0	0	0	0

Bit/Field	Name	Type	Reset	Description
31:16	reserved	RO	0x0000	Software should not rely on the value of a reserved bit. To provide compatibility with future products, the value of a reserved bit should be preserved across a read-modify-write operation.
15	LME5RIS	RO	0	<p>LIN Mode Edge 5 Raw Interrupt Status</p> <p>Value Description</p> <p>1 The timer value at the 5th falling edge of the LIN Sync Field has been captured.</p> <p>0 No interrupt</p> <p>This bit is cleared by writing a 1 to the LME5IC bit in the <b>UARTICR</b> register.</p>
14	LME1RIS	RO	0	<p>LIN Mode Edge 1 Raw Interrupt Status</p> <p>Value Description</p> <p>1 The timer value at the 1st falling edge of the LIN Sync Field has been captured.</p> <p>0 No interrupt</p> <p>This bit is cleared by writing a 1 to the LME1IC bit in the <b>UARTICR</b> register.</p>
13	LMSBRIS	RO	0	<p>LIN Mode Sync Break Raw Interrupt Status</p> <p>Value Description</p> <p>1 A LIN Sync Break has been detected.</p> <p>0 No interrupt</p> <p>This bit is cleared by writing a 1 to the LMSBIC bit in the <b>UARTICR</b> register.</p>

Bit/Field	Name	Type	Reset	Description
12:11	reserved	RO	0x0	Software should not rely on the value of a reserved bit. To provide compatibility with future products, the value of a reserved bit should be preserved across a read-modify-write operation.
10	OERIS	RO	0	<p>UART Overrun Error Raw Interrupt Status</p> <p>Value Description</p> <p>1 An overrun error has occurred.</p> <p>0 No interrupt</p> <p>This bit is cleared by writing a 1 to the OEIC bit in the <b>UARTICR</b> register.</p>
9	BERIS	RO	0	<p>UART Break Error Raw Interrupt Status</p> <p>Value Description</p> <p>1 A break error has occurred.</p> <p>0 No interrupt</p> <p>This bit is cleared by writing a 1 to the BEIC bit in the <b>UARTICR</b> register.</p>
8	PERIS	RO	0	<p>UART Parity Error Raw Interrupt Status</p> <p>Value Description</p> <p>1 A parity error has occurred.</p> <p>0 No interrupt</p> <p>This bit is cleared by writing a 1 to the PEIC bit in the <b>UARTICR</b> register.</p>
7	FERIS	RO	0	<p>UART Framing Error Raw Interrupt Status</p> <p>Value Description</p> <p>1 A framing error has occurred.</p> <p>0 No interrupt</p> <p>This bit is cleared by writing a 1 to the FEIC bit in the <b>UARTICR</b> register.</p>
6	RTRIS	RO	0	<p>UART Receive Time-Out Raw Interrupt Status</p> <p>Value Description</p> <p>1 A receive time out has occurred.</p> <p>0 No interrupt</p> <p>This bit is cleared by writing a 1 to the RTIC bit in the <b>UARTICR</b> register.</p>

Bit/Field	Name	Type	Reset	Description
5	TXRIS	RO	0	<p>UART Transmit Raw Interrupt Status</p> <p>Value Description</p> <p>1 If the <b>EOT</b> bit in the <b>UARTCTRL</b> register is clear, the transmit FIFO level has passed through the condition defined in the <b>UARTIFLS</b> register.</p> <p>If the <b>EOT</b> bit is set, the last bit of all transmitted data and flags has left the serializer.</p> <p>0 No interrupt</p> <p>This bit is cleared by writing a 1 to the <b>TXIC</b> bit in the <b>UARTICR</b> register.</p>
4	RXRIS	RO	0	<p>UART Receive Raw Interrupt Status</p> <p>Value Description</p> <p>1 The receive FIFO level has passed through the condition defined in the <b>UARTIFLS</b> register.</p> <p>0 No interrupt</p> <p>This bit is cleared by writing a 1 to the <b>RXIC</b> bit in the <b>UARTICR</b> register.</p>
3	DSRRIS	RO	0	<p>UART Data Set Ready Modem Raw Interrupt Status</p> <p>Value Description</p> <p>1 Data Set Ready used for software flow control.</p> <p>0 No interrupt</p> <p>This bit is cleared by writing a 1 to the <b>DSRIC</b> bit in the <b>UARTICR</b> register.</p> <p>This bit is implemented only on UART1 and is reserved for UART0 and UART2.</p>
2	DCDRIS	RO	0	<p>UART Data Carrier Detect Modem Raw Interrupt Status</p> <p>Value Description</p> <p>1 Data Carrier Detect used for software flow control.</p> <p>0 No interrupt</p> <p>This bit is cleared by writing a 1 to the <b>DCDIC</b> bit in the <b>UARTICR</b> register.</p> <p>This bit is implemented only on UART1 and is reserved for UART0 and UART2.</p>
1	CTSRIS	RO	0	<p>UART Clear to Send Modem Raw Interrupt Status</p> <p>Value Description</p> <p>1 Clear to Send used for software flow control.</p> <p>0 No interrupt</p> <p>This bit is cleared by writing a 1 to the <b>CTSIC</b> bit in the <b>UARTICR</b> register.</p> <p>This bit is implemented only on UART1 and is reserved for UART0 and UART2.</p>

Bit/Field	Name	Type	Reset	Description
0	RIRIS	RO	0	UART Ring Indicator Modem Raw Interrupt Status  Value Description 1 Ring Indicator used for software flow control. 0 No interrupt  This bit is cleared by writing a 1 to the RIIIC bit in the <b>UARTICR</b> register. This bit is implemented only on UART1 and is reserved for UART0 and UART2.



## Register 12: UART Masked Interrupt Status (UARTMIS), offset 0x040

The **UARTMIS** register is the masked interrupt status register. On a read, this register gives the current masked status value of the corresponding interrupt. A write has no effect.

Note that bits [3:0] are only implemented on UART1. These bits are reserved on UART0 and UART2.

### UART Masked Interrupt Status (UARTMIS)

UART0 base: 0x4000.C000  
 UART1 base: 0x4000.D000  
 UART2 base: 0x4000.E000  
 Offset 0x040  
 Type RO, reset 0x0000.0000

	31	30	29	28	27	26	25	24	23	22	21	20	19	18	17	16
	reserved															
Type	RO	RO	RO	RO	RO	RO	RO	RO	RO	RO	RO	RO	RO	RO	RO	RO
Reset	0	0	0	0	0	0	0	0	0	0	0	0	0	0	0	0
	15	14	13	12	11	10	9	8	7	6	5	4	3	2	1	0
	LME5MIS	LME1MIS	LMSBMIS	reserved	OEMIS	BEMIS	PEMIS	FEMIS	RTMIS	TXMIS	RXMIS	DSRMIS	DCDMIS	CTSMIS	RIMIS	
Type	RO	RO	RO	RO	RO	RO	RO	RO	RO	RO	RO	RO	RO	RO	RO	RO
Reset	0	0	0	0	0	0	0	0	0	0	0	0	0	0	0	0

Bit/Field	Name	Type	Reset	Description
31:16	reserved	RO	0x0000	Software should not rely on the value of a reserved bit. To provide compatibility with future products, the value of a reserved bit should be preserved across a read-modify-write operation.
15	LME5MIS	RO	0	<p>LIN Mode Edge 5 Masked Interrupt Status</p> <p>Value Description</p> <p>1 An unmasked interrupt was signaled due to the 5th falling edge of the LIN Sync Field.</p> <p>0 An interrupt has not occurred or is masked.</p> <p>This bit is cleared by writing a 1 to the <b>LME5IC</b> bit in the <b>UARTICR</b> register.</p>
14	LME1MIS	RO	0	<p>LIN Mode Edge 1 Masked Interrupt Status</p> <p>Value Description</p> <p>1 An unmasked interrupt was signaled due to the 1st falling edge of the LIN Sync Field.</p> <p>0 An interrupt has not occurred or is masked.</p> <p>This bit is cleared by writing a 1 to the <b>LME1IC</b> bit in the <b>UARTICR</b> register.</p>
13	LMSBMIS	RO	0	<p>LIN Mode Sync Break Masked Interrupt Status</p> <p>Value Description</p> <p>1 An unmasked interrupt was signaled due the receipt of a LIN Sync Break.</p> <p>0 An interrupt has not occurred or is masked.</p> <p>This bit is cleared by writing a 1 to the <b>LMSBIC</b> bit in the <b>UARTICR</b> register.</p>

Bit/Field	Name	Type	Reset	Description
12:11	reserved	RO	0x0	Software should not rely on the value of a reserved bit. To provide compatibility with future products, the value of a reserved bit should be preserved across a read-modify-write operation.
10	OEMIS	RO	0	<p>UART Overrun Error Masked Interrupt Status</p> <p>Value Description</p> <p>1 An unmasked interrupt was signaled due to an overrun error.</p> <p>0 An interrupt has not occurred or is masked.</p> <p>This bit is cleared by writing a 1 to the OEIC bit in the <b>UARTICR</b> register.</p>
9	BEMIS	RO	0	<p>UART Break Error Masked Interrupt Status</p> <p>Value Description</p> <p>1 An unmasked interrupt was signaled due to a break error.</p> <p>0 An interrupt has not occurred or is masked.</p> <p>This bit is cleared by writing a 1 to the BEIC bit in the <b>UARTICR</b> register.</p>
8	PEMIS	RO	0	<p>UART Parity Error Masked Interrupt Status</p> <p>Value Description</p> <p>1 An unmasked interrupt was signaled due to a parity error.</p> <p>0 An interrupt has not occurred or is masked.</p> <p>This bit is cleared by writing a 1 to the PEIC bit in the <b>UARTICR</b> register.</p>
7	FEMIS	RO	0	<p>UART Framing Error Masked Interrupt Status</p> <p>Value Description</p> <p>1 An unmasked interrupt was signaled due to a framing error.</p> <p>0 An interrupt has not occurred or is masked.</p> <p>This bit is cleared by writing a 1 to the FEIC bit in the <b>UARTICR</b> register.</p>
6	RTMIS	RO	0	<p>UART Receive Time-Out Masked Interrupt Status</p> <p>Value Description</p> <p>1 An unmasked interrupt was signaled due to a receive time out.</p> <p>0 An interrupt has not occurred or is masked.</p> <p>This bit is cleared by writing a 1 to the RTIC bit in the <b>UARTICR</b> register.</p>
5	TXMIS	RO	0	<p>UART Transmit Masked Interrupt Status</p> <p>Value Description</p> <p>1 An unmasked interrupt was signaled due to passing through the specified transmit FIFO level (if the EOT bit is clear) or due to the transmission of the last data bit (if the EOT bit is set).</p> <p>0 An interrupt has not occurred or is masked.</p> <p>This bit is cleared by writing a 1 to the TXIC bit in the <b>UARTICR</b> register.</p>

Bit/Field	Name	Type	Reset	Description
4	RXMIS	RO	0	<p>UART Receive Masked Interrupt Status</p> <p>Value Description</p> <p>1 An unmasked interrupt was signaled due to passing through the specified receive FIFO level.</p> <p>0 An interrupt has not occurred or is masked.</p> <p>This bit is cleared by writing a 1 to the <code>RXIC</code> bit in the <b>UARTICR</b> register.</p>
3	DSRMIS	RO	0	<p>UART Data Set Ready Modem Masked Interrupt Status</p> <p>Value Description</p> <p>1 An unmasked interrupt was signaled due to Data Set Ready.</p> <p>0 An interrupt has not occurred or is masked.</p> <p>This bit is cleared by writing a 1 to the <code>DSRIC</code> bit in the <b>UARTICR</b> register.</p> <p>This bit is implemented only on UART1 and is reserved for UART0 and UART2.</p>
2	DCDMIS	RO	0	<p>UART Data Carrier Detect Modem Masked Interrupt Status</p> <p>Value Description</p> <p>1 An unmasked interrupt was signaled due to Data Carrier Detect.</p> <p>0 An interrupt has not occurred or is masked.</p> <p>This bit is cleared by writing a 1 to the <code>DCDIC</code> bit in the <b>UARTICR</b> register.</p> <p>This bit is implemented only on UART1 and is reserved for UART0 and UART2.</p>
1	CTSMIS	RO	0	<p>UART Clear to Send Modem Masked Interrupt Status</p> <p>Value Description</p> <p>1 An unmasked interrupt was signaled due to Clear to Send.</p> <p>0 An interrupt has not occurred or is masked.</p> <p>This bit is cleared by writing a 1 to the <code>CTSIC</code> bit in the <b>UARTICR</b> register.</p> <p>This bit is implemented only on UART1 and is reserved for UART0 and UART2.</p>
0	RIMIS	RO	0	<p>UART Ring Indicator Modem Masked Interrupt Status</p> <p>Value Description</p> <p>1 An unmasked interrupt was signaled due to Ring Indicator.</p> <p>0 An interrupt has not occurred or is masked.</p> <p>This bit is cleared by writing a 1 to the <code>RIIC</code> bit in the <b>UARTICR</b> register.</p> <p>This bit is implemented only on UART1 and is reserved for UART0 and UART2.</p>

### Register 13: UART Interrupt Clear (UARTICR), offset 0x044

The **UARTICR** register is the interrupt clear register. On a write of 1, the corresponding interrupt (both raw interrupt and masked interrupt, if enabled) is cleared. A write of 0 has no effect.

Note that bits [3:0] are only implemented on UART1. These bits are reserved on UART0 and UART2.

#### UART Interrupt Clear (UARTICR)

UART0 base: 0x4000.C000  
 UART1 base: 0x4000.D000  
 UART2 base: 0x4000.E000  
 Offset 0x044  
 Type W1C, reset 0x0000.0000

	31	30	29	28	27	26	25	24	23	22	21	20	19	18	17	16
	reserved															
Type	RO	RO	RO	RO	RO	RO	RO	RO	RO	RO	RO	RO	RO	RO	RO	RO
Reset	0	0	0	0	0	0	0	0	0	0	0	0	0	0	0	0
	15	14	13	12	11	10	9	8	7	6	5	4	3	2	1	0
	LME5MIC	LME1MIC	LMSBMIC	reserved	OEIC	BEIC	PEIC	FEIC	RTIC	TXIC	RXIC	DSRMIC	DCDMIC	CTSMIC	RIMIC	
Type	W1C	W1C	W1C	RO	RO	W1C	W1C	W1C	W1C	W1C	W1C	W1C	W1C	W1C	W1C	W1C
Reset	0	0	0	0	0	0	0	0	0	0	0	0	0	0	0	0

Bit/Field	Name	Type	Reset	Description
31:16	reserved	RO	0x0000	Software should not rely on the value of a reserved bit. To provide compatibility with future products, the value of a reserved bit should be preserved across a read-modify-write operation.
15	LME5MIC	W1C	0	LIN Mode Edge 5 Interrupt Clear  Writing a 1 to this bit clears the <b>LME5RIS</b> bit in the <b>UARTRIS</b> register and the <b>LME5MIS</b> bit in the <b>UARTMIS</b> register.
14	LME1MIC	W1C	0	LIN Mode Edge 1 Interrupt Clear  Writing a 1 to this bit clears the <b>LME1RIS</b> bit in the <b>UARTRIS</b> register and the <b>LME1MIS</b> bit in the <b>UARTMIS</b> register.
13	LMSBMIC	W1C	0	LIN Mode Sync Break Interrupt Clear  Writing a 1 to this bit clears the <b>LMSBRIS</b> bit in the <b>UARTRIS</b> register and the <b>LMSBMIS</b> bit in the <b>UARTMIS</b> register.
12:11	reserved	RO	0x0	Software should not rely on the value of a reserved bit. To provide compatibility with future products, the value of a reserved bit should be preserved across a read-modify-write operation.
10	OEIC	W1C	0	Overrun Error Interrupt Clear  Writing a 1 to this bit clears the <b>OERIS</b> bit in the <b>UARTRIS</b> register and the <b>OEMIS</b> bit in the <b>UARTMIS</b> register.
9	BEIC	W1C	0	Break Error Interrupt Clear  Writing a 1 to this bit clears the <b>BERIS</b> bit in the <b>UARTRIS</b> register and the <b>BEMIS</b> bit in the <b>UARTMIS</b> register.
8	PEIC	W1C	0	Parity Error Interrupt Clear  Writing a 1 to this bit clears the <b>PERIS</b> bit in the <b>UARTRIS</b> register and the <b>PEMIS</b> bit in the <b>UARTMIS</b> register.

Bit/Field	Name	Type	Reset	Description
7	FEIC	W1C	0	Framing Error Interrupt Clear Writing a 1 to this bit clears the <code>FERIS</code> bit in the <b>UARTRIS</b> register and the <code>FEMIS</code> bit in the <b>UARTMIS</b> register.
6	RTIC	W1C	0	Receive Time-Out Interrupt Clear Writing a 1 to this bit clears the <code>RTRIS</code> bit in the <b>UARTRIS</b> register and the <code>RTMIS</code> bit in the <b>UARTMIS</b> register.
5	TXIC	W1C	0	Transmit Interrupt Clear Writing a 1 to this bit clears the <code>TXRIS</code> bit in the <b>UARTRIS</b> register and the <code>TXMIS</code> bit in the <b>UARTMIS</b> register.
4	RXIC	W1C	0	Receive Interrupt Clear Writing a 1 to this bit clears the <code>RXRIS</code> bit in the <b>UARTRIS</b> register and the <code>RXMIS</code> bit in the <b>UARTMIS</b> register.
3	DSRMIC	W1C	0	UART Data Set Ready Modem Interrupt Clear Writing a 1 to this bit clears the <code>DSRRIS</code> bit in the <b>UARTRIS</b> register and the <code>DSRMIS</code> bit in the <b>UARTMIS</b> register. This bit is implemented only on UART1 and is reserved for UART0 and UART2.
2	DCDMIC	W1C	0	UART Data Carrier Detect Modem Interrupt Clear Writing a 1 to this bit clears the <code>DCDRIS</code> bit in the <b>UARTRIS</b> register and the <code>DCDMIS</code> bit in the <b>UARTMIS</b> register. This bit is implemented only on UART1 and is reserved for UART0 and UART2.
1	CTSMIC	W1C	0	UART Clear to Send Modem Interrupt Clear Writing a 1 to this bit clears the <code>CTSRIS</code> bit in the <b>UARTRIS</b> register and the <code>CTSMIS</code> bit in the <b>UARTMIS</b> register. This bit is implemented only on UART1 and is reserved for UART0 and UART2.
0	RIMIC	W1C	0	UART Ring Indicator Modem Interrupt Clear Writing a 1 to this bit clears the <code>RIRIS</code> bit in the <b>UARTRIS</b> register and the <code>RIMIS</code> bit in the <b>UARTMIS</b> register. This bit is implemented only on UART1 and is reserved for UART0 and UART2.

## Register 14: UART DMA Control (UARTDMACTL), offset 0x048

The **UARTDMACTL** register is the DMA control register.

### UART DMA Control (UARTDMACTL)

UART0 base: 0x4000.C000  
 UART1 base: 0x4000.D000  
 UART2 base: 0x4000.E000  
 Offset 0x048  
 Type R/W, reset 0x0000.0000

	31	30	29	28	27	26	25	24	23	22	21	20	19	18	17	16	
	reserved																
Type	RO	RO	RO	RO	RO	RO	RO	RO	RO	RO	RO	RO	RO	RO	RO	RO	
Reset	0	0	0	0	0	0	0	0	0	0	0	0	0	0	0	0	
	15	14	13	12	11	10	9	8	7	6	5	4	3	2	1	0	
	reserved													DMAERR	TXDMAE	RXDMAE	
Type	RO	RO	RO	RO	RO	RO	RO	RO	RO	RO	RO	RO	RO	RO	R/W	R/W	R/W
Reset	0	0	0	0	0	0	0	0	0	0	0	0	0	0	0	0	0

Bit/Field	Name	Type	Reset	Description
31:3	reserved	RO	0x00000.000	Software should not rely on the value of a reserved bit. To provide compatibility with future products, the value of a reserved bit should be preserved across a read-modify-write operation.
2	DMAERR	R/W	0	DMA on Error  Value Description 1     μDMA receive requests are automatically disabled when a receive error occurs. 0     μDMA receive requests are unaffected when a receive error occurs.
1	TXDMAE	R/W	0	Transmit DMA Enable  Value Description 1     μDMA for the transmit FIFO is enabled. 0     μDMA for the transmit FIFO is disabled.
0	RXDMAE	R/W	0	Receive DMA Enable  Value Description 1     μDMA for the receive FIFO is enabled. 0     μDMA for the receive FIFO is disabled.

**Register 15: UART LIN Control (UARTLCTL), offset 0x090**

The **UARTLCTL** register is the configures the operation of the UART when in LIN mode.

**UART LIN Control (UARTLCTL)**

UART0 base: 0x4000.C000  
 UART1 base: 0x4000.D000  
 UART2 base: 0x4000.E000  
 Offset 0x090  
 Type R/W, reset 0x0000.0000

	31	30	29	28	27	26	25	24	23	22	21	20	19	18	17	16
	reserved															
Type	RO	RO	RO	RO	RO	RO	RO	RO	RO	RO	RO	RO	RO	RO	RO	RO
Reset	0	0	0	0	0	0	0	0	0	0	0	0	0	0	0	0
	15	14	13	12	11	10	9	8	7	6	5	4	3	2	1	0
	reserved										BLEN		reserved			MASTER
Type	RO	RO	RO	RO	RO	RO	RO	RO	RO	RO	R/W	R/W	RO	RO	RO	R/W
Reset	0	0	0	0	0	0	0	0	0	0	0	0	0	0	0	0

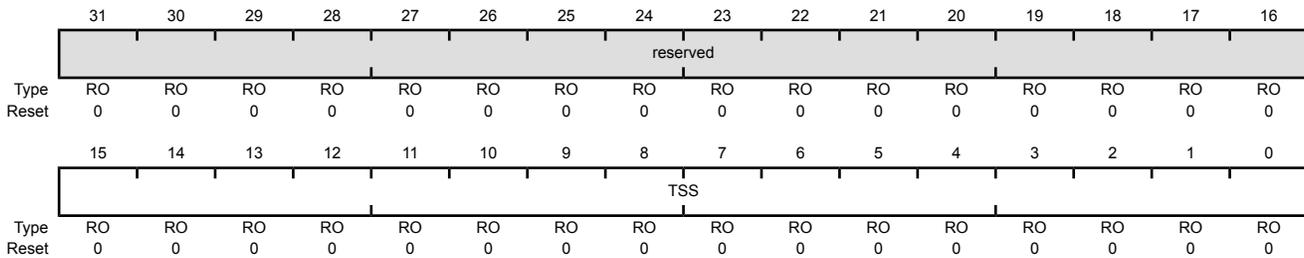
Bit/Field	Name	Type	Reset	Description
31:6	reserved	RO	0x0000.00	Software should not rely on the value of a reserved bit. To provide compatibility with future products, the value of a reserved bit should be preserved across a read-modify-write operation.
5:4	BLEN	R/W	0x0	Sync Break Length  Value Description 0x3 Sync break length is 16T bits 0x2 Sync break length is 15T bits 0x1 Sync break length is 14T bits 0x0 Sync break length is 13T bits (default)
3:1	reserved	RO	0x0	Software should not rely on the value of a reserved bit. To provide compatibility with future products, the value of a reserved bit should be preserved across a read-modify-write operation.
0	MASTER	R/W	0	LIN Master Enable  Value Description 1 The UART operates as a LIN master. 0 The UART operates as a LIN slave.

### Register 16: UART LIN Snap Shot (UARTLSS), offset 0x094

The **UARTLSS** register captures the free-running timer value when either the Sync Edge 1 or the Sync Edge 5 is detected in LIN mode.

#### UART LIN Snap Shot (UARTLSS)

UART0 base: 0x4000.C000  
 UART1 base: 0x4000.D000  
 UART2 base: 0x4000.E000  
 Offset 0x094  
 Type RO, reset 0x0000.0000



Bit/Field	Name	Type	Reset	Description
31:16	reserved	RO	0x0000	Software should not rely on the value of a reserved bit. To provide compatibility with future products, the value of a reserved bit should be preserved across a read-modify-write operation.
15:0	TSS	RO	0x0000	Timer Snap Shot  This field contains the value of the free-running timer when either the Sync Edge 5 or the Sync Edge 1 was detected.



## Register 17: UART LIN Timer (UARTLTIM), offset 0x098

The **UARTLTIM** register contains the current timer value for the free-running timer that is used to calculate the baud rate when in LIN slave mode. The value in this register is used along with the value in the **UART LIN Snap Shot (UARTLSS)** register to adjust the baud rate to match that of the master.

### UART LIN Timer (UARTLTIM)

UART0 base: 0x4000.C000

UART1 base: 0x4000.D000

UART2 base: 0x4000.E000

Offset 0x098

Type RO, reset 0x0000.0000

	31	30	29	28	27	26	25	24	23	22	21	20	19	18	17	16
	reserved															
Type	RO	RO	RO	RO	RO	RO	RO	RO	RO	RO	RO	RO	RO	RO	RO	RO
Reset	0	0	0	0	0	0	0	0	0	0	0	0	0	0	0	0
	15	14	13	12	11	10	9	8	7	6	5	4	3	2	1	0
	TIMER															
Type	RO	RO	RO	RO	RO	RO	RO	RO	RO	RO	RO	RO	RO	RO	RO	RO
Reset	0	0	0	0	0	0	0	0	0	0	0	0	0	0	0	0

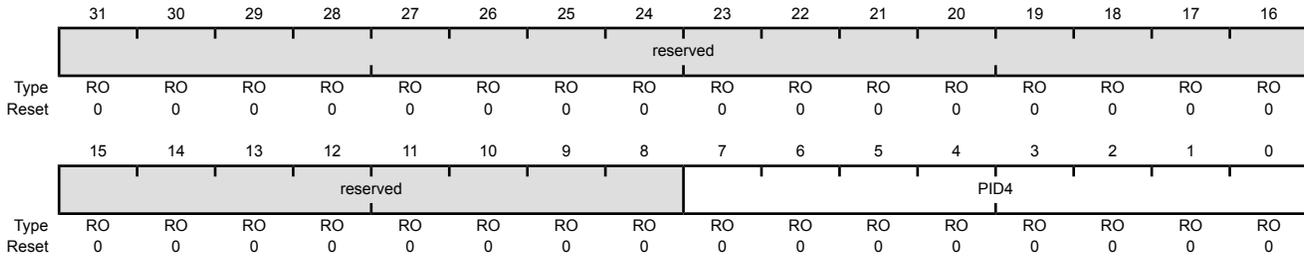
Bit/Field	Name	Type	Reset	Description
31:16	reserved	RO	0x0000	Software should not rely on the value of a reserved bit. To provide compatibility with future products, the value of a reserved bit should be preserved across a read-modify-write operation.
15:0	TIMER	RO	0x0000	Timer Value This field contains the value of the free-running timer.

### Register 18: UART Peripheral Identification 4 (UARTPeriphID4), offset 0xFD0

The **UARTPeriphIDn** registers are hard-coded and the fields within the registers determine the reset values.

#### UART Peripheral Identification 4 (UARTPeriphID4)

UART0 base: 0x4000.C000  
 UART1 base: 0x4000.D000  
 UART2 base: 0x4000.E000  
 Offset 0xFD0  
 Type RO, reset 0x0000.0000



Bit/Field	Name	Type	Reset	Description
31:8	reserved	RO	0x0000.00	Software should not rely on the value of a reserved bit. To provide compatibility with future products, the value of a reserved bit should be preserved across a read-modify-write operation.
7:0	PID4	RO	0x00	UART Peripheral ID Register [7:0]  Can be used by software to identify the presence of this peripheral.

**Register 19: UART Peripheral Identification 5 (UARTPeriphID5), offset 0xFD4**

The **UARTPeriphIDn** registers are hard-coded and the fields within the registers determine the reset values.

## UART Peripheral Identification 5 (UARTPeriphID5)

UART0 base: 0x4000.C000

UART1 base: 0x4000.D000

UART2 base: 0x4000.E000

Offset 0xFD4

Type RO, reset 0x0000.0000

	31	30	29	28	27	26	25	24	23	22	21	20	19	18	17	16
	reserved															
Type	RO	RO	RO	RO	RO	RO	RO	RO	RO	RO	RO	RO	RO	RO	RO	RO
Reset	0	0	0	0	0	0	0	0	0	0	0	0	0	0	0	0
	15	14	13	12	11	10	9	8	7	6	5	4	3	2	1	0
	reserved								PID5							
Type	RO	RO	RO	RO	RO	RO	RO	RO	RO	RO	RO	RO	RO	RO	RO	RO
Reset	0	0	0	0	0	0	0	0	0	0	0	0	0	0	0	0

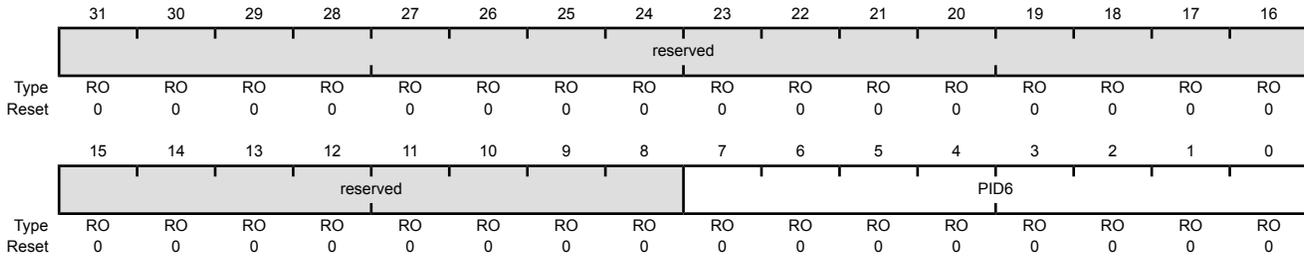
Bit/Field	Name	Type	Reset	Description
31:8	reserved	RO	0x0000.00	Software should not rely on the value of a reserved bit. To provide compatibility with future products, the value of a reserved bit should be preserved across a read-modify-write operation.
7:0	PID5	RO	0x00	UART Peripheral ID Register [15:8] Can be used by software to identify the presence of this peripheral.

## Register 20: UART Peripheral Identification 6 (UARTPeriphID6), offset 0xFD8

The **UARTPeriphIDn** registers are hard-coded and the fields within the registers determine the reset values.

### UART Peripheral Identification 6 (UARTPeriphID6)

UART0 base: 0x4000.C000  
 UART1 base: 0x4000.D000  
 UART2 base: 0x4000.E000  
 Offset 0xFD8  
 Type RO, reset 0x0000.0000



Bit/Field	Name	Type	Reset	Description
31:8	reserved	RO	0x0000.00	Software should not rely on the value of a reserved bit. To provide compatibility with future products, the value of a reserved bit should be preserved across a read-modify-write operation.
7:0	PID6	RO	0x00	UART Peripheral ID Register [23:16]  Can be used by software to identify the presence of this peripheral.

**Register 21: UART Peripheral Identification 7 (UARTPeriphID7), offset 0xFDC**

The **UARTPeriphIDn** registers are hard-coded and the fields within the registers determine the reset values.

## UART Peripheral Identification 7 (UARTPeriphID7)

UART0 base: 0x4000.C000

UART1 base: 0x4000.D000

UART2 base: 0x4000.E000

Offset 0xFDC

Type RO, reset 0x0000.0000

	31	30	29	28	27	26	25	24	23	22	21	20	19	18	17	16
	reserved															
Type	RO	RO	RO	RO	RO	RO	RO	RO	RO	RO	RO	RO	RO	RO	RO	RO
Reset	0	0	0	0	0	0	0	0	0	0	0	0	0	0	0	0
	15	14	13	12	11	10	9	8	7	6	5	4	3	2	1	0
	reserved								PID7							
Type	RO	RO	RO	RO	RO	RO	RO	RO	RO	RO	RO	RO	RO	RO	RO	RO
Reset	0	0	0	0	0	0	0	0	0	0	0	0	0	0	0	0

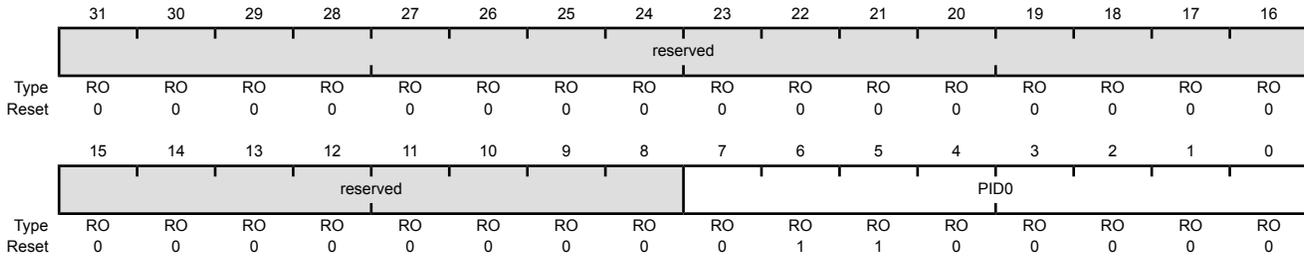
Bit/Field	Name	Type	Reset	Description
31:8	reserved	RO	0x0000.00	Software should not rely on the value of a reserved bit. To provide compatibility with future products, the value of a reserved bit should be preserved across a read-modify-write operation.
7:0	PID7	RO	0x00	UART Peripheral ID Register [31:24] Can be used by software to identify the presence of this peripheral.

## Register 22: UART Peripheral Identification 0 (UARTPeriphID0), offset 0xFE0

The **UARTPeriphIDn** registers are hard-coded and the fields within the registers determine the reset values.

### UART Peripheral Identification 0 (UARTPeriphID0)

UART0 base: 0x4000.C000  
 UART1 base: 0x4000.D000  
 UART2 base: 0x4000.E000  
 Offset 0xFE0  
 Type RO, reset 0x0000.0060



Bit/Field	Name	Type	Reset	Description
31:8	reserved	RO	0x0000.00	Software should not rely on the value of a reserved bit. To provide compatibility with future products, the value of a reserved bit should be preserved across a read-modify-write operation.
7:0	PID0	RO	0x60	UART Peripheral ID Register [7:0]  Can be used by software to identify the presence of this peripheral.

**Register 23: UART Peripheral Identification 1 (UARTPeriphID1), offset 0xFE4**

The **UARTPeriphIDn** registers are hard-coded and the fields within the registers determine the reset values.

## UART Peripheral Identification 1 (UARTPeriphID1)

UART0 base: 0x4000.C000

UART1 base: 0x4000.D000

UART2 base: 0x4000.E000

Offset 0xFE4

Type RO, reset 0x0000.0000

	31	30	29	28	27	26	25	24	23	22	21	20	19	18	17	16
	reserved															
Type	RO	RO	RO	RO	RO	RO	RO	RO	RO	RO	RO	RO	RO	RO	RO	RO
Reset	0	0	0	0	0	0	0	0	0	0	0	0	0	0	0	0
	15	14	13	12	11	10	9	8	7	6	5	4	3	2	1	0
	reserved								PID1							
Type	RO	RO	RO	RO	RO	RO	RO	RO	RO	RO	RO	RO	RO	RO	RO	RO
Reset	0	0	0	0	0	0	0	0	0	0	0	0	0	0	0	0

Bit/Field	Name	Type	Reset	Description
31:8	reserved	RO	0x0000.00	Software should not rely on the value of a reserved bit. To provide compatibility with future products, the value of a reserved bit should be preserved across a read-modify-write operation.
7:0	PID1	RO	0x00	UART Peripheral ID Register [15:8] Can be used by software to identify the presence of this peripheral.

## Register 24: UART Peripheral Identification 2 (UARTPeriphID2), offset 0xFE8

The **UARTPeriphIDn** registers are hard-coded and the fields within the registers determine the reset values.

### UART Peripheral Identification 2 (UARTPeriphID2)

UART0 base: 0x4000.C000  
 UART1 base: 0x4000.D000  
 UART2 base: 0x4000.E000  
 Offset 0xFE8  
 Type RO, reset 0x0000.0018

	31	30	29	28	27	26	25	24	23	22	21	20	19	18	17	16
	reserved															
Type	RO	RO	RO	RO	RO	RO	RO	RO	RO	RO	RO	RO	RO	RO	RO	RO
Reset	0	0	0	0	0	0	0	0	0	0	0	0	0	0	0	0
	15	14	13	12	11	10	9	8	7	6	5	4	3	2	1	0
	reserved								PID2							
Type	RO	RO	RO	RO	RO	RO	RO	RO	RO	RO	RO	RO	RO	RO	RO	RO
Reset	0	0	0	0	0	0	0	0	0	0	0	1	1	0	0	0

Bit/Field	Name	Type	Reset	Description
31:8	reserved	RO	0x0000.00	Software should not rely on the value of a reserved bit. To provide compatibility with future products, the value of a reserved bit should be preserved across a read-modify-write operation.
7:0	PID2	RO	0x18	UART Peripheral ID Register [23:16]  Can be used by software to identify the presence of this peripheral.



**Register 25: UART Peripheral Identification 3 (UARTPeriphID3), offset 0xFEC**

The **UARTPeriphIDn** registers are hard-coded and the fields within the registers determine the reset values.

## UART Peripheral Identification 3 (UARTPeriphID3)

UART0 base: 0x4000.C000

UART1 base: 0x4000.D000

UART2 base: 0x4000.E000

Offset 0xFEC

Type RO, reset 0x0000.0001

	31	30	29	28	27	26	25	24	23	22	21	20	19	18	17	16
	reserved															
Type	RO	RO	RO	RO	RO	RO	RO	RO	RO	RO	RO	RO	RO	RO	RO	RO
Reset	0	0	0	0	0	0	0	0	0	0	0	0	0	0	0	0
	15	14	13	12	11	10	9	8	7	6	5	4	3	2	1	0
	reserved								PID3							
Type	RO	RO	RO	RO	RO	RO	RO	RO	RO	RO	RO	RO	RO	RO	RO	RO
Reset	0	0	0	0	0	0	0	0	0	0	0	0	0	0	0	1

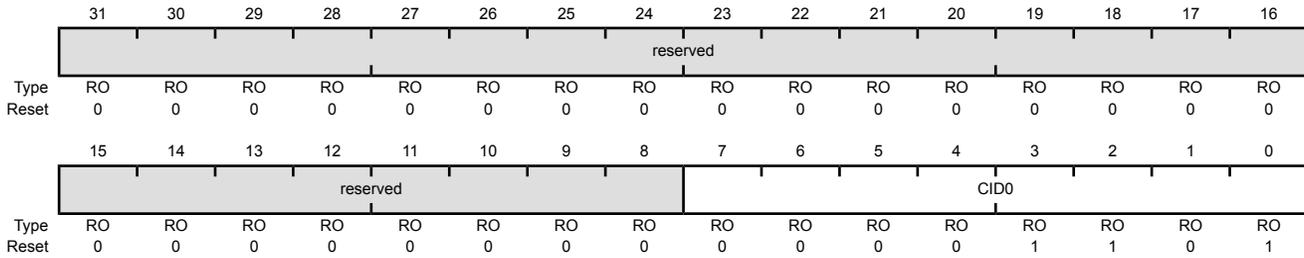
Bit/Field	Name	Type	Reset	Description
31:8	reserved	RO	0x0000.00	Software should not rely on the value of a reserved bit. To provide compatibility with future products, the value of a reserved bit should be preserved across a read-modify-write operation.
7:0	PID3	RO	0x01	UART Peripheral ID Register [31:24] Can be used by software to identify the presence of this peripheral.

### Register 26: UART PrimeCell Identification 0 (UARTPCellID0), offset 0xFF0

The **UARTPCellIDn** registers are hard-coded and the fields within the registers determine the reset values.

#### UART PrimeCell Identification 0 (UARTPCellID0)

UART0 base: 0x4000.C000  
 UART1 base: 0x4000.D000  
 UART2 base: 0x4000.E000  
 Offset 0xFF0  
 Type RO, reset 0x0000.000D



Bit/Field	Name	Type	Reset	Description
31:8	reserved	RO	0x0000.00	Software should not rely on the value of a reserved bit. To provide compatibility with future products, the value of a reserved bit should be preserved across a read-modify-write operation.
7:0	CID0	RO	0x0D	UART PrimeCell ID Register [7:0] Provides software a standard cross-peripheral identification system.

**Register 27: UART PrimeCell Identification 1 (UARTPCellID1), offset 0xFF4**

The **UARTPCellIDn** registers are hard-coded and the fields within the registers determine the reset values.

## UART PrimeCell Identification 1 (UARTPCellID1)

UART0 base: 0x4000.C000

UART1 base: 0x4000.D000

UART2 base: 0x4000.E000

Offset 0xFF4

Type RO, reset 0x0000.00F0

	31	30	29	28	27	26	25	24	23	22	21	20	19	18	17	16
	reserved															
Type	RO	RO	RO	RO	RO	RO	RO	RO	RO	RO	RO	RO	RO	RO	RO	RO
Reset	0	0	0	0	0	0	0	0	0	0	0	0	0	0	0	0
	15	14	13	12	11	10	9	8	7	6	5	4	3	2	1	0
	reserved								CID1							
Type	RO	RO	RO	RO	RO	RO	RO	RO	RO	RO	RO	RO	RO	RO	RO	RO
Reset	0	0	0	0	0	0	0	0	1	1	1	1	0	0	0	0

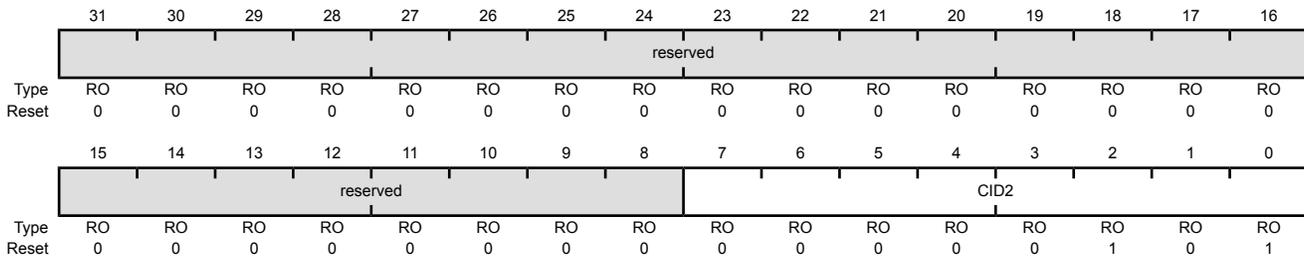
Bit/Field	Name	Type	Reset	Description
31:8	reserved	RO	0x0000.00	Software should not rely on the value of a reserved bit. To provide compatibility with future products, the value of a reserved bit should be preserved across a read-modify-write operation.
7:0	CID1	RO	0xF0	UART PrimeCell ID Register [15:8] Provides software a standard cross-peripheral identification system.

### Register 28: UART PrimeCell Identification 2 (UARTPCelIID2), offset 0xFF8

The **UARTPCelIIDn** registers are hard-coded and the fields within the registers determine the reset values.

#### UART PrimeCell Identification 2 (UARTPCelIID2)

UART0 base: 0x4000.C000  
 UART1 base: 0x4000.D000  
 UART2 base: 0x4000.E000  
 Offset 0xFF8  
 Type RO, reset 0x0000.0005



Bit/Field	Name	Type	Reset	Description
31:8	reserved	RO	0x0000.00	Software should not rely on the value of a reserved bit. To provide compatibility with future products, the value of a reserved bit should be preserved across a read-modify-write operation.
7:0	CID2	RO	0x05	UART PrimeCell ID Register [23:16] Provides software a standard cross-peripheral identification system.

**Register 29: UART PrimeCell Identification 3 (UARTPCelIID3), offset 0xFFC**

The **UARTPCelIIDn** registers are hard-coded and the fields within the registers determine the reset values.

## UART PrimeCell Identification 3 (UARTPCelIID3)

UART0 base: 0x4000.C000

UART1 base: 0x4000.D000

UART2 base: 0x4000.E000

Offset 0xFFC

Type RO, reset 0x0000.00B1

	31	30	29	28	27	26	25	24	23	22	21	20	19	18	17	16
	reserved															
Type	RO	RO	RO	RO	RO	RO	RO	RO	RO	RO	RO	RO	RO	RO	RO	RO
Reset	0	0	0	0	0	0	0	0	0	0	0	0	0	0	0	0
	15	14	13	12	11	10	9	8	7	6	5	4	3	2	1	0
	reserved								CID3							
Type	RO	RO	RO	RO	RO	RO	RO	RO	RO	RO	RO	RO	RO	RO	RO	RO
Reset	0	0	0	0	0	0	0	0	1	0	1	1	0	0	0	1

Bit/Field	Name	Type	Reset	Description
31:8	reserved	RO	0x0000.00	Software should not rely on the value of a reserved bit. To provide compatibility with future products, the value of a reserved bit should be preserved across a read-modify-write operation.
7:0	CID3	RO	0xB1	UART PrimeCell ID Register [31:24] Provides software a standard cross-peripheral identification system.

## 15 Synchronous Serial Interface (SSI)

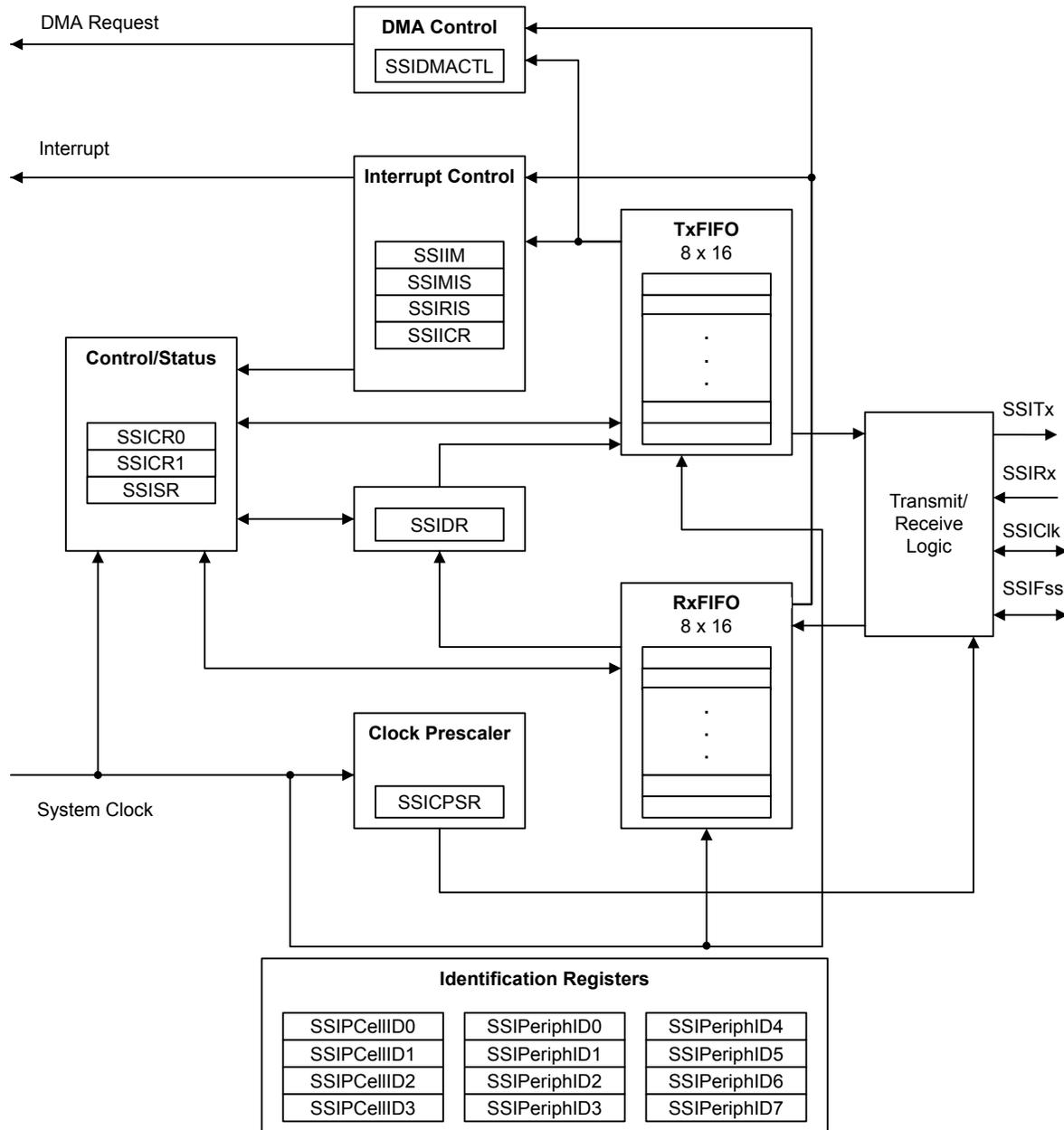
The Stellaris<sup>®</sup> microcontroller includes two Synchronous Serial Interface (SSI) modules. Each SSI is a master or slave interface for synchronous serial communication with peripheral devices that have either Freescale SPI, MICROWIRE, or Texas Instruments synchronous serial interfaces.

The Stellaris<sup>®</sup> LM3S9B96 controller includes two SSI modules with the following features:

- Programmable interface operation for Freescale SPI, MICROWIRE, or Texas Instruments synchronous serial interfaces
- Master or slave operation
- Programmable clock bit rate and prescaler
- Separate transmit and receive FIFOs, each 16 bits wide and 8 locations deep
- Programmable data frame size from 4 to 16 bits
- Internal loopback test mode for diagnostic/debug testing
- Standard FIFO-based interrupts and End-of-Transmission interrupt
- Efficient transfers using Micro Direct Memory Access Controller ( $\mu$ DMA)
  - Separate channels for transmit and receive
  - Receive single request asserted when data is in the FIFO; burst request asserted when FIFO contains 4 entries
  - Transmit single request asserted when there is space in the FIFO; burst request asserted when FIFO contains 4 entries

## 15.1 Block Diagram

Figure 15-1. SSI Module Block Diagram



## 15.2 Signal Description

Table 15-1 on page 648 and Table 15-2 on page 648 list the external signals of the SSI module and describe the function of each. The SSI signals are alternate functions for some GPIO signals and default to be GPIO signals at reset., with the exception of the `SSI0Clk`, `SSI0Fss`, `SSI0Rx`, and `SSI0Tx` pins which default to the SSI function. The column in the table below titled "Pin Mux/Pin Assignment" lists the possible GPIO pin placements for the SSI signals. The `AFSEL` bit in the **GPIO Alternate Function Select (GPIOAFSEL)** register (page 328) should be set to choose the SSI

function. The number in parentheses is the encoding that must be programmed into the  $PMC_n$  field in the **GPIO Port Control (GPIOCTL)** register (page 346) to assign the SSI signal to the specified GPIO port pin. For more information on configuring GPIOs, see “General-Purpose Input/Outputs (GPIOs)” on page 304.

**Table 15-1. Signals for SSI (100LQFP)**

Pin Name	Pin Number	Pin Mux / Pin Assignment	Pin Type	Buffer Type <sup>a</sup>	Description
SSI0Clk	28	PA2 (1)	I/O	TTL	SSI module 0 clock.
SSI0Fss	29	PA3 (1)	I/O	TTL	SSI module 0 frame.
SSI0Rx	30	PA4 (1)	I	TTL	SSI module 0 receive.
SSI0Tx	31	PA5 (1)	O	TTL	SSI module 0 transmit.
SSI1Clk	60 74 76	PF2 (9) PE0 (2) PH4 (11)	I/O	TTL	SSI module 1 clock.
SSI1Fss	59 63 75	PF3 (9) PH5 (11) PE1 (2)	I/O	TTL	SSI module 1 frame.
SSI1Rx	42 62 95	PF4 (9) PH6 (11) PE2 (2)	I	TTL	SSI module 1 receive.
SSI1Tx	15 41 96	PH7 (11) PF5 (9) PE3 (2)	O	TTL	SSI module 1 transmit.

a. The TTL designation indicates the pin has TTL-compatible voltage levels.

**Table 15-2. Signals for SSI (108BGA)**

Pin Name	Pin Number	Pin Mux / Pin Assignment	Pin Type	Buffer Type <sup>a</sup>	Description
SSI0Clk	M4	PA2 (1)	I/O	TTL	SSI module 0 clock.
SSI0Fss	L4	PA3 (1)	I/O	TTL	SSI module 0 frame.
SSI0Rx	L5	PA4 (1)	I	TTL	SSI module 0 receive.
SSI0Tx	M5	PA5 (1)	O	TTL	SSI module 0 transmit.
SSI1Clk	J11 B11 B10	PF2 (9) PE0 (2) PH4 (11)	I/O	TTL	SSI module 1 clock.
SSI1Fss	J12 F10 A12	PF3 (9) PH5 (11) PE1 (2)	I/O	TTL	SSI module 1 frame.
SSI1Rx	K4 G3 A4	PF4 (9) PH6 (11) PE2 (2)	I	TTL	SSI module 1 receive.
SSI1Tx	H3 K3 B4	PH7 (11) PF5 (9) PE3 (2)	O	TTL	SSI module 1 transmit.

a. The TTL designation indicates the pin has TTL-compatible voltage levels.

## 15.3 Functional Description

The SSI performs serial-to-parallel conversion on data received from a peripheral device. The CPU accesses data, control, and status information. The transmit and receive paths are buffered with



internal FIFO memories allowing up to eight 16-bit values to be stored independently in both transmit and receive modes. The SSI also supports the  $\mu$ DMA interface. The transmit and receive FIFOs can be programmed as destination/source addresses in the  $\mu$ DMA module.  $\mu$ DMA operation is enabled by setting the appropriate bit(s) in the **SSIDMACTL** register (see page 675).

### 15.3.1 Bit Rate Generation

The SSI includes a programmable bit rate clock divider and prescaler to generate the serial output clock. Bit rates are supported to 2 MHz and higher, although maximum bit rate is determined by peripheral devices.

The serial bit rate is derived by dividing down the input clock (SysClk). The clock is first divided by an even prescale value **CPSDVSR** from 2 to 254, which is programmed in the **SSI Clock Prescale (SSICPSR)** register (see page 668). The clock is further divided by a value from 1 to 256, which is  $1 + \text{SCR}$ , where **SCR** is the value programmed in the **SSI Control 0 (SSICR0)** register (see page 661).

The frequency of the output clock **SSIClk** is defined by:

$$\text{SSIClk} = \text{SysClk} / (\text{CPSDVSR} * (1 + \text{SCR}))$$

**Note:** For master mode, the system clock must be at least two times faster than the **SSIClk**. For slave mode, the system clock must be at least 12 times faster than the **SSIClk**.

See “Synchronous Serial Interface (SSI)” on page 1219 to view SSI timing parameters.

### 15.3.2 FIFO Operation

#### 15.3.2.1 Transmit FIFO

The common transmit FIFO is a 16-bit wide, 8-locations deep, first-in, first-out memory buffer. The CPU writes data to the FIFO by writing the **SSI Data (SSIDR)** register (see page 665), and data is stored in the FIFO until it is read out by the transmission logic.

When configured as a master or a slave, parallel data is written into the transmit FIFO prior to serial conversion and transmission to the attached slave or master, respectively, through the **SSITx** pin.

In slave mode, the SSI transmits data each time the master initiates a transaction. If the transmit FIFO is empty and the master initiates, the slave transmits the 8th most recent value in the transmit FIFO. If less than 8 values have been written to the transmit FIFO since the SSI module clock was enabled using the **SSI** bit in the **RGCG1** register, then 0 is transmitted. Care should be taken to ensure that valid data is in the FIFO as needed. The SSI can be configured to generate an interrupt or a  $\mu$ DMA request when the FIFO is empty.

#### 15.3.2.2 Receive FIFO

The common receive FIFO is a 16-bit wide, 8-locations deep, first-in, first-out memory buffer. Received data from the serial interface is stored in the buffer until read out by the CPU, which accesses the read FIFO by reading the **SSIDR** register.

When configured as a master or slave, serial data received through the **SSIRx** pin is registered prior to parallel loading into the attached slave or master receive FIFO, respectively.

### 15.3.3 Interrupts

The SSI can generate interrupts when the following conditions are observed:

- Transmit FIFO service (when the transmit FIFO is half full or less)
- Receive FIFO service (when the receive FIFO is half full or more)

- Receive FIFO time-out
- Receive FIFO overrun
- End of transmission

All of the interrupt events are ORed together before being sent to the interrupt controller, so the SSI generates a single interrupt request to the controller regardless of the number of active interrupts. Each of the four individual maskable interrupts can be masked by clearing the appropriate bit in the **SSI Interrupt Mask (SSIIM)** register (see page 669). Setting the appropriate mask bit enables the interrupt.

The individual outputs, along with a combined interrupt output, allow use of either a global interrupt service routine or modular device drivers to handle interrupts. The transmit and receive dynamic dataflow interrupts have been separated from the status interrupts so that data can be read or written in response to the FIFO trigger levels. The status of the individual interrupt sources can be read from the **SSI Raw Interrupt Status (SSIRIS)** and **SSI Masked Interrupt Status (SSIMIS)** registers (see page 670 and page 672, respectively).

The receive FIFO has a time-out period that is 32 periods at the rate of `SSIClk` (whether or not `SSIClk` is currently active) and is started when the RX FIFO goes from EMPTY to not-EMPTY. If the RX FIFO is emptied before 32 clocks have passed, the time-out period is reset. As a result, the ISR should clear the Receive FIFO Time-out Interrupt just after reading out the RX FIFO by writing a 1 to the `RTIC` bit in the **SSI Interrupt Clear (SSIICR)** register. The interrupt should not be cleared so late that the ISR returns before the interrupt is actually cleared, or the ISR may be re-activated unnecessarily.

The End-of-Transmission (EOT) interrupt indicates that the data has been transmitted completely. This interrupt can be used to indicate when it is safe to turn off the SSI module clock or enter sleep mode. In addition, because transmitted data and received data complete at exactly the same time, the interrupt can also indicate that read data is ready immediately, without waiting for the receive FIFO time-out period to complete.

### 15.3.4 Frame Formats

Each data frame is between 4 and 16 bits long, depending on the size of data programmed, and is transmitted starting with the MSB. There are three basic frame types that can be selected:

- Texas Instruments synchronous serial
- Freescale SPI
- MICROWIRE

For all three formats, the serial clock (`SSIClk`) is held inactive while the SSI is idle, and `SSIClk` transitions at the programmed frequency only during active transmission or reception of data. The idle state of `SSIClk` is utilized to provide a receive timeout indication that occurs when the receive FIFO still contains data after a timeout period.

For Freescale SPI and MICROWIRE frame formats, the serial frame (`SSIFSS`) pin is active Low, and is asserted (pulled down) during the entire transmission of the frame.

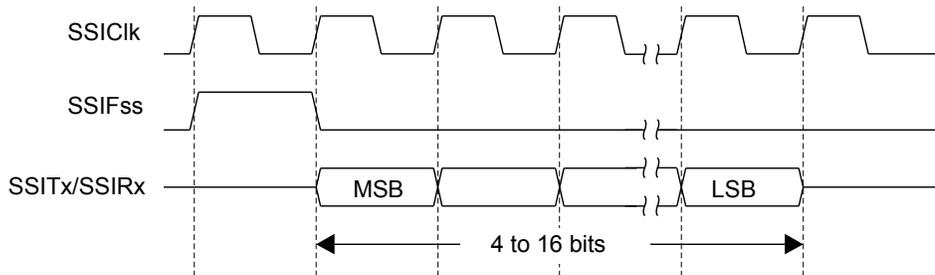
For Texas Instruments synchronous serial frame format, the `SSIFSS` pin is pulsed for one serial clock period starting at its rising edge, prior to the transmission of each frame. For this frame format, both the SSI and the off-chip slave device drive their output data on the rising edge of `SSIClk` and latch data from the other device on the falling edge.

Unlike the full-duplex transmission of the other two frame formats, the MICROWIRE format uses a special master-slave messaging technique which operates at half-duplex. In this mode, when a frame begins, an 8-bit control message is transmitted to the off-chip slave. During this transmit, no incoming data is received by the SSI. After the message has been sent, the off-chip slave decodes it and, after waiting one serial clock after the last bit of the 8-bit control message has been sent, responds with the requested data. The returned data can be 4 to 16 bits in length, making the total frame length anywhere from 13 to 25 bits.

#### 15.3.4.1 Texas Instruments Synchronous Serial Frame Format

Figure 15-2 on page 651 shows the Texas Instruments synchronous serial frame format for a single transmitted frame.

**Figure 15-2. TI Synchronous Serial Frame Format (Single Transfer)**

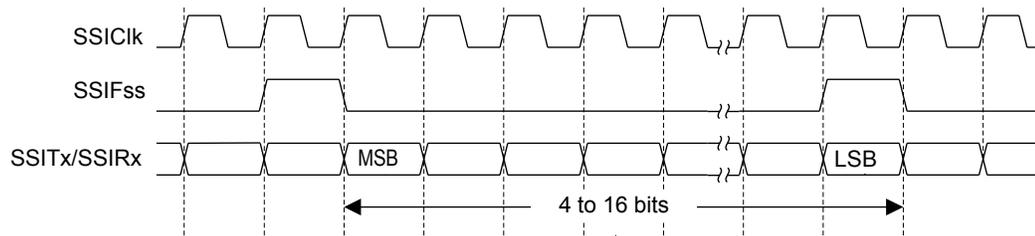


In this mode,  $SSIClk$  and  $SSIFss$  are forced Low, and the transmit data line  $SSITx$  is tristated whenever the SSI is idle. Once the bottom entry of the transmit FIFO contains data,  $SSIFss$  is pulsed High for one  $SSIClk$  period. The value to be transmitted is also transferred from the transmit FIFO to the serial shift register of the transmit logic. On the next rising edge of  $SSIClk$ , the MSB of the 4 to 16-bit data frame is shifted out on the  $SSITx$  pin. Likewise, the MSB of the received data is shifted onto the  $SSIRx$  pin by the off-chip serial slave device.

Both the SSI and the off-chip serial slave device then clock each data bit into their serial shifter on each falling edge of  $SSIClk$ . The received data is transferred from the serial shifter to the receive FIFO on the first rising edge of  $SSIClk$  after the LSB has been latched.

Figure 15-3 on page 651 shows the Texas Instruments synchronous serial frame format when back-to-back frames are transmitted.

**Figure 15-3. TI Synchronous Serial Frame Format (Continuous Transfer)**



### 15.3.4.2 Freescale SPI Frame Format

The Freescale SPI interface is a four-wire interface where the `SSIFss` signal behaves as a slave select. The main feature of the Freescale SPI format is that the inactive state and phase of the `SSIClk` signal are programmable through the `SPO` and `SPH` bits in the `SSISCR0` control register.

#### **SPO Clock Polarity Bit**

When the `SPO` clock polarity control bit is clear, it produces a steady state Low value on the `SSIClk` pin. If the `SPO` bit is set, a steady state High value is placed on the `SSIClk` pin when data is not being transferred.

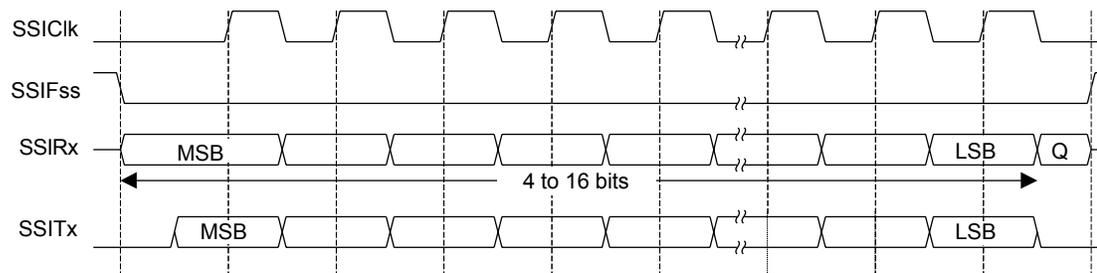
#### **SPH Phase Control Bit**

The `SPH` phase control bit selects the clock edge that captures data and allows it to change state. The state of this bit has the most impact on the first bit transmitted by either allowing or not allowing a clock transition before the first data capture edge. When the `SPH` phase control bit is clear, data is captured on the first clock edge transition. If the `SPH` bit is set, data is captured on the second clock edge transition.

### 15.3.4.3 Freescale SPI Frame Format with `SPO=0` and `SPH=0`

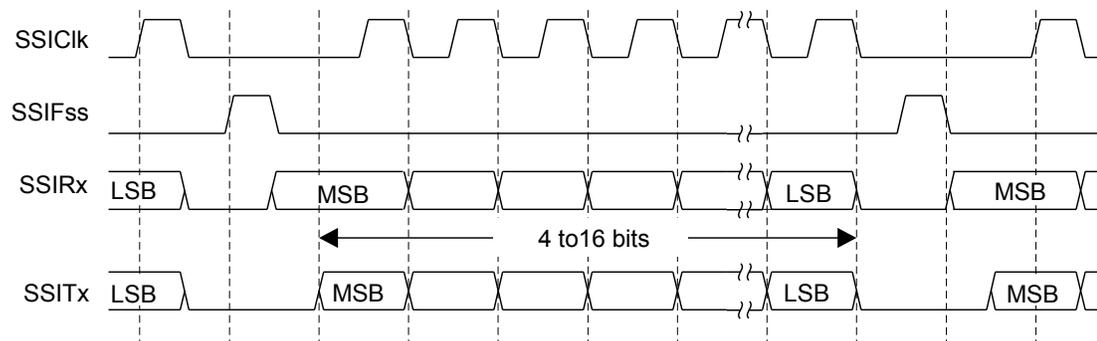
Single and continuous transmission signal sequences for Freescale SPI format with `SPO=0` and `SPH=0` are shown in Figure 15-4 on page 652 and Figure 15-5 on page 652.

**Figure 15-4. Freescale SPI Format (Single Transfer) with `SPO=0` and `SPH=0`**



**Note:** Q is undefined.

**Figure 15-5. Freescale SPI Format (Continuous Transfer) with `SPO=0` and `SPH=0`**



In this configuration, during idle periods:

- `SSIClk` is forced Low

- SSIF<sub>SS</sub> is forced High
- The transmit data line SSIT<sub>x</sub> is arbitrarily forced Low
- When the SSI is configured as a master, it enables the SSIClk pad
- When the SSI is configured as a slave, it disables the SSIClk pad

If the SSI is enabled and valid data is in the transmit FIFO, the start of transmission is signified by the SSIF<sub>SS</sub> master signal being driven Low, causing slave data to be enabled onto the SSIR<sub>x</sub> input line of the master. The master SSIT<sub>x</sub> output pad is enabled.

One half SSIClk period later, valid master data is transferred to the SSIT<sub>x</sub> pin. Once both the master and slave data have been set, the SSIClk master clock pin goes High after one additional half SSIClk period.

The data is now captured on the rising and propagated on the falling edges of the SSIClk signal.

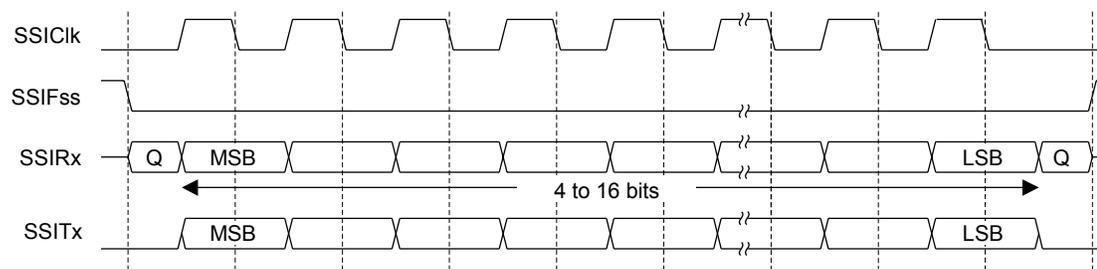
In the case of a single word transmission, after all bits of the data word have been transferred, the SSIF<sub>SS</sub> line is returned to its idle High state one SSIClk period after the last bit has been captured.

However, in the case of continuous back-to-back transmissions, the SSIF<sub>SS</sub> signal must be pulsed High between each data word transfer because the slave select pin freezes the data in its serial peripheral register and does not allow it to be altered if the SPH bit is clear. Therefore, the master device must raise the SSIF<sub>SS</sub> pin of the slave device between each data transfer to enable the serial peripheral data write. On completion of the continuous transfer, the SSIF<sub>SS</sub> pin is returned to its idle state one SSIClk period after the last bit has been captured.

#### 15.3.4.4 Freescale SPI Frame Format with SPO=0 and SPH=1

The transfer signal sequence for Freescale SPI format with SPO=0 and SPH=1 is shown in Figure 15-6 on page 653, which covers both single and continuous transfers.

**Figure 15-6. Freescale SPI Frame Format with SPO=0 and SPH=1**



**Note:** Q is undefined.

In this configuration, during idle periods:

- SSIClk is forced Low
- SSIF<sub>SS</sub> is forced High
- The transmit data line SSIT<sub>x</sub> is arbitrarily forced Low
- When the SSI is configured as a master, it enables the SSIClk pad

- When the SSI is configured as a slave, it disables the `SSIClk` pad

If the SSI is enabled and valid data is in the transmit FIFO, the start of transmission is signified by the `SSIFss` master signal being driven Low. The master `SSITx` output is enabled. After an additional one-half `SSIClk` period, both master and slave valid data are enabled onto their respective transmission lines. At the same time, the `SSIClk` is enabled with a rising edge transition.

Data is then captured on the falling edges and propagated on the rising edges of the `SSIClk` signal.

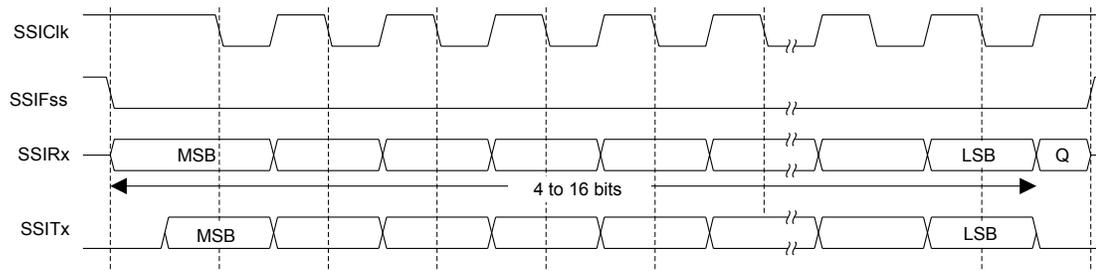
In the case of a single word transfer, after all bits have been transferred, the `SSIFss` line is returned to its idle High state one `SSIClk` period after the last bit has been captured.

For continuous back-to-back transfers, the `SSIFss` pin is held Low between successive data words, and termination is the same as that of the single word transfer.

#### 15.3.4.5 Freescale SPI Frame Format with `SPO=1` and `SPH=0`

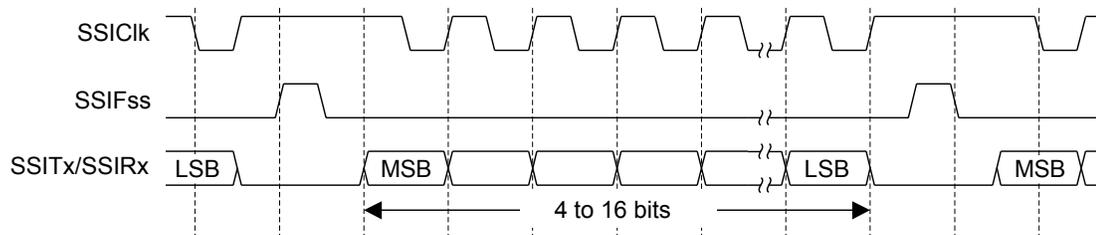
Single and continuous transmission signal sequences for Freescale SPI format with `SPO=1` and `SPH=0` are shown in Figure 15-7 on page 654 and Figure 15-8 on page 654.

**Figure 15-7. Freescale SPI Frame Format (Single Transfer) with `SPO=1` and `SPH=0`**



**Note:** Q is undefined.

**Figure 15-8. Freescale SPI Frame Format (Continuous Transfer) with `SPO=1` and `SPH=0`**



In this configuration, during idle periods:

- `SSIClk` is forced High
- `SSIFss` is forced High
- The transmit data line `SSITx` is arbitrarily forced Low
- When the SSI is configured as a master, it enables the `SSIClk` pad
- When the SSI is configured as a slave, it disables the `SSIClk` pad

If the SSI is enabled and valid data is in the transmit FIFO, the start of transmission is signified by the `SSIFSS` master signal being driven Low, causing slave data to be immediately transferred onto the `SSIRx` line of the master. The master `SSITx` output pad is enabled.

One-half period later, valid master data is transferred to the `SSITx` line. Once both the master and slave data have been set, the `SSIClk` master clock pin becomes Low after one additional half `SSIClk` period, meaning that data is captured on the falling edges and propagated on the rising edges of the `SSIClk` signal.

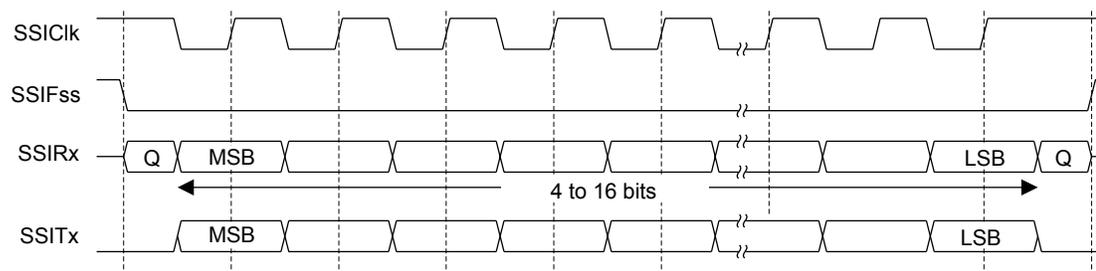
In the case of a single word transmission, after all bits of the data word are transferred, the `SSIFSS` line is returned to its idle High state one `SSIClk` period after the last bit has been captured.

However, in the case of continuous back-to-back transmissions, the `SSIFSS` signal must be pulsed High between each data word transfer because the slave select pin freezes the data in its serial peripheral register and does not allow it to be altered if the `SPH` bit is clear. Therefore, the master device must raise the `SSIFSS` pin of the slave device between each data transfer to enable the serial peripheral data write. On completion of the continuous transfer, the `SSIFSS` pin is returned to its idle state one `SSIClk` period after the last bit has been captured.

#### 15.3.4.6 Freescale SPI Frame Format with `SPO=1` and `SPH=1`

The transfer signal sequence for Freescale SPI format with `SPO=1` and `SPH=1` is shown in Figure 15-9 on page 655, which covers both single and continuous transfers.

**Figure 15-9. Freescale SPI Frame Format with `SPO=1` and `SPH=1`**



**Note:** Q is undefined.

In this configuration, during idle periods:

- `SSIClk` is forced High
- `SSIFSS` is forced High
- The transmit data line `SSITx` is arbitrarily forced Low
- When the SSI is configured as a master, it enables the `SSIClk` pad
- When the SSI is configured as a slave, it disables the `SSIClk` pad

If the SSI is enabled and valid data is in the transmit FIFO, the start of transmission is signified by the `SSIFSS` master signal being driven Low. The master `SSITx` output pad is enabled. After an additional one-half `SSIClk` period, both master and slave data are enabled onto their respective transmission lines. At the same time, `SSIClk` is enabled with a falling edge transition. Data is then captured on the rising edges and propagated on the falling edges of the `SSIClk` signal.

After all bits have been transferred, in the case of a single word transmission, the  $SSIF_{SS}$  line is returned to its idle high state one  $SSIClk$  period after the last bit has been captured.

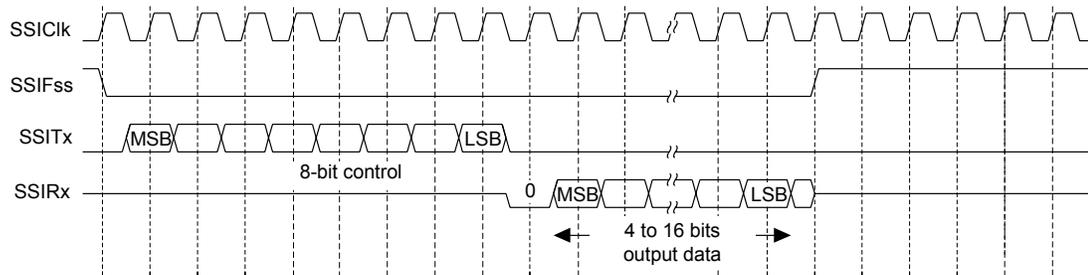
For continuous back-to-back transmissions, the  $SSIF_{SS}$  pin remains in its active Low state until the final bit of the last word has been captured and then returns to its idle state as described above.

For continuous back-to-back transfers, the  $SSIF_{SS}$  pin is held Low between successive data words and termination is the same as that of the single word transfer.

#### 15.3.4.7 MICROWIRE Frame Format

Figure 15-10 on page 656 shows the MICROWIRE frame format for a single frame. Figure 15-11 on page 657 shows the same format when back-to-back frames are transmitted.

**Figure 15-10. MICROWIRE Frame Format (Single Frame)**



MICROWIRE format is very similar to SPI format, except that transmission is half-duplex instead of full-duplex and uses a master-slave message passing technique. Each serial transmission begins with an 8-bit control word that is transmitted from the SSI to the off-chip slave device. During this transmission, no incoming data is received by the SSI. After the message has been sent, the off-chip slave decodes it and, after waiting one serial clock after the last bit of the 8-bit control message has been sent, responds with the required data. The returned data is 4 to 16 bits in length, making the total frame length anywhere from 13 to 25 bits.

In this configuration, during idle periods:

- $SSIClk$  is forced Low
- $SSIF_{SS}$  is forced High
- The transmit data line  $SSITx$  is arbitrarily forced Low

A transmission is triggered by writing a control byte to the transmit FIFO. The falling edge of  $SSIF_{SS}$  causes the value contained in the bottom entry of the transmit FIFO to be transferred to the serial shift register of the transmit logic and the MSB of the 8-bit control frame to be shifted out onto the  $SSITx$  pin.  $SSIF_{SS}$  remains Low for the duration of the frame transmission. The  $SSIRx$  pin remains tristated during this transmission.

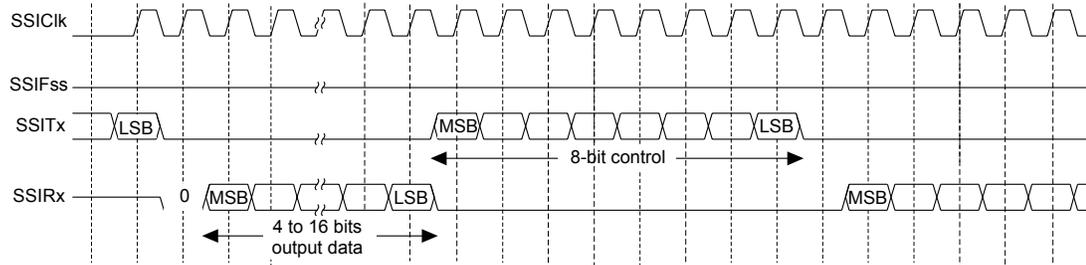
The off-chip serial slave device latches each control bit into its serial shifter on each rising edge of  $SSIClk$ . After the last bit is latched by the slave device, the control byte is decoded during a one clock wait-state, and the slave responds by transmitting data back to the SSI. Each bit is driven onto the  $SSIRx$  line on the falling edge of  $SSIClk$ . The SSI in turn latches each bit on the rising edge of  $SSIClk$ . At the end of the frame, for single transfers, the  $SSIF_{SS}$  signal is pulled High one clock period after the last bit has been latched in the receive serial shifter, causing the data to be transferred to the receive FIFO.



**Note:** The off-chip slave device can tristate the receive line either on the falling edge of `SSIClk` after the LSB has been latched by the receive shifter or when the `SSIFss` pin goes High.

For continuous transfers, data transmission begins and ends in the same manner as a single transfer. However, the `SSIFss` line is continuously asserted (held Low) and transmission of data occurs back-to-back. The control byte of the next frame follows directly after the LSB of the received data from the current frame. Each of the received values is transferred from the receive shifter on the falling edge of `SSIClk`, after the LSB of the frame has been latched into the SSI.

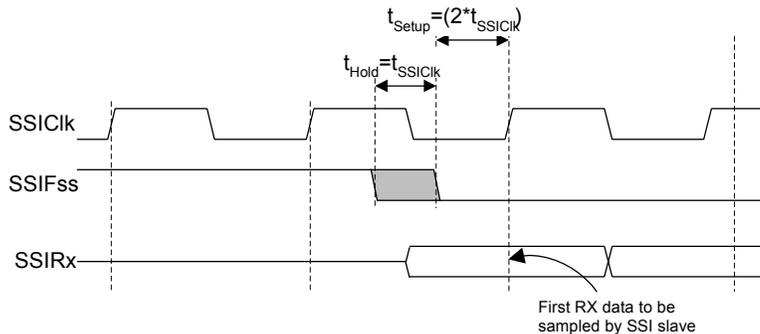
**Figure 15-11. MICROWIRE Frame Format (Continuous Transfer)**



In the MICROWIRE mode, the SSI slave samples the first bit of receive data on the rising edge of `SSIClk` after `SSIFss` has gone Low. Masters that drive a free-running `SSIClk` must ensure that the `SSIFss` signal has sufficient setup and hold margins with respect to the rising edge of `SSIClk`.

Figure 15-12 on page 657 illustrates these setup and hold time requirements. With respect to the `SSIClk` rising edge on which the first bit of receive data is to be sampled by the SSI slave, `SSIFss` must have a setup of at least two times the period of `SSIClk` on which the SSI operates. With respect to the `SSIClk` rising edge previous to this edge, `SSIFss` must have a hold of at least one `SSIClk` period.

**Figure 15-12. MICROWIRE Frame Format, SSIFss Input Setup and Hold Requirements**



### 15.3.5 DMA Operation

The SSI peripheral provides an interface to the  $\mu$ DMA controller with separate channels for transmit and receive. The  $\mu$ DMA operation of the SSI is enabled through the **SSI DMA Control (SSIDMACTL)** register. When  $\mu$ DMA operation is enabled, the SSI asserts a  $\mu$ DMA request on the receive or transmit channel when the associated FIFO can transfer data. For the receive channel, a single transfer request is asserted whenever any data is in the receive FIFO. A burst transfer request is asserted whenever the amount of data in the receive FIFO is 4 or more items. For the transmit channel, a single transfer request is asserted whenever at least one empty location is in the transmit FIFO. The burst request is asserted whenever the transmit FIFO has 4 or more empty slots. The

single and burst  $\mu$ DMA transfer requests are handled automatically by the  $\mu$ DMA controller depending how the  $\mu$ DMA channel is configured. To enable  $\mu$ DMA operation for the receive channel, the `RXDMAE` bit of the **DMA Control (SSIDMACTL)** register should be set. To enable  $\mu$ DMA operation for the transmit channel, the `TXDMAE` bit of **SSIDMACTL** should be set. If  $\mu$ DMA is enabled, then the  $\mu$ DMA controller triggers an interrupt when a transfer is complete. The interrupt occurs on the SSI interrupt vector. Therefore, if interrupts are used for SSI operation and  $\mu$ DMA is enabled, the SSI interrupt handler must be designed to handle the  $\mu$ DMA completion interrupt.

See “Micro Direct Memory Access ( $\mu$ DMA)” on page 246 for more details about programming the  $\mu$ DMA controller.

## 15.4 Initialization and Configuration

To enable and initialize the SSI, the following steps are necessary:

1. Enable the SSI module by setting the `SSI` bit in the **RCGC1** register (see page 181).
2. Enable the clock to the appropriate GPIO module via the **RCGC2** register (see page 193). To find out which GPIO port to enable, refer to Table 25-5 on page 1160.
3. Set the GPIO `AFSEL` bits for the appropriate pins (see page 328). To determine which GPIOs to configure, see Table 25-4 on page 1151.
4. Configure the `PMCn` fields in the **GPIOPCTL** register to assign the SSI signals to the appropriate pins. See page 346 and Table 25-5 on page 1160.

For each of the frame formats, the SSI is configured using the following steps:

1. Ensure that the `SSE` bit in the **SSICR1** register is clear before making any configuration changes.
2. Select whether the SSI is a master or slave:
  - a. For master operations, set the **SSICR1** register to 0x0000.0000.
  - b. For slave mode (output enabled), set the **SSICR1** register to 0x0000.0004.
  - c. For slave mode (output disabled), set the **SSICR1** register to 0x0000.000C.
3. Configure the clock prescale divisor by writing the **SSICPSR** register.
4. Write the **SSICR0** register with the following configuration:
  - Serial clock rate (`SCR`)
  - Desired clock phase/polarity, if using Freescale SPI mode (`SPH` and `SPO`)
  - The protocol mode: Freescale SPI, TI SSF, MICROWIRE (`FRF`)
  - The data size (`DSS`)
5. Optionally, configure the  $\mu$ DMA channel (see “Micro Direct Memory Access ( $\mu$ DMA)” on page 246) and enable the DMA option(s) in the **SSIDMACTL** register.
6. Enable the SSI by setting the `SSE` bit in the **SSICR1** register.

As an example, assume the SSI must be configured to operate with the following parameters:

- Master operation
- Freescale SPI mode (SPO=1, SPH=1)
- 1 Mbps bit rate
- 8 data bits

Assuming the system clock is 20 MHz, the bit rate calculation would be:

$$SSIClk = SysClk / (CPSDVSR * (1 + SCR)) \times 10^6 = 20 \times 10^6 / (CPSDVSR * (1 + SCR))$$

In this case, if CPSDVSR=0x2, SCR must be 0x9.

The configuration sequence would be as follows:

1. Ensure that the SSE bit in the **SSICR1** register is clear.
2. Write the **SSICR1** register with a value of 0x0000.0000.
3. Write the **SSICPSR** register with a value of 0x0000.0002.
4. Write the **SSICR0** register with a value of 0x0000.09C7.
5. The SSI is then enabled by setting the SSE bit in the **SSICR1** register.

## 15.5 Register Map

Table 15-3 on page 659 lists the SSI registers. The offset listed is a hexadecimal increment to the register's address, relative to that SSI module's base address:

- SSI0: 0x4000.8000
- SSI1: 0x4000.9000

Note that the SSI module clock must be enabled before the registers can be programmed (see page 181).

**Note:** The SSI must be disabled (see the SSE bit in the **SSICR1** register) before any of the control registers are reprogrammed.

**Table 15-3. SSI Register Map**

Offset	Name	Type	Reset	Description	See page
0x000	SSICR0	R/W	0x0000.0000	SSI Control 0	661
0x004	SSICR1	R/W	0x0000.0000	SSI Control 1	663
0x008	SSIDR	R/W	0x0000.0000	SSI Data	665
0x00C	SSISR	RO	0x0000.0003	SSI Status	666
0x010	SSICPSR	R/W	0x0000.0000	SSI Clock Prescale	668
0x014	SSIIM	R/W	0x0000.0000	SSI Interrupt Mask	669
0x018	SSIRIS	RO	0x0000.0008	SSI Raw Interrupt Status	670

Table 15-3. SSI Register Map (continued)

Offset	Name	Type	Reset	Description	See page
0x01C	SSIMIS	RO	0x0000.0000	SSI Masked Interrupt Status	672
0x020	SSIICR	W1C	0x0000.0000	SSI Interrupt Clear	674
0x024	SSIDMACTL	R/W	0x0000.0000	SSI DMA Control	675
0xFD0	SSIPeriphID4	RO	0x0000.0000	SSI Peripheral Identification 4	676
0xFD4	SSIPeriphID5	RO	0x0000.0000	SSI Peripheral Identification 5	677
0xFD8	SSIPeriphID6	RO	0x0000.0000	SSI Peripheral Identification 6	678
0xFDC	SSIPeriphID7	RO	0x0000.0000	SSI Peripheral Identification 7	679
0xFE0	SSIPeriphID0	RO	0x0000.0022	SSI Peripheral Identification 0	680
0xFE4	SSIPeriphID1	RO	0x0000.0000	SSI Peripheral Identification 1	681
0xFE8	SSIPeriphID2	RO	0x0000.0018	SSI Peripheral Identification 2	682
0xFEC	SSIPeriphID3	RO	0x0000.0001	SSI Peripheral Identification 3	683
0xFF0	SSIPrimeCellID0	RO	0x0000.000D	SSI PrimeCell Identification 0	684
0xFF4	SSIPrimeCellID1	RO	0x0000.00F0	SSI PrimeCell Identification 1	685
0xFF8	SSIPrimeCellID2	RO	0x0000.0005	SSI PrimeCell Identification 2	686
0xFFC	SSIPrimeCellID3	RO	0x0000.00B1	SSI PrimeCell Identification 3	687

## 15.6 Register Descriptions

The remainder of this section lists and describes the SSI registers, in numerical order by address offset.

## Register 1: SSI Control 0 (SSICR0), offset 0x000

The **SSICR0** register contains bit fields that control various functions within the SSI module. Functionality such as protocol mode, clock rate, and data size are configured in this register.

### SSI Control 0 (SSICR0)

SSI0 base: 0x4000.8000  
 SSI1 base: 0x4000.9000  
 Offset 0x000  
 Type R/W, reset 0x0000.0000

	31	30	29	28	27	26	25	24	23	22	21	20	19	18	17	16
	reserved															
Type	RO	RO	RO	RO	RO	RO	RO	RO	RO	RO	RO	RO	RO	RO	RO	RO
Reset	0	0	0	0	0	0	0	0	0	0	0	0	0	0	0	0
	15	14	13	12	11	10	9	8	7	6	5	4	3	2	1	0
	SCR								SPH	SPO	FRF		DSS			
Type	R/W	R/W	R/W	R/W	R/W	R/W	R/W	R/W	R/W	R/W	R/W	R/W	R/W	R/W	R/W	R/W
Reset	0	0	0	0	0	0	0	0	0	0	0	0	0	0	0	0

Bit/Field	Name	Type	Reset	Description
31:16	reserved	RO	0x0000	Software should not rely on the value of a reserved bit. To provide compatibility with future products, the value of a reserved bit should be preserved across a read-modify-write operation.
15:8	SCR	R/W	0x00	SSI Serial Clock Rate  This bit field is used to generate the transmit and receive bit rate of the SSI. The bit rate is:  $BR = SSI\text{Clk} / (\text{CPSDVSR} * (1 + \text{SCR}))$ where CPSDVSR is an even value from 2-254 programmed in the <b>SSICPSR</b> register, and SCR is a value from 0-255.
7	SPH	R/W	0	SSI Serial Clock Phase  This bit is only applicable to the Freescale SPI Format.  The SPH control bit selects the clock edge that captures data and allows it to change state. This bit has the most impact on the first bit transmitted by either allowing or not allowing a clock transition before the first data capture edge.  Value Description 0 Data is captured on the first clock edge transition. 1 Data is captured on the second clock edge transition.
6	SPO	R/W	0	SSI Serial Clock Polarity  Value Description 0 A steady state Low value is placed on the SSI $\text{Clk}$ pin. 1 A steady state High value is placed on the SSI $\text{Clk}$ pin when data is not being transferred.

Bit/Field	Name	Type	Reset	Description
5:4	FRF	R/W	0x0	SSI Frame Format Select  Value   Frame Format 0x0   Freescale SPI Frame Format 0x1   Texas Instruments Synchronous Serial Frame Format 0x2   MICROWIRE Frame Format 0x3   Reserved
3:0	DSS	R/W	0x0	SSI Data Size Select  Value   Data Size 0x0-0x2 Reserved 0x3   4-bit data 0x4   5-bit data 0x5   6-bit data 0x6   7-bit data 0x7   8-bit data 0x8   9-bit data 0x9   10-bit data 0xA   11-bit data 0xB   12-bit data 0xC   13-bit data 0xD   14-bit data 0xE   15-bit data 0xF   16-bit data

## Register 2: SSI Control 1 (SSICR1), offset 0x004

The **SSICR1** register contains bit fields that control various functions within the SSI module. Master and slave mode functionality is controlled by this register.

### SSI Control 1 (SSICR1)

SSI0 base: 0x4000.8000  
 SSI1 base: 0x4000.9000  
 Offset 0x004  
 Type R/W, reset 0x0000.0000

	31	30	29	28	27	26	25	24	23	22	21	20	19	18	17	16	
	reserved																
Type	RO	RO	RO	RO	RO	RO	RO	RO	RO	RO	RO	RO	RO	RO	RO	RO	
Reset	0	0	0	0	0	0	0	0	0	0	0	0	0	0	0	0	
	15	14	13	12	11	10	9	8	7	6	5	4	3	2	1	0	
	reserved												EOT	SOD	MS	SSE	LBM
Type	RO	RO	RO	RO	RO	RO	RO	RO	RO	RO	RO	RO	R/W	R/W	R/W	R/W	R/W
Reset	0	0	0	0	0	0	0	0	0	0	0	0	0	0	0	0	0

Bit/Field	Name	Type	Reset	Description
31:5	reserved	RO	0x0000.0	Software should not rely on the value of a reserved bit. To provide compatibility with future products, the value of a reserved bit should be preserved across a read-modify-write operation.
4	EOT	R/W	0	End of Transmission  Value Description 0 The TXRIS interrupt indicates that the transmit FIFO is half full or less. 1 The End of Transmit interrupt mode for the TXRIS interrupt is enabled.
3	SOD	R/W	0	SSI Slave Mode Output Disable  This bit is relevant only in the Slave mode ( $MS=1$ ). In multiple-slave systems, it is possible for the SSI master to broadcast a message to all slaves in the system while ensuring that only one slave drives data onto the serial output line. In such systems, the TXD lines from multiple slaves could be tied together. To operate in such a system, the SOD bit can be configured so that the SSI slave does not drive the SSITx pin.  Value Description 0 SSI can drive the SSITx output in Slave mode. 1 SSI must not drive the SSITx output in Slave mode.
2	MS	R/W	0	SSI Master/Slave Select  This bit selects Master or Slave mode and can be modified only when the SSI is disabled ( $SSE=0$ ).  Value Description 0 The SSI is configured as a master. 1 The SSI is configured as a slave.

Bit/Field	Name	Type	Reset	Description
1	SSE	R/W	0	SSI Synchronous Serial Port Enable  Value Description 0 SSI operation is disabled. 1 SSI operation is enabled.  <b>Note:</b> This bit must be cleared before any control registers are reprogrammed.
0	LBM	R/W	0	SSI Loopback Mode  Value Description 0 Normal serial port operation enabled. 1 Output of the transmit serial shift register is connected internally to the input of the receive serial shift register.



### Register 3: SSI Data (SSIDR), offset 0x008

**Important:** Use caution when reading this register. Performing a read may change bit status.

The **SSIDR** register is 16-bits wide. When the **SSIDR** register is read, the entry in the receive FIFO that is pointed to by the current FIFO read pointer is accessed. When a data value is removed by the SSI receive logic from the incoming data frame, it is placed into the entry in the receive FIFO pointed to by the current FIFO write pointer.

When the **SSIDR** register is written to, the entry in the transmit FIFO that is pointed to by the write pointer is written to. Data values are removed from the transmit FIFO one value at a time by the transmit logic. Each data value is loaded into the transmit serial shifter, then serially shifted out onto the **SSITx** pin at the programmed bit rate.

When a data size of less than 16 bits is selected, the user must right-justify data written to the transmit FIFO. The transmit logic ignores the unused bits. Received data less than 16 bits is automatically right-justified in the receive buffer.

When the SSI is programmed for MICROWIRE frame format, the default size for transmit data is eight bits (the most significant byte is ignored). The receive data size is controlled by the programmer. The transmit FIFO and the receive FIFO are not cleared even when the **SSE** bit in the **SSICR1** register is cleared, allowing the software to fill the transmit FIFO before enabling the SSI.

#### SSI Data (SSIDR)

SSI0 base: 0x4000.8000  
 SSI1 base: 0x4000.9000  
 Offset 0x008  
 Type R/W, reset 0x0000.0000

	31	30	29	28	27	26	25	24	23	22	21	20	19	18	17	16
	reserved															
Type	RO	RO	RO	RO	RO	RO	RO	RO	RO	RO	RO	RO	RO	RO	RO	RO
Reset	0	0	0	0	0	0	0	0	0	0	0	0	0	0	0	0
	15	14	13	12	11	10	9	8	7	6	5	4	3	2	1	0
	DATA															
Type	R/W	R/W	R/W	R/W	R/W	R/W	R/W	R/W	R/W	R/W	R/W	R/W	R/W	R/W	R/W	R/W
Reset	0	0	0	0	0	0	0	0	0	0	0	0	0	0	0	0

Bit/Field	Name	Type	Reset	Description
31:16	reserved	RO	0x0000	Software should not rely on the value of a reserved bit. To provide compatibility with future products, the value of a reserved bit should be preserved across a read-modify-write operation.
15:0	DATA	R/W	0x0000	SSI Receive/Transmit Data  A read operation reads the receive FIFO. A write operation writes the transmit FIFO.  Software must right-justify data when the SSI is programmed for a data size that is less than 16 bits. Unused bits at the top are ignored by the transmit logic. The receive logic automatically right-justifies the data.

### Register 4: SSI Status (SSISR), offset 0x00C

The **SSISR** register contains bits that indicate the FIFO fill status and the SSI busy status.

#### SSI Status (SSISR)

SSI0 base: 0x4000.8000  
 SSI1 base: 0x4000.9000  
 Offset 0x00C  
 Type RO, reset 0x0000.0003

	31	30	29	28	27	26	25	24	23	22	21	20	19	18	17	16	
	reserved																
Type	RO	RO	RO	RO	RO	RO	RO	RO	RO	RO	RO	RO	RO	RO	RO	RO	
Reset	0	0	0	0	0	0	0	0	0	0	0	0	0	0	0	0	
	15	14	13	12	11	10	9	8	7	6	5	4	3	2	1	0	
	reserved												BSY	RFF	RNE	TNF	TFE
Type	RO	RO	RO	RO	RO	RO	RO	RO	RO	RO	RO	RO	RO	RO	RO	RO	
Reset	0	0	0	0	0	0	0	0	0	0	0	0	0	0	1	1	

Bit/Field	Name	Type	Reset	Description
31:5	reserved	RO	0x0000.00	Software should not rely on the value of a reserved bit. To provide compatibility with future products, the value of a reserved bit should be preserved across a read-modify-write operation.
4	BSY	RO	0	SSI Busy Bit  Value Description 0 The SSI is idle. 1 The SSI is currently transmitting and/or receiving a frame, or the transmit FIFO is not empty.
3	RFF	RO	0	SSI Receive FIFO Full  Value Description 0 The receive FIFO is not full. 1 The receive FIFO is full.
2	RNE	RO	0	SSI Receive FIFO Not Empty  Value Description 0 The receive FIFO is empty. 1 The receive FIFO is not empty.
1	TNF	RO	1	SSI Transmit FIFO Not Full  Value Description 0 The transmit FIFO is full. 1 The transmit FIFO is not full.

---

Bit/Field	Name	Type	Reset	Description
0	TFE	RO	1	SSI Transmit FIFO Empty
				Value Description
				0 The transmit FIFO is not empty.
				1 The transmit FIFO is empty.

**Register 5: SSI Clock Prescale (SSICPSR), offset 0x010**

The **SSICPSR** register specifies the division factor which is used to derive the **SSIClk** from the system clock. The clock is further divided by a value from 1 to 256, which is  $1 + \text{SCR}$ . **SCR** is programmed in the **SSICR0** register. The frequency of the **SSIClk** is defined by:

$$\text{SSIClk} = \text{SysClk} / (\text{CPSDVSR} * (1 + \text{SCR}))$$

The value programmed into this register must be an even number between 2 and 254. The least-significant bit of the programmed number is hard-coded to zero. If an odd number is written to this register, data read back from this register has the least-significant bit as zero.

## SSI Clock Prescale (SSICPSR)

SSI0 base: 0x4000.8000  
 SSI1 base: 0x4000.9000  
 Offset 0x010  
 Type R/W, reset 0x0000.0000

	31	30	29	28	27	26	25	24	23	22	21	20	19	18	17	16
	reserved															
Type	RO	RO	RO	RO	RO	RO	RO	RO	RO	RO	RO	RO	RO	RO	RO	RO
Reset	0	0	0	0	0	0	0	0	0	0	0	0	0	0	0	0
	15	14	13	12	11	10	9	8	7	6	5	4	3	2	1	0
	reserved								CPSDVSR							
Type	RO	RO	RO	RO	RO	RO	RO	RO	R/W	R/W	R/W	R/W	R/W	R/W	R/W	R/W
Reset	0	0	0	0	0	0	0	0	0	0	0	0	0	0	0	0

Bit/Field	Name	Type	Reset	Description
31:8	reserved	RO	0x00	Software should not rely on the value of a reserved bit. To provide compatibility with future products, the value of a reserved bit should be preserved across a read-modify-write operation.
7:0	CPSDVSR	R/W	0x00	SSI Clock Prescale Divisor  This value must be an even number from 2 to 254, depending on the frequency of <b>SSIClk</b> . The LSB always returns 0 on reads.

## Register 6: SSI Interrupt Mask (SSIIM), offset 0x014

The **SSIIM** register is the interrupt mask set or clear register. It is a read/write register and all bits are cleared on reset.

On a read, this register gives the current value of the mask on the corresponding interrupt. Setting a bit sets the mask, preventing the interrupt from being signaled to the interrupt controller. Clearing a bit clears the corresponding mask, enabling the interrupt to be sent to the interrupt controller.

### SSI Interrupt Mask (SSIIM)

SSI0 base: 0x4000.8000  
 SSI1 base: 0x4000.9000  
 Offset 0x014  
 Type R/W, reset 0x0000.0000

	31	30	29	28	27	26	25	24	23	22	21	20	19	18	17	16	
	reserved																
Type	RO	RO	RO	RO	RO	RO	RO	RO	RO	RO	RO	RO	RO	RO	RO	RO	
Reset	0	0	0	0	0	0	0	0	0	0	0	0	0	0	0	0	
	15	14	13	12	11	10	9	8	7	6	5	4	3	2	1	0	
	reserved													TXIM	RXIM	RTIM	RORIM
Type	RO	RO	RO	RO	RO	RO	RO	RO	RO	RO	RO	RO	RO	R/W	R/W	R/W	R/W
Reset	0	0	0	0	0	0	0	0	0	0	0	0	0	0	0	0	0

Bit/Field	Name	Type	Reset	Description
31:4	reserved	RO	0x0000.000	Software should not rely on the value of a reserved bit. To provide compatibility with future products, the value of a reserved bit should be preserved across a read-modify-write operation.
3	TXIM	R/W	0	SSI Transmit FIFO Interrupt Mask  Value Description 0 The transmit FIFO interrupt is masked. 1 The transmit FIFO interrupt is not masked.
2	RXIM	R/W	0	SSI Receive FIFO Interrupt Mask  Value Description 0 The receive FIFO interrupt is masked. 1 The receive FIFO interrupt is not masked.
1	RTIM	R/W	0	SSI Receive Time-Out Interrupt Mask  Value Description 0 The receive FIFO time-out interrupt is masked. 1 The receive FIFO time-out interrupt is not masked.
0	RORIM	R/W	0	SSI Receive Overrun Interrupt Mask  Value Description 0 The receive FIFO overrun interrupt is masked. 1 The receive FIFO overrun interrupt is not masked.

### Register 7: SSI Raw Interrupt Status (SSIRIS), offset 0x018

The **SSIRIS** register is the raw interrupt status register. On a read, this register gives the current raw status value of the corresponding interrupt prior to masking. A write has no effect.

#### SSI Raw Interrupt Status (SSIRIS)

SSI0 base: 0x4000.8000  
 SSI1 base: 0x4000.9000  
 Offset 0x018  
 Type RO, reset 0x0000.0008

	31	30	29	28	27	26	25	24	23	22	21	20	19	18	17	16	
	reserved																
Type	RO	RO	RO	RO	RO	RO	RO	RO	RO	RO	RO	RO	RO	RO	RO	RO	
Reset	0	0	0	0	0	0	0	0	0	0	0	0	0	0	0	0	
	15	14	13	12	11	10	9	8	7	6	5	4	3	2	1	0	
	reserved													TXRIS	RXRIS	RTRIS	RORRIS
Type	RO	RO	RO	RO	RO	RO	RO	RO	RO	RO	RO	RO	RO	RO	RO	RO	
Reset	0	0	0	0	0	0	0	0	0	0	0	0	0	1	0	0	0

Bit/Field	Name	Type	Reset	Description
31:4	reserved	RO	0x0000.000	Software should not rely on the value of a reserved bit. To provide compatibility with future products, the value of a reserved bit should be preserved across a read-modify-write operation.
3	TXRIS	RO	1	SSI Transmit FIFO Raw Interrupt Status  Value Description 0 No interrupt. 1 If the <b>EOT</b> bit in the <b>SSICR1</b> register is clear, the transmit FIFO is half full or less.  If the <b>EOT</b> bit is set, the transmit FIFO is empty, and the last bit has been transmitted out of the serializer.  This bit is cleared when the transmit FIFO is more than half full (if the <b>EOT</b> bit is clear) or when it has any data in it (if the <b>EOT</b> bit is set).
2	RXRIS	RO	0	SSI Receive FIFO Raw Interrupt Status  Value Description 0 No interrupt. 1 The receive FIFO is half full or more.  This bit is cleared when the receive FIFO is less than half full.
1	RTRIS	RO	0	SSI Receive Time-Out Raw Interrupt Status  Value Description 0 No interrupt. 1 The receive time-out has occurred.  This bit is cleared when a 1 is written to the <b>RTIC</b> bit in the <b>SSI Interrupt Clear (SSICR)</b> register.

---

Bit/Field	Name	Type	Reset	Description
0	RORRIS	RO	0	SSI Receive Overrun Raw Interrupt Status  Value Description 0 No interrupt. 1 The receive FIFO has overflowed  This bit is cleared when a 1 is written to the RORIC bit in the <b>SSI Interrupt Clear (SSIICR)</b> register.

**Register 8: SSI Masked Interrupt Status (SSIMIS), offset 0x01C**

The **SSIMIS** register is the masked interrupt status register. On a read, this register gives the current masked status value of the corresponding interrupt. A write has no effect.

**SSI Masked Interrupt Status (SSIMIS)**

SSI0 base: 0x4000.8000  
 SSI1 base: 0x4000.9000  
 Offset 0x01C  
 Type RO, reset 0x0000.0000

	31	30	29	28	27	26	25	24	23	22	21	20	19	18	17	16
	reserved															
Type	RO	RO	RO	RO	RO	RO	RO	RO	RO	RO	RO	RO	RO	RO	RO	RO
Reset	0	0	0	0	0	0	0	0	0	0	0	0	0	0	0	0
	15	14	13	12	11	10	9	8	7	6	5	4	3	2	1	0
	reserved												TXMIS	RXMIS	RTMIS	RORMIS
Type	RO	RO	RO	RO	RO	RO	RO	RO	RO	RO	RO	RO	RO	RO	RO	RO
Reset	0	0	0	0	0	0	0	0	0	0	0	0	0	0	0	0

Bit/Field	Name	Type	Reset	Description
31:4	reserved	RO	0x0000.000	Software should not rely on the value of a reserved bit. To provide compatibility with future products, the value of a reserved bit should be preserved across a read-modify-write operation.
3	TXMIS	RO	0	SSI Transmit FIFO Masked Interrupt Status  Value Description 0 An interrupt has not occurred or is masked. 1 An unmasked interrupt was signaled due to the transmit FIFO being half full or less (if the EOT bit is clear) or due to the transmission of the last data bit (if the EOT bit is set).  This bit is cleared when the transmit FIFO is more than half full (if the EOT bit is clear) or when it has any data in it (if the EOT bit is set).
2	RXMIS	RO	0	SSI Receive FIFO Masked Interrupt Status  Value Description 0 An interrupt has not occurred or is masked. 1 An unmasked interrupt was signaled due to the receive FIFO being half full or less.  This bit is cleared when the receive FIFO is less than half full.
1	RTMIS	RO	0	SSI Receive Time-Out Masked Interrupt Status  Value Description 0 An interrupt has not occurred or is masked. 1 An unmasked interrupt was signaled due to the receive time out.  This bit is cleared when a 1 is written to the RTIC bit in the <b>SSI Interrupt Clear (SSIICR)</b> register.



---

Bit/Field	Name	Type	Reset	Description
0	RORMIS	RO	0	SSI Receive Overrun Masked Interrupt Status  Value Description 0 An interrupt has not occurred or is masked. 1 An unmasked interrupt was signaled due to the receive FIFO overflowing.  This bit is cleared when a 1 is written to the RORIC bit in the <b>SSI Interrupt Clear (SSIICR)</b> register.

**Register 9: SSI Interrupt Clear (SSIICR), offset 0x020**

The **SSIICR** register is the interrupt clear register. On a write of 1, the corresponding interrupt is cleared. A write of 0 has no effect.

## SSI Interrupt Clear (SSIICR)

SSI0 base: 0x4000.8000

SSI1 base: 0x4000.9000

Offset 0x020

Type W1C, reset 0x0000.0000

	31	30	29	28	27	26	25	24	23	22	21	20	19	18	17	16	
	reserved																
Type	RO	RO	RO	RO	RO	RO	RO	RO	RO	RO	RO	RO	RO	RO	RO	RO	
Reset	0	0	0	0	0	0	0	0	0	0	0	0	0	0	0	0	
	15	14	13	12	11	10	9	8	7	6	5	4	3	2	1	0	
	reserved														RTIC	RORIC	
Type	RO	RO	RO	RO	RO	RO	RO	RO	RO	RO	RO	RO	RO	RO	RO	W1C	W1C
Reset	0	0	0	0	0	0	0	0	0	0	0	0	0	0	0	0	0

Bit/Field	Name	Type	Reset	Description
31:2	reserved	RO	0x0000.0000	Software should not rely on the value of a reserved bit. To provide compatibility with future products, the value of a reserved bit should be preserved across a read-modify-write operation.
1	RTIC	W1C	0	SSI Receive Time-Out Interrupt Clear  Writing a 1 to this bit clears the <b>RTRIS</b> bit in the <b>SSIRIS</b> register and the <b>RTMIS</b> bit in the <b>SSIMIS</b> register.
0	RORIC	W1C	0	SSI Receive Overrun Interrupt Clear  Writing a 1 to this bit clears the <b>RORRIS</b> bit in the <b>SSIRIS</b> register and the <b>RORMIS</b> bit in the <b>SSIMIS</b> register.

**Register 10: SSI DMA Control (SSIDMACTL), offset 0x024**

The **SSIDMACTL** register is the  $\mu$ DMA control register.

**SSI DMA Control (SSIDMACTL)**

SSI0 base: 0x4000.8000

SSI1 base: 0x4000.9000

Offset 0x024

Type R/W, reset 0x0000.0000

	31	30	29	28	27	26	25	24	23	22	21	20	19	18	17	16	
	reserved																
Type	RO	RO	RO	RO	RO	RO	RO	RO	RO	RO	RO	RO	RO	RO	RO	RO	
Reset	0	0	0	0	0	0	0	0	0	0	0	0	0	0	0	0	
	15	14	13	12	11	10	9	8	7	6	5	4	3	2	1	0	
	reserved															TXDMAE	RXDMAE
Type	RO	RO	RO	RO	RO	RO	RO	RO	RO	RO	RO	RO	RO	RO	RO	R/W	R/W
Reset	0	0	0	0	0	0	0	0	0	0	0	0	0	0	0	0	0

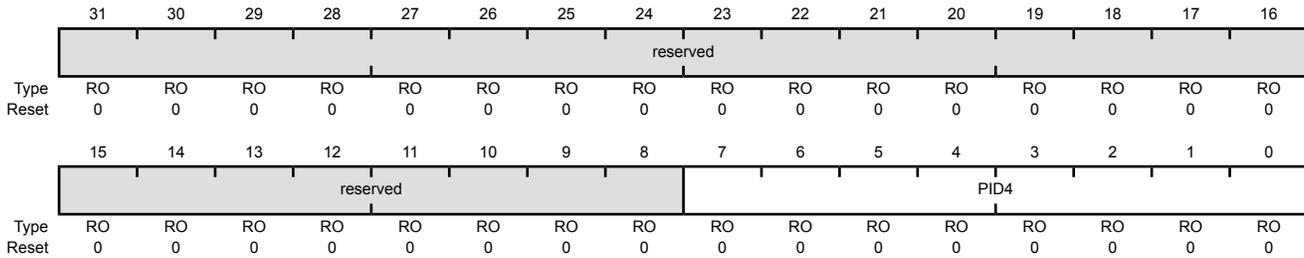
Bit/Field	Name	Type	Reset	Description
31:2	reserved	RO	0x0000.000	Software should not rely on the value of a reserved bit. To provide compatibility with future products, the value of a reserved bit should be preserved across a read-modify-write operation.
1	TXDMAE	R/W	0	Transmit DMA Enable  Value Description 0 $\mu$ DMA for the transmit FIFO is disabled. 1 $\mu$ DMA for the transmit FIFO is enabled.
0	RXDMAE	R/W	0	Receive DMA Enable  Value Description 0 $\mu$ DMA for the receive FIFO is disabled. 1 $\mu$ DMA for the receive FIFO is enabled.

### Register 11: SSI Peripheral Identification 4 (SSIPeriphID4), offset 0xFD0

The **SSIPeriphIDn** registers are hard-coded and the fields within the register determine the reset value.

#### SSI Peripheral Identification 4 (SSIPeriphID4)

SSI0 base: 0x4000.8000  
 SSI1 base: 0x4000.9000  
 Offset 0xFD0  
 Type RO, reset 0x0000.0000



Bit/Field	Name	Type	Reset	Description
31:8	reserved	RO	0x0000.00	Software should not rely on the value of a reserved bit. To provide compatibility with future products, the value of a reserved bit should be preserved across a read-modify-write operation.
7:0	PID4	RO	0x00	SSI Peripheral ID Register [7:0]  Can be used by software to identify the presence of this peripheral.

## Register 12: SSI Peripheral Identification 5 (SSIPeriphID5), offset 0xFD4

The **SSIPeriphIDn** registers are hard-coded and the fields within the register determine the reset value.

### SSI Peripheral Identification 5 (SSIPeriphID5)

SSI0 base: 0x4000.8000  
 SSI1 base: 0x4000.9000  
 Offset 0xFD4  
 Type RO, reset 0x0000.0000

	31	30	29	28	27	26	25	24	23	22	21	20	19	18	17	16
	reserved															
Type	RO	RO	RO	RO	RO	RO	RO	RO	RO	RO	RO	RO	RO	RO	RO	RO
Reset	0	0	0	0	0	0	0	0	0	0	0	0	0	0	0	0
	15	14	13	12	11	10	9	8	7	6	5	4	3	2	1	0
	reserved								PID5							
Type	RO	RO	RO	RO	RO	RO	RO	RO	RO	RO	RO	RO	RO	RO	RO	RO
Reset	0	0	0	0	0	0	0	0	0	0	0	0	0	0	0	0

Bit/Field	Name	Type	Reset	Description
31:8	reserved	RO	0x0000.00	Software should not rely on the value of a reserved bit. To provide compatibility with future products, the value of a reserved bit should be preserved across a read-modify-write operation.
7:0	PID5	RO	0x00	SSI Peripheral ID Register [15:8]  Can be used by software to identify the presence of this peripheral.

### Register 13: SSI Peripheral Identification 6 (SSIPeriphID6), offset 0xFD8

The **SSIPeriphIDn** registers are hard-coded and the fields within the register determine the reset value.

#### SSI Peripheral Identification 6 (SSIPeriphID6)

SSI0 base: 0x4000.8000  
 SSI1 base: 0x4000.9000  
 Offset 0xFD8  
 Type RO, reset 0x0000.0000

	31	30	29	28	27	26	25	24	23	22	21	20	19	18	17	16
	reserved															
Type	RO	RO	RO	RO	RO	RO	RO	RO	RO	RO	RO	RO	RO	RO	RO	RO
Reset	0	0	0	0	0	0	0	0	0	0	0	0	0	0	0	0
	15	14	13	12	11	10	9	8	7	6	5	4	3	2	1	0
	reserved								PID6							
Type	RO	RO	RO	RO	RO	RO	RO	RO	RO	RO	RO	RO	RO	RO	RO	RO
Reset	0	0	0	0	0	0	0	0	0	0	0	0	0	0	0	0

Bit/Field	Name	Type	Reset	Description
31:8	reserved	RO	0x0000.00	Software should not rely on the value of a reserved bit. To provide compatibility with future products, the value of a reserved bit should be preserved across a read-modify-write operation.
7:0	PID6	RO	0x00	SSI Peripheral ID Register [23:16]  Can be used by software to identify the presence of this peripheral.

**Register 14: SSI Peripheral Identification 7 (SSIPeriphID7), offset 0xFDC**

The **SSIPeriphIDn** registers are hard-coded and the fields within the register determine the reset value.

**SSI Peripheral Identification 7 (SSIPeriphID7)**

SSI0 base: 0x4000.8000  
 SSI1 base: 0x4000.9000  
 Offset 0xFDC  
 Type RO, reset 0x0000.0000

	31	30	29	28	27	26	25	24	23	22	21	20	19	18	17	16
	reserved															
Type	RO	RO	RO	RO	RO	RO	RO	RO	RO	RO	RO	RO	RO	RO	RO	RO
Reset	0	0	0	0	0	0	0	0	0	0	0	0	0	0	0	0
	15	14	13	12	11	10	9	8	7	6	5	4	3	2	1	0
	reserved								PID7							
Type	RO	RO	RO	RO	RO	RO	RO	RO	RO	RO	RO	RO	RO	RO	RO	RO
Reset	0	0	0	0	0	0	0	0	0	0	0	0	0	0	0	0

Bit/Field	Name	Type	Reset	Description
31:8	reserved	RO	0x0000.00	Software should not rely on the value of a reserved bit. To provide compatibility with future products, the value of a reserved bit should be preserved across a read-modify-write operation.
7:0	PID7	RO	0x00	SSI Peripheral ID Register [31:24]  Can be used by software to identify the presence of this peripheral.

### Register 15: SSI Peripheral Identification 0 (SSIPeriphID0), offset 0xFE0

The **SSIPeriphIDn** registers are hard-coded and the fields within the register determine the reset value.

#### SSI Peripheral Identification 0 (SSIPeriphID0)

SSI0 base: 0x4000.8000  
 SSI1 base: 0x4000.9000  
 Offset 0xFE0  
 Type RO, reset 0x0000.0022

	31	30	29	28	27	26	25	24	23	22	21	20	19	18	17	16
	reserved															
Type	RO	RO	RO	RO	RO	RO	RO	RO	RO	RO	RO	RO	RO	RO	RO	RO
Reset	0	0	0	0	0	0	0	0	0	0	0	0	0	0	0	0
	15	14	13	12	11	10	9	8	7	6	5	4	3	2	1	0
	reserved								PID0							
Type	RO	RO	RO	RO	RO	RO	RO	RO	RO	RO	RO	RO	RO	RO	RO	RO
Reset	0	0	0	0	0	0	0	0	0	0	1	0	0	0	1	0

Bit/Field	Name	Type	Reset	Description
31:8	reserved	RO	0x0000.00	Software should not rely on the value of a reserved bit. To provide compatibility with future products, the value of a reserved bit should be preserved across a read-modify-write operation.
7:0	PID0	RO	0x22	SSI Peripheral ID Register [7:0]  Can be used by software to identify the presence of this peripheral.



**Register 16: SSI Peripheral Identification 1 (SSIPeriphID1), offset 0xFE4**

The **SSIPeriphIDn** registers are hard-coded and the fields within the register determine the reset value.

## SSI Peripheral Identification 1 (SSIPeriphID1)

SSI0 base: 0x4000.8000

SSI1 base: 0x4000.9000

Offset 0xFE4

Type RO, reset 0x0000.0000

	31	30	29	28	27	26	25	24	23	22	21	20	19	18	17	16
	reserved															
Type	RO	RO	RO	RO	RO	RO	RO	RO	RO	RO	RO	RO	RO	RO	RO	RO
Reset	0	0	0	0	0	0	0	0	0	0	0	0	0	0	0	0
	15	14	13	12	11	10	9	8	7	6	5	4	3	2	1	0
	reserved								PID1							
Type	RO	RO	RO	RO	RO	RO	RO	RO	RO	RO	RO	RO	RO	RO	RO	RO
Reset	0	0	0	0	0	0	0	0	0	0	0	0	0	0	0	0

Bit/Field	Name	Type	Reset	Description
31:8	reserved	RO	0x0000.00	Software should not rely on the value of a reserved bit. To provide compatibility with future products, the value of a reserved bit should be preserved across a read-modify-write operation.
7:0	PID1	RO	0x00	SSI Peripheral ID Register [15:8] Can be used by software to identify the presence of this peripheral.

### Register 17: SSI Peripheral Identification 2 (SSIPeriphID2), offset 0xFE8

The **SSIPeriphIDn** registers are hard-coded and the fields within the register determine the reset value.

#### SSI Peripheral Identification 2 (SSIPeriphID2)

SSI0 base: 0x4000.8000  
 SSI1 base: 0x4000.9000  
 Offset 0xFE8  
 Type RO, reset 0x0000.0018

	31	30	29	28	27	26	25	24	23	22	21	20	19	18	17	16
	reserved															
Type	RO	RO	RO	RO	RO	RO	RO	RO	RO	RO	RO	RO	RO	RO	RO	RO
Reset	0	0	0	0	0	0	0	0	0	0	0	0	0	0	0	0
	15	14	13	12	11	10	9	8	7	6	5	4	3	2	1	0
	reserved								PID2							
Type	RO	RO	RO	RO	RO	RO	RO	RO	RO	RO	RO	RO	RO	RO	RO	RO
Reset	0	0	0	0	0	0	0	0	0	0	0	0	1	1	0	0

Bit/Field	Name	Type	Reset	Description
31:8	reserved	RO	0x0000.00	Software should not rely on the value of a reserved bit. To provide compatibility with future products, the value of a reserved bit should be preserved across a read-modify-write operation.
7:0	PID2	RO	0x18	SSI Peripheral ID Register [23:16]  Can be used by software to identify the presence of this peripheral.

## Register 18: SSI Peripheral Identification 3 (SSIPeriphID3), offset 0xFEC

The **SSIPeriphIDn** registers are hard-coded and the fields within the register determine the reset value.

### SSI Peripheral Identification 3 (SSIPeriphID3)

SSI0 base: 0x4000.8000

SSI1 base: 0x4000.9000

Offset 0xFEC

Type RO, reset 0x0000.0001

	31	30	29	28	27	26	25	24	23	22	21	20	19	18	17	16
	reserved															
Type	RO	RO	RO	RO	RO	RO	RO	RO	RO	RO	RO	RO	RO	RO	RO	RO
Reset	0	0	0	0	0	0	0	0	0	0	0	0	0	0	0	0
	15	14	13	12	11	10	9	8	7	6	5	4	3	2	1	0
	reserved								PID3							
Type	RO	RO	RO	RO	RO	RO	RO	RO	RO	RO	RO	RO	RO	RO	RO	RO
Reset	0	0	0	0	0	0	0	0	0	0	0	0	0	0	0	1

Bit/Field	Name	Type	Reset	Description
31:8	reserved	RO	0x0000.00	Software should not rely on the value of a reserved bit. To provide compatibility with future products, the value of a reserved bit should be preserved across a read-modify-write operation.
7:0	PID3	RO	0x01	SSI Peripheral ID Register [31:24] Can be used by software to identify the presence of this peripheral.

### Register 19: SSI PrimeCell Identification 0 (SSIPCellID0), offset 0xFF0

The **SSIPCellIDn** registers are hard-coded, and the fields within the register determine the reset value.

#### SSI PrimeCell Identification 0 (SSIPCellID0)

SSI0 base: 0x4000.8000  
 SSI1 base: 0x4000.9000  
 Offset 0xFF0  
 Type RO, reset 0x0000.000D

	31	30	29	28	27	26	25	24	23	22	21	20	19	18	17	16
	reserved															
Type	RO	RO	RO	RO	RO	RO	RO	RO	RO	RO	RO	RO	RO	RO	RO	RO
Reset	0	0	0	0	0	0	0	0	0	0	0	0	0	0	0	0
	15	14	13	12	11	10	9	8	7	6	5	4	3	2	1	0
	reserved								CID0							
Type	RO	RO	RO	RO	RO	RO	RO	RO	RO	RO	RO	RO	RO	RO	RO	RO
Reset	0	0	0	0	0	0	0	0	0	0	0	0	1	1	0	1

Bit/Field	Name	Type	Reset	Description
31:8	reserved	RO	0x0000.00	Software should not rely on the value of a reserved bit. To provide compatibility with future products, the value of a reserved bit should be preserved across a read-modify-write operation.
7:0	CID0	RO	0x0D	SSI PrimeCell ID Register [7:0]  Provides software a standard cross-peripheral identification system.

**Register 20: SSI PrimeCell Identification 1 (SSIPCellID1), offset 0xFF4**

The **SSIPCellIDn** registers are hard-coded, and the fields within the register determine the reset value.

## SSI PrimeCell Identification 1 (SSIPCellID1)

SSI0 base: 0x4000.8000

SSI1 base: 0x4000.9000

Offset 0xFF4

Type RO, reset 0x0000.00F0

	31	30	29	28	27	26	25	24	23	22	21	20	19	18	17	16
	reserved															
Type	RO	RO	RO	RO	RO	RO	RO	RO	RO	RO	RO	RO	RO	RO	RO	RO
Reset	0	0	0	0	0	0	0	0	0	0	0	0	0	0	0	0
	15	14	13	12	11	10	9	8	7	6	5	4	3	2	1	0
	reserved								CID1							
Type	RO	RO	RO	RO	RO	RO	RO	RO	RO	RO	RO	RO	RO	RO	RO	RO
Reset	0	0	0	0	0	0	0	0	1	1	1	1	0	0	0	0

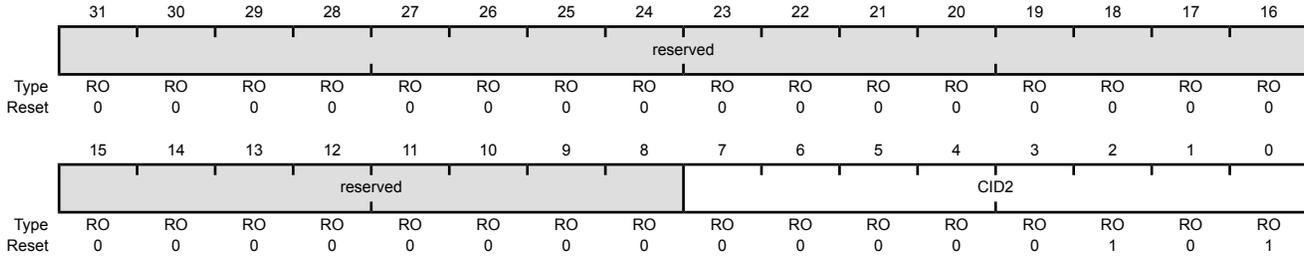
Bit/Field	Name	Type	Reset	Description
31:8	reserved	RO	0x0000.00	Software should not rely on the value of a reserved bit. To provide compatibility with future products, the value of a reserved bit should be preserved across a read-modify-write operation.
7:0	CID1	RO	0xF0	SSI PrimeCell ID Register [15:8] Provides software a standard cross-peripheral identification system.

### Register 21: SSI PrimeCell Identification 2 (SSIPCellID2), offset 0xFF8

The **SSIPCellIDn** registers are hard-coded, and the fields within the register determine the reset value.

#### SSI PrimeCell Identification 2 (SSIPCellID2)

SSI0 base: 0x4000.8000  
 SSI1 base: 0x4000.9000  
 Offset 0xFF8  
 Type RO, reset 0x0000.0005



Bit/Field	Name	Type	Reset	Description
31:8	reserved	RO	0x0000.00	Software should not rely on the value of a reserved bit. To provide compatibility with future products, the value of a reserved bit should be preserved across a read-modify-write operation.
7:0	CID2	RO	0x05	SSI PrimeCell ID Register [23:16] Provides software a standard cross-peripheral identification system.

**Register 22: SSI PrimeCell Identification 3 (SSIPCellID3), offset 0xFFC**

The **SSIPCellIDn** registers are hard-coded, and the fields within the register determine the reset value.

**SSI PrimeCell Identification 3 (SSIPCellID3)**

SSI0 base: 0x4000.8000  
 SSI1 base: 0x4000.9000  
 Offset 0xFFC  
 Type RO, reset 0x0000.00B1

	31	30	29	28	27	26	25	24	23	22	21	20	19	18	17	16
	reserved															
Type	RO	RO	RO	RO	RO	RO	RO	RO	RO	RO	RO	RO	RO	RO	RO	RO
Reset	0	0	0	0	0	0	0	0	0	0	0	0	0	0	0	0
	15	14	13	12	11	10	9	8	7	6	5	4	3	2	1	0
	reserved								CID3							
Type	RO	RO	RO	RO	RO	RO	RO	RO	RO	RO	RO	RO	RO	RO	RO	RO
Reset	0	0	0	0	0	0	0	0	1	0	1	1	0	0	0	1

Bit/Field	Name	Type	Reset	Description
31:8	reserved	RO	0x0000.00	Software should not rely on the value of a reserved bit. To provide compatibility with future products, the value of a reserved bit should be preserved across a read-modify-write operation.
7:0	CID3	RO	0xB1	SSI PrimeCell ID Register [31:24] Provides software a standard cross-peripheral identification system.

## 16 Inter-Integrated Circuit (I<sup>2</sup>C) Interface

The Inter-Integrated Circuit (I<sup>2</sup>C) bus provides bi-directional data transfer through a two-wire design (a serial data line SDA and a serial clock line SCL), and interfaces to external I<sup>2</sup>C devices such as serial memory (RAMs and ROMs), networking devices, LCDs, tone generators, and so on. The I<sup>2</sup>C bus may also be used for system testing and diagnostic purposes in product development and manufacture. The LM3S9B96 microcontroller includes two I<sup>2</sup>C modules, providing the ability to interact (both transmit and receive) with other I<sup>2</sup>C devices on the bus.

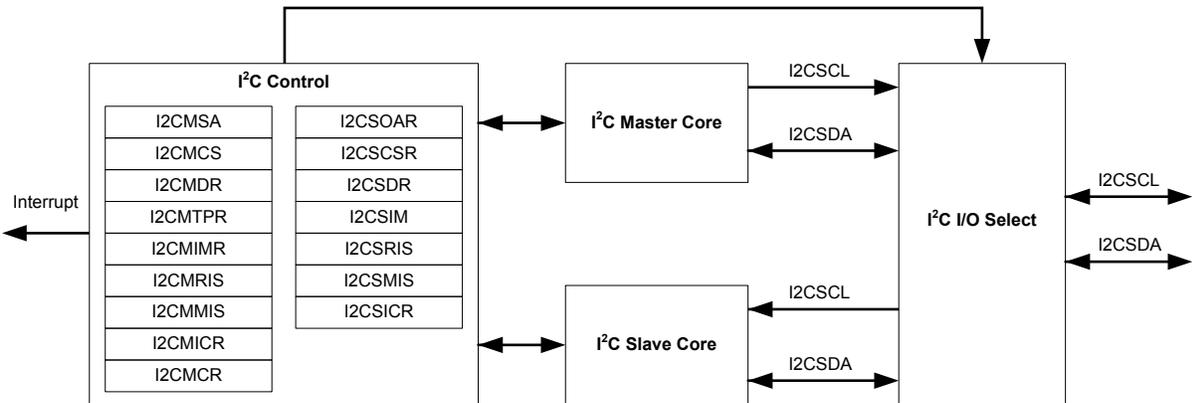
The Stellaris<sup>®</sup> LM3S9B96 controller includes two I<sup>2</sup>C modules with the following features:

- Devices on the I<sup>2</sup>C bus can be designated as either a master or a slave
  - Supports both transmitting and receiving data as either a master or a slave
  - Supports simultaneous master and slave operation
- Four I<sup>2</sup>C modes
  - Master transmit
  - Master receive
  - Slave transmit
  - Slave receive
- Two transmission speeds: Standard (100 Kbps) and Fast (400 Kbps)
- Master and slave interrupt generation
  - Master generates interrupts when a transmit or receive operation completes (or aborts due to an error)
  - Slave generates interrupts when data has been transferred or requested by a master or when a START or STOP condition is detected
- Master with arbitration and clock synchronization, multimaster support, and 7-bit addressing mode



## 16.1 Block Diagram

Figure 16-1. I<sup>2</sup>C Block Diagram



## 16.2 Signal Description

Table 16-1 on page 689 and Table 16-2 on page 689 list the external signals of the I<sup>2</sup>C interface and describe the function of each. The I<sup>2</sup>C interface signals are alternate functions for some GPIO signals and default to be GPIO signals at reset., with the exception of the I2C0SCL and I2CSDA pins which default to the I<sup>2</sup>C function. The column in the table below titled "Pin Mux/Pin Assignment" lists the possible GPIO pin placements for the I<sup>2</sup>C signals. The AFSEL bit in the **GPIO Alternate Function Select (GPIOAFSEL)** register (page 328) should be set to choose the I<sup>2</sup>C function. The number in parentheses is the encoding that must be programmed into the PMC<sub>n</sub> field in the **GPIO Port Control (GPIOPTL)** register (page 346) to assign the I<sup>2</sup>C signal to the specified GPIO port pin. Note that the I<sup>2</sup>C pins should be set to open drain using the **GPIO Open Drain Select (GPIOODR)** register. For more information on configuring GPIOs, see "General-Purpose Input/Outputs (GPIOs)" on page 304.

Table 16-1. Signals for I2C (100LQFP)

Pin Name	Pin Number	Pin Mux / Pin Assignment	Pin Type	Buffer Type <sup>a</sup>	Description
I2C0SCL	72	PB2 (1)	I/O	OD	I <sup>2</sup> C module 0 clock.
I2C0SDA	65	PB3 (1)	I/O	OD	I <sup>2</sup> C module 0 data.
I2C1SCL	14 19 26 34	PJ0 (11) PG0 (3) PA0 (8) PA6 (1)	I/O	OD	I <sup>2</sup> C module 1 clock.
I2C1SDA	18 27 35 87	PG1 (3) PA1 (8) PA7 (1) PJ1 (11)	I/O	OD	I <sup>2</sup> C module 1 data.

a. The TTL designation indicates the pin has TTL-compatible voltage levels.

Table 16-2. Signals for I2C (108BGA)

Pin Name	Pin Number	Pin Mux / Pin Assignment	Pin Type	Buffer Type <sup>a</sup>	Description
I2C0SCL	A11	PB2 (1)	I/O	OD	I <sup>2</sup> C module 0 clock.

Table 16-2. Signals for I<sup>2</sup>C (108BGA) (continued)

Pin Name	Pin Number	Pin Mux / Pin Assignment	Pin Type	Buffer Type <sup>a</sup>	Description
I2C0SDA	E11	PB3 (1)	I/O	OD	I <sup>2</sup> C module 0 data.
I2C1SCL	F3 K1 L3 L6	PJ0 (11) PG0 (3) PA0 (8) PA6 (1)	I/O	OD	I <sup>2</sup> C module 1 clock.
I2C1SDA	K2 M3 M6 B6	PG1 (3) PA1 (8) PA7 (1) PJ1 (11)	I/O	OD	I <sup>2</sup> C module 1 data.

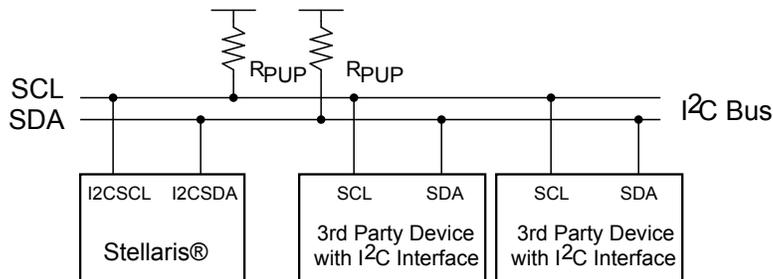
a. The TTL designation indicates the pin has TTL-compatible voltage levels.

## 16.3 Functional Description

Each I<sup>2</sup>C module is comprised of both master and slave functions which are implemented as separate peripherals. For proper operation, the SDA and SCL pins must be connected to bi-directional open-drain pads. A typical I<sup>2</sup>C bus configuration is shown in Figure 16-2.

See “Inter-Integrated Circuit (I<sup>2</sup>C) Interface” on page 1221 for I<sup>2</sup>C timing diagrams.

Figure 16-2. I<sup>2</sup>C Bus Configuration



### 16.3.1 I<sup>2</sup>C Bus Functional Overview

The I<sup>2</sup>C bus uses only two signals: SDA and SCL, named I2CSDA and I2CSCL on Stellaris<sup>®</sup> microcontrollers. SDA is the bi-directional serial data line and SCL is the bi-directional serial clock line. The bus is considered idle when both lines are High.

Every transaction on the I<sup>2</sup>C bus is nine bits long, consisting of eight data bits and a single acknowledge bit. The number of bytes per transfer (defined as the time between a valid START and STOP condition, described in “START and STOP Conditions” on page 690) is unrestricted, but each byte has to be followed by an acknowledge bit, and data must be transferred MSB first. When a receiver cannot receive another complete byte, it can hold the clock line SCL Low and force the transmitter into a wait state. The data transfer continues when the receiver releases the clock SCL.

#### 16.3.1.1 START and STOP Conditions

The protocol of the I<sup>2</sup>C bus defines two states to begin and end a transaction: START and STOP. A High-to-Low transition on the SDA line while the SCL is High is defined as a START condition, and a Low-to-High transition on the SDA line while SCL is High is defined as a STOP condition. The bus is considered busy after a START condition and free after a STOP condition. See Figure 16-3.

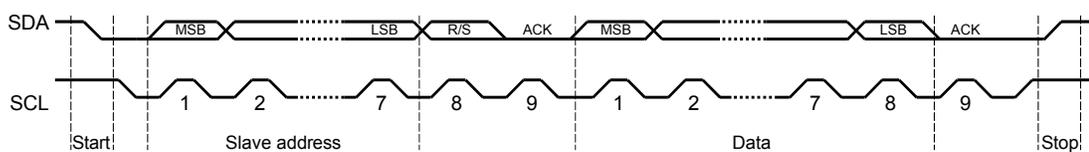
**Figure 16-3. START and STOP Conditions**

The STOP bit determines if the cycle stops at the end of the data cycle or continues on to a repeated START condition. To generate a single transmit cycle, the **I<sup>2</sup>C Master Slave Address (I2CMSA)** register is written with the desired address, the R/S bit is cleared, and the Control register is written with ACK=X (0 or 1), STOP=1, START=1, and RUN=1 to perform the operation and stop. When the operation is completed (or aborted due an error), the interrupt pin becomes active and the data may be read from the **I2CMDR** register. When the I<sup>2</sup>C module operates in Master receiver mode, the ACK bit is normally set causing the I<sup>2</sup>C bus controller to transmit an acknowledge automatically after each byte. This bit must be cleared when the I<sup>2</sup>C bus controller requires no further data to be transmitted from the slave transmitter.

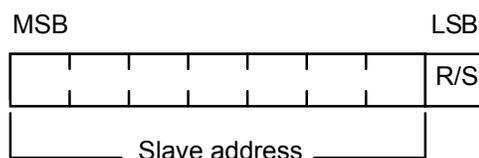
When operating in slave mode, two bits in the **I2CSRIS** register indicate detection of start and stop conditions on the bus; while two bits in the **I2CSMIS** register allow start and stop conditions to be promoted to controller interrupts (when interrupts are enabled).

### 16.3.1.2 Data Format with 7-Bit Address

Data transfers follow the format shown in Figure 16-4. After the START condition, a slave address is transmitted. This address is 7-bits long followed by an eighth bit, which is a data direction bit (R/S bit in the **I2CMSA** register). If the R/S bit is clear, it indicates a transmit operation (send), and if it is set, it indicates a request for data (receive). A data transfer is always terminated by a STOP condition generated by the master, however, a master can initiate communications with another device on the bus by generating a repeated START condition and addressing another slave without first generating a STOP condition. Various combinations of receive/transmit formats are then possible within a single transfer.

**Figure 16-4. Complete Data Transfer with a 7-Bit Address**

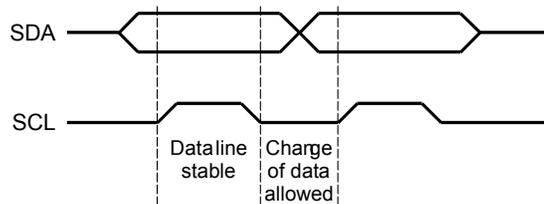
The first seven bits of the first byte make up the slave address (see Figure 16-5). The eighth bit determines the direction of the message. A zero in the R/S position of the first byte means that the master transmits (sends) data to the selected slave, and a one in this position means that the master receives data from the slave.

**Figure 16-5. R/S Bit in First Byte**

### 16.3.1.3 Data Validity

The data on the SDA line must be stable during the high period of the clock, and the data line can only change when SCL is Low (see Figure 16-6).

**Figure 16-6. Data Validity During Bit Transfer on the I<sup>2</sup>C Bus**



### 16.3.1.4 Acknowledge

All bus transactions have a required acknowledge clock cycle that is generated by the master. During the acknowledge cycle, the transmitter (which can be the master or slave) releases the SDA line. To acknowledge the transaction, the receiver must pull down SDA during the acknowledge clock cycle. The data transmitted out by the receiver during the acknowledge cycle must comply with the data validity requirements described in “Data Validity” on page 692.

When a slave receiver does not acknowledge the slave address, SDA must be left High by the slave so that the master can generate a STOP condition and abort the current transfer. If the master device is acting as a receiver during a transfer, it is responsible for acknowledging each transfer made by the slave. Because the master controls the number of bytes in the transfer, it signals the end of data to the slave transmitter by not generating an acknowledge on the last data byte. The slave transmitter must then release SDA to allow the master to generate the STOP or a repeated START condition.

### 16.3.1.5 Arbitration

A master may start a transfer only if the bus is idle. It's possible for two or more masters to generate a START condition within minimum hold time of the START condition. In these situations, an arbitration scheme takes place on the SDA line, while SCL is High. During arbitration, the first of the competing master devices to place a '1' (High) on SDA while another master transmits a '0' (Low) switches off its data output stage and retires until the bus is idle again.

Arbitration can take place over several bits. Its first stage is a comparison of address bits, and if both masters are trying to address the same device, arbitration continues on to the comparison of data bits.

## 16.3.2 Available Speed Modes

The I<sup>2</sup>C bus can run in either Standard mode (100 kbps) or Fast mode (400 kbps). The selected mode should match the speed of the other I<sup>2</sup>C devices on the bus. The mode is selected by using a value in the **I<sup>2</sup>C Master Timer Period (I2CMTPR)** register that results in an SCL frequency of 100 kbps for Standard mode or 400 kbps for Fast mode.

The I<sup>2</sup>C clock rate is determined by the parameters *CLK\_PRD*, *TIMER\_PRD*, *SCL\_LP*, and *SCL\_HP* where:

*CLK\_PRD* is the system clock period

*SCL\_LP* is the low phase of SCL (fixed at 6)

*SCL\_HP* is the high phase of SCL (fixed at 4)

**TIMER\_PRD** is the programmed value in the **I2CMTPR** register (see page 711).

The I<sup>2</sup>C clock period is calculated as follows:

$$SCL\_PERIOD = 2 \times (1 + TIMER\_PRD) \times (SCL\_LP + SCL\_HP) \times CLK\_PRD$$

For example:

$$CLK\_PRD = 50 \text{ ns}$$

$$TIMER\_PRD = 2$$

$$SCL\_LP=6$$

$$SCL\_HP=4$$

yields a SCL frequency of:

$$1/SCL\_PERIOD = 333 \text{ Khz}$$

Table 16-3 gives examples of the timer periods that should be used to generate both Standard and Fast mode SCL frequencies based on various system clock frequencies.

**Table 16-3. Examples of I<sup>2</sup>C Master Timer Period versus Speed Mode**

System Clock	Timer Period	Standard Mode	Timer Period	Fast Mode
4 MHz	0x01	100 Kbps	-	-
6 MHz	0x02	100 Kbps	-	-
12.5 MHz	0x06	89 Kbps	0x01	312 Kbps
16.7 MHz	0x08	93 Kbps	0x02	278 Kbps
20 MHz	0x09	100 Kbps	0x02	333 Kbps
25 MHz	0x0C	96.2 Kbps	0x03	312 Kbps
33 MHz	0x10	97.1 Kbps	0x04	330 Kbps
40 MHz	0x13	100 Kbps	0x04	400 Kbps
50 MHz	0x18	100 Kbps	0x06	357 Kbps
80 MHz	0x27	100 Kbps	0x09	400 Kbps

### 16.3.3 Interrupts

The I<sup>2</sup>C can generate interrupts when the following conditions are observed:

- Master transaction completed
- Master transaction error
- Slave transaction received
- Slave transaction requested
- Stop condition on bus detected
- Start condition on bus detected

The I<sup>2</sup>C master and I<sup>2</sup>C slave modules have separate interrupt signals. While both modules can generate interrupts for multiple conditions, only a single interrupt signal is sent to the interrupt controller.

### 16.3.3.1 I<sup>2</sup>C Master Interrupts

The I<sup>2</sup>C master module generates an interrupt when a transaction completes (either transmit or receive), or when an error occurs during a transaction. To enable the I<sup>2</sup>C master interrupt, software must set the `IM` bit in the **I<sup>2</sup>C Master Interrupt Mask (I2CMIMR)** register. When an interrupt condition is met, software must check the `ERROR` bit in the **I<sup>2</sup>C Master Control/Status (I2CMCS)** register to verify that an error didn't occur during the last transaction. An error condition is asserted if the last transaction wasn't acknowledged by the slave, or if the master was forced to give up ownership of the bus due to a lost arbitration round with another master. If an error is not detected, the application can proceed with the transfer. The interrupt is cleared by writing a 1 to the `IC` bit in the **I<sup>2</sup>C Master Interrupt Clear (I2CMICR)** register.

If the application doesn't require the use of interrupts, the raw interrupt status is always visible via the **I<sup>2</sup>C Master Raw Interrupt Status (I2CMRIS)** register.

### 16.3.3.2 I<sup>2</sup>C Slave Interrupts

The slave module can generate an interrupt when data has been received or requested. This interrupt is enabled by setting the `DATAIM` bit in the **I<sup>2</sup>C Slave Interrupt Mask (I2CSIMR)** register. Software determines whether the module should write (transmit) or read (receive) data from the **I<sup>2</sup>C Slave Data (I2CSDR)** register, by checking the `RREQ` and `TREQ` bits of the **I<sup>2</sup>C Slave Control/Status (I2CSCR)** register. If the slave module is in receive mode and the first byte of a transfer is received, the `FBR` bit is set along with the `RREQ` bit. The interrupt is cleared by setting the `DATAIC` bit in the **I<sup>2</sup>C Slave Interrupt Clear (I2CSICR)** register.

In addition, the slave module can generate an interrupt when a start and stop condition is detected. These interrupts are enabled by setting the `STARTIM` and `STOPIM` bits of the **I<sup>2</sup>C Slave Interrupt Mask (I2CSIMR)** register and cleared by writing a 1 to the `STOPIC` and `STARTIC` bits of the **I<sup>2</sup>C Slave Interrupt Clear (I2CSICR)** register.

If the application doesn't require the use of interrupts, the raw interrupt status is always visible via the **I<sup>2</sup>C Slave Raw Interrupt Status (I2CSRIS)** register.

### 16.3.4 Loopback Operation

The I<sup>2</sup>C modules can be placed into an internal loopback mode for diagnostic or debug work by setting the `LPBK` bit in the **I<sup>2</sup>C Master Configuration (I2CMCR)** register. In loopback mode, the SDA and SCL signals from the master and slave modules are tied together.

### 16.3.5 Command Sequence Flow Charts

This section details the steps required to perform the various I<sup>2</sup>C transfer types in both master and slave mode.

#### 16.3.5.1 I<sup>2</sup>C Master Command Sequences

The figures that follow show the command sequences available for the I<sup>2</sup>C master.

Figure 16-7. Master Single TRANSMIT

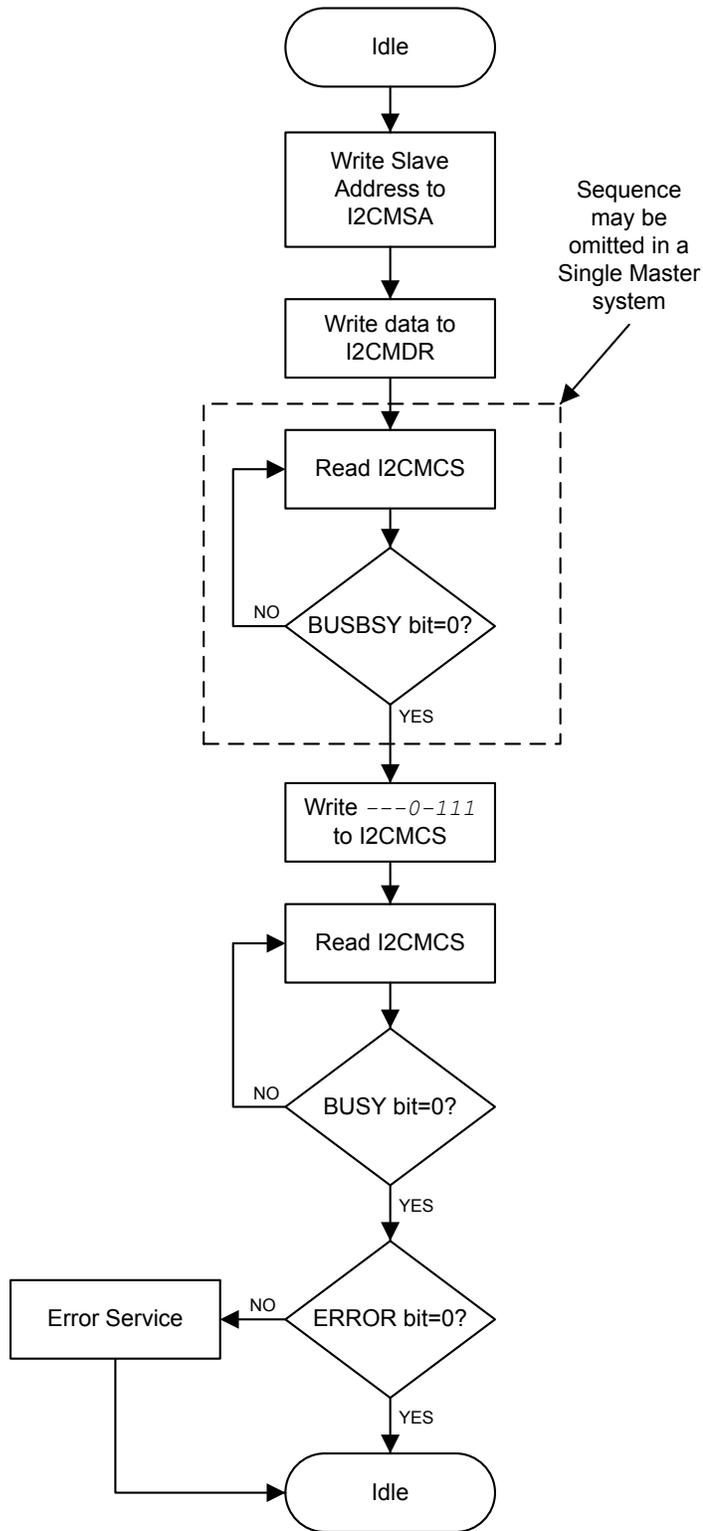


Figure 16-8. Master Single RECEIVE

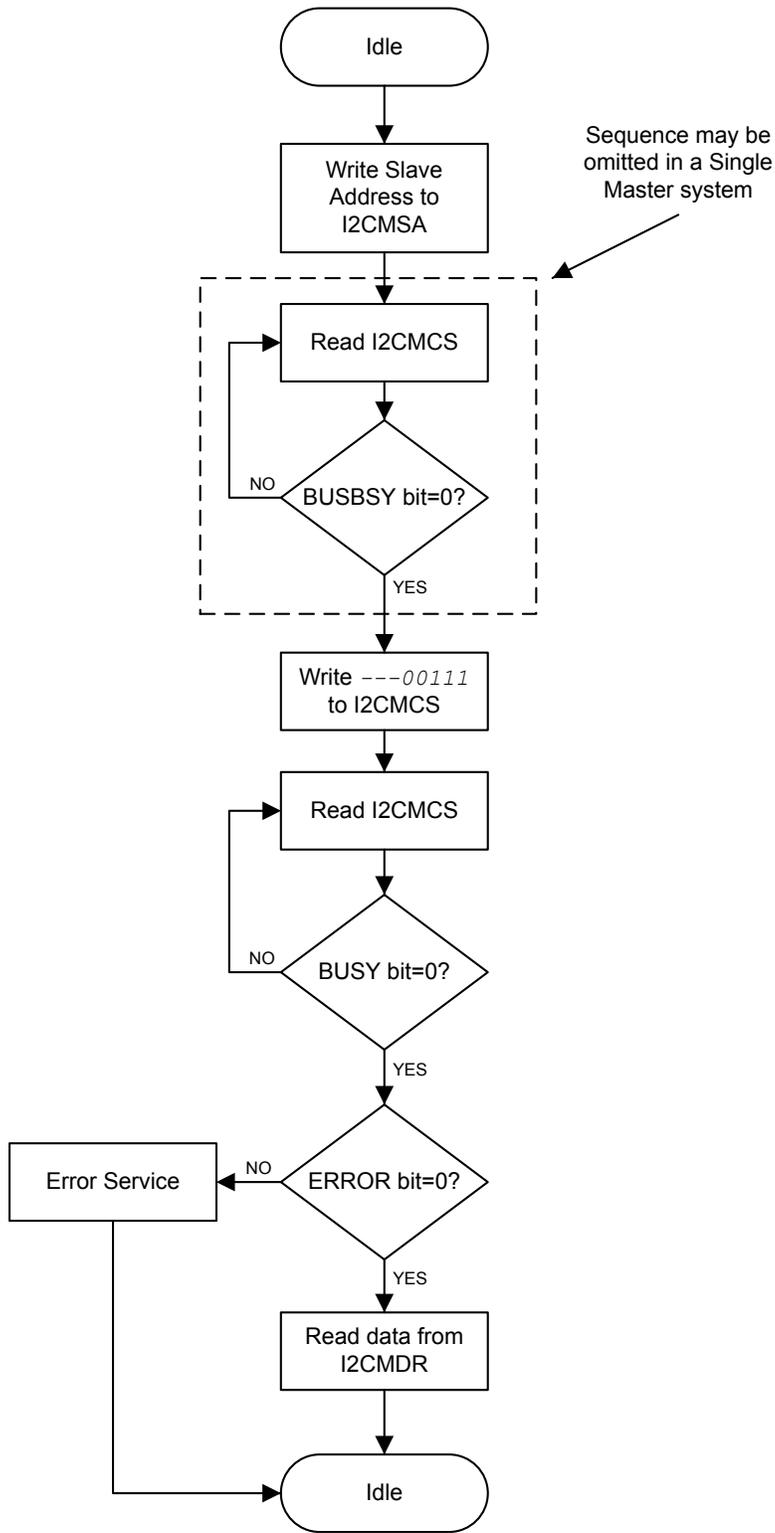




Figure 16-9. Master TRANSMIT with Repeated START

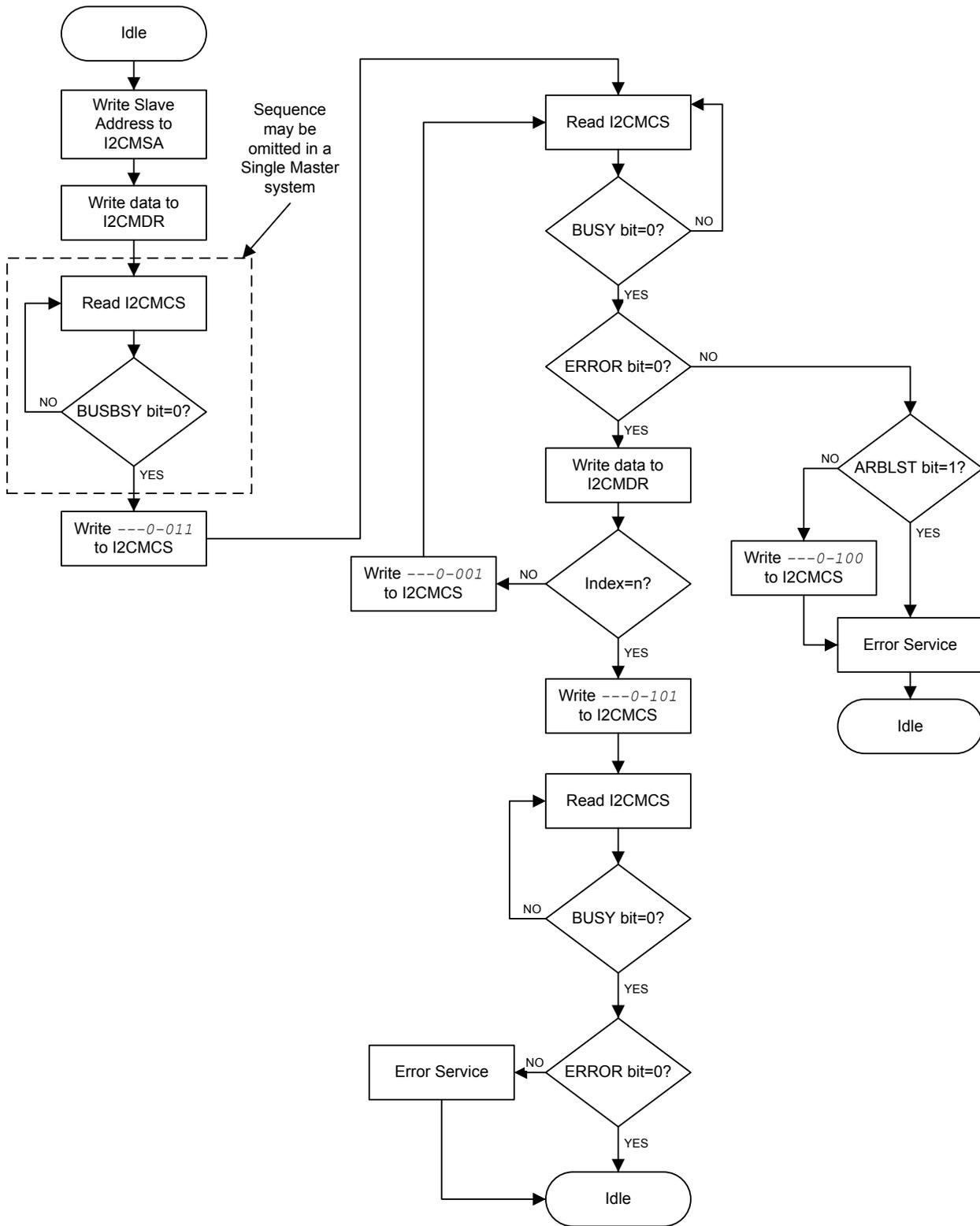


Figure 16-10. Master RECEIVE with Repeated START

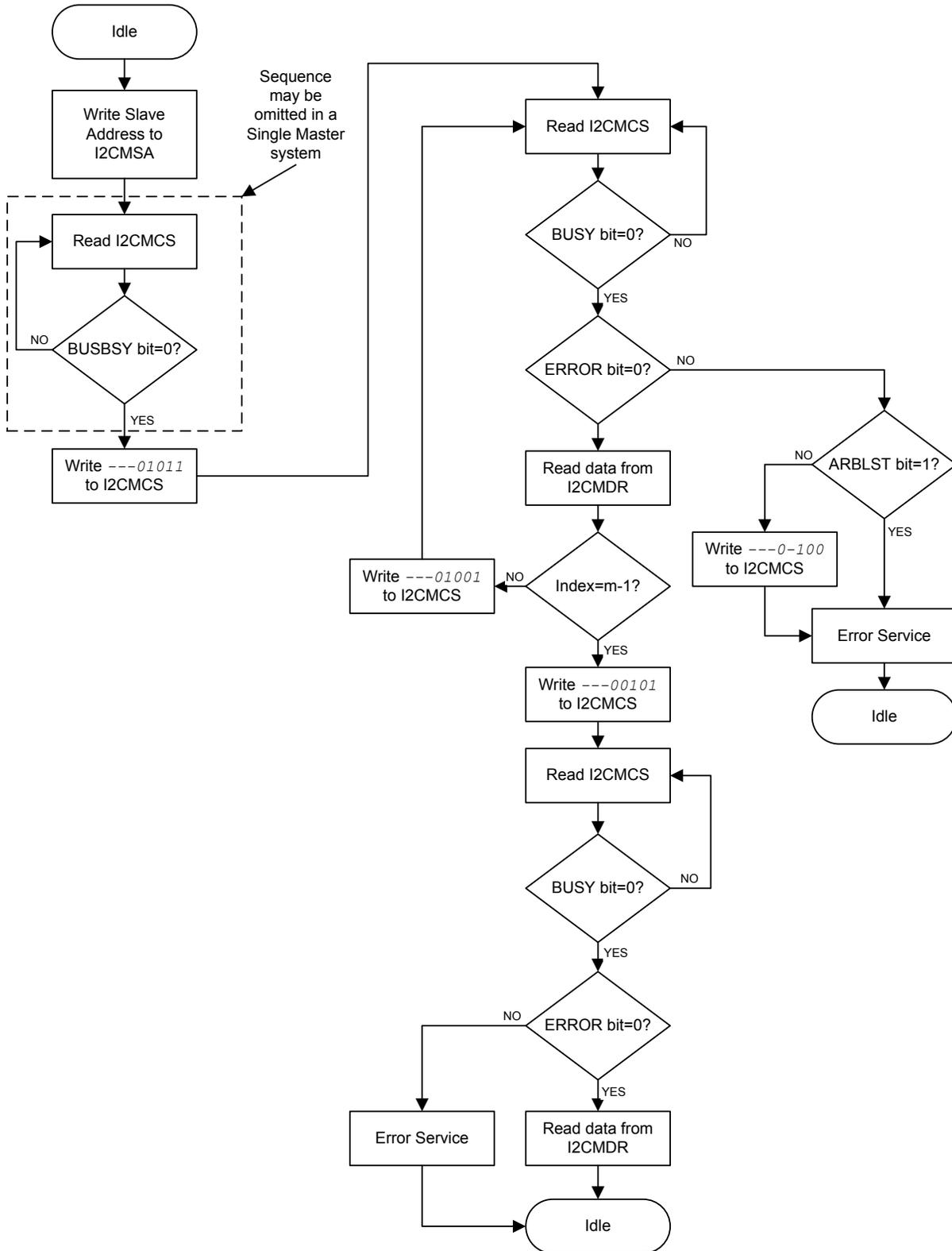


Figure 16-11. Master RECEIVE with Repeated START after TRANSMIT with Repeated START

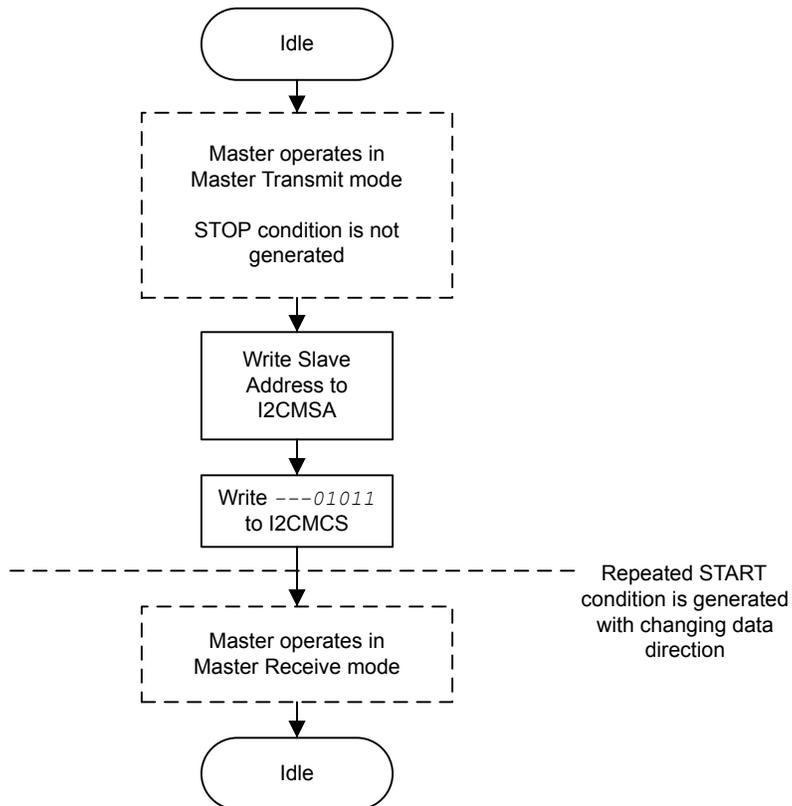
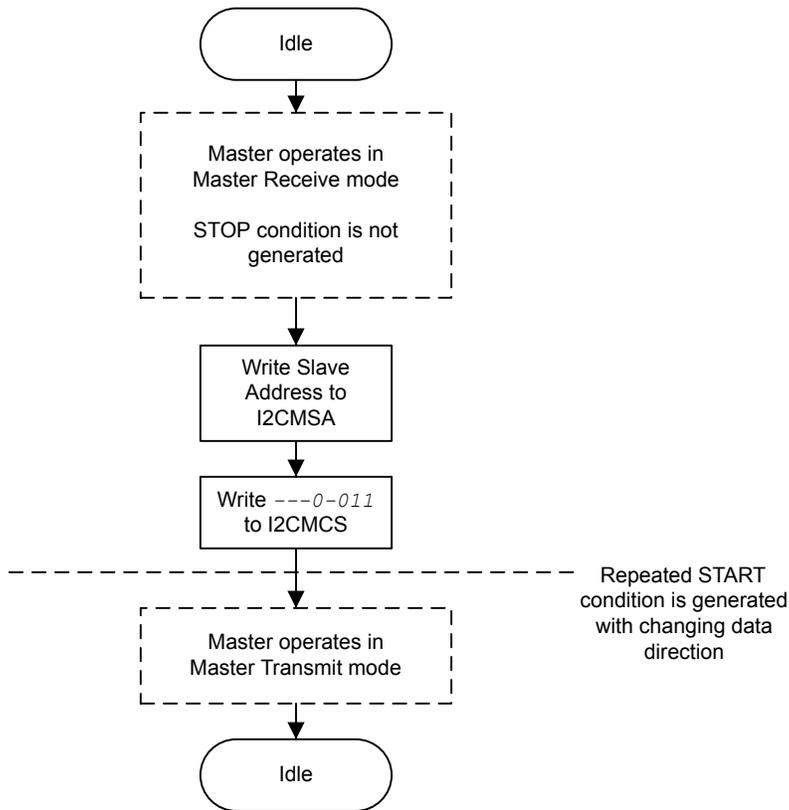


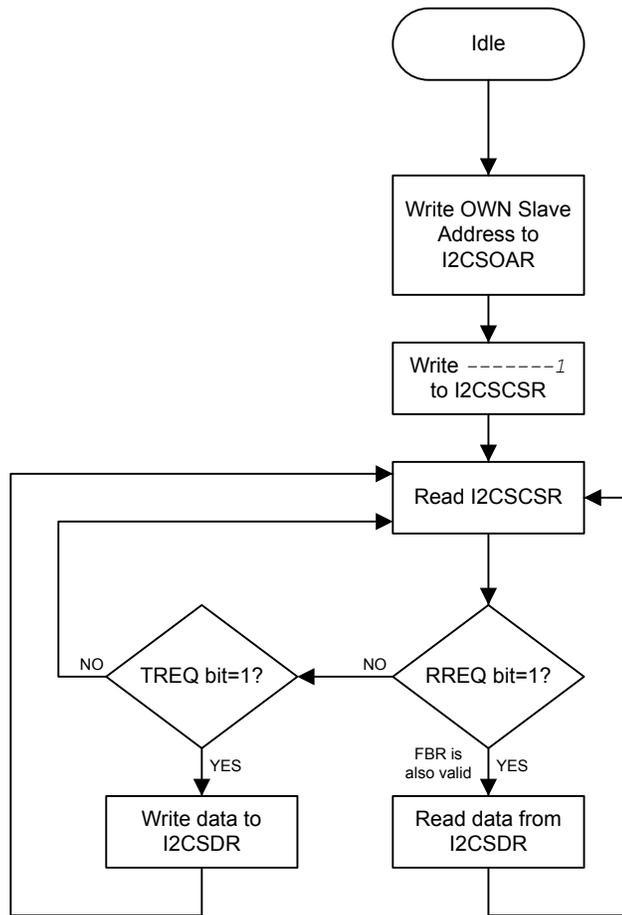
Figure 16-12. Master TRANSMIT with Repeated START after RECEIVE with Repeated START



### 16.3.5.2 I<sup>2</sup>C Slave Command Sequences

Figure 16-13 on page 701 presents the command sequence available for the I<sup>2</sup>C slave.

Figure 16-13. Slave Command Sequence



## 16.4 Initialization and Configuration

The following example shows how to configure the I<sup>2</sup>C module to transmit a single byte as a master. This assumes the system clock is 20 MHz.

1. Enable the I<sup>2</sup>C clock by writing a value of 0x0000.1000 to the **RCGC1** register in the System Control module (see page 181).
2. Enable the clock to the appropriate GPIO module via the **RCGC2** register in the System Control module (see page 193). To find out which GPIO port to enable, refer to Table 25-5 on page 1160.
3. In the GPIO module, enable the appropriate pins for their alternate function using the **GPIOAFSEL** register (see page 328). To determine which GPIOs to configure, see Table 25-4 on page 1151.
4. Enable the I<sup>2</sup>C pins for Open Drain operation. See page 333.
5. Configure the **PMC<sub>n</sub>** fields in the **GPIOPCTL** register to assign the I<sup>2</sup>C signals to the appropriate pins. See page 346 and Table 25-5 on page 1160.
6. Initialize the I<sup>2</sup>C Master by writing the **I2CMCR** register with a value of 0x0000.0010.

- Set the desired SCL clock speed of 100 Kbps by writing the **I2CMTPR** register with the correct value. The value written to the **I2CMTPR** register represents the number of system clock periods in one SCL clock period. The TPR value is determined by the following equation:

$$\begin{aligned} \text{TPR} &= (\text{System Clock} / (2 * (\text{SCL\_LP} + \text{SCL\_HP}) * \text{SCL\_CLK})) - 1; \\ \text{TPR} &= (20\text{MHz} / (2 * (6+4) * 100000)) - 1; \\ \text{TPR} &= 9 \end{aligned}$$

Write the **I2CMTPR** register with the value of 0x0000.0009.

- Specify the slave address of the master and that the next operation is a Transmit by writing the **I2CMSA** register with a value of 0x0000.0076. This sets the slave address to 0x3B.
- Place data (byte) to be transmitted in the data register by writing the **I2CMDR** register with the desired data.
- Initiate a single byte transmit of the data from Master to Slave by writing the **I2CMCS** register with a value of 0x0000.0007 (STOP, START, RUN).
- Wait until the transmission completes by polling the **I2CMCS** register's **BUSBSY** bit until it has been cleared.

## 16.5 Register Map

Table 16-4 on page 702 lists the I<sup>2</sup>C registers. All addresses given are relative to the I<sup>2</sup>C base addresses for the master and slave:

- I<sup>2</sup>C Master 0: 0x4002.0000
- I<sup>2</sup>C Slave 0: 0x4002.0800
- I<sup>2</sup>C Master 1: 0x4002.1000
- I<sup>2</sup>C Slave 1: 0x4002.1800

Note that the I<sup>2</sup>C module clock must be enabled before the registers can be programmed (see page 181).

**Table 16-4. Inter-Integrated Circuit (I<sup>2</sup>C) Interface Register Map**

Offset	Name	Type	Reset	Description	See page
<b>I<sup>2</sup>C Master</b>					
0x000	I2CMSA	R/W	0x0000.0000	I2C Master Slave Address	704
0x004	I2CMCS	R/W	0x0000.0000	I2C Master Control/Status	705
0x008	I2CMDR	R/W	0x0000.0000	I2C Master Data	710
0x00C	I2CMTPR	R/W	0x0000.0001	I2C Master Timer Period	711
0x010	I2CMIMR	R/W	0x0000.0000	I2C Master Interrupt Mask	712
0x014	I2CMRIS	RO	0x0000.0000	I2C Master Raw Interrupt Status	713
0x018	I2CMMIS	RO	0x0000.0000	I2C Master Masked Interrupt Status	714
0x01C	I2CMICR	WO	0x0000.0000	I2C Master Interrupt Clear	715
0x020	I2CMCR	R/W	0x0000.0000	I2C Master Configuration	716

**Table 16-4. Inter-Integrated Circuit (I<sup>2</sup>C) Interface Register Map (continued)**

Offset	Name	Type	Reset	Description	See page
<b>I<sup>2</sup>C Slave</b>					
0x000	I2CSOAR	R/W	0x0000.0000	I2C Slave Own Address	717
0x004	I2CSCSR	RO	0x0000.0000	I2C Slave Control/Status	718
0x008	I2CSDR	R/W	0x0000.0000	I2C Slave Data	720
0x00C	I2CSIMR	R/W	0x0000.0000	I2C Slave Interrupt Mask	721
0x010	I2CSRIS	RO	0x0000.0000	I2C Slave Raw Interrupt Status	722
0x014	I2CSMIS	RO	0x0000.0000	I2C Slave Masked Interrupt Status	723
0x018	I2CSICR	WO	0x0000.0000	I2C Slave Interrupt Clear	724

## 16.6 Register Descriptions (I<sup>2</sup>C Master)

The remainder of this section lists and describes the I<sup>2</sup>C master registers, in numerical order by address offset. See also “Register Descriptions (I<sup>2</sup>C Slave)” on page 716.

### Register 1: I<sup>2</sup>C Master Slave Address (I2CMSA), offset 0x000

This register consists of eight bits: seven address bits (A6-A0), and a Receive/Send bit, which determines if the next operation is a Receive (High), or Transmit (Low).

#### I2C Master Slave Address (I2CMSA)

I2C Master 0 base: 0x4002.0000

I2C Master 1 base: 0x4002.1000

Offset 0x000

Type R/W, reset 0x0000.0000

	31	30	29	28	27	26	25	24	23	22	21	20	19	18	17	16
	reserved															
Type	RO	RO	RO	RO	RO	RO	RO	RO	RO	RO	RO	RO	RO	RO	RO	RO
Reset	0	0	0	0	0	0	0	0	0	0	0	0	0	0	0	0
	15	14	13	12	11	10	9	8	7	6	5	4	3	2	1	0
	reserved								SA							R/S
Type	RO	RO	RO	RO	RO	RO	RO	RO	R/W	R/W	R/W	R/W	R/W	R/W	R/W	R/W
Reset	0	0	0	0	0	0	0	0	0	0	0	0	0	0	0	0

Bit/Field	Name	Type	Reset	Description						
31:8	reserved	RO	0x0000.00	Software should not rely on the value of a reserved bit. To provide compatibility with future products, the value of a reserved bit should be preserved across a read-modify-write operation.						
7:1	SA	R/W	0x00	I <sup>2</sup> C Slave Address  This field specifies bits A6 through A0 of the slave address.						
0	R/S	R/W	0	Receive/Send  The R/S bit specifies if the next operation is a Receive (High) or Transmit (Low).  <table border="1" style="margin-left: 20px;"> <thead> <tr> <th>Value</th> <th>Description</th> </tr> </thead> <tbody> <tr> <td>0</td> <td>Transmit</td> </tr> <tr> <td>1</td> <td>Receive</td> </tr> </tbody> </table>	Value	Description	0	Transmit	1	Receive
Value	Description									
0	Transmit									
1	Receive									



## Register 2: I<sup>2</sup>C Master Control/Status (I2CMCS), offset 0x004

This register accesses seven status bits when read and four control bits when written.

The status register consists of seven bits, which when read determine the state of the I<sup>2</sup>C bus controller.

The control register consists of four bits: the RUN, START, STOP, and ACK bits. The START bit generates the START or REPEATED START condition.

The STOP bit determines if the cycle stops at the end of the data cycle or continues on to a repeated START condition. To generate a single transmit cycle, the **I<sup>2</sup>C Master Slave Address (I2CMSA)** register is written with the desired address, the R/S bit is cleared, and the Control register is written with ACK=X (0 or 1), STOP=1, START=1, and RUN=1 to perform the operation and stop. When the operation is completed (or aborted due an error), the interrupt pin becomes active and the data may be read from the **I2CMDR** register. When the I<sup>2</sup>C module operates in Master receiver mode, the ACK bit is normally set causing the I<sup>2</sup>C bus controller to transmit an acknowledge automatically after each byte. This bit must be cleared when the I<sup>2</sup>C bus controller requires no further data to be transmitted from the slave transmitter.

### Read-Only Status Register

#### I2C Master Control/Status (I2CMCS)

I2C Master 0 base: 0x4002.0000

I2C Master 1 base: 0x4002.1000

Offset 0x004

Type RO, reset 0x0000.0000

	31	30	29	28	27	26	25	24	23	22	21	20	19	18	17	16	
	reserved																
Type	RO	RO	RO	RO	RO	RO	RO	RO	RO	RO	RO	RO	RO	RO	RO	RO	
Reset	0	0	0	0	0	0	0	0	0	0	0	0	0	0	0	0	
	15	14	13	12	11	10	9	8	7	6	5	4	3	2	1	0	
	reserved										BUSBSY	IDLE	ARBLST	DATACK	ADRACK	ERROR	BUSY
Type	RO	RO	RO	RO	RO	RO	RO	RO	RO	RO	RO	RO	RO	RO	RO	RO	
Reset	0	0	0	0	0	0	0	0	0	0	0	0	0	0	0	0	

Bit/Field	Name	Type	Reset	Description
31:7	reserved	RO	0x0000.00	Software should not rely on the value of a reserved bit. To provide compatibility with future products, the value of a reserved bit should be preserved across a read-modify-write operation.
6	BUSBSY	RO	0	Bus Busy  Value Description 0 The I <sup>2</sup> C bus is idle. 1 The I <sup>2</sup> C bus is busy.  The bit changes based on the START and STOP conditions.
5	IDLE	RO	0	I <sup>2</sup> C Idle  Value Description 0 The I <sup>2</sup> C controller is not idle. 1 The I <sup>2</sup> C controller is idle.

Bit/Field	Name	Type	Reset	Description
4	ARBLST	RO	0	Arbitration Lost  Value Description 0 The I <sup>2</sup> C controller won arbitration. 1 The I <sup>2</sup> C controller lost arbitration.
3	DATAACK	RO	0	Acknowledge Data  Value Description 0 The transmitted data was acknowledged 1 The transmitted data was not acknowledged.
2	ADRACK	RO	0	Acknowledge Address  Value Description 0 The transmitted address was acknowledged 1 The transmitted address was not acknowledged.
1	ERROR	RO	0	Error  Value Description 0 No error was detected on the last operation. 1 An error occurred on the last operation.  The error can be from the slave address not being acknowledged, the transmit data not being acknowledged, or because the controller lost arbitration.
0	BUSY	RO	0	I <sup>2</sup> C Busy  Value Description 0 The controller is idle. 1 The controller is busy.  When the <code>BUSY</code> bit is set, the other status bits are not valid.

## Write-Only Control Register

### I2C Master Control/Status (I2CMCS)

I2C Master 0 base: 0x4002.0000

I2C Master 1 base: 0x4002.1000

Offset 0x004

Type WO, reset 0x0000.0000

	31	30	29	28	27	26	25	24	23	22	21	20	19	18	17	16
	reserved															
Type	WO	WO	WO	WO	WO	WO	WO	WO	WO	WO	WO	WO	WO	WO	WO	WO
Reset	0	0	0	0	0	0	0	0	0	0	0	0	0	0	0	0
	15	14	13	12	11	10	9	8	7	6	5	4	3	2	1	0
	reserved												ACK	STOP	START	RUN
Type	WO	WO	WO	WO	WO	WO	WO	WO	WO	WO	WO	WO	WO	WO	WO	WO
Reset	0	0	0	0	0	0	0	0	0	0	0	0	0	0	0	0

Bit/Field	Name	Type	Reset	Description
31:4	reserved	WO	0x0000.000	Software should not rely on the value of a reserved bit. To provide compatibility with future products, the value of a reserved bit should be preserved across a read-modify-write operation.
3	ACK	WO	0	Data Acknowledge Enable  Value Description 0 The received data byte is not acknowledged automatically by the master. 1 The received data byte is acknowledged automatically by the master. See field decoding in Table 16-5 on page 708.
2	STOP	WO	0	Generate STOP  Value Description 0 The controller does not generate the STOP condition. 1 The controller generates the STOP condition. See field decoding in Table 16-5 on page 708.
1	START	WO	0	Generate START  Value Description 0 The controller does not generate the START condition. 1 The controller generates the START or repeated START condition. See field decoding in Table 16-5 on page 708.
0	RUN	WO	0	I <sup>2</sup> C Master Enable  Value Description 0 The master is disabled. 1 The master is enabled to transmit or receive data. See field decoding in Table 16-5 on page 708.

Table 16-5. Write Field Decoding for I2CMCS[3:0] Field

Current State	I2CMSA[0]	I2CMCS[3:0]				Description
	R/S	ACK	STOP	START	RUN	
Idle	0	X <sup>a</sup>	0	1	1	START condition followed by TRANSMIT (master goes to the Master Transmit state).
	0	X	1	1	1	START condition followed by a TRANSMIT and STOP condition (master remains in Idle state).
	1	0	0	1	1	START condition followed by RECEIVE operation with negative ACK (master goes to the Master Receive state).
	1	0	1	1	1	START condition followed by RECEIVE and STOP condition (master remains in Idle state).
	1	1	0	1	1	START condition followed by RECEIVE (master goes to the Master Receive state).
	1	1	1	1	1	Illegal
	All other combinations not listed are non-operations.					NOP
Master Transmit	X	X	0	0	1	TRANSMIT operation (master remains in Master Transmit state).
	X	X	1	0	0	STOP condition (master goes to Idle state).
	X	X	1	0	1	TRANSMIT followed by STOP condition (master goes to Idle state).
	0	X	0	1	1	Repeated START condition followed by a TRANSMIT (master remains in Master Transmit state).
	0	X	1	1	1	Repeated START condition followed by TRANSMIT and STOP condition (master goes to Idle state).
	1	0	0	1	1	Repeated START condition followed by a RECEIVE operation with a negative ACK (master goes to Master Receive state).
	1	0	1	1	1	Repeated START condition followed by a TRANSMIT and STOP condition (master goes to Idle state).
	1	1	0	1	1	Repeated START condition followed by RECEIVE (master goes to Master Receive state).
	1	1	1	1	1	Illegal.
All other combinations not listed are non-operations.					NOP.	

Table 16-5. Write Field Decoding for I2CMCS[3:0] Field (continued)

Current State	I2CMSA[0]	I2CMCS[3:0]				Description
	R/S	ACK	STOP	START	RUN	
Master Receive	X	0	0	0	1	RECEIVE operation with negative ACK (master remains in Master Receive state).
	X	X	1	0	0	STOP condition (master goes to Idle state). <sup>b</sup>
	X	0	1	0	1	RECEIVE followed by STOP condition (master goes to Idle state).
	X	1	0	0	1	RECEIVE operation (master remains in Master Receive state).
	X	1	1	0	1	Illegal.
	1	0	0	1	1	Repeated START condition followed by RECEIVE operation with a negative ACK (master remains in Master Receive state).
	1	0	1	1	1	Repeated START condition followed by RECEIVE and STOP condition (master goes to Idle state).
	1	1	0	1	1	Repeated START condition followed by RECEIVE (master remains in Master Receive state).
	0	X	0	1	1	Repeated START condition followed by TRANSMIT (master goes to Master Transmit state).
	0	X	1	1	1	Repeated START condition followed by TRANSMIT and STOP condition (master goes to Idle state).
	All other combinations not listed are non-operations.					

a. An X in a table cell indicates the bit can be 0 or 1.

b. In Master Receive mode, a STOP condition should be generated only after a Data Negative Acknowledge executed by the master or an Address Negative Acknowledge executed by the slave.

### Register 3: I<sup>2</sup>C Master Data (I2CMDR), offset 0x008

**Important:** Use caution when reading this register. Performing a read may change bit status.

This register contains the data to be transmitted when in the Master Transmit state and the data received when in the Master Receive state.

#### I2C Master Data (I2CMDR)

I2C Master 0 base: 0x4002.0000

I2C Master 1 base: 0x4002.1000

Offset 0x008

Type R/W, reset 0x0000.0000

	31	30	29	28	27	26	25	24	23	22	21	20	19	18	17	16
	reserved															
Type	RO	RO	RO	RO	RO	RO	RO	RO	RO	RO	RO	RO	RO	RO	RO	RO
Reset	0	0	0	0	0	0	0	0	0	0	0	0	0	0	0	0
	15	14	13	12	11	10	9	8	7	6	5	4	3	2	1	0
	reserved								DATA							
Type	RO	RO	RO	RO	RO	RO	RO	RO	R/W	R/W	R/W	R/W	R/W	R/W	R/W	R/W
Reset	0	0	0	0	0	0	0	0	0	0	0	0	0	0	0	0

Bit/Field	Name	Type	Reset	Description
31:8	reserved	RO	0x0000.00	Software should not rely on the value of a reserved bit. To provide compatibility with future products, the value of a reserved bit should be preserved across a read-modify-write operation.
7:0	DATA	R/W	0x00	Data Transferred Data transferred during transaction.

**Register 4: I<sup>2</sup>C Master Timer Period (I2CMTPR), offset 0x00C**

This register specifies the period of the SCL clock.

**Caution – Take care not to set bit 7 when accessing this register as unpredictable behavior can occur.**

**I2C Master Timer Period (I2CMTPR)**

I2C Master 0 base: 0x4002.0000

I2C Master 1 base: 0x4002.1000

Offset 0x00C

Type R/W, reset 0x0000.0001

	31	30	29	28	27	26	25	24	23	22	21	20	19	18	17	16
	reserved															
Type	RO	RO	RO	RO	RO	RO	RO	RO	RO	RO	RO	RO	RO	RO	RO	RO
Reset	0	0	0	0	0	0	0	0	0	0	0	0	0	0	0	0
	15	14	13	12	11	10	9	8	7	6	5	4	3	2	1	0
	reserved									TPR						
Type	RO	RO	RO	RO	RO	RO	RO	RO	RO	R/W	R/W	R/W	R/W	R/W	R/W	R/W
Reset	0	0	0	0	0	0	0	0	0	0	0	0	0	0	0	1

Bit/Field	Name	Type	Reset	Description
31:7	reserved	RO	0x0000.00	Software should not rely on the value of a reserved bit. To provide compatibility with future products, the value of a reserved bit should be preserved across a read-modify-write operation.

6:0	TPR	R/W	0x1	SCL Clock Period
-----	-----	-----	-----	------------------

This field specifies the period of the SCL clock.

$$SCL\_PRD = 2 \times (1 + TPR) \times (SCL\_LP + SCL\_HP) \times CLK\_PRD$$

where:

*SCL\_PRD* is the SCL line period (I<sup>2</sup>C clock).

*TPR* is the Timer Period register value (range of 1 to 127).

*SCL\_LP* is the SCL Low period (fixed at 6).

*SCL\_HP* is the SCL High period (fixed at 4).

*CLK\_PRD* is the system clock period in ns.

## Register 5: I<sup>2</sup>C Master Interrupt Mask (I2CMIMR), offset 0x010

This register controls whether a raw interrupt is promoted to a controller interrupt.

### I2C Master Interrupt Mask (I2CMIMR)

I2C Master 0 base: 0x4002.0000

I2C Master 1 base: 0x4002.1000

Offset 0x010

Type R/W, reset 0x0000.0000

	31	30	29	28	27	26	25	24	23	22	21	20	19	18	17	16	
	reserved																
Type	RO	RO	RO	RO	RO	RO	RO	RO	RO	RO	RO	RO	RO	RO	RO	RO	
Reset	0	0	0	0	0	0	0	0	0	0	0	0	0	0	0	0	
	15	14	13	12	11	10	9	8	7	6	5	4	3	2	1	0	
	reserved															IM	
Type	RO	RO	RO	RO	RO	RO	RO	RO	RO	RO	RO	RO	RO	RO	RO	RO	R/W
Reset	0	0	0	0	0	0	0	0	0	0	0	0	0	0	0	0	0

Bit/Field	Name	Type	Reset	Description
31:1	reserved	RO	0x0000.000	Software should not rely on the value of a reserved bit. To provide compatibility with future products, the value of a reserved bit should be preserved across a read-modify-write operation.
0	IM	R/W	0	Interrupt Mask

Value	Description
1	The master interrupt is sent to the interrupt controller when the RIS bit in the <b>I2CMRIS</b> register is set.
0	The RIS interrupt is suppressed and not sent to the interrupt controller.



## Register 6: I<sup>2</sup>C Master Raw Interrupt Status (I2CMRIS), offset 0x014

This register specifies whether an interrupt is pending.

### I2C Master Raw Interrupt Status (I2CMRIS)

I2C Master 0 base: 0x4002.0000

I2C Master 1 base: 0x4002.1000

Offset 0x014

Type RO, reset 0x0000.0000

	31	30	29	28	27	26	25	24	23	22	21	20	19	18	17	16
	reserved															
Type	RO	RO	RO	RO	RO	RO	RO	RO	RO	RO	RO	RO	RO	RO	RO	RO
Reset	0	0	0	0	0	0	0	0	0	0	0	0	0	0	0	0
	15	14	13	12	11	10	9	8	7	6	5	4	3	2	1	0
	reserved															RIS
Type	RO	RO	RO	RO	RO	RO	RO	RO	RO	RO	RO	RO	RO	RO	RO	RO
Reset	0	0	0	0	0	0	0	0	0	0	0	0	0	0	0	0

Bit/Field	Name	Type	Reset	Description
31:1	reserved	RO	0x0000.000	Software should not rely on the value of a reserved bit. To provide compatibility with future products, the value of a reserved bit should be preserved across a read-modify-write operation.
0	RIS	RO	0	Raw Interrupt Status

Value	Description
1	A master interrupt is pending.
0	No interrupt.

This bit is cleared by writing a 1 to the IC bit in the I2CMICR register.

## Register 7: I<sup>2</sup>C Master Masked Interrupt Status (I2CMMIS), offset 0x018

This register specifies whether an interrupt was signaled.

### I2C Master Masked Interrupt Status (I2CMMIS)

I2C Master 0 base: 0x4002.0000

I2C Master 1 base: 0x4002.1000

Offset 0x018

Type RO, reset 0x0000.0000

	31	30	29	28	27	26	25	24	23	22	21	20	19	18	17	16
	reserved															
Type	RO	RO	RO	RO	RO	RO	RO	RO	RO	RO	RO	RO	RO	RO	RO	RO
Reset	0	0	0	0	0	0	0	0	0	0	0	0	0	0	0	0
	15	14	13	12	11	10	9	8	7	6	5	4	3	2	1	0
	reserved															
Type	RO	RO	RO	RO	RO	RO	RO	RO	RO	RO	RO	RO	RO	RO	RO	RO
Reset	0	0	0	0	0	0	0	0	0	0	0	0	0	0	0	MIS

Bit/Field	Name	Type	Reset	Description
31:1	reserved	RO	0x0000.000	Software should not rely on the value of a reserved bit. To provide compatibility with future products, the value of a reserved bit should be preserved across a read-modify-write operation.
0	MIS	RO	0	Masked Interrupt Status

**Value Description**

- 1 An unmasked master interrupt was signaled is pending.
- 0 An interrupt has not occurred or is masked.

This bit is cleared by writing a 1 to the IC bit in the I2CMICR register.

## Register 8: I<sup>2</sup>C Master Interrupt Clear (I2CMICR), offset 0x01C

This register clears the raw interrupt.

### I2C Master Interrupt Clear (I2CMICR)

I2C Master 0 base: 0x4002.0000

I2C Master 1 base: 0x4002.1000

Offset 0x01C

Type WO, reset 0x0000.0000

	31	30	29	28	27	26	25	24	23	22	21	20	19	18	17	16	
	reserved																
Type	RO	RO	RO	RO	RO	RO	RO	RO	RO	RO	RO	RO	RO	RO	RO	RO	
Reset	0	0	0	0	0	0	0	0	0	0	0	0	0	0	0	0	
	15	14	13	12	11	10	9	8	7	6	5	4	3	2	1	0	
	reserved															IC	
Type	RO	RO	RO	RO	RO	RO	RO	RO	RO	RO	RO	RO	RO	RO	RO	RO	WO
Reset	0	0	0	0	0	0	0	0	0	0	0	0	0	0	0	0	0

Bit/Field	Name	Type	Reset	Description
31:1	reserved	RO	0x0000.000	Software should not rely on the value of a reserved bit. To provide compatibility with future products, the value of a reserved bit should be preserved across a read-modify-write operation.
0	IC	WO	0	<p>Interrupt Clear</p> <p>Writing a 1 to this bit clears the <b>RIS</b> bit in the <b>I2CMRIS</b> register and the <b>MIS</b> bit in the <b>I2CMMIS</b> register.</p> <p>A read of this register returns no meaningful data.</p>

## Register 9: I<sup>2</sup>C Master Configuration (I2CMCR), offset 0x020

This register configures the mode (Master or Slave) and sets the interface for test mode loopback.

### I2C Master Configuration (I2CMCR)

I2C Master 0 base: 0x4002.0000

I2C Master 1 base: 0x4002.1000

Offset 0x020

Type R/W, reset 0x0000.0000

	31	30	29	28	27	26	25	24	23	22	21	20	19	18	17	16	
	reserved																
Type	RO	RO	RO	RO	RO	RO	RO	RO	RO	RO	RO	RO	RO	RO	RO	RO	
Reset	0	0	0	0	0	0	0	0	0	0	0	0	0	0	0	0	
	15	14	13	12	11	10	9	8	7	6	5	4	3	2	1	0	
	reserved											SFE	MFE	reserved		LPBK	
Type	RO	RO	RO	RO	RO	RO	RO	RO	RO	RO	RO	R/W	R/W	RO	RO	RO	R/W
Reset	0	0	0	0	0	0	0	0	0	0	0	0	0	0	0	0	0

Bit/Field	Name	Type	Reset	Description
31:6	reserved	RO	0x0000.00	Software should not rely on the value of a reserved bit. To provide compatibility with future products, the value of a reserved bit should be preserved across a read-modify-write operation.
5	SFE	R/W	0	I <sup>2</sup> C Slave Function Enable  Value Description 1 Slave mode is enabled. 0 Slave mode is disabled.
4	MFE	R/W	0	I <sup>2</sup> C Master Function Enable  Value Description 1 Master mode is enabled. 0 Master mode is disabled.
3:1	reserved	RO	0x0	Software should not rely on the value of a reserved bit. To provide compatibility with future products, the value of a reserved bit should be preserved across a read-modify-write operation.
0	LPBK	R/W	0	I <sup>2</sup> C Loopback  Value Description 1 The controller in a test mode loopback configuration. 0 Normal operation.

## 16.7 Register Descriptions (I<sup>2</sup>C Slave)

The remainder of this section lists and describes the I<sup>2</sup>C slave registers, in numerical order by address offset. See also “Register Descriptions (I<sup>2</sup>C Master)” on page 703.

## Register 10: I<sup>2</sup>C Slave Own Address (I2CSOAR), offset 0x000

This register consists of seven address bits that identify the Stellaris® I<sup>2</sup>C device on the I<sup>2</sup>C bus.

### I2C Slave Own Address (I2CSOAR)

I2C Slave 0 base: 0x4002.0800

I2C Slave 1 base: 0x4002.1800

Offset 0x000

Type R/W, reset 0x0000.0000

	31	30	29	28	27	26	25	24	23	22	21	20	19	18	17	16
	reserved															
Type	RO	RO	RO	RO	RO	RO	RO	RO	RO	RO	RO	RO	RO	RO	RO	RO
Reset	0	0	0	0	0	0	0	0	0	0	0	0	0	0	0	0
	15	14	13	12	11	10	9	8	7	6	5	4	3	2	1	0
	reserved									OAR						
Type	RO	RO	RO	RO	RO	RO	RO	RO	RO	R/W	R/W	R/W	R/W	R/W	R/W	R/W
Reset	0	0	0	0	0	0	0	0	0	0	0	0	0	0	0	0

Bit/Field	Name	Type	Reset	Description
31:7	reserved	RO	0x0000.00	Software should not rely on the value of a reserved bit. To provide compatibility with future products, the value of a reserved bit should be preserved across a read-modify-write operation.
6:0	OAR	R/W	0x00	I <sup>2</sup> C Slave Own Address This field specifies bits A6 through A0 of the slave address.

### Register 11: I<sup>2</sup>C Slave Control/Status (I2CSCSR), offset 0x004

This register accesses one control bit when written, and three status bits when read.

The read-only Status register consists of three bits: the FBR, RREQ, and TREQ bits. The First Byte Received (FBR) bit is set only after the Stellaris<sup>®</sup> device detects its own slave address and receives the first data byte from the I<sup>2</sup>C master. The Receive Request (RREQ) bit indicates that the Stellaris<sup>®</sup> I<sup>2</sup>C device has received a data byte from an I<sup>2</sup>C master. Read one data byte from the **I<sup>2</sup>C Slave Data (I2CSDR)** register to clear the RREQ bit. The Transmit Request (TREQ) bit indicates that the Stellaris<sup>®</sup> I<sup>2</sup>C device is addressed as a Slave Transmitter. Write one data byte into the **I<sup>2</sup>C Slave Data (I2CSDR)** register to clear the TREQ bit.

The write-only Control register consists of one bit: the DA bit. The DA bit enables and disables the Stellaris<sup>®</sup> I<sup>2</sup>C slave operation.

#### Read-Only Status Register

##### I2C Slave Control/Status (I2CSCSR)

I2C Slave 0 base: 0x4002.0800

I2C Slave 1 base: 0x4002.1800

Offset 0x004

Type RO, reset 0x0000.0000

	31	30	29	28	27	26	25	24	23	22	21	20	19	18	17	16
	reserved															
Type	RO	RO	RO	RO	RO	RO	RO	RO	RO	RO	RO	RO	RO	RO	RO	RO
Reset	0	0	0	0	0	0	0	0	0	0	0	0	0	0	0	0
	15	14	13	12	11	10	9	8	7	6	5	4	3	2	1	0
	reserved													FBR	TREQ	RREQ
Type	RO	RO	RO	RO	RO	RO	RO	RO	RO	RO	RO	RO	RO	RO	RO	RO
Reset	0	0	0	0	0	0	0	0	0	0	0	0	0	0	0	0

Bit/Field	Name	Type	Reset	Description
31:3	reserved	RO	0x0000.000	Software should not rely on the value of a reserved bit. To provide compatibility with future products, the value of a reserved bit should be preserved across a read-modify-write operation.
2	FBR	RO	0	<p>First Byte Received</p> <p>Value Description</p> <p>1 The first byte following the slave's own address has been received.</p> <p>0 The first byte has not been received.</p> <p>This bit is only valid when the RREQ bit is set and is automatically cleared when data has been read from the I2CSDR register.</p> <p><b>Note:</b> This bit is not used for slave transmit operations.</p>
1	TREQ	RO	0	<p>Transmit Request</p> <p>Value Description</p> <p>1 The I<sup>2</sup>C controller has been addressed as a slave transmitter and is using clock stretching to delay the master until data has been written to the I2CSDR register.</p> <p>0 No outstanding transmit request.</p>

Bit/Field	Name	Type	Reset	Description
0	RREQ	RO	0	Receive Request

## Value Description

1	The I <sup>2</sup> C controller has outstanding receive data from the I <sup>2</sup> C master and is using clock stretching to delay the master until the data has been read from the <b>I2CSDR</b> register.
0	No outstanding receive data.

**Write-Only Control Register****I2C Slave Control/Status (I2CSCSR)**

I2C Slave 0 base: 0x4002.0800

I2C Slave 1 base: 0x4002.1800

Offset 0x004

Type WO, reset 0x0000.0000

	31	30	29	28	27	26	25	24	23	22	21	20	19	18	17	16	
	reserved																
Type	RO	RO	RO	RO	RO	RO	RO	RO	RO	RO	RO	RO	RO	RO	RO	RO	
Reset	0	0	0	0	0	0	0	0	0	0	0	0	0	0	0	0	
	15	14	13	12	11	10	9	8	7	6	5	4	3	2	1	0	
	reserved															DA	
Type	RO	RO	RO	RO	RO	RO	RO	RO	RO	RO	RO	RO	RO	RO	RO	RO	WO
Reset	0	0	0	0	0	0	0	0	0	0	0	0	0	0	0	0	0

Bit/Field	Name	Type	Reset	Description
31:1	reserved	RO	0x0000.000	Software should not rely on the value of a reserved bit. To provide compatibility with future products, the value of a reserved bit should be preserved across a read-modify-write operation.
0	DA	WO	0	Device Active

## Value Description

0	Disables the I <sup>2</sup> C slave operation.
1	Enables the I <sup>2</sup> C slave operation.

## Register 12: I<sup>2</sup>C Slave Data (I2CSDR), offset 0x008

**Important:** Use caution when reading this register. Performing a read may change bit status.

This register contains the data to be transmitted when in the Slave Transmit state, and the data received when in the Slave Receive state.

### I2C Slave Data (I2CSDR)

I2C Slave 0 base: 0x4002.0800

I2C Slave 1 base: 0x4002.1800

Offset 0x008

Type R/W, reset 0x0000.0000

	31	30	29	28	27	26	25	24	23	22	21	20	19	18	17	16
	reserved															
Type	RO	RO	RO	RO	RO	RO	RO	RO	RO	RO	RO	RO	RO	RO	RO	RO
Reset	0	0	0	0	0	0	0	0	0	0	0	0	0	0	0	0
	15	14	13	12	11	10	9	8	7	6	5	4	3	2	1	0
	reserved								DATA							
Type	RO	RO	RO	RO	RO	RO	RO	RO	R/W	R/W	R/W	R/W	R/W	R/W	R/W	R/W
Reset	0	0	0	0	0	0	0	0	0	0	0	0	0	0	0	0

Bit/Field	Name	Type	Reset	Description
31:8	reserved	RO	0x0000.00	Software should not rely on the value of a reserved bit. To provide compatibility with future products, the value of a reserved bit should be preserved across a read-modify-write operation.
7:0	DATA	R/W	0x00	Data for Transfer  This field contains the data for transfer during a slave receive or transmit operation.



## Register 13: I<sup>2</sup>C Slave Interrupt Mask (I2CSIMR), offset 0x00C

This register controls whether a raw interrupt is promoted to a controller interrupt.

### I2C Slave Interrupt Mask (I2CSIMR)

I2C Slave 0 base: 0x4002.0800

I2C Slave 1 base: 0x4002.1800

Offset 0x00C

Type R/W, reset 0x0000.0000

	31	30	29	28	27	26	25	24	23	22	21	20	19	18	17	16
	reserved															
Type	RO	RO	RO	RO	RO	RO	RO	RO	RO	RO	RO	RO	RO	RO	RO	RO
Reset	0	0	0	0	0	0	0	0	0	0	0	0	0	0	0	0
	15	14	13	12	11	10	9	8	7	6	5	4	3	2	1	0
	reserved													STOPIM	STARTIM	DATAIM
Type	RO	RO	RO	RO	RO	RO	RO	RO	RO	RO	RO	RO	RO	RO	RO	R/W
Reset	0	0	0	0	0	0	0	0	0	0	0	0	0	0	0	0

Bit/Field	Name	Type	Reset	Description
31:3	reserved	RO	0x0000.000	Software should not rely on the value of a reserved bit. To provide compatibility with future products, the value of a reserved bit should be preserved across a read-modify-write operation.
2	STOPIM	RO	0	Stop Condition Interrupt Mask  Value Description 1 The STOP condition interrupt is sent to the interrupt controller when the <code>STOPRIS</code> bit in the <code>I2CSRIS</code> register is set. 0 The <code>STOPRIS</code> interrupt is suppressed and not sent to the interrupt controller.
1	STARTIM	RO	0	Start Condition Interrupt Mask  Value Description 1 The START condition interrupt is sent to the interrupt controller when the <code>STARTRIS</code> bit in the <code>I2CSRIS</code> register is set. 0 The <code>STARTRIS</code> interrupt is suppressed and not sent to the interrupt controller.
0	DATAIM	R/W	0	Data Interrupt Mask  Value Description 1 The data received or data requested interrupt is sent to the interrupt controller when the <code>DATARIS</code> bit in the <code>I2CSRIS</code> register is set. 0 The <code>DATARIS</code> interrupt is suppressed and not sent to the interrupt controller.

## Register 14: I<sup>2</sup>C Slave Raw Interrupt Status (I2CSRIS), offset 0x010

This register specifies whether an interrupt is pending.

### I2C Slave Raw Interrupt Status (I2CSRIS)

I2C Slave 0 base: 0x4002.0800

I2C Slave 1 base: 0x4002.1800

Offset 0x010

Type RO, reset 0x0000.0000

	31	30	29	28	27	26	25	24	23	22	21	20	19	18	17	16
	reserved															
Type	RO	RO	RO	RO	RO	RO	RO	RO	RO	RO	RO	RO	RO	RO	RO	RO
Reset	0	0	0	0	0	0	0	0	0	0	0	0	0	0	0	0
	15	14	13	12	11	10	9	8	7	6	5	4	3	2	1	0
	reserved													STOPRIS	STARTRIS	DATARIS
Type	RO	RO	RO	RO	RO	RO	RO	RO	RO	RO	RO	RO	RO	RO	RO	RO
Reset	0	0	0	0	0	0	0	0	0	0	0	0	0	0	0	0

Bit/Field	Name	Type	Reset	Description
31:3	reserved	RO	0x0000.000	Software should not rely on the value of a reserved bit. To provide compatibility with future products, the value of a reserved bit should be preserved across a read-modify-write operation.
2	STOPRIS	RO	0	<p>Stop Condition Raw Interrupt Status</p> <p>Value Description</p> <p>1 A STOP condition interrupt is pending.</p> <p>0 No interrupt.</p> <p>This bit is cleared by writing a 1 to the STOPIC bit in the I2CSICR register.</p>
1	STARTRIS	RO	0	<p>Start Condition Raw Interrupt Status</p> <p>Value Description</p> <p>1 A START condition interrupt is pending.</p> <p>0 No interrupt.</p> <p>This bit is cleared by writing a 1 to the STARTIC bit in the I2CSICR register.</p>
0	DATARIS	RO	0	<p>Data Raw Interrupt Status</p> <p>Value Description</p> <p>1 A data received or data requested interrupt is pending.</p> <p>0 No interrupt.</p> <p>This bit is cleared by writing a 1 to the DATAIC bit in the I2CSICR register.</p>

## Register 15: I<sup>2</sup>C Slave Masked Interrupt Status (I2CSMIS), offset 0x014

This register specifies whether an interrupt was signaled.

### I2C Slave Masked Interrupt Status (I2CSMIS)

I2C Slave 0 base: 0x4002.0800

I2C Slave 1 base: 0x4002.1800

Offset 0x014

Type RO, reset 0x0000.0000

	31	30	29	28	27	26	25	24	23	22	21	20	19	18	17	16
	reserved															
Type	RO	RO	RO	RO	RO	RO	RO	RO	RO	RO	RO	RO	RO	RO	RO	RO
Reset	0	0	0	0	0	0	0	0	0	0	0	0	0	0	0	0
	15	14	13	12	11	10	9	8	7	6	5	4	3	2	1	0
	reserved												STOPMIS	STARTMIS	DATAMIS	
Type	RO	RO	RO	RO	RO	RO	RO	RO	RO	RO	RO	RO	RO	R/W	R/W	RO
Reset	0	0	0	0	0	0	0	0	0	0	0	0	0	0	0	0

Bit/Field	Name	Type	Reset	Description
31:3	reserved	RO	0x0000.000	Software should not rely on the value of a reserved bit. To provide compatibility with future products, the value of a reserved bit should be preserved across a read-modify-write operation.
2	STOPMIS	R/W	0	<p>Stop Condition Masked Interrupt Status</p> <p>Value Description</p> <p>1 An unmasked STOP condition interrupt was signaled is pending.</p> <p>0 An interrupt has not occurred or is masked.</p> <p>This bit is cleared by writing a 1 to the STOPIC bit in the I2CSICR register.</p>
1	STARTMIS	R/W	0	<p>Start Condition Masked Interrupt Status</p> <p>Value Description</p> <p>1 An unmasked START condition interrupt was signaled is pending.</p> <p>0 An interrupt has not occurred or is masked.</p> <p>This bit is cleared by writing a 1 to the STARTIC bit in the I2CSICR register.</p>
0	DATAMIS	RO	0	<p>Data Masked Interrupt Status</p> <p>Value Description</p> <p>1 An unmasked data received or data requested interrupt was signaled is pending.</p> <p>0 An interrupt has not occurred or is masked.</p> <p>This bit is cleared by writing a 1 to the DATAIC bit in the I2CSICR register.</p>

## Register 16: I<sup>2</sup>C Slave Interrupt Clear (I2CSICR), offset 0x018

This register clears the raw interrupt. A read of this register returns no meaningful data.

### I2C Slave Interrupt Clear (I2CSICR)

I2C Slave 0 base: 0x4002.0800

I2C Slave 1 base: 0x4002.1800

Offset 0x018

Type WO, reset 0x0000.0000

	31	30	29	28	27	26	25	24	23	22	21	20	19	18	17	16	
	reserved																
Type	RO	RO	RO	RO	RO	RO	RO	RO	RO	RO	RO	RO	RO	RO	RO	RO	
Reset	0	0	0	0	0	0	0	0	0	0	0	0	0	0	0	0	
	15	14	13	12	11	10	9	8	7	6	5	4	3	2	1	0	
	reserved													STOPIC	STARTIC	DATAIC	
Type	RO	RO	RO	RO	RO	RO	RO	RO	RO	RO	RO	RO	RO	RO	WO	WO	WO
Reset	0	0	0	0	0	0	0	0	0	0	0	0	0	0	0	0	0

Bit/Field	Name	Type	Reset	Description
31:3	reserved	RO	0x0000.000	Software should not rely on the value of a reserved bit. To provide compatibility with future products, the value of a reserved bit should be preserved across a read-modify-write operation.
2	STOPIC	WO	0	Stop Condition Interrupt Clear  Writing a 1 to this bit clears the <i>STOPRIS</i> bit in the <b>I2CSRIS</b> register and the <i>STOPMIS</i> bit in the <b>I2CSMIS</b> register.  A read of this register returns no meaningful data.
1	STARTIC	WO	0	Start Condition Interrupt Clear  Writing a 1 to this bit clears the <i>STOPRIS</i> bit in the <b>I2CSRIS</b> register and the <i>STOPMIS</i> bit in the <b>I2CSMIS</b> register.  A read of this register returns no meaningful data.
0	DATAIC	WO	0	Data Interrupt Clear  Writing a 1 to this bit clears the <i>STOPRIS</i> bit in the <b>I2CSRIS</b> register and the <i>STOPMIS</i> bit in the <b>I2CSMIS</b> register.  A read of this register returns no meaningful data.

## 17 Inter-Integrated Circuit Sound (I<sup>2</sup>S) Interface

The I<sup>2</sup>S module is a configurable serial audio core that contains a transmit module and a receive module. The module is configurable for the I<sup>2</sup>S as well as Left-Justified and Right-Justified serial audio formats. Data can be in one of four modes: Stereo, Mono, Compact 16-bit Stereo and Compact 8-Bit Stereo.

The transmit and receive modules each have an 8-entry audio-sample FIFO. An audio sample can consist of a Left and Right Stereo sample, a Mono sample, or a Left and Right Compact Stereo sample. In Compact 16-Bit Stereo, each FIFO entry contains both the 16-bit left and 16-bit right samples, allowing efficient data transfers and requiring less memory space. In Compact 8-bit Stereo, each FIFO entry contains an 8-bit left and an 8-bit right sample, reducing memory requirements further.

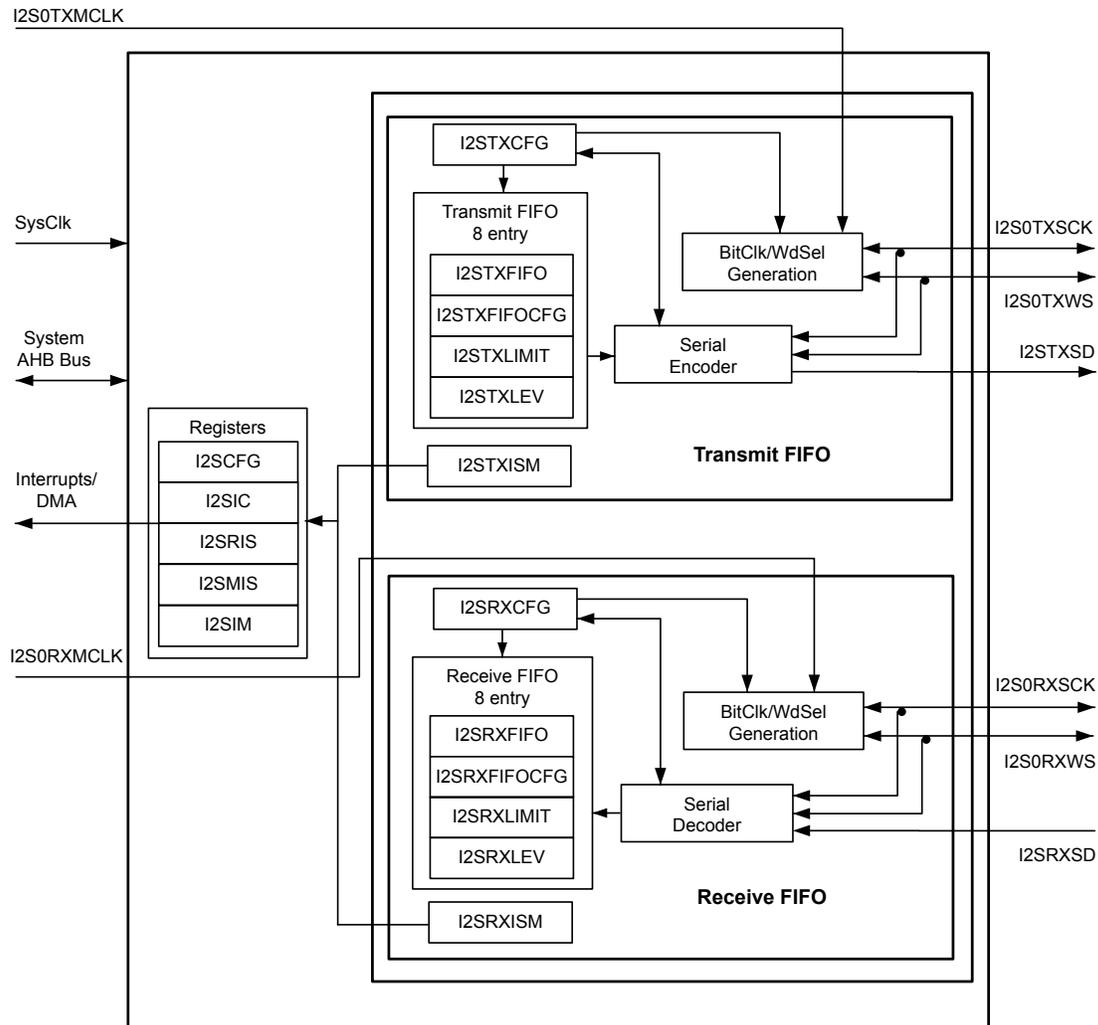
Both the transmitter and receiver are capable of being a master or a slave.

The Stellaris® I<sup>2</sup>S module has the following features:

- Configurable audio format supporting I<sup>2</sup>S, Left-justification, and Right-justification
- Configurable sample size from 8 to 32 bits
- Mono and Stereo support
- 8-, 16-, and 32-bit FIFO interface for packing memory
- Independent transmit and receive 8-entry FIFOs
- Configurable FIFO-level interrupt and  $\mu$ DMA requests
- Independent transmit and receive MCLK direction control
- Transmit and receive internal MCLK sources
- Independent transmit and receive control for serial clock and word select
- MCLK and SCLK can be independently set to master or slave
- Configurable transmit zero or last sample when FIFO empty
- Efficient transfers using Micro Direct Memory Access Controller ( $\mu$ DMA)
  - Separate channels for transmit and receive
  - Burst requests
  - Channel requests asserted when FIFO contains required amount of data

## 17.1 Block Diagram

Figure 17-1. I<sup>2</sup>S Block Diagram



## 17.2 Signal Description

Table 17-1 on page 727 and Table 17-2 on page 727 list the external signals of the I<sup>2</sup>S module and describe the function of each. The I<sup>2</sup>S module signals are alternate functions for some GPIO signals and default to be GPIO signals at reset. The column in the table below titled "Pin Mux/Pin Assignment" lists the possible GPIO pin placements for the I<sup>2</sup>S signals. The **AFSEL** bit in the **GPIO Alternate Function Select (GPIOAFSEL)** register (page 328) should be set to choose the I<sup>2</sup>S function. The number in parentheses is the encoding that must be programmed into the **PMC<sub>n</sub>** field in the **GPIO Port Control (GPIOCTL)** register (page 346) to assign the I<sup>2</sup>S signal to the specified GPIO port pin. For more information on configuring GPIOs, see "General-Purpose Input/Outputs (GPIOs)" on page 304.

**Table 17-1. Signals for I2S (100LQFP)**

Pin Name	Pin Number	Pin Mux / Pin Assignment	Pin Type	Buffer Type <sup>a</sup>	Description
I2S0RXMCLK	29 98	PA3 (9) PD5 (8)	I/O	TTL	I <sup>2</sup> S module 0 receive master clock.
I2S0RXSCK	10	PD0 (8)	I/O	TTL	I <sup>2</sup> S module 0 receive clock.
I2S0RXSD	28 97	PA2 (9) PD4 (8)	I/O	TTL	I <sup>2</sup> S module 0 receive data.
I2S0RXWS	11	PD1 (8)	I/O	TTL	I <sup>2</sup> S module 0 receive word select.
I2S0TXMCLK	61	PF1 (8)	I/O	TTL	I <sup>2</sup> S module 0 transmit master clock.
I2S0TXSCK	30 90 99	PA4 (9) PB6 (9) PD6 (8)	I/O	TTL	I <sup>2</sup> S module 0 transmit clock.
I2S0TXSD	5 47	PE5 (9) PF0 (8)	I/O	TTL	I <sup>2</sup> S module 0 transmit data.
I2S0TXWS	6 31 100	PE4 (9) PA5 (9) PD7 (8)	I/O	TTL	I <sup>2</sup> S module 0 transmit word select.

a. The TTL designation indicates the pin has TTL-compatible voltage levels.

**Table 17-2. Signals for I2S (108BGA)**

Pin Name	Pin Number	Pin Mux / Pin Assignment	Pin Type	Buffer Type <sup>a</sup>	Description
I2S0RXMCLK	L4 C6	PA3 (9) PD5 (8)	I/O	TTL	I <sup>2</sup> S module 0 receive master clock.
I2S0RXSCK	G1	PD0 (8)	I/O	TTL	I <sup>2</sup> S module 0 receive clock.
I2S0RXSD	M4 B5	PA2 (9) PD4 (8)	I/O	TTL	I <sup>2</sup> S module 0 receive data.
I2S0RXWS	G2	PD1 (8)	I/O	TTL	I <sup>2</sup> S module 0 receive word select.
I2S0TXMCLK	H12	PF1 (8)	I/O	TTL	I <sup>2</sup> S module 0 transmit master clock.
I2S0TXSCK	L5 A7 A3	PA4 (9) PB6 (9) PD6 (8)	I/O	TTL	I <sup>2</sup> S module 0 transmit clock.
I2S0TXSD	B3 M9	PE5 (9) PF0 (8)	I/O	TTL	I <sup>2</sup> S module 0 transmit data.
I2S0TXWS	B2 M5 A2	PE4 (9) PA5 (9) PD7 (8)	I/O	TTL	I <sup>2</sup> S module 0 transmit word select.

a. The TTL designation indicates the pin has TTL-compatible voltage levels.

## 17.3 Functional Description

The Inter-Integrated Circuit Sound (I<sup>2</sup>S) module contains separate transmit and receive engines. Each engine consists of the following:

- Serial encoder for the transmitter; serial decoder for the receiver
- 8-entry FIFO to store sample data
- Independent configuration of all programmable settings

The basic programming model of the I<sup>2</sup>S block is as follows:

■ Configuration

- Overall I<sup>2</sup>S module configuration in the **I<sup>2</sup>S Module Configuration (I2SCFG)** register. This register is used to select the MCLK source and enable the receiver and transmitter.
- Transmit and receive configuration in the **I<sup>2</sup>S Transmit Module Configuration (I2STXCFG)** and **I<sup>2</sup>S Receive Module Configuration (I2SRXCFG)** registers. These registers set the basic parameters for the receiver and transmitter such as data configuration (justification, delay, read mode, sample size, and system data size); SCLK (polarity and source); and word select polarity.
- Transmit and receive FIFO configuration in the **I<sup>2</sup>S Transmit FIFO Configuration (I2STXFIFOCFG)** and **I<sup>2</sup>S Receive FIFO Configuration (I2SRXFIFOCFG)** registers. These registers select the Compact Stereo mode size (16-bit or 8-bit), provide indication of whether the next sample is Left or Right, and select mono mode for the receiver.

■ FIFO

- Transmit and receive FIFO data in the **I<sup>2</sup>S Transmit FIFO Data (I2STXFIFO)** and **I<sup>2</sup>S Receive FIFO Data (I2SRXFIFO)** registers
- Information on FIFO data levels in the **I<sup>2</sup>S Transmit FIFO Level (I2STXLEV)** and **I<sup>2</sup>S Receive FIFO Level (I2SRXLEV)** registers
- Configuration for FIFO service requests based on FIFO levels in the **I<sup>2</sup>S Transmit FIFO Limit (I2STXLIMIT)** and **I<sup>2</sup>S Receive FIFO Limit (I2SRXLIM)** registers

■ Interrupt Control

- Interrupt masking configuration in the **I<sup>2</sup>S Interrupt Mask (I2SIM)** register
- Raw and masked interrupt status in the **I<sup>2</sup>S Raw Interrupt Status (I2SRIS)** and **I<sup>2</sup>S Masked Interrupt Status (I2SMIS)** registers
- Interrupt clearing through the **I<sup>2</sup>S Interrupt Clear (I2SIC)** register
- Configuration for FIFO service requests interrupts and transmit/receive error interrupts in the **I<sup>2</sup>S Transmit Interrupt Status and Mask (I2STXISM)** and **I<sup>2</sup>S Receive Interrupt Status and Mask (I2SRXISM)** registers

Figure 17-2 on page 729 provides an example of an I<sup>2</sup>S data transfer. Figure 17-3 on page 729 provides an example of an Left-Justified data transfer. Figure 17-4 on page 729 provides an example of an Right-Justified data transfer.



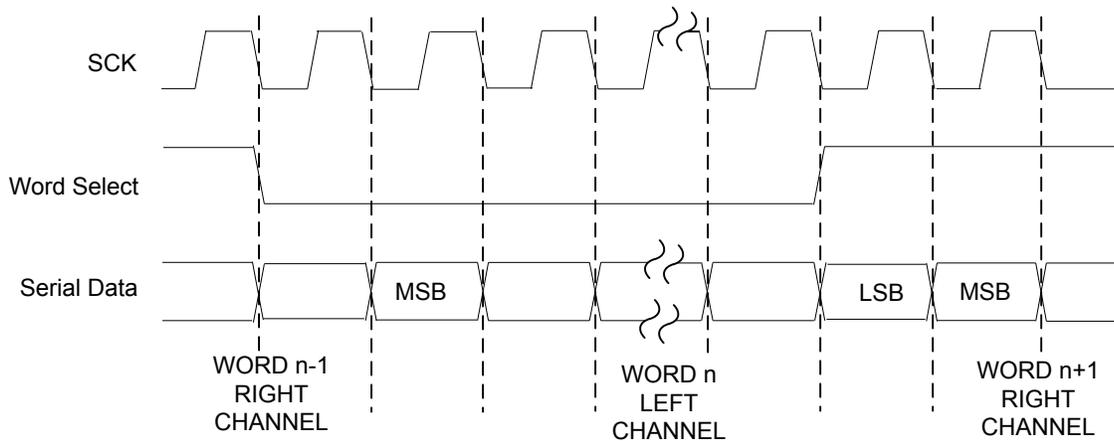
Figure 17-2. I<sup>2</sup>S Data Transfer

Figure 17-3. Left-Justified Data Transfer

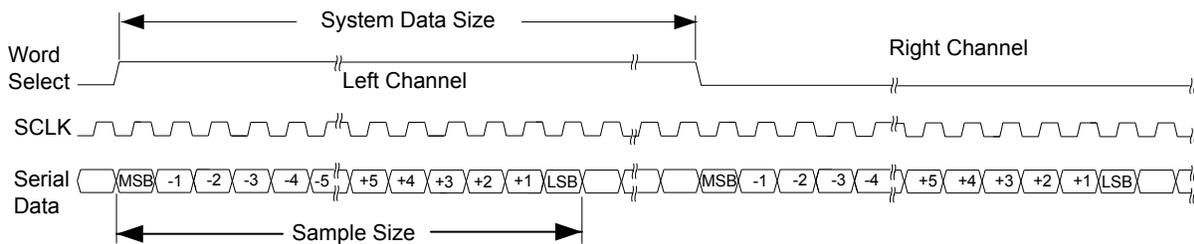
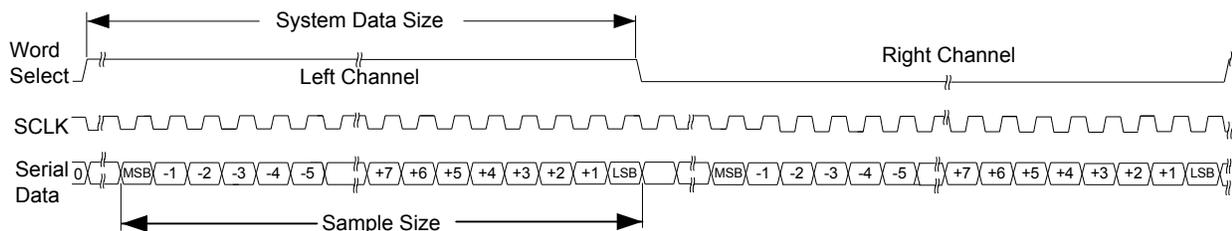


Figure 17-4. Right-Justified Data Transfer



### 17.3.1 Transmit

The transmitter consists of a serial encoder, an 8-entry FIFO, and control logic. The transmitter has independent MCLK (I2S0TXMCLK), SCLK (I2S0TXSCK), and Word-Select (I2S0TXWS) signals.

#### 17.3.1.1 Serial Encoder

The serial encoder reads audio samples from the receive FIFO and converts them into an audio stream. By configuring the serial encoder, common audio formats I<sup>2</sup>S, Left-Justified, and Right-Justified are supported. The MSB is transmitted first. The sample size and system data size are configurable with the SSZ and SDSZ bits in the **I<sup>2</sup>S Transmit Module Configuration (I2STXCFG)** register. The sample size is the number of bits of data being transmitted, and the system data size is the number of I2S0TXSCK transitions between the word select transitions. The system data size must be large enough to accommodate the maximum sample size. In Mono mode, the sample data

is repeated in both the left and right channels. When the FIFO is empty, the user may select either transmission of zeros or of the last sample. The serial encoder is enabled using the `TXEN` bit in the **I<sup>2</sup>S Module Configuration (I2SCFG)** register.

### 17.3.1.2 FIFO Operation

The transmit FIFO stores eight Mono samples or eight Stereo sample-pairs of data and is accessed through the **I<sup>2</sup>S Transmit FIFO Data (I2STXFIFO)** register. The FIFO interface for the audio data is different based on the Write mode, defined by the **I<sup>2</sup>S Transmit FIFO Configuration (I2STXFIFOCFG)** Compact Stereo Sample Size bit (`CSS`) and the **I2STXCFG** Write Mode field (`WM`). All data samples are MSB-aligned. Table 17-3 on page 730 defines the interface for each Write mode. Stereo samples are written first left then right. The next sample (right or left) to be written is indicated by the `LRS` bit in the **I2STXFIFOCFG** register.

**Table 17-3. I<sup>2</sup>S Transmit FIFO Interface**

<code>WM</code> field in I2STXCFG	<code>CSS</code> bit in I2STXFIFOCFG	Write Mode	Sample Width	Samples per FIFO Write	Data Alignment
0x0	don't care	Stereo	8-32 bits	1	MSB
0x1	0	Compact Stereo - 16 bit	8-16 bits	2	MSB Right [31:16], Left [15:0]
0x1	1	Compact Stereo - 8 bit	8 bits	2	Right [15:8], Left[7:0]
0x2	don't care	Mono	8-32 bits	1	MSB

The number of samples in the transmit FIFO can be read using the **I<sup>2</sup>S Transmit FIFO Level (I2STXLEV)** register. The value ranges from 0 to 16. Stereo and compact stereo sample pairs are counted as two. The mono samples also increment the count by two, therefore, four mono samples will have a count of eight.

### 17.3.1.3 Clock Control

The transmitter `MCLK` and `SCLK` can be independently programmed to be the master or slave. The transmitter is programmed to be the master or slave of the `SCLK` using the `MSL` bit in the **I2STXCFG** register. When the transmitter is the master, the `I2S0TXSCK` frequency is the specified `I2S0TXMCLK` divided by four. The `I2S0TXSCK` may be inverted using the `SCP` bit in the **I2STXCFG** register.

The transmitter can also be the master or slave of the `MCLK`. When the transmitter is the master, the PLL must be active and a fractional clock divider must be programmed. See page 144 for the setup for the master `I2S0TXMCLK` source. An external transmit `I2S0TXMCLK` does not require the use of the PLL and is selected using the `TXSLV` bit in the **I2SCFG** register.

The following tables show combinations of the `TXINT` and `TXFRAC` bits in the **I<sup>2</sup>S MCLK Configuration (I2SMCLKCFG)** register that provide `MCLK` frequencies within acceptable error limits. In the table,  $F_s$  is the sampling frequency in kHz and possible crystal frequencies are shown in MHz across the top row of the table. The words "not supported" in the table mean that it is not possible to obtain the specified sampling frequencies with the specified crystal frequency within the error tolerance of 0.3%. The values in the table are based on the following values:

$$MCLK = F_s \times 256 \text{ PLL} = 400 \text{ MHz}$$

The Integer value is taken from the result of the following calculation:

$$\text{ROUND}(\text{PLL}/MCLK)$$

The remaining fractional component is converted to binary, and the first four bits are the Fractional value.

Table 17-4. Crystal Frequency (Values from 3.5795 MHz to 5 MHz)

Sampling Frequency Fs (kHz)	Crystal Frequency (MHz)											
	3.5795		3.6864		4		4.096		4.9152		5	
	Integer	Fractional	Integer	Fractional	Integer	Fractional	Integer	Fractional	Integer	Fractional	Integer	Fractional
8	195	12	194	6	195	5	196	0	194	6	195	5
11.025	142	1	141	1	141	12	142	4	141	1	141	12
12	130	8	129	10	130	3	130	11	129	10	130	3
16	97	14	97	3	97	10	98	0	97	3	97	10
22.05	71	0	70	8	70	14	71	2	70	8	70	14
24	65	4	64	13	65	2	65	5	64	13	65	2
32	48	15	48	10	48	13	49	0	48	10	48	13
44.1	35	8	35	4	35	7	35	9	35	4	35	7
48	32	10	32	6	32	9	32	11	32	6	32	9
64	24	8	24	5	24	7	24	8	24	5	24	7
88.2	17	12	17	10	17	11	17	12	17	10	17	11
96	16	5	16	3	16	4	16	5	16	3	16	4
128	12	4	12	2	12	3	12	4	12	2	12	3
176.4	8	14	8	13	8	14	8	14	8	13	8	14
192	Not supported		Not supported		8	2	8	3	Not supported		8	2

Table 17-5. Crystal Frequency (Values from 5.12 MHz to 8.192 MHz)

Sampling Frequency Fs (kHz)	Crystal Frequency (MHz)											
	5.12		6		6.144		7.3728		8		8.192	
	Integer	Fractional	Integer	Fractional	Integer	Fractional	Integer	Fractional	Integer	Fractional	Integer	Fractional
8	195	0	195	5	195	0	194	6	195	5	194	11
11.025	141	8	141	12	141	8	141	1	141	12	141	4
12	130	0	130	3	130	0	129	10	130	3	129	12
16	97	8	97	10	97	8	97	3	97	10	97	5
22.05	70	12	70	14	70	12	70	8	70	14	70	10
24	65	0	65	2	65	0	64	13	65	2	64	14
32	48	12	48	13	48	12	48	10	48	13	48	11
44.1	35	6	35	7	35	6	35	4	35	7	35	5
48	32	8	32	9	32	8	32	6	32	9	32	7
64	24	6	24	7	24	6	24	5	24	7	24	5
88.2	17	11	17	11	17	11	17	10	17	11	17	11
96	16	4	16	4	16	4	16	3	16	4	16	4
128	12	3	12	3	12	3	12	2	12	3	12	3
176.4	Not supported		8	14	Not supported		8	13	8	14	8	13
192	8	2	8	2	8	2	Not supported		8	2	8	2

**Table 17-6. Crystal Frequency (Values from 10 MHz to 14.3181 MHz)**

Sampling Frequency Fs (kHz)	Crystal Frequency (MHz)									
	10		12		12.288		13.56		14.3181	
	Integer	Fractional	Integer	Fractional	Integer	Fractional	Integer	Fractional	Integer	Fractional
8	195	5	195	5	196	0	194	3	195	12
11.025	141	12	141	12	142	4	140	15	142	1
12	130	3	130	3	130	11	129	8	130	8
16	97	10	97	10	98	0	97	2	97	14
22.05	70	14	70	14	71	2	70f	7	71	0
24	65	2	65	2	65	5	64	12	65	4
32	48	13	48	13	49	0	48	9	48	15
44.1	35	7	35	7	35	9	35	4	35	8
48	32	9	32	9	32	11	32	6	32	10
64	24	7	24	7	24	8	24	4	24	8
88.2	17	11	17	11	17	12	17	10	17	12
96	16	4	16	4	16	5	16	3	16	5
128	12	3	12	3	12	4	12	2	12	4
176.4	8	14	8	14	8	14	8	13	8	14
192	8	2	8	2	8	3	Not supported		Not supported	

**Table 17-7. Crystal Frequency (Values from 16 MHz to 16.384 MHz)**

Sampling Frequency Fs (kHz)	Crystal Frequency (MHz)			
	16		16.384	
	Integer	Fractional	Integer	Fractional
8	195	5	192	0
11.025	141	12	139	5
12	130	3	128	0
16	97	10	96	0
22.05	70	14	69	11
24	65	2	64	0
32	48	13	48	0
44.1	35	7	34	13
48	32	9	32	0
64	24	7	24	0
88.2	17	11	17	7
96	16	4	16	0
128	12	3	12	0
176.4	8	14	8	11
192	8	2	8	0

**17.3.1.4 Interrupt Control**

A single interrupt is asserted to the CPU whenever any of the transmit or receive sources is asserted. The transmit module has two interrupt sources: the FIFO service request and write error. The interrupts may be masked using the TXSRIM and TXWEIM bits in the I<sup>2</sup>S Interrupt Mask (I2SIM)

register. The status of the interrupt source is indicated by the **I<sup>2</sup>S Raw Interrupt Status (I2SRIS)** register. The status of enabled interrupts is indicated by the **I<sup>2</sup>S Masked Interrupt Status (I2SMIS)** register. The FIFO level interrupt has a second level of masking using the **FFM** bit in the **I<sup>2</sup>S Transmit Interrupt Status and Mask (I2STXISM)** register.

The FIFO service request interrupt is asserted when the FIFO level (indicated by the **LEVEL** field in the **I<sup>2</sup>S Transmit FIFO Level (I2STXLEV)** register) is below the FIFO limit (programmed using the **I<sup>2</sup>S Transmit FIFO Limit (I2STXLIMIT)** register) and both the **TXSRIM** and **FFM** bits are set. If software attempts to write to a full FIFO, a Transmit FIFO Write error occurs (indicated by the **TXWERIS** bit in the **I<sup>2</sup>S Raw Interrupt Status (I2SRIS)** register). The **TXWERIS** bit in the **I2SRIS** register and the **TXWEMIS** bit in the **I2SMIS** register are cleared by setting the **TXWEIC** bit in the **I<sup>2</sup>S Interrupt Clear (I2SIC)** register.

### 17.3.1.5 DMA Support

The  $\mu$ DMA can be used to more efficiently stream data to and from the I<sup>2</sup>S bus. The I<sup>2</sup>S transmit and receive modules have separate  $\mu$ DMA channels. The FIFO Interrupt Mask bit (**FFM**) in the **I2STXISM** register must be set for the request signaling to propagate to the  $\mu$ DMA module. See “Micro Direct Memory Access ( $\mu$ DMA)” on page 246 for channel configuration.

The I<sup>2</sup>S module uses the  $\mu$ DMA burst request signal, not the single request. Thus each time a  $\mu$ DMA request is made, the  $\mu$ DMA controller transfers the number of items specified as the burst size for the  $\mu$ DMA channel. Therefore, the  $\mu$ DMA channel burst size and the I<sup>2</sup>S FIFO service request limit must be set to the same value (using the **LIMIT** field in the **I2STXLIMIT** register).

## 17.3.2 Receive

The receiver consists of a serial decoder, an 8-entry FIFO, and control logic. The receiver has independent **MCLK (I2S0RXMCLK)**, **SCLK (I2S0RXSCK)**, and **Word-Select (I2S0RXWS)** signals.

### 17.3.2.1 Serial Decoder

The serial decoder accepts incoming audio stream data and places the sample data in the receive FIFO. By configuring the serial decoder, common audio formats I<sup>2</sup>S, Left-Justified, and Right-Justified are supported. The MSB is transmitted first. The sample size and system data size are configurable with the **SSZ** and **SDSZ** bits in the **I<sup>2</sup>S Receive Module Configuration (I2SRXCFG)** register. The sample size is the number of bits of data being received, and the system data size is the number of **I2S0RXSCK** transitions between the word select transitions. The system data size must be large enough to accommodate the maximum sample size. Any bits received after the LSB are 0s. If the FIFO is full, the incoming sample (in Mono) or sample-pairs (Stereo) are dropped until the FIFO has space. The serial decoder is enabled using the **RXEN** bit in the **I2SCFG** register.

### 17.3.2.2 FIFO Operation

The receive FIFO stores eight Mono samples or eight Stereo sample-pairs of data and is accessed through the **I<sup>2</sup>S Receive FIFO Data (I2SRXFIFO)** register. Table 17-8 on page 734 defines the interface for each Read mode. All data is stored MSB-aligned. The Stereo data is read left sample then right.

In Mono mode, the FIFO interface can be configured to read the right or left channel by setting the FIFO Mono Mode bit (**FMM**) in the **I<sup>2</sup>S Receive FIFO Configuration (I2SRXFIFOCFG)** register. This enables reads from a single channel, where the channel selected can be either the right or left as determined by the **LRP** bit in the **I2SRXCFG** register.

Table 17-8. I<sup>2</sup>S Receive FIFO Interface

RM bit in I2RXCFG	CSS bit in I2SRXFIFOCFG	Read Mode	Sample Width	Samples per FIFO Read	Data Alignment
0	don't care	Stereo	8-32 bits	1	MSB
1	0	Compact Stereo - 16 bit	8-16 bits	2	MSB Right [31:15], Left [15:0]
1	1	Compact Stereo - 8 bit	8 bits	2	Right [15:8] Left[7:0]
0	don't care	Mono (FMM bit in the I2SRXFIFOCFG register must be set.)	8-32 bits	1	MSB

The number of samples in the receive FIFO can be read using the **I<sup>2</sup>S Receive FIFO Level (I2SRXLEV)** register. The value ranges from 0 to 16. Stereo and compact stereo sample pairs are counted as two. The mono samples also increment the count by two, therefore four Mono samples will have a count of eight.

### 17.3.2.3 Clock Control

The receiver MCLK and SCLK can be independently programmed to be the master or slave. The receiver is programmed to be the master or slave of the SCLK using the **MSL** bit in the **I2SRXCFG** register. When the receiver is the master, the **I2S0RXSCK** frequency is the specified **I2S0RXMCLK** divided by four. The **I2S0RXSCK** may be inverted using the **SCP** bit in the **I2SRXCFG** register.

The receiver can also be the master or slave of the MCLK. When the receiver is the master, the PLL must be active and a fractional clock divider must be programmed. See page 144 for the setup for the master **I2S0RXMCLK** source. An external transmit **I2S0RXMCLK** does not require the use of the PLL and is selected using the **RXSLV** bit in the **I2SCFG** register.

Refer to "Clock Control" on page 730 for combinations of the **RXINT** and **RXFRAC** bits in the **I<sup>2</sup>S MCLK Configuration (I2SMCLKCFG)** register that provide MCLK frequencies within acceptable error limits. In the table,  $F_s$  is the sampling frequency in kHz and possible crystal frequencies are shown in MHz across the top row of the table. The words "not supported" in the table mean that it is not possible to obtain the specified sampling frequencies with the specified crystal frequency within the error tolerance of 0.3%.

### 17.3.2.4 Interrupt Control

A single interrupt is asserted to the CPU whenever any of the transmit or receive sources is asserted. The receive module has two interrupt sources: the FIFO service request and read error. The interrupts may be masked using the **RXSRIM** and **RXREIM** bits in the **I2SIM** register. The status of the interrupt source is indicated by the **I2SRIS** register. The status of enabled interrupts is indicated by the **I2SMIS** register. The FIFO service request interrupt has a second level of masking using the **FMM** bit in the **I<sup>2</sup>S Receive Interrupt Status and Mask (I2SRXISM)** register. The sources may be masked using the **I2SIM** register.

The FIFO service request interrupt is asserted when the FIFO level (indicated by the **LEVEL** field in the **I<sup>2</sup>S Receive FIFO Level (I2SRXLEV)** register) is above the FIFO limit (programmed using the **I<sup>2</sup>S Receive FIFO Limit (I2SRXLIMIT)** register) and both the **RXSRIM** and **FMM** bits are set. An error occurs when reading an empty FIFO or if a stereo sample pair is not read left then right. To clear an interrupt, write a 1 to the appropriate bit in the **I2SIC** register. If software attempts to read an empty FIFO or if a stereo sample pair is not read left then right, a Receive FIFO Read error occurs (indicated by the **RXRERIS** bit in the **I2SRIS** register). The **RXRERIS** bit in the **I2SRIS** register and the **RXREMIS** bit in the **I2SMIS** register are cleared by setting the **RXREIC** bit in the **I2SIC** register.

### 17.3.2.5 DMA Support

The  $\mu$ DMA can be used to more efficiently stream data to and from the I<sup>2</sup>S bus. The I<sup>2</sup>S transmit and receive modules have separate  $\mu$ DMA channels. The FIFO Interrupt Mask bit ( $F_{FM}$ ) in the **I2SRXISM** register must be set for the request signaling to propagate to the  $\mu$ DMA module. See “Micro Direct Memory Access ( $\mu$ DMA)” on page 246 for channel configuration.

The I<sup>2</sup>S module uses the  $\mu$ DMA burst request signal, not the single request. Thus each time a  $\mu$ DMA request is made, the  $\mu$ DMA controller transfers the number of items specified as the burst size for the  $\mu$ DMA channel. Therefore, the  $\mu$ DMA channel burst size and the I<sup>2</sup>S FIFO service request limit must be set to the same value (using the  $LIMIT$  field in the **I2SRXLIMIT** register).

## 17.4 Initialization and Configuration

The default setup for the I<sup>2</sup>S transmit and receive is to use external MCLK, external SCLK, Stereo, I<sup>2</sup>S audio format, and 32-bit data samples. The following example shows how to configure a system using the internal MCLK, internal SCLK, Compact Stereo, and Left-Justified audio format with 16-bit data samples.

1. Enable the I<sup>2</sup>S peripheral clock by writing a value of 0x1000.0000 to the **RCGC1** register in the System Control module (see page 181).
2. Enable the clock to the appropriate GPIO module via the **RCGC2** register in the System Control module (see page 193). To find out which GPIO port to enable, refer to Table 25-5 on page 1160.
3. In the GPIO module, enable the appropriate pins for their alternate function using the **GPIOAFSEL** register (see page 328). To determine which GPIOs to configure, see Table 25-4 on page 1151.
4. Configure the  $PMC_n$  fields in the **GPIOPCTL** register to assign the I<sup>2</sup>S signals to the appropriate pins (see page 346 and Table 25-5 on page 1160).
5. Set up the MCLK sources for a 48-kHz sample rate. The input crystal is assumed to be 6 MHz for this example (internal source).
  - Enable the PLL by clearing the  $PWRDWN$  bit in the **RCC** register in the System Control module (see page 129).
  - Set the MCLK dividers and enable them by writing 0x0208.0208 to the **I2SMCLKCFG** register in the System Control module (see page 144).
  - Enable the MCLK internal sources by writing 0x8208.8208 to the **I2SMCLKCFG** register in the System Control module.

To allow an external MCLK to be used, set bits 4 and 5 of the **I2SCFG** register. Starting up the PLL and enabling the MCLK sources is not required.

6. Set up the Serial Bit Clock SCLK source. By default, the SCLK is externally sourced.
  - Receiver: Masters the  $I2S0RXSCK$  by ORing 0x0040.0000 into the **I2SRXCFG** register.
  - Transmitter: Masters the  $I2S0TXSCK$  by ORing 0x0040.0000 into the **I2STXCFG** register.
7. Configure the Serial Encoder/Decoder (Left-Justified, Compact Stereo, 16-bit samples, 32-bit system data size).

- Set the audio format using the Justification (**JST**), Data Delay (**DLY**), SCLK polarity (**SCP**), and Left-Right Polarity (**LRP**) bits written to the **I2STXCFG** and **I2SRXCFG** registers. The settings are shown in the table below.

**Table 17-9. Audio Formats Configuration**

Audio Format	I2STXCFG/I2SRXCFG Register Bit			
	JST	DLY	SCP	LRP
I <sup>2</sup> S	0	1	0	1
Left-Justified	0	0	0	0
Right-Justified	1	0	0	0

- Write 0x0140.3DF0 to both the **I2STXCFG** and **I2SRXCFG** registers to program the following configurations:
    - Set the sample size to 16 bits using the **SSZ** field of the **I2STXCFG** and **I2SRXCFG** registers.
    - Set the system data size to 32 bits using the **SDSZ** field of the **I2STXCFG** and **I2SRXCFG** registers.
    - Set the Write and Read modes using the **WM** and **RM** fields in the **I2STXCFG** and **I2SRXCFG** registers, respectively.
8. Set up the FIFO limits for triggering interrupts (also used for  $\mu$ DMA)
- Set up the transmit FIFO to trigger when it has less than four sample pairs by writing a 0x0000.0008 to the **I2STXLIMIT** register.
  - Set up the receive FIFO to trigger when there are more than four sample pairs by writing a 0x0000.00008 to the **I2SRXLIMIT** register.
9. Enable interrupts.
- Enable the transmit FIFO interrupt by setting the **FFM** bit in the **I2STXISM** register (write 0x0000.0001).
  - Set up the receive FIFO interrupts by setting the **FFM** bit in the **I2SRXISM** register (write 0x0000.0001).
  - Enable the TX FIFO service request, the TX Error, the RX FIFO service request, and the RX Error interrupts to be sent to the CPU by writing a 0x0000.0033 to the **I2SSIM** register.
10. Enable the Serial Encoder and Serial Decoders by writing a 0x0000.0003 to the **I2SCFG** register.

## 17.5 Register Map

Table 17-10 on page 737 lists the I<sup>2</sup>S registers. The offset listed is a hexadecimal increment to the register's address, relative to the I<sup>2</sup>S interface base address of 0x4005.4000. Note that the I<sup>2</sup>S module clock must be enabled before the registers can be programmed (see page 181).



**Table 17-10. Inter-Integrated Circuit Sound (I<sup>2</sup>S) Interface Register Map**

Offset	Name	Type	Reset	Description	See page
0x000	I2STXFIFO	WO	0x0000.0000	I2S Transmit FIFO Data	738
0x004	I2STXFIFOCFG	R/W	0x0000.0000	I2S Transmit FIFO Configuration	739
0x008	I2STXCFCG	R/W	0x1400.7DF0	I2S Transmit Module Configuration	740
0x00C	I2STXLIMIT	R/W	0x0000.0000	I2S Transmit FIFO Limit	742
0x010	I2STXISM	R/W	0x0000.0000	I2S Transmit Interrupt Status and Mask	743
0x018	I2STXLEV	RO	0x0000.0000	I2S Transmit FIFO Level	744
0x800	I2SRXFIFO	RO	0x0000.0000	I2S Receive FIFO Data	745
0x804	I2SRXFIFOCFG	R/W	0x0000.0000	I2S Receive FIFO Configuration	746
0x808	I2SRXCFCG	R/W	0x1400.7DF0	I2S Receive Module Configuration	747
0x80C	I2SRXLIMIT	R/W	0x0000.7FFF	I2S Receive FIFO Limit	750
0x810	I2SRXISM	R/W	0x0000.0000	I2S Receive Interrupt Status and Mask	751
0x818	I2SRXLEV	RO	0x0000.0000	I2S Receive FIFO Level	752
0xC00	I2SCFCG	R/W	0x0000.0000	I2S Module Configuration	753
0xC10	I2SIM	R/W	0x0000.0000	I2S Interrupt Mask	755
0xC14	I2SRIS	RO	0x0000.0000	I2S Raw Interrupt Status	757
0xC18	I2SMIS	RO	0x0000.0000	I2S Masked Interrupt Status	759
0xC1C	I2SIC	WO	0x0000.0000	I2S Interrupt Clear	761

## 17.6 Register Descriptions

The remainder of this section lists and describes the I<sup>2</sup>S registers, in numerical order by address offset.

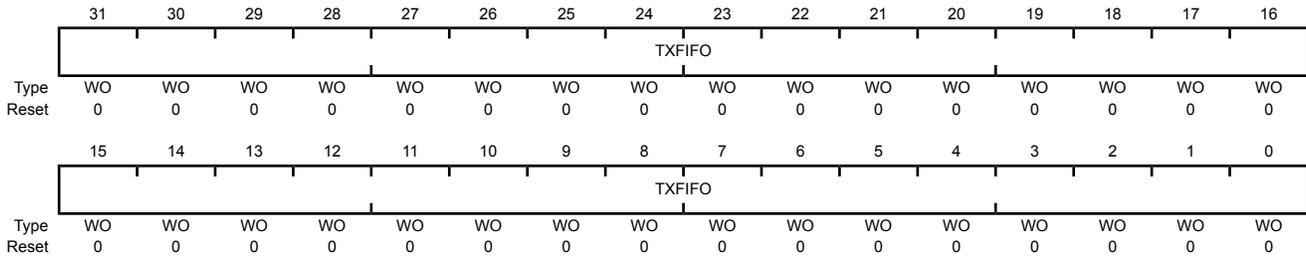
**Register 1: I<sup>2</sup>S Transmit FIFO Data (I2STXFIFO), offset 0x000**

This register is the 32-bit serial audio transmit data register. In Stereo mode, the data is written left, right, left, right, and so on. The *LRS* bit in the **I<sup>2</sup>S Transmit FIFO Configuration (I2STXFIFOCFG)** register can be read to verify the next position expected. In Compact 16-bit mode, bits [31:16] contain the right sample, and bits [15:0] contain the left sample. In Compact 8-bit mode, bits [15:8] contain the right sample, and bits [7:0] contain the left sample. In Mono mode, each 32-bit entry is a single sample.

Note that if the FIFO is full and a write is attempted, a transmit FIFO write error is generated.

I2S Transmit FIFO Data (I2STXFIFO)

Base 0x4005.4000  
 Offset 0x000  
 Type WO, reset 0x0000.0000



Bit/Field	Name	Type	Reset	Description
31:0	TXFIFO	WO	0x0000.0000	TX Data Serial audio sample data to be transmitted.

## Register 2: I<sup>2</sup>S Transmit FIFO Configuration (I2STXFIFOCFG), offset 0x004

This register configures the sample for dual-channel operation. In Stereo mode, the LRS bit toggles between left and right samples as the Transmit FIFO is written. The left sample is written first, followed by the right.

### I2S Transmit FIFO Configuration (I2STXFIFOCFG)

Base 0x4005.4000  
Offset 0x004  
Type R/W, reset 0x0000.0000

	31	30	29	28	27	26	25	24	23	22	21	20	19	18	17	16
	reserved															
Type	RO	RO	RO	RO	RO	RO	RO	RO	RO	RO	RO	RO	RO	RO	RO	RO
Reset	0	0	0	0	0	0	0	0	0	0	0	0	0	0	0	0
	15	14	13	12	11	10	9	8	7	6	5	4	3	2	1	0
	reserved														CSS	LRS
Type	RO	RO	RO	RO	RO	RO	RO	RO	RO	RO	RO	RO	RO	RO	R/W	R/W
Reset	0	0	0	0	0	0	0	0	0	0	0	0	0	0	0	0

Bit/Field	Name	Type	Reset	Description
31:2	reserved	RO	0x0000.000	Software should not rely on the value of a reserved bit. To provide compatibility with future products, the value of a reserved bit should be preserved across a read-modify-write operation.
1	CSS	R/W	0	Compact Stereo Sample Size  Value Description 0 The transmitter is in Compact 16-bit Stereo Mode with a 16-bit sample size. 1 The transmitter is in Compact 8-bit Stereo Mode with an 8-bit sample size.
0	LRS	R/W	0	Left-Right Sample Indicator  Value Description 0 The left sample is the next position. 1 The right sample is the next position.  In Mono mode and Compact stereo mode, this bit toggles as if it were in Stereo mode, but it has no meaning and should be ignored.

### Register 3: I<sup>2</sup>S Transmit Module Configuration (I2STXCFG), offset 0x008

This register controls the configuration of the Transmit module.

#### I2S Transmit Module Configuration (I2STXCFG)

Base 0x4005.4000  
 Offset 0x008  
 Type R/W, reset 0x1400.7DF0

	31	30	29	28	27	26	25	24	23	22	21	20	19	18	17	16
	reserved		JST	DLY	SCP	LRP	WM		FMT	MSL	reserved					
Type	RO	RO	R/W	R/W	R/W	R/W	R/W	R/W	R/W	R/W	RO	RO	RO	RO	RO	RO
Reset	0	0	0	1	0	1	0	0	0	0	0	0	0	0	0	0
	15	14	13	12	11	10	9	8	7	6	5	4	3	2	1	0
	SSZ				SDSZ						reserved					
Type	R/W	R/W	R/W	R/W	R/W	R/W	R/W	R/W	R/W	R/W	R/W	R/W	RO	RO	RO	RO
Reset	0	1	1	1	1	1	0	1	1	1	1	1	0	0	0	0

Bit/Field	Name	Type	Reset	Description
31:30	reserved	RO	0x0	Software should not rely on the value of a reserved bit. To provide compatibility with future products, the value of a reserved bit should be preserved across a read-modify-write operation.
29	JST	R/W	0	Justification of Output Data  Value Description 0 The data is Left-Justified. 1 The data is Right-Justified.
28	DLY	R/W	1	Data Delay  Value Description 0 Data is latched on the next latching edge of I2S0TXSCK as defined by the SCP bit. This bit should be clear in Left-Justified or Right-Justified mode. 1 A one-I2S0TXSCK delay from the edge of I2S0TXWS is inserted before data is latched. This bit should be set in I <sup>2</sup> S mode.
27	SCP	R/W	0	SCLK Polarity  Value Description 0 Data and the I2S0TXWS signal (when the MSL bit is set) are launched on the falling edge of I2S0TXSCK. 1 Data and the I2S0TXWS signal (when the MSL bit is set) are launched on the rising edge of I2S0TXSCK.
26	LRP	R/W	1	Left/Right Clock Polarity  Value Description 0 I2S0TXWS is high during the transmission of the left channel data. 1 I2S0TXWS is high during the transmission of the right channel data.

Bit/Field	Name	Type	Reset	Description
25:24	WM	R/W	0x0	<p>Write Mode</p> <p>This bit field selects the mode in which the transmit data is stored in the FIFO and transmitted.</p> <p>Value Description</p> <p>0x0 Stereo mode</p> <p>0x1 Compact Stereo mode</p> <p>Left/Right sample packed. Refer to <b>I2STXFIFOCFG</b> for 8/16-bit sample size selection.</p> <p>0x2 Mono mode</p> <p>0x3 reserved</p>
23	FMT	R/W	0	<p>FIFO Empty</p> <p>Value Description</p> <p>0 All zeroes are transmitted if the FIFO is empty.</p> <p>1 The last sample is transmitted if the FIFO is empty.</p>
22	MSL	R/W	0	<p>SCLK Master/Slave</p> <p>Source of serial bit clock (<b>I2S0TXSCK</b>) and Word Select (<b>I2S0TXWS</b>).</p> <p>Value Description</p> <p>0 The transmitter is a slave using the externally driven <b>I2S0TXSCK</b> and <b>I2S0TXWS</b> signals.</p> <p>1 The transmitter is a master using the internally generated <b>I2S0TXSCK</b> and <b>I2S0TXWS</b> signals.</p>
21:16	reserved	RO	0x00	<p>Software should not rely on the value of a reserved bit. To provide compatibility with future products, the value of a reserved bit should be preserved across a read-modify-write operation.</p>
15:10	SSZ	R/W	0x1F	<p>Sample Size</p> <p>This field contains the number of bits minus one in the sample.</p> <p><b>Note:</b> This field is only used in Right-Justified mode. Unused bits are not masked.</p>
9:4	SDSZ	R/W	0x1F	<p>System Data Size</p> <p>This field contains the number of bits minus one during the high or low phase of the <b>I2S0TXWS</b> signal.</p>
3:0	reserved	RO	0x0	<p>Software should not rely on the value of a reserved bit. To provide compatibility with future products, the value of a reserved bit should be preserved across a read-modify-write operation.</p>

### Register 4: I<sup>2</sup>S Transmit FIFO Limit (I2STXLIMIT), offset 0x00C

This register sets the lower FIFO limit at which a FIFO service request is issued.

#### I2S Transmit FIFO Limit (I2STXLIMIT)

Base 0x4005.4000  
 Offset 0x00C  
 Type R/W, reset 0x0000.0000

	31	30	29	28	27	26	25	24	23	22	21	20	19	18	17	16
	reserved															
Type	RO	RO	RO	RO	RO	RO	RO	RO	RO	RO	RO	RO	RO	RO	RO	RO
Reset	0	0	0	0	0	0	0	0	0	0	0	0	0	0	0	0
	15	14	13	12	11	10	9	8	7	6	5	4	3	2	1	0
	reserved												LIMIT			
Type	RO	RO	RO	RO	RO	RO	RO	RO	RO	RO	RO	R/W	R/W	R/W	R/W	R/W
Reset	0	0	0	0	0	0	0	0	0	0	0	0	0	0	0	0

Bit/Field	Name	Type	Reset	Description
31:5	reserved	RO	0x0000.00	Software should not rely on the value of a reserved bit. To provide compatibility with future products, the value of a reserved bit should be preserved across a read-modify-write operation.
4:0	LIMIT	R/W	0x00	<p>FIFO Limit</p> <p>This field sets the FIFO level at which a FIFO service request is issued, generating an interrupt or a <math>\mu</math>DMA transfer request.</p> <p>The transmit FIFO generates a service request when the number of items in the FIFO is less than the level specified by the <code>LIMIT</code> field. For example, if the <code>LIMIT</code> field is set to 8, then a service request is generated when there are less than 8 samples remaining in the transmit FIFO.</p>

**Register 5: I<sup>2</sup>S Transmit Interrupt Status and Mask (I2STXISM), offset 0x010**

This register indicates the transmit interrupt status and interrupt masking control.

**I2S Transmit Interrupt Status and Mask (I2STXISM)**

Base 0x4005.4000  
Offset 0x010  
Type R/W, reset 0x0000.0000

	31	30	29	28	27	26	25	24	23	22	21	20	19	18	17	16
	reserved															FFI
Type	RO	RO	RO	RO	RO	RO	RO	RO	RO	RO	RO	RO	RO	RO	RO	RO
Reset	0	0	0	0	0	0	0	0	0	0	0	0	0	0	0	0
	15	14	13	12	11	10	9	8	7	6	5	4	3	2	1	0
	reserved															FFM
Type	RO	RO	RO	RO	RO	RO	RO	RO	RO	RO	RO	RO	RO	RO	RO	R/W
Reset	0	0	0	0	0	0	0	0	0	0	0	0	0	0	0	0

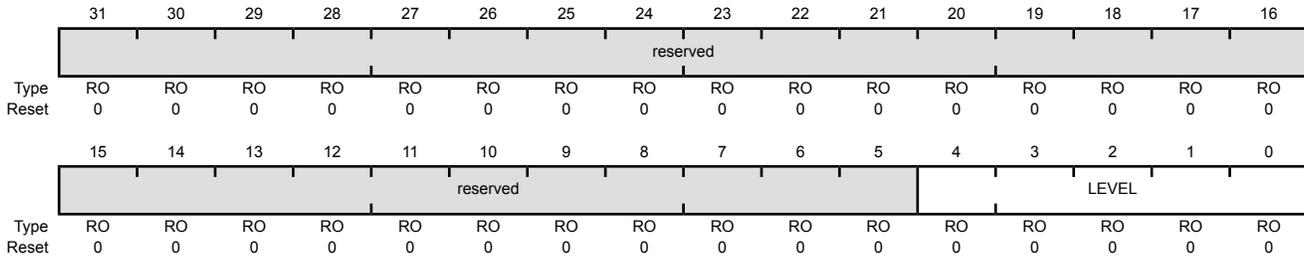
Bit/Field	Name	Type	Reset	Description
31:17	reserved	RO	0x000	Software should not rely on the value of a reserved bit. To provide compatibility with future products, the value of a reserved bit should be preserved across a read-modify-write operation.
16	FFI	RO	0	Transmit FIFO Service Request Interrupt  Value Description 0 The FIFO level is equal to or above the FIFO limit. 1 The FIFO level is below the FIFO limit.
15:1	reserved	RO	0x000	Software should not rely on the value of a reserved bit. To provide compatibility with future products, the value of a reserved bit should be preserved across a read-modify-write operation.
0	FFM	R/W	0	FIFO Interrupt Mask  Value Description 0 The FIFO interrupt is masked and not sent to the CPU. 1 The FIFO interrupt is enabled to be sent to the interrupt controller.

### Register 6: I<sup>2</sup>S Transmit FIFO Level (I2STXLEV), offset 0x018

The number of samples in the transmit FIFO can be read using the **I2STXLEV** register. The value ranges from 0 to 16. Stereo and Compact Stereo sample-pairs are counted as two. Mono samples also increment the count by two. For example, the **LEVEL** field is set to eight if there are four Mono samples.

#### I2S Transmit FIFO Level (I2STXLEV)

Base 0x4005.4000  
 Offset 0x018  
 Type RO, reset 0x0000.0000



Bit/Field	Name	Type	Reset	Description
31:5	reserved	RO	0x0000.00	Software should not rely on the value of a reserved bit. To provide compatibility with future products, the value of a reserved bit should be preserved across a read-modify-write operation.
4:0	LEVEL	RO	0x00	Number of Audio Samples  This field contains the number of samples in the FIFO.



## Register 7: I<sup>2</sup>S Receive FIFO Data (I2SRXFIFO), offset 0x800

**Important:** Use caution when reading this register. Performing a read may change bit status.

This register is the 32-bit serial audio receive data register. In Stereo mode, the data is read left, right, left, right, and so on. The  $LRS$  bit in the **I<sup>2</sup>S Receive FIFO Configuration (I2SRXFIFOCFG)** register can be read to verify the next position expected. In Compact 16-bit mode, bits [31:16] contain the right sample, and bits [15:0] contain the left sample. In Compact 8-bit mode, bits [15:8] contain the right sample, and bits [7:0] contain the left sample. In Mono mode, each 32-bit entry is a single sample. If the FIFO is empty, a read of this register returns a value of 0x0000.0000 and generates a receive FIFO read error.

### I2S Receive FIFO Data (I2SRXFIFO)

Base 0x4005.4000

Offset 0x800

Type RO, reset 0x0000.0000

	31	30	29	28	27	26	25	24	23	22	21	20	19	18	17	16
	RXFIFO															
Type	RO	RO	RO	RO	RO	RO	RO	RO	RO	RO	RO	RO	RO	RO	RO	RO
Reset	0	0	0	0	0	0	0	0	0	0	0	0	0	0	0	0
	15	14	13	12	11	10	9	8	7	6	5	4	3	2	1	0
	RXFIFO															
Type	RO	RO	RO	RO	RO	RO	RO	RO	RO	RO	RO	RO	RO	RO	RO	RO
Reset	0	0	0	0	0	0	0	0	0	0	0	0	0	0	0	0

Bit/Field	Name	Type	Reset	Description
31:0	RXFIFO	RO	0x0000.0000	RX Data

Serial audio sample data received.

The read of an empty FIFO returns a value of 0x0.

### Register 8: I<sup>2</sup>S Receive FIFO Configuration (I2SRXFIFOCFG), offset 0x804

This register configures the sample for dual-channel operation. In Stereo mode, the LRS bit toggles between Left and Right as the samples are read from the receive FIFO. In Mono mode, both the left and right samples are stored in the FIFO. The FMM bit can be used to read only the left or right sample as determined by the LRP bit. In Compact Stereo 8- or 16-bit mode, both the left and right samples are read in one access from the FIFO.

#### I2S Receive FIFO Configuration (I2SRXFIFOCFG)

Base 0x4005.4000  
 Offset 0x804  
 Type R/W, reset 0x0000.0000

	31	30	29	28	27	26	25	24	23	22	21	20	19	18	17	16
	reserved															
Type	RO	RO	RO	RO	RO	RO	RO	RO	RO	RO	RO	RO	RO	RO	RO	RO
Reset	0	0	0	0	0	0	0	0	0	0	0	0	0	0	0	0
	15	14	13	12	11	10	9	8	7	6	5	4	3	2	1	0
	reserved													FMM	CSS	LRS
Type	RO	RO	RO	RO	RO	RO	RO	RO	RO	RO	RO	RO	RO	R/W	R/W	R/W
Reset	0	0	0	0	0	0	0	0	0	0	0	0	0	0	0	0

Bit/Field	Name	Type	Reset	Description
31:3	reserved	RO	0x0000.000	Software should not rely on the value of a reserved bit. To provide compatibility with future products, the value of a reserved bit should be preserved across a read-modify-write operation.
2	FMM	R/W	0	FIFO Mono Mode  Value Description 0 The receiver is in Stereo Mode. 1 The receiver is in Mono mode.  If the LRP bit in the I2SRXCFG register is clear, data is read while the I2SORXWS signal is low (Right Channel); if the LRP bit is set, data is read while the I2SORXWS signal is high (Left Channel).
1	CSS	R/W	0	Compact Stereo Sample Size  Value Description 0 The receiver is in Compact 16-bit Stereo Mode with a 16-bit sample size. 1 The receiver is in Compact 8-bit Stereo Mode with a 8-bit sample size.
0	LRS	R/W	0	Left-Right Sample Indicator  Value Description 0 The left sample is the next position to be read. 1 The right sample is the next position to be read.  This bit is only meaningful in Compact Stereo Mode.

## Register 9: I<sup>2</sup>S Receive Module Configuration (I2SRXCFG), offset 0x808

This register controls the configuration of the receive module.

### I2S Receive Module Configuration (I2SRXCFG)

Base 0x4005.4000

Offset 0x808

Type R/W, reset 0x1400.7DF0

	31	30	29	28	27	26	25	24	23	22	21	20	19	18	17	16	
	reserved		JST	DLY	SCP	LRP	reserved	RM	reserved	MSL	reserved						
Type	RO	RO	R/W	R/W	R/W	R/W	RO	R/W	RO	R/W	RO	RO	RO	RO	RO	RO	
Reset	0	0	0	1	0	1	0	0	0	0	0	0	0	0	0	0	
	15	14	13	12	11	10	9	8	7	6	5	4	3	2	1	0	
	SSZ					SDSZ						reserved					
Type	R/W	R/W	R/W	R/W	R/W	R/W	R/W	R/W	R/W	R/W	R/W	R/W	R/W	RO	RO	RO	RO
Reset	0	1	1	1	1	1	0	1	1	1	1	1	0	0	0	0	

Bit/Field	Name	Type	Reset	Description
31:30	reserved	RO	0x0	Software should not rely on the value of a reserved bit. To provide compatibility with future products, the value of a reserved bit should be preserved across a read-modify-write operation.
29	JST	R/W	0	Justification of Input Data  Value Description 0 The data is Left-Justified. 1 The data is Right-Justified.
28	DLY	R/W	1	Data Delay  Value Description 0 Data is latched on the next latching edge of I2S0RXSCK as defined by the SCP bit. This bit should be clear in Left-Justified or Right-Justified mode. 1 A one-I2S0RXSCK delay from the edge of I2S0RXWS is inserted before data is latched. This bit should be set in I <sup>2</sup> S mode.
27	SCP	R/W	0	SCLK Polarity  Value Description 0 Data is latched on the rising edge and the I2S0RXWS signal (when the MSL bit is set) is launched on the falling edge of I2S0RXSCK. 1 Data is latched on the falling edge and the I2S0RXWS signal (when the MSL bit is set) is launched on the rising edge of I2S0RXSCK.

Bit/Field	Name	Type	Reset	Description
26	LRP	R/W	1	<p>Left/Right Clock Polarity</p> <p>Value Description</p> <p>0 In Stereo mode, I2S0RXWS is high during the transmission of the left channel data.</p> <p>In Mono mode, data is read while the I2S0RXWS signal is low (Right Channel).</p> <p>1 In Stereo mode, I2S0RXWS is high during the transmission of the right channel data.</p> <p>In Mono mode, data is read while the I2S0RXWS signal is high (Left Channel).</p>
25	reserved	RO	0	Software should not rely on the value of a reserved bit. To provide compatibility with future products, the value of a reserved bit should be preserved across a read-modify-write operation.
24	RM	R/W	0	<p>Read Mode</p> <p>This bit selects the mode in which the receive data is received and stored in the FIFO.</p> <p>Value Description</p> <p>0 Stereo/Mono mode</p> <p><b>I2SRXFIFOCFG</b> FMM bit specifies Stereo or Mono FIFO read behavior.</p> <p>1 Compact Stereo mode</p> <p>Left/Right sample packed. Refer to <b>I2SRXFIFOCFG</b> for 8/16-bit sample size selection.</p>
23	reserved	RO	0	Software should not rely on the value of a reserved bit. To provide compatibility with future products, the value of a reserved bit should be preserved across a read-modify-write operation.
22	MSL	R/W	0	<p>SCLK Master/Slave</p> <p>Value Description</p> <p>0 The receiver is a slave and uses the externally driven I2S0RXSCK and I2S0RXWS signals.</p> <p>1 The receiver is a master and uses the internally generated I2S0RXSCK and I2S0RXWS signals.</p>
21:16	reserved	RO	0x00	Software should not rely on the value of a reserved bit. To provide compatibility with future products, the value of a reserved bit should be preserved across a read-modify-write operation.
15:10	SSZ	R/W	0x1F	<p>Sample Size</p> <p>This field contains the number of bits minus one in the sample.</p>
9:4	SDSZ	R/W	0x1F	<p>System Data Size</p> <p>This field contains the number of bits minus one during the high or low phase of the I2S0RXWS signal.</p>

Bit/Field	Name	Type	Reset	Description
3:0	reserved	RO	0x0	Software should not rely on the value of a reserved bit. To provide compatibility with future products, the value of a reserved bit should be preserved across a read-modify-write operation.

### Register 10: I<sup>2</sup>S Receive FIFO Limit (I2SRXLIMIT), offset 0x80C

This register sets the upper FIFO limit at which a FIFO service request is issued.

#### I2S Receive FIFO Limit (I2SRXLIMIT)

Base 0x4005.4000  
 Offset 0x80C  
 Type R/W, reset 0x0000.7FFF

	31	30	29	28	27	26	25	24	23	22	21	20	19	18	17	16
	reserved															
Type	RO	RO	RO	RO	RO	RO	RO	RO	RO	RO	RO	RO	RO	RO	RO	RO
Reset	0	0	0	0	0	0	0	0	0	0	0	0	0	0	0	0
	15	14	13	12	11	10	9	8	7	6	5	4	3	2	1	0
	reserved												LIMIT			
Type	RO	RO	RO	RO	RO	RO	RO	RO	RO	RO	RO	R/W	R/W	R/W	R/W	R/W
Reset	1	1	1	1	1	1	1	1	1	1	1	1	1	1	1	1

Bit/Field	Name	Type	Reset	Description
31:16	reserved	RO	0x0000	Software should not rely on the value of a reserved bit. To provide compatibility with future products, the value of a reserved bit should be preserved across a read-modify-write operation.
15:5	reserved	RO	0x7FF	Software should not rely on the value of a reserved bit. To provide compatibility with future products, the value of a reserved bit should be preserved across a read-modify-write operation.
4:0	LIMIT	R/W	0x1F	FIFO Limit  This field sets the FIFO level at which a FIFO service request is issued, generating an interrupt or a $\mu$ DMA transfer request.  The receive FIFO generates a service request when the number of items in the FIFO is greater than the level specified by the LIMIT field. For example, if the LIMIT field is set to 4, then a service request is generated when there are more than 4 samples remaining in the transmit FIFO.

**Register 11: I<sup>2</sup>S Receive Interrupt Status and Mask (I2SRXISM), offset 0x810**

This register indicates the receive interrupt status and interrupt masking control.

**I2S Receive Interrupt Status and Mask (I2SRXISM)**

Base 0x4005.4000  
Offset 0x810  
Type R/W, reset 0x0000.0000

	31	30	29	28	27	26	25	24	23	22	21	20	19	18	17	16
	reserved															FFI
Type	RO	RO	RO	RO	RO	RO	RO	RO	RO	RO	RO	RO	RO	RO	RO	RO
Reset	0	0	0	0	0	0	0	0	0	0	0	0	0	0	0	0
	15	14	13	12	11	10	9	8	7	6	5	4	3	2	1	0
	reserved															FFM
Type	RO	RO	RO	RO	RO	RO	RO	RO	RO	RO	RO	RO	RO	RO	RO	R/W
Reset	0	0	0	0	0	0	0	0	0	0	0	0	0	0	0	0

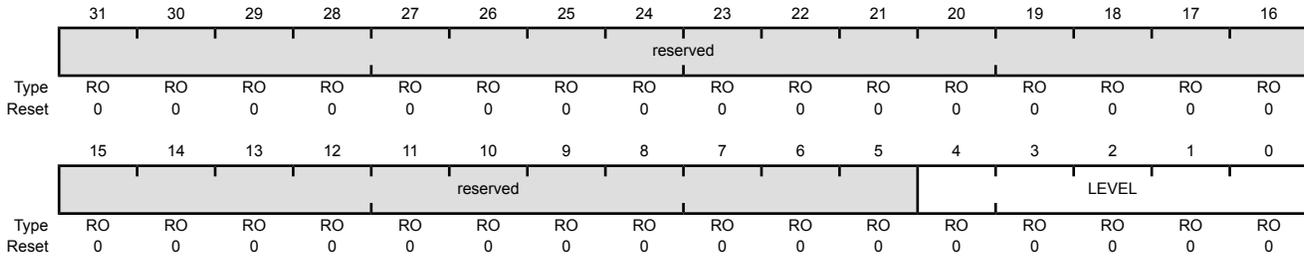
Bit/Field	Name	Type	Reset	Description
31:17	reserved	RO	0x000	Software should not rely on the value of a reserved bit. To provide compatibility with future products, the value of a reserved bit should be preserved across a read-modify-write operation.
16	FFI	RO	0	Receive FIFO Service Request Interrupt  Value Description 0 The FIFO level is equal to or below the FIFO limit. 1 The FIFO level is above the FIFO limit.
15:1	reserved	RO	0x000	Software should not rely on the value of a reserved bit. To provide compatibility with future products, the value of a reserved bit should be preserved across a read-modify-write operation.
0	FFM	R/W	0	FIFO Interrupt Mask  Value Description 0 The FIFO interrupt is masked and not sent to the CPU. 1 The FIFO interrupt is enabled to be sent to the interrupt controller.

### Register 12: I<sup>2</sup>S Receive FIFO Level (I2SRXLEV), offset 0x818

The number of samples in the receive FIFO can be read using the **I2SRXLEV** register. The value ranges from 0 to 16. Stereo and Compact Stereo sample pairs are counted as two. Mono samples also increment the count by two. For example, the LEVEL field is set to eight if there are four Mono samples.

#### I2S Receive FIFO Level (I2SRXLEV)

Base 0x4005.4000  
 Offset 0x818  
 Type RO, reset 0x0000.0000



Bit/Field	Name	Type	Reset	Description
31:5	reserved	RO	0x0000.00	Software should not rely on the value of a reserved bit. To provide compatibility with future products, the value of a reserved bit should be preserved across a read-modify-write operation.
4:0	LEVEL	RO	0x00	Number of Audio Samples This field contains the number of samples in the FIFO.



## Register 13: I<sup>2</sup>S Module Configuration (I2SCFG), offset 0xC00

This register enables the transmit and receive serial engines and sets the source of the I2S0TXMCLK and I2S0RXMCLK signals.

### I2S Module Configuration (I2SCFG)

Base 0x4005.4000  
Offset 0xC00  
Type R/W, reset 0x0000.0000

	31	30	29	28	27	26	25	24	23	22	21	20	19	18	17	16	
	reserved																
Type	RO	RO	RO	RO	RO	RO	RO	RO	RO	RO	RO	RO	RO	RO	RO	RO	
Reset	0	0	0	0	0	0	0	0	0	0	0	0	0	0	0	0	
	15	14	13	12	11	10	9	8	7	6	5	4	3	2	1	0	
	reserved											RXSLV	TXSLV	reserved		RXEN	TXEN
Type	RO	RO	RO	RO	RO	RO	RO	RO	RO	RO	RO	R/W	R/W	RO	RO	R/W	R/W
Reset	0	0	0	0	0	0	0	0	0	0	0	0	0	0	0	0	0

Bit/Field	Name	Type	Reset	Description
31:6	reserved	RO	0x0000.00	Software should not rely on the value of a reserved bit. To provide compatibility with future products, the value of a reserved bit should be preserved across a read-modify-write operation.
5	RXSLV	R/W	0	Use External I2S0RXMCLK  Value Description 0 The receiver uses the internally generated MCLK as the I2S0RXMCLK signal. See "Clock Control" on page 730 for information on how to program the I2S0RXMCLK. 1 The receiver uses the externally driven I2S0RXMCLK signal.
4	TXSLV	R/W	0	Use External I2S0TXMCLK  Value Description 0 The transmitter uses the internally generated MCLK as the I2S0TXMCLK signal. See "Clock Control" on page 730 for information on how to program the I2S0TXMCLK. 1 The transmitter uses the externally driven I2S0TXMCLK signal.
3:2	reserved	RO	0x0	Software should not rely on the value of a reserved bit. To provide compatibility with future products, the value of a reserved bit should be preserved across a read-modify-write operation.
1	RXEN	R/W	0	Serial Receive Engine Enable  Value Description 0 Disables the serial receive engine. 1 Enables the serial receive engine.

Bit/Field	Name	Type	Reset	Description
0	TXEN	R/W	0	Serial Transmit Engine Enable
				Value Description
				0 Disables the serial transmit engine.
				1 Enables the serial transmit engine.

## Register 14: I<sup>2</sup>S Interrupt Mask (I2SIM), offset 0xC10

This register masks the interrupts to the CPU.

### I2S Interrupt Mask (I2SIM)

Base 0x4005.4000  
Offset 0xC10  
Type R/W, reset 0x0000.0000

	31	30	29	28	27	26	25	24	23	22	21	20	19	18	17	16	
	reserved																
Type	RO	RO	RO	RO	RO	RO	RO	RO	RO	RO	RO	RO	RO	RO	RO	RO	
Reset	0	0	0	0	0	0	0	0	0	0	0	0	0	0	0	0	
	15	14	13	12	11	10	9	8	7	6	5	4	3	2	1	0	
	reserved											RXREIM	RXSRIM	reserved		TXWEIM	TXSRIM
Type	RO	RO	RO	RO	RO	RO	RO	RO	RO	RO	R/W	R/W	RO	RO	R/W	R/W	
Reset	0	0	0	0	0	0	0	0	0	0	0	0	0	0	0	0	

Bit/Field	Name	Type	Reset	Description
31:6	reserved	RO	0x0000.00	Software should not rely on the value of a reserved bit. To provide compatibility with future products, the value of a reserved bit should be preserved across a read-modify-write operation.
5	RXREIM	R/W	0	Receive FIFO Read Error  Value Description 0 The receive FIFO read error interrupt is masked and not sent to the CPU. 1 The receive FIFO read error is enabled to be sent to the interrupt controller.
4	RXSRIM	R/W	0	Receive FIFO Service Request  Value Description 0 The receive FIFO service request interrupt is masked and not sent to the CPU. 1 The receive FIFO service request is enabled to be sent to the interrupt controller.
3:2	reserved	RO	0x0	Software should not rely on the value of a reserved bit. To provide compatibility with future products, the value of a reserved bit should be preserved across a read-modify-write operation.
1	TXWEIM	R/W	0	Transmit FIFO Write Error  Value Description 0 The transmit FIFO write error interrupt is masked and not sent to the CPU. 1 The transmit FIFO write error is enabled to be sent to the interrupt controller.

Bit/Field	Name	Type	Reset	Description
0	TXSRIM	R/W	0	Transmit FIFO Service Request
				Value Description
				0 The transmit FIFO service request interrupt is masked and not sent to the CPU.
				1 The transmit FIFO service request is enabled to be sent to the interrupt controller.

## Register 15: I<sup>2</sup>S Raw Interrupt Status (I2SRIS), offset 0xC14

This register reads the unmasked interrupt status.

### I2S Raw Interrupt Status (I2SRIS)

Base 0x4005.4000  
Offset 0xC14  
Type RO, reset 0x0000.0000

	31	30	29	28	27	26	25	24	23	22	21	20	19	18	17	16	
	reserved																
Type	RO	RO	RO	RO	RO	RO	RO	RO	RO	RO	RO	RO	RO	RO	RO	RO	
Reset	0	0	0	0	0	0	0	0	0	0	0	0	0	0	0	0	
	15	14	13	12	11	10	9	8	7	6	5	4	3	2	1	0	
	reserved											RXRERIS	RXSRRIS	reserved		TXWERIS	TXSRRIS
Type	RO	RO	RO	RO	RO	RO	RO	RO	RO	RO	RO	RO	RO	RO	RO	RO	
Reset	0	0	0	0	0	0	0	0	0	0	0	0	0	0	0	0	

Bit/Field	Name	Type	Reset	Description
31:6	reserved	RO	0x0000.00	Software should not rely on the value of a reserved bit. To provide compatibility with future products, the value of a reserved bit should be preserved across a read-modify-write operation.
5	RXRERIS	RO	0	Receive FIFO Read Error  Value Description 1 A receive FIFO read error interrupt has occurred. 0 No interrupt  This bit is cleared by setting the <code>RXREIC</code> bit in the <code>I2SIC</code> register.
4	RXSRRIS	RO	0	Receive FIFO Service Request  Value Description 1 A receive FIFO service request interrupt has occurred. 0 No interrupt  This bit is cleared when the level in the receive FIFO has risen to a value greater than the value programmed in the <code>LIMIT</code> field in the <code>I2SRXLIMIT</code> register.
3:2	reserved	RO	0x0	Software should not rely on the value of a reserved bit. To provide compatibility with future products, the value of a reserved bit should be preserved across a read-modify-write operation.
1	TXWERIS	RO	0	Transmit FIFO Write Error  Value Description 1 A transmit FIFO write error interrupt has occurred. 0 No interrupt  This bit is cleared by setting the <code>TXWEIC</code> bit in the <code>I2SIC</code> register.

Bit/Field	Name	Type	Reset	Description
0	TXSRRIS	RO	0	Transmit FIFO Service Request
				Value Description
				1 A transmit FIFO service request interrupt has occurred.
				0 No interrupt
				This bit is cleared when the level in the transmit FIFO has fallen to a value less than the value programmed in the <code>LIMIT</code> field in the <b>I2STXLIMIT</b> register.

## Register 16: I<sup>2</sup>S Masked Interrupt Status (I2SMIS), offset 0xC18

This register reads the masked interrupt status. The mask is defined in the **I2SIM** register.

### I2S Masked Interrupt Status (I2SMIS)

Base 0x4005.4000  
Offset 0xC18  
Type RO, reset 0x0000.0000

	31	30	29	28	27	26	25	24	23	22	21	20	19	18	17	16	
	reserved																
Type	RO	RO	RO	RO	RO	RO	RO	RO	RO	RO	RO	RO	RO	RO	RO	RO	
Reset	0	0	0	0	0	0	0	0	0	0	0	0	0	0	0	0	
	15	14	13	12	11	10	9	8	7	6	5	4	3	2	1	0	
	reserved											RXREMIS	RXSRMIS	reserved		TXWEMIS	TXSRMIS
Type	RO	RO	RO	RO	RO	RO	RO	RO	RO	RO	RO	RO	RO	RO	RO	RO	
Reset	0	0	0	0	0	0	0	0	0	0	0	0	0	0	0	0	

Bit/Field	Name	Type	Reset	Description
31:6	reserved	RO	0x0000.00	Software should not rely on the value of a reserved bit. To provide compatibility with future products, the value of a reserved bit should be preserved across a read-modify-write operation.
5	RXREMIS	RO	0	Receive FIFO Read Error  Value Description 1 An unmasked interrupt was signaled due to a receive FIFO read error. 0 An interrupt has not occurred or is masked.  This bit is cleared by setting the <b>RXREIC</b> bit in the <b>I2SIC</b> register.
4	RXSRMIS	RO	0	Receive FIFO Service Request  Value Description 1 An unmasked interrupt was signaled due to a receive FIFO service request. 0 An interrupt has not occurred or is masked.  This bit is cleared when the level in the receive FIFO has risen to a value greater than the value programmed in the <b>LIMIT</b> field in the <b>I2SRXLIMIT</b> register.
3:2	reserved	RO	0s0	Software should not rely on the value of a reserved bit. To provide compatibility with future products, the value of a reserved bit should be preserved across a read-modify-write operation.
1	TXWEMIS	RO	0	Transmit FIFO Write Error  Value Description 1 An unmasked interrupt was signaled due to a transmit FIFO write error. 0 An interrupt has not occurred or is masked.  This bit is cleared by setting the <b>TXWEIC</b> bit in the <b>I2SIC</b> register.

Bit/Field	Name	Type	Reset	Description
0	TXSRMIS	RO	0	Transmit FIFO Service Request  Value Description 1 An unmasked interrupt was signaled due to a transmit FIFO service request. 0 An interrupt has not occurred or is masked.  This bit is cleared when the level in the transmit FIFO has fallen to a value less than the value programmed in the <code>LIMIT</code> field in the <b>I2STXLIMIT</b> register.



## Register 17: I<sup>2</sup>S Interrupt Clear (I2SIC), offset 0xC1C

Writing a 1 to a bit in this register clears the corresponding interrupt.

### I2S Interrupt Clear (I2SIC)

Base 0x4005.4000  
Offset 0xC1C  
Type WO, reset 0x0000.0000

	31	30	29	28	27	26	25	24	23	22	21	20	19	18	17	16
	reserved															
Type	WO	WO	WO	WO	WO	WO	WO	WO	WO	WO	WO	WO	WO	WO	WO	WO
Reset	0	0	0	0	0	0	0	0	0	0	0	0	0	0	0	0
	15	14	13	12	11	10	9	8	7	6	5	4	3	2	1	0
	reserved										RXREIC	reserved			TXWEIC	reserved
Type	WO	WO	WO	WO	WO	WO	WO	WO	WO	WO	WO	WO	WO	WO	WO	WO
Reset	0	0	0	0	0	0	0	0	0	0	0	0	0	0	0	0

Bit/Field	Name	Type	Reset	Description
31:6	reserved	WO	0x0000.00	Software should not rely on the value of a reserved bit. To provide compatibility with future products, the value of a reserved bit should be preserved across a read-modify-write operation.
5	RXREIC	WO	0	Receive FIFO Read Error  Writing a 1 to this bit clears the <code>RXRERIS</code> bit in the <b>I2CRIS</b> register and the <code>RXREMIS</code> bit in the <b>I2CMIS</b> register.
4:2	reserved	WO	0x0	Software should not rely on the value of a reserved bit. To provide compatibility with future products, the value of a reserved bit should be preserved across a read-modify-write operation.
1	TXWEIC	WO	0	Transmit FIFO Write Error  Writing a 1 to this bit clears the <code>TXWERIS</code> bit in the <b>I2CRIS</b> register and the <code>TXWEMIS</code> bit in the <b>I2CMIS</b> register.
0	reserved	WO	0	Software should not rely on the value of a reserved bit. To provide compatibility with future products, the value of a reserved bit should be preserved across a read-modify-write operation.

## 18 Controller Area Network (CAN) Module

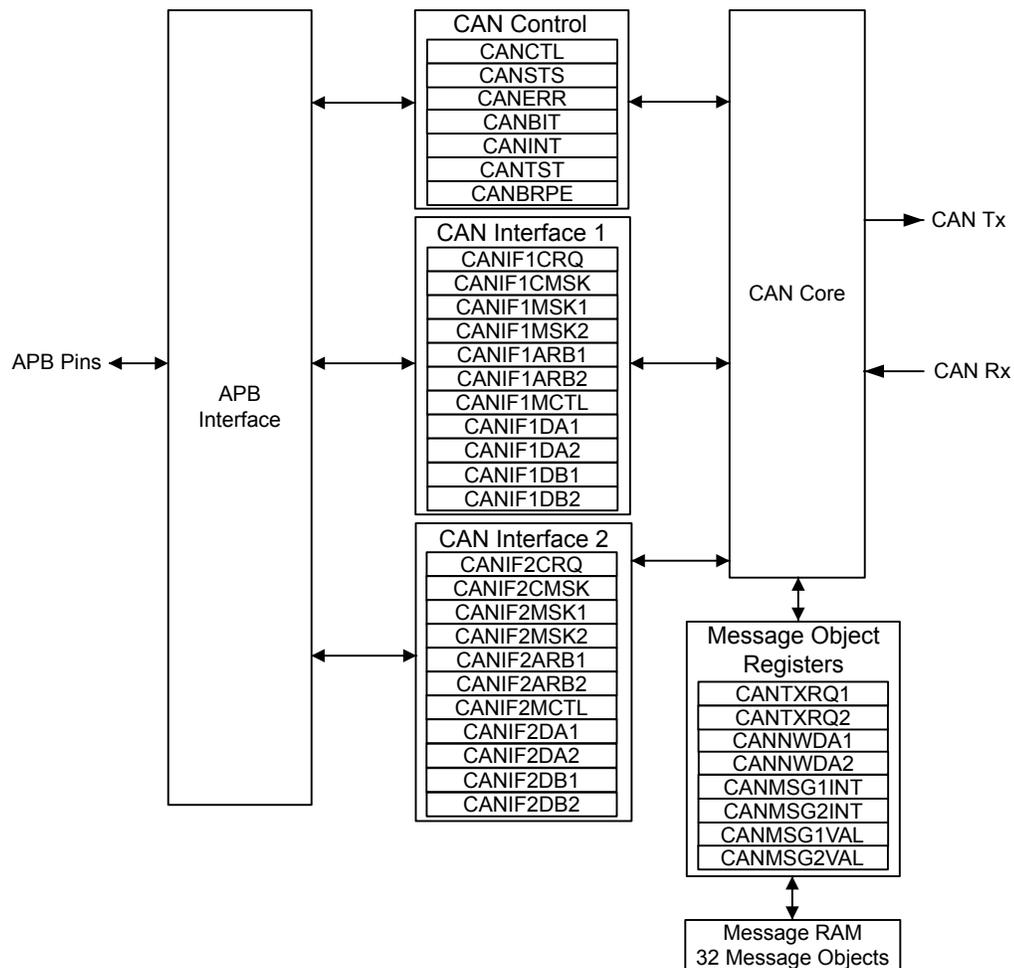
Controller Area Network (CAN) is a multicast, shared serial bus standard for connecting electronic control units (ECUs). CAN was specifically designed to be robust in electromagnetically-noisy environments and can utilize a differential balanced line like RS-485 or a more robust twisted-pair wire. Originally created for automotive purposes, it is also used in many embedded control applications (such as industrial and medical). Bit rates up to 1 Mbps are possible at network lengths less than 40 meters. Decreased bit rates allow longer network distances (for example, 125 Kbps at 500 meters).

The Stellaris<sup>®</sup> LM3S9B96 microcontroller includes two CAN units with the following features:

- CAN protocol version 2.0 part A/B
- Bit rates up to 1 Mbps
- 32 message objects with individual identifier masks
- Maskable interrupt
- Disable Automatic Retransmission mode for Time-Triggered CAN (TTCAN) applications
- Programmable Loopback mode for self-test operation
- Programmable FIFO mode enables storage of multiple message objects
- Gluelessly attaches to an external CAN transceiver through the CAN<sub>n</sub>TX and CAN<sub>n</sub>RX signals

## 18.1 Block Diagram

Figure 18-1. CAN Controller Block Diagram



## 18.2 Signal Description

Table 18-1 on page 764 and Table 18-2 on page 764 list the external signals of the CAN controller and describe the function of each. The CAN controller signals are alternate functions for some GPIO signals and default to be GPIO signals at reset. The column in the table below titled "Pin Mux/Pin Assignment" lists the possible GPIO pin placements for the CAN signals. The **AFSEL** bit in the **GPIO Alternate Function Select (GPIOAFSEL)** register (page 328) should be set to choose the CAN controller function. The number in parentheses is the encoding that must be programmed into the **PMC<sub>n</sub>** field in the **GPIO Port Control (GPIOCTL)** register (page 346) to assign the CAN signal to the specified GPIO port pin. For more information on configuring GPIOs, see "General-Purpose Input/Outputs (GPIOs)" on page 304.

Table 18-1. Signals for Controller Area Network (100LQFP)

Pin Name	Pin Number	Pin Mux / Pin Assignment	Pin Type	Buffer Type <sup>a</sup>	Description
CAN0Rx	10	PD0 (2)	I	TTL	CAN module 0 receive.
	30	PA4 (5)			
	34	PA6 (6)			
	92	PB4 (5)			
CAN0Tx	11	PD1 (2)	O	TTL	CAN module 0 transmit.
	31	PA5 (5)			
	35	PA7 (6)			
	91	PB5 (5)			
CAN1Rx	47	PF0 (1)	I	TTL	CAN module 1 receive.
CAN1Tx	61	PF1 (1)	O	TTL	CAN module 1 transmit.

a. The TTL designation indicates the pin has TTL-compatible voltage levels.

Table 18-2. Signals for Controller Area Network (108BGA)

Pin Name	Pin Number	Pin Mux / Pin Assignment	Pin Type	Buffer Type <sup>a</sup>	Description
CAN0Rx	G1	PD0 (2)	I	TTL	CAN module 0 receive.
	L5	PA4 (5)			
	L6	PA6 (6)			
	A6	PB4 (5)			
CAN0Tx	G2	PD1 (2)	O	TTL	CAN module 0 transmit.
	M5	PA5 (5)			
	M6	PA7 (6)			
	B7	PB5 (5)			
CAN1Rx	M9	PF0 (1)	I	TTL	CAN module 1 receive.
CAN1Tx	H12	PF1 (1)	O	TTL	CAN module 1 transmit.

a. The TTL designation indicates the pin has TTL-compatible voltage levels.

## 18.3 Functional Description

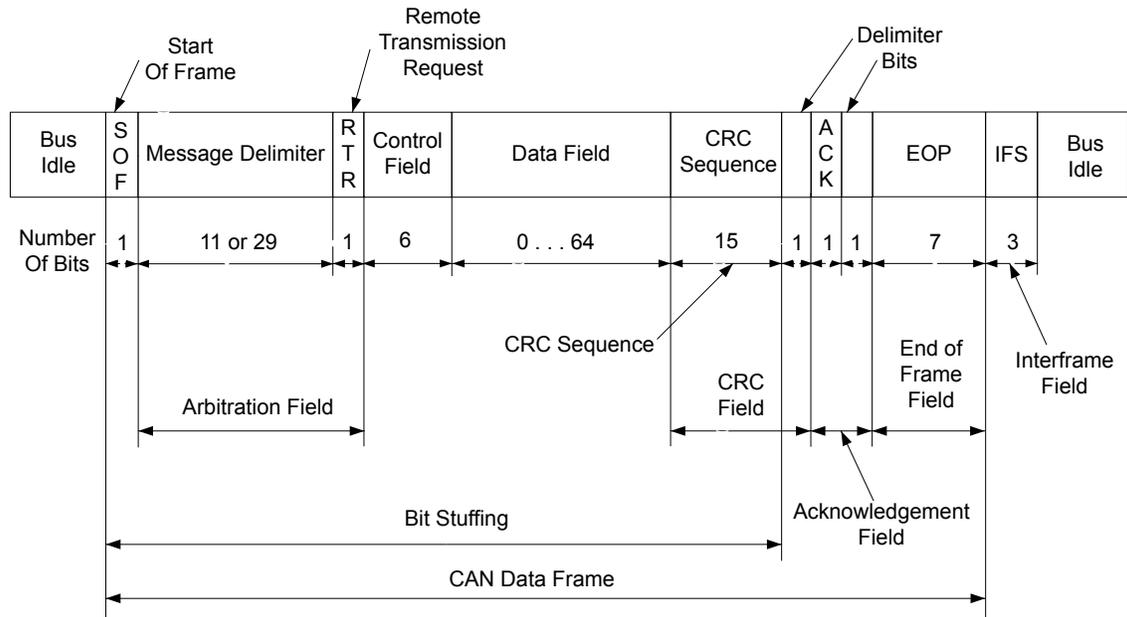
The Stellaris<sup>®</sup> CAN controller conforms to the CAN protocol version 2.0 (parts A and B). Message transfers that include data, remote, error, and overload frames with an 11-bit identifier (standard) or a 29-bit identifier (extended) are supported. Transfer rates can be programmed up to 1 Mbps.

The CAN module consists of three major parts:

- CAN protocol controller and message handler
- Message memory
- CAN register interface

A data frame contains data for transmission, whereas a remote frame contains no data and is used to request the transmission of a specific message object. The CAN data/remote frame is constructed as shown in Figure 18-2.

Figure 18-2. CAN Data/Remote Frame



The protocol controller transfers and receives the serial data from the CAN bus and passes the data on to the message handler. The message handler then loads this information into the appropriate message object based on the current filtering and identifiers in the message object memory. The message handler is also responsible for generating interrupts based on events on the CAN bus.

The message object memory is a set of 32 identical memory blocks that hold the current configuration, status, and actual data for each message object. These memory blocks are accessed via either of the CAN message object register interfaces.

The message memory is not directly accessible in the Stellaris® memory map, so the Stellaris® CAN controller provides an interface to communicate with the message memory via two CAN interface register sets for communicating with the message objects. The message object memory cannot be directly accessed, so these two interfaces must be used to read or write to each message object. The two message object interfaces allow parallel access to the CAN controller message objects when multiple objects may have new information that must be processed. In general, one interface is used for transmit data and one for receive data.

### 18.3.1 Initialization

To use the CAN controller, the peripheral clock must be enabled using the **RCGC0** register (see page 173). In addition, the clock to the appropriate GPIO module must be enabled via the **RCGC2** register (see page 193). To find out which GPIO port to enable, refer to Table 25-4 on page 1151. Set the GPIO **AFSEL** bits for the appropriate pins (see page 328). Configure the **PMC<sub>n</sub>** fields in the **GPIOPCTL** register to assign the CAN signals to the appropriate pins. See page 346 and Table 25-5 on page 1160.

Software initialization is started by setting the **INIT** bit in the **CAN Control (CANCTL)** register (with software or by a hardware reset) or by going bus-off, which occurs when the transmitter's error counter exceeds a count of 255. While **INIT** is set, all message transfers to and from the CAN bus are stopped and the **CAN<sub>n</sub>TX** signal is held High. Entering the initialization state does not change the configuration of the CAN controller, the message objects, or the error counters. However, some configuration registers are only accessible while in the initialization state.

To initialize the CAN controller, set the **CAN Bit Timing (CANBIT)** register and configure each message object. If a message object is not needed, label it as not valid by clearing the `MSGVAL` bit in the **CAN IFn Arbitration 2 (CANIFnARB2)** register. Otherwise, the whole message object must be initialized, as the fields of the message object may not have valid information, causing unexpected results. Both the `INIT` and `CCE` bits in the **CANCTL** register must be set in order to access the **CANBIT** register and the **CAN Baud Rate Prescaler Extension (CANBRPE)** register to configure the bit timing. To leave the initialization state, the `INIT` bit must be cleared. Afterwards, the internal Bit Stream Processor (BSP) synchronizes itself to the data transfer on the CAN bus by waiting for the occurrence of a sequence of 11 consecutive recessive bits (indicating a bus idle condition) before it takes part in bus activities and starts message transfers. Message object initialization does not require the CAN to be in the initialization state and can be done on the fly. However, message objects should all be configured to particular identifiers or set to not valid before message transfer starts. To change the configuration of a message object during normal operation, clear the `MSGVAL` bit in the **CANIFnARB2** register to indicate that the message object is not valid during the change. When the configuration is completed, set the `MSGVAL` bit again to indicate that the message object is once again valid.

### 18.3.2 Operation

Two sets of CAN Interface Registers (**CANIF1x** and **CANIF2x**) are used to access the message objects in the Message RAM. The CAN controller coordinates transfers to and from the Message RAM to and from the registers. The two sets are independent and identical and can be used to queue transactions. Generally, one interface is used to transmit data and one is used to receive data.

Once the CAN module is initialized and the `INIT` bit in the **CANCTL** register is cleared, the CAN module synchronizes itself to the CAN bus and starts the message transfer. As each message is received, it goes through the message handler's filtering process, and if it passes through the filter, is stored in the message object specified by the `MNUM` bit in the **CAN IFn Command Request (CANIFnCRQ)** register. The whole message (including all arbitration bits, data-length code, and eight data bytes) is stored in the message object. If the Identifier Mask (the `MSK` bits in the **CAN IFn Mask 1** and **CAN IFn Mask 2 (CANIFnMSKn)** registers) is used, the arbitration bits that are masked to "don't care" may be overwritten in the message object.

The CPU may read or write each message at any time via the CAN Interface Registers. The message handler guarantees data consistency in case of concurrent accesses.

The transmission of message objects is under the control of the software that is managing the CAN hardware. Message objects can be used for one-time data transfers or can be permanent message objects used to respond in a more periodic manner. Permanent message objects have all arbitration and control set up, and only the data bytes are updated. At the start of transmission, the appropriate `TXRQST` bit in the **CAN Transmission Request n (CANTXRQn)** register and the `NEWDAT` bit in the **CAN New Data n (CANNWDAn)** register are set. If several transmit messages are assigned to the same message object (when the number of message objects is not sufficient), the whole message object has to be configured before the transmission of this message is requested.

The transmission of any number of message objects may be requested at the same time; they are transmitted according to their internal priority, which is based on the message identifier (`MNUM`) for the message object, with 1 being the highest priority and 32 being the lowest priority. Messages may be updated or set to not valid any time, even when their requested transmission is still pending. The old data is discarded when a message is updated before its pending transmission has started. Depending on the configuration of the message object, the transmission of a message may be requested autonomously by the reception of a remote frame with a matching identifier.

Transmission can be automatically started by the reception of a matching remote frame. To enable this mode, set the `RMTEN` bit in the **CAN IFn Message Control (CANIFnMCTL)** register. A matching received remote frame causes the `TXRQST` bit to be set, and the message object automatically transfers its data or generates an interrupt indicating a remote frame was requested. A remote frame can be strictly a single message identifier, or it can be a range of values specified in the message object. The CAN mask registers, **CANIFnMSKn**, configure which groups of frames are identified as remote frame requests. The `UMASK` bit in the **CANIFnMCTL** register enables the `MSK` bits in the **CANIFnMSKn** register to filter which frames are identified as a remote frame request. The `MXTD` bit in the **CANIFnMSK2** register should be set if a remote frame request is expected to be triggered by 29-bit extended identifiers.

### 18.3.3 Transmitting Message Objects

If the internal transmit shift register of the CAN module is ready for loading, and if a data transfer is not occurring between the CAN Interface Registers and message RAM, the valid message object with the highest priority that has a pending transmission request is loaded into the transmit shift register by the message handler and the transmission is started. The message object's `NEWDAT` bit in the **CANNWDAn** register is cleared. After a successful transmission, and if no new data was written to the message object since the start of the transmission, the `TXRQST` bit in the **CANTXRQn** register is cleared. If the CAN controller is configured to interrupt on a successful transmission of a message object, (the `TXIE` bit in the **CAN IFn Message Control (CANIFnMCTL)** register is set), the `INTPND` bit in the **CANIFnMCTL** register is set after a successful transmission. If the CAN module has lost the arbitration or if an error occurred during the transmission, the message is re-transmitted as soon as the CAN bus is free again. If, meanwhile, the transmission of a message with higher priority has been requested, the messages are transmitted in the order of their priority.

### 18.3.4 Configuring a Transmit Message Object

The following steps illustrate how to configure a transmit message object.

1. In the **CAN IFn Command Mask (CANIFnCMASK)** register:
  - Set the `WRNRD` bit to specify a write to the **CANIFnCMASK** register; specify whether to transfer the `IDMASK`, `DIR`, and `MXTD` of the message object into the **CAN IFn** registers using the `MASK` bit
  - Specify whether to transfer the `ID`, `DIR`, `XTD`, and `MSGVAL` of the message object into the interface registers using the `ARB` bit
  - Specify whether to transfer the control bits into the interface registers using the `CONTROL` bit
  - Specify whether to clear the `INTPND` bit in the **CANIFnMCTL** register using the `CLRINTPND` bit
  - Specify whether to clear the `NEWDAT` bit in the **CANNWDAn** register using the `NEWDAT` bit
  - Specify which bits to transfer using the `DATAA` and `DATAB` bits
2. In the **CANIFnMSK1** register, use the `MSK[15:0]` bits to specify which of the bits in the 29-bit or 11-bit message identifier are used for acceptance filtering. Note that `MSK[15:0]` in this register are used for bits [15:0] of the 29-bit message identifier and are not used for an 11-bit identifier. A value of 0x00 enables all messages to pass through the acceptance filtering. Also

note that in order for these bits to be used for acceptance filtering, they must be enabled by setting the `UMASK` bit in the **CANIFnMCTL** register.

3. In the **CANIFnMSK2** register, use the `MSK[12:0]` bits to specify which of the bits in the 29-bit or 11-bit message identifier are used for acceptance filtering. Note that `MSK[12:0]` are used for bits [28:16] of the 29-bit message identifier; whereas `MSK[12:2]` are used for bits [10:0] of the 11-bit message identifier. Use the `MXTD` and `MDIR` bits to specify whether to use `XTD` and `DIR` for acceptance filtering. A value of 0x00 enables all messages to pass through the acceptance filtering. Also note that in order for these bits to be used for acceptance filtering, they must be enabled by setting the `UMASK` bit in the **CANIFnMCTL** register.
4. For a 29-bit identifier, configure `ID[15:0]` in the **CANIFnARB1** register to are used for bits [15:0] of the message identifier and `ID[12:0]` in the **CANIFnARB2** register to are used for bits [28:16] of the message identifier. Set the `XTD` bit to indicate an extended identifier; set the `DIR` bit to indicate transmit; and set the `MSGVAL` bit to indicate that the message object is valid.
5. For an 11-bit identifier, disregard the **CANIFnARB1** register and configure `ID[12:2]` in the **CANIFnARB2** register to are used for bits [10:0] of the message identifier. Clear the `XTD` bit to indicate a standard identifier; set the `DIR` bit to indicate transmit; and set the `MSGVAL` bit to indicate that the message object is valid.
6. In the **CANIFnMCTL** register:
  - Optionally set the `UMASK` bit to enable the mask (`MSK`, `MXTD`, and `MDIR` specified in the **CANIFnMSK1** and **CANIFnMSK2** registers) for acceptance filtering
  - Optionally set the `TXIE` bit to enable the `INTPND` bit to be set after a successful transmission
  - Optionally set the `RMTEN` bit to enable the `TXRQST` bit to be set on the reception of a matching remote frame allowing automatic transmission
  - Set the `EOB` bit for a single message object
  - Configure the `DLC[3:0]` field to specify the size of the data frame. Take care during this configuration not to set the `NEWDAT`, `MSGLST`, `INTPND` or `TXRQST` bits.
7. Load the data to be transmitted into the **CAN IFn Data (CANIFnDA1, CANIFnDA2, CANIFnDB1, CANIFnDB2)** registers. Byte 0 of the CAN data frame is stored in `DATA[7:0]` in the **CANIFnDA1** register.
8. Program the number of the message object to be transmitted in the `MNUM` field in the **CAN IFn Command Request (CANIFnCRQ)** register.
9. When everything is properly configured, set the `TXRQST` bit in the **CANIFnMCTL** register. Once this bit is set, the message object is available to be transmitted, depending on priority and bus availability. Note that setting the `RMTEN` bit in the **CANIFnMCTL** register can also start message transmission if a matching remote frame has been received.

### 18.3.5 Updating a Transmit Message Object

The CPU may update the data bytes of a Transmit Message Object any time via the CAN Interface Registers and neither the `MSGVAL` bit in the **CANIFnARB2** register nor the `TXRQST` bits in the **CANIFnMCTL** register have to be cleared before the update.



Even if only some of the data bytes are to be updated, all four bytes of the corresponding **CANIFnDAn/CANIFnDBn** register have to be valid before the content of that register is transferred to the message object. Either the CPU must write all four bytes into the **CANIFnDAn/CANIFnDBn** register or the message object is transferred to the **CANIFnDAn/CANIFnDBn** register before the CPU writes the new data bytes.

In order to only update the data in a message object, the **WRNRD**, **DATAA** and **DATAB** bits in the **CANIFnMSKn** register are set, followed by writing the updated data into **CANIFnDA1**, **CANIFnDA2**, **CANIFnDB1**, and **CANIFnDB2** registers, and then the number of the message object is written to the **MNUM** field in the **CAN IFn Command Request (CANIFnCRQ)** register. To begin transmission of the new data as soon as possible, set the **TXRQST** bit in the **CANIFnMSKn** register.

To prevent the clearing of the **TXRQST** bit in the **CANIFnMCTL** register at the end of a transmission that may already be in progress while the data is updated, the **NEWDAT** and **TXRQST** bits have to be set at the same time in the **CANIFnMCTL** register. When these bits are set at the same time, **NEWDAT** is cleared as soon as the new transmission has started.

### 18.3.6 Accepting Received Message Objects

When the arbitration and control field (the **ID** and **XTD** bits in the **CANIFnARB2** and the **RMTEN** and **DLC[3:0]** bits of the **CANIFnMCTL** register) of an incoming message is completely shifted into the CAN controller, the message handling capability of the controller starts scanning the message RAM for a matching valid message object. To scan the message RAM for a matching message object, the controller uses the acceptance filtering programmed through the mask bits in the **CANIFnMSKn** register and enabled using the **UMASK** bit in the **CANIFnMCTL** register. Each valid message object, starting with object 1, is compared with the incoming message to locate a matching message object in the message RAM. If a match occurs, the scanning is stopped and the message handler proceeds depending on whether it is a data frame or remote frame that was received.

### 18.3.7 Receiving a Data Frame

The message handler stores the message from the CAN controller receive shift register into the matching message object in the message RAM. The data bytes, all arbitration bits, and the **DLC** bits are all stored into the corresponding message object. In this manner, the data bytes are connected with the identifier even if arbitration masks are used. The **NEWDAT** bit of the **CANIFnMCTL** register is set to indicate that new data has been received. The CPU should clear this bit when it reads the message object to indicate to the controller that the message has been received, and the buffer is free to receive more messages. If the CAN controller receives a message and the **NEWDAT** bit is already set, the **MSGLST** bit in the **CANIFnMCTL** register is set to indicate that the previous data was lost. If the system requires an interrupt on successful reception of a frame, the **RXIE** bit of the **CANIFnMCTL** register should be set. In this case, the **INTPND** bit of the same register is set, causing the **CANINT** register to point to the message object that just received a message. The **TXRQST** bit of this message object should be cleared to prevent the transmission of a remote frame.

### 18.3.8 Receiving a Remote Frame

A remote frame contains no data, but instead specifies which object should be transmitted. When a remote frame is received, three different configurations of the matching message object have to be considered:

Table 18-3. Message Object Configurations

Configuration in CANIFnMCTL	Description
<ul style="list-style-type: none"> <li>■ DIR = 1 (direction = transmit); programmed in the <b>CANIFnARB2</b> register</li> <li>■ RMTEN = 1 (set the TXRQST bit of the <b>CANIFnMCTL</b> register at reception of the frame to enable transmission)</li> <li>■ UMASK = 1 or 0</li> </ul>	At the reception of a matching remote frame, the TXRQST bit of this message object is set. The rest of the message object remains unchanged, and the controller automatically transfers the data in the message object as soon as possible.
<ul style="list-style-type: none"> <li>■ DIR = 1 (direction = transmit); programmed in the <b>CANIFnARB2</b> register</li> <li>■ RMTEN = 0 (do not change the TXRQST bit of the <b>CANIFnMCTL</b> register at reception of the frame)</li> <li>■ UMASK = 0 (ignore mask in the <b>CANIFnMSKn</b> register)</li> </ul>	At the reception of a matching remote frame, the TXRQST bit of this message object remains unchanged, and the remote frame is ignored. This remote frame is disabled, the data is not transferred and nothing indicates that the remote frame ever happened.
<ul style="list-style-type: none"> <li>■ DIR = 1 (direction = transmit); programmed in the <b>CANIFnARB2</b> register</li> <li>■ RMTEN = 0 (do not change the TXRQST bit of the <b>CANIFnMCTL</b> register at reception of the frame)</li> <li>■ UMASK = 1 (use mask (MSK, MXTD, and MDIR in the <b>CANIFnMSKn</b> register) for acceptance filtering)</li> </ul>	At the reception of a matching remote frame, the TXRQST bit of this message object is cleared. The arbitration and control field (ID + XTD + RMTEN + DLC) from the shift register is stored into the message object in the message RAM, and the NEWDAT bit of this message object is set. The data field of the message object remains unchanged; the remote frame is treated similar to a received data frame. This mode is useful for a remote data request from another CAN device for which the Stellaris® controller does not have readily available data. The software must fill the data and answer the frame manually.

### 18.3.9 Receive/Transmit Priority

The receive/transmit priority for the message objects is controlled by the message number. Message object 1 has the highest priority, while message object 32 has the lowest priority. If more than one transmission request is pending, the message objects are transmitted in order based on the message object with the lowest message number. This prioritization is separate from that of the message identifier which is enforced by the CAN bus. As a result, if message object 1 and message object 2 both have valid messages to be transmitted, message object 1 is always transmitted first regardless of the message identifier in the message object itself.

### 18.3.10 Configuring a Receive Message Object

The following steps illustrate how to configure a receive message object.

1. Program the **CAN IFn Command Mask (CANIFnCMASK)** register as described in the “Configuring a Transmit Message Object” on page 767 section, except that the WRNRD bit is set to specify a write to the message RAM.
2. Program the **CANIFnMSK1** and **CANIFnMSK2** registers as described in the “Configuring a Transmit Message Object” on page 767 section to configure which bits are used for acceptance filtering. Note that in order for these bits to be used for acceptance filtering, they must be enabled by setting the UMASK bit in the **CANIFnMCTL** register.
3. In the **CANIFnMSK2** register, use the MSK[12:0] bits to specify which of the bits in the 29-bit or 11-bit message identifier are used for acceptance filtering. Note that MSK[12:0] are used for bits [28:16] of the 29-bit message identifier; whereas MSK[12:2] are used for bits [10:0] of

the 11-bit message identifier. Use the `MXTD` and `MDIR` bits to specify whether to use `XTD` and `DIR` for acceptance filtering. A value of `0x00` enables all messages to pass through the acceptance filtering. Also note that in order for these bits to be used for acceptance filtering, they must be enabled by setting the `UMASK` bit in the **CANIFnMCTL** register.

4. Program the **CANIFnARB1** and **CANIFnARB2** registers as described in the “Configuring a Transmit Message Object” on page 767 section to program `XTD` and `ID` bits for the message identifier to be received; set the `MSGVAL` bit to indicate a valid message; and clear the `DIR` bit to specify receive.
5. In the **CANIFnMCTL** register:
  - Optionally set the `UMASK` bit to enable the mask (`MSK`, `MXTD`, and `MDIR` specified in the **CANIFnMSK1** and **CANIFnMSK2** registers) for acceptance filtering
  - Optionally set the `RXIE` bit to enable the `INTPND` bit to be set after a successful reception
  - Clear the `RMTEN` bit to leave the `TXRQST` bit unchanged
  - Set the `EOB` bit for a single message object
  - Configure the `DLC[3:0]` field to specify the size of the data frame

Take care during this configuration not to set the `NEWDAT`, `MSGLST`, `INTPND` or `TXRQST` bits.
6. Program the number of the message object to be received in the `MNUM` field in the **CAN IFn Command Request (CANIFnCRQ)** register. Reception of the message object begins as soon as a matching frame is available on the CAN bus.

When the message handler stores a data frame in the message object, it stores the received Data Length Code and eight data bytes in the **CANIFnDA1**, **CANIFnDA2**, **CANIFnDB1**, and **CANIFnDB2** register. Byte 0 of the CAN data frame is stored in `DATA[7:0]` in the **CANIFnDA1** register. If the Data Length Code is less than 8, the remaining bytes of the message object are overwritten by unspecified values.

The CAN mask registers can be used to allow groups of data frames to be received by a message object. The CAN mask registers, **CANIFnMSKn**, configure which groups of frames are received by a message object. The `UMASK` bit in the **CANIFnMCTL** register enables the `MSK` bits in the **CANIFnMSKn** register to filter which frames are received. The `MXTD` bit in the **CANIFnMSK2** register should be set if only 29-bit extended identifiers are expected by this message object.

### 18.3.11 Handling of Received Message Objects

The CPU may read a received message any time via the CAN Interface registers because the data consistency is guaranteed by the message handler state machine.

Typically, the CPU first writes `0x007F` to the **CANIFnCMSK** register and then writes the number of the message object to the **CANIFnCRQ** register. That combination transfers the whole received message from the message RAM into the Message Buffer registers (**CANIFnMSKn**, **CANIFnARBn**, and **CANIFnMCTL**). Additionally, the `NEWDAT` and `INTPND` bits are cleared in the message RAM, acknowledging that the message has been read and clearing the pending interrupt generated by this message object.

If the message object uses masks for acceptance filtering, the **CANIFnARBn** registers show the full, unmasked ID for the received message.

The `NEWDAT` bit in the `CANIFnMCTL` register shows whether a new message has been received since the last time this message object was read. The `MSGLST` bit in the `CANIFnMCTL` register shows whether more than one message has been received since the last time this message object was read. `MSGLST` is not automatically cleared, and should be cleared by software after reading its status.

Using a remote frame, the CPU may request new data from another CAN node on the CAN bus. Setting the `TXRQST` bit of a receive object causes the transmission of a remote frame with the receive object's identifier. This remote frame triggers the other CAN node to start the transmission of the matching data frame. If the matching data frame is received before the remote frame could be transmitted, the `TXRQST` bit is automatically reset. This prevents the possible loss of data when the other device on the CAN bus has already transmitted the data slightly earlier than expected.

### 18.3.11.1 Configuration of a FIFO Buffer

With the exception of the `EOB` bit in the `CANIFnMCTL` register, the configuration of receive message objects belonging to a FIFO buffer is the same as the configuration of a single receive message object (see "Configuring a Receive Message Object" on page 770). To concatenate two or more message objects into a FIFO buffer, the identifiers and masks (if used) of these message objects have to be programmed to matching values. Due to the implicit priority of the message objects, the message object with the lowest message object number is the first message object in a FIFO buffer. The `EOB` bit of all message objects of a FIFO buffer except the last one must be cleared. The `EOB` bit of the last message object of a FIFO buffer is set, indicating it is the last entry in the buffer.

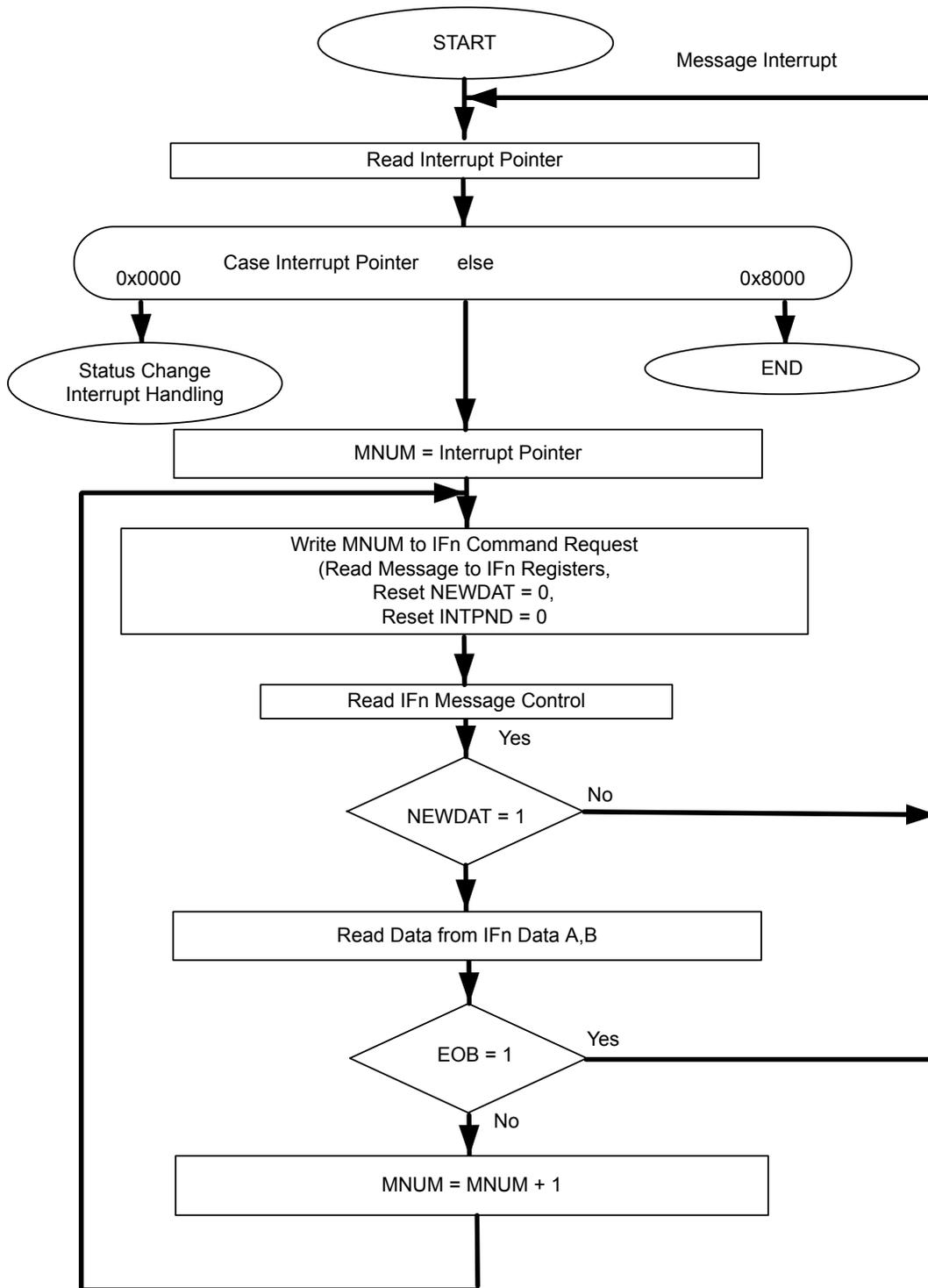
### 18.3.11.2 Reception of Messages with FIFO Buffers

Received messages with identifiers matching to a FIFO buffer are stored starting with the message object with the lowest message number. When a message is stored into a message object of a FIFO buffer, the `NEWDAT` of the `CANIFnMCTL` register bit of this message object is set. By setting `NEWDAT` while `EOB` is clear, the message object is locked and cannot be written to by the message handler until the CPU has cleared the `NEWDAT` bit. Messages are stored into a FIFO buffer until the last message object of this FIFO buffer is reached. Until all of the preceding message objects have been released by clearing the `NEWDAT` bit, all further messages for this FIFO buffer are written into the last message object of the FIFO buffer and therefore overwrite previous messages.

### 18.3.11.3 Reading from a FIFO Buffer

When the CPU transfers the contents of a message object from a FIFO buffer by writing its number to the `CANIFnCRQ` register, the `TXRQST` and `CLRINTPND` bits in the `CANIFnCMSK` register should be set such that the `NEWDAT` and `INTPEND` bits in the `CANIFnMCTL` register are cleared after the read. The values of these bits in the `CANIFnMCTL` register always reflect the status of the message object before the bits are cleared. To assure the correct function of a FIFO buffer, the CPU should read out the message objects starting with the message object with the lowest message number. When reading from the FIFO buffer, the user should be aware that a new received message could be placed in the location of any message object for which the `NEWDAT` bit of the `CANIFnMCTL` register is clear. As a result, the order of the received messages in the FIFO is not guaranteed. Figure 18-3 on page 773 shows how a set of message objects which are concatenated to a FIFO Buffer can be handled by the CPU.

Figure 18-3. Message Objects in a FIFO Buffer



### 18.3.12 Handling of Interrupts

If several interrupts are pending, the **CAN Interrupt (CANINT)** register points to the pending interrupt with the highest priority, disregarding their chronological order. The status interrupt has the highest

priority. Among the message interrupts, the message object's interrupt with the lowest message number has the highest priority. A message interrupt is cleared by clearing the message object's `INTPND` bit in the **CANIFnMCTL** register or by reading the **CAN Status (CANSTS)** register. The status Interrupt is cleared by reading the **CANSTS** register.

The interrupt identifier `INTID` in the **CANINT** register indicates the cause of the interrupt. When no interrupt is pending, the register reads as 0x0000. If the value of the `INTID` field is different from 0, then an interrupt is pending. If the `IE` bit is set in the **CANCTL** register, the interrupt line to the interrupt controller is active. The interrupt line remains active until the `INTID` field is 0, meaning that all interrupt sources have been cleared (the cause of the interrupt is reset), or until `IE` is cleared, which disables interrupts from the CAN controller.

The `INTID` field of the **CANINT** register points to the pending message interrupt with the highest interrupt priority. The `SIE` bit in the **CANCTL** register controls whether a change of the `RXOK`, `TXOK`, and `LEC` bits in the **CANSTS** register can cause an interrupt. The `EIE` bit in the **CANCTL** register controls whether a change of the `BOFF` and `EWARN` bits in the **CANSTS** register can cause an interrupt. The `IE` bit in the **CANCTL** register controls whether any interrupt from the CAN controller actually generates an interrupt to the interrupt controller. The **CANINT** register is updated even when the `IE` bit in the **CANCTL** register is clear, but the interrupt is not indicated to the CPU.

A value of 0x8000 in the **CANINT** register indicates that an interrupt is pending because the CAN module has updated, but not necessarily changed, the **CANSTS** register, indicating that either an error or status interrupt has been generated. A write access to the **CANSTS** register can clear the `RXOK`, `TXOK`, and `LEC` bits in that same register; however, the only way to clear the source of a status interrupt is to read the **CANSTS** register.

The source of an interrupt can be determined in two ways during interrupt handling. The first is to read the `INTID` bit in the **CANINT** register to determine the highest priority interrupt that is pending, and the second is to read the **CAN Message Interrupt Pending (CANMSGnINT)** register to see all of the message objects that have pending interrupts.

An interrupt service routine reading the message that is the source of the interrupt may read the message and clear the message object's `INTPND` bit at the same time by setting the `CLRINTPND` bit in the **CANIFnCMSK** register. Once the `INTPND` bit has been cleared, the **CANINT** register contains the message number for the next message object with a pending interrupt.

### 18.3.13 Test Mode

A Test Mode is provided which allows various diagnostics to be performed. Test Mode is entered by setting the `TEST` bit in the **CANCTL** register. Once in Test Mode, the `TX[1:0]`, `LBACK`, `SILENT` and `BASIC` bits in the **CAN Test (CANTST)** register can be used to put the CAN controller into the various diagnostic modes. The `RX` bit in the **CANTST** register allows monitoring of the `CANnRX` signal. All **CANTST** register functions are disabled when the `TEST` bit is cleared.

#### 18.3.13.1 Silent Mode

Silent Mode can be used to analyze the traffic on a CAN bus without affecting it by the transmission of dominant bits (Acknowledge Bits, Error Frames). The CAN Controller is put in Silent Mode setting the `SILENT` bit in the **CANTST** register. In Silent Mode, the CAN controller is able to receive valid data frames and valid remote frames, but it sends only recessive bits on the CAN bus and cannot start a transmission. If the CAN Controller is required to send a dominant bit (ACK bit, overload flag, or active error flag), the bit is rerouted internally so that the CAN Controller monitors this dominant bit, although the CAN bus remains in recessive state.

### 18.3.13.2 Loopback Mode

Loopback mode is useful for self-test functions. In Loopback Mode, the CAN Controller internally routes the `CANnTX` signal on to the `CANnRX` signal and treats its own transmitted messages as received messages and stores them (if they pass acceptance filtering) into the message buffer. The CAN Controller is put in Loopback Mode by setting the `LBACK` bit in the `CANTST` register. To be independent from external stimulation, the CAN Controller ignores acknowledge errors (a recessive bit sampled in the acknowledge slot of a data/remote frame) in Loopback Mode. The actual value of the `CANnRX` signal is disregarded by the CAN Controller. The transmitted messages can be monitored on the `CANnTX` signal.

### 18.3.13.3 Loopback Combined with Silent Mode

Loopback Mode and Silent Mode can be combined to allow the CAN Controller to be tested without affecting a running CAN system connected to the `CANnTX` and `CANnRX` signals. In this mode, the `CANnRX` signal is disconnected from the CAN Controller and the `CANnTX` signal is held recessive. This mode is enabled by setting both the `LBACK` and `SILENT` bits in the `CANTST` register.

### 18.3.13.4 Basic Mode

Basic Mode allows the CAN Controller to be operated without the Message RAM. In Basic Mode, The CANIF1 registers are used as the transmit buffer. The transmission of the contents of the IF1 registers is requested by setting the `BUSY` bit of the `CANIF1CRQ` register. The CANIF1 registers are locked while the `BUSY` bit is set. The `BUSY` bit indicates that a transmission is pending. As soon the CAN bus is idle, the CANIF1 registers are loaded into the shift register of the CAN Controller and transmission is started. When the transmission has completed, the `BUSY` bit is cleared and the locked CANIF1 registers are released. A pending transmission can be aborted at any time by clearing the `BUSY` bit in the `CANIF1CRQ` register while the CANIF1 registers are locked. If the CPU has cleared the `BUSY` bit, a possible retransmission in case of lost arbitration or an error is disabled.

The CANIF2 Registers are used as a receive buffer. After the reception of a message, the contents of the shift register are stored in the CANIF2 registers, without any acceptance filtering. Additionally, the actual contents of the shift register can be monitored during the message transfer. Each time a read message object is initiated by setting the `BUSY` bit of the `CANIF2CRQ` register, the contents of the shift register are stored into the CANIF2 registers.

In Basic Mode, all message-object-related control and status bits and of the control bits of the `CANIFnCMSK` registers are not evaluated. The message number of the `CANIFnCRQ` registers is also not evaluated. In the `CANIF2MCTL` register, the `NEWDAT` and `MSGLST` bits retain their function, the `DLC[3:0]` field shows the received DLC, the other control bits are cleared.

Basic Mode is enabled by setting the `BASIC` bit in the `CANTST` register.

### 18.3.13.5 Transmit Control

Software can directly override control of the `CANnTX` signal in four different ways.

- `CANnTX` is controlled by the CAN Controller
- The sample point is driven on the `CANnTX` signal to monitor the bit timing
- `CANnTX` drives a low value
- `CANnTX` drives a high value

The last two functions, combined with the readable CAN receive pin `CANnRX`, can be used to check the physical layer of the CAN bus.

The Transmit Control function is enabled by programming the `TX[1:0]` field in the **CANTST** register. The three test functions for the `CANnTX` signal interfere with all CAN protocol functions. `TX[1:0]` must be cleared when CAN message transfer or Loopback Mode, Silent Mode, or Basic Mode are selected.

### 18.3.14 Bit Timing Configuration Error Considerations

Even if minor errors in the configuration of the CAN bit timing do not result in immediate failure, the performance of a CAN network can be reduced significantly. In many cases, the CAN bit synchronization amends a faulty configuration of the CAN bit timing to such a degree that only occasionally an error frame is generated. In the case of arbitration, however, when two or more CAN nodes simultaneously try to transmit a frame, a misplaced sample point may cause one of the transmitters to become error passive. The analysis of such sporadic errors requires a detailed knowledge of the CAN bit synchronization inside a CAN node and of the CAN nodes' interaction on the CAN bus.

### 18.3.15 Bit Time and Bit Rate

The CAN system supports bit rates in the range of lower than 1 Kbps up to 1000 Kbps. Each member of the CAN network has its own clock generator. The timing parameter of the bit time can be configured individually for each CAN node, creating a common bit rate even though the CAN nodes' oscillator periods may be different.

Because of small variations in frequency caused by changes in temperature or voltage and by deteriorating components, these oscillators are not absolutely stable. As long as the variations remain inside a specific oscillator's tolerance range, the CAN nodes are able to compensate for the different bit rates by periodically resynchronizing to the bit stream.

According to the CAN specification, the bit time is divided into four segments (see Figure 18-4 on page 777): the Synchronization Segment, the Propagation Time Segment, the Phase Buffer Segment 1, and the Phase Buffer Segment 2. Each segment consists of a specific, programmable number of time quanta (see Table 18-4 on page 777). The length of the time quantum ( $t_q$ ), which is the basic time unit of the bit time, is defined by the CAN controller's input clock ( $f_{SYS}$ ) and the Baud Rate Prescaler (**BRP**):

$$t_q = \text{BRP} / f_{\text{sys}}$$

The  $f_{\text{sys}}$  input clock is the system clock frequency as configured by the **RCC** or **RCC2** registers (see page 129 or page 137).

The Synchronization Segment Sync is that part of the bit time where edges of the CAN bus level are expected to occur; the distance between an edge that occurs outside of `Sync` and the `Sync` is called the phase error of that edge.

The Propagation Time Segment Prop is intended to compensate for the physical delay times within the CAN network.

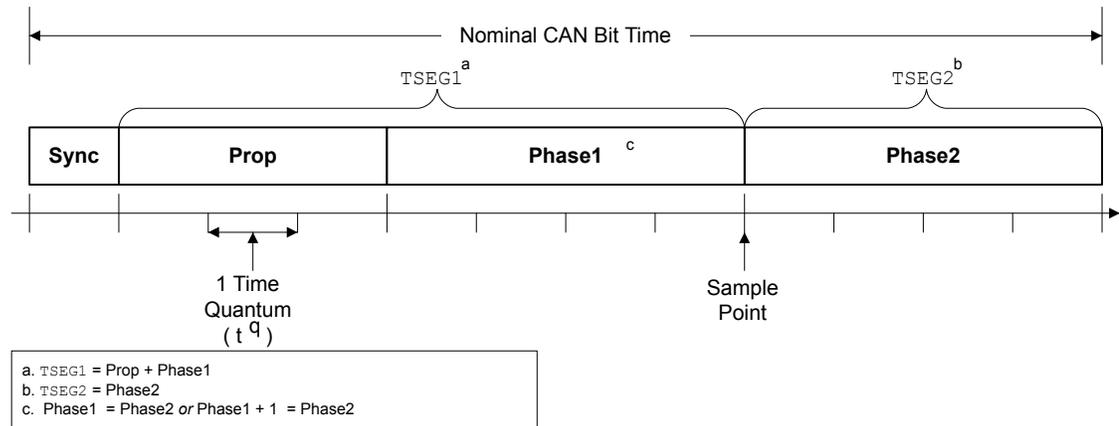
The Phase Buffer Segments Phase1 and Phase2 surround the Sample Point.

The (Re-)Synchronization Jump Width (SJW) defines how far a resynchronization may move the Sample Point inside the limits defined by the Phase Buffer Segments to compensate for edge phase errors.

A given bit rate may be met by different bit-time configurations, but for the proper function of the CAN network, the physical delay times and the oscillator's tolerance range have to be considered.



Figure 18-4. CAN Bit Time

Table 18-4. CAN Protocol Ranges<sup>a</sup>

Parameter	Range	Remark
BRP	[1 .. 64]	Defines the length of the time quantum $t_q$ . The <b>CANBRPE</b> register can be used to extend the range to 1024.
Sync	1 $t_q$	Fixed length, synchronization of bus input to system clock
Prop	[1 .. 8] $t_q$	Compensates for the physical delay times
Phase1	[1 .. 8] $t_q$	May be lengthened temporarily by synchronization
Phase2	[1 .. 8] $t_q$	May be shortened temporarily by synchronization
SJW	[1 .. 4] $t_q$	May not be longer than either Phase Buffer Segment

a. This table describes the minimum programmable ranges required by the CAN protocol.

The bit timing configuration is programmed in two register bytes in the **CANBIT** register. In the **CANBIT** register, the four components TSEG2, TSEG1, SJW, and BRP have to be programmed to a numerical value that is one less than its functional value; so instead of values in the range of [1..n], values in the range of [0..n-1] are programmed. That way, for example, SJW (functional range of [1..4]) is represented by only two bits in the SJW bit field. Table 18-5 shows the relationship between the **CANBIT** register values and the parameters.

Table 18-5. CANBIT Register Values

CANBIT Register Field	Setting
TSEG2	Phase2 - 1
TSEG1	Prop + Phase1 - 1
SJW	SJW - 1
BRP	BRP

Therefore, the length of the bit time is (programmed values):

$$[TSEG1 + TSEG2 + 3] \times t_q$$

or (functional values):

$$[Sync + Prop + Phase1 + Phase2] \times t_q$$

The data in the **CANBIT** register is the configuration input of the CAN protocol controller. The baud rate prescaler (configured by the BRP field) defines the length of the time quantum, the basic time

unit of the bit time; the bit timing logic (configured by TSEG1, TSEG2, and SJW) defines the number of time quanta in the bit time.

The processing of the bit time, the calculation of the position of the sample point, and occasional synchronizations are controlled by the CAN controller and are evaluated once per time quantum.

The CAN controller translates messages to and from frames. In addition, the controller generates and discards the enclosing fixed format bits, inserts and extracts stuff bits, calculates and checks the CRC code, performs the error management, and decides which type of synchronization is to be used. The bit value is received or transmitted at the sample point. The information processing time (IPT) is the time after the sample point needed to calculate the next bit to be transmitted on the CAN bus. The IPT includes any of the following: retrieving the next data bit, handling a CRC bit, determining if bit stuffing is required, generating an error flag or simply going idle.

The IPT is application-specific but may not be longer than  $2 t_q$ ; the CAN's IPT is  $0 t_q$ . Its length is the lower limit of the programmed length of Phase2. In case of synchronization, Phase2 may be shortened to a value less than IPT, which does not affect bus timing.

### 18.3.16 Calculating the Bit Timing Parameters

Usually, the calculation of the bit timing configuration starts with a required bit rate or bit time. The resulting bit time (1/bit rate) must be an integer multiple of the system clock period.

The bit time may consist of 4 to 25 time quanta. Several combinations may lead to the required bit time, allowing iterations of the following steps.

The first part of the bit time to be defined is Prop. Its length depends on the delay times measured in the system. A maximum bus length as well as a maximum node delay has to be defined for expandable CAN bus systems. The resulting time for Prop is converted into time quanta (rounded up to the nearest integer multiple of  $t_q$ ).

Sync is  $1 t_q$  long (fixed), which leaves  $(\text{bit time} - \text{Prop} - 1) t_q$  for the two Phase Buffer Segments. If the number of remaining  $t_q$  is even, the Phase Buffer Segments have the same length, that is, Phase2 = Phase1, else Phase2 = Phase1 + 1.

The minimum nominal length of Phase2 has to be regarded as well. Phase2 may not be shorter than the CAN controller's Information Processing Time, which is, depending on the actual implementation, in the range of  $[0..2] t_q$ .

The length of the synchronization jump width is set to the least of 4, Phase1 or Phase2.

The oscillator tolerance range necessary for the resulting configuration is calculated by the formula given below:

$$(1 - df) \times f_{nom} \leq f_{osc} \leq (1 + df) \times f_{nom}$$

where:

- $df$  = Maximum tolerance of oscillator frequency
- $f_{osc}$  = Actual oscillator frequency
- $f_{nom}$  = Nominal oscillator frequency

Maximum frequency tolerance must take into account the following formulas:

$$df \leq \frac{(Phase\_seg1, Phase\_seg2) \min}{2 \times (13 \times tbit - Phase\_Seg2)}$$

$$df \max = 2 \times df \times f_{nom}$$

where:

- Phase1 and Phase2 are from Table 18-4 on page 777
- tbit = Bit Time
- dfmax = Maximum difference between two oscillators

If more than one configuration is possible, that configuration allowing the highest oscillator tolerance range should be chosen.

CAN nodes with different system clocks require different configurations to come to the same bit rate. The calculation of the propagation time in the CAN network, based on the nodes with the longest delay times, is done once for the whole network.

The CAN system's oscillator tolerance range is limited by the node with the lowest tolerance range.

The calculation may show that bus length or bit rate have to be decreased or that the oscillator frequencies' stability has to be increased in order to find a protocol-compliant configuration of the CAN bit timing.

### 18.3.16.1 Example for Bit Timing at High Baud Rate

In this example, the frequency of CAN clock is 25 MHz, and the bit rate is 1 Mbps.

$$t_q \ 200 \text{ ns} = (\text{Baud rate Prescaler}) / \text{CAN Clock}$$

$$t_{\text{Sync}} = 1 \times t_q = 200 \text{ ns} \quad \backslash\backslash \text{fixed at 1 time quanta}$$

delay of bus driver 50 ns

delay of receiver circuit 30 ns

delay of bus line (40m) 220 ns

$$t_{\text{Prop}} \ 400 \text{ ns} = 2 \times t_q \quad \backslash\backslash 400 \text{ is next integer multiple of } t_q$$

$$\text{bit time} = t_{\text{Sync}} + t_{\text{TSeg1}} + t_{\text{TSeg2}}$$

$$\text{bit time} = t_{\text{Sync}} + t_{\text{Prop}} + t_{\text{Phase 1}} + t_{\text{Phase 2}}$$

$$t_{\text{Phase 1}} + t_{\text{Phase 2}} = \text{bit time} - t_{\text{Sync}} - t_{\text{Prop}}$$

$$t_{\text{Phase 1}} + t_{\text{Phase 2}} = 1000 \text{ ns} - 200 \text{ ns} - 400 \text{ ns}$$

$$t_{\text{Phase 1}} + t_{\text{Phase 2}} = 400 \text{ ns}$$

$$t_{\text{Phase 1}} = 200 \text{ ns}$$

$$t_{\text{Phase 2}} = 200 \text{ ns} \quad \backslash\backslash t_{\text{Phase 1}} = t_{\text{Phase 2}}$$

$$t_{\text{TSeg1}} = t_{\text{Prop}} + t_{\text{Phase 1}}$$

$$t_{\text{TSeg1}} = 400 \text{ ns} + 200 \text{ ns}$$

$$t_{\text{TSeg1}} = 600 \text{ ns} = 3 \times t_q$$

$$t_{\text{TSeg2}} = t_{\text{Phase 2}}$$

$$tTSeg2 = (\text{Information Processing Time} + 1) \times t_q$$

$$tTSeg2 = 200 \text{ ns} = 1 \times t_q \quad \backslash\backslash \text{Assumes IPT}=0$$

$$tSJW = 1 \times t_q = 200 \text{ ns} \quad \backslash\backslash \text{Least of 4, Phase1 and Phase2} = 1$$

In the above example, the bit field values for the **CANBIT** register are:

TSEG2	= TSeg2 - 1 = 1-1 = 0
TSEG1	= TSeg1 - 1 = 3-1 = 2
SJW	= SJW - 1 = 1-1 = 0
BRP	= Baud rate prescaler - 1 = 5-1 = 4

The final value programmed into the **CANBIT** register = 0x0204.

### 18.3.16.2 Example for Bit Timing at Low Baud Rate

In this example, the frequency of the CAN clock is 50 MHz, and the bit rate is 100 Kbps.

$$t_q = 1 \mu\text{s} = (\text{Baud rate Prescaler}) / \text{CAN Clock}$$

$$tSync = 1 \times t_q = 1 \mu\text{s} \quad \backslash\backslash \text{fixed at 1 time quanta}$$

delay of bus driver 200 ns  
 delay of receiver circuit 80 ns  
 delay of bus line (40m) 220 ns

$$tProp = 1 \mu\text{s} = 1 \times t_q \quad \backslash\backslash 1 \mu\text{s} \text{ is next integer multiple of } t_q$$

$$\text{bit time} = tSync + tTSeg1 + tTSeg2$$

$$\text{bit time} = tSync + tProp + tPhase1 + tPhase2$$

$$tPhase1 + tPhase2 = \text{bit time} - tSync - tProp$$

$$tPhase1 + tPhase2 = 10 \mu\text{s} - 1 \mu\text{s} - 1 \mu\text{s}$$

$$tPhase1 + tPhase2 = 8 \mu\text{s}$$

$$tPhase1 = 4 \mu\text{s}$$

$$tPhase2 = 4 \mu\text{s} \quad \backslash\backslash tPhase1 = tPhase2$$

$$tTSeg1 = tProp + tPhase1$$

$$tTSeg1 = 1 \mu\text{s} + 4 \mu\text{s}$$

$$tTSeg1 = 5 \mu\text{s} = 5 \times t_q$$

$$tTSeg2 = tPhase2$$

$$tTSeg2 = (\text{Information Processing Time} + 4) \times t_q$$

$$tTSeg2 = 4 \mu\text{s} = 4 \times t_q \quad \backslash\backslash \text{Assumes IPT}=0$$

$$tSJW = 4 \times t_q = 4 \mu\text{s} \quad \backslash\backslash \text{Least of 4, Phase1, and Phase2}$$

TSEG2	= TSeg2 -1 = 4-1 = 3
TSEG1	= TSeg1 -1 = 5-1 = 4
SJW	= SJW -1 = 4-1 = 3
BRP	= Baud rate prescaler - 1 = 50-1 =49

The final value programmed into the **CANBIT** register = 0x34F1.

## 18.4 Register Map

Table 18-6 on page 781 lists the registers. All addresses given are relative to the CAN base address of:

- CAN0: 0x4004.0000
- CAN1: 0x4004.1000

Note that the CAN controller clock must be enabled before the registers can be programmed (see page 173).

**Table 18-6. CAN Register Map**

Offset	Name	Type	Reset	Description	See page
0x000	CANCTL	R/W	0x0000.0001	CAN Control	783
0x004	CANSTS	R/W	0x0000.0000	CAN Status	785
0x008	CANERR	RO	0x0000.0000	CAN Error Counter	788
0x00C	CANBIT	R/W	0x0000.2301	CAN Bit Timing	789
0x010	CANINT	RO	0x0000.0000	CAN Interrupt	791
0x014	CANTST	R/W	0x0000.0000	CAN Test	792
0x018	CANBRPE	R/W	0x0000.0000	CAN Baud Rate Prescaler Extension	794
0x020	CANIF1CRQ	R/W	0x0000.0001	CAN IF1 Command Request	795
0x024	CANIF1CMSK	R/W	0x0000.0000	CAN IF1 Command Mask	797
0x028	CANIF1MSK1	R/W	0x0000.FFFF	CAN IF1 Mask 1	800
0x02C	CANIF1MSK2	R/W	0x0000.FFFF	CAN IF1 Mask 2	801
0x030	CANIF1ARB1	R/W	0x0000.0000	CAN IF1 Arbitration 1	803
0x034	CANIF1ARB2	R/W	0x0000.0000	CAN IF1 Arbitration 2	804
0x038	CANIF1MCTL	R/W	0x0000.0000	CAN IF1 Message Control	806

Table 18-6. CAN Register Map (continued)

Offset	Name	Type	Reset	Description	See page
0x03C	CANIF1DA1	R/W	0x0000.0000	CAN IF1 Data A1	809
0x040	CANIF1DA2	R/W	0x0000.0000	CAN IF1 Data A2	809
0x044	CANIF1DB1	R/W	0x0000.0000	CAN IF1 Data B1	809
0x048	CANIF1DB2	R/W	0x0000.0000	CAN IF1 Data B2	809
0x080	CANIF2CRQ	R/W	0x0000.0001	CAN IF2 Command Request	795
0x084	CANIF2CMSK	R/W	0x0000.0000	CAN IF2 Command Mask	797
0x088	CANIF2MSK1	R/W	0x0000.FFFF	CAN IF2 Mask 1	800
0x08C	CANIF2MSK2	R/W	0x0000.FFFF	CAN IF2 Mask 2	801
0x090	CANIF2ARB1	R/W	0x0000.0000	CAN IF2 Arbitration 1	803
0x094	CANIF2ARB2	R/W	0x0000.0000	CAN IF2 Arbitration 2	804
0x098	CANIF2MCTL	R/W	0x0000.0000	CAN IF2 Message Control	806
0x09C	CANIF2DA1	R/W	0x0000.0000	CAN IF2 Data A1	809
0x0A0	CANIF2DA2	R/W	0x0000.0000	CAN IF2 Data A2	809
0x0A4	CANIF2DB1	R/W	0x0000.0000	CAN IF2 Data B1	809
0x0A8	CANIF2DB2	R/W	0x0000.0000	CAN IF2 Data B2	809
0x100	CANTXRQ1	RO	0x0000.0000	CAN Transmission Request 1	810
0x104	CANTXRQ2	RO	0x0000.0000	CAN Transmission Request 2	810
0x120	CANNWDA1	RO	0x0000.0000	CAN New Data 1	811
0x124	CANNWDA2	RO	0x0000.0000	CAN New Data 2	811
0x140	CANMSG1INT	RO	0x0000.0000	CAN Message 1 Interrupt Pending	812
0x144	CANMSG2INT	RO	0x0000.0000	CAN Message 2 Interrupt Pending	812
0x160	CANMSG1VAL	RO	0x0000.0000	CAN Message 1 Valid	813
0x164	CANMSG2VAL	RO	0x0000.0000	CAN Message 2 Valid	813

## 18.5 CAN Register Descriptions

The remainder of this section lists and describes the CAN registers, in numerical order by address offset. There are two sets of Interface Registers that are used to access the Message Objects in the Message RAM: **CANIF1x** and **CANIF2x**. The function of the two sets are identical and are used to queue transactions.

## Register 1: CAN Control (CANCTL), offset 0x000

This control register initializes the module and enables test mode and interrupts.

The bus-off recovery sequence (see CAN Specification Rev. 2.0) cannot be shortened by setting or clearing `INIT`. If the device goes bus-off, it sets `INIT`, stopping all bus activities. Once `INIT` has been cleared by the CPU, the device then waits for 129 occurrences of Bus Idle (129 \* 11 consecutive High bits) before resuming normal operations. At the end of the bus-off recovery sequence, the Error Management Counters are reset.

During the waiting time after `INIT` is cleared, each time a sequence of 11 High bits has been monitored, a `BITERROR0` code is written to the **CANSTS** register (the `LEC` field = 0x5), enabling the CPU to readily check whether the CAN bus is stuck Low or continuously disturbed, and to monitor the proceeding of the bus-off recovery sequence.

### CAN Control (CANCTL)

CAN0 base: 0x4004.0000  
CAN1 base: 0x4004.1000  
Offset 0x000  
Type R/W, reset 0x0000.0001

	31	30	29	28	27	26	25	24	23	22	21	20	19	18	17	16
	reserved															
Type	RO	RO	RO	RO	RO	RO	RO	RO	RO	RO	RO	RO	RO	RO	RO	RO
Reset	0	0	0	0	0	0	0	0	0	0	0	0	0	0	0	0
	15	14	13	12	11	10	9	8	7	6	5	4	3	2	1	0
	reserved								TEST	CCE	DAR	reserved	EIE	SIE	IE	INIT
Type	RO	RO	RO	RO	RO	RO	RO	RO	R/W	R/W	R/W	RO	R/W	R/W	R/W	R/W
Reset	0	0	0	0	0	0	0	0	0	0	0	0	0	0	0	1

Bit/Field	Name	Type	Reset	Description						
31:8	reserved	RO	0x0000.00	Software should not rely on the value of a reserved bit. To provide compatibility with future products, the value of a reserved bit should be preserved across a read-modify-write operation.						
7	TEST	R/W	0	Test Mode Enable						
				<table border="0"> <tr> <td>Value</td> <td>Description</td> </tr> <tr> <td>0</td> <td>The CAN controller is operating normally.</td> </tr> <tr> <td>1</td> <td>The CAN controller is in test mode.</td> </tr> </table>	Value	Description	0	The CAN controller is operating normally.	1	The CAN controller is in test mode.
Value	Description									
0	The CAN controller is operating normally.									
1	The CAN controller is in test mode.									
6	CCE	R/W	0	Configuration Change Enable						
				<table border="0"> <tr> <td>Value</td> <td>Description</td> </tr> <tr> <td>0</td> <td>Write accesses to the <b>CANBIT</b> register are not allowed.</td> </tr> <tr> <td>1</td> <td>Write accesses to the <b>CANBIT</b> register are allowed if the <code>INIT</code> bit is 1.</td> </tr> </table>	Value	Description	0	Write accesses to the <b>CANBIT</b> register are not allowed.	1	Write accesses to the <b>CANBIT</b> register are allowed if the <code>INIT</code> bit is 1.
Value	Description									
0	Write accesses to the <b>CANBIT</b> register are not allowed.									
1	Write accesses to the <b>CANBIT</b> register are allowed if the <code>INIT</code> bit is 1.									
5	DAR	R/W	0	Disable Automatic-Retransmission						
				<table border="0"> <tr> <td>Value</td> <td>Description</td> </tr> <tr> <td>0</td> <td>Auto-retransmission of disturbed messages is enabled.</td> </tr> <tr> <td>1</td> <td>Auto-retransmission is disabled.</td> </tr> </table>	Value	Description	0	Auto-retransmission of disturbed messages is enabled.	1	Auto-retransmission is disabled.
Value	Description									
0	Auto-retransmission of disturbed messages is enabled.									
1	Auto-retransmission is disabled.									

Bit/Field	Name	Type	Reset	Description						
4	reserved	RO	0	Software should not rely on the value of a reserved bit. To provide compatibility with future products, the value of a reserved bit should be preserved across a read-modify-write operation.						
3	EIE	R/W	0	Error Interrupt Enable  <table border="1"> <thead> <tr> <th>Value</th> <th>Description</th> </tr> </thead> <tbody> <tr> <td>0</td> <td>No error status interrupt is generated.</td> </tr> <tr> <td>1</td> <td>A change in the <i>BOFF</i> or <i>EWARN</i> bits in the <b>CANSTS</b> register generates an interrupt.</td> </tr> </tbody> </table>	Value	Description	0	No error status interrupt is generated.	1	A change in the <i>BOFF</i> or <i>EWARN</i> bits in the <b>CANSTS</b> register generates an interrupt.
Value	Description									
0	No error status interrupt is generated.									
1	A change in the <i>BOFF</i> or <i>EWARN</i> bits in the <b>CANSTS</b> register generates an interrupt.									
2	SIE	R/W	0	Status Interrupt Enable  <table border="1"> <thead> <tr> <th>Value</th> <th>Description</th> </tr> </thead> <tbody> <tr> <td>0</td> <td>No status interrupt is generated.</td> </tr> <tr> <td>1</td> <td>An interrupt is generated when a message has successfully been transmitted or received, or a CAN bus error has been detected. A change in the <i>TXOK</i>, <i>RXOK</i> or <i>LEC</i> bits in the <b>CANSTS</b> register generates an interrupt.</td> </tr> </tbody> </table>	Value	Description	0	No status interrupt is generated.	1	An interrupt is generated when a message has successfully been transmitted or received, or a CAN bus error has been detected. A change in the <i>TXOK</i> , <i>RXOK</i> or <i>LEC</i> bits in the <b>CANSTS</b> register generates an interrupt.
Value	Description									
0	No status interrupt is generated.									
1	An interrupt is generated when a message has successfully been transmitted or received, or a CAN bus error has been detected. A change in the <i>TXOK</i> , <i>RXOK</i> or <i>LEC</i> bits in the <b>CANSTS</b> register generates an interrupt.									
1	IE	R/W	0	CAN Interrupt Enable  <table border="1"> <thead> <tr> <th>Value</th> <th>Description</th> </tr> </thead> <tbody> <tr> <td>0</td> <td>Interrupts disabled.</td> </tr> <tr> <td>1</td> <td>Interrupts enabled.</td> </tr> </tbody> </table>	Value	Description	0	Interrupts disabled.	1	Interrupts enabled.
Value	Description									
0	Interrupts disabled.									
1	Interrupts enabled.									
0	INIT	R/W	1	Initialization  <table border="1"> <thead> <tr> <th>Value</th> <th>Description</th> </tr> </thead> <tbody> <tr> <td>0</td> <td>Normal operation.</td> </tr> <tr> <td>1</td> <td>Initialization started.</td> </tr> </tbody> </table>	Value	Description	0	Normal operation.	1	Initialization started.
Value	Description									
0	Normal operation.									
1	Initialization started.									



## Register 2: CAN Status (CANSTS), offset 0x004

**Important:** Use caution when reading this register. Performing a read may change bit status.

The status register contains information for interrupt servicing such as Bus-Off, error count threshold, and error types.

The LEC field holds the code that indicates the type of the last error to occur on the CAN bus. This field is cleared when a message has been transferred (reception or transmission) without error. The unused error code 0x7 may be written by the CPU to manually set this field to an invalid error so that it can be checked for a change later.

An error interrupt is generated by the BOFF and EWARN bits, and a status interrupt is generated by the RXOK, TXOK, and LEC bits, if the corresponding enable bits in the **CAN Control (CANCTL)** register are set. A change of the EPASS bit or a write to the RXOK, TXOK, or LEC bits does not generate an interrupt.

Reading the **CAN Status (CANSTS)** register clears the **CAN Interrupt (CANINT)** register, if it is pending.

### CAN Status (CANSTS)

CAN0 base: 0x4004.0000  
CAN1 base: 0x4004.1000  
Offset 0x004  
Type R/W, reset 0x0000.0000

	31	30	29	28	27	26	25	24	23	22	21	20	19	18	17	16
	reserved															
Type	RO	RO	RO	RO	RO	RO	RO	RO	RO	RO	RO	RO	RO	RO	RO	RO
Reset	0	0	0	0	0	0	0	0	0	0	0	0	0	0	0	0
	15	14	13	12	11	10	9	8	7	6	5	4	3	2	1	0
	reserved								BOFF	EWARN	EPASS	RXOK	TXOK	LEC		
Type	RO	RO	RO	RO	RO	RO	RO	RO	RO	RO	RO	R/W	R/W	R/W	R/W	R/W
Reset	0	0	0	0	0	0	0	0	0	0	0	0	0	0	0	0

Bit/Field	Name	Type	Reset	Description						
31:8	reserved	RO	0x0000.00	Software should not rely on the value of a reserved bit. To provide compatibility with future products, the value of a reserved bit should be preserved across a read-modify-write operation.						
7	BOFF	RO	0	Bus-Off Status						
				<table border="0"> <tr> <td style="padding-right: 20px;">Value</td> <td>Description</td> </tr> <tr> <td>0</td> <td>The CAN controller is not in bus-off state.</td> </tr> <tr> <td>1</td> <td>The CAN controller is in bus-off state.</td> </tr> </table>	Value	Description	0	The CAN controller is not in bus-off state.	1	The CAN controller is in bus-off state.
Value	Description									
0	The CAN controller is not in bus-off state.									
1	The CAN controller is in bus-off state.									
6	EWARN	RO	0	Warning Status						
				<table border="0"> <tr> <td style="padding-right: 20px;">Value</td> <td>Description</td> </tr> <tr> <td>0</td> <td>Both error counters are below the error warning limit of 96.</td> </tr> <tr> <td>1</td> <td>At least one of the error counters has reached the error warning limit of 96.</td> </tr> </table>	Value	Description	0	Both error counters are below the error warning limit of 96.	1	At least one of the error counters has reached the error warning limit of 96.
Value	Description									
0	Both error counters are below the error warning limit of 96.									
1	At least one of the error counters has reached the error warning limit of 96.									

Bit/Field	Name	Type	Reset	Description						
5	EPASS	RO	0	<p>Error Passive</p> <table border="1"> <thead> <tr> <th>Value</th> <th>Description</th> </tr> </thead> <tbody> <tr> <td>0</td> <td>The CAN module is in the Error Active state, that is, the receive or transmit error count is less than or equal to 127.</td> </tr> <tr> <td>1</td> <td>The CAN module is in the Error Passive state, that is, the receive or transmit error count is greater than 127.</td> </tr> </tbody> </table>	Value	Description	0	The CAN module is in the Error Active state, that is, the receive or transmit error count is less than or equal to 127.	1	The CAN module is in the Error Passive state, that is, the receive or transmit error count is greater than 127.
Value	Description									
0	The CAN module is in the Error Active state, that is, the receive or transmit error count is less than or equal to 127.									
1	The CAN module is in the Error Passive state, that is, the receive or transmit error count is greater than 127.									
4	RXOK	R/W	0	<p>Received a Message Successfully</p> <table border="1"> <thead> <tr> <th>Value</th> <th>Description</th> </tr> </thead> <tbody> <tr> <td>0</td> <td>Since this bit was last cleared, no message has been successfully received.</td> </tr> <tr> <td>1</td> <td>Since this bit was last cleared, a message has been successfully received, independent of the result of the acceptance filtering.</td> </tr> </tbody> </table> <p>This bit must be cleared by writing a 0 to it.</p>	Value	Description	0	Since this bit was last cleared, no message has been successfully received.	1	Since this bit was last cleared, a message has been successfully received, independent of the result of the acceptance filtering.
Value	Description									
0	Since this bit was last cleared, no message has been successfully received.									
1	Since this bit was last cleared, a message has been successfully received, independent of the result of the acceptance filtering.									
3	TXOK	R/W	0	<p>Transmitted a Message Successfully</p> <table border="1"> <thead> <tr> <th>Value</th> <th>Description</th> </tr> </thead> <tbody> <tr> <td>0</td> <td>Since this bit was last cleared, no message has been successfully transmitted.</td> </tr> <tr> <td>1</td> <td>Since this bit was last cleared, a message has been successfully transmitted error-free and acknowledged by at least one other node.</td> </tr> </tbody> </table> <p>This bit must be cleared by writing a 0 to it.</p>	Value	Description	0	Since this bit was last cleared, no message has been successfully transmitted.	1	Since this bit was last cleared, a message has been successfully transmitted error-free and acknowledged by at least one other node.
Value	Description									
0	Since this bit was last cleared, no message has been successfully transmitted.									
1	Since this bit was last cleared, a message has been successfully transmitted error-free and acknowledged by at least one other node.									

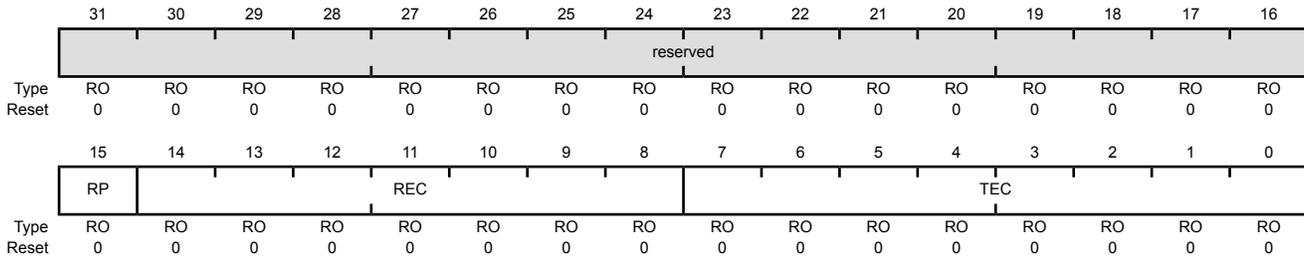
Bit/Field	Name	Type	Reset	Description																																				
2:0	LEC	R/W	0x0	<p>Last Error Code</p> <p>This is the type of the last error to occur on the CAN bus.</p> <table border="1"> <thead> <tr> <th>Value</th> <th>Description</th> </tr> </thead> <tbody> <tr> <td>0x0</td> <td>No Error</td> </tr> <tr> <td>0x1</td> <td>Stuff Error</td> </tr> <tr> <td></td> <td>More than 5 equal bits in a sequence have occurred in a part of a received message where this is not allowed.</td> </tr> <tr> <td>0x2</td> <td>Format Error</td> </tr> <tr> <td></td> <td>A fixed format part of the received frame has the wrong format.</td> </tr> <tr> <td>0x3</td> <td>ACK Error</td> </tr> <tr> <td></td> <td>The message transmitted was not acknowledged by another node.</td> </tr> <tr> <td>0x4</td> <td>Bit 1 Error</td> </tr> <tr> <td></td> <td>When a message is transmitted, the CAN controller monitors the data lines to detect any conflicts. When the arbitration field is transmitted, data conflicts are a part of the arbitration protocol. When other frame fields are transmitted, data conflicts are considered errors.</td> </tr> <tr> <td></td> <td>A Bit 1 Error indicates that the device wanted to send a High level (logical 1) but the monitored bus value was Low (logical 0).</td> </tr> <tr> <td>0x5</td> <td>Bit 0 Error</td> </tr> <tr> <td></td> <td>A Bit 0 Error indicates that the device wanted to send a Low level (logical 0), but the monitored bus value was High (logical 1).</td> </tr> <tr> <td></td> <td>During bus-off recovery, this status is set each time a sequence of 11 High bits has been monitored. By checking for this status, software can monitor the proceeding of the bus-off recovery sequence without any disturbances to the bus.</td> </tr> <tr> <td>0x6</td> <td>CRC Error</td> </tr> <tr> <td></td> <td>The CRC checksum was incorrect in the received message, indicating that the calculated value received did not match the calculated CRC of the data.</td> </tr> <tr> <td>0x7</td> <td>No Event</td> </tr> <tr> <td></td> <td>When the LEC bit shows this value, no CAN bus event was detected since this value was written to the LEC field.</td> </tr> </tbody> </table>	Value	Description	0x0	No Error	0x1	Stuff Error		More than 5 equal bits in a sequence have occurred in a part of a received message where this is not allowed.	0x2	Format Error		A fixed format part of the received frame has the wrong format.	0x3	ACK Error		The message transmitted was not acknowledged by another node.	0x4	Bit 1 Error		When a message is transmitted, the CAN controller monitors the data lines to detect any conflicts. When the arbitration field is transmitted, data conflicts are a part of the arbitration protocol. When other frame fields are transmitted, data conflicts are considered errors.		A Bit 1 Error indicates that the device wanted to send a High level (logical 1) but the monitored bus value was Low (logical 0).	0x5	Bit 0 Error		A Bit 0 Error indicates that the device wanted to send a Low level (logical 0), but the monitored bus value was High (logical 1).		During bus-off recovery, this status is set each time a sequence of 11 High bits has been monitored. By checking for this status, software can monitor the proceeding of the bus-off recovery sequence without any disturbances to the bus.	0x6	CRC Error		The CRC checksum was incorrect in the received message, indicating that the calculated value received did not match the calculated CRC of the data.	0x7	No Event		When the LEC bit shows this value, no CAN bus event was detected since this value was written to the LEC field.
Value	Description																																							
0x0	No Error																																							
0x1	Stuff Error																																							
	More than 5 equal bits in a sequence have occurred in a part of a received message where this is not allowed.																																							
0x2	Format Error																																							
	A fixed format part of the received frame has the wrong format.																																							
0x3	ACK Error																																							
	The message transmitted was not acknowledged by another node.																																							
0x4	Bit 1 Error																																							
	When a message is transmitted, the CAN controller monitors the data lines to detect any conflicts. When the arbitration field is transmitted, data conflicts are a part of the arbitration protocol. When other frame fields are transmitted, data conflicts are considered errors.																																							
	A Bit 1 Error indicates that the device wanted to send a High level (logical 1) but the monitored bus value was Low (logical 0).																																							
0x5	Bit 0 Error																																							
	A Bit 0 Error indicates that the device wanted to send a Low level (logical 0), but the monitored bus value was High (logical 1).																																							
	During bus-off recovery, this status is set each time a sequence of 11 High bits has been monitored. By checking for this status, software can monitor the proceeding of the bus-off recovery sequence without any disturbances to the bus.																																							
0x6	CRC Error																																							
	The CRC checksum was incorrect in the received message, indicating that the calculated value received did not match the calculated CRC of the data.																																							
0x7	No Event																																							
	When the LEC bit shows this value, no CAN bus event was detected since this value was written to the LEC field.																																							

### Register 3: CAN Error Counter (CANERR), offset 0x008

This register contains the error counter values, which can be used to analyze the cause of an error.

#### CAN Error Counter (CANERR)

CAN0 base: 0x4004.0000  
 CAN1 base: 0x4004.1000  
 Offset 0x008  
 Type RO, reset 0x0000.0000



Bit/Field	Name	Type	Reset	Description						
31:16	reserved	RO	0x0000	Software should not rely on the value of a reserved bit. To provide compatibility with future products, the value of a reserved bit should be preserved across a read-modify-write operation.						
15	RP	RO	0	Received Error Passive  <table border="1"> <thead> <tr> <th>Value</th> <th>Description</th> </tr> </thead> <tbody> <tr> <td>0</td> <td>The Receive Error counter is below the Error Passive level (127 or less).</td> </tr> <tr> <td>1</td> <td>The Receive Error counter has reached the Error Passive level (128 or greater).</td> </tr> </tbody> </table>	Value	Description	0	The Receive Error counter is below the Error Passive level (127 or less).	1	The Receive Error counter has reached the Error Passive level (128 or greater).
Value	Description									
0	The Receive Error counter is below the Error Passive level (127 or less).									
1	The Receive Error counter has reached the Error Passive level (128 or greater).									
14:8	REC	RO	0x00	Receive Error Counter  This field contains the state of the receiver error counter (0 to 127).						
7:0	TEC	RO	0x00	Transmit Error Counter  This field contains the state of the transmit error counter (0 to 255).						

## Register 4: CAN Bit Timing (CANBIT), offset 0x00C

This register is used to program the bit width and bit quantum. Values are programmed to the system clock frequency. This register is write-enabled by setting the `CCE` and `INIT` bits in the `CANCTL` register. See “Bit Time and Bit Rate” on page 776 for more information.

### CAN Bit Timing (CANBIT)

CAN0 base: 0x4004.0000  
CAN1 base: 0x4004.1000  
Offset 0x00C  
Type R/W, reset 0x0000.2301

	31	30	29	28	27	26	25	24	23	22	21	20	19	18	17	16
	reserved															
Type	RO	RO	RO	RO	RO	RO	RO	RO	RO	RO	RO	RO	RO	RO	RO	RO
Reset	0	0	0	0	0	0	0	0	0	0	0	0	0	0	0	0
	15	14	13	12	11	10	9	8	7	6	5	4	3	2	1	0
	reserved	TSEG2			TSEG1				SJW		BRP					
Type	RO	R/W	R/W	R/W	R/W	R/W	R/W	R/W	R/W	R/W	R/W	R/W	R/W	R/W	R/W	R/W
Reset	0	0	1	0	0	0	1	1	0	0	0	0	0	0	0	1

Bit/Field	Name	Type	Reset	Description
31:15	reserved	RO	0x0000	Software should not rely on the value of a reserved bit. To provide compatibility with future products, the value of a reserved bit should be preserved across a read-modify-write operation.
14:12	TSEG2	R/W	0x2	Time Segment after Sample Point  0x00-0x07: The actual interpretation by the hardware of this value is such that one more than the value programmed here is used.  So, for example, the reset value of 0x2 means that 3 (2+1) bit time quanta are defined for <code>Phase2</code> (see Figure 18-4 on page 777). The bit time quanta is defined by the <code>BRP</code> field.
11:8	TSEG1	R/W	0x3	Time Segment Before Sample Point  0x00-0x0F: The actual interpretation by the hardware of this value is such that one more than the value programmed here is used.  So, for example, the reset value of 0x3 means that 4 (3+1) bit time quanta are defined for <code>Phase1</code> (see Figure 18-4 on page 777). The bit time quanta is defined by the <code>BRP</code> field.
7:6	SJW	R/W	0x0	(Re)Synchronization Jump Width  0x00-0x03: The actual interpretation by the hardware of this value is such that one more than the value programmed here is used.  During the start of frame (SOF), if the CAN controller detects a phase error (misalignment), it can adjust the length of <code>TSEG2</code> or <code>TSEG1</code> by the value in <code>SJW</code> . So the reset value of 0 adjusts the length by 1 bit time quanta.

Bit/Field	Name	Type	Reset	Description
5:0	BRP	R/W	0x1	<p>Baud Rate Prescaler</p> <p>The value by which the oscillator frequency is divided for generating the bit time quanta. The bit time is built up from a multiple of this quantum.</p> <p>0x00-0x03F: The actual interpretation by the hardware of this value is such that one more than the value programmed here is used.</p> <p>BRP defines the number of CAN clock periods that make up 1 bit time quanta, so the reset value is 2 bit time quanta (1+1).</p> <p>The <b>CANBRPE</b> register can be used to further divide the bit time.</p>

**Register 5: CAN Interrupt (CANINT), offset 0x010**

This register indicates the source of the interrupt.

If several interrupts are pending, the **CAN Interrupt (CANINT)** register points to the pending interrupt with the highest priority, disregarding the order in which the interrupts occurred. An interrupt remains pending until the CPU has cleared it. If the **INTID** field is not 0x0000 (the default) and the **IE** bit in the **CANCTL** register is set, the interrupt is active. The interrupt line remains active until the **INTID** field is cleared by reading the **CANSTS** register, or until the **IE** bit in the **CANCTL** register is cleared.

**Note:** Reading the **CAN Status (CANSTS)** register clears the **CAN Interrupt (CANINT)** register, if it is pending.

**CAN Interrupt (CANINT)**

CAN0 base: 0x4004.0000

CAN1 base: 0x4004.1000

Offset 0x010

Type RO, reset 0x0000.0000

	31	30	29	28	27	26	25	24	23	22	21	20	19	18	17	16
	reserved															
Type	RO	RO	RO	RO	RO	RO	RO	RO	RO	RO	RO	RO	RO	RO	RO	RO
Reset	0	0	0	0	0	0	0	0	0	0	0	0	0	0	0	0
	15	14	13	12	11	10	9	8	7	6	5	4	3	2	1	0
	INTID															
Type	RO	RO	RO	RO	RO	RO	RO	RO	RO	RO	RO	RO	RO	RO	RO	RO
Reset	0	0	0	0	0	0	0	0	0	0	0	0	0	0	0	0

Bit/Field	Name	Type	Reset	Description
31:16	reserved	RO	0x0000	Software should not rely on the value of a reserved bit. To provide compatibility with future products, the value of a reserved bit should be preserved across a read-modify-write operation.
15:0	INTID	RO	0x0000	Interrupt Identifier The number in this field indicates the source of the interrupt.
			Value	Description
			0x0000	No interrupt pending
			0x0001-0x0020	Number of the message object that caused the interrupt
			0x0021-0x7FFF	Reserved
			0x8000	Status Interrupt
			0x8001-0xFFFF	Reserved

### Register 6: CAN Test (CANTST), offset 0x014

This register is used for self-test and external pin access. It is write-enabled by setting the `TEST` bit in the `CANCTL` register. Different test functions may be combined, however, CAN transfers are affected if the `TX` bits in this register are not zero.

#### CAN Test (CANTST)

CAN0 base: 0x4004.0000  
 CAN1 base: 0x4004.1000  
 Offset 0x014  
 Type R/W, reset 0x0000.0000

	31	30	29	28	27	26	25	24	23	22	21	20	19	18	17	16
	reserved															
Type	RO	RO	RO	RO	RO	RO	RO	RO	RO	RO	RO	RO	RO	RO	RO	RO
Reset	0	0	0	0	0	0	0	0	0	0	0	0	0	0	0	0
	15	14	13	12	11	10	9	8	7	6	5	4	3	2	1	0
	reserved								RX	TX		LBACK	SILENT	BASIC	reserved	
Type	RO	RO	RO	RO	RO	RO	RO	RO	RO	R/W	R/W	R/W	R/W	R/W	RO	RO
Reset	0	0	0	0	0	0	0	0	0	0	0	0	0	0	0	0

Bit/Field	Name	Type	Reset	Description										
31:8	reserved	RO	0x0000.00	Software should not rely on the value of a reserved bit. To provide compatibility with future products, the value of a reserved bit should be preserved across a read-modify-write operation.										
7	RX	RO	0	Receive Observation  <table border="0"> <tr> <td>Value</td> <td>Description</td> </tr> <tr> <td>0</td> <td>The <code>CANnRx</code> pin is low.</td> </tr> <tr> <td>1</td> <td>The <code>CANnRx</code> pin is high.</td> </tr> </table>	Value	Description	0	The <code>CANnRx</code> pin is low.	1	The <code>CANnRx</code> pin is high.				
Value	Description													
0	The <code>CANnRx</code> pin is low.													
1	The <code>CANnRx</code> pin is high.													
6:5	TX	R/W	0x0	Transmit Control  Overrides control of the <code>CANnTx</code> pin.  <table border="0"> <tr> <td>Value</td> <td>Description</td> </tr> <tr> <td>0x0</td> <td>CAN Module Control   <code>CANnTx</code> is controlled by the CAN module; default operation</td> </tr> <tr> <td>0x1</td> <td>Sample Point                               The sample point is driven on the <code>CANnTx</code> signal. This mode is useful to monitor bit timing.</td> </tr> <tr> <td>0x2</td> <td>Driven Low   <code>CANnTx</code> drives a low value. This mode is useful for checking the physical layer of the CAN bus.</td> </tr> <tr> <td>0x3</td> <td>Driven High   <code>CANnTx</code> drives a high value. This mode is useful for checking the physical layer of the CAN bus.</td> </tr> </table>	Value	Description	0x0	CAN Module Control  <code>CANnTx</code> is controlled by the CAN module; default operation	0x1	Sample Point  The sample point is driven on the <code>CANnTx</code> signal. This mode is useful to monitor bit timing.	0x2	Driven Low  <code>CANnTx</code> drives a low value. This mode is useful for checking the physical layer of the CAN bus.	0x3	Driven High  <code>CANnTx</code> drives a high value. This mode is useful for checking the physical layer of the CAN bus.
Value	Description													
0x0	CAN Module Control  <code>CANnTx</code> is controlled by the CAN module; default operation													
0x1	Sample Point  The sample point is driven on the <code>CANnTx</code> signal. This mode is useful to monitor bit timing.													
0x2	Driven Low  <code>CANnTx</code> drives a low value. This mode is useful for checking the physical layer of the CAN bus.													
0x3	Driven High  <code>CANnTx</code> drives a high value. This mode is useful for checking the physical layer of the CAN bus.													



Bit/Field	Name	Type	Reset	Description	
4	LBACK	R/W	0	Loopback Mode	
				Value	Description
				0	Loopback mode is disabled.
				1	Loopback mode is enabled. In loopback mode, the data from the transmitter is routed into the receiver. Any data on the receive input is ignored.
3	SILENT	R/W	0	Silent Mode	
				Value	Description
				0	Silent mode is disabled.
				1	Silent mode is enabled. In silent mode, the CAN controller does not transmit data but instead monitors the bus. This mode is also known as Bus Monitor mode.
2	BASIC	R/W	0	Basic Mode	
				Value	Description
				0	Basic mode is disabled.
				1	Basic mode is enabled. In basic mode, software should use the <b>CANIF1</b> registers as the transmit buffer and use the <b>CANIF2</b> registers as the receive buffer.
1:0	reserved	RO	0x0	Software should not rely on the value of a reserved bit. To provide compatibility with future products, the value of a reserved bit should be preserved across a read-modify-write operation.	

### Register 7: CAN Baud Rate Prescaler Extension (CANBRPE), offset 0x018

This register is used to further divide the bit time set with the `BRP` bit in the `CANBIT` register. It is write-enabled by setting the `CCE` bit in the `CANCTL` register.

#### CAN Baud Rate Prescaler Extension (CANBRPE)

CAN0 base: 0x4004.0000  
 CAN1 base: 0x4004.1000  
 Offset 0x018  
 Type R/W, reset 0x0000.0000

	31	30	29	28	27	26	25	24	23	22	21	20	19	18	17	16
	reserved															
Type	RO	RO	RO	RO	RO	RO	RO	RO	RO	RO	RO	RO	RO	RO	RO	RO
Reset	0	0	0	0	0	0	0	0	0	0	0	0	0	0	0	0
	15	14	13	12	11	10	9	8	7	6	5	4	3	2	1	0
	reserved												BRPE			
Type	RO	RO	RO	RO	RO	RO	RO	RO	RO	RO	RO	RO	R/W	R/W	R/W	R/W
Reset	0	0	0	0	0	0	0	0	0	0	0	0	0	0	0	0

Bit/Field	Name	Type	Reset	Description
31:4	reserved	RO	0x0000.000	Software should not rely on the value of a reserved bit. To provide compatibility with future products, the value of a reserved bit should be preserved across a read-modify-write operation.
3:0	BRPE	R/W	0x0	Baud Rate Prescaler Extension  0x00-0x0F: Extend the <code>BRP</code> bit in the <code>CANBIT</code> register to values up to 1023. The actual interpretation by the hardware is one more than the value programmed by <code>BRPE</code> (MSBs) and <code>BRP</code> (LSBs).

**Register 8: CAN IF1 Command Request (CANIF1CRQ), offset 0x020****Register 9: CAN IF2 Command Request (CANIF2CRQ), offset 0x080**

A message transfer is started as soon as there is a write of the message object number to the `MNUM` field when the `TXRQST` bit in the `CANIF1MCTL` register is set. With this write operation, the `BUSY` bit is automatically set to indicate that a transfer between the CAN Interface Registers and the internal message RAM is in progress. After a wait time of 3 to 6 `CAN_CLK` periods, the transfer between the interface register and the message RAM completes, which then clears the `BUSY` bit.

## CAN IF1 Command Request (CANIF1CRQ)

CAN0 base: 0x4004.0000  
 CAN1 base: 0x4004.1000  
 Offset 0x020  
 Type R/W, reset 0x0000.0001

	31	30	29	28	27	26	25	24	23	22	21	20	19	18	17	16
	reserved															
Type	RO	RO	RO	RO	RO	RO	RO	RO	RO	RO	RO	RO	RO	RO	RO	RO
Reset	0	0	0	0	0	0	0	0	0	0	0	0	0	0	0	0
	15	14	13	12	11	10	9	8	7	6	5	4	3	2	1	0
	BUSY	reserved									MNUM					
Type	RO	RO	RO	RO	RO	RO	RO	RO	RO	RO	R/W	R/W	R/W	R/W	R/W	R/W
Reset	0	0	0	0	0	0	0	0	0	0	0	0	0	0	0	1

Bit/Field	Name	Type	Reset	Description						
31:16	reserved	RO	0x0000	Software should not rely on the value of a reserved bit. To provide compatibility with future products, the value of a reserved bit should be preserved across a read-modify-write operation.						
15	BUSY	RO	0	Busy Flag						
				<table border="1"> <thead> <tr> <th>Value</th> <th>Description</th> </tr> </thead> <tbody> <tr> <td>0</td> <td>This bit is cleared when read/write action has finished.</td> </tr> <tr> <td>1</td> <td>This bit is set when a write occurs to the message number in this register.</td> </tr> </tbody> </table>	Value	Description	0	This bit is cleared when read/write action has finished.	1	This bit is set when a write occurs to the message number in this register.
Value	Description									
0	This bit is cleared when read/write action has finished.									
1	This bit is set when a write occurs to the message number in this register.									
14:6	reserved	RO	0x00	Software should not rely on the value of a reserved bit. To provide compatibility with future products, the value of a reserved bit should be preserved across a read-modify-write operation.						

Bit/Field	Name	Type	Reset	Description								
5:0	MNUM	R/W	0x01	Message Number Selects one of the 32 message objects in the message RAM for data transfer. The message objects are numbered from 1 to 32.								
				<table><thead><tr><th>Value</th><th>Description</th></tr></thead><tbody><tr><td>0x00</td><td>Reserved 0 is not a valid message number; it is interpreted as 0x20, or object 32.</td></tr><tr><td>0x01-0x20</td><td>Message Number Indicates specified message object 1 to 32.</td></tr><tr><td>0x21-0x3F</td><td>Reserved Not a valid message number; values are shifted and it is interpreted as 0x01-0x1F.</td></tr></tbody></table>	Value	Description	0x00	Reserved 0 is not a valid message number; it is interpreted as 0x20, or object 32.	0x01-0x20	Message Number Indicates specified message object 1 to 32.	0x21-0x3F	Reserved Not a valid message number; values are shifted and it is interpreted as 0x01-0x1F.
Value	Description											
0x00	Reserved 0 is not a valid message number; it is interpreted as 0x20, or object 32.											
0x01-0x20	Message Number Indicates specified message object 1 to 32.											
0x21-0x3F	Reserved Not a valid message number; values are shifted and it is interpreted as 0x01-0x1F.											

**Register 10: CAN IF1 Command Mask (CANIF1CMSK), offset 0x024****Register 11: CAN IF2 Command Mask (CANIF2CMSK), offset 0x084**

Reading the Command Mask registers provides status for various functions. Writing to the Command Mask registers specifies the transfer direction and selects which buffer registers are the source or target of the data transfer.

Note that when a read from the message object buffer occurs when the WRNRD bit is clear and the CLRINTPND and/or NEWDAT bits are set, the interrupt pending and/or new data flags in the message object buffer are cleared.

**CAN IF1 Command Mask (CANIF1CMSK)**

CAN0 base: 0x4004.0000  
CAN1 base: 0x4004.1000  
Offset 0x024  
Type R/W, reset 0x0000.0000

	31	30	29	28	27	26	25	24	23	22	21	20	19	18	17	16
	reserved															
Type	RO	RO	RO	RO	RO	RO	RO	RO	RO	RO	RO	RO	RO	RO	RO	RO
Reset	0	0	0	0	0	0	0	0	0	0	0	0	0	0	0	0
	15	14	13	12	11	10	9	8	7	6	5	4	3	2	1	0
	reserved								WRNRD	MASK	ARB	CONTROL	CLRINTPND	NEWDAT / TXRQST	DATAA	DATAB
Type	RO	RO	RO	RO	RO	RO	RO	RO	R/W	R/W	R/W	R/W	R/W	R/W	R/W	R/W
Reset	0	0	0	0	0	0	0	0	0	0	0	0	0	0	0	0

Bit/Field	Name	Type	Reset	Description
31:8	reserved	RO	0x0000.00	Software should not rely on the value of a reserved bit. To provide compatibility with future products, the value of a reserved bit should be preserved across a read-modify-write operation.
7	WRNRD	R/W	0	Write, Not Read
				Value Description
				0 Transfer the data in the CAN message object specified by the the MNUM field in the <b>CANIFnCRQ</b> register into the CANIFn registers.
				1 Transfer the data in the CANIFn registers to the CAN message object specified by the MNUM field in the <b>CAN Command Request (CANIFnCRQ)</b> .
				<b>Note:</b> Interrupt pending and new data conditions in the message buffer can be cleared by reading from the buffer (WRNRD = 0) when the CLRINTPND and/or NEWDAT bits are set.
6	MASK	R/W	0	Access Mask Bits
				Value Description
				0 Mask bits unchanged.
				1 Transfer IDMASK + DIR + MXTD of the message object into the Interface registers.

Bit/Field	Name	Type	Reset	Description						
5	ARB	R/W	0	<p>Access Arbitration Bits</p> <table border="1"> <thead> <tr> <th>Value</th> <th>Description</th> </tr> </thead> <tbody> <tr> <td>0</td> <td>Arbitration bits unchanged.</td> </tr> <tr> <td>1</td> <td>Transfer ID + DIR + XTD + MSGVAL of the message object into the Interface registers.</td> </tr> </tbody> </table>	Value	Description	0	Arbitration bits unchanged.	1	Transfer ID + DIR + XTD + MSGVAL of the message object into the Interface registers.
Value	Description									
0	Arbitration bits unchanged.									
1	Transfer ID + DIR + XTD + MSGVAL of the message object into the Interface registers.									
4	CONTROL	R/W	0	<p>Access Control Bits</p> <table border="1"> <thead> <tr> <th>Value</th> <th>Description</th> </tr> </thead> <tbody> <tr> <td>0</td> <td>Control bits unchanged.</td> </tr> <tr> <td>1</td> <td>Transfer control bits from the <b>CANIFnMCTL</b> register into the Interface registers.</td> </tr> </tbody> </table>	Value	Description	0	Control bits unchanged.	1	Transfer control bits from the <b>CANIFnMCTL</b> register into the Interface registers.
Value	Description									
0	Control bits unchanged.									
1	Transfer control bits from the <b>CANIFnMCTL</b> register into the Interface registers.									
3	CLRINTPND	R/W	0	<p>Clear Interrupt Pending Bit</p> <p>The function of this bit depends on the configuration of the <b>WRNRD</b> bit.</p> <table border="1"> <thead> <tr> <th>Value</th> <th>Description</th> </tr> </thead> <tbody> <tr> <td>0</td> <td> <p>If <b>WRNRD</b> is clear, the interrupt pending status is transferred from the message buffer into the <b>CANIFnMCTL</b> register.</p> <p>If <b>WRNRD</b> is set, the <b>INTPND</b> bit in the message object remains unchanged.</p> </td> </tr> <tr> <td>1</td> <td> <p>If <b>WRNRD</b> is clear, the interrupt pending status is cleared in the message buffer. Note the value of this bit that is transferred to the <b>CANIFnMCTL</b> register always reflects the status of the bits before clearing.</p> <p>If <b>WRNRD</b> is set, the <b>INTPND</b> bit is cleared in the message object.</p> </td> </tr> </tbody> </table>	Value	Description	0	<p>If <b>WRNRD</b> is clear, the interrupt pending status is transferred from the message buffer into the <b>CANIFnMCTL</b> register.</p> <p>If <b>WRNRD</b> is set, the <b>INTPND</b> bit in the message object remains unchanged.</p>	1	<p>If <b>WRNRD</b> is clear, the interrupt pending status is cleared in the message buffer. Note the value of this bit that is transferred to the <b>CANIFnMCTL</b> register always reflects the status of the bits before clearing.</p> <p>If <b>WRNRD</b> is set, the <b>INTPND</b> bit is cleared in the message object.</p>
Value	Description									
0	<p>If <b>WRNRD</b> is clear, the interrupt pending status is transferred from the message buffer into the <b>CANIFnMCTL</b> register.</p> <p>If <b>WRNRD</b> is set, the <b>INTPND</b> bit in the message object remains unchanged.</p>									
1	<p>If <b>WRNRD</b> is clear, the interrupt pending status is cleared in the message buffer. Note the value of this bit that is transferred to the <b>CANIFnMCTL</b> register always reflects the status of the bits before clearing.</p> <p>If <b>WRNRD</b> is set, the <b>INTPND</b> bit is cleared in the message object.</p>									
2	NEWDAT / TXRQST	R/W	0	<p>NEWDAT / TXRQST Bit</p> <p>The function of this bit depends on the configuration of the <b>WRNRD</b> bit.</p> <table border="1"> <thead> <tr> <th>Value</th> <th>Description</th> </tr> </thead> <tbody> <tr> <td>0</td> <td> <p>If <b>WRNRD</b> is clear, the value of the new data status is transferred from the message buffer into the <b>CANIFnMCTL</b> register.</p> <p>If <b>WRNRD</b> is set, a transmission is not requested.</p> </td> </tr> <tr> <td>1</td> <td> <p>If <b>WRNRD</b> is clear, the new data status is cleared in the message buffer. Note the value of this bit that is transferred to the <b>CANIFnMCTL</b> register always reflects the status of the bits before clearing.</p> <p>If <b>WRNRD</b> is set, a transmission is requested. Note that when this bit is set, the <b>TXRQST</b> bit in the <b>CANIFnMCTL</b> register is ignored.</p> </td> </tr> </tbody> </table>	Value	Description	0	<p>If <b>WRNRD</b> is clear, the value of the new data status is transferred from the message buffer into the <b>CANIFnMCTL</b> register.</p> <p>If <b>WRNRD</b> is set, a transmission is not requested.</p>	1	<p>If <b>WRNRD</b> is clear, the new data status is cleared in the message buffer. Note the value of this bit that is transferred to the <b>CANIFnMCTL</b> register always reflects the status of the bits before clearing.</p> <p>If <b>WRNRD</b> is set, a transmission is requested. Note that when this bit is set, the <b>TXRQST</b> bit in the <b>CANIFnMCTL</b> register is ignored.</p>
Value	Description									
0	<p>If <b>WRNRD</b> is clear, the value of the new data status is transferred from the message buffer into the <b>CANIFnMCTL</b> register.</p> <p>If <b>WRNRD</b> is set, a transmission is not requested.</p>									
1	<p>If <b>WRNRD</b> is clear, the new data status is cleared in the message buffer. Note the value of this bit that is transferred to the <b>CANIFnMCTL</b> register always reflects the status of the bits before clearing.</p> <p>If <b>WRNRD</b> is set, a transmission is requested. Note that when this bit is set, the <b>TXRQST</b> bit in the <b>CANIFnMCTL</b> register is ignored.</p>									

Bit/Field	Name	Type	Reset	Description						
1	DATAA	R/W	0	<p>Access Data Byte 0 to 3</p> <p>The function of this bit depends on the configuration of the WRNRD bit.</p> <table border="1"> <thead> <tr> <th>Value</th> <th>Description</th> </tr> </thead> <tbody> <tr> <td>0</td> <td>Data bytes 0-3 are unchanged.</td> </tr> <tr> <td>1</td> <td> <p>If WRNRD is clear, transfer data bytes 0-3 in <b>CANIFnDA1</b> and <b>CANIFnDA2</b> to the message object.</p> <p>If WRNRD is set, transfer data bytes 0-3 in message object to <b>CANIFnDA1</b> and <b>CANIFnDA2</b>.</p> </td> </tr> </tbody> </table>	Value	Description	0	Data bytes 0-3 are unchanged.	1	<p>If WRNRD is clear, transfer data bytes 0-3 in <b>CANIFnDA1</b> and <b>CANIFnDA2</b> to the message object.</p> <p>If WRNRD is set, transfer data bytes 0-3 in message object to <b>CANIFnDA1</b> and <b>CANIFnDA2</b>.</p>
Value	Description									
0	Data bytes 0-3 are unchanged.									
1	<p>If WRNRD is clear, transfer data bytes 0-3 in <b>CANIFnDA1</b> and <b>CANIFnDA2</b> to the message object.</p> <p>If WRNRD is set, transfer data bytes 0-3 in message object to <b>CANIFnDA1</b> and <b>CANIFnDA2</b>.</p>									
0	DATAB	R/W	0	<p>Access Data Byte 4 to 7</p> <p>The function of this bit depends on the configuration of the WRNRD bit as follows:</p> <table border="1"> <thead> <tr> <th>Value</th> <th>Description</th> </tr> </thead> <tbody> <tr> <td>0</td> <td>Data bytes 4-7 are unchanged.</td> </tr> <tr> <td>1</td> <td> <p>If WRNRD is clear, transfer data bytes 4-7 in <b>CANIFnDA1</b> and <b>CANIFnDA2</b> to the message object.</p> <p>If WRNRD is set, transfer data bytes 4-7 in message object to <b>CANIFnDA1</b> and <b>CANIFnDA2</b>.</p> </td> </tr> </tbody> </table>	Value	Description	0	Data bytes 4-7 are unchanged.	1	<p>If WRNRD is clear, transfer data bytes 4-7 in <b>CANIFnDA1</b> and <b>CANIFnDA2</b> to the message object.</p> <p>If WRNRD is set, transfer data bytes 4-7 in message object to <b>CANIFnDA1</b> and <b>CANIFnDA2</b>.</p>
Value	Description									
0	Data bytes 4-7 are unchanged.									
1	<p>If WRNRD is clear, transfer data bytes 4-7 in <b>CANIFnDA1</b> and <b>CANIFnDA2</b> to the message object.</p> <p>If WRNRD is set, transfer data bytes 4-7 in message object to <b>CANIFnDA1</b> and <b>CANIFnDA2</b>.</p>									

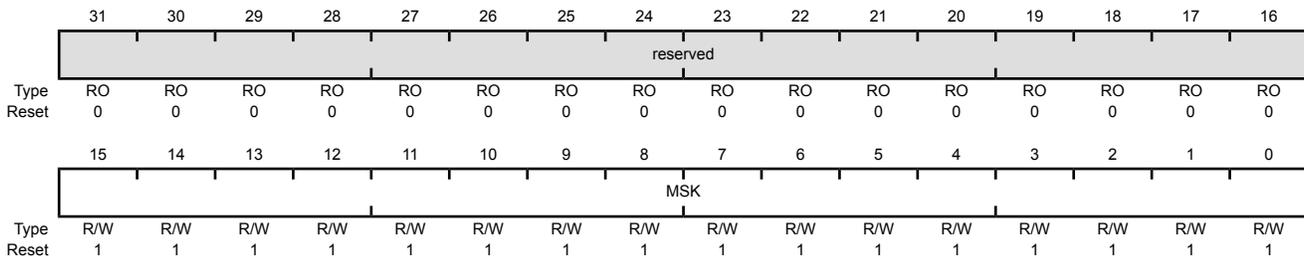
**Register 12: CAN IF1 Mask 1 (CANIF1MSK1), offset 0x028**

**Register 13: CAN IF2 Mask 1 (CANIF2MSK1), offset 0x088**

The mask information provided in this register accompanies the data (**CANIFnDAn**), arbitration information (**CANIFnARBn**), and control information (**CANIFnMCTL**) to the message object in the message RAM. The mask is used with the **ID** bit in the **CANIFnARBn** register for acceptance filtering. Additional mask information is contained in the **CANIFnMSK2** register.

CAN IF1 Mask 1 (CANIF1MSK1)

CAN0 base: 0x4004.0000  
 CAN1 base: 0x4004.1000  
 Offset 0x028  
 Type R/W, reset 0x0000.FFFF



Bit/Field	Name	Type	Reset	Description
31:16	reserved	RO	0x0000	Software should not rely on the value of a reserved bit. To provide compatibility with future products, the value of a reserved bit should be preserved across a read-modify-write operation.
15:0	MSK	R/W	0xFFFF	Identifier Mask

When using a 29-bit identifier, these bits are used for bits [15:0] of the ID. The **MSK** field in the **CANIFnMSK2** register are used for bits [28:16] of the ID. When using an 11-bit identifier, these bits are ignored.

Value	Description
0	The corresponding identifier field ( <b>ID</b> ) in the message object cannot inhibit the match in acceptance filtering.
1	The corresponding identifier field ( <b>ID</b> ) is used for acceptance filtering.



**Register 14: CAN IF1 Mask 2 (CANIF1MSK2), offset 0x02C****Register 15: CAN IF2 Mask 2 (CANIF2MSK2), offset 0x08C**

This register holds extended mask information that accompanies the **CANIFnMSK1** register.

## CAN IF1 Mask 2 (CANIF1MSK2)

CAN0 base: 0x4004.0000

CAN1 base: 0x4004.1000

Offset 0x02C

Type R/W, reset 0x0000.FFFF

	31	30	29	28	27	26	25	24	23	22	21	20	19	18	17	16
	reserved															
Type	RO	RO	RO	RO	RO	RO	RO	RO	RO	RO	RO	RO	RO	RO	RO	RO
Reset	0	0	0	0	0	0	0	0	0	0	0	0	0	0	0	0
	15	14	13	12	11	10	9	8	7	6	5	4	3	2	1	0
	MXTD	MDIR	reserved													
Type	R/W	R/W	RO	R/W	R/W	R/W	R/W	R/W	R/W	R/W	R/W	R/W	R/W	R/W	R/W	R/W
Reset	1	1	1	0	0	0	0	0	1	1	1	1	1	1	1	1

Bit/Field	Name	Type	Reset	Description						
31:16	reserved	RO	0x0000	Software should not rely on the value of a reserved bit. To provide compatibility with future products, the value of a reserved bit should be preserved across a read-modify-write operation.						
15	MXTD	R/W	1	Mask Extended Identifier <table border="0" style="margin-left: 20px;"> <tr> <td>Value</td> <td>Description</td> </tr> <tr> <td>0</td> <td>The extended identifier bit (<i>X</i>TD in the <b>CANIFnARB2</b> register) has no effect on the acceptance filtering.</td> </tr> <tr> <td>1</td> <td>The extended identifier bit <i>X</i>TD is used for acceptance filtering.</td> </tr> </table>	Value	Description	0	The extended identifier bit ( <i>X</i> TD in the <b>CANIFnARB2</b> register) has no effect on the acceptance filtering.	1	The extended identifier bit <i>X</i> TD is used for acceptance filtering.
Value	Description									
0	The extended identifier bit ( <i>X</i> TD in the <b>CANIFnARB2</b> register) has no effect on the acceptance filtering.									
1	The extended identifier bit <i>X</i> TD is used for acceptance filtering.									
14	MDIR	R/W	1	Mask Message Direction <table border="0" style="margin-left: 20px;"> <tr> <td>Value</td> <td>Description</td> </tr> <tr> <td>0</td> <td>The message direction bit (<i>D</i>IR in the <b>CANIFnARB2</b> register) has no effect for acceptance filtering.</td> </tr> <tr> <td>1</td> <td>The message direction bit <i>D</i>IR is used for acceptance filtering.</td> </tr> </table>	Value	Description	0	The message direction bit ( <i>D</i> IR in the <b>CANIFnARB2</b> register) has no effect for acceptance filtering.	1	The message direction bit <i>D</i> IR is used for acceptance filtering.
Value	Description									
0	The message direction bit ( <i>D</i> IR in the <b>CANIFnARB2</b> register) has no effect for acceptance filtering.									
1	The message direction bit <i>D</i> IR is used for acceptance filtering.									
13	reserved	RO	1	Software should not rely on the value of a reserved bit. To provide compatibility with future products, the value of a reserved bit should be preserved across a read-modify-write operation.						

Bit/Field	Name	Type	Reset	Description						
12:0	MSK	R/W	0xFF	<p>Identifier Mask</p> <p>When using a 29-bit identifier, these bits are used for bits [28:16] of the ID. The <code>MSK</code> field in the <code>CANIFnMSK1</code> register are used for bits [15:0] of the ID. When using an 11-bit identifier, <code>MSK[12:2]</code> are used for bits [10:0] of the ID.</p> <table><thead><tr><th>Value</th><th>Description</th></tr></thead><tbody><tr><td>0</td><td>The corresponding identifier field (<code>ID</code>) in the message object cannot inhibit the match in acceptance filtering.</td></tr><tr><td>1</td><td>The corresponding identifier field (<code>ID</code>) is used for acceptance filtering.</td></tr></tbody></table>	Value	Description	0	The corresponding identifier field ( <code>ID</code> ) in the message object cannot inhibit the match in acceptance filtering.	1	The corresponding identifier field ( <code>ID</code> ) is used for acceptance filtering.
Value	Description									
0	The corresponding identifier field ( <code>ID</code> ) in the message object cannot inhibit the match in acceptance filtering.									
1	The corresponding identifier field ( <code>ID</code> ) is used for acceptance filtering.									

**Register 16: CAN IF1 Arbitration 1 (CANIF1ARB1), offset 0x030****Register 17: CAN IF2 Arbitration 1 (CANIF2ARB1), offset 0x090**

These registers hold the identifiers for acceptance filtering.

## CAN IF1 Arbitration 1 (CANIF1ARB1)

CAN0 base: 0x4004.0000

CAN1 base: 0x4004.1000

Offset 0x030

Type R/W, reset 0x0000.0000

	31	30	29	28	27	26	25	24	23	22	21	20	19	18	17	16
	reserved															
Type	RO	RO	RO	RO	RO	RO	RO	RO	RO	RO	RO	RO	RO	RO	RO	RO
Reset	0	0	0	0	0	0	0	0	0	0	0	0	0	0	0	0
	15	14	13	12	11	10	9	8	7	6	5	4	3	2	1	0
	ID															
Type	R/W	R/W	R/W	R/W	R/W	R/W	R/W	R/W	R/W	R/W	R/W	R/W	R/W	R/W	R/W	R/W
Reset	0	0	0	0	0	0	0	0	0	0	0	0	0	0	0	0

Bit/Field	Name	Type	Reset	Description
31:16	reserved	RO	0x0000	Software should not rely on the value of a reserved bit. To provide compatibility with future products, the value of a reserved bit should be preserved across a read-modify-write operation.
15:0	ID	R/W	0x0000	<p>Message Identifier</p> <p>This bit field is used with the <code>ID</code> field in the <code>CANIFnARB2</code> register to create the message identifier.</p> <p>When using a 29-bit identifier, bits 15:0 of the <code>CANIFnARB1</code> register are [15:0] of the ID, while bits 12:0 of the <code>CANIFnARB2</code> register are [28:16] of the ID.</p> <p>When using an 11-bit identifier, these bits are not used.</p>

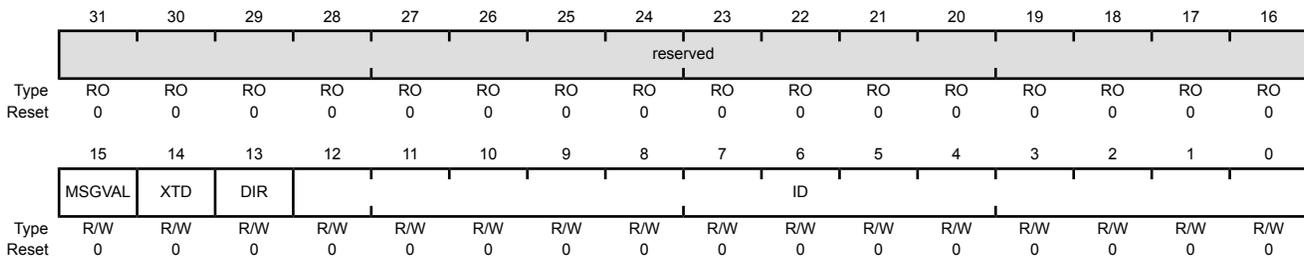
**Register 18: CAN IF1 Arbitration 2 (CANIF1ARB2), offset 0x034**

**Register 19: CAN IF2 Arbitration 2 (CANIF2ARB2), offset 0x094**

These registers hold information for acceptance filtering.

CAN IF1 Arbitration 2 (CANIF1ARB2)

CAN0 base: 0x4004.0000  
 CAN1 base: 0x4004.1000  
 Offset 0x034  
 Type R/W, reset 0x0000.0000



Bit/Field	Name	Type	Reset	Description
31:16	reserved	RO	0x0000	Software should not rely on the value of a reserved bit. To provide compatibility with future products, the value of a reserved bit should be preserved across a read-modify-write operation.

15	MSGVAL	R/W	0	Message Valid
	Value	Description		
	0	The message object is ignored by the message handler.		
	1	The message object is configured and ready to be considered by the message handler within the CAN controller.		

All unused message objects should have this bit cleared during initialization and before clearing the `INIT` bit in the `CANCTL` register. The `MSGVAL` bit must also be cleared before any of the following bits are modified or if the message object is no longer required: the `ID` fields in the `CANIFnARBn` registers, the `XTD` and `DIR` bits in the `CANIFnARB2` register, or the `DLC` field in the `CANIFnMCTL` register.

14	XTD	R/W	0	Extended Identifier
	Value	Description		
	0	An 11-bit Standard Identifier is used for this message object.		
	1	A 29-bit Extended Identifier is used for this message object.		

Bit/Field	Name	Type	Reset	Description						
13	DIR	R/W	0	<p>Message Direction</p> <table border="1"> <thead> <tr> <th>Value</th> <th>Description</th> </tr> </thead> <tbody> <tr> <td>0</td> <td>Receive. When the <code>TXRQST</code> bit in the <b>CANIFnMCTL</b> register is set, a remote frame with the identifier of this message object is received. On reception of a data frame with matching identifier, that message is stored in this message object.</td> </tr> <tr> <td>1</td> <td>Transmit. When the <code>TXRQST</code> bit in the <b>CANIFnMCTL</b> register is set, the respective message object is transmitted as a data frame. On reception of a remote frame with matching identifier, the <code>TXRQST</code> bit of this message object is set (if <code>RMTEEN=1</code>).</td> </tr> </tbody> </table>	Value	Description	0	Receive. When the <code>TXRQST</code> bit in the <b>CANIFnMCTL</b> register is set, a remote frame with the identifier of this message object is received. On reception of a data frame with matching identifier, that message is stored in this message object.	1	Transmit. When the <code>TXRQST</code> bit in the <b>CANIFnMCTL</b> register is set, the respective message object is transmitted as a data frame. On reception of a remote frame with matching identifier, the <code>TXRQST</code> bit of this message object is set (if <code>RMTEEN=1</code> ).
Value	Description									
0	Receive. When the <code>TXRQST</code> bit in the <b>CANIFnMCTL</b> register is set, a remote frame with the identifier of this message object is received. On reception of a data frame with matching identifier, that message is stored in this message object.									
1	Transmit. When the <code>TXRQST</code> bit in the <b>CANIFnMCTL</b> register is set, the respective message object is transmitted as a data frame. On reception of a remote frame with matching identifier, the <code>TXRQST</code> bit of this message object is set (if <code>RMTEEN=1</code> ).									
12:0	ID	R/W	0x000	<p>Message Identifier</p> <p>This bit field is used with the <code>ID</code> field in the <b>CANIFnARB2</b> register to create the message identifier.</p> <p>When using a 29-bit identifier, <code>ID[15:0]</code> of the <b>CANIFnARB1</b> register are [15:0] of the ID, while these bits, <code>ID[12:0]</code>, are [28:16] of the ID.</p> <p>When using an 11-bit identifier, <code>ID[12:2]</code> are used for bits [10:0] of the ID. The <code>ID</code> field in the <b>CANIFnARB1</b> register is ignored.</p>						

**Register 20: CAN IF1 Message Control (CANIF1MCTL), offset 0x038**

**Register 21: CAN IF2 Message Control (CANIF2MCTL), offset 0x098**

This register holds the control information associated with the message object to be sent to the Message RAM.

CAN IF1 Message Control (CANIF1MCTL)

CAN0 base: 0x4004.0000  
 CAN1 base: 0x4004.1000  
 Offset 0x038  
 Type R/W, reset 0x0000.0000

	31	30	29	28	27	26	25	24	23	22	21	20	19	18	17	16
	reserved															
Type	RO	RO	RO	RO	RO	RO	RO	RO	RO	RO	RO	RO	RO	RO	RO	RO
Reset	0	0	0	0	0	0	0	0	0	0	0	0	0	0	0	0
	15	14	13	12	11	10	9	8	7	6	5	4	3	2	1	0
	NEWDAT	MSGLST	INTPND	UMASK	TXIE	RXIE	RMTEN	TXRQST	EOB	reserved			DLC			
Type	R/W	R/W	R/W	R/W	R/W	R/W	R/W	R/W	R/W	RO	RO	RO	R/W	R/W	R/W	R/W
Reset	0	0	0	0	0	0	0	0	0	0	0	0	0	0	0	0

Bit/Field	Name	Type	Reset	Description						
31:16	reserved	RO	0x0000	Software should not rely on the value of a reserved bit. To provide compatibility with future products, the value of a reserved bit should be preserved across a read-modify-write operation.						
15	NEWDAT	R/W	0	New Data  <table border="1"> <thead> <tr> <th>Value</th> <th>Description</th> </tr> </thead> <tbody> <tr> <td>0</td> <td>No new data has been written into the data portion of this message object by the message handler since the last time this flag was cleared by the CPU.</td> </tr> <tr> <td>1</td> <td>The message handler or the CPU has written new data into the data portion of this message object.</td> </tr> </tbody> </table>	Value	Description	0	No new data has been written into the data portion of this message object by the message handler since the last time this flag was cleared by the CPU.	1	The message handler or the CPU has written new data into the data portion of this message object.
Value	Description									
0	No new data has been written into the data portion of this message object by the message handler since the last time this flag was cleared by the CPU.									
1	The message handler or the CPU has written new data into the data portion of this message object.									
14	MSGLST	R/W	0	Message Lost  <table border="1"> <thead> <tr> <th>Value</th> <th>Description</th> </tr> </thead> <tbody> <tr> <td>0</td> <td>No message was lost since the last time this bit was cleared by the CPU.</td> </tr> <tr> <td>1</td> <td>The message handler stored a new message into this object when NEWDAT was set; the CPU has lost a message.</td> </tr> </tbody> </table> <p>This bit is only valid for message objects when the DIR bit in the CANIFnARB2 register is clear (receive).</p>	Value	Description	0	No message was lost since the last time this bit was cleared by the CPU.	1	The message handler stored a new message into this object when NEWDAT was set; the CPU has lost a message.
Value	Description									
0	No message was lost since the last time this bit was cleared by the CPU.									
1	The message handler stored a new message into this object when NEWDAT was set; the CPU has lost a message.									
13	INTPND	R/W	0	Interrupt Pending  <table border="1"> <thead> <tr> <th>Value</th> <th>Description</th> </tr> </thead> <tbody> <tr> <td>0</td> <td>This message object is not the source of an interrupt.</td> </tr> <tr> <td>1</td> <td>This message object is the source of an interrupt. The interrupt identifier in the CANINT register points to this message object if there is not another interrupt source with a higher priority.</td> </tr> </tbody> </table>	Value	Description	0	This message object is not the source of an interrupt.	1	This message object is the source of an interrupt. The interrupt identifier in the CANINT register points to this message object if there is not another interrupt source with a higher priority.
Value	Description									
0	This message object is not the source of an interrupt.									
1	This message object is the source of an interrupt. The interrupt identifier in the CANINT register points to this message object if there is not another interrupt source with a higher priority.									

Bit/Field	Name	Type	Reset	Description
12	UMASK	R/W	0	Use Acceptance Mask  Value      Description 0            Mask is ignored. 1            Use mask (MSK, MXTD, and MDIR bits in the <b>CANIFnMSKn</b> registers) for acceptance filtering.
11	TXIE	R/W	0	Transmit Interrupt Enable  Value      Description 0            The <b>INTPND</b> bit in the <b>CANIFnMCTL</b> register is unchanged after a successful transmission of a frame. 1            The <b>INTPND</b> bit in the <b>CANIFnMCTL</b> register is set after a successful transmission of a frame.
10	RXIE	R/W	0	Receive Interrupt Enable  Value      Description 0            The <b>INTPND</b> bit in the <b>CANIFnMCTL</b> register is unchanged after a successful reception of a frame. 1            The <b>INTPND</b> bit in the <b>CANIFnMCTL</b> register is set after a successful reception of a frame.
9	RMTEN	R/W	0	Remote Enable  Value      Description 0            At the reception of a remote frame, the <b>TXRQST</b> bit in the <b>CANIFnMCTL</b> register is left unchanged. 1            At the reception of a remote frame, the <b>TXRQST</b> bit in the <b>CANIFnMCTL</b> register is set.
8	TXRQST	R/W	0	Transmit Request  Value      Description 0            This message object is not waiting for transmission. 1            The transmission of this message object is requested and is not yet done.  <b>Note:</b> If the <b>WRNRD</b> and <b>TXRQST</b> bits in the <b>CANIFnCMSK</b> register are set, this bit is ignored.

Bit/Field	Name	Type	Reset	Description						
7	EOB	R/W	0	<p>End of Buffer</p> <table border="1"> <thead> <tr> <th>Value</th> <th>Description</th> </tr> </thead> <tbody> <tr> <td>0</td> <td>Message object belongs to a FIFO Buffer and is not the last message object of that FIFO Buffer.</td> </tr> <tr> <td>1</td> <td>Single message object or last message object of a FIFO Buffer.</td> </tr> </tbody> </table> <p>This bit is used to concatenate two or more message objects (up to 32) to build a FIFO buffer. For a single message object (thus not belonging to a FIFO buffer), this bit must be set.</p>	Value	Description	0	Message object belongs to a FIFO Buffer and is not the last message object of that FIFO Buffer.	1	Single message object or last message object of a FIFO Buffer.
Value	Description									
0	Message object belongs to a FIFO Buffer and is not the last message object of that FIFO Buffer.									
1	Single message object or last message object of a FIFO Buffer.									
6:4	reserved	RO	0x0	Software should not rely on the value of a reserved bit. To provide compatibility with future products, the value of a reserved bit should be preserved across a read-modify-write operation.						
3:0	DLC	R/W	0x0	<p>Data Length Code</p> <table border="1"> <thead> <tr> <th>Value</th> <th>Description</th> </tr> </thead> <tbody> <tr> <td>0x0-0x8</td> <td>Specifies the number of bytes in the data frame.</td> </tr> <tr> <td>0x9-0xF</td> <td>Defaults to a data frame with 8 bytes.</td> </tr> </tbody> </table> <p>The <b>DLC</b> field in the <b>CANIFnMCTL</b> register of a message object must be defined the same as in all the corresponding objects with the same identifier at other nodes. When the message handler stores a data frame, it writes <b>DLC</b> to the value given by the received message.</p>	Value	Description	0x0-0x8	Specifies the number of bytes in the data frame.	0x9-0xF	Defaults to a data frame with 8 bytes.
Value	Description									
0x0-0x8	Specifies the number of bytes in the data frame.									
0x9-0xF	Defaults to a data frame with 8 bytes.									



**Register 22: CAN IF1 Data A1 (CANIF1DA1), offset 0x03C**

**Register 23: CAN IF1 Data A2 (CANIF1DA2), offset 0x040**

**Register 24: CAN IF1 Data B1 (CANIF1DB1), offset 0x044**

**Register 25: CAN IF1 Data B2 (CANIF1DB2), offset 0x048**

**Register 26: CAN IF2 Data A1 (CANIF2DA1), offset 0x09C**

**Register 27: CAN IF2 Data A2 (CANIF2DA2), offset 0x0A0**

**Register 28: CAN IF2 Data B1 (CANIF2DB1), offset 0x0A4**

**Register 29: CAN IF2 Data B2 (CANIF2DB2), offset 0x0A8**

These registers contain the data to be sent or that has been received. In a CAN data frame, data byte 0 is the first byte to be transmitted or received and data byte 7 is the last byte to be transmitted or received. In CAN's serial bit stream, the MSB of each byte is transmitted first.

#### CAN IF1 Data A1 (CANIF1DA1)

CAN0 base: 0x4004.0000  
CAN1 base: 0x4004.1000  
Offset 0x03C  
Type R/W, reset 0x0000.0000

	31	30	29	28	27	26	25	24	23	22	21	20	19	18	17	16
	reserved															
Type	RO	RO	RO	RO	RO	RO	RO	RO	RO	RO	RO	RO	RO	RO	RO	RO
Reset	0	0	0	0	0	0	0	0	0	0	0	0	0	0	0	0
	15	14	13	12	11	10	9	8	7	6	5	4	3	2	1	0
	DATA															
Type	R/W	R/W	R/W	R/W	R/W	R/W	R/W	R/W	R/W	R/W	R/W	R/W	R/W	R/W	R/W	R/W
Reset	0	0	0	0	0	0	0	0	0	0	0	0	0	0	0	0

Bit/Field	Name	Type	Reset	Description
31:16	reserved	RO	0x0000	Software should not rely on the value of a reserved bit. To provide compatibility with future products, the value of a reserved bit should be preserved across a read-modify-write operation.
15:0	DATA	R/W	0x0000	Data

The **CANIFnDA1** registers contain data bytes 1 and 0; **CANIFnDA2** data bytes 3 and 2; **CANIFnDB1** data bytes 5 and 4; and **CANIFnDB2** data bytes 7 and 6.

**Register 30: CAN Transmission Request 1 (CANTXRQ1), offset 0x100**

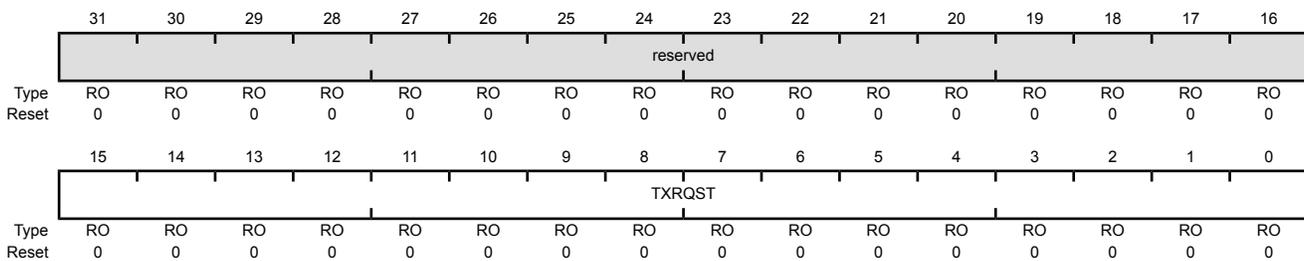
**Register 31: CAN Transmission Request 2 (CANTXRQ2), offset 0x104**

The **CANTXRQ1** and **CANTXRQ2** registers hold the **TXRQST** bits of the 32 message objects. By reading out these bits, the CPU can check which message object has a transmission request pending. The **TXRQST** bit of a specific message object can be changed by three sources: (1) the CPU via the **CANIFnMCTL** register, (2) the message handler state machine after the reception of a remote frame, or (3) the message handler state machine after a successful transmission.

The **CANTXRQ1** register contains the **TXRQST** bits of the first 16 message objects in the message RAM; the **CANTXRQ2** register contains the **TXRQST** bits of the second 16 message objects.

CAN Transmission Request 1 (CANTXRQ1)

CAN0 base: 0x4004.0000  
 CAN1 base: 0x4004.1000  
 Offset 0x100  
 Type RO, reset 0x0000.0000



Bit/Field	Name	Type	Reset	Description
31:16	reserved	RO	0x0000	Software should not rely on the value of a reserved bit. To provide compatibility with future products, the value of a reserved bit should be preserved across a read-modify-write operation.
15:0	TXRQST	RO	0x0000	Transmission Request Bits
				Value      Description
				0            The corresponding message object is not waiting for transmission.
				1            The transmission of the corresponding message object is requested and is not yet done.

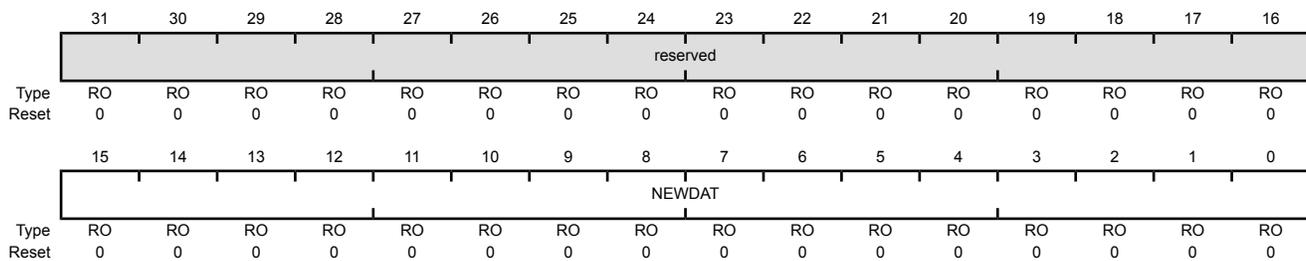
**Register 32: CAN New Data 1 (CANNWDA1), offset 0x120****Register 33: CAN New Data 2 (CANNWDA2), offset 0x124**

The **CANNWDA1** and **CANNWDA2** registers hold the **NEWDAT** bits of the 32 message objects. By reading these bits, the CPU can check which message object has its data portion updated. The **NEWDAT** bit of a specific message object can be changed by three sources: (1) the CPU via the **CANIFnMCTL** register, (2) the message handler state machine after the reception of a data frame, or (3) the message handler state machine after a successful transmission.

The **CANNWDA1** register contains the **NEWDAT** bits of the first 16 message objects in the message RAM; the **CANNWDA2** register contains the **NEWDAT** bits of the second 16 message objects.

## CAN New Data 1 (CANNWDA1)

CAN0 base: 0x4004.0000  
 CAN1 base: 0x4004.1000  
 Offset 0x120  
 Type RO, reset 0x0000.0000



Bit/Field	Name	Type	Reset	Description
31:16	reserved	RO	0x0000	Software should not rely on the value of a reserved bit. To provide compatibility with future products, the value of a reserved bit should be preserved across a read-modify-write operation.
15:0	NEWDAT	RO	0x0000	New Data Bits
				Value    Description
				0        No new data has been written into the data portion of the corresponding message object by the message handler since the last time this flag was cleared by the CPU.
				1        The message handler or the CPU has written new data into the data portion of the corresponding message object.

**Register 34: CAN Message 1 Interrupt Pending (CANMSG1INT), offset 0x140**

**Register 35: CAN Message 2 Interrupt Pending (CANMSG2INT), offset 0x144**

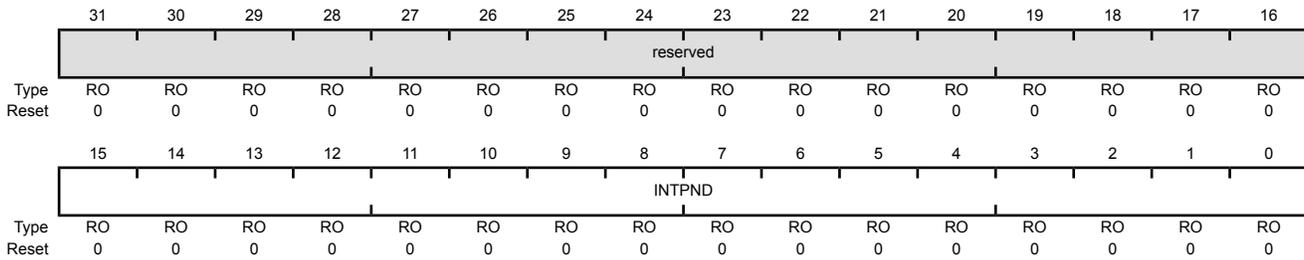
The **CANMSG1INT** and **CANMSG2INT** registers hold the **INTPND** bits of the 32 message objects. By reading these bits, the CPU can check which message object has an interrupt pending. The **INTPND** bit of a specific message object can be changed through two sources: (1) the CPU via the **CANIFnMCTL** register, or (2) the message handler state machine after the reception or transmission of a frame.

This field is also encoded in the **CANINT** register.

The **CANMSG1INT** register contains the **INTPND** bits of the first 16 message objects in the message RAM; the **CANMSG2INT** register contains the **INTPND** bits of the second 16 message objects.

**CAN Message 1 Interrupt Pending (CANMSG1INT)**

CAN0 base: 0x4004.0000  
 CAN1 base: 0x4004.1000  
 Offset 0x140  
 Type RO, reset 0x0000.0000



Bit/Field	Name	Type	Reset	Description
31:16	reserved	RO	0x0000	Software should not rely on the value of a reserved bit. To provide compatibility with future products, the value of a reserved bit should be preserved across a read-modify-write operation.
15:0	INTPND	RO	0x0000	Interrupt Pending Bits
			Value	Description
			0	The corresponding message object is not the source of an interrupt.
			1	The corresponding message object is the source of an interrupt.

**Register 36: CAN Message 1 Valid (CANMSG1VAL), offset 0x160****Register 37: CAN Message 2 Valid (CANMSG2VAL), offset 0x164**

The **CANMSG1VAL** and **CANMSG2VAL** registers hold the **MSGVAL** bits of the 32 message objects. By reading these bits, the CPU can check which message object is valid. The message valid bit of a specific message object can be changed with the **CANIFnARB2** register.

The **CANMSG1VAL** register contains the **MSGVAL** bits of the first 16 message objects in the message RAM; the **CANMSG2VAL** register contains the **MSGVAL** bits of the second 16 message objects in the message RAM.

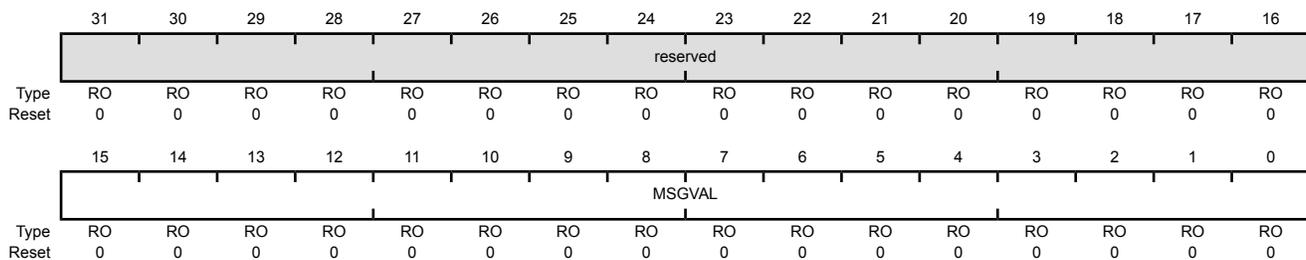
## CAN Message 1 Valid (CANMSG1VAL)

CAN0 base: 0x4004.0000

CAN1 base: 0x4004.1000

Offset 0x160

Type RO, reset 0x0000.0000



Bit/Field	Name	Type	Reset	Description
31:16	reserved	RO	0x0000	Software should not rely on the value of a reserved bit. To provide compatibility with future products, the value of a reserved bit should be preserved across a read-modify-write operation.
15:0	MSGVAL	RO	0x0000	Message Valid Bits
				Value      Description
				0            The corresponding message object is not configured and is ignored by the message handler.
				1            The corresponding message object is configured and should be considered by the message handler.

## 19 Ethernet Controller

The Stellaris<sup>®</sup> Ethernet Controller consists of a fully integrated media access controller (MAC) and network physical (PHY) interface. The Ethernet Controller conforms to *IEEE 802.3* specifications and fully supports 10BASE-T and 100BASE-TX standards.

The Stellaris<sup>®</sup> Ethernet Controller module has the following features:

- Conforms to the *IEEE 802.3-2002 specification*
  - 10BASE-T/100BASE-TX IEEE-802.3 compliant. Requires only a dual 1:1 isolation transformer interface to the line
  - 10BASE-T/100BASE-TX ENDEC, 100BASE-TX scrambler/descrambler
  - Full-featured auto-negotiation
- Multiple operational modes
  - Full- and half-duplex 100 Mbps
  - Full- and half-duplex 10 Mbps
  - Power-saving and power-down modes
- Highly configurable
  - Programmable MAC address
  - LED activity selection
  - Promiscuous mode support
  - CRC error-rejection control
  - User-configurable interrupts
- Physical media manipulation
  - MDI/MDI-X cross-over support through software assist
  - Register-programmable transmit amplitude
  - Automatic polarity correction and 10BASE-T signal reception
- IEEE 1588 Precision Time Protocol: Provides highly accurate time stamps for individual packets
- Efficient transfers using Micro Direct Memory Access Controller ( $\mu$ DMA)
  - Separate channels for transmit and receive
  - Receive channel request asserted on packet receipt
  - Transmit channel request asserted on empty transmit FIFO

## 19.1 Block Diagram

As shown in Figure 19-1 on page 815, the Ethernet Controller is functionally divided into two layers: the Media Access Controller (MAC) layer and the Network Physical (PHY) layer. These layers correspond to the OSI model layers 2 and 1, respectively. The CPU accesses the Ethernet Controller via the MAC layer. The MAC layer provides transmit and receive processing for Ethernet frames. The MAC layer also provides the interface to the PHY layer via an internal Media Independent Interface (MII). The PHY layer communicates with the Ethernet bus.

Figure 19-1. Ethernet Controller

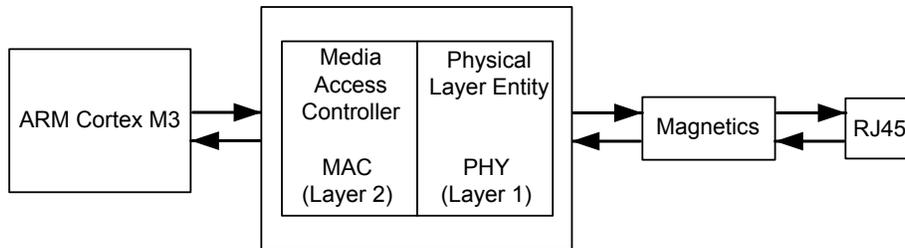
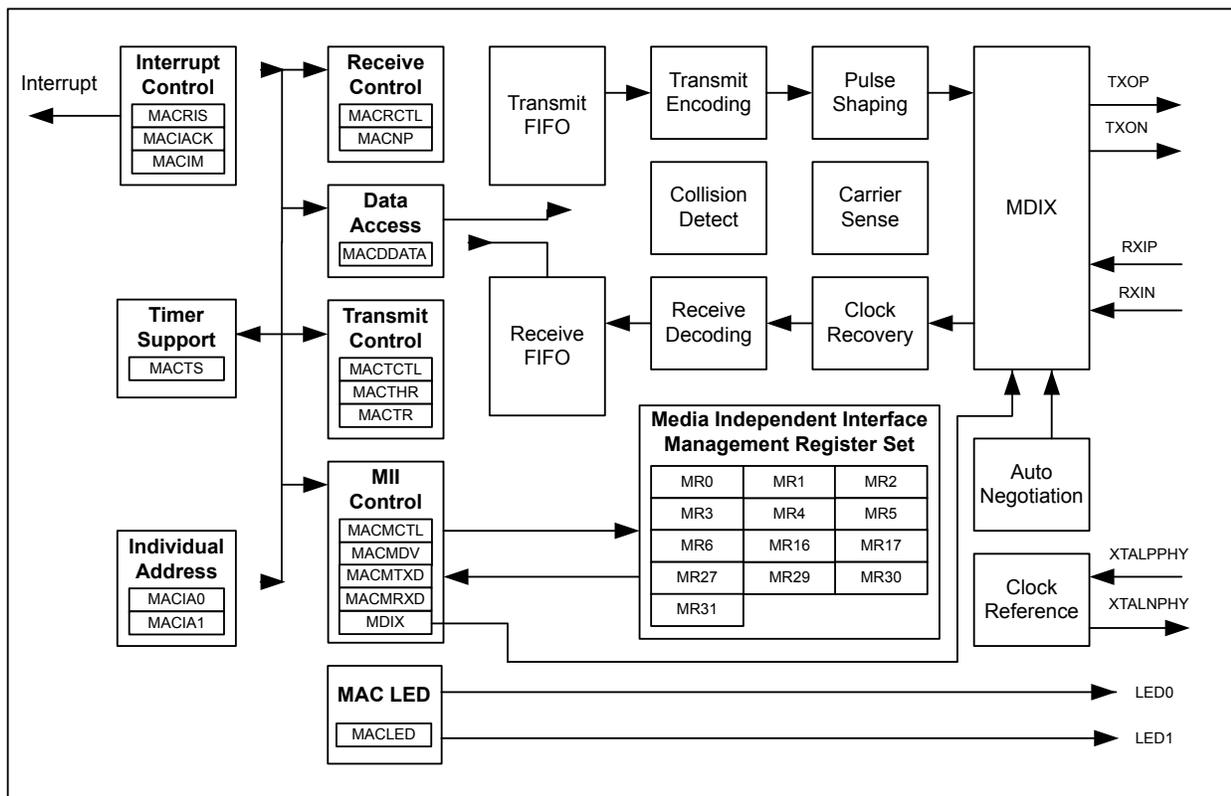


Figure 19-2 on page 815 shows more detail of the internal structure of the Ethernet Controller and how the register set relates to various functions.

Figure 19-2. Ethernet Controller Block Diagram



## 19.2 Signal Description

Table 19-1 on page 816 and Table 19-2 on page 816 list the external signals of the Ethernet Controller and describe the function of each. The Ethernet LED signals are alternate functions for GPIO signals and default to be GPIO signals at reset. The column in the table below titled "Pin Mux/Pin Assignment" lists the GPIO pin placement for the LED signals. The **AFSEL** bit in the **GPIO Alternate Function Select (GPIOAFSEL)** register (page 328) should be set to choose the LED function. The number in parentheses is the encoding that must be programmed into the **PMC<sub>n</sub>** field in the **GPIO Port Control (GPIOPTL)** register (page 346) to assign the **LED0** and **LED1** signals to the specified GPIO port pins. For more information on configuring GPIOs, see "General-Purpose Input/Outputs (GPIOs)" on page 304. The remaining signals (with the word "fixed" in the Pin Mux/Pin Assignment column) have a fixed pin assignment and function.

**Table 19-1. Signals for Ethernet (100LQFP)**

Pin Name	Pin Number	Pin Mux / Pin Assignment	Pin Type	Buffer Type <sup>a</sup>	Description
ERBIAS	33	fixed	O	Analog	12.4-kΩ resistor (1% precision) used internally for Ethernet PHY.
LED0	59	PF3 (1)	O	TTL	Ethernet LED 0.
LED1	60	PF2 (1)	O	TTL	Ethernet LED 1.
MDIO	58	fixed	I/O	OD	MDIO of the Ethernet PHY.
RXIN	37	fixed	I	Analog	RXIN of the Ethernet PHY.
RXIP	40	fixed	I	Analog	RXIP of the Ethernet PHY.
TXON	46	fixed	O	TTL	TXON of the Ethernet PHY.
TXOP	43	fixed	O	TTL	TXOP of the Ethernet PHY.
XTALNPHY	17	fixed	O	Analog	Ethernet PHY XTALN 25-MHz oscillator crystal output.
XTALPPHY	16	fixed	I	Analog	Ethernet PHY XTALP 25-MHz oscillator crystal input.

a. The TTL designation indicates the pin has TTL-compatible voltage levels.

**Table 19-2. Signals for Ethernet (108BGA)**

Pin Name	Pin Number	Pin Mux / Pin Assignment	Pin Type	Buffer Type <sup>a</sup>	Description
ERBIAS	J3	fixed	O	Analog	12.4-kΩ resistor (1% precision) used internally for Ethernet PHY.
LED0	J12	PF3 (1)	O	TTL	Ethernet LED 0.
LED1	J11	PF2 (1)	O	TTL	Ethernet LED 1.
MDIO	L9	fixed	I/O	OD	MDIO of the Ethernet PHY.
RXIN	L7	fixed	I	Analog	RXIN of the Ethernet PHY.
RXIP	M7	fixed	I	Analog	RXIP of the Ethernet PHY.
TXON	L8	fixed	O	TTL	TXON of the Ethernet PHY.
TXOP	M8	fixed	O	TTL	TXOP of the Ethernet PHY.
XTALNPHY	J1	fixed	O	Analog	Ethernet PHY XTALN 25-MHz oscillator crystal output.
XTALPPHY	J2	fixed	I	Analog	Ethernet PHY XTALP 25-MHz oscillator crystal input.

a. The TTL designation indicates the pin has TTL-compatible voltage levels.



## 19.3 Functional Description

**Note:** A 12.4-k $\Omega$  resistor should be connected between the `ERBIAS` and ground. The 12.4-k $\Omega$  resistor should have a 1% tolerance and should be located in close proximity to the `ERBIAS` pin. Power dissipation in the resistor is low, so a chip resistor of any geometry may be used.

The functional description of the Ethernet Controller is discussed in the following sections.

### 19.3.1 MAC Operation

The following sections describe the operation of the MAC layer, including an overview of the Ethernet frame format, the MAC layer FIFOs, Ethernet transmission and reception options, packet timestamps, and LED indicators.

#### 19.3.1.1 Ethernet Frame Format

Ethernet data is carried by Ethernet frames. The basic frame format is shown in Figure 19-3 on page 817.

**Figure 19-3. Ethernet Frame**

Preamble	SFD	Destination Address	Source Address	Length/ Type	Data	FCS
7 Bytes	1 Byte	6 Bytes	6 Bytes	2 Bytes	46 - 1500 Bytes	4 Bytes

The seven fields of the frame are transmitted from left to right. The bits within the frame are transmitted from least to most significant bit.

- **Preamble**  
The Preamble field is used to synchronize with the received frame's timing. The preamble is 7 octets long.
- **Start Frame Delimiter (SFD)**  
The SFD field follows the preamble pattern and indicates the start of the frame. Its value is 1010.1011b.
- **Destination Address (DA)**  
This field specifies destination addresses for which the frame is intended. The LSB (bit 16 of DA oct 1 in the frame, see Table 19-3 on page 819) of the DA determines whether the address is an individual (0), or group/multicast (1) address.
- **Source Address (SA)**  
The source address field identifies the station from which the frame was initiated.
- **Length/Type Field**  
The meaning of this field depends on its numeric value. This field can be interpreted as length or type code. The maximum length of the data field is 1500 octets. If the value of the Length/Type field is less than or equal to 1500 decimal, it indicates the number of MAC client data octets. If the value of this field is greater than or equal to 1536 decimal, then it encodes the type interpretation. The meaning of the Length/Type field when the value is between 1500 and 1536 decimal is unspecified by the IEEE 802.3 standard. However, the Ethernet Controller assumes

type interpretation if the value of the Length/Type field is greater than 1500 decimal. The definition of the Type field is specified in the IEEE 802.3 standard. The first of the two octets in this field is most significant.

- Data

The data field is a sequence of octets that is at least 46 in length, up to 1500 in length. Full data transparency is provided so any values can appear in this field. A minimum frame size of 46 octets is required to meet the IEEE standard. If the frame size is too small, the Ethernet Controller automatically appends extra bits (a pad), thus the pad can have a size of 0 to 46 octets. Data padding can be disabled by clearing the `PADEN` bit in the **Ethernet MAC Transmit Control (MACTCTL)** register.

For the Ethernet Controller, data sent/received can be larger than 1500 bytes without causing a Frame Too Long error. Instead, a FIFO overrun error is reported using the `FOV` bit in the **Ethernet MAC Raw Interrupt Status (MACRIS)** register when the frame received is too large to fit into the Ethernet Controller's 2K RAM.

- Frame Check Sequence (FCS)

The frame check sequence carries the cyclic redundancy check (CRC) value. The CRC is computed over the destination address, source address, length/type, and data (including pad) fields using the CRC-32 algorithm. The Ethernet Controller computes the FCS value one nibble at a time. For transmitted frames, this field is automatically inserted by the MAC layer, unless disabled by clearing the `CRC` bit in the **MACTCTL** register. For received frames, this field is automatically checked. If the FCS does not pass, the frame is not placed in the RX FIFO, unless the FCS check is disabled by clearing the `BADCRC` bit in the **MACRCTL** register.

### 19.3.1.2 MAC Layer FIFOs

The Ethernet Controller is capable of simultaneous transmission and reception. This feature is enabled by setting the `DUPLX` bit in the **MACTCTL** register.

For Ethernet frame transmission, a 2-KB transmit FIFO is provided that can be used to store a single frame. While the *IEEE 802.3 specification* limits the size of an Ethernet frame's payload section to 1500 Bytes, the Ethernet Controller places no such limit. The full buffer can be used for a payload of up to 2032 bytes (as the first 16 bytes in the FIFO are reserved for destination address, source address and length/type information).

For Ethernet frame reception, a 2-KB receive FIFO is provided that can be used to store multiple frames, up to a maximum of 31 frames. If a frame is received, and there is insufficient space in the RX FIFO, an overflow error is indicated using the `FOV` bit in the **MACRIS** register.

For details regarding the TX and RX FIFO layout, refer to Table 19-3 on page 819. Please note the following difference between TX and RX FIFO layout. For the TX FIFO, the Data Length field in the first FIFO word refers to the Ethernet frame data payload, as shown in the 5th to nth FIFO positions. For the RX FIFO, the Frame Length field is the total length of the received Ethernet frame, including the Length/Type bytes and the FCS bits.

If FCS generation is disabled by clearing the `CRC` bit in the **MACTCTL** register, the last word in the TX FIFO must contain the FCS bytes for the frame that has been written to the FIFO.

Also note that if the length of the data payload section is not a multiple of 4, the FCS field is not be aligned on a word boundary in the FIFO. However, for the RX FIFO, the beginning of the next frame is always on a word boundary.

Table 19-3. TX &amp; RX FIFO Organization

FIFO Word Read/Write Sequence	Word Bit Fields	TX FIFO (Write)	RX FIFO (Read)
1st	7:0	Data Length Least Significant Byte	Frame Length Least Significant Byte
	15:8	Data Length Most Significant Byte	Frame Length Most Significant Byte
	23:16	DA oct 1	
	31:24	DA oct 2	
2nd	7:0	DA oct 3	
	15:8	DA oct 4	
	23:16	DA oct 5	
	31:24	DA oct 6	
3rd	7:0	SA oct 1	
	15:8	SA oct 2	
	23:16	SA oct 3	
	31:24	SA oct 4	
4th	7:0	SA oct 5	
	15:8	SA oct 6	
	23:16	Len/Type Most Significant Byte	
	31:24	Len/Type Least Significant Byte	
5th to nth	7:0	data oct n	
	15:8	data oct n+1	
	23:16	data oct n+2	
	31:24	data oct n+3	
last	7:0	FCS 1 <sup>a</sup>	
	15:8	FCS 2 <sup>a</sup>	
	23:16	FCS 3 <sup>a</sup>	
	31:24	FCS 4 <sup>a</sup>	

a. If the CRC bit in the **MACTCTL** register is clear, the FCS bytes must be written with the correct CRC. If the CRC bit is set, the Ethernet Controller automatically writes the FCS bytes.

### 19.3.1.3 Ethernet Transmission Options

At the MAC layer, the transmitter can be configured for both full-duplex and half-duplex operation by using the **DUPLEX** bit in the **MACTCTL** register. Note that in 10BASE-T half-duplex mode, the transmitted data is looped back on the receive path.

The Ethernet Controller automatically generates and inserts the Frame Check Sequence (FCS) at the end of the transmit frame when the **CRC** bit in the **MACTCTL** register is set. However, for test purposes, this feature can be disabled in order to generate a frame with an invalid CRC by clearing the **CRC** bit.

The *IEEE 802.3 specification* requires that the Ethernet frame payload section be a minimum of 46 bytes. The Ethernet Controller automatically pads the data section if the payload data section loaded into the FIFO is less than the minimum 46 bytes when the **PADEN** bit in the **MACTCTL** register is set. This feature can be disabled by clearing the **PADEN** bit.

The transmitter must be enabled by setting the **TXEN** bit in the **MACTCTL** register.

#### 19.3.1.4 Ethernet Reception Options

The Ethernet Controller RX FIFO should be cleared during software initialization. The receiver should first be disabled by clearing the `RXEN` bit in the **Ethernet MAC Receive Control (MACRCTL)** register, then the FIFO can be cleared by setting the `RSTFIFO` bit in the **MACRCTL** register.

The receiver automatically rejects frames that contain bad CRC values in the FCS field. In this case, a Receive Error interrupt is generated and the receive data is lost. To accept all frames, clear the `BADCRC` bit in the **MACRCTL** register.

In normal operating mode, the receiver accepts only those frames that have a destination address that matches the address programmed into the **Ethernet MAC Individual Address 0 (MACIA0)** and **Ethernet MAC Individual Address 1 (MACIA1)** registers. However, the Ethernet receiver can also be configured for Promiscuous and Multicast modes by setting the `PRMS` and `AMUL` bits in the **MACRCTL** register.

#### 19.3.1.5 Packet Timestamps

Some applications require a very precise clock for time stamping samples or triggering events. The IEEE Precision Time Protocol (PTP), or IEEE-1588, provides a mechanism for synchronizing clocks across an Ethernet to sub-microsecond precision. The accuracy of the PTP clock depends greatly upon the accuracy of timestamps of the PTP Ethernet packets. In a software-only PTP solution, there can be jitter in the Ethernet packet timestamps, resulting in a less precise PTP clock on the target. In some Stellaris devices, General-Purpose Timer 3 (GPT3) can be used in conjunction with the **Ethernet MAC Timer Support (MACTS)** register to provide a more accurate timestamp for Ethernet packets.

This feature is enabled by setting the `TSEN` bit in the **MACTS** register. Note that when this feature is enabled, GPT3 must be dedicated to the Ethernet Controller. GPT3 must be configured to 16-bit edge capture mode, see page 451. Timer A of GPT3 stores the transmit time, and Timer B stores the receive time. One other General-Purpose Timer can be set up as a 16-bit free-running timer to synchronize the receiver and transmitter timers and provide a timestamp with which to compare the timestamps stored in GPT3. The `enet_ptpd` example in the StellarisWare<sup>®</sup> software package provides a sample PTP application that illustrates both software-only time stamping as well the use of the GPT3 and **MACTS** register for more accurate timestamps. This example supports version 1 of the IEEE-1588 protocol, but Stellaris<sup>®</sup> microcontrollers support both versions 1 and 2.

#### 19.3.1.6 LED Indicators

The Ethernet Controller supports two LED signals that can be used to indicate various states of operation. These signals are mapped to the `LED0` and `LED1` pins. By default, these pins are configured as GPIO signals (`PF3` and `PF2`). For the Ethernet Controller to drive these signals, they must be reconfigured to their hardware function. See “General-Purpose Input/Outputs (GPIOs)” on page 304 for additional details. The function of these pins is programmable using the **Ethernet MAC LED Encoding (MACLED)** register. Refer to page 852 for additional details on how to program these LED functions.

#### 19.3.2 Internal MII Operation

For the MII management interface to function properly, the `MDIO` signal must be connected through a 10 k $\Omega$  pull-up resistor to the +3.3 V supply. Failure to connect this pull-up resistor prevents management transactions on this internal MII to function. Note that it is possible for data transmission across the MII to still function since the PHY layer auto-negotiates the link parameters by default.

For the MII management interface to function properly, the internal clock must be divided down from the system clock to a frequency no greater than 2.5 MHz. The **Ethernet MAC Management Divider**

(**MACMDV**) register contains the divider used for scaling down the system clock. See page 846 for more details about the use of this register.

### 19.3.3 PHY Operation

The Physical Layer (PHY) in the Ethernet Controller includes integrated ENDECs, scrambler/descrambler, dual-speed clock recovery, and full-featured auto-negotiation functions. The transmitter includes an on-chip pulse shaper and a low-power line driver. The receiver has an adaptive equalizer and a baseline restoration circuit required for accurate clock and data recovery. The transceiver interfaces to Category-5 unshielded twisted pair (Cat-5 UTP) cabling for 100BASE-TX applications, and Category-3 unshielded twisted pair (Cat-3 UTP) for 10BASE-T applications. The Ethernet Controller is connected to the line media via dual 1:1 isolation transformers. No external filter is required.

#### 19.3.3.1 Clock Selection

The Ethernet Controller can be clocked from an on-chip crystal oscillator which can also be driven by an external oscillator. When using the on-chip crystal oscillator, a 25-MHz crystal should be connected between the `XTALPPHY` and `XTALNPY` pins. Alternatively, an external 25-MHz clock input can be connected to the `XTALPPHY` pin. In this mode of operation, a crystal is not required and the `XTALNPY` pin should be left unconnected. See “Ethernet Controller” on page 1223 for more information regarding the specifications of the Ethernet Controller.

#### 19.3.3.2 Auto-Negotiation

The Ethernet Controller supports the auto-negotiation functions of Clause 28 of the *IEEE 802.3* standard for 10/100 Mbps operation over copper wiring. This function is controlled via register settings. The auto-negotiation function is turned on by default, and the `ANEGEN` bit in the **Ethernet PHY Management Register 0 - Control (MR0)** is set after reset. Software can disable the auto-negotiation function by clearing the `ANEGEN` bit. The contents of the **Ethernet PHY Management Register - Auto-Negotiation Advertisement (MR4)** are reflected to the Ethernet Controller’s link partner during auto-negotiation via fast-link pulse coding.

Once auto-negotiation is complete, the `SPEED` bit in the **Ethernet PHY Management Register 31 – PHY Special Control/Status (MR31)** register reflects the actual speed. The `AUTODONE` bit in **MR31** is set to indicate that auto-negotiation is complete. Setting the `RANEG` bit in the **MR0** register also causes auto-negotiation to restart.

#### 19.3.3.3 Polarity Correction

The Ethernet Controller is capable of automatic polarity reversal for 10BASE-T and auto-negotiation functions. The `XPOL` bit in the **Ethernet PHY Management Register 27 –Special Control/Status (MR27)** register is set to indicate the polarity has automatically been reversed.

#### 19.3.3.4 MDI/MDI-X Configuration

The Ethernet Controller supports the MDI/MDI-X configuration as defined in *IEEE 802.3-2002 specification* through software assistance. The MDI/MDI-X configuration eliminates the need for cross-over cables when connecting to another device, such as a hub. Software can implement the MDI/MDI-X configuration using a function outlined by the pseudo code below. This code should be called periodically using one of the available timer resources on the Stellaris® microcontroller such as the System Tick Timer or one of the General Purpose timers. The following code refers to the `LINK` bit in the **Ethernet PHY Management Register 1 - Status (MR1)**, the `ENON` bit in the **Ethernet PHY Management Register 17 - Mode Control/Status (MR17)**, and the `EN` bit of the **Ethernet PHY MDIX (MDIX)** register.

```
//
// Entry Point for MDI/MDI-X configuration.
//

//
// Increment the Link Active and Energy Detect Timers using the elapsed time
// since the last call to this function.  If using a periodic timer, the
// elapsed time should be a constant (the programmed period of the timer).
//
Increment Link Active Timer
Increment Energy Detect Timer

//
if(No Ethernet Link Active)
{
    //
    // If energy has been detected on the link, reset the Energy Detect Timer.
    // If it is a "new" energy detect, reset the link detect timer also.
    //
    if(Ethernet Energy Detected)
    {
        Reset Energy Detect Timer

        if(New Energy Detect)
        {
            Reset Link Detect Timer
        }
    }

    //
    // If the Energy or Link Detect timer has expired, toggle the MDI/MDI-X
    // mode. Typically, the Energy Detect Timer would be ~62ms, while the
    // Link Detect Timer would be ~2s
    //
    if((Energy Detect Timer Expired) or
        (Link Detect Timer Expired))
    {
        Reset Energy Detect Timer

        if(Random Event)
        {
            Reset Link Detect Timer
            Toggle MDI/MDI-X Mode
        }
    }
}

//
// Here, if an Ethernet Link has been detected, simply reset the timers
// for the next time around.
//
else
```

```

{
  Reset Link Detect Timer
  Reset Energy Detect Timer
}

```

### 19.3.3.5 Power Management

The PHY has two power-saving modes:

- Power-Down
- Energy Detect Power-Down

Power-down mode is activated by setting the `PWRDN` bit in the **MR0** register. When the PHY is in power-down mode, it consumes minimum power. When the `PWRDN` bit is cleared, the PHY powers up and is automatically reset.

The energy detect power-down mode is activated by setting the `EDPD` bit in the **MR17** register. In this mode of operation, when no energy is present on the line, the PHY is powered down, except for the management interface, the SQUELCH circuit and the ENERGYON logic. The ENERGYON logic is used to detect the presence of valid energy from 100BASE-T, 10BASE-T, or auto-negotiation signals. While the PHY is powered down, nothing is transmitted. When link pulses or packets are received, the PHY powers-up. The PHY automatically resets itself into the state it had prior to power down and sets the `EONIS` bit in the **MR29** register. The first and possibly the second packet to activate the ENERGYON mode may be lost.

### 19.3.4 Interrupts

The Ethernet Controller can generate an interrupt for one or more of the following conditions:

- A frame has been received into an empty RX FIFO
- A frame transmission error has occurred
- A frame has been transmitted successfully
- A frame has been received with inadequate room in the RX FIFO (overflow)
- A frame has been received with one or more error conditions (for example, FCS failed)
- An MII management transaction between the MAC and PHY layers has completed
- One or more of the following PHY layer conditions occurs:
  - Auto-Negotiate Complete
  - Remote Fault
  - Link Partner Acknowledge
  - Parallel Detect Fault
  - Page Received

Refer to **Ethernet PHY Management Register 29 - Interrupt Source Flags (MR29)** (see page 870) for additional details regarding PHY interrupts.

### 19.3.5 DMA Operation

The Ethernet peripheral provides request signals to the  $\mu$ DMA controller and has a dedicated channel for transmit and one for receive. The request is a single type for both channels. Burst requests are not supported. The RX channel request is asserted when a packet is received while the TX channel request is asserted when the transmit FIFO becomes empty.

No special configuration is needed to enable the Ethernet peripheral for use with the  $\mu$ DMA controller.

Because the size of a received packet is not known until the header is examined, it is best to set up the initial  $\mu$ DMA transfer to copy the first 4 words including the packet length plus the Ethernet header from the RX FIFO when the RX request occurs. The  $\mu$ DMA causes an interrupt when this transfer is complete. Upon entering the interrupt handler, the packet length in the FIFO and the Ethernet header are in a buffer and can be examined. Once the packet length is known, then another  $\mu$ DMA transfer can be set up to transfer the remaining received packet payload from the FIFO into a buffer. This transfer should be initiated by software. Another interrupt occurs when this transfer is done.

Even though the TX channel generates a TX empty request, the recommended way to handle  $\mu$ DMA transfers for transmitting packets is to set up the transfer from the buffer containing the packet to the transmit FIFO, and then to initiate the transfer with a software request. An interrupt occurs when this transfer is complete. For both channels, the "auto-request" transfer mode should be used. See "Micro Direct Memory Access ( $\mu$ DMA)" on page 246 for more details about programming the  $\mu$ DMA controller.

## 19.4 Initialization and Configuration

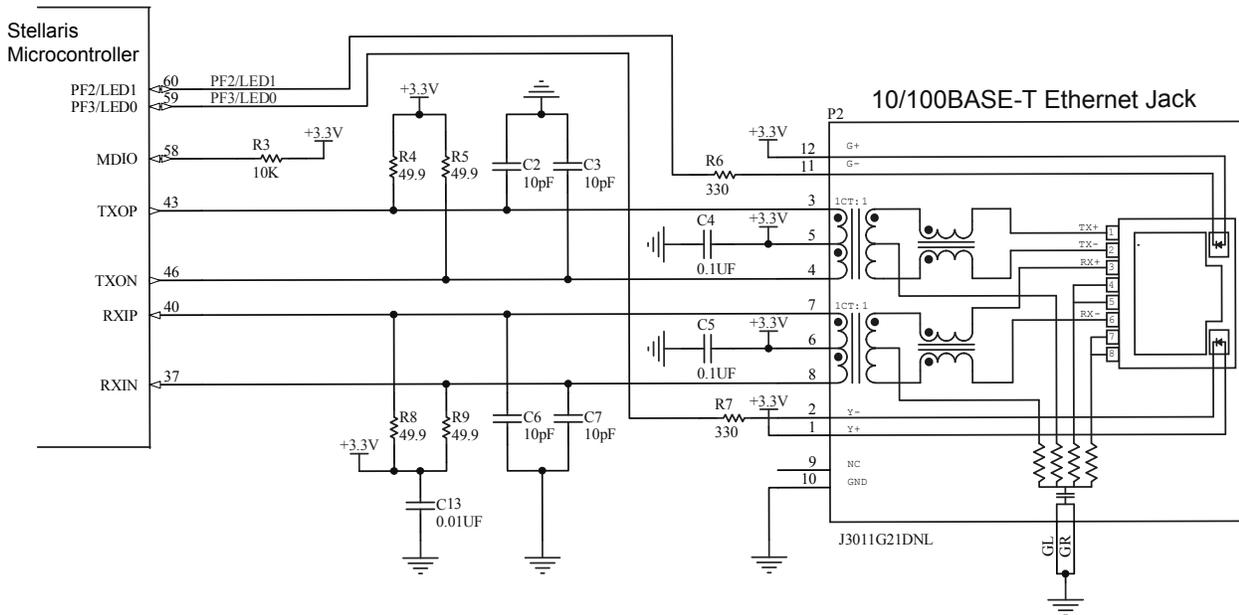
The following sections describe the hardware and software configuration required to set up the Ethernet Controller.

### 19.4.1 Hardware Configuration

Figure 19-4 on page 825 shows the proper method for interfacing the Ethernet Controller to a 10/100BASE-T Ethernet jack.



Figure 19-4. Interface to an Ethernet Jack



The following isolation transformers have been tested and are known to successfully interface to the Ethernet PHY layer.

- Isolation Transformers
  - TDK TLA-6T103
  - TDK TLA-6T118
  - Bel-Fuse S558-5999-46
  - Halo TG22-3506ND
  - Halo TG110-S050
  - PCA EPF8023G
  - Pulse PE-68515
  - Valor ST6118
  - YCL 20PMT04
- Isolation transformers with integrated RJ45 connector
  - TDK TLA-6T704
  - Delta RJS-1A08T089A
- Isolation transformers with integrated RJ45 connector, LEDs and termination resistors
  - Pulse J0011D21B/E
  - Pulse J3011G21DNL

### 19.4.2 Software Configuration

To use the Ethernet Controller, it must be enabled by setting the `EPHY0` and `EMAC0` bits in the `RCGC2` register (see page 193). In addition, the clock to the appropriate GPIO module must be enabled via the `RCGC2` register in the System Control module. See page 193. To find out which GPIO port to enable, refer to Table 25-4 on page 1151. Configure the `PMCn` fields in the `GPIOCTL` register to assign the Ethernet signals to the appropriate pins. See page 346 and Table 25-5 on page 1160.

The following steps can then be used to configure the Ethernet Controller for basic operation.

1. Program the **MACDIV** register to obtain a 2.5 MHz clock (or less) on the internal MII. Assuming a 20-MHz system clock, the **MACDIV** value should be 0x03 or greater.
2. Program the **MACIA0** and **MACIA1** register for address filtering.
3. Program the **MACTCTL** register for Auto CRC generation, padding, and full-duplex operation using a value of 0x16.
4. Program the **MACRCTL** register to flush the receive FIFO and reject frames with bad FCS using a value of 0x18.
5. Enable both the Transmitter and Receive by setting the LSB in both the **MACTCTL** and **MACRCTL** registers.
6. To transmit a frame, write the frame into the TX FIFO using the **Ethernet MAC Data (MACDATA)** register. Then set the **NEWTX** bit in the **Ethernet Mac Transmission Request (MACTR)** register to initiate the transmit process. When the **NEWTX** bit has been cleared, the TX FIFO is available for the next transmit frame.
7. To receive a frame, wait for the **NPR** field in the **Ethernet MAC Number of Packets (MACNP)** register to be non-zero. Then begin reading the frame from the RX FIFO by using the **MACDATA** register. To ensure that the entire packet is received, either use the DriverLib EthernetPacketGet() API or compare the number of bytes received to the Length field from the frame to determine when the packet has been completely read.

## 19.5 Register Map

Table 19-4 on page 826 lists the Ethernet MAC and MII Management registers. The MAC register addresses given are relative to the Ethernet base address of 0x4004.8000. The MII Management registers are accessed using the **MACMCTL** register. Note that the Ethernet controller clocks must be enabled before the registers can be programmed (see page 193).

The *IEEE 802.3* standard specifies a register set for controlling and gathering status from the PHY layer. The registers are collectively known as the MII Management registers and are detailed in Section 22.2.4 of the *IEEE 802.3 specification*. Table 19-4 on page 826 also lists these MII Management registers. *All addresses given are absolute and are written directly to the REGADR field of the Ethernet MAC Management Control (MACMCTL) register.* The format of registers 0 to 15 are defined by the IEEE specification and are common to all PHY layer implementations. The only variance allowed is for features that may or may not be supported by a specific PHY implementation. Registers 16 to 31 are vendor-specific registers, used to support features that are specific to a vendor's PHY implementation.

**Table 19-4. Ethernet Register Map**

Offset	Name	Type	Reset	Description	See page
<b>Ethernet MAC (Ethernet Offset)</b>					
0x000	MACRIS/MACIACK	R/W1C	0x0000.0000	Ethernet MAC Raw Interrupt Status/Acknowledge	829
0x004	MACIM	R/W	0x0000.007F	Ethernet MAC Interrupt Mask	832
0x008	MACRCTL	R/W	0x0000.0008	Ethernet MAC Receive Control	834
0x00C	MACTCTL	R/W	0x0000.0000	Ethernet MAC Transmit Control	836

Table 19-4. Ethernet Register Map (continued)

Offset	Name	Type	Reset	Description	See page
0x010	MACDATA	R/W	0x0000.0000	Ethernet MAC Data	838
0x014	MACIA0	R/W	0x0000.0000	Ethernet MAC Individual Address 0	840
0x018	MACIA1	R/W	0x0000.0000	Ethernet MAC Individual Address 1	841
0x01C	MACTHR	R/W	0x0000.003F	Ethernet MAC Threshold	842
0x020	MACMCTL	R/W	0x0000.0000	Ethernet MAC Management Control	844
0x024	MACMDV	R/W	0x0000.0080	Ethernet MAC Management Divider	846
0x02C	MACMTXD	R/W	0x0000.0000	Ethernet MAC Management Transmit Data	847
0x030	MACMRXD	R/W	0x0000.0000	Ethernet MAC Management Receive Data	848
0x034	MACNP	RO	0x0000.0000	Ethernet MAC Number of Packets	849
0x038	MACTR	R/W	0x0000.0000	Ethernet MAC Transmission Request	850
0x03C	MACTS	R/W	0x0000.0000	Ethernet MAC Timer Support	851
0x040	MACLED	R/W	0x0000.0100	Ethernet MAC LED Encoding	852
0x044	MDIX	R/W	0x0000.0000	Ethernet PHY MDIX	854
<b>MII Management (Accessed through the MACMCTL register)</b>					
-	MR0	R/W	0x1000	Ethernet PHY Management Register 0 – Control	855
-	MR1	RO	0x7809	Ethernet PHY Management Register 1 – Status	857
-	MR2	RO	0x0161	Ethernet PHY Management Register 2 – PHY Identifier 1	859
-	MR3	RO	0xB410	Ethernet PHY Management Register 3 – PHY Identifier 2	860
-	MR4	R/W	0x01E1	Ethernet PHY Management Register 4 – Auto-Negotiation Advertisement	861
-	MR5	RO	0x0001	Ethernet PHY Management Register 5 – Auto-Negotiation Link Partner Base Page Ability	863
-	MR6	RO	0x0000	Ethernet PHY Management Register 6 – Auto-Negotiation Expansion	865
-	MR16	RO	0x0040	Ethernet PHY Management Register 16 – Vendor-Specific	866
-	MR17	R/W	0x0002	Ethernet PHY Management Register 17 – Mode Control/Status	867
-	MR27	RO	-	Ethernet PHY Management Register 27 – Special Control/Status	869
-	MR29	RO	0x0000	Ethernet PHY Management Register 29 – Interrupt Status	870
-	MR30	R/W	0x0000	Ethernet PHY Management Register 30 – Interrupt Mask	872
-	MR31	R/W	0x00040	Ethernet PHY Management Register 31 – PHY Special Control/Status	874

## **19.6 Ethernet MAC Register Descriptions**

The remainder of this section lists and describes the Ethernet MAC registers, in numerical order by address offset. Also see “MII Management Register Descriptions” on page 854.

## Register 1: Ethernet MAC Raw Interrupt Status/Acknowledge (MACRIS/MACIACK), offset 0x000

The **MACRIS/MACIACK** register is the interrupt status and acknowledge register. On a read, this register gives the current status value of the corresponding interrupt prior to masking. On a write, setting any bit clears the corresponding interrupt status bit.

### Ethernet MAC Raw Interrupt Status/Acknowledge (MACRIS/MACIACK)

Base 0x4004.8000

Offset 0x000

Type R/W1C, reset 0x0000.0000

	31	30	29	28	27	26	25	24	23	22	21	20	19	18	17	16	
	reserved																
Type	RO	RO	RO	RO	RO	RO	RO	RO	RO	RO	RO	RO	RO	RO	RO	RO	
Reset	0	0	0	0	0	0	0	0	0	0	0	0	0	0	0	0	
	15	14	13	12	11	10	9	8	7	6	5	4	3	2	1	0	
	reserved										PHYINT	MDINT	RXER	FOV	TXEMP	TXER	RXINT
Type	RO	RO	RO	RO	RO	RO	RO	RO	RO	RO	RW1C	RW1C	RW1C	RW1C	RW1C	RW1C	
Reset	0	0	0	0	0	0	0	0	0	0	0	0	0	0	0	0	

Bit/Field	Name	Type	Reset	Description
31:7	reserved	RO	0x0000.00	Software should not rely on the value of a reserved bit. To provide compatibility with future products, the value of a reserved bit should be preserved across a read-modify-write operation.
6	PHYINT	RW1C	0	PHY Interrupt  Value Description 1 An enabled interrupt in the PHY layer has occurred. <b>MR29</b> in the PHY must be read to determine the specific PHY event that triggered this interrupt. 0 No interrupt.  This bit is cleared by writing a 1 to it.
5	MDINT	RW1C	0	MII Transaction Complete  Value Description 1 A transaction (read or write) on the MII interface has completed successfully. 0 No interrupt.  This bit is cleared by writing a 1 to it.

Bit/Field	Name	Type	Reset	Description
4	RXER	RW1C	0	<p>Receive Error</p> <p>Value Description</p> <p>1 An error was encountered on the receiver. The possible errors that can cause this interrupt bit to be set are:</p> <ul style="list-style-type: none"> <li>■ A receive error occurs during the reception of a frame (100 Mbps only).</li> <li>■ The frame is not an integer number of bytes (dribble bits) due to an alignment error.</li> <li>■ The CRC of the frame does not pass the FCS check.</li> <li>■ The length/type field is inconsistent with the frame data size when interpreted as a length field.</li> </ul> <p>0 No interrupt.</p> <p>This bit is cleared by writing a 1 to it.</p>
3	FOV	RW1C	0	<p>FIFO Overrun</p> <p>Value Description</p> <p>1 An overrun was encountered on the receive FIFO.</p> <p>0 No interrupt.</p> <p>This bit is cleared by writing a 1 to it.</p>
2	TXEMP	RW1C	0	<p>Transmit FIFO Empty</p> <p>Value Description</p> <p>1 The packet was transmitted and that the TX FIFO is empty.</p> <p>0 No interrupt.</p> <p>This bit is cleared by writing a 1 to it.</p>
1	TXER	RW1C	0	<p>Transmit Error</p> <p>Value Description</p> <p>1 An error was encountered on the transmitter. The possible errors that can cause this interrupt bit to be set are:</p> <ul style="list-style-type: none"> <li>■ The data length field stored in the TX FIFO exceeds 2032 decimal (buffer length - 16 bytes of header data). The frame is not sent when this error occurs.</li> <li>■ The retransmission attempts during the backoff process have exceeded the maximum limit of 16 decimal.</li> </ul> <p>0 No interrupt.</p> <p>Writing a 1 to this bit clears it and resets the TX FIFO write pointer.</p>

---

Bit/Field	Name	Type	Reset	Description
0	RXINT	RW1C	0	Packet Received
				Value Description
				1 At least one packet has been received and is stored in the receiver FIFO.
				0 No interrupt.
				This bit is cleared by writing a 1 to it.

## Register 2: Ethernet MAC Interrupt Mask (MACIM), offset 0x004

This register allows software to enable/disable Ethernet MAC interrupts. Clearing a bit disables the interrupt, while setting the bit enables it.

### Ethernet MAC Interrupt Mask (MACIM)

Base 0x4004.8000  
Offset 0x004  
Type R/W, reset 0x0000.007F

	31	30	29	28	27	26	25	24	23	22	21	20	19	18	17	16	
	reserved																
Type	RO	RO	RO	RO	RO	RO	RO	RO	RO	RO	RO	RO	RO	RO	RO	RO	
Reset	0	0	0	0	0	0	0	0	0	0	0	0	0	0	0	0	
	15	14	13	12	11	10	9	8	7	6	5	4	3	2	1	0	
	reserved										PHYINTM	MDINTM	RXERM	FOVM	TXEMPM	TXERM	RXINTM
Type	RO	RO	RO	RO	RO	RO	RO	RO	RO	RO	R/W	R/W	R/W	R/W	R/W	R/W	
Reset	0	0	0	0	0	0	0	0	0	0	1	1	1	1	1	1	

Bit/Field	Name	Type	Reset	Description
31:7	reserved	RO	0x0000.00	Software should not rely on the value of a reserved bit. To provide compatibility with future products, the value of a reserved bit should be preserved across a read-modify-write operation.
6	PHYINTM	R/W	1	Mask PHY Interrupt  Value Description 1 An interrupt is sent to the interrupt controller when the PHYINT bit in the <b>MACRIS/MACIACK</b> register is set. 0 The PHYINT interrupt is suppressed and not sent to the interrupt controller.
5	MDINTM	R/W	1	Mask MII Transaction Complete  Value Description 1 An interrupt is sent to the interrupt controller when the MDINT bit in the <b>MACRIS/MACIACK</b> register is set. 0 The MDINT interrupt is suppressed and not sent to the interrupt controller.
4	RXERM	R/W	1	Mask Receive Error  Value Description 1 An interrupt is sent to the interrupt controller when the RXER bit in the <b>MACRIS/MACIACK</b> register is set. 0 The RXER interrupt is suppressed and not sent to the interrupt controller.



Bit/Field	Name	Type	Reset	Description
3	FOVM	R/W	1	Mask FIFO Overrun  Value Description 1 An interrupt is sent to the interrupt controller when the FOV bit in the <b>MACRIS/MACIACK</b> register is set. 0 The FOV interrupt is suppressed and not sent to the interrupt controller.
2	TXEMPM	R/W	1	Mask Transmit FIFO Empty  Value Description 1 An interrupt is sent to the interrupt controller when the TXEMP bit in the <b>MACRIS/MACIACK</b> register is set. 0 The TXEMP interrupt is suppressed and not sent to the interrupt controller.
1	TXERM	R/W	1	Mask Transmit Error  Value Description 1 An interrupt is sent to the interrupt controller when the TXER bit in the <b>MACRIS/MACIACK</b> register is set. 0 The TXER interrupt is suppressed and not sent to the interrupt controller.
0	RXINTM	R/W	1	Mask Packet Received  Value Description 1 An interrupt is sent to the interrupt controller when the RXINT bit in the <b>MACRIS/MACIACK</b> register is set. 0 The RXINT interrupt is suppressed and not sent to the interrupt controller.

### Register 3: Ethernet MAC Receive Control (MACRCTL), offset 0x008

This register configures the receiver and controls the types of frames that are received.

It is important to note that when the receiver is enabled, all valid frames with a broadcast address of FF-FF-FF-FF-FF-FF in the Destination Address field are received and stored in the RX FIFO, even if the `AMUL` bit is not set.

#### Ethernet MAC Receive Control (MACRCTL)

Base 0x4004.8000  
Offset 0x008  
Type R/W, reset 0x0000.0008

	31	30	29	28	27	26	25	24	23	22	21	20	19	18	17	16	
	reserved																
Type	RO	RO	RO	RO	RO	RO	RO	RO	RO	RO	RO	RO	RO	RO	RO	RO	
Reset	0	0	0	0	0	0	0	0	0	0	0	0	0	0	0	0	
	15	14	13	12	11	10	9	8	7	6	5	4	3	2	1	0	
	reserved												RSTFIFO	BADCRC	PRMS	AMUL	RXEN
Type	RO	RO	RO	RO	RO	RO	RO	RO	RO	RO	RO	RO	R/W	R/W	R/W	R/W	R/W
Reset	0	0	0	0	0	0	0	0	0	0	0	0	0	1	0	0	0

Bit/Field	Name	Type	Reset	Description
31:5	reserved	RO	0x0000.000	Software should not rely on the value of a reserved bit. To provide compatibility with future products, the value of a reserved bit should be preserved across a read-modify-write operation.
4	RSTFIFO	R/W	0	<p>Clear Receive FIFO</p> <p>Value Description</p> <p>1 Clear the receive FIFO. The receive FIFO should be cleared when software initialization is performed.</p> <p>0 No effect.</p> <p>This bit is automatically cleared when read.</p> <p>The receiver should be disabled (<code>RXEN = 0</code>), before a reset is initiated (<code>RSTFIFO = 1</code>). This sequence flushes and resets the RX FIFO.</p>
3	BADCRC	R/W	1	<p>Enable Reject Bad CRC</p> <p>Value Description</p> <p>1 Enables the rejection of frames with an incorrectly calculated CRC. If a bad CRC is encountered, the <code>RXER</code> bit in the <b>MACRIS</b> register is set and the receiver FIFO is reset.</p> <p>0 Disables the rejection of frames with an incorrectly calculated CRC.</p>
2	PRMS	R/W	0	<p>Enable Promiscuous Mode</p> <p>Value Description</p> <p>1 Enables Promiscuous mode, which accepts all valid frames, regardless of the specified Destination Address.</p> <p>0 Disables Promiscuous mode, accepting only frames with the programmed Destination Address.</p>

---

Bit/Field	Name	Type	Reset	Description
1	AMUL	R/W	0	Enable Multicast Frames  Value Description 1 Enables the reception of multicast frames. 0 Disables the reception of multicast frames.
0	RXEN	R/W	0	Enable Receiver  Value Description 1 Enables the Ethernet receiver. 0 Disables the receiver. All frames are ignored.

## Register 4: Ethernet MAC Transmit Control (MACTCTL), offset 0x00C

This register configures the transmitter and controls the frames that are transmitted.

### Ethernet MAC Transmit Control (MACTCTL)

Base 0x4004.8000  
Offset 0x00C  
Type R/W, reset 0x0000.0000

	31	30	29	28	27	26	25	24	23	22	21	20	19	18	17	16	
	reserved																
Type	RO	RO	RO	RO	RO	RO	RO	RO	RO	RO	RO	RO	RO	RO	RO	RO	
Reset	0	0	0	0	0	0	0	0	0	0	0	0	0	0	0	0	
	15	14	13	12	11	10	9	8	7	6	5	4	3	2	1	0	
	reserved												DUPLEX	reserved	CRC	PADEN	TXEN
Type	RO	RO	RO	RO	RO	RO	RO	RO	RO	RO	RO	R/W	RO	R/W	R/W	R/W	
Reset	0	0	0	0	0	0	0	0	0	0	0	0	0	0	0	0	

Bit/Field	Name	Type	Reset	Description
31:5	reserved	RO	0x0000.000	Software should not rely on the value of a reserved bit. To provide compatibility with future products, the value of a reserved bit should be preserved across a read-modify-write operation.
4	DUPLEX	R/W	0	Enable Duplex Mode  Value Description 1 Enables Duplex mode, allowing simultaneous transmission and reception. 0 Disables Duplex mode.
3	reserved	RO	0	Software should not rely on the value of a reserved bit. To provide compatibility with future products, the value of a reserved bit should be preserved across a read-modify-write operation.
2	CRC	R/W	0	Enable CRC Generation  Value Description 1 Enables the automatic generation of the CRC and its placement at the end of the packet. 0 The frames placed in the TX FIFO are sent exactly as they are written into the FIFO.  Note that this bit should generally be set.
1	PADEN	R/W	0	Enable Packet Padding  Value Description 1 Enables the automatic padding of packets that do not meet the minimum frame size. 0 Disables automatic padding.  Note that this bit should generally be set.

---

Bit/Field	Name	Type	Reset	Description
0	TXEN	R/W	0	Enable Transmitter
				Value Description
				1 Enables the transmitter.
				0 Disables the transmitter.

## Register 5: Ethernet MAC Data (MACDATA), offset 0x010

**Important:** Use caution when reading this register. Performing a read may change bit status.

This register enables software to access the TX and RX FIFOs.

Reads from this register return the data stored in the RX FIFO from the location indicated by the read pointer. The read pointer is then auto incremented to the next RX FIFO location. Reading from the RX FIFO when a frame has not been received or is in the process of being received returns indeterminate data and does not increment the read pointer.

Writes to this register store the data in the TX FIFO at the location indicated by the write pointer. The write pointer is then auto incremented to the next TX FIFO location. Writing more data into the TX FIFO than indicated in the length field results in the data being lost. Writing less data into the TX FIFO than indicated in the length field results in indeterminate data being appended to the end of the frame to achieve the indicated length. Attempting to write the next frame into the TX FIFO before transmission of the first has completed results in the data being lost.

Bytes may not be randomly accessed in either the RX or TX FIFOs. Data must be read from the RX FIFO sequentially and stored in a buffer for further processing. Once a read has been performed, the data in the FIFO cannot be re-read. Data must be written to the TX FIFO sequentially. If an error is made in placing the frame into the TX FIFO, the write pointer can be reset to the start of the TX FIFO by writing the `TXER` bit of the **MACIACK** register and then the data re-written.

### Reads

#### Ethernet MAC Data (MACDATA)

Base 0x4004.8000  
Offset 0x010  
Type RO, reset 0x0000.0000

	31	30	29	28	27	26	25	24	23	22	21	20	19	18	17	16
	RXDATA															
Type	RO	RO	RO	RO	RO	RO	RO	RO	RO	RO	RO	RO	RO	RO	RO	RO
Reset	0	0	0	0	0	0	0	0	0	0	0	0	0	0	0	0
	15	14	13	12	11	10	9	8	7	6	5	4	3	2	1	0
	RXDATA															
Type	RO	RO	RO	RO	RO	RO	RO	RO	RO	RO	RO	RO	RO	RO	RO	RO
Reset	0	0	0	0	0	0	0	0	0	0	0	0	0	0	0	0

Bit/Field	Name	Type	Reset	Description
31:0	RXDATA	RO	0x0000.0000	Receive FIFO Data

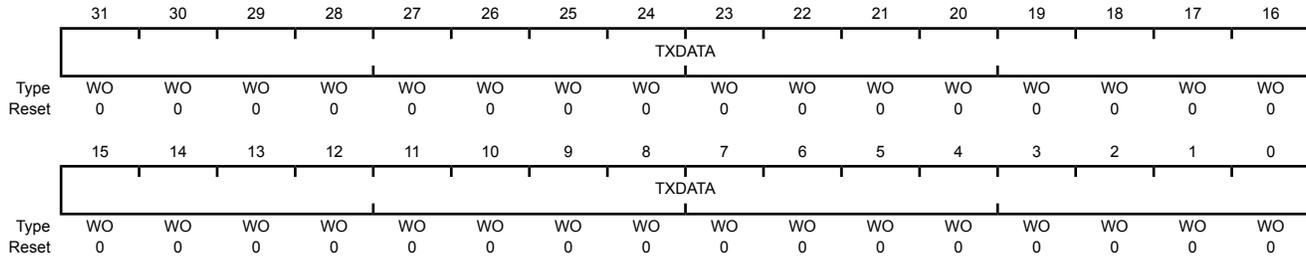
The `RXDATA` bits represent the next word of data stored in the RX FIFO.

**Writes****Ethernet MAC Data (MACDATA)**

Base 0x4004.8000

Offset 0x010

Type WO, reset 0x0000.0000



Bit/Field	Name	Type	Reset	Description
31:0	TXDATA	WO	0x0000.0000	Transmit FIFO Data

The TXDATA bits represent the next word of data to place in the TX FIFO for transmission.

## Register 6: Ethernet MAC Individual Address 0 (MACIA0), offset 0x014

This register enables software to program the first four bytes of the hardware MAC address of the Network Interface Card (NIC). The last two bytes are in **MACIA1**. The 6-byte Individual Address is compared against the incoming Destination Address fields to determine whether the frame should be received.

### Ethernet MAC Individual Address 0 (MACIA0)

Base 0x4004.8000  
Offset 0x014  
Type R/W, reset 0x0000.0000

	31	30	29	28	27	26	25	24	23	22	21	20	19	18	17	16
	MACOCT4								MACOCT3							
Type	R/W	R/W	R/W	R/W	R/W	R/W	R/W	R/W	R/W	R/W	R/W	R/W	R/W	R/W	R/W	R/W
Reset	0	0	0	0	0	0	0	0	0	0	0	0	0	0	0	0
	15	14	13	12	11	10	9	8	7	6	5	4	3	2	1	0
	MACOCT2								MACOCT1							
Type	R/W	R/W	R/W	R/W	R/W	R/W	R/W	R/W	R/W	R/W	R/W	R/W	R/W	R/W	R/W	R/W
Reset	0	0	0	0	0	0	0	0	0	0	0	0	0	0	0	0

Bit/Field	Name	Type	Reset	Description
31:24	MACOCT4	R/W	0x00	MAC Address Octet 4  The <b>MACOCT4</b> bits represent the fourth octet of the MAC address used to uniquely identify the Ethernet Controller.
23:16	MACOCT3	R/W	0x00	MAC Address Octet 3  The <b>MACOCT3</b> bits represent the third octet of the MAC address used to uniquely identify the Ethernet Controller.
15:8	MACOCT2	R/W	0x00	MAC Address Octet 2  The <b>MACOCT2</b> bits represent the second octet of the MAC address used to uniquely identify the Ethernet Controller.
7:0	MACOCT1	R/W	0x00	MAC Address Octet 1  The <b>MACOCT1</b> bits represent the first octet of the MAC address used to uniquely identify the Ethernet Controller.



## Register 7: Ethernet MAC Individual Address 1 (MACIA1), offset 0x018

This register enables software to program the last two bytes of the hardware MAC address of the Network Interface Card (NIC). The first four bytes are in **MACIA0**. The 6-byte IAR is compared against the incoming Destination Address fields to determine whether the frame should be received.

### Ethernet MAC Individual Address 1 (MACIA1)

Base 0x4004.8000  
Offset 0x018  
Type R/W, reset 0x0000.0000

	31	30	29	28	27	26	25	24	23	22	21	20	19	18	17	16
	reserved															
Type	RO	RO	RO	RO	RO	RO	RO	RO	RO	RO	RO	RO	RO	RO	RO	RO
Reset	0	0	0	0	0	0	0	0	0	0	0	0	0	0	0	0
	15	14	13	12	11	10	9	8	7	6	5	4	3	2	1	0
	MACOCT6								MACOCT5							
Type	R/W	R/W	R/W	R/W	R/W	R/W	R/W	R/W	R/W	R/W	R/W	R/W	R/W	R/W	R/W	R/W
Reset	0	0	0	0	0	0	0	0	0	0	0	0	0	0	0	0

Bit/Field	Name	Type	Reset	Description
31:16	reserved	RO	0x0000	Software should not rely on the value of a reserved bit. To provide compatibility with future products, the value of a reserved bit should be preserved across a read-modify-write operation.
15:8	MACOCT6	R/W	0x00	MAC Address Octet 6  The <b>MACOCT6</b> bits represent the sixth octet of the MAC address used to uniquely identify each Ethernet Controller.
7:0	MACOCT5	R/W	0x00	MAC Address Octet 5  The <b>MACOCT5</b> bits represent the fifth octet of the MAC address used to uniquely identify the Ethernet Controller.

## Register 8: Ethernet MAC Threshold (MACTHR), offset 0x01C

In order to increase the transmission rate, it is possible to program the Ethernet Controller to begin transmission of the next frame prior to the completion of the transmission of the current frame.

**Caution – Extreme care must be used when implementing this function. Software must be able to guarantee that the complete frame is able to be stored in the transmission FIFO prior to the completion of the transmission frame.**

This register enables software to set the threshold level at which the transmission of the frame begins. If the THRESH bits are set to 0x3F, which is the reset value, the early transmission feature is disabled, and transmission does not start until the NEWTX bit is set in the MACTR register.

Writing the THRESH field to any value besides 0x3F enables the early transmission feature. Once the byte count of data in the TX FIFO reaches the value derived from the THRESH bits as shown below, transmission of the frame begins. When the THRESH field is clear, transmission of the frame begins after 4 bytes (a single write) are stored in the TX FIFO. Each increment of the THRESH bit field waits for an additional 32 bytes of data (eight writes) to be stored in the TX FIFO. Therefore, a value of 0x01 causes the transmitter to wait for 36 bytes of data to be written while a value of 0x02 makes the wait equal to 68 bytes of written data. In general, early transmission starts when:

$$\text{Number of Bytes} \geq 4 ((\text{THRESH} \times 8) + 1)$$

Reaching the threshold level has the same effect as setting the NEWTX bit in the MACTR register. Transmission of the frame begins, and then the number of bytes indicated by the Data Length field is transmitted. Because underrun checking is not performed, if any event, such as an interrupt, delays the filling of the FIFO, the tail pointer may reach and pass the write pointer in the TX FIFO. In this event, indeterminate values are transmitted rather than the end of the frame. Therefore, sufficient bus bandwidth for writing to the TX FIFO must be guaranteed by the software.

If a frame smaller than the threshold level must be sent, the NEWTX bit in the MACTR register must be set with an explicit write, which initiates the transmission of the frame even though the threshold limit has not been reached.

If the threshold level is set too small, it is possible for the transmitter to underrun. If this occurs, the transmit frame is aborted, and a transmit error occurs. Note that in this case, the TXER bit in the MACRIS is not set, meaning that the CPU receives no indication that a transmit error happened.

### Ethernet MAC Threshold (MACTHR)

Base 0x4004.8000  
Offset 0x01C  
Type R/W, reset 0x0000.003F

	31	30	29	28	27	26	25	24	23	22	21	20	19	18	17	16
	reserved															
Type	RO	RO	RO	RO	RO	RO	RO	RO	RO	RO	RO	RO	RO	RO	RO	RO
Reset	0	0	0	0	0	0	0	0	0	0	0	0	0	0	0	0
	15	14	13	12	11	10	9	8	7	6	5	4	3	2	1	0
	reserved										THRESH					
Type	RO	RO	RO	RO	RO	RO	RO	RO	RO	RO	R/W	R/W	R/W	R/W	R/W	R/W
Reset	0	0	0	0	0	0	0	0	0	0	1	1	1	1	1	1

Bit/Field	Name	Type	Reset	Description
31:6	reserved	RO	0x0000.00	Software should not rely on the value of a reserved bit. To provide compatibility with future products, the value of a reserved bit should be preserved across a read-modify-write operation.

---

Bit/Field	Name	Type	Reset	Description
5:0	THRESH	R/W	0x3F	Threshold Value  The THRESH bits represent the early transmit threshold. Once the amount of data in the TX FIFO exceeds the value represented by the above equation, transmission of the packet begins.

**Register 9: Ethernet MAC Management Control (MACMCTL), offset 0x020**

This register enables software to control the transfer of data to and from the MII Management registers in the Ethernet PHY layer. The address, name, type, reset configuration, and functional description of each of these registers can be found in Table 19-4 on page 826 and in “MII Management Register Descriptions” on page 854.

In order to initiate a *read* transaction from the MII Management registers, the `WRITE` bit must be cleared during the same cycle that the `START` bit is set.

In order to initiate a *write* transaction to the MII Management registers, the `WRITE` bit must be set during the same cycle that the `START` bit is set.

## Ethernet MAC Management Control (MACMCTL)

Base 0x4004.8000  
Offset 0x020  
Type R/W, reset 0x0000.0000

	31	30	29	28	27	26	25	24	23	22	21	20	19	18	17	16
	reserved															
Type	RO	RO	RO	RO	RO	RO	RO	RO	RO	RO	RO	RO	RO	RO	RO	RO
Reset	0	0	0	0	0	0	0	0	0	0	0	0	0	0	0	0
	15	14	13	12	11	10	9	8	7	6	5	4	3	2	1	0
	reserved								REGADR				reserved	WRITE	START	
Type	RO	RO	RO	RO	RO	RO	RO	RO	R/W	R/W	R/W	R/W	R/W	RO	R/W	R/W
Reset	0	0	0	0	0	0	0	0	0	0	0	0	0	0	0	0

Bit/Field	Name	Type	Reset	Description
31:8	reserved	RO	0x0000.00	Software should not rely on the value of a reserved bit. To provide compatibility with future products, the value of a reserved bit should be preserved across a read-modify-write operation.
7:3	REGADR	R/W	0x0	MII Register Address  The <code>REGADR</code> bit field represents the MII Management register address for the next MII management interface transaction. Refer to Table 19-4 on page 826 for the PHY register offsets.  Note that any address that is not valid in the register map should not be written to, and any data read should be ignored.
2	reserved	RO	0	Software should not rely on the value of a reserved bit. To provide compatibility with future products, the value of a reserved bit should be preserved across a read-modify-write operation.
1	WRITE	R/W	0	MII Register Transaction Type  Value Description 1 The next operation of the next MII management interface is a write transaction. 0 The next operation of the next MII management interface is a read transaction.

---

Bit/Field	Name	Type	Reset	Description
0	START	R/W	0	MII Register Transaction Enable
				Value Description
			1	The MII register located at REGADR is read (WRITE=0) or written (WRITE=1).
			0	No effect.

**Register 10: Ethernet MAC Management Divider (MACMDV), offset 0x024**

This register enables software to set the clock divider for the Management Data Clock (MDC). This clock is used to synchronize read and write transactions between the system and the MII Management registers. The frequency of the MDC clock can be calculated from the following formula:

$$F_{mdc} = \frac{F_{ipclk}}{2 \times (\text{MACMDV} + 1)}$$

The clock divider must be written with a value that ensures that the MDC clock does not exceed a frequency of 2.5 MHz.

**Ethernet MAC Management Divider (MACMDV)**

Base 0x4004.8000  
Offset 0x024  
Type R/W, reset 0x0000.0080

	31	30	29	28	27	26	25	24	23	22	21	20	19	18	17	16
	reserved															
Type	RO	RO	RO	RO	RO	RO	RO	RO	RO	RO	RO	RO	RO	RO	RO	RO
Reset	0	0	0	0	0	0	0	0	0	0	0	0	0	0	0	0
	15	14	13	12	11	10	9	8	7	6	5	4	3	2	1	0
	reserved								DIV							
Type	RO	RO	RO	RO	RO	RO	RO	RO	R/W	R/W	R/W	R/W	R/W	R/W	R/W	R/W
Reset	0	0	0	0	0	0	0	0	1	0	0	0	0	0	0	0

Bit/Field	Name	Type	Reset	Description
31:8	reserved	RO	0x0000.00	Software should not rely on the value of a reserved bit. To provide compatibility with future products, the value of a reserved bit should be preserved across a read-modify-write operation.
7:0	DIV	R/W	0x80	Clock Divider  The <code>DIV</code> bits are used to set the clock divider for the MDC clock used to transmit data between the MAC and PHY layers.

## Register 11: Ethernet MAC Management Transmit Data (MACMTXD), offset 0x02C

This register holds the next value to be written to the MII Management registers.

### Ethernet MAC Management Transmit Data (MACMTXD)

Base 0x4004.8000

Offset 0x02C

Type R/W, reset 0x0000.0000

	31	30	29	28	27	26	25	24	23	22	21	20	19	18	17	16
	reserved															
Type	RO	RO	RO	RO	RO	RO	RO	RO	RO	RO	RO	RO	RO	RO	RO	RO
Reset	0	0	0	0	0	0	0	0	0	0	0	0	0	0	0	0
	15	14	13	12	11	10	9	8	7	6	5	4	3	2	1	0
	MDTX															
Type	R/W	R/W	R/W	R/W	R/W	R/W	R/W	R/W	R/W	R/W	R/W	R/W	R/W	R/W	R/W	R/W
Reset	0	0	0	0	0	0	0	0	0	0	0	0	0	0	0	0

Bit/Field	Name	Type	Reset	Description
31:16	reserved	RO	0x0000	Software should not rely on the value of a reserved bit. To provide compatibility with future products, the value of a reserved bit should be preserved across a read-modify-write operation.
15:0	MDTX	R/W	0x0000	MII Register Transmit Data The MDTX bits represent the data to be written in the next MII management transaction.

## Register 12: Ethernet MAC Management Receive Data (MACMRXD), offset 0x030

This register holds the last value read from the MII Management registers.

### Ethernet MAC Management Receive Data (MACMRXD)

Base 0x4004.8000

Offset 0x030

Type R/W, reset 0x0000.0000

	31	30	29	28	27	26	25	24	23	22	21	20	19	18	17	16
	reserved															
Type	RO	RO	RO	RO	RO	RO	RO	RO	RO	RO	RO	RO	RO	RO	RO	RO
Reset	0	0	0	0	0	0	0	0	0	0	0	0	0	0	0	0
	15	14	13	12	11	10	9	8	7	6	5	4	3	2	1	0
	MDRX															
Type	R/W	R/W	R/W	R/W	R/W	R/W	R/W	R/W	R/W	R/W	R/W	R/W	R/W	R/W	R/W	R/W
Reset	0	0	0	0	0	0	0	0	0	0	0	0	0	0	0	0

Bit/Field	Name	Type	Reset	Description
31:16	reserved	RO	0x0000	Software should not rely on the value of a reserved bit. To provide compatibility with future products, the value of a reserved bit should be preserved across a read-modify-write operation.
15:0	MDRX	R/W	0x0000	MII Register Receive Data The MDRX bits represent the data that was read in the previous MII management transaction.



**Register 13: Ethernet MAC Number of Packets (MACNP), offset 0x034**

This register holds the number of frames that are currently in the RX FIFO. When `NPR` is 0, there are no frames in the RX FIFO, and the `RXINT` bit is clear. When `NPR` is any other value, at least one frame is in the RX FIFO, and the `RXINT` bit in the **MACRIS** register is set.

**Note:** The FCS bytes are not included in the `NPR` value. As a result, the `NPR` value could be zero before the FCS bytes are read from the FIFO. In addition, a new packet could be received before the `NPR` value reaches zero. To ensure that the entire packet is received, either use the DriverLib `EthernetPacketGet()` API or compare the number of bytes received to the Length field from the frame to determine when the packet has been completely read.

## Ethernet MAC Number of Packets (MACNP)

Base 0x4004.8000

Offset 0x034

Type RO, reset 0x0000.0000

	31	30	29	28	27	26	25	24	23	22	21	20	19	18	17	16
	reserved															
Type	RO	RO	RO	RO	RO	RO	RO	RO	RO	RO	RO	RO	RO	RO	RO	RO
Reset	0	0	0	0	0	0	0	0	0	0	0	0	0	0	0	0
	15	14	13	12	11	10	9	8	7	6	5	4	3	2	1	0
	reserved											NPR				
Type	RO	RO	RO	RO	RO	RO	RO	RO	RO	RO	RO	RO	RO	RO	RO	RO
Reset	0	0	0	0	0	0	0	0	0	0	0	0	0	0	0	0

Bit/Field	Name	Type	Reset	Description
31:6	reserved	RO	0x0000.00	Software should not rely on the value of a reserved bit. To provide compatibility with future products, the value of a reserved bit should be preserved across a read-modify-write operation.
5:0	NPR	RO	0x00	Number of Packets in Receive FIFO  The <code>NPR</code> bits represent the number of packets stored in the RX FIFO. While the <code>NPR</code> field is greater than 0, the <code>RXINT</code> interrupt in the <b>MACRIS</b> register is set.

### Register 14: Ethernet MAC Transmission Request (MACTR), offset 0x038

This register enables software to initiate the transmission of the frame currently located in the TX FIFO. Once the frame has been transmitted from the TX FIFO or a transmission error has been encountered, the NEWTX bit is automatically cleared.

#### Ethernet MAC Transmission Request (MACTR)

Base 0x4004.8000  
 Offset 0x038  
 Type R/W, reset 0x0000.0000

	31	30	29	28	27	26	25	24	23	22	21	20	19	18	17	16
	reserved															
Type	RO	RO	RO	RO	RO	RO	RO	RO	RO	RO	RO	RO	RO	RO	RO	RO
Reset	0	0	0	0	0	0	0	0	0	0	0	0	0	0	0	0
	15	14	13	12	11	10	9	8	7	6	5	4	3	2	1	0
	reserved															NEWTX
Type	RO	RO	RO	RO	RO	RO	RO	RO	RO	RO	RO	RO	RO	RO	RO	R/W
Reset	0	0	0	0	0	0	0	0	0	0	0	0	0	0	0	0

Bit/Field	Name	Type	Reset	Description
31:1	reserved	RO	0x0000.000	Software should not rely on the value of a reserved bit. To provide compatibility with future products, the value of a reserved bit should be preserved across a read-modify-write operation.
0	NEWTX	R/W	0	New Transmission
				Value Description
				1 Initiates an Ethernet transmission once the packet has been placed in the TX FIFO.
				0 The transmission has completed.
				If early transmission is being used (see the <b>MACTHR</b> register), this bit does not need to be set.

## Register 15: Ethernet MAC Timer Support (MACTS), offset 0x03C

This register enables software to enable highly precise timing on the transmission and reception of frames. To enable this function, set the TSEN bit.

### Ethernet MAC Timer Support (MACTS)

Base 0x4004.8000  
Offset 0x03C  
Type R/W, reset 0x0000.0000

	31	30	29	28	27	26	25	24	23	22	21	20	19	18	17	16
	reserved															
Type	RO	RO	RO	RO	RO	RO	RO	RO	RO	RO	RO	RO	RO	RO	RO	RO
Reset	0	0	0	0	0	0	0	0	0	0	0	0	0	0	0	0
	15	14	13	12	11	10	9	8	7	6	5	4	3	2	1	0
	reserved															TSEN
Type	RO	RO	RO	RO	RO	RO	RO	RO	RO	RO	RO	RO	RO	RO	RO	R/W
Reset	0	0	0	0	0	0	0	0	0	0	0	0	0	0	0	0

Bit/Field	Name	Type	Reset	Description
31:1	reserved	RO	0x0000.000	Software should not rely on the value of a reserved bit. To provide compatibility with future products, the value of a reserved bit should be preserved across a read-modify-write operation.
0	TSEN	R/W	0	Time Stamp Enable
				Value Description
			1	The TX and RX interrupts are routed to the CCP inputs of General-Purpose Timer 3.
			0	No effect.

**Register 16: Ethernet MAC LED Encoding (MACLED), offset 0x040**

This register enables software to select the source that causes the LED1 and LED0 signal to toggle.

## Ethernet MAC LED Encoding (MACLED)

Base 0x4004.8000  
Offset 0x040  
Type R/W, reset 0x0000.0100

	31	30	29	28	27	26	25	24	23	22	21	20	19	18	17	16
	reserved															
Type	RO	RO	RO	RO	RO	RO	RO	RO	RO	RO	RO	RO	RO	RO	RO	RO
Reset	0	0	0	0	0	0	0	0	0	0	0	0	0	0	0	0
	15	14	13	12	11	10	9	8	7	6	5	4	3	2	1	0
	reserved				LED1				reserved				LED0			
Type	RO	RO	RO	RO	R/W	R/W	R/W	R/W	RO	RO	RO	RO	R/W	R/W	R/W	R/W
Reset	0	0	0	0	0	0	0	1	0	0	0	0	0	0	0	0

Bit/Field	Name	Type	Reset	Description																		
31:12	reserved	RO	0	Software should not rely on the value of a reserved bit. To provide compatibility with future products, the value of a reserved bit should be preserved across a read-modify-write operation.																		
11:8	LED1	R/W	0x1	LED1 Source The LED1 field selects the source that toggles the LED1 signal.  <table border="1"> <thead> <tr> <th>Value</th> <th>Description</th> </tr> </thead> <tbody> <tr> <td>0x0</td> <td>Link OK</td> </tr> <tr> <td>0x1</td> <td>RX or TX Activity (Default LED1)</td> </tr> <tr> <td>0x2-0x4</td> <td>Reserved</td> </tr> <tr> <td>0x5</td> <td>100BASE-TX mode</td> </tr> <tr> <td>0x6</td> <td>10BASE-T mode</td> </tr> <tr> <td>0x7</td> <td>Full-Duplex</td> </tr> <tr> <td>0x8</td> <td>Link OK &amp; Blink=RX or TX Activity</td> </tr> <tr> <td>0x9-0xF</td> <td>Reserved</td> </tr> </tbody> </table>	Value	Description	0x0	Link OK	0x1	RX or TX Activity (Default LED1)	0x2-0x4	Reserved	0x5	100BASE-TX mode	0x6	10BASE-T mode	0x7	Full-Duplex	0x8	Link OK & Blink=RX or TX Activity	0x9-0xF	Reserved
Value	Description																					
0x0	Link OK																					
0x1	RX or TX Activity (Default LED1)																					
0x2-0x4	Reserved																					
0x5	100BASE-TX mode																					
0x6	10BASE-T mode																					
0x7	Full-Duplex																					
0x8	Link OK & Blink=RX or TX Activity																					
0x9-0xF	Reserved																					
7:4	reserved	RO	0x0	Software should not rely on the value of a reserved bit. To provide compatibility with future products, the value of a reserved bit should be preserved across a read-modify-write operation.																		

---

Bit/Field	Name	Type	Reset	Description
3:0	LED0	R/W	0x0	LED0 Source The LED0 field selects the source that toggles the LED0 signal.  Value Description 0x0 Link OK (Default LED0) 0x1 RX or TX Activity 0x2-0x4 Reserved 0x5 100BASE-TX mode 0x6 10BASE-T mode 0x7 Full-Duplex 0x8 Link OK & Blink=RX or TX Activity 0x9-0xF Reserved

## Register 17: Ethernet PHY MDIX (MDIX), offset 0x044

This register enables the transmit and receive lines to be reversed in order to implement the MDI/MDI-X functionality. Software can implement the MDI/MDI-X configuration by using any available timer resource such as SysTick (see “System Timer (SysTick)” on page 80 for more information) to implement this functionality. Once the Ethernet Controller has been configured and enabled, software should check to see if the `LINK` bit in the `MR1` register has been set within approximately 1 s; if not, set the `EN` bit of the `MDIX` register to switch the reverse the transmit and receive lines to the PHY layer. Software should check the `LINK` bit again after approximately another 1 s and if no link has been established, the `EN` bit should be cleared. Software must continue to change the termination back and forth by setting and clearing the `EN` bit every 1 s until a link is established.

### Ethernet PHY MDIX (MDIX)

Base 0x4004.8000  
Offset 0x044  
Type R/W, reset 0x0000.0000

	31	30	29	28	27	26	25	24	23	22	21	20	19	18	17	16
	reserved															
Type	RO	RO	RO	RO	RO	RO	RO	RO	RO	RO	RO	RO	RO	RO	RO	RO
Reset	0	0	0	0	0	0	0	0	0	0	0	0	0	0	0	0
	15	14	13	12	11	10	9	8	7	6	5	4	3	2	1	0
	reserved															EN
Type	RO	RO	RO	RO	RO	RO	RO	RO	RO	RO	RO	RO	RO	RO	RO	R/W
Reset	0	0	0	0	0	0	0	0	0	0	0	0	0	0	0	0

Bit/Field	Name	Type	Reset	Description
31:1	reserved	RO	0x0000.000	Software should not rely on the value of a reserved bit. To provide compatibility with future products, the value of a reserved bit should be preserved across a read-modify-write operation.
0	EN	R/W	0	MDI/MDI-X Enable
				Value Description
				1 The transmit and receive signals are switched such that data is received on the transmit signals <code>TXOP</code> and <code>TXON</code> ; data is transmitted on the receive signals <code>RXIP</code> and <code>RXIN</code>
				0 No effect.

## 19.7 MII Management Register Descriptions

The *IEEE 802.3 standard* specifies a register set for controlling and gathering status from the PHY layer. The registers are collectively known as the MII Management registers. The **Ethernet MAC Management Control (MACMCTL)** register is used to access the MII Management registers, see page 844. All addresses given are absolute. Addresses not listed are reserved; these addresses should not be written to and any data read should be ignored. Also see “Ethernet MAC Register Descriptions” on page 828.

## Register 18: Ethernet PHY Management Register 0 – Control (MR0), address 0x00

This register enables software to configure the operation of the PHY layer. The default settings of these registers are designed to initialize the Ethernet Controller to a normal operational mode without configuration.

### Ethernet PHY Management Register 0 – Control (MR0)

Base 0x4004.8000

Address 0x00

Type R/W, reset 0x1000

	15	14	13	12	11	10	9	8	7	6	5	4	3	2	1	0
	RESET	LOOPBK	SPEEDSL	ANEGEN	PWRDN	ISO	RANEG	DUPLEX	COLT	reserved						
Type	R/W	R/W	R/W	R/W	R/W	R/W	R/W	R/W	R/W	R/W	R/W	R/W	R/W	R/W	R/W	R/W
Reset	0	0	0	1	0	0	0	0	0	0	0	0	0	0	0	0

Bit/Field	Name	Type	Reset	Description
15	RESET	R/W	0	Reset Registers
				Value Description
				1 The PHY layer registers reset to their default state and the internal state machines are reinitialized.
				0 No effect.
				Once the reset operation has completed, this bit is automatically cleared by hardware.
14	LOOPBK	R/W	0	Loopback Mode
				Value Description
				1 Enables the Loopback mode of operation. The receiver ignores external inputs and receives the data that is transmitted by the transmitter.
				0 No effect.
13	SPEEDSL	R/W	0	Speed Select
				Value Description
				1 Enables the 100 Mbps mode of operation (100BASE-TX).
				0 Enables the 10 Mbps mode of operation (10BASE-T).
12	ANEGEN	R/W	1	Auto-Negotiation Enable
				Value Description
				1 Enables the auto-negotiation process.
				0 No effect.

Bit/Field	Name	Type	Reset	Description
11	PWRDN	R/W	0	<p>Power Down</p> <p>Value Description</p> <p>1 The PHY layer is configured to be in a low-power consuming state. All data on the data inputs is ignored.</p> <p>0 No effect.</p>
10	ISO	R/W	0	<p>Isolate</p> <p>Value Description</p> <p>1 The transmit and receive data paths are isolated and all data being transmitted and received is ignored.</p> <p>0 No effect.</p>
9	RANEG	R/W	0	<p>Restart Auto-Negotiation</p> <p>Value Description</p> <p>1 Restarts the auto-negotiation process.</p> <p>0 No effect.</p> <p>Once the restart has initiated, this bit is automatically cleared by hardware.</p>
8	DUPLEX	R/W	0	<p>Set Duplex Mode</p> <p>Value Description</p> <p>1 Enables the Full-Duplex mode of operation. This bit can be set by software in a manual configuration process or by the auto-negotiation process.</p> <p>0 Enables the Half-Duplex mode of operation.</p> <p>Note that in 10BASE-T half-duplex mode, the transmitted data is looped back on the receive path.</p>
7	COLT	R/W	0	<p>Collision Test</p> <p>Value Description</p> <p>1 Enables the Collision Test mode of operation.</p> <p>0 No effect.</p> <p>The COLT bit is set after the initiation of a transmission and is cleared once the transmission is halted.</p>
6:0	reserved	R/W	0x00	<p>Software should not rely on the value of a reserved bit. To provide compatibility with future products, the value of a reserved bit should be preserved across a read-modify-write operation.</p> <p>These bits should always be written as zero.</p>



## Register 19: Ethernet PHY Management Register 1 – Status (MR1), address 0x01

This register enables software to determine the capabilities of the PHY layer and perform its initialization and operation appropriately.

### Ethernet PHY Management Register 1 – Status (MR1)

Base 0x4004.8000

Address 0x01

Type RO, reset 0x7809

	15	14	13	12	11	10	9	8	7	6	5	4	3	2	1	0
	reserved	100X_F	100X_H	10T_F	10T_H	reserved				ANEGC	RFAULT	ANEGA	LINK	JAB	EXTD	
Type	RO	RO	RO	RO	RO	RO	RO	RO	RO	RO	RO	RC	RO	RO	RC	RO
Reset	0	1	1	1	1	0	0	0	0	0	0	0	1	0	0	1

Bit/Field	Name	Type	Reset	Description
15	reserved	RO	0	Software should not rely on the value of a reserved bit. To provide compatibility with future products, the value of a reserved bit should be preserved across a read-modify-write operation.
14	100X_F	RO	1	100BASE-TX Full-Duplex Mode  Value Description 1 The Ethernet Controller is capable of supporting 100BASE-TX Full-Duplex mode. 0 The Ethernet Controller is not capable of supporting 100BASE-TX Full-Duplex mode.
13	100X_H	RO	1	100BASE-TX Half-Duplex Mode  Value Description 1 The Ethernet Controller is capable of supporting 100BASE-TX Half-Duplex mode. 0 The Ethernet Controller is not capable of supporting 100BASE-TX Half-Duplex mode.
12	10T_F	RO	1	10BASE-T Full-Duplex Mode  Value Description 1 The Ethernet Controller is capable of supporting 10BASE-T Full-Duplex mode. 0 The Ethernet Controller is not capable of supporting 10BASE-T Full-Duplex mode.
11	10T_H	RO	1	10BASE-T Half-Duplex Mode  Value Description 1 The Ethernet Controller is capable of supporting 10BASE-T Half-Duplex mode. 0 The Ethernet Controller is not capable of supporting 10BASE-T Half-Duplex mode.

Bit/Field	Name	Type	Reset	Description
10:6	reserved	RO	0	Software should not rely on the value of a reserved bit. To provide compatibility with future products, the value of a reserved bit should be preserved across a read-modify-write operation.
5	ANEGC	RO	0	Auto-Negotiation Complete  Value Description 1 The auto-negotiation process has been completed and that the extended registers defined by the auto-negotiation protocol are valid. 0 The auto-negotiation process is not complete.
4	RFAULT	RC	0	Remote Fault  Value Description 1 A remote fault condition has been detected. 0 A remote fault condition has not been detected.  This bit remains set until it is read, even if the condition no longer exists.
3	ANEGA	RO	1	Auto-Negotiation  Value Description 1 The Ethernet Controller has the ability to perform auto-negotiation. 0 The Ethernet Controller does not have the ability to perform auto-negotiation.
2	LINK	RO	0	Link Made  Value Description 1 A valid link has been established by the Ethernet Controller. 0 A valid link has not been established by the Ethernet Controller.
1	JAB	RC	0	Jabber Condition  Value Description 1 A jabber condition has been detected by the Ethernet Controller. 0 A jabber condition has not been detected by the Ethernet Controller.  This bit remains set until it is read, even if the jabber condition no longer exists.
0	EXTD	RO	1	Extended Capabilities  Value Description 1 The Ethernet Controller provides an extended set of capabilities that can be accessed through the extended register set. 0 The Ethernet Controller does not provide extended capabilities.

## Register 20: Ethernet PHY Management Register 2 – PHY Identifier 1 (MR2), address 0x02

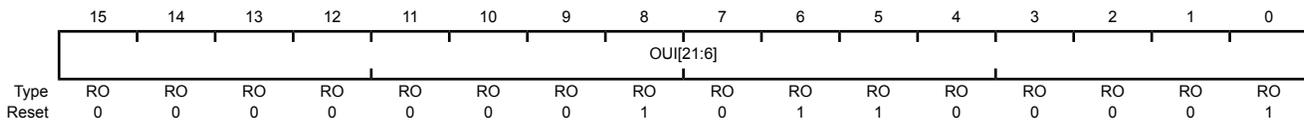
This register, along with **MR3**, provides a 32-bit value indicating the manufacturer, model, and revision information.

### Ethernet PHY Management Register 2 – PHY Identifier 1 (MR2)

Base 0x4004.8000

Address 0x02

Type RO, reset 0x0161



Bit/Field	Name	Type	Reset	Description
15:0	OUI[21:6]	RO	0x0161	Organizationally Unique Identifier[21:6]  This field, along with the OUI[5:0] field in <b>MR3</b> , makes up the Organizationally Unique Identifier indicating the PHY manufacturer.

### Register 21: Ethernet PHY Management Register 3 – PHY Identifier 2 (MR3), address 0x03

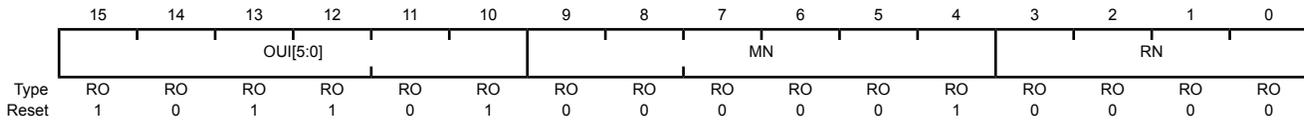
This register, along with **MR2**, provides a 32-bit value indicating the manufacturer, model, and revision information.

#### Ethernet PHY Management Register 3 – PHY Identifier 2 (MR3)

Base 0x4004.8000

Address 0x03

Type RO, reset 0xB410



Bit/Field	Name	Type	Reset	Description
15:10	OUI[5:0]	RO	0x2D	Organizationally Unique Identifier[5:0]  This field, along with the OUI [ 21 : 6 ] field in <b>MR2</b> , makes up the Organizationally Unique Identifier indicating the PHY manufacturer.
9:4	MN	RO	0x01	Model Number  The MN field represents the Model Number of the PHY.
3:0	RN	RO	0x0	Revision Number  The RN field represents the Revision Number of the PHY implementation.

## Register 22: Ethernet PHY Management Register 4 – Auto-Negotiation Advertisement (MR4), address 0x04

This register provides the advertised abilities of the Ethernet Controller used during auto-negotiation. Bits 8:5 represent the Technology Ability Field bits. This field can be overwritten by software to auto-negotiate to an alternate common technology. Writing to this register has no effect until auto-negotiation is re-initiated by setting the `RANEG` bit in the **MR0** register.

### Ethernet PHY Management Register 4 – Auto-Negotiation Advertisement (MR4)

Base 0x4004.8000  
Address 0x04  
Type R/W, reset 0x01E1

	15	14	13	12	11	10	9	8	7	6	5	4	3	2	1	0
	NP	reserved	RF	reserved			A3	A2	A1	A0	S					
Type	RO	RO	R/W	RO	RO	RO	RO	R/W	R/W	R/W	R/W	RO	RO	RO	RO	RO
Reset	0	0	0	0	0	0	0	1	1	1	1	0	0	0	0	1

Bit/Field	Name	Type	Reset	Description
15	NP	RO	0	Next Page  Value Description 1 The Ethernet Controller is capable of Next Page exchanges to provide more detailed information on the PHY layer's capabilities. 0 The Ethernet Controller is not capable of Next Page exchanges.
14	reserved	RO	0	Software should not rely on the value of a reserved bit. To provide compatibility with future products, the value of a reserved bit should be preserved across a read-modify-write operation.
13	RF	R/W	0	Remote Fault  Value Description 1 Indicates to the link partner that a Remote Fault condition has been encountered. 0 No Remote Fault condition has been encountered.
12:9	reserved	RO	0x0	Software should not rely on the value of a reserved bit. To provide compatibility with future products, the value of a reserved bit should be preserved across a read-modify-write operation.
8	A3	R/W	1	Technology Ability Field [3]  Value Description 1 The Ethernet Controller supports the 100Base-TX full-duplex signaling protocol. If software wants to ensure that this mode is not used, this bit can be cleared and auto-negotiation re-initiated with the <code>RANEG</code> bit in the <b>MR0</b> register. 0 The Ethernet Controller does not support the 100Base-TX full-duplex signaling protocol.

Bit/Field	Name	Type	Reset	Description
7	A2	R/W	1	<p>Technology Ability Field [2]</p> <p>Value Description</p> <p>1 The Ethernet Controller supports the 100Base-TX half-duplex signaling protocol. If software wants to ensure that this mode is not used, this bit can be cleared and auto-negotiation re-initiated with the <code>RANEG</code> bit in the <b>MRO</b> register.</p> <p>0 The Ethernet Controller does not support the 100Base-TX half-duplex signaling protocol.</p>
6	A1	R/W	1	<p>Technology Ability Field [1]</p> <p>Value Description</p> <p>1 The Ethernet Controller supports the 10BASE-T full-duplex signaling protocol. If software wants to ensure that this mode is not used, this bit can be cleared and auto-negotiation re-initiated with the <code>RANEG</code> bit in the <b>MRO</b> register.</p> <p>0 The Ethernet Controller does not support the 10BASE-T full-duplex signaling protocol.</p>
5	A0	R/W	1	<p>Technology Ability Field [0]</p> <p>Value Description</p> <p>1 The Ethernet Controller supports the 10BASE-T half-duplex signaling protocol. If software wants to ensure that this mode is not used, this bit can be cleared and auto-negotiation re-initiated with the <code>RANEG</code> bit in the <b>MRO</b> register.</p> <p>0 The Ethernet Controller does not support the 10BASE-T half-duplex signaling protocol.</p>
4:0	S	RO	0x1	<p>Selector Field</p> <p>This field encodes 32 possible messages for communicating between Ethernet Controllers. This field is hard-coded to 0x01, indicating that the Stellaris<sup>®</sup> Ethernet Controller is <i>IEEE 802.3</i> compliant.</p>

## Register 23: Ethernet PHY Management Register 5 – Auto-Negotiation Link Partner Base Page Ability (MR5), address 0x05

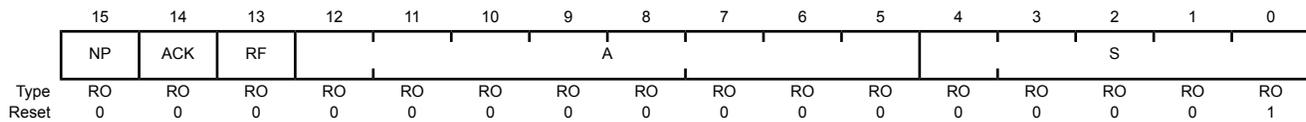
This register provides the advertised abilities of the link partner's Ethernet Controller that are received and stored during auto-negotiation.

### Ethernet PHY Management Register 5 – Auto-Negotiation Link Partner Base Page Ability (MR5)

Base 0x4004.8000

Address 0x05

Type RO, reset 0x0001



Bit/Field	Name	Type	Reset	Description
15	NP	RO	0	Next Page
				Value Description
				1 The link partner's Ethernet Controller is capable of Next page exchanges to provide more detailed information on the Ethernet Controller's capabilities.
				0 The link partner's Ethernet Controller is not capable of Next page exchanges
14	ACK	RO	0	Acknowledge
				Value Description
				1 The Ethernet Controller has successfully received the link partner's advertised abilities during auto-negotiation.
				0 The Ethernet Controller has not received the link partner's advertised abilities during auto-negotiation.
13	RF	RO	0	Remote Fault
				Value Description
				1 The link partner is indicating that a Remote Fault condition has been encountered.
				0 The link partner is not indicating that a Remote Fault condition has been encountered.
12:5	A	RO	0x00	Technology Ability Field
				This field encodes individual technologies that are supported by the Ethernet Controller. See the <b>MR4</b> register for definitions. Note that bits [12:9] describe functions that are not implemented on the Stellaris® Ethernet Controller. Refer to the IEEE 802.3 standard for definitions.

Bit/Field	Name	Type	Reset	Description														
4:0	S	RO	0x01	Selector Field This field encodes possible messages for communicating between Ethernet Controllers.														
				<table><thead><tr><th>Value</th><th>Description</th></tr></thead><tbody><tr><td>0x00</td><td>Reserved</td></tr><tr><td>0x01</td><td>IEEE Std 802.3</td></tr><tr><td>0x02</td><td>IEEE Std 802.9 ISLAN-16T</td></tr><tr><td>0x03</td><td>IEEE Std 802.5</td></tr><tr><td>0x04</td><td>IEEE Std 1394</td></tr><tr><td>0x05–0x1F</td><td>Reserved</td></tr></tbody></table>	Value	Description	0x00	Reserved	0x01	IEEE Std 802.3	0x02	IEEE Std 802.9 ISLAN-16T	0x03	IEEE Std 802.5	0x04	IEEE Std 1394	0x05–0x1F	Reserved
Value	Description																	
0x00	Reserved																	
0x01	IEEE Std 802.3																	
0x02	IEEE Std 802.9 ISLAN-16T																	
0x03	IEEE Std 802.5																	
0x04	IEEE Std 1394																	
0x05–0x1F	Reserved																	



## Register 24: Ethernet PHY Management Register 6 – Auto-Negotiation Expansion (MR6), address 0x06

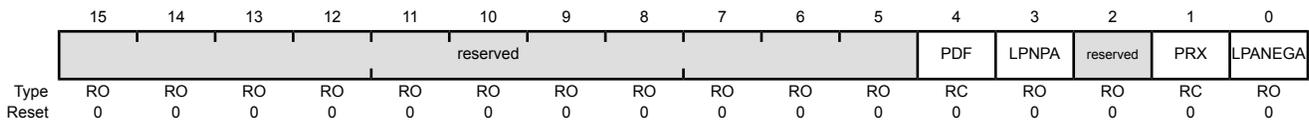
This register enables software to determine the auto-negotiation and next page capabilities of the Ethernet Controller and the link partner after auto-negotiation.

### Ethernet PHY Management Register 6 – Auto-Negotiation Expansion (MR6)

Base 0x4004.8000

Address 0x06

Type RO, reset 0x0000



Bit/Field	Name	Type	Reset	Description
15:5	reserved	RO	0x000	Software should not rely on the value of a reserved bit. To provide compatibility with future products, the value of a reserved bit should be preserved across a read-modify-write operation.
4	PDF	RC	0	Parallel Detection Fault  Value Description 1 More than one technology was detected at link up. 0 Only one technology was detected at link up.  This bit is automatically cleared when read.
3	LPNPA	RO	0	Link Partner is Next Page Able  Value Description 1 The link partner is enabled to support next page. 0 The link partner is not enabled to support next page.
2	reserved	RO	0	Software should not rely on the value of a reserved bit. To provide compatibility with future products, the value of a reserved bit should be preserved across a read-modify-write operation.
1	PRX	RC	0	New Page Received  Value Description 1 A new page has been received from the link partner and stored. 0 A new page has not been received.  This bit is automatically cleared when read.
0	LPANEGA	RO	0	Link Partner is Auto-Negotiation Able  Value Description 1 The link partner is enabled to support auto-negotiation. 0 The link partner is not enabled to support auto-negotiation.

## Register 25: Ethernet PHY Management Register 16 – Vendor-Specific (MR16), address 0x10

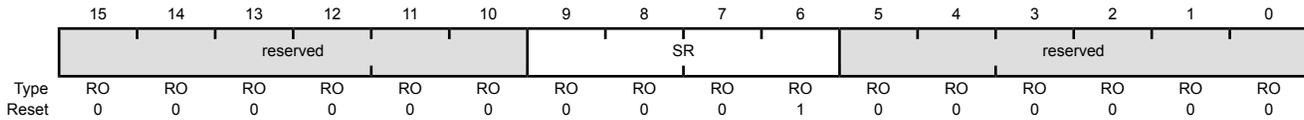
This register contains a silicon revision identifier.

### Ethernet PHY Management Register 16 – Vendor-Specific (MR16)

Base 0x4004.8000

Address 0x10

Type RO, reset 0x0040



Bit/Field	Name	Type	Reset	Description
15:10	reserved	RO	0x0000.0	Software should not rely on the value of a reserved bit. To provide compatibility with future products, the value of a reserved bit should be preserved across a read-modify-write operation.
9:6	SR	RO	0x1	Silicon Revision Identifier This field contains the four-bit identifier for the silicon revision.
5:0	reserved	RO	0x00	Software should not rely on the value of a reserved bit. To provide compatibility with future products, the value of a reserved bit should be preserved across a read-modify-write operation.

## Register 26: Ethernet PHY Management Register 17 – Mode Control/Status (MR17), address 0x11

This register provides the means for controlling and observing various PHY layer modes.

### Ethernet PHY Management Register 17 – Mode Control/Status (MR17)

Base 0x4004.8000

Address 0x11

Type R/W, reset 0x0002

	15	14	13	12	11	10	9	8	7	6	5	4	3	2	1	0
	reserved	FASTRIP	EDPD	reserved	LSQE	reserved	FASTEST	reserved	reserved	reserved	reserved	reserved	reserved	FGLS	ENON	reserved
Type	R/W	R/W	R/W	R/W	R/W	RO	RO	R/W	R/W	R/W	R/W	R/W	R/W	R/W	RO	R/W
Reset	0	0	0	0	0	0	0	0	0	0	0	0	0	0	1	0

Bit/Field	Name	Type	Reset	Description
15	reserved	R/W	0	Software should not rely on the value of a reserved bit. To provide compatibility with future products, the value of a reserved bit should be preserved across a read-modify-write operation.  <b>Important:</b> This bit must always be written with a 0 to ensure proper operation.
14	FASTRIP	R/W	0	10-BASE-T Fast Mode Enable  Value Description 1 Enables PHYT_10 test mode. 0 No effect.
13	EDPD	R/W	0	Enable Energy Detect Power Down  Value Description 1 Enables the Energy Detect Power Down mode. 0 No effect.
12	reserved	R/W	0	Software should not rely on the value of a reserved bit. To provide compatibility with future products, the value of a reserved bit should be preserved across a read-modify-write operation.  <b>Important:</b> This bit must always be written with a 0 to ensure proper operation.
11	LSQE	R/W	0	Low Squelch Enable  Value Description 1 Enables a lower threshold meaning more sensitivity to the signal levels. 0 No effect.
10:9	reserved	RO	0	Software should not rely on the value of a reserved bit. To provide compatibility with future products, the value of a reserved bit should be preserved across a read-modify-write operation.

Bit/Field	Name	Type	Reset	Description
8	FASTEST	R/W	0	<p>Auto-Negotiation Test Mode</p> <p>Value Description</p> <p>1 Enables the Auto-Negotiation Test mode.</p> <p>0 No effect.</p>
7:3	reserved	R/W	0	<p>Software should not rely on the value of a reserved bit. To provide compatibility with future products, the value of a reserved bit should be preserved across a read-modify-write operation.</p> <hr/> <p><b>Important:</b> This bit must always be written with a 0 to ensure proper operation.</p> <hr/>
2	FGLS	R/W	0	<p>Force Good Link Status</p> <p>Value Description</p> <p>1 Forces the 100BASE-T link to be active.</p> <p>0 No effect.</p> <p><b>Note:</b> This bit should only be set when testing.</p>
1	ENON	RO	1	<p>Energy On</p> <p>Value Description</p> <p>1 Energy is detected on the line.</p> <p>0 Valid energy has not been detected on the line within 256 ms.</p> <p>This bit is set by a hardware reset, but is unaffected by a software reset.</p>
0	reserved	R/W	0	<p>Software should not rely on the value of a reserved bit. To provide compatibility with future products, the value of a reserved bit should be preserved across a read-modify-write operation.</p> <hr/> <p><b>Important:</b> This bit must always be written with a 0 to ensure proper operation.</p> <hr/>

## Register 27: Ethernet PHY Management Register 27 – Special Control/Status (MR27), address 0x1B

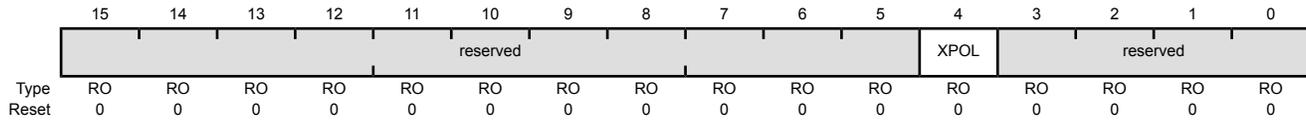
This register shows the status of the 10BASE-T polarity.

### Ethernet PHY Management Register 27 – Special Control/Status (MR27)

Base 0x4004.8000

Address 0x1B

Type RO, reset -



Bit/Field	Name	Type	Reset	Description
15:5	reserved	RO	0x000	Software should not rely on the value of a reserved bit. To provide compatibility with future products, the value of a reserved bit should be preserved across a read-modify-write operation.
4	XPOL	RO	0	Polarity State of 10 BASE-T  Value Description 1 The 10BASE-T is reversed polarity. 0 The 10BASE-T is normal polarity.
3:0	reserved	RO	0x0	Software should not rely on the value of a reserved bit. To provide compatibility with future products, the value of a reserved bit should be preserved across a read-modify-write operation.

## Register 28: Ethernet PHY Management Register 29 – Interrupt Status (MR29), address 0x1D

This register contains information about the source of PHY layer interrupts. Reading this register clears any bits that are set. The `PHYINT` bit is set in the `MACRIS/MACIACK` register whenever any of the bits in this register are set.

### Ethernet PHY Management Register 29 – Interrupt Status (MR29)

Base 0x4004.8000  
Address 0x1D  
Type RO, reset 0x0000

	15	14	13	12	11	10	9	8	7	6	5	4	3	2	1	0
	reserved								EONIS	ANCOMPIS	RFLTIS	LDIS	LPACKIS	PDFIS	PRXIS	reserved
Type	RO	RO	RO	RO	RO	RO	RO	RO	RO	RO	RO	RO	RO	RO	RO	RO
Reset	0	0	0	0	0	0	0	0	0	0	0	0	0	0	0	0

Bit/Field	Name	Type	Reset	Description
15:8	reserved	RO	0x00	Software should not rely on the value of a reserved bit. To provide compatibility with future products, the value of a reserved bit should be preserved across a read-modify-write operation.
7	EONIS	RO	0	ENERGYON Interrupt  Value Description 1 An interrupt has been generated due to the <code>ENON</code> bit being set in the <b>MR17</b> register. 0 No interrupt.  This bit is cleared by reading the value.
6	ANCOMPIS	RO	0	Auto-Negotiation Complete Interrupt  Value Description 1 An interrupt has been generated due to the completion of auto negotiation. 0 No interrupt.  This bit is cleared by reading the value.
5	RFLTIS	RO	0	Remote Fault Interrupt  Value Description 1 An interrupt has been generated due to the detection of a Remote Fault. 0 No interrupt.  This bit is cleared by reading the value.
4	LDIS	RO	0	Link Down Interrupt  Value Description 1 An interrupt has been generated because the <code>LINK</code> bit in <b>MR1</b> is clear. 0 No interrupt.  This bit is cleared by reading the value.

Bit/Field	Name	Type	Reset	Description
3	LPACKIS	RO	0	<p>Auto-Negotiation LP Acknowledge</p> <p>Value Description</p> <p>1 An interrupt has been generated due to the reception of an acknowledge message from the link partner during auto-negotiation.</p> <p>0 No interrupt.</p> <p>This bit is cleared by reading the value.</p>
2	PDFIS	RO	0	<p>Parallel Detection Fault</p> <p>Value Description</p> <p>1 An interrupt has been generated due to the detection of a parallel detection fault during auto negotiation.</p> <p>0 No interrupt.</p> <p>This bit is cleared by reading the value.</p>
1	PRXIS	RO	0	<p>Auto Negotiation Page Received</p> <p>Value Description</p> <p>1 An interrupt has been generated due to the reception of an auto negotiation page from the link partner.</p> <p>0 No interrupt.</p> <p>This bit is cleared by reading the value.</p>
0	reserved	RO	0	<p>Software should not rely on the value of a reserved bit. To provide compatibility with future products, the value of a reserved bit should be preserved across a read-modify-write operation.</p>

## Register 29: Ethernet PHY Management Register 30 – Interrupt Mask (MR30), address 0x1E

This register enables interrupts to be generated by the various sources of PHY layer interrupts.

### Ethernet PHY Management Register 30 – Interrupt Mask (MR30)

Base 0x4004.8000

Address 0x1E

Type R/W, reset 0x0000

	15	14	13	12	11	10	9	8	7	6	5	4	3	2	1	0
	reserved								EONIM	ANCOMPIM	RFLTIM	LDIM	LPACKIM	PDFIM	PRXIM	reserved
Type	RO	RO	RO	RO	RO	RO	RO	RO	R/W	R/W	R/W	R/W	R/W	R/W	R/W	R/W
Reset	0	0	0	0	0	0	0	0	0	0	0	0	0	0	0	0

Bit/Field	Name	Type	Reset	Description
15:8	reserved	RO	0x00	Software should not rely on the value of a reserved bit. To provide compatibility with future products, the value of a reserved bit should be preserved across a read-modify-write operation.
7	EONIM	R/W	0	ENERGYON Interrupt Enabled  Value Description 1 An interrupt is sent to the interrupt controller when the EONIS bit in the <b>MR29</b> register is set. 0 The EONIS interrupt is suppressed and not sent to the interrupt controller.
6	ANCOMPIM	R/W	0	Auto-Negotiation Complete Interrupt Enabled  Value Description 1 An interrupt is sent to the interrupt controller when the ANCOMPIS bit in the <b>MR29</b> register is set. 0 The ANCOMPIS interrupt is suppressed and not sent to the interrupt controller.
5	RFLTIM	R/W	0	Remote Fault Interrupt Enabled  Value Description 1 An interrupt is sent to the interrupt controller when the RFLTIS bit in the <b>MR29</b> register is set. 0 The RFLTIS interrupt is suppressed and not sent to the interrupt controller.
4	LDIM	R/W	0	Link Down Interrupt Enabled  Value Description 1 An interrupt is sent to the interrupt controller when the LDIS bit in the <b>MR29</b> register is set. 0 The LDIS interrupt is suppressed and not sent to the interrupt controller.



Bit/Field	Name	Type	Reset	Description
3	LPACKIM	R/W	0	Auto-Negotiation LP Acknowledge Enabled  Value Description 1 An interrupt is sent to the interrupt controller when the LPACKIS bit in the <b>MR29</b> register is set. 0 The LPACKIS interrupt is suppressed and not sent to the interrupt controller.
2	PDFIM	R/W	0	Parallel Detection Fault Enabled  Value Description 1 An interrupt is sent to the interrupt controller when the PDFIS bit in the <b>MR29</b> register is set. 0 The PDFIS interrupt is suppressed and not sent to the interrupt controller.
1	PRXIM	R/W	0	Auto Negotiation Page Received Enabled  Value Description 1 An interrupt is sent to the interrupt controller when the PRXIS bit in the <b>MR29</b> register is set. 0 The PRXIS interrupt is suppressed and not sent to the interrupt controller.
0	reserved	R/W	0	Software should not rely on the value of a reserved bit. To provide compatibility with future products, the value of a reserved bit should be preserved across a read-modify-write operation.

## Register 30: Ethernet PHY Management Register 31 – PHY Special Control/Status (MR31), address 0x1F

This register provides special control and status for the PHY layer.

### Ethernet PHY Management Register 31 – PHY Special Control/Status (MR31)

Base 0x4004.8000

Address 0x1F

Type R/W, reset 0x00040

	15	14	13	12	11	10	9	8	7	6	5	4	3	2	1	0
	reserved			AUTODONE	reserved						SPEED			reserved	SCRDIS	
Type	R/W	R/W	R/W	RO	RO	RO	RO	RO	RO	RO	RO	RO	RO	RO	R/W	R/W
Reset	0	0	0	0	0	0	0	0	0	0	0	0	0	0	0	0

Bit/Field	Name	Type	Reset	Description
15:13	reserved	R/W	0x0	Software should not rely on the value of a reserved bit. To provide compatibility with future products, the value of a reserved bit should be preserved across a read-modify-write operation.
<b>Important:</b> This bit field must always be written with a 0 to ensure proper operation.				
12	AUTODONE	RO	0	Auto Negotiation Done
		Value	Description	
		1	Auto negotiation is complete.	
		0	Auto negotiation is not complete.	
11:5	reserved	RO	0	Software should not rely on the value of a reserved bit. To provide compatibility with future products, the value of a reserved bit should be preserved across a read-modify-write operation.
4:2	SPEED	RO	0x0	HCD Speed Value
		Value	Description	
		0x0	Reserved	
		0x1	10BASE-T half duplex	
		0x2	100BASE-T half duplex	
		0x3-0x4	Reserved	
		0x5	10BASE-T full duplex	
		0x6	100BASE-T full duplex	
		0x7	Reserved	
1	reserved	R/W	0	Software should not rely on the value of a reserved bit. To provide compatibility with future products, the value of a reserved bit should be preserved across a read-modify-write operation.
0	SCRDIS	R/W	0	Scramble Disable
		Value	Description	
		1	Disables data scrambling.	
		0	Enables data scrambling.	

## 20 Universal Serial Bus (USB) Controller

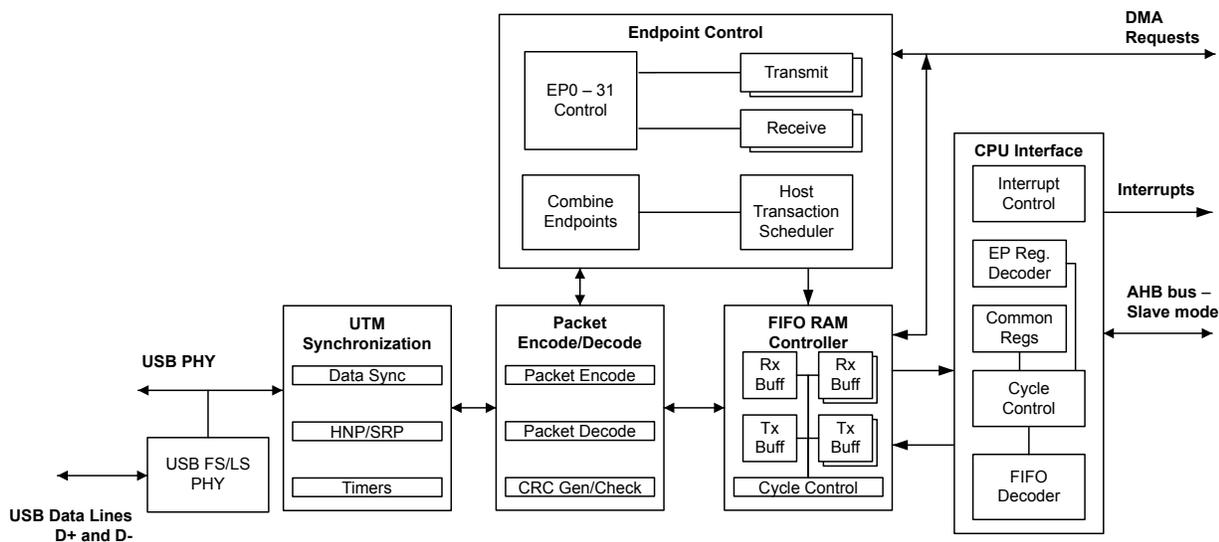
The Stellaris® USB controller operates as a full-speed or low-speed function controller during point-to-point communications with USB Host, Device, or OTG functions. The controller complies with the USB 2.0 standard, which includes SUSPEND and RESUME signaling. 32 endpoints including two hard-wired for control transfers (one endpoint for IN and one endpoint for OUT) plus 30 endpoints defined by firmware along with a dynamic sizable FIFO support multiple packet queueing.  $\mu$ DMA access to the FIFO allows minimal interference from system software. Software-controlled connect and disconnect allows flexibility during USB device start-up. The controller complies with OTG standard's session request protocol (SRP) and host negotiation protocol (HNP).

The Stellaris® USB module has the following features:

- Complies with USB-IF certification standards
- USB 2.0 full-speed (12 Mbps) and low-speed (1.5 Mbps) operation
- Integrated PHY
- 4 transfer types: Control, Interrupt, Bulk, and Isochronous
- 32 endpoints
  - 1 dedicated control IN endpoint and 1 dedicated control OUT endpoint
  - 15 configurable IN endpoints and 15 configurable OUT endpoints
- 4 KB dedicated endpoint memory: one endpoint may be defined for double-buffered 1023-byte isochronous packet size
- VBUS droop and valid ID detection and interrupt
- Efficient transfers using Micro Direct Memory Access Controller ( $\mu$ DMA)
  - Separate channels for transmit and receive for up to three IN endpoints and three OUT endpoints
  - Channel requests asserted when FIFO contains required amount of data

## 20.1 Block Diagram

Figure 20-1. USB Module Block Diagram



## 20.2 Signal Description

Table 20-1 on page 876 and Table 20-2 on page 877 list the external signals of the USB controller and describe the function of each. Some USB controller signals are alternate functions for some GPIO signals and default to be GPIO signals at reset. The column in the table below titled "Pin Mux/Pin Assignment" lists the possible GPIO pin placements for these USB signals. The `AFSEL` bit in the **GPIO Alternate Function Select (GPIOAFSEL)** register (page 328) should be set to choose the USB function. The number in parentheses is the encoding that must be programmed into the `PMCn` field in the **GPIO Port Control (GPIOCTL)** register (page 346) to assign the USB signal to the specified GPIO port pin. The `USB0VBUS` and `USB0ID` signals are configured by clearing the appropriate `DEN` bit in the **GPIO Digital Enable (GPIODEN)** register. For more information on configuring GPIOs, see "General-Purpose Input/Outputs (GPIOs)" on page 304. The remaining signals (with the word "fixed" in the Pin Mux/Pin Assignment column) have a fixed pin assignment and function.

**Note:** When used in OTG mode, `USB0VBUS` and `USB0ID` do not require any configuration as they are dedicated pins for the USB controller and directly connect to the USB connector's VBUS and ID signals. If the USB controller is used as either a dedicated Host or Device, the `DEVMODOTG` and `DEVMOD` bits in the **USB General-Purpose Control and Status (USBGPCS)** register can be used to connect the `USB0VBUS` and `USB0ID` inputs to fixed levels internally, freeing the `PB0` and `PB1` pins for GPIO use. For proper self-powered Device operation, the VBUS value must still be monitored to assure that if the Host removes VBUS, the self-powered Device disables the D+/D- pull-up resistors. This function can be accomplished by connecting a standard GPIO to VBUS.

Table 20-1. Signals for USB (100LQFP)

Pin Name	Pin Number	Pin Mux / Pin Assignment	Pin Type	Buffer Type <sup>a</sup>	Description
USB0DM	70	fixed	I/O	Analog	Bidirectional differential data pin (D- per USB specification).

Table 20-1. Signals for USB (100LQFP) (continued)

Pin Name	Pin Number	Pin Mux / Pin Assignment	Pin Type	Buffer Type <sup>a</sup>	Description
USB0DP	71	fixed	I/O	Analog	Bidirectional differential data pin (D+ per USB specification).
USB0EPEN	19 24 34 72 83	PG0 (7) PC5 (6) PA6 (8) PB2 (8) PH3 (4)	O	TTL	Optionally used in Host mode to control an external power source to supply power to the USB bus.
USB0ID	66	PB0	I	Analog	This signal senses the state of the USB ID signal. The USB PHY enables an integrated pull-up, and an external element (USB connector) indicates the initial state of the USB controller (pulled down is the A side of the cable and pulled up is the B side).
USB0PFLT	22 23 35 65 74 76 87	PC7 (6) PC6 (7) PA7 (8) PB3 (8) PE0 (9) PH4 (4) PJ1 (9)	I	TTL	Optionally used in Host mode by an external power source to indicate an error state by that power source.
USB0RBIAS	73	fixed	O	Analog	9.1-kΩ resistor (1% precision) used internally for USB analog circuitry.
USB0VBUS	67	PB1	I/O	Analog	This signal is used during the session request protocol. This signal allows the USB PHY to both sense the voltage level of VBUS, and pull up VBUS momentarily during VBUS pulsing.

a. The TTL designation indicates the pin has TTL-compatible voltage levels.

Table 20-2. Signals for USB (108BGA)

Pin Name	Pin Number	Pin Mux / Pin Assignment	Pin Type	Buffer Type <sup>a</sup>	Description
USB0DM	C11	fixed	I/O	Analog	Bidirectional differential data pin (D- per USB specification).
USB0DP	C12	fixed	I/O	Analog	Bidirectional differential data pin (D+ per USB specification).
USB0EPEN	K1 M1 L6 A11 D10	PG0 (7) PC5 (6) PA6 (8) PB2 (8) PH3 (4)	O	TTL	Optionally used in Host mode to control an external power source to supply power to the USB bus.
USB0ID	E12	PB0	I	Analog	This signal senses the state of the USB ID signal. The USB PHY enables an integrated pull-up, and an external element (USB connector) indicates the initial state of the USB controller (pulled down is the A side of the cable and pulled up is the B side).
USB0PFLT	L2 M2 M6 E11 B11 B10 B6	PC7 (6) PC6 (7) PA7 (8) PB3 (8) PE0 (9) PH4 (4) PJ1 (9)	I	TTL	Optionally used in Host mode by an external power source to indicate an error state by that power source.

Table 20-2. Signals for USB (108BGA) (continued)

Pin Name	Pin Number	Pin Mux / Pin Assignment	Pin Type	Buffer Type <sup>a</sup>	Description
USB0RBIAS	B12	fixed	O	Analog	9.1-kΩ resistor (1% precision) used internally for USB analog circuitry.
USB0VBUS	D12	PB1	I/O	Analog	This signal is used during the session request protocol. This signal allows the USB PHY to both sense the voltage level of VBUS, and pull up VBUS momentarily during VBUS pulsing.

a. The TTL designation indicates the pin has TTL-compatible voltage levels.

## 20.3 Functional Description

**Note:** A 9.1-kΩ resistor should be connected between the USB0RBIAS and ground. The 9.1-kΩ resistor should have a 1% tolerance and should be located in close proximity to the USB0RBIAS pin. Power dissipation in the resistor is low, so a chip resistor of any geometry may be used.

The Stellaris<sup>®</sup> USB controller provides full OTG negotiation by supporting both the session request protocol (SRP) and the host negotiation protocol (HNP). The session request protocol allows devices on the B side of a cable to request the A side device turn on VBUS. The host negotiation protocol is used after the initial session request protocol has powered the bus and provides a method to determine which end of the cable will act as the Host controller. When the device is connected to non-OTG peripherals or devices, the controller can detect which cable end was used and provides a register to indicate if the controller should act as the Host or the Device controller. This indication and the mode of operation are handled automatically by the USB controller. This auto-detection allows the system to use a single A/B connector instead of having both A and B connectors in the system and supports full OTG negotiations with other OTG devices.

In addition, the USB controller provides support for connecting to non-OTG peripherals or Host controllers. The USB controller can be configured to act as either a dedicated Host or Device, in which case, the USB0VBUS and USB0ID signals can be used as GPIOs. However, when the USB controller is acting as a self-powered Device, a GPIO input or analog comparator input must be connected to VBUS and configured to generate an interrupt when the VBUS level drops. This interrupt is used to disable the pullup resistor on the USB0DP signal.

**Note:** When USB is used in the system, the minimum system frequency is 20 MHz.

### 20.3.1 Operation as a Device

This section describes the Stellaris<sup>®</sup> USB controller's actions when it is being used as a USB Device. Before the USB controller's operating mode is changed from Device to Host or Host to Device, software must reset the USB controller by setting the USB0 bit in the **Software Reset Control 2 (SRCR2)** register (see page 207). IN endpoints, OUT endpoints, entry into and exit from SUSPEND mode, and recognition of Start of Frame (SOF) are all described.

When in Device mode, IN transactions are controlled by an endpoint's transmit interface and use the transmit endpoint registers for the given endpoint. OUT transactions are handled with an endpoint's receive interface and use the receive endpoint registers for the given endpoint.

When configuring the size of the FIFOs for endpoints, take into account the maximum packet size for an endpoint.

- **Bulk.** Bulk endpoints should be the size of the maximum packet (up to 64 bytes) or twice the maximum packet size if double buffering is used (described further in the following section).

- **Interrupt.** Interrupt endpoints should be the size of the maximum packet (up to 64 bytes) or twice the maximum packet size if double buffering is used.
- **Isochronous.** Isochronous endpoints are more flexible and can be up to 1023 bytes.
- **Control.** It is also possible to specify a separate control endpoint for a USB Device. However, in most cases the USB Device should use the dedicated control endpoint on the USB controller's endpoint 0.

### 20.3.1.1 Endpoints

When operating as a Device, the USB controller provides two dedicated control endpoints (IN and OUT) and 30 configurable endpoints (15 IN and 15 OUT) that can be used for communications with a Host controller. The endpoint number and direction associated with an endpoint is directly related to its register designation. For example, when the Host is transmitting to endpoint 1, all configuration and data is in the endpoint 1 transmit register interface.

Endpoint 0 is a dedicated control endpoint used for all control transactions to endpoint 0 during enumeration or when any other control requests are made to endpoint 0. Endpoint 0 uses the first 64 bytes of the USB controller's FIFO RAM as a shared memory for both IN and OUT transactions.

The remaining 30 endpoints can be configured as control, bulk, interrupt, or isochronous endpoints. They should be treated as 15 configurable IN and 15 configurable OUT endpoints. The endpoint pairs are not required to have the same type for their IN and OUT endpoint configuration. For example, the OUT portion of an endpoint pair could be a bulk endpoint, while the IN portion of that endpoint pair could be an interrupt endpoint. The address and size of the FIFOs attached to each endpoint can be modified to fit the application's needs.

### 20.3.1.2 IN Transactions as a Device

When operating as a USB Device, data for IN transactions is handled through the FIFOs attached to the transmit endpoints. The sizes of the FIFOs for the 15 configurable IN endpoints are determined by the **USB Transmit FIFO Start Address (USBTXFIFOADD)** register. The maximum size of a data packet that may be placed in a transmit endpoint's FIFO for transmission is programmable and is determined by the value written to the **USB Maximum Transmit Data Endpoint n (USBTXMAXPn)** register for that endpoint. The endpoint's FIFO can also be configured to use double-packet or single-packet buffering. When double-packet buffering is enabled, two data packets can be buffered in the FIFO, which also requires that the FIFO is at least two packets in size. When double-packet buffering is disabled, only one packet can be buffered, even if the packet size is less than half the FIFO size.

**Note:** The maximum packet size set for any endpoint must not exceed the FIFO size. The **USBTXMAXPn** register should not be written to while data is in the FIFO as unexpected results may occur.

#### **Single-Packet Buffering**

If the size of the transmit endpoint's FIFO is less than twice the maximum packet size for this endpoint (as set in the **USB Transmit Dynamic FIFO Sizing (USBTXFIFOSZ)** register), only one packet can be buffered in the FIFO and single-packet buffering is required. When each packet is completely loaded into the transmit FIFO, the **TXRDY** bit in the **USB Transmit Control and Status Endpoint n Low (USBTXCSRLn)** register must be set. If the **AUTOSET** bit in the **USB Transmit Control and Status Endpoint n High (USBTXCSRHn)** register is set, the **TXRDY** bit is automatically set when a maximum-sized packet is loaded into the FIFO. For packet sizes less than the maximum, the **TXRDY** bit must be set manually. When the **TXRDY** bit is set, either manually or automatically, the packet is ready to be sent. When the packet has been successfully sent, both **TXRDY** and **FIFONE**

are cleared, and the appropriate transmit endpoint interrupt signaled. At this point, the next packet can be loaded into the FIFO.

#### **Double-Packet Buffering**

If the size of the transmit endpoint's FIFO is at least twice the maximum packet size for this endpoint, two packets can be buffered in the FIFO and double-packet buffering is allowed. As each packet is loaded into the transmit FIFO, the `TXRDY` bit in the **USBTXCSSLn** register must be set. If the `AUTOSET` bit in the **USBTXCSRHn** register is set, the `TXRDY` bit is automatically set when a maximum-sized packet is loaded into the FIFO. For packet sizes less than the maximum, `TXRDY` must be set manually. When the `TXRDY` bit is set, either manually or automatically, the packet is ready to be sent. After the first packet is loaded, `TXRDY` is immediately cleared and an interrupt is generated. A second packet can now be loaded into the transmit FIFO and `TXRDY` set again (either manually or automatically if the packet is the maximum size). At this point, both packets are ready to be sent. After each packet has been successfully sent, `TXRDY` is automatically cleared and the appropriate transmit endpoint interrupt signaled to indicate that another packet can now be loaded into the transmit FIFO. The state of the `FIFONE` bit in the **USBTXCSSLn** register at this point indicates how many packets may be loaded. If the `FIFONE` bit is set, then another packet is in the FIFO and only one more packet can be loaded. If the `FIFONE` bit is clear, then no packets are in the FIFO and two more packets can be loaded.

**Note:** Double-packet buffering is disabled if an endpoint's corresponding `EPn` bit is set in the **USB Transmit Double Packet Buffer Disable (USBTXDPKTBUFDIS)** register. This bit is set by default, so it must be cleared to enable double-packet buffering.

### **20.3.1.3 OUT Transactions as a Device**

When in Device mode, OUT transactions are handled through the USB controller receive FIFOs. The sizes of the receive FIFOs for the 15 configurable OUT endpoints are determined by the **USB Receive FIFO Start Address (USBRXFIFOADD)** register. The maximum amount of data received by an endpoint in any packet is determined by the value written to the **USB Maximum Receive Data Endpoint n (USBRXMAXPn)** register for that endpoint. When double-packet buffering is enabled, two data packets can be buffered in the FIFO. When double-packet buffering is disabled, only one packet can be buffered even if the packet is less than half the FIFO size.

**Note:** In all cases, the maximum packet size must not exceed the FIFO size.

#### **Single-Packet Buffering**

If the size of the receive endpoint FIFO is less than twice the maximum packet size for an endpoint, only one data packet can be buffered in the FIFO and single-packet buffering is required. When a packet is received and placed in the receive FIFO, the `RXRDY` and `FULL` bits in the **USB Receive Control and Status Endpoint n Low (USBRXCSSLn)** register are set and the appropriate receive endpoint is signaled, indicating that a packet can now be unloaded from the FIFO. After the packet has been unloaded, the `RXRDY` bit must be cleared in order to allow further packets to be received. This action also generates the acknowledge signaling to the Host controller. If the `AUTOCL` bit in the **USB Receive Control and Status Endpoint n High (USBRXCSRHn)** register is set and a maximum-sized packet is unloaded from the FIFO, the `RXRDY` and `FULL` bits are cleared automatically. For packet sizes less than the maximum, `RXRDY` must be cleared manually.

#### **Double-Packet Buffering**

If the size of the receive endpoint FIFO is at least twice the maximum packet size for the endpoint, two data packets can be buffered and double-packet buffering can be used. When the first packet is received and loaded into the receive FIFO, the `RXRDY` bit in the **USBRXCSSLn** register is set



and the appropriate receive endpoint interrupt is signaled to indicate that a packet can now be unloaded from the FIFO.

**Note:** The `FULL` bit in `USBRXCSSLn` is not set when the first packet is received. It is only set if a second packet is received and loaded into the receive FIFO.

After each packet has been unloaded, the `RXRDY` bit must be cleared to allow further packets to be received. If the `AUTOCL` bit in the `USBRXCSSLn` register is set and a maximum-sized packet is unloaded from the FIFO, the `RXRDY` bit is cleared automatically. For packet sizes less than the maximum, `RXRDY` must be cleared manually. If the `FULL` bit is set when `RXRDY` is cleared, the USB controller first clears the `FULL` bit, then sets `RXRDY` again to indicate that there is another packet waiting in the FIFO to be unloaded.

**Note:** Double-packet buffering is disabled if an endpoint's corresponding `EPn` bit is set in the **USB Receive Double Packet Buffer Disable (USBRXDPKTBUFDIS)** register. This bit is set by default, so it must be cleared to enable double-packet buffering.

#### 20.3.1.4 Scheduling

The Device has no control over the scheduling of transactions as scheduling is determined by the Host controller. The Stellaris® USB controller can set up a transaction at any time. The USB controller waits for the request from the Host controller and generates an interrupt when the transaction is complete or if it was terminated due to some error. If the Host controller makes a request and the Device controller is not ready, the USB controller sends a busy response (NAK) to all requests until it is ready.

#### 20.3.1.5 Additional Actions

The USB controller responds automatically to certain conditions on the USB bus or actions by the Host controller such as when the USB controller automatically stalls a control transfer or unexpected zero length OUT data packets.

##### ***Stalled Control Transfer***

The USB controller automatically issues a STALL handshake to a control transfer under the following conditions:

1. The Host sends more data during an OUT data phase of a control transfer than was specified in the Device request during the SETUP phase. This condition is detected by the USB controller when the Host sends an OUT token (instead of an IN token) after the last OUT packet has been unloaded and the `DATAEND` bit in the **USB Control and Status Endpoint 0 Low (USBCSRL0)** register has been set.
2. The Host requests more data during an IN data phase of a control transfer than was specified in the Device request during the SETUP phase. This condition is detected by the USB controller when the Host sends an IN token (instead of an OUT token) after the CPU has cleared `TXRDY` and set `DATAEND` in response to the ACK issued by the Host to what should have been the last packet.
3. The Host sends more than `USBRXMAXPn` bytes of data with an OUT data token.
4. The Host sends more than a zero length data packet for the OUT STATUS phase.

### **Zero Length OUT Data Packets**

A zero-length OUT data packet is used to indicate the end of a control transfer. In normal operation, such packets should only be received after the entire length of the Device request has been transferred.

However, if the Host sends a zero-length OUT data packet before the entire length of Device request has been transferred, it is signaling the premature end of the transfer. In this case, the USB controller automatically flushes any IN token ready for the data phase from the FIFO and sets the `DATAEND` bit in the `USBCSRL0` register.

### **Setting the Device Address**

When a Host is attempting to enumerate the USB Device, it requests that the Device change its address from zero to some other value. The address is changed by writing the value that the Host requested to the **USB Device Functional Address (USBFADDR)** register. However, care should be taken when writing to `USBFADDR` to avoid changing the address before the transaction is complete. This register should only be set after the `SET_ADDRESS` command is complete. Like all control transactions, the transaction is only complete after the Device has left the `STATUS` phase. In the case of a `SET_ADDRESS` command, the transaction is completed by responding to the IN request from the Host with a zero-byte packet. Once the Device has responded to the IN request, the `USBFADDR` register should be programmed to the new value as soon as possible to avoid missing any new commands sent to the new address.

**Note:** If the `USBFADDR` register is set to the new value as soon as the Device receives the OUT transaction with the `SET_ADDRESS` command in the packet, it changes the address during the control transfer. In this case, the Device does not receive the IN request that allows the USB transaction to exit the `STATUS` phase of the control transfer because it is sent to the old address. As a result, the Host does not get a response to the IN request, and the Host fails to enumerate the Device.

## **20.3.1.6 Device Mode SUSPEND**

When no activity has occurred on the USB bus for 3 ms, the USB controller automatically enters `SUSPEND` mode. If the `SUSPEND` interrupt has been enabled in the **USB Interrupt Enable (USBIE)** register, an interrupt is generated at this time. When in `SUSPEND` mode, the PHY also goes into `SUSPEND` mode. When `RESUME` signaling is detected, the USB controller exits `SUSPEND` mode and takes the PHY out of `SUSPEND`. If the `RESUME` interrupt is enabled, an interrupt is generated. The USB controller can also be forced to exit `SUSPEND` mode by setting the `RESUME` bit in the **USB Power (USBPOWER)** register. When this bit is set, the USB controller exits `SUSPEND` mode and drives `RESUME` signaling onto the bus. The `RESUME` bit must be cleared after 10 ms (a maximum of 15 ms) to end `RESUME` signaling.

To meet USB power requirements, the controller can be put into Deep Sleep mode which keeps the controller in a static state.

## **20.3.1.7 Start-of-Frame**

When the USB controller is operating in Device mode, it receives a Start-Of-Frame (SOF) packet from the Host once every millisecond. When the SOF packet is received, the 11-bit frame number contained in the packet is written into the **USB Frame Value (USBFRAME)** register, and an SOF interrupt is also signaled and can be handled by the application. Once the USB controller has started to receive SOF packets, it expects one every millisecond. If no SOF packet is received after 1.00358 ms, the packet is assumed to have been lost, and the `USBFRAME` register is not updated. The USB controller continues and resynchronizes these pulses to the received SOF packets when these packets are successfully received again.

### 20.3.1.8 USB RESET

When the USB controller is in Device mode and a RESET condition is detected on the USB bus, the USB controller automatically performs the following actions:

- Clears the **USBFADDR** register.
- Clears the **USB Endpoint Index (USBEPIDX)** register.
- Flushes all endpoint FIFOs.
- Clears all control/status registers.
- Enables all endpoint interrupts.
- Generates a RESET interrupt.

When the application software driving the USB controller receives a RESET interrupt, any open pipes are closed and the USB controller waits for bus enumeration to begin.

### 20.3.1.9 Connect/Disconnect

The USB controller connection to the USB bus is handled by software. The USB PHY can be switched between normal mode and non-driving mode by setting or clearing the **SOFTCONN** bit of the **USBPOWER** register. When the **SOFTCONN** bit is set, the PHY is placed in its normal mode, and the **USB0DP/USB0DM** lines of the USB bus are enabled. At the same time, the USB controller is placed into a state, in which it does not respond to any USB signaling except a USB RESET.

When the **SOFTCONN** bit is cleared, the PHY is put into non-driving mode, **USB0DP** and **USB0DM** are tristated, and the USB controller appears to other devices on the USB bus as if it has been disconnected. The non-driving mode is the default so the USB controller appears disconnected until the **SOFTCONN** bit has been set. The application software can then choose when to set the PHY into its normal mode. Systems with a lengthy initialization procedure may use this to ensure that initialization is complete, and the system is ready to perform enumeration before connecting to the USB bus. Once the **SOFTCONN** bit has been set, the USB controller can be disconnected by clearing this bit.

**Note:** The USB controller does not generate an interrupt when the Device is connected to the Host. However, an interrupt is generated when the Host terminates a session.

## 20.3.2 Operation as a Host

When the Stellaris® USB controller is operating in Host mode, it can either be used for point-to-point communications with another USB device or, when attached to a hub, for communication with multiple devices. Before the USB controller's operating mode is changed from Host to Device or Device to Host, software must reset the USB controller by setting the **USB0** bit in the **Software Reset Control 2 (SRCR2)** register (see page 207). Full-speed and low-speed USB devices are supported, both for point-to-point communication and for operation through a hub. The USB controller automatically carries out the necessary transaction translation needed to allow a low-speed or full-speed device to be used with a USB 2.0 hub. Control, bulk, isochronous, and interrupt transactions are supported. This section describes the USB controller's actions when it is being used as a USB Host. Configuration of IN endpoints, OUT endpoints, entry into and exit from SUSPEND mode, and RESET are all described.

When in Host mode, IN transactions are controlled by an endpoint's receive interface. All IN transactions use the receive endpoint registers and all OUT endpoints use the transmit endpoint

registers for a given endpoint. As in Device mode, the FIFOs for endpoints should take into account the maximum packet size for an endpoint.

- **Bulk.** Bulk endpoints should be the size of the maximum packet (up to 64 bytes) or twice the maximum packet size if double buffering is used (described further in the following section).
- **Interrupt.** Interrupt endpoints should be the size of the maximum packet (up to 64 bytes) or twice the maximum packet size if double buffering is used.
- **Isochronous.** Isochronous endpoints are more flexible and can be up to 1023 bytes.
- **Control.** It is also possible to specify a separate control endpoint to communicate with a Device. However, in most cases the USB controller should use the dedicated control endpoint to communicate with a Device's endpoint 0.

### 20.3.2.1 Endpoints

The endpoint registers are used to control the USB endpoint interfaces which communicate with Device(s) that are connected. The endpoints consist of a dedicated control IN endpoint, a dedicated control OUT endpoint, 15 configurable OUT endpoints, and 15 configurable IN endpoints.

The dedicated control interface can only be used for control transactions to endpoint 0 of Devices. These control transactions are used during enumeration or other control functions that communicate using endpoint 0 of Devices. This control endpoint shares the first 64 bytes of the USB controller's FIFO RAM for IN and OUT transactions. The remaining IN and OUT interfaces can be configured to communicate with control, bulk, interrupt, or isochronous Device endpoints.

These USB interfaces can be used to simultaneously schedule as many as 15 independent OUT and 15 independent IN transactions to any endpoints on any Device. The IN and OUT controls are paired in three sets of registers. However, they can be configured to communicate with different types of endpoints and different endpoints on Devices. For example, the first pair of endpoint controls can be split so that the OUT portion is communicating with a Device's bulk OUT endpoint 1, while the IN portion is communicating with a Device's interrupt IN endpoint 2.

Before accessing any Device, whether for point-to-point communications or for communications via a hub, the relevant **USB Receive Functional Address Endpoint n (USBRXFUNCADDRn)** or **USB Transmit Functional Address Endpoint n (USBTXFUNCADDRn)** registers must be set for each receive or transmit endpoint to record the address of the Device being accessed.

The USB controller also supports connections to Devices through a USB hub by providing a register that specifies the hub address and port of each USB transfer. The FIFO address and size are customizable and can be specified for each USB IN and OUT transfer. Customization includes allowing one FIFO per transaction, sharing a FIFO across transactions, and allowing for double-buffered FIFOs.

### 20.3.2.2 IN Transactions as a Host

IN transactions are handled in a similar manner to the way in which OUT transactions are handled when the USB controller is in Device mode except that the transaction first must be initiated by setting the `REQPKT` bit in the **USBCSRL0** register, indicating to the transaction scheduler that there is an active transaction on this endpoint. The transaction scheduler then sends an IN token to the target Device. When the packet is received and placed in the receive FIFO, the `RXRDY` bit in the **USBCSRL0** register is set, and the appropriate receive endpoint interrupt is signaled to indicate that a packet can now be unloaded from the FIFO.

When the packet has been unloaded, `RXRDY` must be cleared. The `AUTOCL` bit in the **USBXCSRHn** register can be used to have `RXRDY` automatically cleared when a maximum-sized packet has been

unloaded from the FIFO. The `AUTORQ` bit in **USBXCSRHn** causes the `REQPKT` bit to be automatically set when the `RXRDY` bit is cleared. The `AUTOCL` and `AUTORQ` bits can be used with  $\mu$ DMA accesses to perform complete bulk transfers without main processor intervention. When the `RXRDY` bit is cleared, the controller sends an acknowledge to the Device. When there is a known number of packets to be transferred, the **USB Request Packet Count in Block Transfer Endpoint n (USBRQPKTCOUNTn)** register associated with the endpoint should be configured to the number of packets to be transferred. The USB controller decrements the value in the **USBRQPKTCOUNTn** register following each request. When the **USBRQPKTCOUNTn** value decrements to 0, the `AUTORQ` bit is cleared to prevent any further transactions being attempted. For cases where the size of the transfer is unknown, **USBRQPKTCOUNTn** should be cleared. `AUTORQ` then remains set until cleared by the reception of a short packet (that is, less than the `MAXLOAD` value in the **USBXMAXPn** register) such as may occur at the end of a bulk transfer.

If the Device responds to a bulk or interrupt IN token with a NAK, the USB Host controller keeps retrying the transaction until any NAK Limit that has been set has been reached. If the target Device responds with a STALL, however, the USB Host controller does not retry the transaction but sets the `STALLED` bit in the **USBCSRL0** register. If the target Device does not respond to the IN token within the required time, or the packet contained a CRC or bit-stuff error, the USB Host controller retries the transaction. If after three attempts the target Device has still not responded, the USB Host controller clears the `REQPKT` bit and sets the `ERROR` bit in the **USBCSRL0** register.

### 20.3.2.3 OUT Transactions as a Host

OUT transactions are handled in a similar manner to the way in which IN transactions are handled when the USB controller is in Device mode. The `TXRDY` bit in the **USBTXCSSLn** register must be set as each packet is loaded into the transmit FIFO. Again, setting the `AUTOSET` bit in the **USBTXCSRHn** register automatically sets `TXRDY` when a maximum-sized packet has been loaded into the FIFO. Furthermore, `AUTOSET` can be used with the  $\mu$ DMA controller to perform complete bulk transfers without software intervention.

If the target Device responds to the OUT token with a NAK, the USB Host controller keeps retrying the transaction until the NAK Limit that has been set has been reached. However, if the target Device responds with a STALL, the USB controller does not retry the transaction but interrupts the main processor by setting the `STALLED` bit in the **USBTXCSSLn** register. If the target Device does not respond to the OUT token within the required time, or the packet contained a CRC or bit-stuff error, the USB Host controller retries the transaction. If after three attempts the target Device has still not responded, the USB controller flushes the FIFO and sets the `ERROR` bit in the **USBTXCSSLn** register.

### 20.3.2.4 Transaction Scheduling

Scheduling of transactions is handled automatically by the USB Host controller. The Host controller allows configuration of the endpoint communication scheduling based on the type of endpoint transaction. Interrupt transactions can be scheduled to occur in the range of every frame to every 255 frames in 1 frame increments. Bulk endpoints do not allow scheduling parameters, but do allow for a NAK timeout in the event an endpoint on a Device is not responding. Isochronous endpoints can be scheduled from every frame to every  $2^{16}$  frames, in powers of 2.

The USB controller maintains a frame counter. If the target Device is a full-speed device, the USB controller automatically sends an SOF packet at the start of each frame and increments the frame counter. If the target Device is a low-speed device, a *K* state is transmitted on the bus to act as a *keep-alive* to stop the low-speed device from going into SUSPEND mode.

After the SOF packet has been transmitted, the USB Host controller cycles through all the configured endpoints looking for active transactions. An active transaction is defined as a receive endpoint for

which the `REQPKT` bit is set or a transmit endpoint for which the `TXRDY` bit and/or the `FIFONE` bit is set.

An isochronous or interrupt transaction is started if the transaction is found on the first scheduler cycle of a frame and if the interval counter for that endpoint has counted down to zero. As a result, only one interrupt or isochronous transaction occurs per endpoint every `n` frames, where `n` is the interval set via the **USB Host Transmit Interval Endpoint `n` (`USBTXINTERVALn`)** or **USB Host Receive Interval Endpoint `n` (`USBRXINTERVALn`)** register for that endpoint.

An active bulk transaction starts immediately, provided sufficient time is left in the frame to complete the transaction before the next SOF packet is due. If the transaction must be retried (for example, because a NAK was received or the target Device did not respond), then the transaction is not retried until the transaction scheduler has first checked all the other endpoints for active transactions. This process ensures that an endpoint that is sending a lot of NAKs does not block other transactions on the bus. The controller also allows the user to specify a limit to the length of time for NAKs to be received from a target Device before the endpoint times out.

### 20.3.2.5 USB Hubs

The following setup requirements apply to the USB Host controller only if it is used with a USB hub. When a full- or low-speed Device is connected to the USB controller via a USB 2.0 hub, details of the hub address and the hub port also must be recorded in the corresponding **USB Receive Hub Address Endpoint `n` (`USBRXHUBADDRn`)** and **USB Receive Hub Port Endpoint `n` (`USBRXHUBPORTn`)** or the **USB Transmit Hub Address Endpoint `n` (`USBTXHUBADDRn`)** and **USB Transmit Hub Port Endpoint `n` (`USBTXHUBPORTn`)** registers. In addition, the speed at which the Device operates (full or low) must be recorded in the **USB Type Endpoint 0 (`USBTTYPE0`)** (endpoint 0), **USB Host Configure Transmit Type Endpoint `n` (`USBTXTYPEn`)**, or **USB Host Configure Receive Type Endpoint `n` (`USBRXTYPEn`)** registers for each endpoint that is accessed by the Device.

For hub communications, the settings in these registers record the current allocation of the endpoints to the attached USB Devices. To maximize the number of Devices supported, the USB Host controller allows this allocation to be changed dynamically by simply updating the address and speed information recorded in these registers. Any changes in the allocation of endpoints to Device functions must be made following the completion of any on-going transactions on the endpoints affected.

### 20.3.2.6 Babble

The USB Host controller does not start a transaction until the bus has been inactive for at least the minimum inter-packet delay. The controller also does not start a transaction unless it can be finished before the end of the frame. If the bus is still active at the end of a frame, then the USB Host controller assumes that the target Device to which it is connected has malfunctioned, and the USB controller suspends all transactions and generates a babble interrupt.

### 20.3.2.7 Host SUSPEND

If the `SUSPEND` bit in the **USBPOWER** register is set, the USB Host controller completes the current transaction then stops the transaction scheduler and frame counter. No further transactions are started and no SOF packets are generated.

To exit `SUSPEND` mode, set the `RESUME` bit and clear the `SUSPEND` bit. While the `RESUME` bit is set, the USB Host controller generates `RESUME` signaling on the bus. After 20 ms, the `RESUME` bit must be cleared, at which point the frame counter and transaction scheduler start. The Host supports the detection of a remote wake-up.

### 20.3.2.8 USB RESET

If the `RESET` bit in the **USBPOWER** register is set, the USB Host controller generates USB RESET signaling on the bus. The `RESET` bit must be set for at least 20 ms to ensure correct resetting of the target Device. After the CPU has cleared the bit, the USB Host controller starts its frame counter and transaction scheduler.

### 20.3.2.9 Connect/Disconnect

A session is started by setting the `SESSION` bit in the **USB Device Control (USBDEVCTL)** register, enabling the USB controller to wait for a Device to be connected. When a Device is detected, a connect interrupt is generated. The speed of the Device that has been connected can be determined by reading the **USBDEVCTL** register where the `FSDEV` bit is set for a full-speed Device, and the `LSDEV` bit is set for a low-speed Device. The USB controller must generate a RESET to the Device, and then the USB Host controller can begin Device enumeration. If the Device is disconnected while a session is in progress, a disconnect interrupt is generated.

## 20.3.3 OTG Mode

To conserve power, the USB On-The-Go (OTG) supplement allows VBUS to only be powered up when required and to be turned off when the bus is not in use. VBUS is always supplied by the A device on the bus. The USB OTG controller determines whether it is the A device or the B device by sampling the ID input from the PHY. This signal is pulled Low when an A-type plug is sensed (signifying that the USB OTG controller should act as the A device) but taken High when a B-type plug is sensed (signifying that the USB controller is a B device). Note that when switching between OTG A and OTG B, the USB controller retains all register contents.

### 20.3.3.1 Starting a Session

When the USB OTG controller is ready to start a session, the `SESSION` bit must be set in the **USBDEVCTL** register. The USB OTG controller then enables ID pin sensing. The ID input is either taken Low if an A-type connection is detected or High if a B-type connection is detected. The `DEV` bit in the **USBDEVCTL** register is also set to indicate whether the USB OTG controller has adopted the role of the A device or the B device. The USB OTG controller also provides an interrupt to indicate that ID pin sensing has completed and the mode value in the **USBDEVCTL** register is valid. This interrupt is enabled in the **USBIDVIM** register, and the status is checked in the **USBIDVISC** register. As soon as the USB controller has detected that it is on the A side of the cable, it must enable VBUS power within 100ms or the USB controller reverts to device mode.

If the USB OTG controller is the A device, then the USB OTG controller enters Host mode (the A device is always the default Host), turns on VBUS, and waits for VBUS to go above the VBUS Valid threshold, as indicated by the `VBUS` bit in the **USBDEVCTL** register going to 0x3. The USB OTG controller then waits for a peripheral to be connected. When a peripheral is detected, a Connect interrupt is signaled and either the `FSDEV` or `LSDEV` bit in the **USBDEVCTL** register is set, depending whether a full-speed or a low-speed peripheral is detected. The USB controller then issues a RESET to the connected Device. The `SESSION` bit in the **USBDEVCTL** register can be cleared to end a session. The USB OTG controller also automatically ends the session if babble is detected or if VBUS drops below session valid.

**Note:** The USB OTG controller may not remain in Host mode when connected to high-current devices. Some devices draw enough current to momentarily drop VBUS below the VBUS-valid level causing the controller to drop out of Host mode. The only way to get back into Host mode is to allow VBUS to go below the Session End level. In this situation, the device is causing VBUS to drop repeatedly and pull VBUS back low the next time VBUS is enabled.

In addition, the USB OTG controller may not remain in Host mode when a device is told that it can start using its active configuration. At this point the device starts drawing more current and can also drop VBUS below VBUS valid.

If the USB OTG controller is the B device, then the USB OTG controller requests a session using the session request protocol defined in the USB On-The-Go supplement, that is, it first discharges VBUS. Then when VBUS has gone below the Session End threshold (VBUS bit in the **USBDEVCTL** register goes to 0x0) and the line state has been a single-ended zero for > 2 ms, the USB OTG controller pulses the data line, then pulses VBUS. At the end of the session, the **SESSION** bit is cleared either by the USB OTG controller or by the application software. The USB OTG controller then causes the PHY to switch out the pull-up resistor on D+, signaling the A device to end the session.

### 20.3.3.2 Detecting Activity

When the other device of the OTG set-up wishes to start a session, it either raises VBUS above the Session Valid threshold if it is the A device, or if it is the B device, it pulses the data line then pulses VBUS. Depending on which of these actions happens, the USB controller can determine whether it is the A device or the B device in the current set-up and act accordingly. If VBUS is raised above the Session Valid threshold, then the USB controller is the B device. The USB controller sets the **SESSION** bit in the **USBDEVCTL** register. When RESET signaling is detected on the bus, a RESET interrupt is signaled, which is interpreted as the start of a session.

The USB controller is in Device mode as the B device is the default mode. At the end of the session, the A device turns off the power to VBUS. When VBUS drops below the Session Valid threshold, the USB controller detects this drop and clears the **SESSION** bit to indicate that the session has ended, causing a disconnect interrupt to be signaled. If data line and VBUS pulsing is detected, then the USB controller is the A device. The controller generates a **SESSION REQUEST** interrupt to indicate that the B device is requesting a session. The **SESSION** bit in the **USBDEVCTL** register must be set to start a session.

### 20.3.3.3 Host Negotiation

When the USB controller is the A device, ID is Low, and the controller automatically enters Host mode when a session starts. When the USB controller is the B device, ID is High, and the controller automatically enters Device mode when a session starts. However, software can request that the USB controller become the Host by setting the **HOSTREQ** bit in the **USBDEVCTL** register. This bit can be set either at the same time as requesting a Session Start by setting the **SESSION** bit in the **USBDEVCTL** register or at any time after a session has started. When the USB controller next enters SUSPEND mode and if the **HOSTREQ** bit remains set, the controller enters Host mode and begins host negotiation (as specified in the USB On-The-Go supplement) by causing the PHY to disconnect the pull-up resistor on the D+ line, causing the A device to switch to Device mode and connect its own pull-up resistor. When the USB controller detects this, a Connect interrupt is generated and the **RESET** bit in the **USBPOWER** register is set to begin resetting the A device. The USB controller begins this reset sequence automatically to ensure that RESET is started as required within 1 ms of the A device connecting its pull-up resistor. The main processor should wait at least 20 ms, then clear the **RESET** bit and enumerate the A device.

When the USB OTG controller B device has finished using the bus, the USB controller goes into SUSPEND mode by setting the **SUSPEND** bit in the **USBPOWER** register. The A device detects this and either terminates the session or reverts to Host mode. If the A device is USB OTG controller, it generates a Disconnect interrupt.



### 20.3.4 DMA Operation

The USB peripheral provides an interface connected to the  $\mu$ DMA controller with separate channels for 3 transmit endpoints and 3 receive endpoints. Software selects which endpoints to service with the  $\mu$ DMA channels using the **USB DMA Select (USBDMASEL)** register. The  $\mu$ DMA operation of the USB is enabled through the **USBTXCSRHn** and **USBRXCSRHn** registers, for the TX and RX channels respectively. When  $\mu$ DMA operation is enabled, the USB asserts a  $\mu$ DMA request on the enabled receive or transmit channel when the associated FIFO can transfer data. When either FIFO can transfer data, the burst request for that channel is asserted. The  $\mu$ DMA channel must be configured to operate in Basic mode, and the size of the  $\mu$ DMA transfer must be restricted to whole multiples of the size of the USB FIFO. Both read and write transfers of the USB FIFOs using  $\mu$ DMA must be configured in this manner. For example, if the USB endpoint is configured with a FIFO size of 64 bytes, the  $\mu$ DMA channel can be used to transfer 64 bytes to or from the endpoint FIFO. If the number of bytes to transfer is less than 64, then a programmed I/O method must be used to copy the data to or from the FIFO.

If the **DMAMOD** bit in the **USBTXCSRHn/USBRXCSRHn** register is clear, an interrupt is generated after every packet is transferred, but the  $\mu$ DMA continues transferring data. If the **DMAMOD** bit is set, an interrupt is generated only when the entire  $\mu$ DMA transfer is complete. The interrupt occurs on the USB interrupt vector. Therefore, if interrupts are used for USB operation and the  $\mu$ DMA is enabled, the USB interrupt handler must be designed to handle the  $\mu$ DMA completion interrupt.

Care must be taken when using the  $\mu$ DMA to unload the receive FIFO as data is read from the receive FIFO in 4 byte chunks regardless of value of the **MAXLOAD** field in the **USBRXCSRHn** register. The **RXRDY** bit is cleared as follows.

**Table 20-3. Remainder (RxMaxP/4)**

Value	Description
0	MAXLOAD = 64 bytes
1	MAXLOAD = 61 bytes
2	MAXLOAD = 62 bytes
3	MAXLOAD = 63 bytes

**Table 20-4. Actual Bytes Read**

Value	Description
0	MAXLOAD
1	MAXLOAD+3
2	MAXLOAD+2
3	MAXLOAD+1

**Table 20-5. Packet Sizes That Clear RXRDY**

Value	Description
0	MAXLOAD, MAXLOAD-1, MAXLOAD-2, MAXLOAD-3
1	MAXLOAD
2	MAXLOAD, MAXLOAD-1
3	MAXLOAD, MAXLOAD-1, MAXLOAD-2

To enable DMA operation for the endpoint receive channel, the `DMAEN` bit of the **USB<sub>RXC</sub>SRH<sub>n</sub>** register should be set. To enable DMA operation for the endpoint transmit channel, the `DMAEN` bit of the **USB<sub>TXC</sub>SRH<sub>n</sub>** register must be set.

See “Micro Direct Memory Access (μDMA)” on page 246 for more details about programming the μDMA controller.

## 20.4 Initialization and Configuration

To use the USB Controller, the peripheral clock must be enabled by via the **RCGC2** register (see page 193). In addition, the clock to the appropriate GPIO module must be enabled via the **RCGC2** register in the System Control module (see page 193). To find out which GPIO port to enable, refer to Table 25-4 on page 1151. Configure the `PMCn` fields in the **GPIOPCTL** register to assign the USB signals to the appropriate pins (see page 346 and Table 25-5 on page 1160).

The initial configuration in all cases requires that the processor enable the USB controller and USB controller’s physical layer interface (PHY) before setting any registers. The next step is to enable the USB PLL so that the correct clocking is provided to the PHY. To ensure that voltage is not supplied to the bus incorrectly, the external power control signal, `USB0EPEN`, should be negated on start up by configuring the `USB0EPEN` and `USB0PFLT` pins to be controlled by the USB controller and not exhibit their default GPIO behavior.

**Note:** When used in OTG mode, `USB0VBUS` and `USB0ID` do not require any configuration as they are dedicated pins for the USB controller and directly connect to the USB connector’s VBUS and ID signals. If the USB controller is used as either a dedicated Host or Device, the `DEVMODOTG` and `DEVMOD` bits in the **USB General-Purpose Control and Status (USBGPCS)** register can be used to connect the `USB0VBUS` and `USB0ID` inputs to fixed levels internally, freeing the `PB0` and `PB1` pins for GPIO use. For proper self-powered Device operation, the VBUS value must still be monitored to assure that if the Host removes VBUS, the self-powered Device disables the D+/D- pull-up resistors. This function can be accomplished by connecting a standard GPIO to VBUS.

### 20.4.1 Pin Configuration

When using the Device controller portion of the USB controller in a system that also provides Host functionality, the power to VBUS must be disabled to allow the external Host controller to supply power. Usually, the `USB0EPEN` signal is used to control the external regulator and should be negated to avoid having two devices driving the `USB0VBUS` power pin on the USB connector.

When the USB controller is acting as a Host, it is in control of two signals that are attached to an external voltage supply that provides power to VBUS. The Host controller uses the `USB0EPEN` signal to enable or disable power to the `USB0VBUS` pin on the USB connector. An input pin, `USB0PFLT`, provides feedback when there has been a power fault on VBUS. The `USB0PFLT` signal can be configured to either automatically negate the `USB0EPEN` signal to disable power, and/or it can generate an interrupt to the interrupt controller to allow software to handle the power fault condition. The polarity and actions related to both `USB0EPEN` and `USB0PFLT` are fully configurable in the USB controller. The controller also provides interrupts on Device insertion and removal to allow the Host controller code to respond to these external events.

### 20.4.2 Endpoint Configuration

To start communication in Host or Device mode, the endpoint registers must first be configured. In Host mode, this configuration establishes a connection between an endpoint register and an endpoint on a Device. In Device mode, an endpoint must be configured before enumerating to the Host controller.

In both cases, the endpoint 0 configuration is limited because it is a fixed-function, fixed-FIFO-size endpoint. In Device and Host modes, the endpoint requires little setup but does require a software-based state machine to progress through the setup, data, and status phases of a standard control transaction. In Device mode, the configuration of the remaining endpoints is done once before enumerating and then only changed if an alternate configuration is selected by the Host controller. In Host mode, the endpoints must be configured to operate as control, bulk, interrupt or isochronous mode. Once the type of endpoint is configured, a FIFO area must be assigned to each endpoint. In the case of bulk, control and interrupt endpoints, each has a maximum of 64 bytes per transaction. Isochronous endpoints can have packets with up to 1023 bytes per packet. In either mode, the maximum packet size for the given endpoint must be set prior to sending or receiving data.

Configuring each endpoint's FIFO involves reserving a portion of the overall USB FIFO RAM to each endpoint. The total FIFO RAM available is 4 Kbytes with the first 64 bytes reserved for endpoint 0. The endpoint's FIFO must be at least as large as the maximum packet size. The FIFO can also be configured as a double-buffered FIFO so that interrupts occur at the end of each packet and allow filling the other half of the FIFO.

If operating as a Device, the USB Device controller's soft connect must be enabled when the Device is ready to start communications, indicating to the Host controller that the Device is ready to start the enumeration process. If operating as a Host controller, the Device soft connect must be disabled and power must be provided to VBUS via the USB0EPEN signal.

## 20.5 Register Map

Table 20-6 on page 891 lists the registers. All addresses given are relative to the USB base address of 0x4005.0000. Note that the USB controller clock must be enabled before the registers can be programmed (see page 193).

**Table 20-6. Universal Serial Bus (USB) Controller Register Map**

Offset	Name	Type	Reset	Description	See page
0x000	USBFADDR	R/W	0x00	USB Device Functional Address	903
0x001	USBPOWER	R/W	0x20	USB Power	904
0x002	USBTXIS	RO	0x0000	USB Transmit Interrupt Status	907
0x004	USBRXIS	RO	0x0000	USB Receive Interrupt Status	909
0x006	USBTXIE	R/W	0xFFFF	USB Transmit Interrupt Enable	911
0x008	USBRXIE	R/W	0xFFFE	USB Receive Interrupt Enable	913
0x00A	USBIS	RO	0x00	USB General Interrupt Status	915
0x00B	USBIE	R/W	0x06	USB Interrupt Enable	918
0x00C	USBFFRAME	RO	0x0000	USB Frame Value	921
0x00E	USBEPIDX	R/W	0x00	USB Endpoint Index	922
0x00F	USBTTEST	R/W	0x00	USB Test Mode	923
0x020	USBFIFO0	R/W	0x0000.0000	USB FIFO Endpoint 0	925
0x024	USBFIFO1	R/W	0x0000.0000	USB FIFO Endpoint 1	925
0x028	USBFIFO2	R/W	0x0000.0000	USB FIFO Endpoint 2	925

Table 20-6. Universal Serial Bus (USB) Controller Register Map (continued)

Offset	Name	Type	Reset	Description	See page
0x02C	USBFIFO3	R/W	0x0000.0000	USB FIFO Endpoint 3	925
0x030	USBFIFO4	R/W	0x0000.0000	USB FIFO Endpoint 4	925
0x034	USBFIFO5	R/W	0x0000.0000	USB FIFO Endpoint 5	925
0x038	USBFIFO6	R/W	0x0000.0000	USB FIFO Endpoint 6	925
0x03C	USBFIFO7	R/W	0x0000.0000	USB FIFO Endpoint 7	925
0x040	USBFIFO8	R/W	0x0000.0000	USB FIFO Endpoint 8	925
0x044	USBFIFO9	R/W	0x0000.0000	USB FIFO Endpoint 9	925
0x048	USBFIFO10	R/W	0x0000.0000	USB FIFO Endpoint 10	925
0x04C	USBFIFO11	R/W	0x0000.0000	USB FIFO Endpoint 11	925
0x050	USBFIFO12	R/W	0x0000.0000	USB FIFO Endpoint 12	925
0x054	USBFIFO13	R/W	0x0000.0000	USB FIFO Endpoint 13	925
0x058	USBFIFO14	R/W	0x0000.0000	USB FIFO Endpoint 14	925
0x05C	USBFIFO15	R/W	0x0000.0000	USB FIFO Endpoint 15	925
0x060	USBDEVCTL	R/W	0x80	USB Device Control	927
0x062	USBTXFIFOSZ	R/W	0x00	USB Transmit Dynamic FIFO Sizing	929
0x063	USBRXFIFOSZ	R/W	0x00	USB Receive Dynamic FIFO Sizing	929
0x064	USBTXFIFOADD	R/W	0x0000	USB Transmit FIFO Start Address	930
0x066	USBRXFIFOADD	R/W	0x0000	USB Receive FIFO Start Address	930
0x07A	USBCONTIM	R/W	0x5C	USB Connect Timing	931
0x07B	USBVPLEN	R/W	0x3C	USB OTG VBUS Pulse Timing	932
0x07D	USBFSEOF	R/W	0x77	USB Full-Speed Last Transaction to End of Frame Timing	933
0x07E	USBLSEOF	R/W	0x72	USB Low-Speed Last Transaction to End of Frame Timing	934
0x080	USBTXFUNCADDR0	R/W	0x00	USB Transmit Functional Address Endpoint 0	935
0x082	USBTXHUBADDR0	R/W	0x00	USB Transmit Hub Address Endpoint 0	937
0x083	USBTXHUBPORT0	R/W	0x00	USB Transmit Hub Port Endpoint 0	939
0x088	USBTXFUNCADDR1	R/W	0x00	USB Transmit Functional Address Endpoint 1	935
0x08A	USBTXHUBADDR1	R/W	0x00	USB Transmit Hub Address Endpoint 1	937
0x08B	USBTXHUBPORT1	R/W	0x00	USB Transmit Hub Port Endpoint 1	939
0x08C	USBRXFUNCADDR1	R/W	0x00	USB Receive Functional Address Endpoint 1	941
0x08E	USBRXHUBADDR1	R/W	0x00	USB Receive Hub Address Endpoint 1	943
0x08F	USBRXHUBPORT1	R/W	0x00	USB Receive Hub Port Endpoint 1	945

Table 20-6. Universal Serial Bus (USB) Controller Register Map (continued)

Offset	Name	Type	Reset	Description	See page
0x090	USBTXFUNCADDR2	R/W	0x00	USB Transmit Functional Address Endpoint 2	935
0x092	USBTXHUBADDR2	R/W	0x00	USB Transmit Hub Address Endpoint 2	937
0x093	USBTXHUBPORT2	R/W	0x00	USB Transmit Hub Port Endpoint 2	939
0x094	USBRXFUNCADDR2	R/W	0x00	USB Receive Functional Address Endpoint 2	941
0x096	USBRXHUBADDR2	R/W	0x00	USB Receive Hub Address Endpoint 2	943
0x097	USBRXHUBPORT2	R/W	0x00	USB Receive Hub Port Endpoint 2	945
0x098	USBTXFUNCADDR3	R/W	0x00	USB Transmit Functional Address Endpoint 3	935
0x09A	USBTXHUBADDR3	R/W	0x00	USB Transmit Hub Address Endpoint 3	937
0x09B	USBTXHUBPORT3	R/W	0x00	USB Transmit Hub Port Endpoint 3	939
0x09C	USBRXFUNCADDR3	R/W	0x00	USB Receive Functional Address Endpoint 3	941
0x09E	USBRXHUBADDR3	R/W	0x00	USB Receive Hub Address Endpoint 3	943
0x09F	USBRXHUBPORT3	R/W	0x00	USB Receive Hub Port Endpoint 3	945
0x0A0	USBTXFUNCADDR4	R/W	0x00	USB Transmit Functional Address Endpoint 4	935
0x0A2	USBTXHUBADDR4	R/W	0x00	USB Transmit Hub Address Endpoint 4	937
0x0A3	USBTXHUBPORT4	R/W	0x00	USB Transmit Hub Port Endpoint 4	939
0x0A4	USBRXFUNCADDR4	R/W	0x00	USB Receive Functional Address Endpoint 4	941
0x0A6	USBRXHUBADDR4	R/W	0x00	USB Receive Hub Address Endpoint 4	943
0x0A7	USBRXHUBPORT4	R/W	0x00	USB Receive Hub Port Endpoint 4	945
0x0A8	USBTXFUNCADDR5	R/W	0x00	USB Transmit Functional Address Endpoint 5	935
0x0AA	USBTXHUBADDR5	R/W	0x00	USB Transmit Hub Address Endpoint 5	937
0x0AB	USBTXHUBPORT5	R/W	0x00	USB Transmit Hub Port Endpoint 5	939
0x0AC	USBRXFUNCADDR5	R/W	0x00	USB Receive Functional Address Endpoint 5	941
0x0AE	USBRXHUBADDR5	R/W	0x00	USB Receive Hub Address Endpoint 5	943
0x0AF	USBRXHUBPORT5	R/W	0x00	USB Receive Hub Port Endpoint 5	945
0x0B0	USBTXFUNCADDR6	R/W	0x00	USB Transmit Functional Address Endpoint 6	935
0x0B2	USBTXHUBADDR6	R/W	0x00	USB Transmit Hub Address Endpoint 6	937
0x0B3	USBTXHUBPORT6	R/W	0x00	USB Transmit Hub Port Endpoint 6	939
0x0B4	USBRXFUNCADDR6	R/W	0x00	USB Receive Functional Address Endpoint 6	941
0x0B6	USBRXHUBADDR6	R/W	0x00	USB Receive Hub Address Endpoint 6	943
0x0B7	USBRXHUBPORT6	R/W	0x00	USB Receive Hub Port Endpoint 6	945
0x0B8	USBTXFUNCADDR7	R/W	0x00	USB Transmit Functional Address Endpoint 7	935
0x0BA	USBTXHUBADDR7	R/W	0x00	USB Transmit Hub Address Endpoint 7	937

Table 20-6. Universal Serial Bus (USB) Controller Register Map (continued)

Offset	Name	Type	Reset	Description	See page
0x0BB	USBTXHUBPORT7	R/W	0x00	USB Transmit Hub Port Endpoint 7	939
0x0BC	USBRXFUNCADDR7	R/W	0x00	USB Receive Functional Address Endpoint 7	941
0x0BE	USBRXHUBADDR7	R/W	0x00	USB Receive Hub Address Endpoint 7	943
0x0BF	USBRXHUBPORT7	R/W	0x00	USB Receive Hub Port Endpoint 7	945
0x0C0	USBTXFUNCADDR8	R/W	0x00	USB Transmit Functional Address Endpoint 8	935
0x0C2	USBTXHUBADDR8	R/W	0x00	USB Transmit Hub Address Endpoint 8	937
0x0C3	USBTXHUBPORT8	R/W	0x00	USB Transmit Hub Port Endpoint 8	939
0x0C4	USBRXFUNCADDR8	R/W	0x00	USB Receive Functional Address Endpoint 8	941
0x0C6	USBRXHUBADDR8	R/W	0x00	USB Receive Hub Address Endpoint 8	943
0x0C7	USBRXHUBPORT8	R/W	0x00	USB Receive Hub Port Endpoint 8	945
0x0C8	USBTXFUNCADDR9	R/W	0x00	USB Transmit Functional Address Endpoint 9	935
0x0CA	USBTXHUBADDR9	R/W	0x00	USB Transmit Hub Address Endpoint 9	937
0x0CB	USBTXHUBPORT9	R/W	0x00	USB Transmit Hub Port Endpoint 9	939
0x0CC	USBRXFUNCADDR9	R/W	0x00	USB Receive Functional Address Endpoint 9	941
0x0CE	USBRXHUBADDR9	R/W	0x00	USB Receive Hub Address Endpoint 9	943
0x0CF	USBRXHUBPORT9	R/W	0x00	USB Receive Hub Port Endpoint 9	945
0x0D0	USBTXFUNCADDR10	R/W	0x00	USB Transmit Functional Address Endpoint 10	935
0x0D2	USBTXHUBADDR10	R/W	0x00	USB Transmit Hub Address Endpoint 10	937
0x0D3	USBTXHUBPORT10	R/W	0x00	USB Transmit Hub Port Endpoint 10	939
0x0D4	USBRXFUNCADDR10	R/W	0x00	USB Receive Functional Address Endpoint 10	941
0x0D6	USBRXHUBADDR10	R/W	0x00	USB Receive Hub Address Endpoint 10	943
0x0D7	USBRXHUBPORT10	R/W	0x00	USB Receive Hub Port Endpoint 10	945
0x0D8	USBTXFUNCADDR11	R/W	0x00	USB Transmit Functional Address Endpoint 11	935
0x0DA	USBTXHUBADDR11	R/W	0x00	USB Transmit Hub Address Endpoint 11	937
0x0DB	USBTXHUBPORT11	R/W	0x00	USB Transmit Hub Port Endpoint 11	939
0x0DC	USBRXFUNCADDR11	R/W	0x00	USB Receive Functional Address Endpoint 11	941
0x0DE	USBRXHUBADDR11	R/W	0x00	USB Receive Hub Address Endpoint 11	943
0x0DF	USBRXHUBPORT11	R/W	0x00	USB Receive Hub Port Endpoint 11	945
0x0E0	USBTXFUNCADDR12	R/W	0x00	USB Transmit Functional Address Endpoint 12	935
0x0E2	USBTXHUBADDR12	R/W	0x00	USB Transmit Hub Address Endpoint 12	937
0x0E3	USBTXHUBPORT12	R/W	0x00	USB Transmit Hub Port Endpoint 12	939
0x0E4	USBRXFUNCADDR12	R/W	0x00	USB Receive Functional Address Endpoint 12	941

Table 20-6. Universal Serial Bus (USB) Controller Register Map (continued)

Offset	Name	Type	Reset	Description	See page
0x0E6	USBRXHUBADDR12	R/W	0x00	USB Receive Hub Address Endpoint 12	943
0x0E7	USBRXHUBPORT12	R/W	0x00	USB Receive Hub Port Endpoint 12	945
0x0E8	USBTXFUNCADDR13	R/W	0x00	USB Transmit Functional Address Endpoint 13	935
0x0EA	USBTXHUBADDR13	R/W	0x00	USB Transmit Hub Address Endpoint 13	937
0x0EB	USBTXHUBPORT13	R/W	0x00	USB Transmit Hub Port Endpoint 13	939
0x0EC	USBRXFUNCADDR13	R/W	0x00	USB Receive Functional Address Endpoint 13	941
0x0EE	USBRXHUBADDR13	R/W	0x00	USB Receive Hub Address Endpoint 13	943
0x0EF	USBRXHUBPORT13	R/W	0x00	USB Receive Hub Port Endpoint 13	945
0x0F0	USBTXFUNCADDR14	R/W	0x00	USB Transmit Functional Address Endpoint 14	935
0x0F2	USBTXHUBADDR14	R/W	0x00	USB Transmit Hub Address Endpoint 14	937
0x0F3	USBTXHUBPORT14	R/W	0x00	USB Transmit Hub Port Endpoint 14	939
0x0F4	USBRXFUNCADDR14	R/W	0x00	USB Receive Functional Address Endpoint 14	941
0x0F6	USBRXHUBADDR14	R/W	0x00	USB Receive Hub Address Endpoint 14	943
0x0F7	USBRXHUBPORT14	R/W	0x00	USB Receive Hub Port Endpoint 14	945
0x0F8	USBTXFUNCADDR15	R/W	0x00	USB Transmit Functional Address Endpoint 15	935
0x0FA	USBTXHUBADDR15	R/W	0x00	USB Transmit Hub Address Endpoint 15	937
0x0FB	USBTXHUBPORT15	R/W	0x00	USB Transmit Hub Port Endpoint 15	939
0x0FC	USBRXFUNCADDR15	R/W	0x00	USB Receive Functional Address Endpoint 15	941
0x0FE	USBRXHUBADDR15	R/W	0x00	USB Receive Hub Address Endpoint 15	943
0x0FF	USBRXHUBPORT15	R/W	0x00	USB Receive Hub Port Endpoint 15	945
0x102	USBCSRL0	W1C	0x00	USB Control and Status Endpoint 0 Low	949
0x103	USBCSRH0	W1C	0x00	USB Control and Status Endpoint 0 High	953
0x108	USBCOUNT0	RO	0x00	USB Receive Byte Count Endpoint 0	955
0x10A	USBTTYPE0	R/W	0x00	USB Type Endpoint 0	956
0x10B	USBNAKLMT	R/W	0x00	USB NAK Limit	957
0x110	USBTXMAXP1	R/W	0x0000	USB Maximum Transmit Data Endpoint 1	947
0x112	USBTXCSSL1	R/W	0x00	USB Transmit Control and Status Endpoint 1 Low	958
0x113	USBTXCDSRH1	R/W	0x00	USB Transmit Control and Status Endpoint 1 High	963
0x114	USBRXMAXP1	R/W	0x0000	USB Maximum Receive Data Endpoint 1	967
0x116	USBRXCSSL1	R/W	0x00	USB Receive Control and Status Endpoint 1 Low	969
0x117	USBRXCDSRH1	R/W	0x00	USB Receive Control and Status Endpoint 1 High	974
0x118	USBRXCOUNT1	RO	0x0000	USB Receive Byte Count Endpoint 1	979

Table 20-6. Universal Serial Bus (USB) Controller Register Map (continued)

Offset	Name	Type	Reset	Description	See page
0x11A	USBTXTYPE1	R/W	0x00	USB Host Transmit Configure Type Endpoint 1	981
0x11B	USBTXINTERVAL1	R/W	0x00	USB Host Transmit Interval Endpoint 1	983
0x11C	USBRXTYPE1	R/W	0x00	USB Host Configure Receive Type Endpoint 1	985
0x11D	USBRXINTERVAL1	R/W	0x00	USB Host Receive Polling Interval Endpoint 1	987
0x120	USBTXMAXP2	R/W	0x0000	USB Maximum Transmit Data Endpoint 2	947
0x122	USBTXCURL2	R/W	0x00	USB Transmit Control and Status Endpoint 2 Low	958
0x123	USBTXCSRH2	R/W	0x00	USB Transmit Control and Status Endpoint 2 High	963
0x124	USBRXMAXP2	R/W	0x0000	USB Maximum Receive Data Endpoint 2	967
0x126	USBRXCURL2	R/W	0x00	USB Receive Control and Status Endpoint 2 Low	969
0x127	USBRXCSRH2	R/W	0x00	USB Receive Control and Status Endpoint 2 High	974
0x128	USBRXCOUNT2	RO	0x0000	USB Receive Byte Count Endpoint 2	979
0x12A	USBTXTYPE2	R/W	0x00	USB Host Transmit Configure Type Endpoint 2	981
0x12B	USBTXINTERVAL2	R/W	0x00	USB Host Transmit Interval Endpoint 2	983
0x12C	USBRXTYPE2	R/W	0x00	USB Host Configure Receive Type Endpoint 2	985
0x12D	USBRXINTERVAL2	R/W	0x00	USB Host Receive Polling Interval Endpoint 2	987
0x130	USBTXMAXP3	R/W	0x0000	USB Maximum Transmit Data Endpoint 3	947
0x132	USBTXCURL3	R/W	0x00	USB Transmit Control and Status Endpoint 3 Low	958
0x133	USBTXCSRH3	R/W	0x00	USB Transmit Control and Status Endpoint 3 High	963
0x134	USBRXMAXP3	R/W	0x0000	USB Maximum Receive Data Endpoint 3	967
0x136	USBRXCURL3	R/W	0x00	USB Receive Control and Status Endpoint 3 Low	969
0x137	USBRXCSRH3	R/W	0x00	USB Receive Control and Status Endpoint 3 High	974
0x138	USBRXCOUNT3	RO	0x0000	USB Receive Byte Count Endpoint 3	979
0x13A	USBTXTYPE3	R/W	0x00	USB Host Transmit Configure Type Endpoint 3	981
0x13B	USBTXINTERVAL3	R/W	0x00	USB Host Transmit Interval Endpoint 3	983
0x13C	USBRXTYPE3	R/W	0x00	USB Host Configure Receive Type Endpoint 3	985
0x13D	USBRXINTERVAL3	R/W	0x00	USB Host Receive Polling Interval Endpoint 3	987
0x140	USBTXMAXP4	R/W	0x0000	USB Maximum Transmit Data Endpoint 4	947
0x142	USBTXCURL4	R/W	0x00	USB Transmit Control and Status Endpoint 4 Low	958
0x143	USBTXCSRH4	R/W	0x00	USB Transmit Control and Status Endpoint 4 High	963
0x144	USBRXMAXP4	R/W	0x0000	USB Maximum Receive Data Endpoint 4	967
0x146	USBRXCURL4	R/W	0x00	USB Receive Control and Status Endpoint 4 Low	969
0x147	USBRXCSRH4	R/W	0x00	USB Receive Control and Status Endpoint 4 High	974



Table 20-6. Universal Serial Bus (USB) Controller Register Map (continued)

Offset	Name	Type	Reset	Description	See page
0x148	USBRXCOUNT4	RO	0x0000	USB Receive Byte Count Endpoint 4	979
0x14A	USBTXTYPE4	R/W	0x00	USB Host Transmit Configure Type Endpoint 4	981
0x14B	USBTXINTERVAL4	R/W	0x00	USB Host Transmit Interval Endpoint 4	983
0x14C	USBRXTYPE4	R/W	0x00	USB Host Configure Receive Type Endpoint 4	985
0x14D	USBRXINTERVAL4	R/W	0x00	USB Host Receive Polling Interval Endpoint 4	987
0x150	USBTXMAXP5	R/W	0x0000	USB Maximum Transmit Data Endpoint 5	947
0x152	USBTXCURL5	R/W	0x00	USB Transmit Control and Status Endpoint 5 Low	958
0x153	USBTXCSRH5	R/W	0x00	USB Transmit Control and Status Endpoint 5 High	963
0x154	USBRXMAXP5	R/W	0x0000	USB Maximum Receive Data Endpoint 5	967
0x156	USBRXCURL5	R/W	0x00	USB Receive Control and Status Endpoint 5 Low	969
0x157	USBRXCSRH5	R/W	0x00	USB Receive Control and Status Endpoint 5 High	974
0x158	USBRXCOUNT5	RO	0x0000	USB Receive Byte Count Endpoint 5	979
0x15A	USBTXTYPE5	R/W	0x00	USB Host Transmit Configure Type Endpoint 5	981
0x15B	USBTXINTERVAL5	R/W	0x00	USB Host Transmit Interval Endpoint 5	983
0x15C	USBRXTYPE5	R/W	0x00	USB Host Configure Receive Type Endpoint 5	985
0x15D	USBRXINTERVAL5	R/W	0x00	USB Host Receive Polling Interval Endpoint 5	987
0x160	USBTXMAXP6	R/W	0x0000	USB Maximum Transmit Data Endpoint 6	947
0x162	USBTXCURL6	R/W	0x00	USB Transmit Control and Status Endpoint 6 Low	958
0x163	USBTXCSRH6	R/W	0x00	USB Transmit Control and Status Endpoint 6 High	963
0x164	USBRXMAXP6	R/W	0x0000	USB Maximum Receive Data Endpoint 6	967
0x166	USBRXCURL6	R/W	0x00	USB Receive Control and Status Endpoint 6 Low	969
0x167	USBRXCSRH6	R/W	0x00	USB Receive Control and Status Endpoint 6 High	974
0x168	USBRXCOUNT6	RO	0x0000	USB Receive Byte Count Endpoint 6	979
0x16A	USBTXTYPE6	R/W	0x00	USB Host Transmit Configure Type Endpoint 6	981
0x16B	USBTXINTERVAL6	R/W	0x00	USB Host Transmit Interval Endpoint 6	983
0x16C	USBRXTYPE6	R/W	0x00	USB Host Configure Receive Type Endpoint 6	985
0x16D	USBRXINTERVAL6	R/W	0x00	USB Host Receive Polling Interval Endpoint 6	987
0x170	USBTXMAXP7	R/W	0x0000	USB Maximum Transmit Data Endpoint 7	947
0x172	USBTXCURL7	R/W	0x00	USB Transmit Control and Status Endpoint 7 Low	958
0x173	USBTXCSRH7	R/W	0x00	USB Transmit Control and Status Endpoint 7 High	963
0x174	USBRXMAXP7	R/W	0x0000	USB Maximum Receive Data Endpoint 7	967
0x176	USBRXCURL7	R/W	0x00	USB Receive Control and Status Endpoint 7 Low	969

**Table 20-6. Universal Serial Bus (USB) Controller Register Map (continued)**

Offset	Name	Type	Reset	Description	See page
0x177	USBRXCSRH7	R/W	0x00	USB Receive Control and Status Endpoint 7 High	974
0x178	USBRXCOUNT7	RO	0x0000	USB Receive Byte Count Endpoint 7	979
0x17A	USBTXTYPE7	R/W	0x00	USB Host Transmit Configure Type Endpoint 7	981
0x17B	USBTXINTERVAL7	R/W	0x00	USB Host Transmit Interval Endpoint 7	983
0x17C	USBRXTYPE7	R/W	0x00	USB Host Configure Receive Type Endpoint 7	985
0x17D	USBRXINTERVAL7	R/W	0x00	USB Host Receive Polling Interval Endpoint 7	987
0x180	USBTXMAXP8	R/W	0x0000	USB Maximum Transmit Data Endpoint 8	947
0x182	USBTXCSSL8	R/W	0x00	USB Transmit Control and Status Endpoint 8 Low	958
0x183	USBTXCSSL8	R/W	0x00	USB Transmit Control and Status Endpoint 8 High	963
0x184	USBRXMAXP8	R/W	0x0000	USB Maximum Receive Data Endpoint 8	967
0x186	USBRXCSSL8	R/W	0x00	USB Receive Control and Status Endpoint 8 Low	969
0x187	USBRXCSSL8	R/W	0x00	USB Receive Control and Status Endpoint 8 High	974
0x188	USBRXCOUNT8	RO	0x0000	USB Receive Byte Count Endpoint 8	979
0x18A	USBTXTYPE8	R/W	0x00	USB Host Transmit Configure Type Endpoint 8	981
0x18B	USBTXINTERVAL8	R/W	0x00	USB Host Transmit Interval Endpoint 8	983
0x18C	USBRXTYPE8	R/W	0x00	USB Host Configure Receive Type Endpoint 8	985
0x18D	USBRXINTERVAL8	R/W	0x00	USB Host Receive Polling Interval Endpoint 8	987
0x190	USBTXMAXP9	R/W	0x0000	USB Maximum Transmit Data Endpoint 9	947
0x192	USBTXCSSL9	R/W	0x00	USB Transmit Control and Status Endpoint 9 Low	958
0x193	USBTXCSSL9	R/W	0x00	USB Transmit Control and Status Endpoint 9 High	963
0x194	USBRXMAXP9	R/W	0x0000	USB Maximum Receive Data Endpoint 9	967
0x196	USBRXCSSL9	R/W	0x00	USB Receive Control and Status Endpoint 9 Low	969
0x197	USBRXCSSL9	R/W	0x00	USB Receive Control and Status Endpoint 9 High	974
0x198	USBRXCOUNT9	RO	0x0000	USB Receive Byte Count Endpoint 9	979
0x19A	USBTXTYPE9	R/W	0x00	USB Host Transmit Configure Type Endpoint 9	981
0x19B	USBTXINTERVAL9	R/W	0x00	USB Host Transmit Interval Endpoint 9	983
0x19C	USBRXTYPE9	R/W	0x00	USB Host Configure Receive Type Endpoint 9	985
0x19D	USBRXINTERVAL9	R/W	0x00	USB Host Receive Polling Interval Endpoint 9	987
0x1A0	USBTXMAXP10	R/W	0x0000	USB Maximum Transmit Data Endpoint 10	947
0x1A2	USBTXCSSL10	R/W	0x00	USB Transmit Control and Status Endpoint 10 Low	958
0x1A3	USBTXCSSL10	R/W	0x00	USB Transmit Control and Status Endpoint 10 High	963
0x1A4	USBRXMAXP10	R/W	0x0000	USB Maximum Receive Data Endpoint 10	967

Table 20-6. Universal Serial Bus (USB) Controller Register Map (continued)

Offset	Name	Type	Reset	Description	See page
0x1A6	USBRXCSRL10	R/W	0x00	USB Receive Control and Status Endpoint 10 Low	969
0x1A7	USBRXCsrH10	R/W	0x00	USB Receive Control and Status Endpoint 10 High	974
0x1A8	USBRXCOUNT10	RO	0x0000	USB Receive Byte Count Endpoint 10	979
0x1AA	USBTXTYPE10	R/W	0x00	USB Host Transmit Configure Type Endpoint 10	981
0x1AB	USBTXINTERVAL10	R/W	0x00	USB Host Transmit Interval Endpoint 10	983
0x1AC	USBRXTYPE10	R/W	0x00	USB Host Configure Receive Type Endpoint 10	985
0x1AD	USBRXINTERVAL10	R/W	0x00	USB Host Receive Polling Interval Endpoint 10	987
0x1B0	USBTXMAXP11	R/W	0x0000	USB Maximum Transmit Data Endpoint 11	947
0x1B2	USBTXCSRL11	R/W	0x00	USB Transmit Control and Status Endpoint 11 Low	958
0x1B3	USBTXCsrH11	R/W	0x00	USB Transmit Control and Status Endpoint 11 High	963
0x1B4	USBRXMAXP11	R/W	0x0000	USB Maximum Receive Data Endpoint 11	967
0x1B6	USBRXCSRL11	R/W	0x00	USB Receive Control and Status Endpoint 11 Low	969
0x1B7	USBRXCsrH11	R/W	0x00	USB Receive Control and Status Endpoint 11 High	974
0x1B8	USBRXCOUNT11	RO	0x0000	USB Receive Byte Count Endpoint 11	979
0x1BA	USBTXTYPE11	R/W	0x00	USB Host Transmit Configure Type Endpoint 11	981
0x1BB	USBTXINTERVAL11	R/W	0x00	USB Host Transmit Interval Endpoint 11	983
0x1BC	USBRXTYPE11	R/W	0x00	USB Host Configure Receive Type Endpoint 11	985
0x1BD	USBRXINTERVAL11	R/W	0x00	USB Host Receive Polling Interval Endpoint 11	987
0x1C0	USBTXMAXP12	R/W	0x0000	USB Maximum Transmit Data Endpoint 12	947
0x1C2	USBTXCSRL12	R/W	0x00	USB Transmit Control and Status Endpoint 12 Low	958
0x1C3	USBTXCsrH12	R/W	0x00	USB Transmit Control and Status Endpoint 12 High	963
0x1C4	USBRXMAXP12	R/W	0x0000	USB Maximum Receive Data Endpoint 12	967
0x1C6	USBRXCSRL12	R/W	0x00	USB Receive Control and Status Endpoint 12 Low	969
0x1C7	USBRXCsrH12	R/W	0x00	USB Receive Control and Status Endpoint 12 High	974
0x1C8	USBRXCOUNT12	RO	0x0000	USB Receive Byte Count Endpoint 12	979
0x1CA	USBTXTYPE12	R/W	0x00	USB Host Transmit Configure Type Endpoint 12	981
0x1CB	USBTXINTERVAL12	R/W	0x00	USB Host Transmit Interval Endpoint 12	983
0x1CC	USBRXTYPE12	R/W	0x00	USB Host Configure Receive Type Endpoint 12	985
0x1CD	USBRXINTERVAL12	R/W	0x00	USB Host Receive Polling Interval Endpoint 12	987
0x1D0	USBTXMAXP13	R/W	0x0000	USB Maximum Transmit Data Endpoint 13	947
0x1D2	USBTXCSRL13	R/W	0x00	USB Transmit Control and Status Endpoint 13 Low	958
0x1D3	USBTXCsrH13	R/W	0x00	USB Transmit Control and Status Endpoint 13 High	963

Table 20-6. Universal Serial Bus (USB) Controller Register Map (continued)

Offset	Name	Type	Reset	Description	See page
0x1D4	USBRXMAXP13	R/W	0x0000	USB Maximum Receive Data Endpoint 13	967
0x1D6	USBRXCSSL13	R/W	0x00	USB Receive Control and Status Endpoint 13 Low	969
0x1D7	USBRXCSSL13	R/W	0x00	USB Receive Control and Status Endpoint 13 High	974
0x1D8	USBRXCOUNT13	RO	0x0000	USB Receive Byte Count Endpoint 13	979
0x1DA	USBTXTYPE13	R/W	0x00	USB Host Transmit Configure Type Endpoint 13	981
0x1DB	USBTXINTERVAL13	R/W	0x00	USB Host Transmit Interval Endpoint 13	983
0x1DC	USBRXTYPE13	R/W	0x00	USB Host Configure Receive Type Endpoint 13	985
0x1DD	USBRXINTERVAL13	R/W	0x00	USB Host Receive Polling Interval Endpoint 13	987
0x1E0	USBTXMAXP14	R/W	0x0000	USB Maximum Transmit Data Endpoint 14	947
0x1E2	USBTXCSSL14	R/W	0x00	USB Transmit Control and Status Endpoint 14 Low	958
0x1E3	USBTXCSSL14	R/W	0x00	USB Transmit Control and Status Endpoint 14 High	963
0x1E4	USBRXMAXP14	R/W	0x0000	USB Maximum Receive Data Endpoint 14	967
0x1E6	USBRXCSSL14	R/W	0x00	USB Receive Control and Status Endpoint 14 Low	969
0x1E7	USBRXCSSL14	R/W	0x00	USB Receive Control and Status Endpoint 14 High	974
0x1E8	USBRXCOUNT14	RO	0x0000	USB Receive Byte Count Endpoint 14	979
0x1EA	USBTXTYPE14	R/W	0x00	USB Host Transmit Configure Type Endpoint 14	981
0x1EB	USBTXINTERVAL14	R/W	0x00	USB Host Transmit Interval Endpoint 14	983
0x1EC	USBRXTYPE14	R/W	0x00	USB Host Configure Receive Type Endpoint 14	985
0x1ED	USBRXINTERVAL14	R/W	0x00	USB Host Receive Polling Interval Endpoint 14	987
0x1F0	USBTXMAXP15	R/W	0x0000	USB Maximum Transmit Data Endpoint 15	947
0x1F2	USBTXCSSL15	R/W	0x00	USB Transmit Control and Status Endpoint 15 Low	958
0x1F3	USBTXCSSL15	R/W	0x00	USB Transmit Control and Status Endpoint 15 High	963
0x1F4	USBRXMAXP15	R/W	0x0000	USB Maximum Receive Data Endpoint 15	967
0x1F6	USBRXCSSL15	R/W	0x00	USB Receive Control and Status Endpoint 15 Low	969
0x1F7	USBRXCSSL15	R/W	0x00	USB Receive Control and Status Endpoint 15 High	974
0x1F8	USBRXCOUNT15	RO	0x0000	USB Receive Byte Count Endpoint 15	979
0x1FA	USBTXTYPE15	R/W	0x00	USB Host Transmit Configure Type Endpoint 15	981
0x1FB	USBTXINTERVAL15	R/W	0x00	USB Host Transmit Interval Endpoint 15	983
0x1FC	USBRXTYPE15	R/W	0x00	USB Host Configure Receive Type Endpoint 15	985
0x1FD	USBRXINTERVAL15	R/W	0x00	USB Host Receive Polling Interval Endpoint 15	987
0x304	USBRQPKTCOUNT1	R/W	0x0000	USB Request Packet Count in Block Transfer Endpoint 1	989

Table 20-6. Universal Serial Bus (USB) Controller Register Map (continued)

Offset	Name	Type	Reset	Description	See page
0x308	USBRQPKTCOUNT2	R/W	0x0000	USB Request Packet Count in Block Transfer Endpoint 2	989
0x30C	USBRQPKTCOUNT3	R/W	0x0000	USB Request Packet Count in Block Transfer Endpoint 3	989
0x310	USBRQPKTCOUNT4	R/W	0x0000	USB Request Packet Count in Block Transfer Endpoint 4	989
0x314	USBRQPKTCOUNT5	R/W	0x0000	USB Request Packet Count in Block Transfer Endpoint 5	989
0x318	USBRQPKTCOUNT6	R/W	0x0000	USB Request Packet Count in Block Transfer Endpoint 6	989
0x31C	USBRQPKTCOUNT7	R/W	0x0000	USB Request Packet Count in Block Transfer Endpoint 7	989
0x320	USBRQPKTCOUNT8	R/W	0x0000	USB Request Packet Count in Block Transfer Endpoint 8	989
0x324	USBRQPKTCOUNT9	R/W	0x0000	USB Request Packet Count in Block Transfer Endpoint 9	989
0x328	USBRQPKTCOUNT10	R/W	0x0000	USB Request Packet Count in Block Transfer Endpoint 10	989
0x32C	USBRQPKTCOUNT11	R/W	0x0000	USB Request Packet Count in Block Transfer Endpoint 11	989
0x330	USBRQPKTCOUNT12	R/W	0x0000	USB Request Packet Count in Block Transfer Endpoint 12	989
0x334	USBRQPKTCOUNT13	R/W	0x0000	USB Request Packet Count in Block Transfer Endpoint 13	989
0x338	USBRQPKTCOUNT14	R/W	0x0000	USB Request Packet Count in Block Transfer Endpoint 14	989
0x33C	USBRQPKTCOUNT15	R/W	0x0000	USB Request Packet Count in Block Transfer Endpoint 15	989
0x340	USBRXDPKTBUFDIS	R/W	0x0000	USB Receive Double Packet Buffer Disable	991
0x342	USBTXDPKTBUFDIS	R/W	0x0000	USB Transmit Double Packet Buffer Disable	993
0x400	USBEPCC	R/W	0x0000.0000	USB External Power Control	995
0x404	USBEPCCRIS	RO	0x0000.0000	USB External Power Control Raw Interrupt Status	998
0x408	USBEPCCIM	R/W	0x0000.0000	USB External Power Control Interrupt Mask	999
0x40C	USBEPCCISC	R/W	0x0000.0000	USB External Power Control Interrupt Status and Clear	1000
0x410	USBDRRIS	RO	0x0000.0000	USB Device RESUME Raw Interrupt Status	1001
0x414	USBDRIM	R/W	0x0000.0000	USB Device RESUME Interrupt Mask	1002
0x418	USBDRISC	W1C	0x0000.0000	USB Device RESUME Interrupt Status and Clear	1003
0x41C	USBGPCS	R/W	0x0000.0000	USB General-Purpose Control and Status	1004

Table 20-6. Universal Serial Bus (USB) Controller Register Map (continued)

Offset	Name	Type	Reset	Description	See page
0x430	USBVDC	R/W	0x0000.0000	USB VBUS Droop Control	1005
0x434	USBVDCRIS	RO	0x0000.0000	USB VBUS Droop Control Raw Interrupt Status	1006
0x438	USBVDCIM	R/W	0x0000.0000	USB VBUS Droop Control Interrupt Mask	1007
0x43C	USBVDCISC	R/W	0x0000.0000	USB VBUS Droop Control Interrupt Status and Clear	1008
0x444	USBIDVRIS	RO	0x0000.0000	USB ID Valid Detect Raw Interrupt Status	1009
0x448	USBIDVIM	R/W	0x0000.0000	USB ID Valid Detect Interrupt Mask	1010
0x44C	USBIDVISC	R/W1C	0x0000.0000	USB ID Valid Detect Interrupt Status and Clear	1011
0x450	USBDMASEL	R/W	0x0033.2211	USB DMA Select	1012

## 20.6 Register Descriptions

The LM3S9B96 USB controller has On-The-Go (OTG) capabilities as specified in the `USB0` bit field in the **DC6** register (see page 162).

**OTG B /  
Device**

This icon indicates that the register is used in OTG B or Device mode. Some registers are used for both Host and Device mode and may have different bit definitions depending on the mode.

**OTG A /  
Host**

This icon indicates that the register is used in OTG A or Host mode. Some registers are used for both Host and Device mode and may have different bit definitions depending on the mode. The USB controller is in OTG B or Device mode upon reset, so the reset values shown for these registers apply to the Device mode definition.

**OTG**

This icon indicates that the register is used for OTG-specific functions such as ID detection and negotiation. Once OTG negotiation is complete, then the USB controller registers are used according to their Host or Device mode meanings depending on whether the OTG negotiations made the USB controller OTG A (Host) or OTG B (Device).

### Register 1: USB Device Functional Address (USBFADDR), offset 0x000

OTG B /  
Device

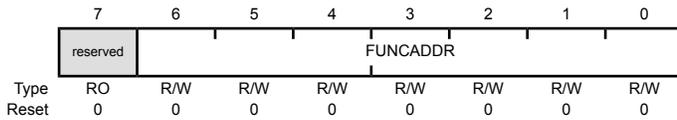
**USBFADDR** is an 8-bit register that contains the 7-bit address of the Device part of the transaction.

When the USB controller is being used in Device mode (the `HOST` bit in the **USBDEVCTL** register is clear), this register must be written with the address received through a `SET_ADDRESS` command, which is then used for decoding the function address in subsequent token packets.

**Important:** See the section called “Setting the Device Address” on page 882 for special considerations when writing this register.

#### USB Device Functional Address (USBFADDR)

Base 0x4005.0000  
Offset 0x000  
Type R/W, reset 0x00



Bit/Field	Name	Type	Reset	Description
7	reserved	RO	0	Software should not rely on the value of a reserved bit. To provide compatibility with future products, the value of a reserved bit should be preserved across a read-modify-write operation.
6:0	FUNCADDR	R/W	0x00	Function Address Function Address of Device as received through <code>SET_ADDRESS</code> .

## Register 2: USB Power (USBPOWER), offset 0x001

OTG A /  
Host

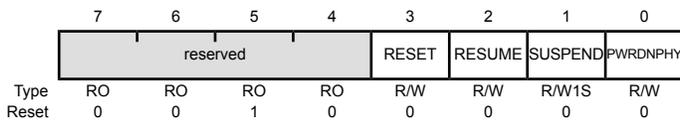
**USBPOWER** is an 8-bit register used for controlling SUSPEND and RESUME signaling and some basic operational aspects of the USB controller.

OTG B /  
Device

### OTG A / Host Mode

#### USB Power (USBPOWER)

Base 0x4005.0000  
Offset 0x001  
Type R/W, reset 0x20



Bit/Field	Name	Type	Reset	Description
7:4	reserved	RO	0x2	Software should not rely on the value of a reserved bit. To provide compatibility with future products, the value of a reserved bit should be preserved across a read-modify-write operation.
3	RESET	R/W	0	RESET Signaling  Value Description 1 Enables RESET signaling on the bus. 0 Ends RESET signaling on the bus.
2	RESUME	R/W	0	RESUME Signaling  Value Description 1 Enables RESUME signaling when the Device is in SUSPEND mode. 0 Ends RESUME signaling on the bus.  This bit must be cleared by software 20 ms after being set.
1	SUSPEND	R/W1S	0	SUSPEND Mode  Value Description 1 Enables SUSPEND mode. 0 No effect.



Bit/Field	Name	Type	Reset	Description
0	PWRDNPHY	R/W	0	Power Down PHY
				Value Description
				1 Powers down the internal USB PHY.
				0 No effect.

## OTG B / Device Mode

### USB Power (USBPOWER)

Base 0x4005.0000

Offset 0x001

Type R/W, reset 0x20

	7	6	5	4	3	2	1	0
Type	R/W	R/W	RO	RO	RO	R/W	RO	R/W
Reset	0	0	1	0	0	0	0	0

Bit/Field	Name	Type	Reset	Description
7	ISOUP	R/W	0	Isynchronous Update
				Value Description
				1 The USB controller waits for an SOF token from the time the <b>TXRDY</b> bit is set in the <b>USBTXCSSLn</b> register before sending the packet. If an IN token is received before an SOF token, then a zero-length data packet is sent.
				0 No effect.
				<b>Note:</b> This bit is only valid for isochronous transfers.
6	SOFTCONN	R/W	0	Soft Connect/Disconnect
				Value Description
				1 The USB D+/D- lines are enabled.
				0 The USB D+/D- lines are tri-stated.
5:4	reserved	RO	0x2	Software should not rely on the value of a reserved bit. To provide compatibility with future products, the value of a reserved bit should be preserved across a read-modify-write operation.
3	RESET	RO	0	RESET Signaling
				Value Description
				1 RESET signaling is present on the bus.
				0 RESET signaling is not present on the bus.

Bit/Field	Name	Type	Reset	Description
2	RESUME	R/W	0	RESUME Signaling  Value Description 1 Enables RESUME signaling when the Device is in SUSPEND mode. 0 Ends RESUME signaling on the bus.  This bit must be cleared by software 10 ms (a maximum of 15 ms) after being set.
1	SUSPEND	RO	0	SUSPEND Mode  Value Description 1 The USB controller is in SUSPEND mode. 0 This bit is cleared when software reads the interrupt register or sets the RESUME bit above.
0	PWRDNPHY	R/W	0	Power Down PHY  Value Description 1 Powers down the internal USB PHY. 0 No effect.

### Register 3: USB Transmit Interrupt Status (USBTXIS), offset 0x002

**Important:** Use caution when reading this register. Performing a read may change bit status.

OTG A /  
Host

**USBTXIS** is a 16-bit read-only register that indicates which interrupts are currently active for endpoint 0 and the transmit endpoints 1–15. The meaning of the  $EP_n$  bits in this register is based on the mode of the device. The  $EP_1$  through  $EP_{15}$  bits always indicate that the USB controller is sending data; however, in Host mode, the bits refer to OUT endpoints; while in Device mode, the bits refer to IN endpoints. The  $EP_0$  bit is special in Host and Device modes and indicates that either a control IN or control OUT endpoint has generated an interrupt.

OTG B /  
Device

**Note:** Bits relating to endpoints that have not been configured always return 0. Note also that all active interrupts are cleared when this register is read.

#### USB Transmit Interrupt Status (USBTXIS)

Base 0x4005.0000  
Offset 0x002  
Type RO, reset 0x0000

	15	14	13	12	11	10	9	8	7	6	5	4	3	2	1	0
Type	RO	RO	RO	RO	RO	RO	RO	RO	RO	RO	RO	RO	RO	RO	RO	RO
Reset	0	0	0	0	0	0	0	0	0	0	0	0	0	0	0	0

Bit/Field	Name	Type	Reset	Description
15	EP15	RO	0	TX Endpoint 15 Interrupt  Value Description 0 No interrupt. 1 The Endpoint 15 transmit interrupt is asserted.
14	EP14	RO	0	TX Endpoint 14 Interrupt Same description as EP15.
13	EP13	RO	0	TX Endpoint 13 Interrupt Same description as EP15.
12	EP12	RO	0	TX Endpoint 12 Interrupt Same description as EP15.
11	EP11	RO	0	TX Endpoint 11 Interrupt Same description as EP15.
10	EP10	RO	0	TX Endpoint 10 Interrupt Same description as EP15.
9	EP9	RO	0	TX Endpoint 9 Interrupt Same description as EP15.
8	EP8	RO	0	TX Endpoint 8 Interrupt Same description as EP15.

Bit/Field	Name	Type	Reset	Description
7	EP7	RO	0	TX Endpoint 7 Interrupt Same description as EP15.
6	EP6	RO	0	TX Endpoint 6 Interrupt Same description as EP15.
5	EP5	RO	0	TX Endpoint 5 Interrupt Same description as EP15.
4	EP4	RO	0	TX Endpoint 4 Interrupt Same description as EP15.
3	EP3	RO	0	TX Endpoint 3 Interrupt Same description as EP15.
2	EP2	RO	0	TX Endpoint 2 Interrupt Same description as EP15.
1	EP1	RO	0	TX Endpoint 1 Interrupt Same description as EP15.
0	EP0	RO	0	TX and RX Endpoint 0 Interrupt Same description as EP15.

## Register 4: USB Receive Interrupt Status (USBRXIS), offset 0x004

**Important:** Use caution when reading this register. Performing a read may change bit status.

OTG A /  
Host

**USBRXIS** is a 16-bit read-only register that indicates which of the interrupts for receive endpoints 1–15 are currently active.

**Note:** Bits relating to endpoints that have not been configured always return 0. Note also that all active interrupts are cleared when this register is read.

OTG B /  
Device

USB Receive Interrupt Status (USBRXIS)

Base 0x4005.0000  
Offset 0x004  
Type RO, reset 0x0000

	15	14	13	12	11	10	9	8	7	6	5	4	3	2	1	0
	EP15	EP14	EP13	EP12	EP11	EP10	EP9	EP8	EP7	EP6	EP5	EP4	EP3	EP2	EP1	reserved
Type	RO	RO	RO	RO	RO	RO	RO	RO	RO	RO	RO	RO	RO	RO	RO	RO
Reset	0	0	0	0	0	0	0	0	0	0	0	0	0	0	0	0

Bit/Field	Name	Type	Reset	Description
15	EP15	RO	0	RX Endpoint 15 Interrupt  Value Description 0 No interrupt. 1 The Endpoint 15 receive interrupt is asserted.
14	EP14	RO	0	RX Endpoint 14 Interrupt Same description as EP15.
13	EP13	RO	0	RX Endpoint 13 Interrupt Same description as EP15.
12	EP12	RO	0	RX Endpoint 12 Interrupt Same description as EP15.
11	EP11	RO	0	RX Endpoint 11 Interrupt Same description as EP15.
10	EP10	RO	0	RX Endpoint 10 Interrupt Same description as EP15.
9	EP9	RO	0	RX Endpoint 9 Interrupt Same description as EP15.
8	EP8	RO	0	RX Endpoint 8 Interrupt Same description as EP15.
7	EP7	RO	0	RX Endpoint 7 Interrupt Same description as EP15.
6	EP6	RO	0	RX Endpoint 6 Interrupt Same description as EP15.

Bit/Field	Name	Type	Reset	Description
5	EP5	RO	0	RX Endpoint 5 Interrupt Same description as EP15.
4	EP4	RO	0	RX Endpoint 4 Interrupt Same description as EP15.
3	EP3	RO	0	RX Endpoint 3 Interrupt Same description as EP15.
2	EP2	RO	0	RX Endpoint 2 Interrupt Same description as EP15.
1	EP1	RO	0	RX Endpoint 1 Interrupt Same description as EP15.
0	reserved	RO	0	Software should not rely on the value of a reserved bit. To provide compatibility with future products, the value of a reserved bit should be preserved across a read-modify-write operation.

**Register 5: USB Transmit Interrupt Enable (USBTXIE), offset 0x006****OTG A /  
Host**

**USBTXIE** is a 16-bit register that provides interrupt enable bits for the interrupts in the **USBTXIS** register. When a bit is set, the USB interrupt is asserted to the interrupt controller when the corresponding interrupt bit in the **USBTXIS** register is set. When a bit is cleared, the interrupt in the **USBTXIS** register is still set but the USB interrupt to the interrupt controller is not asserted. On reset, all interrupts are enabled.

**OTG B /  
Device**

USB Transmit Interrupt Enable (USBTXIE)

Base 0x4005.0000

Offset 0x006

Type R/W, reset 0xFFFF

	15	14	13	12	11	10	9	8	7	6	5	4	3	2	1	0
	EP15	EP14	EP13	EP12	EP11	EP10	EP9	EP8	EP7	EP6	EP5	EP4	EP3	EP2	EP1	EP0
Type	R/W	R/W	R/W	R/W	R/W	R/W	R/W	R/W	R/W	R/W	R/W	R/W	R/W	R/W	R/W	R/W
Reset	1	1	1	1	1	1	1	1	1	1	1	1	1	1	1	1

Bit/Field	Name	Type	Reset	Description
15	EP15	R/W	1	TX Endpoint 15 Interrupt Enable
				Value Description
				1 An interrupt is sent to the interrupt controller when the EP15 bit in the <b>USBTXIS</b> register is set.
				0 The EP15 transmit interrupt is suppressed and not sent to the interrupt controller.
14	EP14	R/W	1	TX Endpoint 14 Interrupt Enable Same description as EP15.
13	EP13	R/W	1	TX Endpoint 13 Interrupt Enable Same description as EP15.
12	EP12	R/W	1	TX Endpoint 12 Interrupt Enable Same description as EP15.
11	EP11	R/W	1	TX Endpoint 11 Interrupt Enable Same description as EP15.
10	EP10	R/W	1	TX Endpoint 10 Interrupt Enable Same description as EP15.
9	EP9	R/W	1	TX Endpoint 9 Interrupt Enable Same description as EP15.
8	EP8	R/W	1	TX Endpoint 8 Interrupt Enable Same description as EP15.
7	EP7	R/W	1	TX Endpoint 7 Interrupt Enable Same description as EP15.
6	EP6	R/W	1	TX Endpoint 6 Interrupt Enable Same description as EP15.

Bit/Field	Name	Type	Reset	Description
5	EP5	R/W	1	TX Endpoint 5 Interrupt Enable Same description as EP15.
4	EP4	R/W	1	TX Endpoint 4 Interrupt Enable Same description as EP15.
3	EP3	R/W	1	TX Endpoint 3 Interrupt Enable Same description as EP15.
2	EP2	R/W	1	TX Endpoint 2 Interrupt Enable Same description as EP15.
1	EP1	R/W	1	TX Endpoint 1 Interrupt Enable Same description as EP15.
0	EP0	R/W	1	TX and RX Endpoint 0 Interrupt Enable Same description as EP15.



**Register 6: USB Receive Interrupt Enable (USBRXIE), offset 0x008**

OTG A /  
Host

**USBRXIE** is a 16-bit register that provides interrupt enable bits for the interrupts in the **USBRXIS** register. When a bit is set, the USB interrupt is asserted to the interrupt controller when the corresponding interrupt bit in the **USBRXIS** register is set. When a bit is cleared, the interrupt in the **USBRXIS** register is still set but the USB interrupt to the interrupt controller is not asserted. On reset, all interrupts are enabled.

OTG B /  
Device

USB Receive Interrupt Enable (USBRXIE)

Base 0x4005.0000

Offset 0x008

Type R/W, reset 0xFFFFE

	15	14	13	12	11	10	9	8	7	6	5	4	3	2	1	0
	EP15	EP14	EP13	EP12	EP11	EP10	EP9	EP8	EP7	EP6	EP5	EP4	EP3	EP2	EP1	reserved
Type	R/W	R/W	R/W	R/W	R/W	R/W	R/W	R/W	R/W	R/W	R/W	R/W	R/W	R/W	R/W	RO
Reset	1	1	1	1	1	1	1	1	1	1	1	1	1	1	1	0

Bit/Field	Name	Type	Reset	Description
15	EP15	R/W	1	RX Endpoint 15 Interrupt Enable
				Value Description
				1 An interrupt is sent to the interrupt controller when the EP15 bit in the <b>USBRXIS</b> register is set.
				0 The EP15 receive interrupt is suppressed and not sent to the interrupt controller.
14	EP14	R/W	1	RX Endpoint 14 Interrupt Enable Same description as EP15.
13	EP13	R/W	1	RX Endpoint 13 Interrupt Enable Same description as EP15.
12	EP12	R/W	1	RX Endpoint 12 Interrupt Enable Same description as EP15.
11	EP11	R/W	1	RX Endpoint 11 Interrupt Enable Same description as EP15.
10	EP10	R/W	1	RX Endpoint 10 Interrupt Enable Same description as EP15.
9	EP9	R/W	1	RX Endpoint 9 Interrupt Enable Same description as EP15.
8	EP8	R/W	1	RX Endpoint 8 Interrupt Enable Same description as EP15.
7	EP7	R/W	1	RX Endpoint 7 Interrupt Enable Same description as EP15.
6	EP6	R/W	1	RX Endpoint 6 Interrupt Enable Same description as EP15.

Bit/Field	Name	Type	Reset	Description
5	EP5	R/W	1	RX Endpoint 5 Interrupt Enable Same description as EP15.
4	EP4	R/W	1	RX Endpoint 4 Interrupt Enable Same description as EP15.
3	EP3	R/W	1	RX Endpoint 3 Interrupt Enable Same description as EP15.
2	EP2	R/W	1	RX Endpoint 2 Interrupt Enable Same description as EP15.
1	EP1	R/W	1	RX Endpoint 1 Interrupt Enable Same description as EP15.
0	reserved	RO	0	Software should not rely on the value of a reserved bit. To provide compatibility with future products, the value of a reserved bit should be preserved across a read-modify-write operation.

## Register 7: USB General Interrupt Status (USBIS), offset 0x00A

**Important:** Use caution when reading this register. Performing a read may change bit status.

OTG A /  
Host

**USBIS** is an 8-bit read-only register that indicates which USB interrupts are currently active. All active interrupts are cleared when this register is read.

OTG B /  
Device

### OTG A / Host Mode

#### USB General Interrupt Status (USBIS)

Base 0x4005.0000

Offset 0x00A

Type RO, reset 0x00

	7	6	5	4	3	2	1	0
	VBUSERR	SESREQ	DISCON	CONN	SOF	BABBLE	RESUME	reserved
Type	RO	RO	RO	RO	RO	RO	RO	RO
Reset	0	0	0	0	0	0	0	0

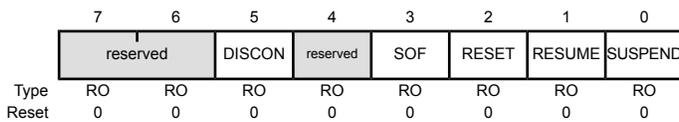
Bit/Field	Name	Type	Reset	Description
7	VBUSERR	RO	0	VBUS Error  Value Description 1 VBUS has dropped below the VBUS Valid threshold during a session. 0 No interrupt.
6	SESREQ	RO	0	SESSION REQUEST  Value Description 1 SESSION REQUEST signaling has been detected. 0 No interrupt.
5	DISCON	RO	0	Session Disconnect  Value Description 1 A Device disconnect has been detected. 0 No interrupt.
4	CONN	RO	0	Session Connect  Value Description 1 A Device connection has been detected. 0 No interrupt.

Bit/Field	Name	Type	Reset	Description
3	SOF	RO	0	Start of Frame  Value Description 1 A new frame has started. 0 No interrupt.
2	BABBLE	RO	0	Babble Detected  Value Description 1 Babble has been detected. This interrupt is active only after the first SOF has been sent. 0 No interrupt.
1	RESUME	RO	0	RESUME Signaling Detected  Value Description 1 RESUME signaling has been detected on the bus while the USB controller is in SUSPEND mode. 0 No interrupt.  This interrupt can only be used if the USB controller's system clock is enabled. If the user disables the clock programming, the <b>USBDRRIS</b> , <b>USBDRIM</b> , and <b>USBDRISC</b> registers should be used.
0	reserved	RO	0	Software should not rely on the value of a reserved bit. To provide compatibility with future products, the value of a reserved bit should be preserved across a read-modify-write operation.

**OTG B / Device Mode**

USB General Interrupt Status (USBIS)

Base 0x4005.0000  
Offset 0x00A  
Type RO, reset 0x00



Bit/Field	Name	Type	Reset	Description
7:6	reserved	RO	0x0	Software should not rely on the value of a reserved bit. To provide compatibility with future products, the value of a reserved bit should be preserved across a read-modify-write operation.
5	DISCON	RO	0	Session Disconnect  Value Description 1 The device has been disconnected from the host. 0 No interrupt.

Bit/Field	Name	Type	Reset	Description
4	reserved	RO	0	Software should not rely on the value of a reserved bit. To provide compatibility with future products, the value of a reserved bit should be preserved across a read-modify-write operation.
3	SOF	RO	0	Start of Frame  Value Description 1 A new frame has started. 0 No interrupt.
2	RESET	RO	0	RESET Signaling Detected  Value Description 1 RESET signaling has been detected on the bus. 0 No interrupt.
1	RESUME	RO	0	RESUME Signaling Detected  Value Description 1 RESUME signaling has been detected on the bus while the USB controller is in SUSPEND mode. 0 No interrupt.  This interrupt can only be used if the USB controller's system clock is enabled. If the user disables the clock programming, the <b>USBDRRIS</b> , <b>USBDRIM</b> , and <b>USBDRISC</b> registers should be used.
0	SUSPEND	RO	0	SUSPEND Signaling Detected  Value Description 1 SUSPEND signaling has been detected on the bus. 0 No interrupt.

### Register 8: USB Interrupt Enable (USBIE), offset 0x00B

OTG A /  
Host

**USBIE** is an 8-bit register that provides interrupt enable bits for each of the interrupts in **USBIS**. At reset interrupts 1 and 2 are enabled in Device mode.

OTG B /  
Device

#### OTG A / Host Mode

##### USB Interrupt Enable (USBIE)

Base 0x4005.0000  
Offset 0x00B  
Type R/W, reset 0x06

	7	6	5	4	3	2	1	0
	VBUSERR	SESREQ	DISCON	CONN	SOF	BABBLE	RESUME	reserved
Type	R/W	R/W	R/W	R/W	R/W	R/W	R/W	RO
Reset	0	0	0	0	0	1	1	0

Bit/Field	Name	Type	Reset	Description
7	VBUSERR	R/W	0	<p>Enable VBUS Error Interrupt</p> <p>Value Description</p> <p>1 An interrupt is sent to the interrupt controller when the <b>VBUSERR</b> bit in the <b>USBIS</b> register is set.</p> <p>0 The <b>VBUSERR</b> interrupt is suppressed and not sent to the interrupt controller.</p>
6	SESREQ	R/W	0	<p>Enable Session Request</p> <p>Value Description</p> <p>1 An interrupt is sent to the interrupt controller when the <b>SESREQ</b> bit in the <b>USBIS</b> register is set.</p> <p>0 The <b>SESREQ</b> interrupt is suppressed and not sent to the interrupt controller.</p>
5	DISCON	R/W	0	<p>Enable Disconnect Interrupt</p> <p>Value Description</p> <p>1 An interrupt is sent to the interrupt controller when the <b>DISCON</b> bit in the <b>USBIS</b> register is set.</p> <p>0 The <b>DISCON</b> interrupt is suppressed and not sent to the interrupt controller.</p>

Bit/Field	Name	Type	Reset	Description
4	CONN	R/W	0	Enable Connect Interrupt  Value Description 1 An interrupt is sent to the interrupt controller when the CONN bit in the <b>USBIS</b> register is set. 0 The CONN interrupt is suppressed and not sent to the interrupt controller.
3	SOF	R/W	0	Enable Start-of-Frame Interrupt  Value Description 1 An interrupt is sent to the interrupt controller SOF the CONN bit in the <b>USBIS</b> register is set. 0 The SOF interrupt is suppressed and not sent to the interrupt controller.
2	BABBLE	R/W	1	Enable Babble Interrupt  Value Description 1 An interrupt is sent to the interrupt controller when the BABBLE bit in the <b>USBIS</b> register is set. 0 The BABBLE interrupt is suppressed and not sent to the interrupt controller.
1	RESUME	R/W	1	Enable RESUME Interrupt  Value Description 1 An interrupt is sent to the interrupt controller when the RESUME bit in the <b>USBIS</b> register is set. 0 The RESUME interrupt is suppressed and not sent to the interrupt controller.
0	reserved	RO	0	Software should not rely on the value of a reserved bit. To provide compatibility with future products, the value of a reserved bit should be preserved across a read-modify-write operation.

## OTG B / Device Mode

### USB Interrupt Enable (USBIE)

Base 0x4005.0000  
Offset 0x00B  
Type R/W, reset 0x06

	7	6	5	4	3	2	1	0
Type	RO	RO	R/W	RO	R/W	R/W	R/W	R/W
Reset	0	0	0	0	0	1	1	0

Bit/Field	Name	Type	Reset	Description
7:6	reserved	RO	0x0	Software should not rely on the value of a reserved bit. To provide compatibility with future products, the value of a reserved bit should be preserved across a read-modify-write operation.
5	DISCON	R/W	0	<p>Enable Disconnect Interrupt</p> <p>Value Description</p> <p>1 An interrupt is sent to the interrupt controller when the DISCON bit in the <b>USBIS</b> register is set.</p> <p>0 The DISCON interrupt is suppressed and not sent to the interrupt controller.</p>
4	reserved	RO	0	Software should not rely on the value of a reserved bit. To provide compatibility with future products, the value of a reserved bit should be preserved across a read-modify-write operation.
3	SOF	R/W	0	<p>Enable Start-of-Frame Interrupt</p> <p>Value Description</p> <p>1 An interrupt is sent to the interrupt controller when the SOF bit in the <b>USBIS</b> register is set.</p> <p>0 The SOF interrupt is suppressed and not sent to the interrupt controller.</p>
2	RESET	R/W	1	<p>Enable RESET Interrupt</p> <p>Value Description</p> <p>1 An interrupt is sent to the interrupt controller when the RESET bit in the <b>USBIS</b> register is set.</p> <p>0 The RESET interrupt is suppressed and not sent to the interrupt controller.</p>
1	RESUME	R/W	1	<p>Enable RESUME Interrupt</p> <p>Value Description</p> <p>1 An interrupt is sent to the interrupt controller when the RESUME bit in the <b>USBIS</b> register is set.</p> <p>0 The RESUME interrupt is suppressed and not sent to the interrupt controller.</p>
0	SUSPEND	R/W	0	<p>Enable SUSPEND Interrupt</p> <p>Value Description</p> <p>1 An interrupt is sent to the interrupt controller when the SUSPEND bit in the <b>USBIS</b> register is set.</p> <p>0 The SUSPEND interrupt is suppressed and not sent to the interrupt controller.</p>



**Register 9: USB Frame Value (USBFRAME), offset 0x00C**

OTG A /  
Host

**USBFRAME** is a 16-bit read-only register that holds the last received frame number.

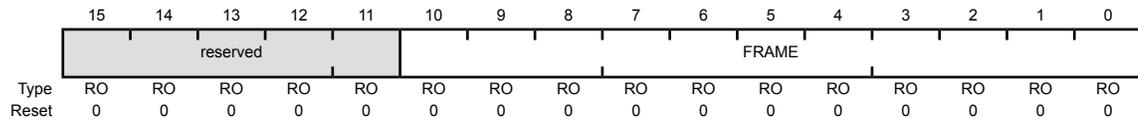
USB Frame Value (USBFRAME)

Base 0x4005.0000

Offset 0x00C

Type RO, reset 0x0000

OTG B /  
Device



Bit/Field	Name	Type	Reset	Description
15:11	reserved	RO	0x0	Software should not rely on the value of a reserved bit. To provide compatibility with future products, the value of a reserved bit should be preserved across a read-modify-write operation.
10:0	FRAME	RO	0x000	Frame Number

### Register 10: USB Endpoint Index (USBEPIDX), offset 0x00E

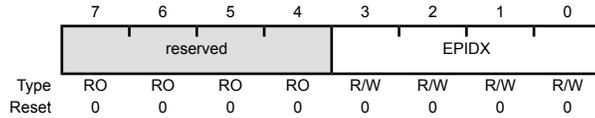
OTG A /  
Host

Each endpoint's buffer can be accessed by configuring a FIFO size and starting address. The **USBEPIDX** 16-bit register is used with the **USBTXFIFOSZ**, **USBRXFIFOSZ**, **USBTXFIFOADD**, and **USBRXFIFOADD** registers.

OTG B /  
Device

USB Endpoint Index (USBEPIDX)

Base 0x4005.0000  
Offset 0x00E  
Type R/W, reset 0x00



Bit/Field	Name	Type	Reset	Description
7:4	reserved	RO	0x0	Software should not rely on the value of a reserved bit. To provide compatibility with future products, the value of a reserved bit should be preserved across a read-modify-write operation.
3:0	EPIDX	R/W	0x0	Endpoint Index  This bit field configures which endpoint is accessed when reading or writing to one of the USB controller's indexed registers. A value of 0x0 corresponds to Endpoint 0 and a value of 0xF corresponds to Endpoint 15.

**Register 11: USB Test Mode (USBTEST), offset 0x00F**

OTG A /  
Host

**USBTEST** is an 8-bit register that is primarily used to put the USB controller into one of the four test modes for operation described in the *USB 2.0 Specification*, in response to a SET FEATURE: USBTESTMODE command. This register is not used in normal operation.

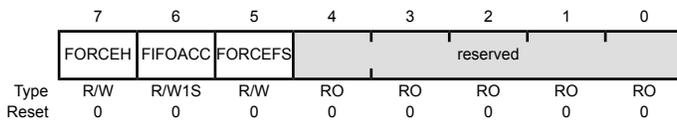
OTG B /  
Device

**Note:** Only one of these bits should be set at any time.

**OTG A / Host Mode**

## USB Test Mode (USBTEST)

Base 0x4005.0000  
Offset 0x00F  
Type R/W, reset 0x00



Bit/Field	Name	Type	Reset	Description
7	FORCEH	R/W	0	Force Host Mode

## Value Description

1 Forces the USB controller to enter Host mode when the `SESSION` bit is set, regardless of whether the USB controller is connected to any peripheral. The state of the `USB0DP` and `USB0DM` signals is ignored. The USB controller then remains in Host mode until the `SESSION` bit is cleared, even if a Device is disconnected. If the `FORCEH` bit remains set, the USB controller re-enters Host mode the next time the `SESSION` bit is set.

0 No effect.

While in this mode, status of the bus connection may be read using the `DEV` bit of the `USBDEVCTL` register. The operating speed is determined from the `FORCEFS` bit.

6	FIFOACC	R/W1S	0	FIFO Access
---	---------	-------	---	-------------

## Value Description

1 Transfers the packet in the endpoint 0 transmit FIFO to the endpoint 0 receive FIFO.

0 No effect.

This bit is cleared automatically.

5	FORCEFS	R/W	0	Force Full-Speed Mode
---	---------	-----	---	-----------------------

## Value Description

1 Forces the USB controller into Full-Speed mode upon receiving a USB RESET.

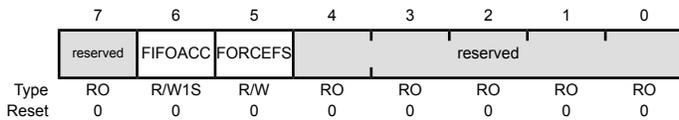
0 The USB controller operates at Low Speed.

Bit/Field	Name	Type	Reset	Description
4:0	reserved	RO	0x0	Software should not rely on the value of a reserved bit. To provide compatibility with future products, the value of a reserved bit should be preserved across a read-modify-write operation.

**OTG B / Device Mode**

**USB Test Mode (USBTEST)**

Base 0x4005.0000  
 Offset 0x00F  
 Type R/W, reset 0x00



Bit/Field	Name	Type	Reset	Description
7	reserved	RO	0	Software should not rely on the value of a reserved bit. To provide compatibility with future products, the value of a reserved bit should be preserved across a read-modify-write operation.
6	FIFOACC	R/W1S	0	FIFO Access  Value Description 1 Transfers the packet in the endpoint 0 transmit FIFO to the endpoint 0 receive FIFO. 0 No effect.  This bit is cleared automatically.
5	FORCEFS	R/W	0	Force Full-Speed Mode  Value Description 1 Forces the USB controller into Full-Speed mode upon receiving a USB RESET. 0 The USB controller operates at Low Speed.
4:0	reserved	RO	0x0	Software should not rely on the value of a reserved bit. To provide compatibility with future products, the value of a reserved bit should be preserved across a read-modify-write operation.

**Register 12: USB FIFO Endpoint 0 (USBFIFO0), offset 0x020**  
**Register 13: USB FIFO Endpoint 1 (USBFIFO1), offset 0x024**  
**Register 14: USB FIFO Endpoint 2 (USBFIFO2), offset 0x028**  
**Register 15: USB FIFO Endpoint 3 (USBFIFO3), offset 0x02C**  
**Register 16: USB FIFO Endpoint 4 (USBFIFO4), offset 0x030**  
**Register 17: USB FIFO Endpoint 5 (USBFIFO5), offset 0x034**  
**Register 18: USB FIFO Endpoint 6 (USBFIFO6), offset 0x038**  
**Register 19: USB FIFO Endpoint 7 (USBFIFO7), offset 0x03C**  
**Register 20: USB FIFO Endpoint 8 (USBFIFO8), offset 0x040**  
**Register 21: USB FIFO Endpoint 9 (USBFIFO9), offset 0x044**  
**Register 22: USB FIFO Endpoint 10 (USBFIFO10), offset 0x048**  
**Register 23: USB FIFO Endpoint 11 (USBFIFO11), offset 0x04C**  
**Register 24: USB FIFO Endpoint 12 (USBFIFO12), offset 0x050**  
**Register 25: USB FIFO Endpoint 13 (USBFIFO13), offset 0x054**  
**Register 26: USB FIFO Endpoint 14 (USBFIFO14), offset 0x058**  
**Register 27: USB FIFO Endpoint 15 (USBFIFO15), offset 0x05C**

---

**Important:** Use caution when reading this register. Performing a read may change bit status.

---

**OTG A /  
Host**

These 32-bit registers provide an address for CPU access to the FIFOs for each endpoint. Writing to these addresses loads data into the Transmit FIFO for the corresponding endpoint. Reading from these addresses unloads data from the Receive FIFO for the corresponding endpoint.

**OTG B /  
Device**

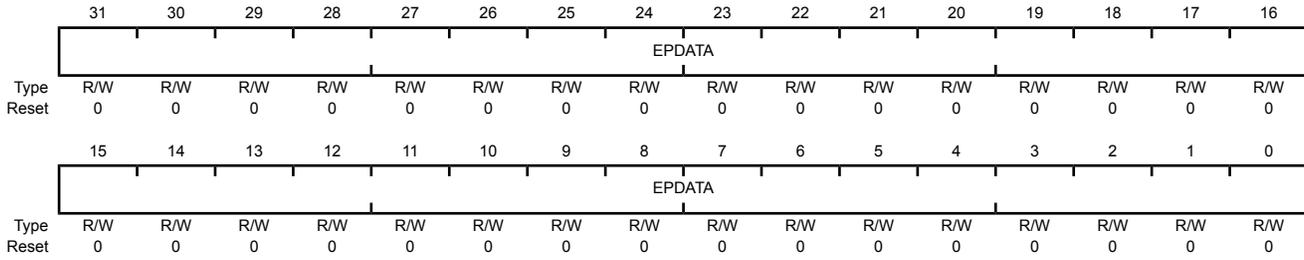
Transfers to and from FIFOs may be 8-bit, 16-bit or 32-bit as required, and any combination of accesses is allowed provided the data accessed is contiguous. All transfers associated with one packet must be of the same width so that the data is consistently byte-, halfword- or word-aligned. However, the last transfer may contain fewer bytes than the previous transfers in order to complete an odd-byte or odd-word transfer.

Depending on the size of the FIFO and the expected maximum packet size, the FIFOs support either single-packet or double-packet buffering (see the section called “Single-Packet Buffering” on page 880). Burst writing of multiple packets is not supported as flags must be set after each packet is written.

Following a STALL response or a transmit error on endpoint 1–15, the associated FIFO is completely flushed.

USB FIFO Endpoint 0 (USBFIFO0)

Base 0x4005.0000  
 Offset 0x020  
 Type R/W, reset 0x0000.0000



Bit/Field	Name	Type	Reset	Description
31:0	EPDATA	R/W	0x0000.0000	Endpoint Data

Writing to this register loads the data into the Transmit FIFO and reading unloads data from the Receive FIFO.

**Register 28: USB Device Control (USBDEVCTL), offset 0x060**

OTG A /  
Host

**USBDEVCTL** is an 8-bit register used for controlling and monitoring the USB VBUS line. If the PHY is suspended, no PHY clock is received and the VBUS is not sampled. In addition, in Host mode, **USBDEVCTL** provides the status information for the current operating mode (Host or Device) of the USB controller. If the USB controller is in Host mode, this register also indicates if a full- or low-speed Device has been connected.

## USB Device Control (USBDEVCTL)

Base 0x4005.0000  
Offset 0x060  
Type R/W, reset 0x80

	7	6	5	4	3	2	1	0
	DEV	FSDEV	LSDEV	VBUS		HOST	HOSTREQ	SESSION
Type	RO	RO	RO	RO	RO	RO	R/W	R/W
Reset	1	0	0	0	0	0	0	0

Bit/Field	Name	Type	Reset	Description
7	DEV	RO	1	Device Mode  Value Description 0 The USB controller is operating on the OTG A side of the cable. 1 The USB controller is operating on the OTG B side of the cable.  <b>Note:</b> This value is only valid while a session is in progress.
6	FSDEV	RO	0	Full-Speed Device Detected  Value Description 0 A full-speed Device has not been detected on the port. 1 A full-speed Device has been detected on the port.
5	LSDEV	RO	0	Low-Speed Device Detected  Value Description 0 A low-speed Device has not been detected on the port. 1 A low-speed Device has been detected on the port.
4:3	VBUS	RO	0x0	VBUS Level  Value Description 0x0 Below SessionEnd VBUS is detected as under 0.5 V. 0x1 Above SessionEnd, below AValid VBUS is detected as above 0.5 V and under 1.5 V. 0x2 Above AValid, below VBUSValid VBUS is detected as above 1.5 V and below 4.5 V. 0x3 Above VBUSValid VBUS is detected as above 4.5 V.

Bit/Field	Name	Type	Reset	Description
2	HOST	RO	0	<p>Host Mode</p> <p>Value Description</p> <p>0 The USB controller is acting as a Device.</p> <p>1 The USB controller is acting as a Host.</p> <p><b>Note:</b> This value is only valid while a session is in progress.</p>
1	HOSTREQ	R/W	0	<p>Host Request</p> <p>Value Description</p> <p>0 No effect.</p> <p>1 Initiates the Host Negotiation when SUSPEND mode is entered.</p> <p>This bit is cleared when Host Negotiation is completed.</p>
0	SESSION	R/W	0	<p>Session Start/End</p> <p><i>When operating as an OTG A device:</i></p> <p>Value Description</p> <p>0 When cleared by software, this bit ends a session.</p> <p>1 When set by software, this bit starts a session.</p> <p><i>When operating as an OTG B device:</i></p> <p>Value Description</p> <p>0 The USB controller has ended a session. When the USB controller is in SUSPEND mode, this bit may be cleared by software to perform a software disconnect.</p> <p>1 The USB controller has started a session. When set by software, the Session Request Protocol is initiated.</p> <p><b>Note:</b> Clearing this bit when the USB controller is not suspended results in undefined behavior.</p>



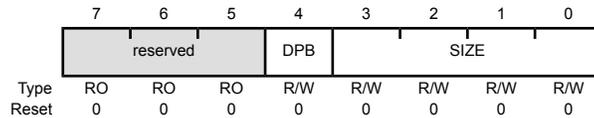
**Register 29: USB Transmit Dynamic FIFO Sizing (USBTXFIFOSZ), offset 0x062****Register 30: USB Receive Dynamic FIFO Sizing (USBRXFIFOSZ), offset 0x063****OTG A /  
Host**

These 8-bit registers allow the selected TX/RX endpoint FIFOs to be dynamically sized. **USBEPIDX** is used to configure each transmit endpoint's FIFO size.

**OTG B /  
Device**

## USB Transmit Dynamic FIFO Sizing (USBTXFIFOSZ)

Base 0x4005.0000  
Offset 0x062  
Type R/W, reset 0x00



Bit/Field	Name	Type	Reset	Description
7:5	reserved	RO	0x0	Software should not rely on the value of a reserved bit. To provide compatibility with future products, the value of a reserved bit should be preserved across a read-modify-write operation.
4	DPB	R/W	0	Double Packet Buffer Support  Value Description 0 Only single-packet buffering is supported. 1 Double-packet buffering is supported.
3:0	SIZE	R/W	0x0	Max Packet Size  Maximum packet size to be allowed.  If $DPB = 0$ , the FIFO also is this size; if $DPB = 1$ , the FIFO is twice this size.  Value Packet Size (Bytes) 0x0 8 0x1 16 0x2 32 0x3 64 0x4 128 0x5 256 0x6 512 0x7 1024 0x8 2048 0x9-0xF Reserved

**Register 31: USB Transmit FIFO Start Address (USBTXFIFOADD), offset 0x064**

**Register 32: USB Receive FIFO Start Address (USBRXFIFOADD), offset 0x066**

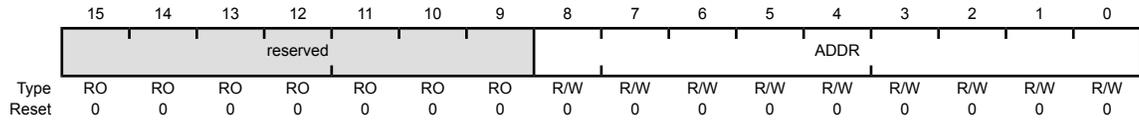
OTG A /  
Host

**USBTXFIFOADD** and **USBRXFIFOADD** are 16-bit registers that controls the start address of the selected transmit and receive endpoint FIFOs.

USB Transmit FIFO Start Address (USBTXFIFOADD)

OTG B /  
Device

Base 0x4005.0000  
Offset 0x064  
Type R/W, reset 0x0000



Bit/Field	Name	Type	Reset	Description
15:9	reserved	RO	0x00	Software should not rely on the value of a reserved bit. To provide compatibility with future products, the value of a reserved bit should be preserved across a read-modify-write operation.
8:0	ADDR	R/W	0x00	Transmit/Receive Start Address Start address of the endpoint FIFO.

Value	Start Address
0x0	0
0x1	8
0x2	16
0x3	24
0x4	32
0x5	40
0x6	48
0x7	56
0x8	64
...	...
0x1FF	4095

**Register 33: USB Connect Timing (USBCONTIM), offset 0x07A****OTG A /  
Host**

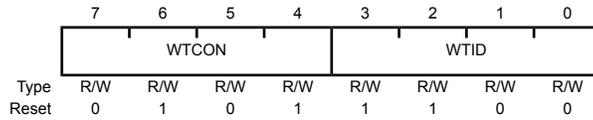
This 8-bit configuration register specifies connection and negotiation delays.

USB Connect Timing (USBCONTIM)

Base 0x4005.0000

Offset 0x07A

Type R/W, reset 0x5C

**OTG B /  
Device**

Bit/Field	Name	Type	Reset	Description
7:4	WTCN	R/W	0x5	Connect Wait  This field configures the wait required to allow for the user's connect/disconnect filter, in units of 533.3 ns. The default corresponds to 2.667 $\mu$ s.
3:0	WTID	R/W	0xC	Wait ID  This field configures the delay required from the enable of the ID detection to when the ID value is valid, in units of 4.369 ms. The default corresponds to 52.43 ms.

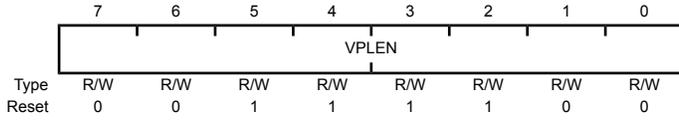
### Register 34: USB OTG VBUS Pulse Timing (USBVPLEN), offset 0x07B

**OTG**

This 8-bit configuration register specifies the duration of the VBUS pulsing charge.

USB OTG VBUS Pulse Timing (USBVPLEN)

Base 0x4005.0000  
 Offset 0x07B  
 Type R/W, reset 0x3C



Bit/Field	Name	Type	Reset	Description
7:0	VPLEN	R/W	0x3C	VBUS Pulse Length

This field configures the duration of the VBUS pulsing charge in units of 546.1  $\mu$ s. The default corresponds to 32.77 ms.

## Register 35: USB Full-Speed Last Transaction to End of Frame Timing (USBFSEOF), offset 0x07D

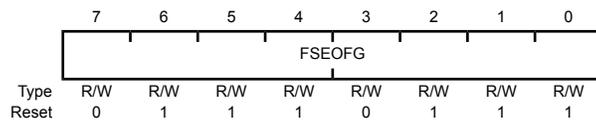
OTG A /  
Host

This 8-bit configuration register specifies the minimum time gap allowed between the start of the last transaction and the EOF for full-speed transactions.

OTG B /  
Device

USB Full-Speed Last Transaction to End of Frame Timing (USBFSEOF)

Base 0x4005.0000  
Offset 0x07D  
Type R/W, reset 0x77



Bit/Field	Name	Type	Reset	Description
7:0	FSEOFG	R/W	0x77	Full-Speed End-of-Frame Gap  This field is used during full-speed transactions to configure the gap between the last transaction and the End-of-Frame (EOF), in units of 533.3 ns. The default corresponds to 63.46 $\mu$ s.

### Register 36: USB Low-Speed Last Transaction to End of Frame Timing (USBLSEOF), offset 0x07E

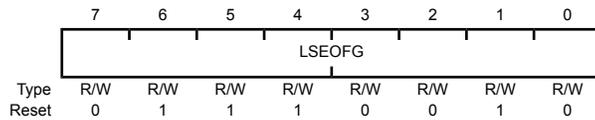
OTG A /  
Host

This 8-bit configuration register specifies the minimum time gap that is to be allowed between the start of the last transaction and the EOF for low-speed transactions.

OTG B /  
Device

USB Low-Speed Last Transaction to End of Frame Timing (USBLSEOF)

Base 0x4005.0000  
Offset 0x07E  
Type R/W, reset 0x72



Bit/Field	Name	Type	Reset	Description
7:0	LSEOFG	R/W	0x72	Low-Speed End-of-Frame Gap

This field is used during low-speed transactions to set the gap between the last transaction and the End-of-Frame (EOF), in units of 1.067  $\mu$ s. The default corresponds to 121.6  $\mu$ s.

**Register 37: USB Transmit Functional Address Endpoint 0 (USBTXFUNCADDR0), offset 0x080**

**Register 38: USB Transmit Functional Address Endpoint 1 (USBTXFUNCADDR1), offset 0x088**

**Register 39: USB Transmit Functional Address Endpoint 2 (USBTXFUNCADDR2), offset 0x090**

**Register 40: USB Transmit Functional Address Endpoint 3 (USBTXFUNCADDR3), offset 0x098**

**Register 41: USB Transmit Functional Address Endpoint 4 (USBTXFUNCADDR4), offset 0x0A0**

**Register 42: USB Transmit Functional Address Endpoint 5 (USBTXFUNCADDR5), offset 0x0A8**

**Register 43: USB Transmit Functional Address Endpoint 6 (USBTXFUNCADDR6), offset 0x0B0**

**Register 44: USB Transmit Functional Address Endpoint 7 (USBTXFUNCADDR7), offset 0x0B8**

**Register 45: USB Transmit Functional Address Endpoint 8 (USBTXFUNCADDR8), offset 0x0C0**

**Register 46: USB Transmit Functional Address Endpoint 9 (USBTXFUNCADDR9), offset 0x0C8**

**Register 47: USB Transmit Functional Address Endpoint 10 (USBTXFUNCADDR10), offset 0x0D0**

**Register 48: USB Transmit Functional Address Endpoint 11 (USBTXFUNCADDR11), offset 0x0D8**

**Register 49: USB Transmit Functional Address Endpoint 12 (USBTXFUNCADDR12), offset 0x0E0**

**Register 50: USB Transmit Functional Address Endpoint 13 (USBTXFUNCADDR13), offset 0x0E8**

**Register 51: USB Transmit Functional Address Endpoint 14 (USBTXFUNCADDR14), offset 0x0F0**

**Register 52: USB Transmit Functional Address Endpoint 15 (USBTXFUNCADDR15), offset 0x0F8**

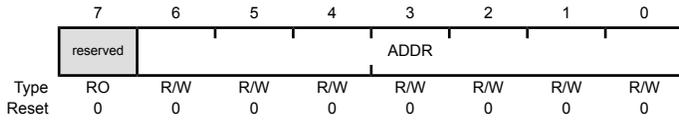
OTG A /  
Host

USBTXFUNCADDR<sub>n</sub> is an 8-bit read/write register that records the address of the target function to be accessed through the associated endpoint (EP<sub>n</sub>). USBTXFUNCADDR<sub>n</sub> must be defined for each transmit endpoint that is used.

**Note:** USBTXFUNCADDR0 is used for both receive and transmit for endpoint 0.

**USB Transmit Functional Address Endpoint 0 (USBTXFUNCADDR0)**

Base 0x4005.0000  
 Offset 0x080  
 Type R/W, reset 0x00



Bit/Field	Name	Type	Reset	Description
7	reserved	RO	0	Software should not rely on the value of a reserved bit. To provide compatibility with future products, the value of a reserved bit should be preserved across a read-modify-write operation.
6:0	ADDR	R/W	0x00	Device Address Specifies the USB bus address for the target Device.



**Register 53: USB Transmit Hub Address Endpoint 0 (USBTXHUBADDR0), offset 0x082**

**Register 54: USB Transmit Hub Address Endpoint 1 (USBTXHUBADDR1), offset 0x08A**

**Register 55: USB Transmit Hub Address Endpoint 2 (USBTXHUBADDR2), offset 0x092**

**Register 56: USB Transmit Hub Address Endpoint 3 (USBTXHUBADDR3), offset 0x09A**

**Register 57: USB Transmit Hub Address Endpoint 4 (USBTXHUBADDR4), offset 0x0A2**

**Register 58: USB Transmit Hub Address Endpoint 5 (USBTXHUBADDR5), offset 0x0AA**

**Register 59: USB Transmit Hub Address Endpoint 6 (USBTXHUBADDR6), offset 0x0B2**

**Register 60: USB Transmit Hub Address Endpoint 7 (USBTXHUBADDR7), offset 0x0BA**

**Register 61: USB Transmit Hub Address Endpoint 8 (USBTXHUBADDR8), offset 0x0C2**

**Register 62: USB Transmit Hub Address Endpoint 9 (USBTXHUBADDR9), offset 0x0CA**

**Register 63: USB Transmit Hub Address Endpoint 10 (USBTXHUBADDR10), offset 0x0D2**

**Register 64: USB Transmit Hub Address Endpoint 11 (USBTXHUBADDR11), offset 0x0DA**

**Register 65: USB Transmit Hub Address Endpoint 12 (USBTXHUBADDR12), offset 0x0E2**

**Register 66: USB Transmit Hub Address Endpoint 13 (USBTXHUBADDR13), offset 0x0EA**

**Register 67: USB Transmit Hub Address Endpoint 14 (USBTXHUBADDR14), offset 0x0F2**

**Register 68: USB Transmit Hub Address Endpoint 15 (USBTXHUBADDR15), offset 0x0FA**

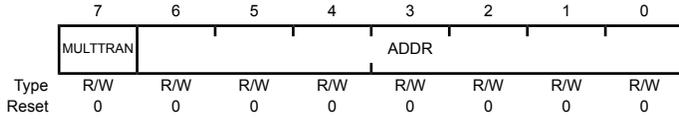
OTG A /  
Host

USBTXHUBADDR<sub>n</sub> is an 8-bit read/write register that, like USBTXHUBPORT<sub>n</sub>, only must be written when a USB Device is connected to transmit endpoint EP<sub>n</sub> via a USB 2.0 hub. This register records the address of the USB 2.0 hub through which the target associated with the endpoint is accessed.

**Note:** USBTXHUBADDR0 is used for both receive and transmit for endpoint 0.

USB Transmit Hub Address Endpoint 0 (USBTXHUBADDR0)

Base 0x4005.0000  
 Offset 0x082  
 Type R/W, reset 0x00



Bit/Field	Name	Type	Reset	Description
7	MULTTRAN	R/W	0	Multiple Translators  Value Description 0 Clear to indicate that the hub has a single transaction translator. 1 Set to indicate that the hub has multiple transaction translators.
6:0	ADDR	R/W	0x00	Hub Address  This field specifies the USB bus address for the USB 2.0 hub.

**Register 69: USB Transmit Hub Port Endpoint 0 (USBTXHUBPORT0), offset 0x083**

**Register 70: USB Transmit Hub Port Endpoint 1 (USBTXHUBPORT1), offset 0x08B**

**Register 71: USB Transmit Hub Port Endpoint 2 (USBTXHUBPORT2), offset 0x093**

**Register 72: USB Transmit Hub Port Endpoint 3 (USBTXHUBPORT3), offset 0x09B**

**Register 73: USB Transmit Hub Port Endpoint 4 (USBTXHUBPORT4), offset 0x0A3**

**Register 74: USB Transmit Hub Port Endpoint 5 (USBTXHUBPORT5), offset 0x0AB**

**Register 75: USB Transmit Hub Port Endpoint 6 (USBTXHUBPORT6), offset 0x0B3**

**Register 76: USB Transmit Hub Port Endpoint 7 (USBTXHUBPORT7), offset 0x0BB**

**Register 77: USB Transmit Hub Port Endpoint 8 (USBTXHUBPORT8), offset 0x0C3**

**Register 78: USB Transmit Hub Port Endpoint 9 (USBTXHUBPORT9), offset 0x0CB**

**Register 79: USB Transmit Hub Port Endpoint 10 (USBTXHUBPORT10), offset 0x0D3**

**Register 80: USB Transmit Hub Port Endpoint 11 (USBTXHUBPORT11), offset 0x0DB**

**Register 81: USB Transmit Hub Port Endpoint 12 (USBTXHUBPORT12), offset 0x0E3**

**Register 82: USB Transmit Hub Port Endpoint 13 (USBTXHUBPORT13), offset 0x0EB**

**Register 83: USB Transmit Hub Port Endpoint 14 (USBTXHUBPORT14), offset 0x0F3**

**Register 84: USB Transmit Hub Port Endpoint 15 (USBTXHUBPORT15), offset 0x0FB**

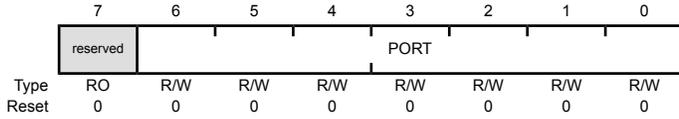
OTG A /  
Host

USBTXHUBPORT<sub>n</sub> is an 8-bit read/write register that, like USBTXHUBADDR<sub>n</sub>, only must be written when a full- or low-speed Device is connected to transmit endpoint EP<sub>n</sub> via a USB 2.0 hub. This register records the port of the USB 2.0 hub through which the target associated with the endpoint is accessed.

**Note:** USBTXHUBPORT0 is used for both receive and transmit for endpoint 0.

USB Transmit Hub Port Endpoint 0 (USBTXHUBPORT0)

Base 0x4005.0000  
 Offset 0x083  
 Type R/W, reset 0x00



Bit/Field	Name	Type	Reset	Description
7	reserved	RO	0	Software should not rely on the value of a reserved bit. To provide compatibility with future products, the value of a reserved bit should be preserved across a read-modify-write operation.
6:0	PORT	R/W	0x00	Hub Port This field specifies the USB hub port number.

**Register 85: USB Receive Functional Address Endpoint 1 (USBRXFUNCADDR1), offset 0x08C**

**Register 86: USB Receive Functional Address Endpoint 2 (USBRXFUNCADDR2), offset 0x094**

**Register 87: USB Receive Functional Address Endpoint 3 (USBRXFUNCADDR3), offset 0x09C**

**Register 88: USB Receive Functional Address Endpoint 4 (USBRXFUNCADDR4), offset 0x0A4**

**Register 89: USB Receive Functional Address Endpoint 5 (USBRXFUNCADDR5), offset 0x0AC**

**Register 90: USB Receive Functional Address Endpoint 6 (USBRXFUNCADDR6), offset 0x0B4**

**Register 91: USB Receive Functional Address Endpoint 7 (USBRXFUNCADDR7), offset 0x0BC**

**Register 92: USB Receive Functional Address Endpoint 8 (USBRXFUNCADDR8), offset 0x0C4**

**Register 93: USB Receive Functional Address Endpoint 9 (USBRXFUNCADDR9), offset 0x0CC**

**Register 94: USB Receive Functional Address Endpoint 10 (USBRXFUNCADDR10), offset 0x0D4**

**Register 95: USB Receive Functional Address Endpoint 11 (USBRXFUNCADDR11), offset 0x0DC**

**Register 96: USB Receive Functional Address Endpoint 12 (USBRXFUNCADDR12), offset 0x0E4**

**Register 97: USB Receive Functional Address Endpoint 13 (USBRXFUNCADDR13), offset 0x0EC**

**Register 98: USB Receive Functional Address Endpoint 14 (USBRXFUNCADDR14), offset 0x0F4**

**Register 99: USB Receive Functional Address Endpoint 15 (USBRXFUNCADDR15), offset 0x0FC**

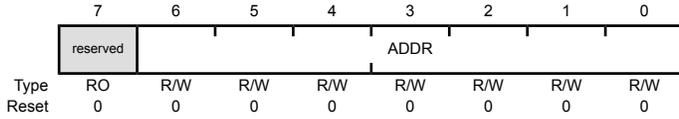
**OTG A /  
Host**

**USBRXFUNCADDR<sub>n</sub>** is an 8-bit read/write register that records the address of the target function accessed through the associated endpoint (EP<sub>n</sub>). **USBRXFUNCADDR<sub>n</sub>** must be defined for each receive endpoint that is used.

**Note:** **USBTXFUNCADDR0** is used for both receive and transmit for endpoint 0.

**USB Receive Functional Address Endpoint 1 (USBXFUNCADDR1)**

Base 0x4005.0000  
 Offset 0x08C  
 Type R/W, reset 0x00



Bit/Field	Name	Type	Reset	Description
7	reserved	RO	0	Software should not rely on the value of a reserved bit. To provide compatibility with future products, the value of a reserved bit should be preserved across a read-modify-write operation.
6:0	ADDR	R/W	0x00	Device Address This field specifies the USB bus address for the target Device.

**Register 100: USB Receive Hub Address Endpoint 1 (USBRXHUBADDR1), offset 0x08E**

**Register 101: USB Receive Hub Address Endpoint 2 (USBRXHUBADDR2), offset 0x096**

**Register 102: USB Receive Hub Address Endpoint 3 (USBRXHUBADDR3), offset 0x09E**

**Register 103: USB Receive Hub Address Endpoint 4 (USBRXHUBADDR4), offset 0x0A6**

**Register 104: USB Receive Hub Address Endpoint 5 (USBRXHUBADDR5), offset 0x0AE**

**Register 105: USB Receive Hub Address Endpoint 6 (USBRXHUBADDR6), offset 0x0B6**

**Register 106: USB Receive Hub Address Endpoint 7 (USBRXHUBADDR7), offset 0x0BE**

**Register 107: USB Receive Hub Address Endpoint 8 (USBRXHUBADDR8), offset 0x0C6**

**Register 108: USB Receive Hub Address Endpoint 9 (USBRXHUBADDR9), offset 0x0CE**

**Register 109: USB Receive Hub Address Endpoint 10 (USBRXHUBADDR10), offset 0x0D6**

**Register 110: USB Receive Hub Address Endpoint 11 (USBRXHUBADDR11), offset 0x0DE**

**Register 111: USB Receive Hub Address Endpoint 12 (USBRXHUBADDR12), offset 0x0E6**

**Register 112: USB Receive Hub Address Endpoint 13 (USBRXHUBADDR13), offset 0x0EE**

**Register 113: USB Receive Hub Address Endpoint 14 (USBRXHUBADDR14), offset 0x0F6**

**Register 114: USB Receive Hub Address Endpoint 15 (USBRXHUBADDR15), offset 0x0FE**

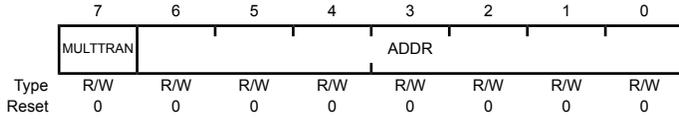
**OTG A /  
Host**

**USBRXHUBADDR<sub>n</sub>** is an 8-bit read/write register that, like **USBRXHUBPORT<sub>n</sub>**, only must be written when a full- or low-speed Device is connected to receive endpoint EP<sub>n</sub> via a USB 2.0 hub. This register records the address of the USB 2.0 hub through which the target associated with the endpoint is accessed.

**Note:** **USBTXHUBADDR0** is used for both receive and transmit for endpoint 0.

USB Receive Hub Address Endpoint 1 (USBRXHUBADDR1)

Base 0x4005.0000  
 Offset 0x08E  
 Type R/W, reset 0x00



Bit/Field	Name	Type	Reset	Description
7	MULTTRAN	R/W	0	Multiple Translators  Value Description 0 Clear to indicate that the hub has a single transaction translator. 1 Set to indicate that the hub has multiple transaction translators.
6:0	ADDR	R/W	0x00	Hub Address  This field specifies the USB bus address for the USB 2.0 hub.



**Register 115: USB Receive Hub Port Endpoint 1 (USBRXHUBPORT1), offset 0x08F**

**Register 116: USB Receive Hub Port Endpoint 2 (USBRXHUBPORT2), offset 0x097**

**Register 117: USB Receive Hub Port Endpoint 3 (USBRXHUBPORT3), offset 0x09F**

**Register 118: USB Receive Hub Port Endpoint 4 (USBRXHUBPORT4), offset 0x0A7**

**Register 119: USB Receive Hub Port Endpoint 5 (USBRXHUBPORT5), offset 0x0AF**

**Register 120: USB Receive Hub Port Endpoint 6 (USBRXHUBPORT6), offset 0x0B7**

**Register 121: USB Receive Hub Port Endpoint 7 (USBRXHUBPORT7), offset 0x0BF**

**Register 122: USB Receive Hub Port Endpoint 8 (USBRXHUBPORT8), offset 0x0C7**

**Register 123: USB Receive Hub Port Endpoint 9 (USBRXHUBPORT9), offset 0x0CF**

**Register 124: USB Receive Hub Port Endpoint 10 (USBRXHUBPORT10), offset 0x0D7**

**Register 125: USB Receive Hub Port Endpoint 11 (USBRXHUBPORT11), offset 0x0DF**

**Register 126: USB Receive Hub Port Endpoint 12 (USBRXHUBPORT12), offset 0x0E7**

**Register 127: USB Receive Hub Port Endpoint 13 (USBRXHUBPORT13), offset 0x0EF**

**Register 128: USB Receive Hub Port Endpoint 14 (USBRXHUBPORT14), offset 0x0F7**

**Register 129: USB Receive Hub Port Endpoint 15 (USBRXHUBPORT15), offset 0x0FF**

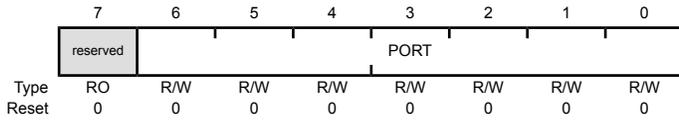
**OTG A /  
Host**

**USBRXHUBPORT<sub>n</sub>** is an 8-bit read/write register that, like **USBRXHUBADDR<sub>n</sub>**, only must be written when a full- or low-speed Device is connected to receive endpoint EP<sub>n</sub> via a USB 2.0 hub. This register records the port of the USB 2.0 hub through which the target associated with the endpoint is accessed.

**Note:** **USBTXHUBPORT0** is used for both receive and transmit for endpoint 0.

USB Receive Hub Port Endpoint 1 (USBRXHUBPORT1)

Base 0x4005.0000  
 Offset 0x08F  
 Type R/W, reset 0x00



Bit/Field	Name	Type	Reset	Description
7	reserved	RO	0	Software should not rely on the value of a reserved bit. To provide compatibility with future products, the value of a reserved bit should be preserved across a read-modify-write operation.
6:0	PORT	R/W	0x00	Hub Port This field specifies the USB hub port number.

**Register 130: USB Maximum Transmit Data Endpoint 1 (USBTXMAXP1), offset 0x110**

**Register 131: USB Maximum Transmit Data Endpoint 2 (USBTXMAXP2), offset 0x120**

**Register 132: USB Maximum Transmit Data Endpoint 3 (USBTXMAXP3), offset 0x130**

**Register 133: USB Maximum Transmit Data Endpoint 4 (USBTXMAXP4), offset 0x140**

**Register 134: USB Maximum Transmit Data Endpoint 5 (USBTXMAXP5), offset 0x150**

**Register 135: USB Maximum Transmit Data Endpoint 6 (USBTXMAXP6), offset 0x160**

**Register 136: USB Maximum Transmit Data Endpoint 7 (USBTXMAXP7), offset 0x170**

**Register 137: USB Maximum Transmit Data Endpoint 8 (USBTXMAXP8), offset 0x180**

**Register 138: USB Maximum Transmit Data Endpoint 9 (USBTXMAXP9), offset 0x190**

**Register 139: USB Maximum Transmit Data Endpoint 10 (USBTXMAXP10), offset 0x1A0**

**Register 140: USB Maximum Transmit Data Endpoint 11 (USBTXMAXP11), offset 0x1B0**

**Register 141: USB Maximum Transmit Data Endpoint 12 (USBTXMAXP12), offset 0x1C0**

**Register 142: USB Maximum Transmit Data Endpoint 13 (USBTXMAXP13), offset 0x1D0**

**Register 143: USB Maximum Transmit Data Endpoint 14 (USBTXMAXP14), offset 0x1E0**

**Register 144: USB Maximum Transmit Data Endpoint 15 (USBTXMAXP15), offset 0x1F0**

**OTG A /  
Host**

The **USBTXMAXPn** 16-bit register defines the maximum amount of data that can be transferred through the transmit endpoint in a single operation.

**OTG B /  
Device**

Bits [10:0] define (in bytes) the maximum payload transmitted in a single transaction. The value set can be up to 1024 bytes but is subject to the constraints placed by the *USB Specification* on packet sizes for bulk, interrupt and isochronous transfers in full-speed operation.

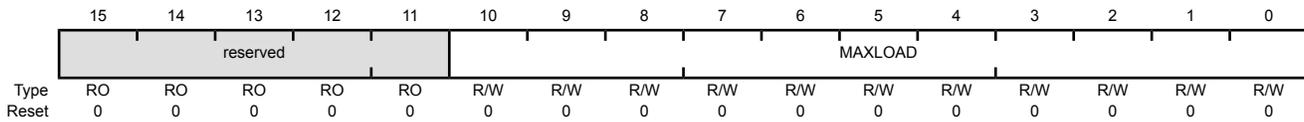
The total amount of data represented by the value written to this register must not exceed the FIFO size for the transmit endpoint, and must not exceed half the FIFO size if double-buffering is required.

If this register is changed after packets have been sent from the endpoint, the transmit endpoint FIFO must be completely flushed (using the `FLUSH` bit in `USBTXCSRL1n`) after writing the new value to this register.

**Note:** `USBTXMAXPn` must be set to an even number of bytes for proper interrupt generation in  $\mu$ DMA Basic Mode.

USB Maximum Transmit Data Endpoint 1 (USBTXMAXP1)

Base 0x4005.0000  
 Offset 0x110  
 Type R/W, reset 0x0000



Bit/Field	Name	Type	Reset	Description
15:11	reserved	RO	0x0	Software should not rely on the value of a reserved bit. To provide compatibility with future products, the value of a reserved bit should be preserved across a read-modify-write operation.
10:0	MAXLOAD	R/W	0x000	Maximum Payload  This field specifies the maximum payload in bytes per transaction.

## Register 145: USB Control and Status Endpoint 0 Low (USBCSRL0), offset 0x102

OTG A /  
Host

USBCSRL0 is an 8-bit register that provides control and status bits for endpoint 0.

OTG B /  
Device

### OTG A / Host Mode

#### USB Control and Status Endpoint 0 Low (USBCSRL0)

Base 0x4005.0000  
Offset 0x102  
Type W1C, reset 0x00

	7	6	5	4	3	2	1	0
	NAKTO	STATUS	REQPKT	ERROR	SETUP	STALLED	TXRDY	RXRDY
Type	R/W	R/W	R/W	R/W	R/W	R/W	R/W	R/W
Reset	0	0	0	0	0	0	0	0

Bit/Field	Name	Type	Reset	Description						
7	NAKTO	R/W	0	<p>NAK Timeout</p> <table border="1"> <thead> <tr> <th>Value</th> <th>Description</th> </tr> </thead> <tbody> <tr> <td>0</td> <td>No timeout.</td> </tr> <tr> <td>1</td> <td>Indicates that endpoint 0 is halted following the receipt of NAK responses for longer than the time set by the <b>USBNAKLMT</b> register.</td> </tr> </tbody> </table> <p>Software must clear this bit to allow the endpoint to continue.</p>	Value	Description	0	No timeout.	1	Indicates that endpoint 0 is halted following the receipt of NAK responses for longer than the time set by the <b>USBNAKLMT</b> register.
Value	Description									
0	No timeout.									
1	Indicates that endpoint 0 is halted following the receipt of NAK responses for longer than the time set by the <b>USBNAKLMT</b> register.									
6	STATUS	R/W	0	<p>STATUS Packet</p> <table border="1"> <thead> <tr> <th>Value</th> <th>Description</th> </tr> </thead> <tbody> <tr> <td>0</td> <td>No transaction.</td> </tr> <tr> <td>1</td> <td>Initiates a STATUS stage transaction. This bit must be set at the same time as the <b>TXRDY</b> or <b>REQPKT</b> bit is set.</td> </tr> </tbody> </table> <p>Setting this bit ensures that the <b>DT</b> bit is set in the <b>USBCSRH0</b> register so that a <b>DATA1</b> packet is used for the STATUS stage transaction.</p> <p>This bit is automatically cleared when the STATUS stage is over.</p>	Value	Description	0	No transaction.	1	Initiates a STATUS stage transaction. This bit must be set at the same time as the <b>TXRDY</b> or <b>REQPKT</b> bit is set.
Value	Description									
0	No transaction.									
1	Initiates a STATUS stage transaction. This bit must be set at the same time as the <b>TXRDY</b> or <b>REQPKT</b> bit is set.									
5	REQPKT	R/W	0	<p>Request Packet</p> <table border="1"> <thead> <tr> <th>Value</th> <th>Description</th> </tr> </thead> <tbody> <tr> <td>0</td> <td>No request.</td> </tr> <tr> <td>1</td> <td>Requests an IN transaction.</td> </tr> </tbody> </table> <p>This bit is cleared when the <b>RXRDY</b> bit is set.</p>	Value	Description	0	No request.	1	Requests an IN transaction.
Value	Description									
0	No request.									
1	Requests an IN transaction.									

Bit/Field	Name	Type	Reset	Description
4	ERROR	R/W	0	<p>Error</p> <p>Value Description</p> <p>0 No error.</p> <p>1 Three attempts have been made to perform a transaction with no response from the peripheral. The <code>EP0</code> bit in the <b>USBTXIS</b> register is also set in this situation.</p> <p>Software must clear this bit.</p>
3	SETUP	R/W	0	<p>Setup Packet</p> <p>Value Description</p> <p>0 Sends an OUT token.</p> <p>1 Sends a SETUP token instead of an OUT token for the transaction. This bit should be set at the same time as the <code>TXRDY</code> bit is set.</p> <p>Setting this bit always clears the <code>DT</code> bit in the <b>USBCSRH0</b> register to send a <code>DATA0</code> packet.</p>
2	STALLED	R/W	0	<p>Endpoint Stalled</p> <p>Value Description</p> <p>0 No handshake has been received.</p> <p>1 A STALL handshake has been received.</p> <p>Software must clear this bit.</p>
1	TXRDY	R/W	0	<p>Transmit Packet Ready</p> <p>Value Description</p> <p>0 No transmit packet is ready.</p> <p>1 Software sets this bit after loading a data packet into the TX FIFO. The <code>EP0</code> bit in the <b>USBTXIS</b> register is also set in this situation.</p> <p>If both the <code>TXRDY</code> and <code>SETUP</code> bits are set, a setup packet is sent. If just <code>TXRDY</code> is set, an OUT packet is sent.</p> <p>This bit is cleared automatically when the data packet has been transmitted.</p>
0	RXRDY	R/W	0	<p>Receive Packet Ready</p> <p>Value Description</p> <p>0 No received packet has been received.</p> <p>1 Indicates that a data packet has been received in the RX FIFO. The <code>EP0</code> bit in the <b>USBTXIS</b> register is also set in this situation.</p> <p>Software must clear this bit after the packet has been read from the FIFO to acknowledge that the data has been read from the FIFO.</p>

## OTG B / Device Mode

### USB Control and Status Endpoint 0 Low (USBCSRL0)

Base 0x4005.0000

Offset 0x102

Type W1C, reset 0x00

	7	6	5	4	3	2	1	0
	SETENDC	RXRDYC	STALL	SETEND	DATAEND	STALLED	TXRDY	RXRDY
Type	W1C	W1C	R/W	RO	R/W	R/W	R/W	RO
Reset	0	0	0	0	0	0	0	0

Bit/Field	Name	Type	Reset	Description
7	SETENDC	W1C	0	Setup End Clear Writing a 1 to this bit clears the SETEND bit.
6	RXRDYC	W1C	0	RXRDY Clear Writing a 1 to this bit clears the RXRDY bit.
5	STALL	R/W	0	Send Stall  Value Description 0 No effect. 1 Terminates the current transaction and transmits the STALL handshake.  This bit is cleared automatically after the STALL handshake is transmitted.
4	SETEND	RO	0	Setup End  Value Description 0 A control transaction has not ended or ended after the DATAEND bit was set. 1 A control transaction has ended before the DATAEND bit has been set. The EP0 bit in the <b>USBTXIS</b> register is also set in this situation.  This bit is cleared by writing a 1 to the SETENDC bit.
3	DATAEND	R/W	0	Data End  Value Description 0 No effect. 1 Set this bit in the following situations: <ul style="list-style-type: none"> <li>■ When setting TXRDY for the last data packet</li> <li>■ When clearing RXRDY after unloading the last data packet</li> <li>■ When setting TXRDY for a zero-length data packet</li> </ul> This bit is cleared automatically.

Bit/Field	Name	Type	Reset	Description
2	STALLED	R/W	0	<p>Endpoint Stalled</p> <p>Value Description</p> <p>0 A STALL handshake has not been transmitted.</p> <p>1 A STALL handshake has been transmitted.</p> <p>Software must clear this bit.</p>
1	TXRDY	R/W	0	<p>Transmit Packet Ready</p> <p>Value Description</p> <p>0 No transmit packet is ready.</p> <p>1 Software sets this bit after loading an IN data packet into the TX FIFO. The EP0 bit in the <b>USBTXIS</b> register is also set in this situation.</p> <p>This bit is cleared automatically when the data packet has been transmitted.</p>
0	RXRDY	RO	0	<p>Receive Packet Ready</p> <p>Value Description</p> <p>0 No data packet has been received.</p> <p>1 A data packet has been received. The EP0 bit in the <b>USBTXIS</b> register is also set in this situation.</p> <p>This bit is cleared by writing a 1 to the RXRDYC bit.</p>



## Register 146: USB Control and Status Endpoint 0 High (USBCSRH0), offset 0x103

OTG A /  
Host

USBSR0H is an 8-bit register that provides control and status bits for endpoint 0.

OTG B /  
Device

### OTG A / Host Mode

#### USB Control and Status Endpoint 0 High (USBCSRH0)

Base 0x4005.0000

Offset 0x103

Type W1C, reset 0x00

	7	6	5	4	3	2	1	0
	reserved					DTWE	DT	FLUSH
Type	RO	RO	RO	RO	RO	R/W	R/W	R/W
Reset	0	0	0	0	0	0	0	0

Bit/Field	Name	Type	Reset	Description
7:3	reserved	RO	0x0	Software should not rely on the value of a reserved bit. To provide compatibility with future products, the value of a reserved bit should be preserved across a read-modify-write operation.
2	DTWE	R/W	0	Data Toggle Write Enable  Value Description 0 The DT bit cannot be written. 1 Enables the current state of the endpoint 0 data toggle to be written (see DT bit).  This bit is automatically cleared once the new value is written.
1	DT	R/W	0	Data Toggle  When read, this bit indicates the current state of the endpoint 0 data toggle.  If DTWE is set, this bit may be written with the required setting of the data toggle. If DTWE is Low, this bit cannot be written. Care should be taken when writing to this bit as it should only be changed to RESET USB endpoint 0.

Bit/Field	Name	Type	Reset	Description
0	FLUSH	R/W	0	Flush FIFO

Value	Description
0	No effect.
1	Flushes the next packet to be transmitted/read from the endpoint 0 FIFO. The FIFO pointer is reset and the TXRDY/RXRDY bit is cleared.

This bit is automatically cleared after the flush is performed.

---

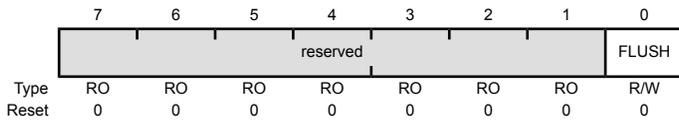
**Important:** This bit should only be set when TXRDY/RXRDY is set. At other times, it may cause data to be corrupted.

---

### OTG B / Device Mode

#### USB Control and Status Endpoint 0 High (USBCSRH0)

Base 0x4005.0000  
 Offset 0x103  
 Type W1C, reset 0x00



Bit/Field	Name	Type	Reset	Description
7:1	reserved	RO	0x00	Software should not rely on the value of a reserved bit. To provide compatibility with future products, the value of a reserved bit should be preserved across a read-modify-write operation.
0	FLUSH	R/W	0	Flush FIFO

Value	Description
0	No effect.
1	Flushes the next packet to be transmitted/read from the endpoint 0 FIFO. The FIFO pointer is reset and the TXRDY/RXRDY bit is cleared.

This bit is automatically cleared after the flush is performed.

---

**Important:** This bit should only be set when TXRDY/RXRDY is set. At other times, it may cause data to be corrupted.

---

**Register 147: USB Receive Byte Count Endpoint 0 (USBCOUNT0), offset 0x108**

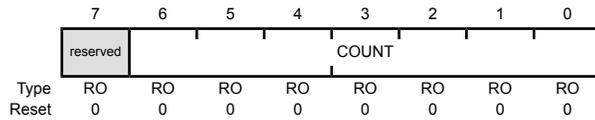
OTG A /  
Host

**USBCOUNT0** is an 8-bit read-only register that indicates the number of received data bytes in the endpoint 0 FIFO. The value returned changes as the contents of the FIFO change and is only valid while the `RXRDY` bit is set.

OTG B /  
Device

USB Receive Byte Count Endpoint 0 (USBCOUNT0)

Base 0x4005.0000  
Offset 0x108  
Type RO, reset 0x00



Bit/Field	Name	Type	Reset	Description
7	reserved	RO	0	Software should not rely on the value of a reserved bit. To provide compatibility with future products, the value of a reserved bit should be preserved across a read-modify-write operation.
6:0	COUNT	RO	0x00	FIFO Count  COUNT is a read-only value that indicates the number of received data bytes in the endpoint 0 FIFO.

### Register 148: USB Type Endpoint 0 (USBTYPE0), offset 0x10A

OTG A /  
Host

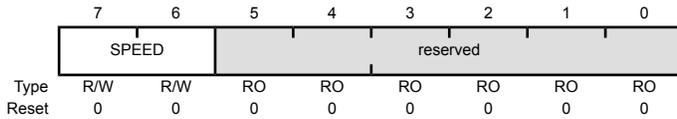
This is an 8-bit register that must be written with the operating speed of the targeted Device being communicated with using endpoint 0.

USB Type Endpoint 0 (USBTYPE0)

Base 0x4005.0000

Offset 0x10A

Type R/W, reset 0x00



Bit/Field	Name	Type	Reset	Description
-----------	------	------	-------	-------------

7:6	SPEED	R/W	0x0	Operating Speed
-----	-------	-----	-----	-----------------

This field specifies the operating speed of the target Device. If selected, the target is assumed to have the same connection speed as the USB controller.

Value	Description
0x0 - 0x1	Reserved
0x2	Full
0x3	Low

5:0	reserved	RO	0x0	Software should not rely on the value of a reserved bit. To provide compatibility with future products, the value of a reserved bit should be preserved across a read-modify-write operation.
-----	----------	----	-----	---

Software should not rely on the value of a reserved bit. To provide compatibility with future products, the value of a reserved bit should be preserved across a read-modify-write operation.

**Register 149: USB NAK Limit (USBNAKLMT), offset 0x10B**

OTG A /  
Host

**USBNAKLMT** is an 8-bit register that sets the number of frames after which endpoint 0 should time out on receiving a stream of NAK responses. (Equivalent settings for other endpoints can be made through their **USBTXINTERVALn** and **USBRXINTERVALn** registers.)

The number of frames selected is  $2^{(m-1)}$  (where  $m$  is the value set in the register, with valid values of 2–16). If the Host receives NAK responses from the target for more frames than the number represented by the limit set in this register, the endpoint is halted.

**Note:** A value of 0 or 1 disables the NAK timeout function.

**USB NAK Limit (USBNAKLMT)**

Base 0x4005.0000  
Offset 0x10B  
Type R/W, reset 0x00

	7	6	5	4	3	2	1	0
	reserved			NAKLMT				
Type	RO	RO	RO	R/W	R/W	R/W	R/W	R/W
Reset	0	0	0	0	0	0	0	0

Bit/Field	Name	Type	Reset	Description
7:5	reserved	RO	0x0	Software should not rely on the value of a reserved bit. To provide compatibility with future products, the value of a reserved bit should be preserved across a read-modify-write operation.
4:0	NAKLMT	R/W	0x0	EP0 NAK Limit  This field specifies the number of frames after receiving a stream of NAK responses.

**Register 150: USB Transmit Control and Status Endpoint 1 Low (USBTXCSRL1), offset 0x112**

**Register 151: USB Transmit Control and Status Endpoint 2 Low (USBTXCSRL2), offset 0x122**

**Register 152: USB Transmit Control and Status Endpoint 3 Low (USBTXCSRL3), offset 0x132**

**Register 153: USB Transmit Control and Status Endpoint 4 Low (USBTXCSRL4), offset 0x142**

**Register 154: USB Transmit Control and Status Endpoint 5 Low (USBTXCSRL5), offset 0x152**

**Register 155: USB Transmit Control and Status Endpoint 6 Low (USBTXCSRL6), offset 0x162**

**Register 156: USB Transmit Control and Status Endpoint 7 Low (USBTXCSRL7), offset 0x172**

**Register 157: USB Transmit Control and Status Endpoint 8 Low (USBTXCSRL8), offset 0x182**

**Register 158: USB Transmit Control and Status Endpoint 9 Low (USBTXCSRL9), offset 0x192**

**Register 159: USB Transmit Control and Status Endpoint 10 Low (USBTXCSRL10), offset 0x1A2**

**Register 160: USB Transmit Control and Status Endpoint 11 Low (USBTXCSRL11), offset 0x1B2**

**Register 161: USB Transmit Control and Status Endpoint 12 Low (USBTXCSRL12), offset 0x1C2**

**Register 162: USB Transmit Control and Status Endpoint 13 Low (USBTXCSRL13), offset 0x1D2**

**Register 163: USB Transmit Control and Status Endpoint 14 Low (USBTXCSRL14), offset 0x1E2**

**Register 164: USB Transmit Control and Status Endpoint 15 Low (USBTXCSRL15), offset 0x1F2**

OTG A /  
Host

USBTXCSRL<sub>n</sub> is an 8-bit register that provides control and status bits for transfers through the currently selected transmit endpoint.

OTG B /  
Device

## OTG A / Host Mode

### USB Transmit Control and Status Endpoint 1 Low (USBTXCSRL1)

Base 0x4005.0000

Offset 0x112

Type R/W, reset 0x00

	7	6	5	4	3	2	1	0
	NAKTO	CLRDT	STALLED	SETUP	FLUSH	ERROR	FIFONE	TXRDY
Type	R/W	R/W	R/W	R/W	R/W	R/W	R/W	R/W
Reset	0	0	0	0	0	0	0	0

Bit/Field	Name	Type	Reset	Description
7	NAKTO	R/W	0	<p>NAK Timeout</p> <p>Value Description</p> <p>0 No timeout.</p> <p>1 <i>Bulk endpoints only:</i> Indicates that the transmit endpoint is halted following the receipt of NAK responses for longer than the time set by the NAKLMT field in the <b>USBTXINTERVALn</b> register. Software must clear this bit to allow the endpoint to continue.</p>
6	CLRDT	R/W	0	<p>Clear Data Toggle</p> <p>Writing a 1 to this bit clears the DT bit in the <b>USBTXCSRHn</b> register.</p>
5	STALLED	R/W	0	<p>Endpoint Stalled</p> <p>Value Description</p> <p>0 A STALL handshake has not been received.</p> <p>1 Indicates that a STALL handshake has been received. When this bit is set, any <math>\mu</math>DMA request that is in progress is stopped, the FIFO is completely flushed, and the TXRDY bit is cleared.</p> <p>Software must clear this bit.</p>
4	SETUP	R/W	0	<p>Setup Packet</p> <p>Value Description</p> <p>0 No SETUP token is sent.</p> <p>1 Sends a SETUP token instead of an OUT token for the transaction. This bit should be set at the same time as the TXRDY bit is set.</p> <p><b>Note:</b> Setting this bit also clears the DT bit in the <b>USBTXCSRHn</b> register.</p>

Bit/Field	Name	Type	Reset	Description
3	FLUSH	R/W	0	<p>Flush FIFO</p> <p>Value Description</p> <p>0 No effect.</p> <p>1 Flushes the latest packet from the endpoint transmit FIFO. The FIFO pointer is reset and the TXRDY bit is cleared. The EPn bit in the <b>USBTXIS</b> register is also set in this situation.</p> <p>This bit may be set simultaneously with the TXRDY bit to abort the packet that is currently being loaded into the FIFO. Note that if the FIFO is double-buffered, FLUSH may have to be set twice to completely clear the FIFO.</p> <hr/> <p><b>Important:</b> This bit should only be set when the TXRDY bit is set. At other times, it may cause data to be corrupted.</p> <hr/>
2	ERROR	R/W	0	<p>Error</p> <p>Value Description</p> <p>0 No error.</p> <p>1 Three attempts have been made to send a packet and no handshake packet has been received. The TXRDY bit is cleared, the EPn bit in the <b>USBTXIS</b> register is set, and the FIFO is completely flushed in this situation.</p> <p>Software must clear this bit.</p> <p><b>Note:</b> This is valid only when the endpoint is operating in Bulk or Interrupt mode.</p>
1	FIFONE	R/W	0	<p>FIFO Not Empty</p> <p>Value Description</p> <p>0 The FIFO is empty.</p> <p>1 At least one packet is in the transmit FIFO.</p>
0	TXRDY	R/W	0	<p>Transmit Packet Ready</p> <p>Value Description</p> <p>0 No transmit packet is ready.</p> <p>1 Software sets this bit after loading a data packet into the TX FIFO.</p> <p>This bit is cleared automatically when a data packet has been transmitted. The EPn bit in the <b>USBTXIS</b> register is also set at this point. TXRDY is also automatically cleared prior to loading a second packet into a double-buffered FIFO.</p>



## OTG B / Device Mode

### USB Transmit Control and Status Endpoint 1 Low (USBTXCSRL1)

Base 0x4005.0000

Offset 0x112

Type R/W, reset 0x00

	7	6	5	4	3	2	1	0
	reserved	CLRDT	STALLED	STALL	FLUSH	UNDRN	FIFONE	TXRDY
Type	RO	R/W	R/W	R/W	R/W	R/W	R/W	R/W
Reset	0	0	0	0	0	0	0	0

Bit/Field	Name	Type	Reset	Description
7	reserved	RO	0	Software should not rely on the value of a reserved bit. To provide compatibility with future products, the value of a reserved bit should be preserved across a read-modify-write operation.
6	CLRDT	R/W	0	Clear Data Toggle Writing a 1 to this bit clears the DT bit in the <b>USBTXCSRHn</b> register.
5	STALLED	R/W	0	Endpoint Stalled  Value Description 0 A STALL handshake has not been transmitted. 1 A STALL handshake has been transmitted. The FIFO is flushed and the TXRDY bit is cleared.  Software must clear this bit.
4	STALL	R/W	0	Send STALL  Value Description 0 No effect. 1 Issues a STALL handshake to an IN token.  Software clears this bit to terminate the STALL condition. <b>Note:</b> This bit has no effect in isochronous transfers.
3	FLUSH	R/W	0	Flush FIFO  Value Description 0 No effect. 1 Flushes the latest packet from the endpoint transmit FIFO. The FIFO pointer is reset and the TXRDY bit is cleared. The EPn bit in the <b>USBTXIS</b> register is also set in this situation.  This bit may be set simultaneously with the TXRDY bit to abort the packet that is currently being loaded into the FIFO. Note that if the FIFO is double-buffered, FLUSH may have to be set twice to completely clear the FIFO.  <b>Important:</b> This bit should only be set when the TXRDY bit is set. At other times, it may cause data to be corrupted.

Bit/Field	Name	Type	Reset	Description
2	UNDRN	R/W	0	<p>Underrun</p> <p>Value Description</p> <p>0 No underrun.</p> <p>1 An IN token has been received when <code>TXRDY</code> is not set.</p> <p>Software must clear this bit.</p>
1	FIFONE	R/W	0	<p>FIFO Not Empty</p> <p>Value Description</p> <p>0 The FIFO is empty.</p> <p>1 At least one packet is in the transmit FIFO.</p>
0	TXRDY	R/W	0	<p>Transmit Packet Ready</p> <p>Value Description</p> <p>0 No transmit packet is ready.</p> <p>1 Software sets this bit after loading a data packet into the TX FIFO.</p> <p>This bit is cleared automatically when a data packet has been transmitted. The <code>EPn</code> bit in the <b>USBTXIS</b> register is also set at this point. <code>TXRDY</code> is also automatically cleared prior to loading a second packet into a double-buffered FIFO.</p>

**Register 165: USB Transmit Control and Status Endpoint 1 High (USBTXCSRH1), offset 0x113**

**Register 166: USB Transmit Control and Status Endpoint 2 High (USBTXCSRH2), offset 0x123**

**Register 167: USB Transmit Control and Status Endpoint 3 High (USBTXCSRH3), offset 0x133**

**Register 168: USB Transmit Control and Status Endpoint 4 High (USBTXCSRH4), offset 0x143**

**Register 169: USB Transmit Control and Status Endpoint 5 High (USBTXCSRH5), offset 0x153**

**Register 170: USB Transmit Control and Status Endpoint 6 High (USBTXCSRH6), offset 0x163**

**Register 171: USB Transmit Control and Status Endpoint 7 High (USBTXCSRH7), offset 0x173**

**Register 172: USB Transmit Control and Status Endpoint 8 High (USBTXCSRH8), offset 0x183**

**Register 173: USB Transmit Control and Status Endpoint 9 High (USBTXCSRH9), offset 0x193**

**Register 174: USB Transmit Control and Status Endpoint 10 High (USBTXCSRH10), offset 0x1A3**

**Register 175: USB Transmit Control and Status Endpoint 11 High (USBTXCSRH11), offset 0x1B3**

**Register 176: USB Transmit Control and Status Endpoint 12 High (USBTXCSRH12), offset 0x1C3**

**Register 177: USB Transmit Control and Status Endpoint 13 High (USBTXCSRH13), offset 0x1D3**

**Register 178: USB Transmit Control and Status Endpoint 14 High (USBTXCSRH14), offset 0x1E3**

**Register 179: USB Transmit Control and Status Endpoint 15 High (USBTXCSRH15), offset 0x1F3**

OTG A /  
Host

**USBTXCSRHn** is an 8-bit register that provides additional control for transfers through the currently selected transmit endpoint.

OTG B /  
Device

**OTG A / Host Mode**

**USB Transmit Control and Status Endpoint 1 High (USBTXCSRH1)**

Base 0x4005.0000  
 Offset 0x113  
 Type R/W, reset 0x00

	7	6	5	4	3	2	1	0
	AUTOSET	reserved	MODE	DMAEN	FDT	DMAMOD	DTWE	DT
Type	R/W	RO	R/W	R/W	R/W	R/W	R/W	R/W
Reset	0	0	0	0	0	0	0	0

Bit/Field	Name	Type	Reset	Description
7	AUTOSET	R/W	0	<p>Auto Set</p> <p>Value Description</p> <p>0 The <b>TXRDY</b> bit must be set manually.</p> <p>1 Enables the <b>TXRDY</b> bit to be automatically set when data of the maximum packet size (value in <b>USBTXMAXPn</b>) is loaded into the transmit FIFO. If a packet of less than the maximum packet size is loaded, then the <b>TXRDY</b> bit must be set manually.</p>
6	reserved	RO	0	Software should not rely on the value of a reserved bit. To provide compatibility with future products, the value of a reserved bit should be preserved across a read-modify-write operation.
5	MODE	R/W	0	<p>Mode</p> <p>Value Description</p> <p>0 Enables the endpoint direction as RX.</p> <p>1 Enables the endpoint direction as TX.</p> <p><b>Note:</b> This bit only has an effect when the same endpoint FIFO is used for both transmit and receive transactions.</p>
4	DMAEN	R/W	0	<p>DMA Request Enable</p> <p>Value Description</p> <p>0 Disables the <math>\mu</math>DMA request for the transmit endpoint.</p> <p>1 Enables the <math>\mu</math>DMA request for the transmit endpoint.</p> <p><b>Note:</b> 3 TX and 3 /RX endpoints can be connected to the <math>\mu</math>DMA module. If this bit is set for a particular endpoint, the <b>DMAATX</b>, <b>DMABTX</b>, or <b>DMACTX</b> field in the <b>USB DMA Select (USBDMASEL)</b> register must be programmed correspondingly.</p>
3	FDT	R/W	0	<p>Force Data Toggle</p> <p>Value Description</p> <p>0 No effect.</p> <p>1 Forces the endpoint <b>DT</b> bit to switch and the data packet to be cleared from the FIFO, regardless of whether an ACK was received. This bit can be used by interrupt transmit endpoints that are used to communicate rate feedback for isochronous endpoints.</p>

Bit/Field	Name	Type	Reset	Description
2	DMAMOD	R/W	0	DMA Request Mode  Value Description 0 An interrupt is generated after every $\mu$ DMA packet transfer. 1 An interrupt is generated only after the entire $\mu$ DMA transfer is complete.  <b>Note:</b> This bit must not be cleared either before or in the same cycle as the above DMAEN bit is cleared.
1	DTWE	R/W	0	Data Toggle Write Enable  Value Description 0 The DT bit cannot be written. 1 Enables the current state of the transmit endpoint data to be written (see DT bit).  This bit is automatically cleared once the new value is written.
0	DT	R/W	0	Data Toggle  When read, this bit indicates the current state of the transmit endpoint data toggle.  If DTWE is High, this bit may be written with the required setting of the data toggle. If DTWE is Low, any value written to this bit is ignored. Care should be taken when writing to this bit as it should only be changed to RESET the transmit endpoint.

## OTG B / Device Mode

### USB Transmit Control and Status Endpoint 1 High (USBTXCSRH1)

Base 0x4005.0000  
Offset 0x113  
Type R/W, reset 0x00

	7	6	5	4	3	2	1	0
	AUTOSET	ISO	MODE	DMAEN	FDT	DMAMOD	reserved	reserved
Type	R/W	R/W	R/W	R/W	R/W	R/W	RO	RO
Reset	0	0	0	0	0	0	0	0

Bit/Field	Name	Type	Reset	Description
7	AUTOSET	R/W	0	Auto Set  Value Description 0 The TXRDY bit must be set manually. 1 Enables the TXRDY bit to be automatically set when data of the maximum packet size (value in USBTXMAXPn) is loaded into the transmit FIFO. If a packet of less than the maximum packet size is loaded, then the TXRDY bit must be set manually.

Bit/Field	Name	Type	Reset	Description
6	ISO	R/W	0	<p>Isochronous Transfers</p> <p>Value Description</p> <p>0 Enables the transmit endpoint for bulk or interrupt transfers.</p> <p>1 Enables the transmit endpoint for isochronous transfers.</p>
5	MODE	R/W	0	<p>Mode</p> <p>Value Description</p> <p>0 Enables the endpoint direction as RX.</p> <p>1 Enables the endpoint direction as TX.</p> <p><b>Note:</b> This bit only has an effect where the same endpoint FIFO is used for both transmit and receive transactions.</p>
4	DMAEN	R/W	0	<p>DMA Request Enable</p> <p>Value Description</p> <p>0 Disables the <math>\mu</math>DMA request for the transmit endpoint.</p> <p>1 Enables the <math>\mu</math>DMA request for the transmit endpoint.</p> <p><b>Note:</b> 3 TX and 3 RX endpoints can be connected to the <math>\mu</math>DMA module. If this bit is set for a particular endpoint, the <i>DMAATX</i>, <i>DMABTX</i>, or <i>DMACTX</i> field in the <b>USB DMA Select (USBDMASEL)</b> register must be programmed correspondingly.</p>
3	FDT	R/W	0	<p>Force Data Toggle</p> <p>Value Description</p> <p>0 No effect.</p> <p>1 Forces the endpoint <i>DT</i> bit to switch and the data packet to be cleared from the FIFO, regardless of whether an ACK was received. This bit can be used by interrupt transmit endpoints that are used to communicate rate feedback for isochronous endpoints.</p>
2	DMAMOD	R/W	0	<p>DMA Request Mode</p> <p>Value Description</p> <p>0 An interrupt is generated after every <math>\mu</math>DMA packet transfer.</p> <p>1 An interrupt is generated only after the entire <math>\mu</math>DMA transfer is complete.</p> <p><b>Note:</b> This bit must not be cleared either before or in the same cycle as the above <i>DMAEN</i> bit is cleared.</p>
1:0	reserved	RO	0x0	Software should not rely on the value of a reserved bit. To provide compatibility with future products, the value of a reserved bit should be preserved across a read-modify-write operation.

**Register 180: USB Maximum Receive Data Endpoint 1 (USBRXMAXP1), offset 0x114**

**Register 181: USB Maximum Receive Data Endpoint 2 (USBRXMAXP2), offset 0x124**

**Register 182: USB Maximum Receive Data Endpoint 3 (USBRXMAXP3), offset 0x134**

**Register 183: USB Maximum Receive Data Endpoint 4 (USBRXMAXP4), offset 0x144**

**Register 184: USB Maximum Receive Data Endpoint 5 (USBRXMAXP5), offset 0x154**

**Register 185: USB Maximum Receive Data Endpoint 6 (USBRXMAXP6), offset 0x164**

**Register 186: USB Maximum Receive Data Endpoint 7 (USBRXMAXP7), offset 0x174**

**Register 187: USB Maximum Receive Data Endpoint 8 (USBRXMAXP8), offset 0x184**

**Register 188: USB Maximum Receive Data Endpoint 9 (USBRXMAXP9), offset 0x194**

**Register 189: USB Maximum Receive Data Endpoint 10 (USBRXMAXP10), offset 0x1A4**

**Register 190: USB Maximum Receive Data Endpoint 11 (USBRXMAXP11), offset 0x1B4**

**Register 191: USB Maximum Receive Data Endpoint 12 (USBRXMAXP12), offset 0x1C4**

**Register 192: USB Maximum Receive Data Endpoint 13 (USBRXMAXP13), offset 0x1D4**

**Register 193: USB Maximum Receive Data Endpoint 14 (USBRXMAXP14), offset 0x1E4**

**Register 194: USB Maximum Receive Data Endpoint 15 (USBRXMAXP15), offset 0x1F4**

**OTG A /  
Host**

The **USBRXMAXP<sub>n</sub>** is a 16-bit register which defines the maximum amount of data that can be transferred through the selected receive endpoint in a single operation.

**OTG B /  
Device**

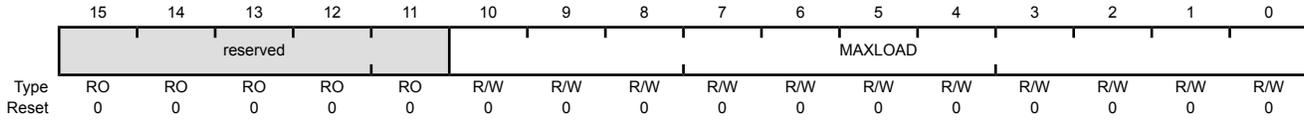
Bits 10:0 define (in bytes) the maximum payload transmitted in a single transaction. The value set can be up to 1024 bytes but is subject to the constraints placed by the *USB Specification* on packet sizes for bulk, interrupt and isochronous transfers in full-speed operations.

The total amount of data represented by the value written to this register must not exceed the FIFO size for the receive endpoint, and must not exceed half the FIFO size if double-buffering is required.

**Note:** **USBRXMAXPn** must be set to an even number of bytes for proper interrupt generation in  $\mu$ DMA Basic mode.

USB Maximum Receive Data Endpoint 1 (USBRXMAXP1)

Base 0x4005.0000  
 Offset 0x114  
 Type R/W, reset 0x0000



Bit/Field	Name	Type	Reset	Description
15:11	reserved	RO	0x0	Software should not rely on the value of a reserved bit. To provide compatibility with future products, the value of a reserved bit should be preserved across a read-modify-write operation.
10:0	MAXLOAD	R/W	0x000	Maximum Payload The maximum payload in bytes per transaction.



**Register 195: USB Receive Control and Status Endpoint 1 Low (USBXCSRL1), offset 0x116**

**Register 196: USB Receive Control and Status Endpoint 2 Low (USBXCSRL2), offset 0x126**

**Register 197: USB Receive Control and Status Endpoint 3 Low (USBXCSRL3), offset 0x136**

**Register 198: USB Receive Control and Status Endpoint 4 Low (USBXCSRL4), offset 0x146**

**Register 199: USB Receive Control and Status Endpoint 5 Low (USBXCSRL5), offset 0x156**

**Register 200: USB Receive Control and Status Endpoint 6 Low (USBXCSRL6), offset 0x166**

**Register 201: USB Receive Control and Status Endpoint 7 Low (USBXCSRL7), offset 0x176**

**Register 202: USB Receive Control and Status Endpoint 8 Low (USBXCSRL8), offset 0x186**

**Register 203: USB Receive Control and Status Endpoint 9 Low (USBXCSRL9), offset 0x196**

**Register 204: USB Receive Control and Status Endpoint 10 Low (USBXCSRL10), offset 0x1A6**

**Register 205: USB Receive Control and Status Endpoint 11 Low (USBXCSRL11), offset 0x1B6**

**Register 206: USB Receive Control and Status Endpoint 12 Low (USBXCSRL12), offset 0x1C6**

**Register 207: USB Receive Control and Status Endpoint 13 Low (USBXCSRL13), offset 0x1D6**

**Register 208: USB Receive Control and Status Endpoint 14 Low (USBXCSRL14), offset 0x1E6**

**Register 209: USB Receive Control and Status Endpoint 15 Low (USBXCSRL15), offset 0x1F6**

OTG A /  
Host

**USBXCSRL<sub>n</sub>** is an 8-bit register that provides control and status bits for transfers through the currently selected receive endpoint.

OTG B /  
Device

**OTG A / Host Mode**

USB Receive Control and Status Endpoint 1 Low (USBXCSRL1)

Base 0x4005.0000  
 Offset 0x116  
 Type R/W, reset 0x00

	7	6	5	4	3	2	1	0
	CLRDT	STALLED	REQPKT	FLUSH	DATAERR / NAKTO	ERROR	FULL	RXRDY
Type	W1C	R/W	R/W	R/W	R/W	R/W	RO	R/W
Reset	0	0	0	0	0	0	0	0

Bit/Field	Name	Type	Reset	Description
7	CLRDT	W1C	0	Clear Data Toggle Writing a 1 to this bit clears the DT bit in the <b>USBXCSRHn</b> register.
6	STALLED	R/W	0	Endpoint Stalled  Value Description 0 A STALL handshake has not been received. 1 A STALL handshake has been received. The EPn bit in the <b>USBXIS</b> register is also set.  Software must clear this bit.
5	REQPKT	R/W	0	Request Packet  Value Description 0 No request. 1 Requests an IN transaction.  This bit is cleared when RXRDY is set.
4	FLUSH	R/W	0	Flush FIFO  Value Description 0 No effect. 1 Flushes the next packet to be read from the endpoint receive FIFO. The FIFO pointer is reset and the RXRDY bit is cleared.  Note that if the FIFO is double-buffered, FLUSH may have to be set twice to completely clear the FIFO.

**Important:** This bit should only be set when the RXRDY bit is set. At other times, it may cause data to be corrupted.

Bit/Field	Name	Type	Reset	Description
3	DATAERR / NAKTO	R/W	0	<p>Data Error / NAK Timeout</p> <p>Value Description</p> <p>0 Normal operation.</p> <p>1 <i>Isochronous endpoints only:</i> Indicates that <code>RXRDY</code> is set and the data packet has a CRC or bit-stuff error. This bit is cleared when <code>RXRDY</code> is cleared.</p> <p><i>Bulk endpoints only:</i> Indicates that the receive endpoint is halted following the receipt of NAK responses for longer than the time set by the <code>NAKLMT</code> field in the <code>USBXINTERVALn</code> register. Software must clear this bit to allow the endpoint to continue.</p>
2	ERROR	R/W	0	<p>Error</p> <p>Value Description</p> <p>0 No error.</p> <p>1 Three attempts have been made to receive a packet and no data packet has been received. The <code>EPn</code> bit in the <code>USBXIS</code> register is set in this situation.</p> <p>Software must clear this bit.</p> <p><b>Note:</b> This bit is only valid when the receive endpoint is operating in Bulk or Interrupt mode. In Isochronous mode, it always returns zero.</p>
1	FULL	RO	0	<p>FIFO Full</p> <p>Value Description</p> <p>0 The receive FIFO is not full.</p> <p>1 No more packets can be loaded into the receive FIFO.</p>
0	RXRDY	R/W	0	<p>Receive Packet Ready</p> <p>Value Description</p> <p>0 No data packet has been received.</p> <p>1 A data packet has been received. The <code>EPn</code> bit in the <code>USBXIS</code> register is also set in this situation.</p> <p>If the <code>AUTOCLR</code> bit in the <code>USBXCSRHn</code> register is set, then this bit is automatically cleared when a packet of <code>USBXMAXPn</code> bytes has been unloaded from the receive FIFO. If the <code>AUTOCLR</code> bit is clear, or if packets of less than the maximum packet size are unloaded, then software must clear this bit manually when the packet has been unloaded from the receive FIFO.</p>

**OTG B / Device Mode**

USB Receive Control and Status Endpoint 1 Low (USBXCSRL1)

Base 0x4005.0000  
 Offset 0x116  
 Type R/W, reset 0x00

	7	6	5	4	3	2	1	0
	CLRDT	STALLED	STALL	FLUSH	DATAERR	OVER	FULL	RXRDY
Type	W1C	R/W	R/W	R/W	RO	R/W	RO	R/W
Reset	0	0	0	0	0	0	0	0

Bit/Field	Name	Type	Reset	Description
7	CLRDT	W1C	0	Clear Data Toggle Writing a 1 to this bit clears the DT bit in the <b>USBXCSRHn</b> register.
6	STALLED	R/W	0	Endpoint Stalled  Value Description 0 A STALL handshake has not been transmitted. 1 A STALL handshake has been transmitted.  Software must clear this bit.
5	STALL	R/W	0	Send STALL  Value Description 0 No effect. 1 Issues a STALL handshake.  Software must clear this bit to terminate the STALL condition.  <b>Note:</b> This bit has no effect where the endpoint is being used for isochronous transfers.
4	FLUSH	R/W	0	Flush FIFO  Value Description 0 No effect. 1 Flushes the next packet from the endpoint receive FIFO. The FIFO pointer is reset and the RXRDY bit is cleared.  The CPU writes a 1 to this bit to flush the next packet to be read from the endpoint receive FIFO. The FIFO pointer is reset and the RXRDY bit is cleared. Note that if the FIFO is double-buffered, FLUSH may have to be set twice to completely clear the FIFO.  <b>Important:</b> This bit should only be set when the RXRDY bit is set. At other times, it may cause data to be corrupted.

Bit/Field	Name	Type	Reset	Description
3	DATAERR	RO	0	<p>Data Error</p> <p>Value Description</p> <p>0 Normal operation.</p> <p>1 Indicates that <code>RXRDY</code> is set and the data packet has a CRC or bit-stuff error.</p> <p>This bit is cleared when <code>RXRDY</code> is cleared.</p> <p><b>Note:</b> This bit is only valid when the endpoint is operating in Isochronous mode. In Bulk mode, it always returns zero.</p>
2	OVER	R/W	0	<p>Overrun</p> <p>Value Description</p> <p>0 No overrun error.</p> <p>1 Indicates that an OUT packet cannot be loaded into the receive FIFO.</p> <p>Software must clear this bit.</p> <p><b>Note:</b> This bit is only valid when the endpoint is operating in Isochronous mode. In Bulk mode, it always returns zero.</p>
1	FULL	RO	0	<p>FIFO Full</p> <p>Value Description</p> <p>0 The receive FIFO is not full.</p> <p>1 No more packets can be loaded into the receive FIFO.</p>
0	RXRDY	R/W	0	<p>Receive Packet Ready</p> <p>Value Description</p> <p>0 No data packet has been received.</p> <p>1 A data packet has been received. The <code>EPn</code> bit in the <code>USBRXIS</code> register is also set in this situation.</p> <p>If the <code>AUTOCLR</code> bit in the <code>USBRXCSRHn</code> register is set, then the this bit is automatically cleared when a packet of <code>USBRXMAXPn</code> bytes has been unloaded from the receive FIFO. If the <code>AUTOCLR</code> bit is clear, or if packets of less than the maximum packet size are unloaded, then software must clear this bit manually when the packet has been unloaded from the receive FIFO.</p>

**Register 210: USB Receive Control and Status Endpoint 1 High (USBXCSRH1), offset 0x117**

**Register 211: USB Receive Control and Status Endpoint 2 High (USBXCSRH2), offset 0x127**

**Register 212: USB Receive Control and Status Endpoint 3 High (USBXCSRH3), offset 0x137**

**Register 213: USB Receive Control and Status Endpoint 4 High (USBXCSRH4), offset 0x147**

**Register 214: USB Receive Control and Status Endpoint 5 High (USBXCSRH5), offset 0x157**

**Register 215: USB Receive Control and Status Endpoint 6 High (USBXCSRH6), offset 0x167**

**Register 216: USB Receive Control and Status Endpoint 7 High (USBXCSRH7), offset 0x177**

**Register 217: USB Receive Control and Status Endpoint 8 High (USBXCSRH8), offset 0x187**

**Register 218: USB Receive Control and Status Endpoint 9 High (USBXCSRH9), offset 0x197**

**Register 219: USB Receive Control and Status Endpoint 10 High (USBXCSRH10), offset 0x1A7**

**Register 220: USB Receive Control and Status Endpoint 11 High (USBXCSRH11), offset 0x1B7**

**Register 221: USB Receive Control and Status Endpoint 12 High (USBXCSRH12), offset 0x1C7**

**Register 222: USB Receive Control and Status Endpoint 13 High (USBXCSRH13), offset 0x1D7**

**Register 223: USB Receive Control and Status Endpoint 14 High (USBXCSRH14), offset 0x1E7**

**Register 224: USB Receive Control and Status Endpoint 15 High (USBXCSRH15), offset 0x1F7**

OTG A /  
Host

**USBXCSRHn** is an 8-bit register that provides additional control and status bits for transfers through the currently selected receive endpoint.

OTG B /  
Device

## OTG A / Host Mode

### USB Receive Control and Status Endpoint 1 High (USBXRCSRH1)

Base 0x4005.0000

Offset 0x117

Type R/W, reset 0x00

	7	6	5	4	3	2	1	0
	AUTOCL	AUTORQ	DMAEN	PIDERR	DMAMOD	DTWE	DT	reserved
Type	R/W	R/W	R/W	RO	R/W	RO	RO	RO
Reset	0	0	0	0	0	0	0	0

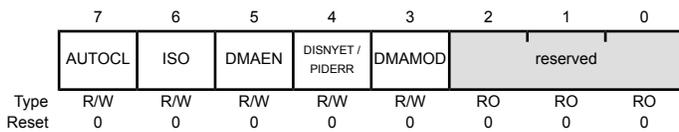
Bit/Field	Name	Type	Reset	Description
7	AUTOCL	R/W	0	<p>Auto Clear</p> <p>Value Description</p> <p>0 No effect.</p> <p>1 Enables the <code>RXRDY</code> bit to be automatically cleared when a packet of <code>USBRXMAXPn</code> bytes has been unloaded from the receive FIFO. When packets of less than the maximum packet size are unloaded, <code>RXRDY</code> must be cleared manually. Care must be taken when using <math>\mu</math>DMA to unload the receive FIFO as data is read from the receive FIFO in 4 byte chunks regardless of the value of the <code>MAXLOAD</code> field in the <code>USBRXMAXPn</code> register, see "DMA Operation" on page 889.</p>
6	AUTORQ	R/W	0	<p>Auto Request</p> <p>Value Description</p> <p>0 No effect.</p> <p>1 Enables the <code>REQPKT</code> bit to be automatically set when the <code>RXRDY</code> bit is cleared.</p> <p><b>Note:</b> This bit is automatically cleared when a short packet is received.</p>
5	DMAEN	R/W	0	<p>DMA Request Enable</p> <p>Value Description</p> <p>0 Disables the <math>\mu</math>DMA request for the receive endpoint.</p> <p>1 Enables the <math>\mu</math>DMA request for the receive endpoint.</p> <p><b>Note:</b> 3 TX and 3 RX endpoints can be connected to the <math>\mu</math>DMA module. If this bit is set for a particular endpoint, the <code>DMAARX</code>, <code>DMABRX</code>, or <code>DMACRX</code> field in the <b>USB DMA Select (USBDMASEL)</b> register must be programmed correspondingly.</p>
4	PIDERR	RO	0	<p>PID Error</p> <p>Value Description</p> <p>0 No error.</p> <p>1 Indicates a PID error in the received packet of an isochronous transaction.</p> <p>This bit is ignored in bulk or interrupt transactions.</p>

Bit/Field	Name	Type	Reset	Description
3	DMAMOD	R/W	0	<p>DMA Request Mode</p> <p>Value Description</p> <p>0 An interrupt is generated after every <math>\mu</math>DMA packet transfer.</p> <p>1 An interrupt is generated only after the entire <math>\mu</math>DMA transfer is complete.</p> <p><b>Note:</b> This bit must not be cleared either before or in the same cycle as the above DMAEN bit is cleared.</p>
2	DTWE	RO	0	<p>Data Toggle Write Enable</p> <p>Value Description</p> <p>0 The DT bit cannot be written.</p> <p>1 Enables the current state of the receive endpoint data to be written (see DT bit).</p> <p>This bit is automatically cleared once the new value is written.</p>
1	DT	RO	0	<p>Data Toggle</p> <p>When read, this bit indicates the current state of the receive data toggle.</p> <p>If DTWE is High, this bit may be written with the required setting of the data toggle. If DTWE is Low, any value written to this bit is ignored. Care should be taken when writing to this bit as it should only be changed to RESET the receive endpoint.</p>
0	reserved	RO	0	<p>Software should not rely on the value of a reserved bit. To provide compatibility with future products, the value of a reserved bit should be preserved across a read-modify-write operation.</p>

**OTG B / Device Mode**

**USB Receive Control and Status Endpoint 1 High (USBXCSRH1)**

Base 0x4005.0000  
 Offset 0x117  
 Type R/W, reset 0x00





Bit/Field	Name	Type	Reset	Description
7	AUTOCL	R/W	0	<p>Auto Clear</p> <p>Value Description</p> <p>0 No effect.</p> <p>1 Enables the <code>RXRDY</code> bit to be automatically cleared when a packet of <b>USBRXMAXPn</b> bytes has been unloaded from the receive FIFO. When packets of less than the maximum packet size are unloaded, <code>RXRDY</code> must be cleared manually. Care must be taken when using <math>\mu</math>DMA to unload the receive FIFO as data is read from the receive FIFO in 4 byte chunks regardless of the value of the <code>MAXLOAD</code> field in the <b>USBRXMAXPn</b> register, see "DMA Operation" on page 889.</p>
6	ISO	R/W	0	<p>Isochronous Transfers</p> <p>Value Description</p> <p>0 Enables the receive endpoint for isochronous transfers.</p> <p>1 Enables the receive endpoint for bulk/interrupt transfers.</p>
5	DMAEN	R/W	0	<p>DMA Request Enable</p> <p>Value Description</p> <p>0 Disables the <math>\mu</math>DMA request for the receive endpoint.</p> <p>1 Enables the <math>\mu</math>DMA request for the receive endpoint.</p> <p><b>Note:</b> 3 TX and 3 RX endpoints can be connected to the <math>\mu</math>DMA module. If this bit is set for a particular endpoint, the <code>DMAARX</code>, <code>DMABRX</code>, or <code>DMACRX</code> field in the <b>USB DMA Select (USBDMASEL)</b> register must be programmed correspondingly.</p>
4	DISNYET / PIDERR	R/W	0	<p>Disable NYET / PID Error</p> <p>Value Description</p> <p>0 No effect.</p> <p>1 <i>For bulk or interrupt transactions:</i> Disables the sending of NYET handshakes. When this bit is set, all successfully received packets are acknowledged, including at the point at which the FIFO becomes full.</p> <p><i>For isochronous transactions:</i> Indicates a PID error in the received packet.</p>
3	DMAMOD	R/W	0	<p>DMA Request Mode</p> <p>Value Description</p> <p>0 An interrupt is generated after every <math>\mu</math>DMA packet transfer.</p> <p>1 An interrupt is generated only after the entire <math>\mu</math>DMA transfer is complete.</p> <p><b>Note:</b> This bit must not be cleared either before or in the same cycle as the above <code>DMAEN</code> bit is cleared.</p>

Bit/Field	Name	Type	Reset	Description
2:0	reserved	RO	0x0	Software should not rely on the value of a reserved bit. To provide compatibility with future products, the value of a reserved bit should be preserved across a read-modify-write operation.

**Register 225: USB Receive Byte Count Endpoint 1 (USBRXCOUNT1), offset 0x118**

**Register 226: USB Receive Byte Count Endpoint 2 (USBRXCOUNT2), offset 0x128**

**Register 227: USB Receive Byte Count Endpoint 3 (USBRXCOUNT3), offset 0x138**

**Register 228: USB Receive Byte Count Endpoint 4 (USBRXCOUNT4), offset 0x148**

**Register 229: USB Receive Byte Count Endpoint 5 (USBRXCOUNT5), offset 0x158**

**Register 230: USB Receive Byte Count Endpoint 6 (USBRXCOUNT6), offset 0x168**

**Register 231: USB Receive Byte Count Endpoint 7 (USBRXCOUNT7), offset 0x178**

**Register 232: USB Receive Byte Count Endpoint 8 (USBRXCOUNT8), offset 0x188**

**Register 233: USB Receive Byte Count Endpoint 9 (USBRXCOUNT9), offset 0x198**

**Register 234: USB Receive Byte Count Endpoint 10 (USBRXCOUNT10), offset 0x1A8**

**Register 235: USB Receive Byte Count Endpoint 11 (USBRXCOUNT11), offset 0x1B8**

**Register 236: USB Receive Byte Count Endpoint 12 (USBRXCOUNT12), offset 0x1C8**

**Register 237: USB Receive Byte Count Endpoint 13 (USBRXCOUNT13), offset 0x1D8**

**Register 238: USB Receive Byte Count Endpoint 14 (USBRXCOUNT14), offset 0x1E8**

**Register 239: USB Receive Byte Count Endpoint 15 (USBRXCOUNT15), offset 0x1F8**

OTG A /  
Host

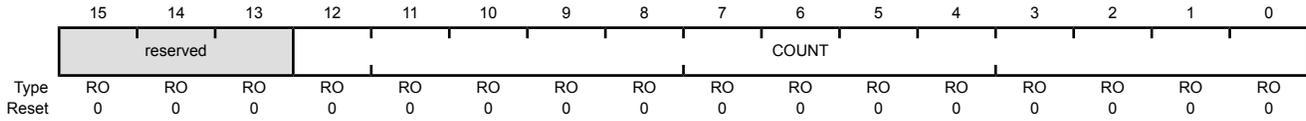
**Note:** The value returned changes as the FIFO is unloaded and is only valid while the `RXRDY` bit in the `USBXCSRLn` register is set.

OTG B /  
Device

**USBXCOUNTn** is a 16-bit read-only register that holds the number of data bytes in the packet currently in line to be read from the receive FIFO. If the packet is transmitted as multiple bulk packets, the number given is for the combined packet.

**USB Receive Byte Count Endpoint 1 (USBRXCOUNT1)**

Base 0x4005.0000  
 Offset 0x118  
 Type RO, reset 0x0000



Bit/Field	Name	Type	Reset	Description
15:13	reserved	RO	0x0	Software should not rely on the value of a reserved bit. To provide compatibility with future products, the value of a reserved bit should be preserved across a read-modify-write operation.
12:0	COUNT	RO	0x000	Receive Packet Count Indicates the number of bytes in the receive packet.

**Register 240: USB Host Transmit Configure Type Endpoint 1 (USBTXTYPE1), offset 0x11A**

**Register 241: USB Host Transmit Configure Type Endpoint 2 (USBTXTYPE2), offset 0x12A**

**Register 242: USB Host Transmit Configure Type Endpoint 3 (USBTXTYPE3), offset 0x13A**

**Register 243: USB Host Transmit Configure Type Endpoint 4 (USBTXTYPE4), offset 0x14A**

**Register 244: USB Host Transmit Configure Type Endpoint 5 (USBTXTYPE5), offset 0x15A**

**Register 245: USB Host Transmit Configure Type Endpoint 6 (USBTXTYPE6), offset 0x16A**

**Register 246: USB Host Transmit Configure Type Endpoint 7 (USBTXTYPE7), offset 0x17A**

**Register 247: USB Host Transmit Configure Type Endpoint 8 (USBTXTYPE8), offset 0x18A**

**Register 248: USB Host Transmit Configure Type Endpoint 9 (USBTXTYPE9), offset 0x19A**

**Register 249: USB Host Transmit Configure Type Endpoint 10 (USBTXTYPE10), offset 0x1AA**

**Register 250: USB Host Transmit Configure Type Endpoint 11 (USBTXTYPE11), offset 0x1BA**

**Register 251: USB Host Transmit Configure Type Endpoint 12 (USBTXTYPE12), offset 0x1CA**

**Register 252: USB Host Transmit Configure Type Endpoint 13 (USBTXTYPE13), offset 0x1DA**

**Register 253: USB Host Transmit Configure Type Endpoint 14 (USBTXTYPE14), offset 0x1EA**

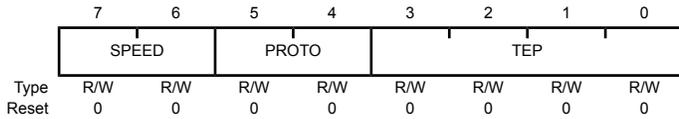
**Register 254: USB Host Transmit Configure Type Endpoint 15 (USBTXTYPE15), offset 0x1FA**

**OTG A /  
Host**

**USBTXTYPE<sub>n</sub>** is an 8-bit register that must be written with the endpoint number to be targeted by the endpoint, the transaction protocol to use for the currently selected transmit endpoint, and its operating speed.

USB Host Transmit Configure Type Endpoint 1 (USBTXTYPE1)

Base 0x4005.0000  
 Offset 0x11A  
 Type R/W, reset 0x00



Bit/Field	Name	Type	Reset	Description										
7:6	SPEED	R/W	0x0	<p>Operating Speed</p> <p>This bit field specifies the operating speed of the target Device:</p> <table border="1"> <thead> <tr> <th>Value</th> <th>Description</th> </tr> </thead> <tbody> <tr> <td>0x0</td> <td>Default</td> </tr> <tr> <td>0x1</td> <td>Reserved</td> </tr> <tr> <td>0x2</td> <td>Full</td> </tr> <tr> <td>0x3</td> <td>Low</td> </tr> </tbody> </table>	Value	Description	0x0	Default	0x1	Reserved	0x2	Full	0x3	Low
Value	Description													
0x0	Default													
0x1	Reserved													
0x2	Full													
0x3	Low													
5:4	PROTO	R/W	0x0	<p>Protocol</p> <p>Software must configure this bit field to select the required protocol for the transmit endpoint:</p> <table border="1"> <thead> <tr> <th>Value</th> <th>Description</th> </tr> </thead> <tbody> <tr> <td>0x0</td> <td>Control</td> </tr> <tr> <td>0x1</td> <td>Isochronous</td> </tr> <tr> <td>0x2</td> <td>Bulk</td> </tr> <tr> <td>0x3</td> <td>Interrupt</td> </tr> </tbody> </table>	Value	Description	0x0	Control	0x1	Isochronous	0x2	Bulk	0x3	Interrupt
Value	Description													
0x0	Control													
0x1	Isochronous													
0x2	Bulk													
0x3	Interrupt													
3:0	TEP	R/W	0x0	<p>Target Endpoint Number</p> <p>Software must configure this value to the endpoint number contained in the transmit endpoint descriptor returned to the USB controller during Device enumeration.</p>										

**Register 255: USB Host Transmit Interval Endpoint 1 (USBTXINTERVAL1), offset 0x11B**

**Register 256: USB Host Transmit Interval Endpoint 2 (USBTXINTERVAL2), offset 0x12B**

**Register 257: USB Host Transmit Interval Endpoint 3 (USBTXINTERVAL3), offset 0x13B**

**Register 258: USB Host Transmit Interval Endpoint 4 (USBTXINTERVAL4), offset 0x14B**

**Register 259: USB Host Transmit Interval Endpoint 5 (USBTXINTERVAL5), offset 0x15B**

**Register 260: USB Host Transmit Interval Endpoint 6 (USBTXINTERVAL6), offset 0x16B**

**Register 261: USB Host Transmit Interval Endpoint 7 (USBTXINTERVAL7), offset 0x17B**

**Register 262: USB Host Transmit Interval Endpoint 8 (USBTXINTERVAL8), offset 0x18B**

**Register 263: USB Host Transmit Interval Endpoint 9 (USBTXINTERVAL9), offset 0x19B**

**Register 264: USB Host Transmit Interval Endpoint 10 (USBTXINTERVAL10), offset 0x1AB**

**Register 265: USB Host Transmit Interval Endpoint 11 (USBTXINTERVAL11), offset 0x1BB**

**Register 266: USB Host Transmit Interval Endpoint 12 (USBTXINTERVAL12), offset 0x1CB**

**Register 267: USB Host Transmit Interval Endpoint 13 (USBTXINTERVAL13), offset 0x1DB**

**Register 268: USB Host Transmit Interval Endpoint 14 (USBTXINTERVAL14), offset 0x1EB**

**Register 269: USB Host Transmit Interval Endpoint 15 (USBTXINTERVAL15), offset 0x1FB**

**OTG A /  
Host**

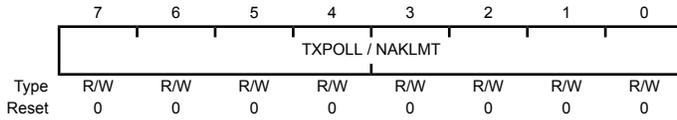
**USBTXINTERVAL<sub>n</sub>** is an 8-bit register that, for interrupt and isochronous transfers, defines the polling interval for the currently selected transmit endpoint. For bulk endpoints, this register defines the number of frames after which the endpoint should time out on receiving a stream of NAK responses.

The **USBTXINTERVAL<sub>n</sub>** register value defines a number of frames, as follows:

Transfer Type	Speed	Valid values (m)	Interpretation
Interrupt	Low-Speed or Full-Speed	0x01 – 0xFF	The polling interval is $m$ frames.
Isochronous	Full-Speed	0x01 – 0x10	The polling interval is $2^{(m-1)}$ frames.
Bulk	Full-Speed	0x02 – 0x10	The NAK Limit is $2^{(m-1)}$ frames. A value of 0 or 1 disables the NAK timeout function.

USB Host Transmit Interval Endpoint 1 (USBTXINTERVAL1)

Base 0x4005.0000  
 Offset 0x11B  
 Type R/W, reset 0x00



Bit/Field	Name	Type	Reset	Description
7:0	TXPOLL / NAKLMT	R/W	0x00	TX Polling / NAK Limit

The polling interval for interrupt/isochronous transfers; the NAK limit for bulk transfers. See table above for valid entries; other values are reserved.



**Register 270: USB Host Configure Receive Type Endpoint 1 (USBRXTYPE1), offset 0x11C**

**Register 271: USB Host Configure Receive Type Endpoint 2 (USBRXTYPE2), offset 0x12C**

**Register 272: USB Host Configure Receive Type Endpoint 3 (USBRXTYPE3), offset 0x13C**

**Register 273: USB Host Configure Receive Type Endpoint 4 (USBRXTYPE4), offset 0x14C**

**Register 274: USB Host Configure Receive Type Endpoint 5 (USBRXTYPE5), offset 0x15C**

**Register 275: USB Host Configure Receive Type Endpoint 6 (USBRXTYPE6), offset 0x16C**

**Register 276: USB Host Configure Receive Type Endpoint 7 (USBRXTYPE7), offset 0x17C**

**Register 277: USB Host Configure Receive Type Endpoint 8 (USBRXTYPE8), offset 0x18C**

**Register 278: USB Host Configure Receive Type Endpoint 9 (USBRXTYPE9), offset 0x19C**

**Register 279: USB Host Configure Receive Type Endpoint 10 (USBRXTYPE10), offset 0x1AC**

**Register 280: USB Host Configure Receive Type Endpoint 11 (USBRXTYPE11), offset 0x1BC**

**Register 281: USB Host Configure Receive Type Endpoint 12 (USBRXTYPE12), offset 0x1CC**

**Register 282: USB Host Configure Receive Type Endpoint 13 (USBRXTYPE13), offset 0x1DC**

**Register 283: USB Host Configure Receive Type Endpoint 14 (USBRXTYPE14), offset 0x1EC**

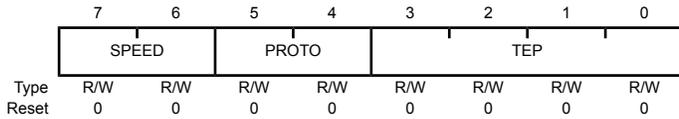
**Register 284: USB Host Configure Receive Type Endpoint 15 (USBRXTYPE15), offset 0x1FC**

**OTG A /  
Host**

**USBRXTYPE<sub>n</sub>** is an 8-bit register that must be written with the endpoint number to be targeted by the endpoint, the transaction protocol to use for the currently selected receive endpoint, and its operating speed.

USB Host Configure Receive Type Endpoint 1 (USBRXTYPE1)

Base 0x4005.0000  
 Offset 0x11C  
 Type R/W, reset 0x00



Bit/Field	Name	Type	Reset	Description										
7:6	SPEED	R/W	0x0	<p>Operating Speed</p> <p>This bit field specifies the operating speed of the target Device:</p> <table border="1"> <thead> <tr> <th>Value</th> <th>Description</th> </tr> </thead> <tbody> <tr> <td>0x0</td> <td>Default</td> </tr> <tr> <td>0x1</td> <td>Reserved</td> </tr> <tr> <td>0x2</td> <td>Full</td> </tr> <tr> <td>0x3</td> <td>Low</td> </tr> </tbody> </table>	Value	Description	0x0	Default	0x1	Reserved	0x2	Full	0x3	Low
Value	Description													
0x0	Default													
0x1	Reserved													
0x2	Full													
0x3	Low													
5:4	PROTO	R/W	0x0	<p>Protocol</p> <p>Software must configure this bit field to select the required protocol for the receive endpoint:</p> <table border="1"> <thead> <tr> <th>Value</th> <th>Description</th> </tr> </thead> <tbody> <tr> <td>0x0</td> <td>Control</td> </tr> <tr> <td>0x1</td> <td>Isochronous</td> </tr> <tr> <td>0x2</td> <td>Bulk</td> </tr> <tr> <td>0x3</td> <td>Interrupt</td> </tr> </tbody> </table>	Value	Description	0x0	Control	0x1	Isochronous	0x2	Bulk	0x3	Interrupt
Value	Description													
0x0	Control													
0x1	Isochronous													
0x2	Bulk													
0x3	Interrupt													
3:0	TEP	R/W	0x0	<p>Target Endpoint Number</p> <p>Software must set this value to the endpoint number contained in the receive endpoint descriptor returned to the USB controller during Device enumeration.</p>										

**Register 285: USB Host Receive Polling Interval Endpoint 1 (USBRXINTERVAL1), offset 0x11D**

**Register 286: USB Host Receive Polling Interval Endpoint 2 (USBRXINTERVAL2), offset 0x12D**

**Register 287: USB Host Receive Polling Interval Endpoint 3 (USBRXINTERVAL3), offset 0x13D**

**Register 288: USB Host Receive Polling Interval Endpoint 4 (USBRXINTERVAL4), offset 0x14D**

**Register 289: USB Host Receive Polling Interval Endpoint 5 (USBRXINTERVAL5), offset 0x15D**

**Register 290: USB Host Receive Polling Interval Endpoint 6 (USBRXINTERVAL6), offset 0x16D**

**Register 291: USB Host Receive Polling Interval Endpoint 7 (USBRXINTERVAL7), offset 0x17D**

**Register 292: USB Host Receive Polling Interval Endpoint 8 (USBRXINTERVAL8), offset 0x18D**

**Register 293: USB Host Receive Polling Interval Endpoint 9 (USBRXINTERVAL9), offset 0x19D**

**Register 294: USB Host Receive Polling Interval Endpoint 10 (USBRXINTERVAL10), offset 0x1AD**

**Register 295: USB Host Receive Polling Interval Endpoint 11 (USBRXINTERVAL11), offset 0x1BD**

**Register 296: USB Host Receive Polling Interval Endpoint 12 (USBRXINTERVAL12), offset 0x1CD**

**Register 297: USB Host Receive Polling Interval Endpoint 13 (USBRXINTERVAL13), offset 0x1DD**

**Register 298: USB Host Receive Polling Interval Endpoint 14 (USBRXINTERVAL14), offset 0x1ED**

**Register 299: USB Host Receive Polling Interval Endpoint 15 (USBRXINTERVAL15), offset 0x1FD**

**OTG A /  
Host**

**USBRXINTERVAL<sub>n</sub>** is an 8-bit register that, for interrupt and isochronous transfers, defines the polling interval for the currently selected receive endpoint. For bulk endpoints, this register defines the number of frames after which the endpoint should time out on receiving a stream of NAK responses.

The **USBTXINTERVAL<sub>n</sub>** register value defines a number of frames, as follows:

Transfer Type	Speed	Valid values (m)	Interpretation
Interrupt	Low-Speed or Full-Speed	0x01 – 0xFF	The polling interval is <i>m</i> frames.
Isochronous	Full-Speed	0x01 – 0x10	The polling interval is $2^{(m-1)}$ frames.

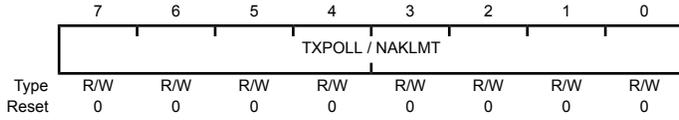
Transfer Type	Speed	Valid values (m)	Interpretation
Bulk	Full-Speed	0x02 – 0x10	The NAK Limit is $2^{(m-1)}$ frames. A value of 0 or 1 disables the NAK timeout function.

USB Host Receive Polling Interval Endpoint 1 (USBRXINTERVAL1)

Base 0x4005.0000

Offset 0x11D

Type R/W, reset 0x00



Bit/Field	Name	Type	Reset	Description
7:0	TXPOLL / NAKLMT	R/W	0x00	RX Polling / NAK Limit

The polling interval for interrupt/isochronous transfers; the NAK limit for bulk transfers. See table above for valid entries; other values are reserved.

**Register 300: USB Request Packet Count in Block Transfer Endpoint 1 (USBRQPKTCOUNT1), offset 0x304**

**Register 301: USB Request Packet Count in Block Transfer Endpoint 2 (USBRQPKTCOUNT2), offset 0x308**

**Register 302: USB Request Packet Count in Block Transfer Endpoint 3 (USBRQPKTCOUNT3), offset 0x30C**

**Register 303: USB Request Packet Count in Block Transfer Endpoint 4 (USBRQPKTCOUNT4), offset 0x310**

**Register 304: USB Request Packet Count in Block Transfer Endpoint 5 (USBRQPKTCOUNT5), offset 0x314**

**Register 305: USB Request Packet Count in Block Transfer Endpoint 6 (USBRQPKTCOUNT6), offset 0x318**

**Register 306: USB Request Packet Count in Block Transfer Endpoint 7 (USBRQPKTCOUNT7), offset 0x31C**

**Register 307: USB Request Packet Count in Block Transfer Endpoint 8 (USBRQPKTCOUNT8), offset 0x320**

**Register 308: USB Request Packet Count in Block Transfer Endpoint 9 (USBRQPKTCOUNT9), offset 0x324**

**Register 309: USB Request Packet Count in Block Transfer Endpoint 10 (USBRQPKTCOUNT10), offset 0x328**

**Register 310: USB Request Packet Count in Block Transfer Endpoint 11 (USBRQPKTCOUNT11), offset 0x32C**

**Register 311: USB Request Packet Count in Block Transfer Endpoint 12 (USBRQPKTCOUNT12), offset 0x330**

**Register 312: USB Request Packet Count in Block Transfer Endpoint 13 (USBRQPKTCOUNT13), offset 0x334**

**Register 313: USB Request Packet Count in Block Transfer Endpoint 14 (USBRQPKTCOUNT14), offset 0x338**

**Register 314: USB Request Packet Count in Block Transfer Endpoint 15 (USBRQPKTCOUNT15), offset 0x33C**

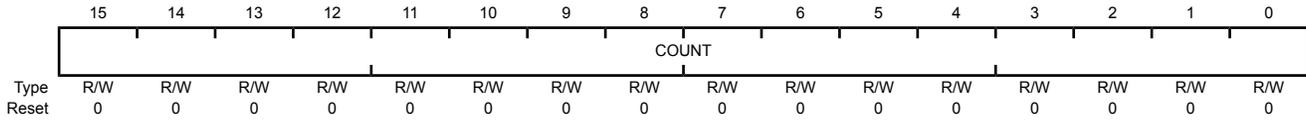
**OTG A /  
Host**

This 16-bit read/write register is used in Host mode to specify the number of packets that are to be transferred in a block transfer of one or more bulk packets to receive endpoint n. The USB controller uses the value recorded in this register to determine the number of requests to issue where the **AUTORQ** bit in the **USBRXCsrHn** register has been set. See “IN Transactions as a Host” on page 884.

**Note:** Multiple packets combined into a single bulk packet within the FIFO count as one packet.

USB Request Packet Count in Block Transfer Endpoint 1 (USBRQPKTCOUNT1)

Base 0x4005.0000  
 Offset 0x304  
 Type R/W, reset 0x0000



Bit/Field	Name	Type	Reset	Description
15:0	COUNT	R/W	0x0000	Block Transfer Packet Count  Sets the number of packets of the size defined by the MAXLOAD bit field that are to be transferred in a block transfer.  <b>Note:</b> This is only used in Host mode when AUTORQ is set. The bit has no effect in Device mode or when AUTORQ is not set.

## Register 315: USB Receive Double Packet Buffer Disable (USBXDPKTBUFDIS), offset 0x340

OTG A /  
Host

**USBXDPKTBUFDIS** is a 16-bit register that indicates which of the receive endpoints have disabled the double-packet buffer functionality (see the section called “Double-Packet Buffering” on page 880).

OTG B /  
Device

USB Receive Double Packet Buffer Disable (USBXDPKTBUFDIS)

Base 0x4005.0000  
Offset 0x340  
Type R/W, reset 0x0000

	15	14	13	12	11	10	9	8	7	6	5	4	3	2	1	0
	EP15	EP14	EP13	EP12	EP11	EP10	EP9	EP8	EP7	EP6	EP5	EP4	EP3	EP2	EP1	reserved
Type	R/W	R/W	R/W	R/W	R/W	R/W	R/W	R/W	R/W	R/W	R/W	R/W	R/W	R/W	R/W	RO
Reset	0	0	0	0	0	0	0	0	0	0	0	0	0	0	0	0

Bit/Field	Name	Type	Reset	Description
15	EP15	R/W	0	EP15 RX Double-Packet Buffer Disable  Value Description 0 Disables double-packet buffering. 1 Enables double-packet buffering.
14	EP14	R/W	0	EP14 RX Double-Packet Buffer Disable Same description as EP15.
13	EP13	R/W	0	EP13 RX Double-Packet Buffer Disable Same description as EP15.
12	EP12	R/W	0	EP12 RX Double-Packet Buffer Disable Same description as EP15.
11	EP11	R/W	0	EP11 RX Double-Packet Buffer Disable Same description as EP15.
10	EP10	R/W	0	EP10 RX Double-Packet Buffer Disable Same description as EP15.
9	EP9	R/W	0	EP9 RX Double-Packet Buffer Disable Same description as EP15.
8	EP8	R/W	0	EP8 RX Double-Packet Buffer Disable Same description as EP15.
7	EP7	R/W	0	EP7 RX Double-Packet Buffer Disable Same description as EP15.
6	EP6	R/W	0	EP6 RX Double-Packet Buffer Disable Same description as EP15.
5	EP5	R/W	0	EP5 RX Double-Packet Buffer Disable Same description as EP15.

Bit/Field	Name	Type	Reset	Description
4	EP4	R/W	0	EP4 RX Double-Packet Buffer Disable Same description as EP15.
3	EP3	R/W	0	EP3 RX Double-Packet Buffer Disable Same description as EP15.
2	EP2	R/W	0	EP2 RX Double-Packet Buffer Disable Same description as EP15.
1	EP1	R/W	0	EP1 RX Double-Packet Buffer Disable Same description as EP15.
0	reserved	RO	0	Software should not rely on the value of a reserved bit. To provide compatibility with future products, the value of a reserved bit should be preserved across a read-modify-write operation.



## Register 316: USB Transmit Double Packet Buffer Disable (USBTXDPKTBUFDIS), offset 0x342

OTG A /  
Host

**USBTXDPKTBUFDIS** is a 16-bit register that indicates which of the transmit endpoints have disabled the double-packet buffer functionality (see the section called “Double-Packet Buffering” on page 880).

USB Transmit Double Packet Buffer Disable (USBTXDPKTBUFDIS)

Base 0x4005.0000  
Offset 0x342  
Type R/W, reset 0x0000

OTG B /  
Device

	15	14	13	12	11	10	9	8	7	6	5	4	3	2	1	0
	EP15	EP14	EP13	EP12	EP11	EP10	EP9	EP8	EP7	EP6	EP5	EP4	EP3	EP2	EP1	reserved
Type	R/W	R/W	R/W	R/W	R/W	R/W	R/W	R/W	R/W	R/W	R/W	R/W	R/W	R/W	R/W	RO
Reset	0	0	0	0	0	0	0	0	0	0	0	0	0	0	0	0

Bit/Field	Name	Type	Reset	Description
15	EP15	R/W	0	EP15 TX Double-Packet Buffer Disable  Value Description 0 Disables double-packet buffering. 1 Enables double-packet buffering.
14	EP14	R/W	0	EP14 TX Double-Packet Buffer Disable Same description as EP15.
13	EP13	R/W	0	EP13 TX Double-Packet Buffer Disable Same description as EP15.
12	EP12	R/W	0	EP12 TX Double-Packet Buffer Disable Same description as EP15.
11	EP11	R/W	0	EP11 TX Double-Packet Buffer Disable Same description as EP15.
10	EP10	R/W	0	EP10 TX Double-Packet Buffer Disable Same description as EP15.
9	EP9	R/W	0	EP9 TX Double-Packet Buffer Disable Same description as EP15.
8	EP8	R/W	0	EP8 TX Double-Packet Buffer Disable Same description as EP15.
7	EP7	R/W	0	EP7 TX Double-Packet Buffer Disable Same description as EP15.
6	EP6	R/W	0	EP6 TX Double-Packet Buffer Disable Same description as EP15.
5	EP5	R/W	0	EP5 TX Double-Packet Buffer Disable Same description as EP15.

Bit/Field	Name	Type	Reset	Description
4	EP4	R/W	0	EP4 TX Double-Packet Buffer Disable Same description as EP15.
3	EP3	R/W	0	EP3 TX Double-Packet Buffer Disable Same description as EP15.
2	EP2	R/W	0	EP2 TX Double-Packet Buffer Disable Same description as EP15.
1	EP1	R/W	0	EP1 TX Double-Packet Buffer Disable Same description as EP15.
0	reserved	RO	0	Software should not rely on the value of a reserved bit. To provide compatibility with future products, the value of a reserved bit should be preserved across a read-modify-write operation.

**Register 317: USB External Power Control (USBEPEN), offset 0x400****OTG A /  
Host**

This 32-bit register specifies the function of the two-pin external power interface (USB0EPEN and USB0PFLT). The assertion of the power fault input may generate an automatic action, as controlled by the hardware configuration registers. The automatic action is necessary because the fault condition may require a response faster than one provided by firmware.

**OTG B /  
Device**

USB External Power Control (USBEPEN)

Base 0x4005.0000

Offset 0x400

Type R/W, reset 0x0000.0000

	31	30	29	28	27	26	25	24	23	22	21	20	19	18	17	16
	reserved															
Type	RO	RO	RO	RO	RO	RO	RO	RO	RO	RO	RO	RO	RO	RO	RO	RO
Reset	0	0	0	0	0	0	0	0	0	0	0	0	0	0	0	0
	15	14	13	12	11	10	9	8	7	6	5	4	3	2	1	0
	reserved						PFLTACT	reserved	PFLTAEN	PFLTSEN	PFLTEN	reserved	EPENDE	EPEN		
Type	RO	RO	RO	RO	RO	RO	R/W	R/W	RO	R/W	R/W	R/W	RO	R/W	R/W	R/W
Reset	0	0	0	0	0	0	0	0	0	0	0	0	0	0	0	0

Bit/Field	Name	Type	Reset	Description										
31:10	reserved	RO	0x0000.0	Software should not rely on the value of a reserved bit. To provide compatibility with future products, the value of a reserved bit should be preserved across a read-modify-write operation.										
9:8	PFLTACT	R/W	0x0	<p>Power Fault Action</p> <p>This bit field specifies how the USB0EPEN signal is changed when detecting a USB power fault.</p> <table border="0"> <tr> <td>Value</td> <td>Description</td> </tr> <tr> <td>0x0</td> <td> <p>Unchanged</p> <p>USB0EPEN is controlled by the combination of the EPEN and EPENDE bits.</p> </td> </tr> <tr> <td>0x1</td> <td> <p>Tristate</p> <p>USB0EPEN is undriven (tristate).</p> </td> </tr> <tr> <td>0x2</td> <td> <p>Low</p> <p>USB0EPEN is driven Low.</p> </td> </tr> <tr> <td>0x3</td> <td> <p>High</p> <p>USB0EPEN is driven High.</p> </td> </tr> </table>	Value	Description	0x0	<p>Unchanged</p> <p>USB0EPEN is controlled by the combination of the EPEN and EPENDE bits.</p>	0x1	<p>Tristate</p> <p>USB0EPEN is undriven (tristate).</p>	0x2	<p>Low</p> <p>USB0EPEN is driven Low.</p>	0x3	<p>High</p> <p>USB0EPEN is driven High.</p>
Value	Description													
0x0	<p>Unchanged</p> <p>USB0EPEN is controlled by the combination of the EPEN and EPENDE bits.</p>													
0x1	<p>Tristate</p> <p>USB0EPEN is undriven (tristate).</p>													
0x2	<p>Low</p> <p>USB0EPEN is driven Low.</p>													
0x3	<p>High</p> <p>USB0EPEN is driven High.</p>													
7	reserved	RO	0	Software should not rely on the value of a reserved bit. To provide compatibility with future products, the value of a reserved bit should be preserved across a read-modify-write operation.										

Bit/Field	Name	Type	Reset	Description
6	PFLTAEN	R/W	0	<p>Power Fault Action Enable</p> <p>This bit specifies whether a USB power fault triggers any automatic corrective action regarding the driven state of the <code>USB0EPEN</code> signal.</p> <p>Value Description</p> <p>0 Disabled</p> <p><code>USB0EPEN</code> is controlled by the combination of the <code>EPEN</code> and <code>EPENDE</code> bits.</p> <p>1 Enabled</p> <p>The <code>USB0EPEN</code> output is automatically changed to the state specified by the <code>PFLTACT</code> field.</p>
5	PFLTSEN	R/W	0	<p>Power Fault Sense</p> <p>This bit specifies the logical sense of the <code>USB0PFLT</code> input signal that indicates an error condition.</p> <p>The complementary state is the inactive state.</p> <p>Value Description</p> <p>0 Low Fault</p> <p>If <code>USB0PFLT</code> is driven Low, the power fault is signaled internally (if enabled by the <code>PFLTEN</code> bit).</p> <p>1 High Fault</p> <p>If <code>USB0PFLT</code> is driven High, the power fault is signaled internally (if enabled by the <code>PFLTEN</code> bit).</p>
4	PFLTEN	R/W	0	<p>Power Fault Input Enable</p> <p>This bit specifies whether the <code>USB0PFLT</code> input signal is used in internal logic.</p> <p>Value Description</p> <p>0 Not Used</p> <p>The <code>USB0PFLT</code> signal is ignored.</p> <p>1 Used</p> <p>The <code>USB0PFLT</code> signal is used internally.</p>
3	reserved	RO	0	<p>Software should not rely on the value of a reserved bit. To provide compatibility with future products, the value of a reserved bit should be preserved across a read-modify-write operation.</p>

Bit/Field	Name	Type	Reset	Description
2	EPENDE	R/W	0	<p>EPEN Drive Enable</p> <p>This bit specifies whether the <code>USB0EPEN</code> signal is driven or undriven (tristate). When driven, the signal value is specified by the <code>EPEN</code> field. When not driven, the <code>EPEN</code> field is ignored and the <code>USB0EPEN</code> signal is placed in a high-impedance state.</p> <p>Value Description</p> <p>0 Not Driven</p> <p>The <code>USB0EPEN</code> signal is high impedance.</p> <p>1 Driven</p> <p>The <code>USB0EPEN</code> signal is driven to the logical value specified by the value of the <code>EPEN</code> field.</p> <p>The <code>USB0EPEN</code> signal is undriven at reset because the sense of the external power supply enable is unknown. By adding the high-impedance state, system designers may bias the power supply enable to the disabled state using a large resistor (100 kΩ) and later configure and drive the output signal to enable the power supply.</p>
1:0	EPEN	R/W	0x0	<p>External Power Supply Enable Configuration</p> <p>This bit field specifies and controls the logical value driven on the <code>USB0EPEN</code> signal.</p> <p>Value Description</p> <p>0x0 Power Enable Active Low</p> <p>The <code>USB0EPEN</code> signal is driven Low if the <code>EPENDE</code> bit is set.</p> <p>0x1 Power Enable Active High</p> <p>The <code>USB0EPEN</code> signal is driven High if the <code>EPENDE</code> bit is set.</p> <p>0x2 Power Enable High if <code>VBUS</code> Low</p> <p>The <code>USB0EPEN</code> signal is driven High when the A device is not recognized.</p> <p>0x3 Power Enable High if <code>VBUS</code> High</p> <p>The <code>USB0EPEN</code> signal is driven High when the A device is recognized.</p>

### Register 318: USB External Power Control Raw Interrupt Status (USBEPCRIS), offset 0x404

OTG A /  
Host

This 32-bit register specifies the unmasked interrupt status of the two-pin external power interface.

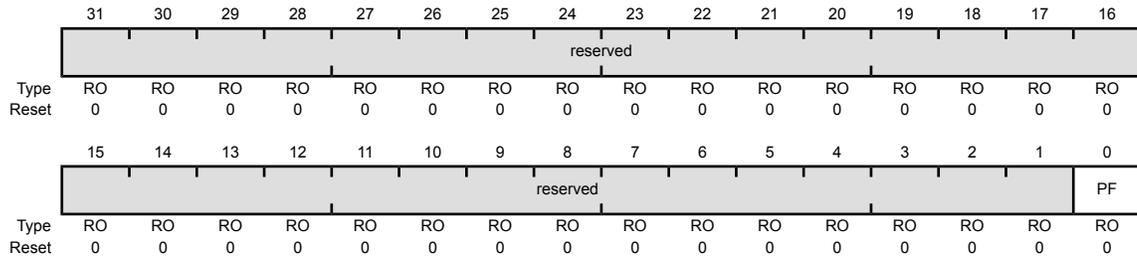
#### USB External Power Control Raw Interrupt Status (USBEPCRIS)

Base 0x4005.0000

Offset 0x404

Type RO, reset 0x0000.0000

OTG B /  
Device



Bit/Field	Name	Type	Reset	Description
31:1	reserved	RO	0x0000.000	Software should not rely on the value of a reserved bit. To provide compatibility with future products, the value of a reserved bit should be preserved across a read-modify-write operation.
0	PF	RO	0	<p>USB Power Fault Interrupt Status</p> <p>Value Description</p> <p>1 A Power Fault status has been detected.</p> <p>0 An interrupt has not occurred.</p> <p>This bit is cleared by writing a 1 to the PF bit in the <b>USBEPICISC</b> register.</p>

## Register 319: USB External Power Control Interrupt Mask (USBEPICM), offset 0x408

OTG A /  
Host

This 32-bit register specifies the interrupt mask of the two-pin external power interface.

USB External Power Control Interrupt Mask (USBEPICM)

Base 0x4005.0000

Offset 0x408

Type R/W, reset 0x0000.0000

OTG B /  
Device

	31	30	29	28	27	26	25	24	23	22	21	20	19	18	17	16
	reserved															
Type	RO	RO	RO	RO	RO	RO	RO	RO	RO	RO	RO	RO	RO	RO	RO	RO
Reset	0	0	0	0	0	0	0	0	0	0	0	0	0	0	0	0
	15	14	13	12	11	10	9	8	7	6	5	4	3	2	1	0
	reserved															PF
Type	RO	RO	RO	RO	RO	RO	RO	RO	RO	RO	RO	RO	RO	RO	RO	R/W
Reset	0	0	0	0	0	0	0	0	0	0	0	0	0	0	0	0

Bit/Field	Name	Type	Reset	Description
31:1	reserved	RO	0x0000.000	Software should not rely on the value of a reserved bit. To provide compatibility with future products, the value of a reserved bit should be preserved across a read-modify-write operation.
0	PF	R/W	0	USB Power Fault Interrupt Mask
				Value Description
				1 The raw interrupt signal from a detected power fault is sent to the interrupt controller.
				0 A detected power fault does not affect the interrupt status.

### Register 320: USB External Power Control Interrupt Status and Clear (USBEPICISC), offset 0x40C

OTG A /  
Host

This 32-bit register specifies the masked interrupt status of the two-pin external power interface. It also provides a method to clear the interrupt state.

OTG B /  
Device

USB External Power Control Interrupt Status and Clear (USBEPICISC)

Base 0x4005.0000  
Offset 0x40C  
Type R/W, reset 0x0000.0000

	31	30	29	28	27	26	25	24	23	22	21	20	19	18	17	16
	reserved															
Type	RO	RO	RO	RO	RO	RO	RO	RO	RO	RO	RO	RO	RO	RO	RO	RO
Reset	0	0	0	0	0	0	0	0	0	0	0	0	0	0	0	0
	15	14	13	12	11	10	9	8	7	6	5	4	3	2	1	0
	reserved															PF
Type	RO	RO	RO	RO	RO	RO	RO	RO	RO	RO	RO	RO	RO	RO	RO	R/W1C
Reset	0	0	0	0	0	0	0	0	0	0	0	0	0	0	0	0

Bit/Field	Name	Type	Reset	Description
31:1	reserved	RO	0x0000.000	Software should not rely on the value of a reserved bit. To provide compatibility with future products, the value of a reserved bit should be preserved across a read-modify-write operation.
0	PF	R/W1C	0	USB Power Fault Interrupt Status and Clear

Value	Description
1	The <b>PF</b> bits in the <b>USBEPCRIS</b> and <b>USBEPCIM</b> registers are set, providing an interrupt to the interrupt controller.
0	No interrupt has occurred or the interrupt is masked.

This bit is cleared by writing a 1. Clearing this bit also clears the **PF** bit in the **USBEPCRIS** register.



## Register 321: USB Device RESUME Raw Interrupt Status (USBDRRIS), offset 0x410

OTG A /  
Host

The **USBDRRIS** 32-bit register is the raw interrupt status register. On a read, this register gives the current raw status value of the corresponding interrupt prior to masking. A write has no effect.

OTG B /  
Device

USB Device RESUME Raw Interrupt Status (USBDRRIS)

Base 0x4005.0000  
Offset 0x410  
Type RO, reset 0x0000.0000

	31	30	29	28	27	26	25	24	23	22	21	20	19	18	17	16
	reserved															
Type	RO	RO	RO	RO	RO	RO	RO	RO	RO	RO	RO	RO	RO	RO	RO	RO
Reset	0	0	0	0	0	0	0	0	0	0	0	0	0	0	0	0
	15	14	13	12	11	10	9	8	7	6	5	4	3	2	1	0
	reserved															RESUME
Type	RO	RO	RO	RO	RO	RO	RO	RO	RO	RO	RO	RO	RO	RO	RO	RO
Reset	0	0	0	0	0	0	0	0	0	0	0	0	0	0	0	0

Bit/Field	Name	Type	Reset	Description
31:1	reserved	RO	0x0000.000	Software should not rely on the value of a reserved bit. To provide compatibility with future products, the value of a reserved bit should be preserved across a read-modify-write operation.
0	RESUME	RO	0	RESUME Interrupt Status
				Value Description
				1 A RESUME status has been detected.
				0 An interrupt has not occurred.
				This bit is cleared by writing a 1 to the RESUME bit in the <b>USBDRISC</b> register.

**Register 322: USB Device RESUME Interrupt Mask (USBDRIM), offset 0x414**

OTG A /  
Host

The **USBDRIM** 32-bit register is the masked interrupt status register. On a read, this register gives the current masked status value of the corresponding interrupt. A write has no effect.

OTG B /  
Device

USB Device RESUME Interrupt Mask (USBDRIM)

Base 0x4005.0000  
Offset 0x414  
Type R/W, reset 0x0000.0000

	31	30	29	28	27	26	25	24	23	22	21	20	19	18	17	16
	reserved															
Type	RO	RO	RO	RO	RO	RO	RO	RO	RO	RO	RO	RO	RO	RO	RO	RO
Reset	0	0	0	0	0	0	0	0	0	0	0	0	0	0	0	0
	15	14	13	12	11	10	9	8	7	6	5	4	3	2	1	0
	reserved															RESUME
Type	RO	RO	RO	RO	RO	RO	RO	RO	RO	RO	RO	RO	RO	RO	RO	R/W
Reset	0	0	0	0	0	0	0	0	0	0	0	0	0	0	0	0

Bit/Field	Name	Type	Reset	Description
31:1	reserved	RO	0x00	Software should not rely on the value of a reserved bit. To provide compatibility with future products, the value of a reserved bit should be preserved across a read-modify-write operation.
0	RESUME	R/W	0	RESUME Interrupt Mask

Value Description

- 1 The raw interrupt signal from a detected RESUME is sent to the interrupt controller. This bit should only be set when a SUSPEND has been detected (the SUSPEND bit in the USBIS register is set).
- 0 A detected RESUME does not affect the interrupt status.

## Register 323: USB Device RESUME Interrupt Status and Clear (USBDRISC), offset 0x418

OTG A /  
Host

The **USBDRISC** 32-bit register is the interrupt clear register. On a write of 1, the corresponding interrupt is cleared. A write of 0 has no effect.

OTG B /  
Device

USB Device RESUME Interrupt Status and Clear (USBDRISC)

Base 0x4005.0000  
Offset 0x418  
Type W1C, reset 0x0000.0000

	31	30	29	28	27	26	25	24	23	22	21	20	19	18	17	16
	reserved															
Type	RO	RO	RO	RO	RO	RO	RO	RO	RO	RO	RO	RO	RO	RO	RO	RO
Reset	0	0	0	0	0	0	0	0	0	0	0	0	0	0	0	0
	15	14	13	12	11	10	9	8	7	6	5	4	3	2	1	0
	reserved															RESUME
Type	RO	RO	RO	RO	RO	RO	RO	RO	RO	RO	RO	RO	RO	RO	RO	R/W1C
Reset	0	0	0	0	0	0	0	0	0	0	0	0	0	0	0	0

Bit/Field	Name	Type	Reset	Description
31:1	reserved	RO	0x0000.000	Software should not rely on the value of a reserved bit. To provide compatibility with future products, the value of a reserved bit should be preserved across a read-modify-write operation.
0	RESUME	R/W1C	0	RESUME Interrupt Status and Clear

#### Value Description

- 1 The **RESUME** bits in the **USBDRRIS** and **USBDRCIM** registers are set, providing an interrupt to the interrupt controller.
- 0 No interrupt has occurred or the interrupt is masked.

This bit is cleared by writing a 1. Clearing this bit also clears the **RESUME** bit in the **USBDRCRIS** register.

### Register 324: USB General-Purpose Control and Status (USBGPCS), offset 0x41C

OTG A /  
Host

USBGPCS provides the state of the internal ID signal.

OTG B /  
Device

**Note:** When used in OTG mode, `USB0VBUS` and `USB0ID` do not require any configuration as they are dedicated pins for the USB controller and directly connect to the USB connector's VBUS and ID signals. If the USB controller is used as either a dedicated Host or Device, the `DEVMODOTG` and `DEVMOD` bits in the **USB General-Purpose Control and Status (USBGPCS)** register can be used to connect the `USB0VBUS` and `USB0ID` inputs to fixed levels internally, freeing the `PB0` and `PB1` pins for GPIO use. For proper self-powered Device operation, the VBUS value must still be monitored to assure that if the Host removes VBUS, the self-powered Device disables the D+/D- pull-up resistors. This function can be accomplished by connecting a standard GPIO to VBUS.

#### USB General-Purpose Control and Status (USBGPCS)

Base 0x4005.0000  
Offset 0x41C  
Type R/W, reset 0x0000.0000

	31	30	29	28	27	26	25	24	23	22	21	20	19	18	17	16	
	reserved																
Type	RO	RO	RO	RO	RO	RO	RO	RO	RO	RO	RO	RO	RO	RO	RO	RO	
Reset	0	0	0	0	0	0	0	0	0	0	0	0	0	0	0	0	
	15	14	13	12	11	10	9	8	7	6	5	4	3	2	1	0	
	reserved															DEVMODOTG	DEVMOD
Type	RO	RO	RO	RO	RO	RO	RO	RO	RO	RO	RO	RO	RO	RO	RO	R/W	R/W
Reset	0	0	0	0	0	0	0	0	0	0	0	0	0	0	0	0	0

Bit/Field	Name	Type	Reset	Description						
31:2	reserved	RO	0x0000.000	Software should not rely on the value of a reserved bit. To provide compatibility with future products, the value of a reserved bit should be preserved across a read-modify-write operation.						
1	DEVMODOTG	R/W	0	<p>Enable Device Mode</p> <p>This bit enables the <code>DEVMOD</code> bit to control the state of the internal ID signal in OTG mode.</p> <table border="0"> <tr> <td>Value</td> <td>Description</td> </tr> <tr> <td>0</td> <td>The mode is specified by the state of the internal ID signal.</td> </tr> <tr> <td>1</td> <td>This bit enables the <code>DEVMOD</code> bit to control the internal ID signal.</td> </tr> </table>	Value	Description	0	The mode is specified by the state of the internal ID signal.	1	This bit enables the <code>DEVMOD</code> bit to control the internal ID signal.
Value	Description									
0	The mode is specified by the state of the internal ID signal.									
1	This bit enables the <code>DEVMOD</code> bit to control the internal ID signal.									
0	DEVMOD	R/W	0	<p>Device Mode</p> <p>This bit specifies the state of the internal ID signal in Host mode and in OTG mode when the <code>DEVMODOTG</code> bit is set.</p> <p>In Device mode this bit is ignored (assumed set).</p> <table border="0"> <tr> <td>Value</td> <td>Description</td> </tr> <tr> <td>0</td> <td>Host mode</td> </tr> <tr> <td>1</td> <td>Device mode</td> </tr> </table>	Value	Description	0	Host mode	1	Device mode
Value	Description									
0	Host mode									
1	Device mode									

### Register 325: USB VBUS Droop Control (USBVDC), offset 0x430

OTG A /  
Host

This 32-bit register enables a controlled masking of VBUS to compensate for any in-rush current by a Device that is connected to the Host controller. The in-rush current can cause VBUS to droop, causing the USB controller's behavior to be unexpected. The USB Host controller allows VBUS to fall lower than the VBUS Valid level (4.5 V) but not below AValid (2.0 V) for 65 microseconds without signaling a `VBUSERR` interrupt in the controller. Without this, any glitch on VBUS would force the USB Host controller to remove power from VBUS and then re-enumerate the Device.

#### USB VBUS Droop Control (USBVDC)

Base 0x4005.0000  
Offset 0x430  
Type R/W, reset 0x0000.0000

	31	30	29	28	27	26	25	24	23	22	21	20	19	18	17	16
	reserved															
Type	RO	RO	RO	RO	RO	RO	RO	RO	RO	RO	RO	RO	RO	RO	RO	RO
Reset	0	0	0	0	0	0	0	0	0	0	0	0	0	0	0	0
	15	14	13	12	11	10	9	8	7	6	5	4	3	2	1	0
	reserved															VBDEN
Type	RO	RO	RO	RO	RO	RO	RO	RO	RO	RO	RO	RO	RO	RO	RO	R/W
Reset	0	0	0	0	0	0	0	0	0	0	0	0	0	0	0	0

Bit/Field	Name	Type	Reset	Description
31:1	reserved	RO	0x0000.000	Software should not rely on the value of a reserved bit. To provide compatibility with future products, the value of a reserved bit should be preserved across a read-modify-write operation.
0	VBDEN	R/W	0	VBUS Droop Enable
				Value Description
			0	No effect.
			1	Any changes from <code>VBUSVALID</code> are masked when VBUS goes below 4.5 V but not lower than 2.0 V for 65 microseconds. During this time, the VBUS state indicates <code>VBUSVALID</code> .

### Register 326: USB VBUS Droop Control Raw Interrupt Status (USBVDCRIS), offset 0x434

OTG A / Host

This 32-bit register specifies the unmasked interrupt status of the VBUS droop limit of 65 microseconds.

USB VBUS Droop Control Raw Interrupt Status (USBVDCRIS)

Base 0x4005.0000

Offset 0x434

Type RO, reset 0x0000.0000

	31	30	29	28	27	26	25	24	23	22	21	20	19	18	17	16
	reserved															
Type	RO	RO	RO	RO	RO	RO	RO	RO	RO	RO	RO	RO	RO	RO	RO	RO
Reset	0	0	0	0	0	0	0	0	0	0	0	0	0	0	0	0
	15	14	13	12	11	10	9	8	7	6	5	4	3	2	1	0
	reserved															VD
Type	RO	RO	RO	RO	RO	RO	RO	RO	RO	RO	RO	RO	RO	RO	RO	RO
Reset	0	0	0	0	0	0	0	0	0	0	0	0	0	0	0	0

Bit/Field	Name	Type	Reset	Description
31:1	reserved	RO	0x0000.000	Software should not rely on the value of a reserved bit. To provide compatibility with future products, the value of a reserved bit should be preserved across a read-modify-write operation.
0	VD	RO	0	VBUS Droop Raw Interrupt Status

Value	Description
1	A VBUS droop lasting for 65 microseconds has been detected.
0	An interrupt has not occurred.

This bit is cleared by writing a 1 to the VD bit in the USBVDCISC register.

## Register 327: USB VBUS Droop Control Interrupt Mask (USBVDCIM), offset 0x438

OTG A /  
Host

This 32-bit register specifies the interrupt mask of the VBUS droop.

USB VBUS Droop Control Interrupt Mask (USBVDCIM)

Base 0x4005.0000

Offset 0x438

Type R/W, reset 0x0000.0000

	31	30	29	28	27	26	25	24	23	22	21	20	19	18	17	16
	reserved															
Type	RO	RO	RO	RO	RO	RO	RO	RO	RO	RO	RO	RO	RO	RO	RO	RO
Reset	0	0	0	0	0	0	0	0	0	0	0	0	0	0	0	0
	15	14	13	12	11	10	9	8	7	6	5	4	3	2	1	0
	reserved															VD
Type	RO	RO	RO	RO	RO	RO	RO	RO	RO	RO	RO	RO	RO	RO	RO	R/W
Reset	0	0	0	0	0	0	0	0	0	0	0	0	0	0	0	0

Bit/Field	Name	Type	Reset	Description
31:1	reserved	RO	0x0000.000	Software should not rely on the value of a reserved bit. To provide compatibility with future products, the value of a reserved bit should be preserved across a read-modify-write operation.
0	VD	R/W	0	VBUS Droop Interrupt Mask
				Value Description
			1	The raw interrupt signal from a detected VBUS droop is sent to the interrupt controller.
			0	A detected VBUS droop does not affect the interrupt status.

### Register 328: USB VBUS Droop Control Interrupt Status and Clear (USBVDCISC), offset 0x43C

OTG A /  
Host

This 32-bit register specifies the masked interrupt status of the VBUS droop and provides a method to clear the interrupt state.

USB VBUS Droop Control Interrupt Status and Clear (USBVDCISC)

Base 0x4005.0000

Offset 0x43C

Type R/W, reset 0x0000.0000

	31	30	29	28	27	26	25	24	23	22	21	20	19	18	17	16
	reserved															
Type	RO	RO	RO	RO	RO	RO	RO	RO	RO	RO	RO	RO	RO	RO	RO	RO
Reset	0	0	0	0	0	0	0	0	0	0	0	0	0	0	0	0
	15	14	13	12	11	10	9	8	7	6	5	4	3	2	1	0
	reserved															VD
Type	RO	RO	RO	RO	RO	RO	RO	RO	RO	RO	RO	RO	RO	RO	RO	R/W1C
Reset	0	0	0	0	0	0	0	0	0	0	0	0	0	0	0	0

Bit/Field	Name	Type	Reset	Description
31:1	reserved	RO	0x0000.000	Software should not rely on the value of a reserved bit. To provide compatibility with future products, the value of a reserved bit should be preserved across a read-modify-write operation.
0	VD	R/W1C	0	VBUS Droop Interrupt Status and Clear

Value	Description
1	The VD bits in the <b>USBVDCRIS</b> and <b>USBVDCIM</b> registers are set, providing an interrupt to the interrupt controller.
0	No interrupt has occurred or the interrupt is masked.

This bit is cleared by writing a 1. Clearing this bit also clears the VD bit in the **USBVDCRIS** register.



## Register 329: USB ID Valid Detect Raw Interrupt Status (USBIDVRIS), offset 0x444

**OTG**

This 32-bit register specifies whether the unmasked interrupt status of the ID value is valid.

### USB ID Valid Detect Raw Interrupt Status (USBIDVRIS)

Base 0x4005.0000  
 Offset 0x444  
 Type RO, reset 0x0000.0000

	31	30	29	28	27	26	25	24	23	22	21	20	19	18	17	16
	reserved															
Type	RO	RO	RO	RO	RO	RO	RO	RO	RO	RO	RO	RO	RO	RO	RO	RO
Reset	0	0	0	0	0	0	0	0	0	0	0	0	0	0	0	0
	15	14	13	12	11	10	9	8	7	6	5	4	3	2	1	0
	reserved															ID
Type	RO	RO	RO	RO	RO	RO	RO	RO	RO	RO	RO	RO	RO	RO	RO	RO
Reset	0	0	0	0	0	0	0	0	0	0	0	0	0	0	0	0

Bit/Field	Name	Type	Reset	Description
31:1	reserved	RO	0x0000.000	Software should not rely on the value of a reserved bit. To provide compatibility with future products, the value of a reserved bit should be preserved across a read-modify-write operation.
0	ID	RO	0	ID Valid Detect Raw Interrupt Status

Value	Description
1	A valid ID has been detected.
0	An interrupt has not occurred.

This bit is cleared by writing a 1 to the ID bit in the **USBIDVISC** register.

### Register 330: USB ID Valid Detect Interrupt Mask (USBIDVIM), offset 0x448

OTG

This 32-bit register specifies the interrupt mask of the ID valid detection.

USB ID Valid Detect Interrupt Mask (USBIDVIM)

Base 0x4005.0000  
 Offset 0x448  
 Type R/W, reset 0x0000.0000

	31	30	29	28	27	26	25	24	23	22	21	20	19	18	17	16
	reserved															
Type	RO	RO	RO	RO	RO	RO	RO	RO	RO	RO	RO	RO	RO	RO	RO	RO
Reset	0	0	0	0	0	0	0	0	0	0	0	0	0	0	0	0
	15	14	13	12	11	10	9	8	7	6	5	4	3	2	1	0
	reserved															ID
Type	RO	RO	RO	RO	RO	RO	RO	RO	RO	RO	RO	RO	RO	RO	RO	R/W
Reset	0	0	0	0	0	0	0	0	0	0	0	0	0	0	0	0

Bit/Field	Name	Type	Reset	Description
31:1	reserved	RO	0x0000.000	Software should not rely on the value of a reserved bit. To provide compatibility with future products, the value of a reserved bit should be preserved across a read-modify-write operation.
0	ID	R/W	0	ID Valid Detect Interrupt Mask
				Value Description
				1 The raw interrupt signal from a detected ID valid is sent to the interrupt controller.
				0 A detected ID valid does not affect the interrupt status.

## Register 331: USB ID Valid Detect Interrupt Status and Clear (USBIDVISC), offset 0x44C

**OTG**

This 32-bit register specifies the masked interrupt status of the ID valid detect. It also provides a method to clear the interrupt state.

### USB ID Valid Detect Interrupt Status and Clear (USBIDVISC)

Base 0x4005.0000

Offset 0x44C

Type R/W1C, reset 0x0000.0000

	31	30	29	28	27	26	25	24	23	22	21	20	19	18	17	16
	reserved															
Type	RO	RO	RO	RO	RO	RO	RO	RO	RO	RO	RO	RO	RO	RO	RO	RO
Reset	0	0	0	0	0	0	0	0	0	0	0	0	0	0	0	0
	15	14	13	12	11	10	9	8	7	6	5	4	3	2	1	0
	reserved															ID
Type	RO	RO	RO	RO	RO	RO	RO	RO	RO	RO	RO	RO	RO	RO	RO	R/W1C
Reset	0	0	0	0	0	0	0	0	0	0	0	0	0	0	0	0

Bit/Field	Name	Type	Reset	Description
31:1	reserved	RO	0x0000.000	Software should not rely on the value of a reserved bit. To provide compatibility with future products, the value of a reserved bit should be preserved across a read-modify-write operation.
0	ID	R/W1C	0	ID Valid Detect Interrupt Status and Clear

#### Value Description

- |   |   |
|---|---|
| 1 | The <b>ID</b> bits in the <b>USBIDVRIS</b> and <b>USBIDVIM</b> registers are set, providing an interrupt to the interrupt controller. |
| 0 | No interrupt has occurred or the interrupt is masked.   |

This bit is cleared by writing a 1. Clearing this bit also clears the **ID** bit in the **USBIDVRIS** register.

**Register 332: USB DMA Select (USBDMASEL), offset 0x450**

OTG A /  
Host

This 32-bit register specifies which endpoints are mapped to the 6 allocated  $\mu$ DMA channels, see Table 8-1 on page 248 for more information on channel assignments.

OTG B /  
Device

USB DMA Select (USBDMASEL)

Base 0x4005.0000  
Offset 0x450  
Type R/W, reset 0x0033.2211

	31	30	29	28	27	26	25	24	23	22	21	20	19	18	17	16
	reserved								DMACTX				DMACRX			
Type	RO	RO	RO	RO	RO	RO	RO	RO	R/W	R/W	R/W	R/W	R/W	R/W	R/W	R/W
Reset	0	0	0	0	0	0	0	0	0	0	1	1	0	0	1	1
	15	14	13	12	11	10	9	8	7	6	5	4	3	2	1	0
	DMABTX				DMABRX				DMAATX				DMAARX			
Type	R/W	R/W	R/W	R/W	R/W	R/W	R/W	R/W	R/W	R/W	R/W	R/W	R/W	R/W	R/W	R/W
Reset	0	0	1	0	0	0	1	0	0	0	0	1	0	0	0	1

Bit/Field	Name	Type	Reset	Description																																		
31:24	reserved	RO	0x00	Software should not rely on the value of a reserved bit. To provide compatibility with future products, the value of a reserved bit should be preserved across a read-modify-write operation.																																		
23:20	DMACTX	R/W	0x3	DMA C TX Select  Specifies the TX mapping of the third USB endpoint on $\mu$ DMA channel 5 (primary assignment).  <table border="0"> <tr> <td>Value</td> <td>Description</td> </tr> <tr> <td>0x0</td> <td>reserved</td> </tr> <tr> <td>0x1</td> <td>Endpoint 1 TX</td> </tr> <tr> <td>0x2</td> <td>Endpoint 2 TX</td> </tr> <tr> <td>0x3</td> <td>Endpoint 3 TX</td> </tr> <tr> <td>0x4</td> <td>Endpoint 4 TX</td> </tr> <tr> <td>0x5</td> <td>Endpoint 5 TX</td> </tr> <tr> <td>0x6</td> <td>Endpoint 6 TX</td> </tr> <tr> <td>0x7</td> <td>Endpoint 7 TX</td> </tr> <tr> <td>0x8</td> <td>Endpoint 8 TX</td> </tr> <tr> <td>0x9</td> <td>Endpoint 9 TX</td> </tr> <tr> <td>0xA</td> <td>Endpoint 10 TX</td> </tr> <tr> <td>0xB</td> <td>Endpoint 11 TX</td> </tr> <tr> <td>0xC</td> <td>Endpoint 12 TX</td> </tr> <tr> <td>0xD</td> <td>Endpoint 13 TX</td> </tr> <tr> <td>0xE</td> <td>Endpoint 14 TX</td> </tr> <tr> <td>0xF</td> <td>Endpoint 15 TX</td> </tr> </table>	Value	Description	0x0	reserved	0x1	Endpoint 1 TX	0x2	Endpoint 2 TX	0x3	Endpoint 3 TX	0x4	Endpoint 4 TX	0x5	Endpoint 5 TX	0x6	Endpoint 6 TX	0x7	Endpoint 7 TX	0x8	Endpoint 8 TX	0x9	Endpoint 9 TX	0xA	Endpoint 10 TX	0xB	Endpoint 11 TX	0xC	Endpoint 12 TX	0xD	Endpoint 13 TX	0xE	Endpoint 14 TX	0xF	Endpoint 15 TX
Value	Description																																					
0x0	reserved																																					
0x1	Endpoint 1 TX																																					
0x2	Endpoint 2 TX																																					
0x3	Endpoint 3 TX																																					
0x4	Endpoint 4 TX																																					
0x5	Endpoint 5 TX																																					
0x6	Endpoint 6 TX																																					
0x7	Endpoint 7 TX																																					
0x8	Endpoint 8 TX																																					
0x9	Endpoint 9 TX																																					
0xA	Endpoint 10 TX																																					
0xB	Endpoint 11 TX																																					
0xC	Endpoint 12 TX																																					
0xD	Endpoint 13 TX																																					
0xE	Endpoint 14 TX																																					
0xF	Endpoint 15 TX																																					

Bit/Field	Name	Type	Reset	Description																																		
19:16	DMACRX	R/W	0x3	<p>DMA C RX Select</p> <p>Specifies the RX and TX mapping of the third USB endpoint on <math>\mu</math>DMA channel 4 (primary assignment).</p> <table border="1"> <thead> <tr> <th>Value</th> <th>Description</th> </tr> </thead> <tbody> <tr><td>0x0</td><td>reserved</td></tr> <tr><td>0x1</td><td>Endpoint 1 RX</td></tr> <tr><td>0x2</td><td>Endpoint 2 RX</td></tr> <tr><td>0x3</td><td>Endpoint 3 RX</td></tr> <tr><td>0x4</td><td>Endpoint 4 RX</td></tr> <tr><td>0x5</td><td>Endpoint 5 RX</td></tr> <tr><td>0x6</td><td>Endpoint 6 RX</td></tr> <tr><td>0x7</td><td>Endpoint 7 RX</td></tr> <tr><td>0x8</td><td>Endpoint 8 RX</td></tr> <tr><td>0x9</td><td>Endpoint 9 RX</td></tr> <tr><td>0xA</td><td>Endpoint 10 RX</td></tr> <tr><td>0xB</td><td>Endpoint 11 RX</td></tr> <tr><td>0xC</td><td>Endpoint 12 RX</td></tr> <tr><td>0xD</td><td>Endpoint 13 RX</td></tr> <tr><td>0xE</td><td>Endpoint 14 RX</td></tr> <tr><td>0xF</td><td>Endpoint 15 RX</td></tr> </tbody> </table>	Value	Description	0x0	reserved	0x1	Endpoint 1 RX	0x2	Endpoint 2 RX	0x3	Endpoint 3 RX	0x4	Endpoint 4 RX	0x5	Endpoint 5 RX	0x6	Endpoint 6 RX	0x7	Endpoint 7 RX	0x8	Endpoint 8 RX	0x9	Endpoint 9 RX	0xA	Endpoint 10 RX	0xB	Endpoint 11 RX	0xC	Endpoint 12 RX	0xD	Endpoint 13 RX	0xE	Endpoint 14 RX	0xF	Endpoint 15 RX
Value	Description																																					
0x0	reserved																																					
0x1	Endpoint 1 RX																																					
0x2	Endpoint 2 RX																																					
0x3	Endpoint 3 RX																																					
0x4	Endpoint 4 RX																																					
0x5	Endpoint 5 RX																																					
0x6	Endpoint 6 RX																																					
0x7	Endpoint 7 RX																																					
0x8	Endpoint 8 RX																																					
0x9	Endpoint 9 RX																																					
0xA	Endpoint 10 RX																																					
0xB	Endpoint 11 RX																																					
0xC	Endpoint 12 RX																																					
0xD	Endpoint 13 RX																																					
0xE	Endpoint 14 RX																																					
0xF	Endpoint 15 RX																																					
15:12	DMABTX	R/W	0x2	<p>DMA B TX Select</p> <p>Specifies the TX mapping of the second USB endpoint on <math>\mu</math>DMA channel 3 (primary assignment).</p> <p>Same bit definitions as the <code>DMACTX</code> field.</p>																																		
11:8	DMABRX	R/W	0x2	<p>DMA B RX Select</p> <p>Specifies the RX mapping of the second USB endpoint on <math>\mu</math>DMA channel 2 (primary assignment).</p> <p>Same bit definitions as the <code>DMACRX</code> field.</p>																																		
7:4	DMAATX	R/W	0x1	<p>DMA A TX Select</p> <p>Specifies the TX mapping of the first USB endpoint on <math>\mu</math>DMA channel 1 (primary assignment).</p> <p>Same bit definitions as the <code>DMACTX</code> field.</p>																																		
3:0	DMAARX	R/W	0x1	<p>DMA A RX Select</p> <p>Specifies the RX mapping of the first USB endpoint on <math>\mu</math>DMA channel 0 (primary assignment).</p> <p>Same bit definitions as the <code>DMACRX</code> field.</p>																																		

## 21 Analog Comparators

An analog comparator is a peripheral that compares two analog voltages and provides a logical output that signals the comparison result.

**Note:** Not all comparators have the option to drive an output pin.

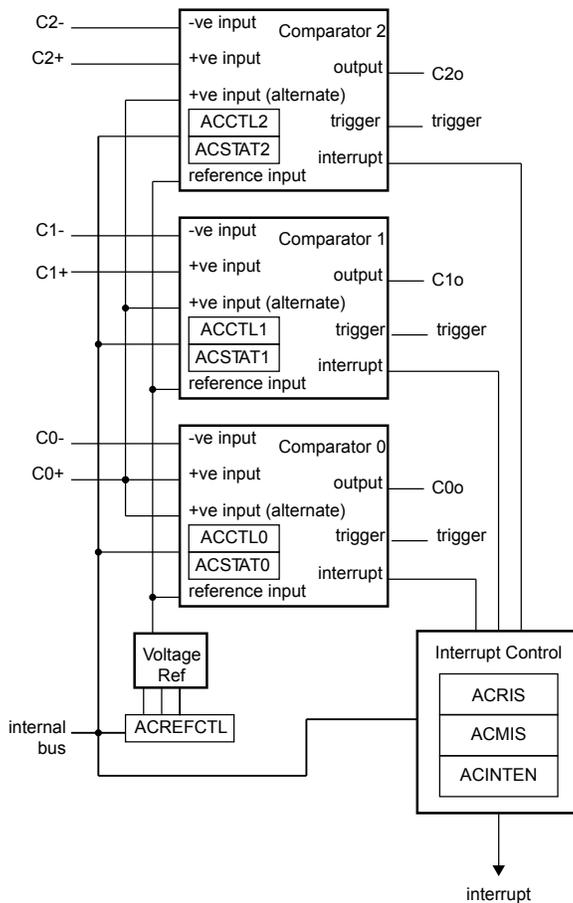
The comparator can provide its output to a device pin, acting as a replacement for an analog comparator on the board. In addition, the comparator can signal the application via interrupts or trigger the start of a sample sequence in the ADC. The interrupt generation and ADC triggering logic is separate and independent. This flexibility means, for example, that an interrupt can be generated on a rising edge and the ADC triggered on a falling edge.

The Stellaris<sup>®</sup> LM3S9B96 microcontroller provides three independent integrated analog comparators with the following functions:

- Compare external pin input to external pin input or to internal programmable voltage reference
- Compare a test voltage against any one of the following voltages:
  - An individual external reference voltage
  - A shared single external reference voltage
  - A shared internal reference voltage

## 21.1 Block Diagram

Figure 21-1. Analog Comparator Module Block Diagram



## 21.2 Signal Description

Table 21-1 on page 1015 and Table 21-2 on page 1016 list the external signals of the Analog Comparators and describe the function of each. The Analog Comparator output signals are alternate functions for some GPIO signals and default to be GPIO signals at reset. The column in the table below titled "Pin Mux/Pin Assignment" lists the possible GPIO pin placements for the Analog Comparator signals. The `AFSEL` bit in the **GPIO Alternate Function Select (GPIOAFSEL)** register (page 328) should be set to choose the Analog Comparator function. The number in parentheses is the encoding that must be programmed into the `PMCn` field in the **GPIO Port Control (GPIOPCTL)** register (page 346) to assign the Analog Comparator signal to the specified GPIO port pin. The positive and negative input signals are configured by clearing the `DEN` bit in the **GPIO Digital Enable (GPIODEN)** register. For more information on configuring GPIOs, see "General-Purpose Input/Outputs (GPIOs)" on page 304.

Table 21-1. Signals for Analog Comparators (100LQFP)

Pin Name	Pin Number	Pin Mux / Pin Assignment	Pin Type	Buffer Type <sup>a</sup>	Description
C0+	90	PB6	I	Analog	Analog comparator 0 positive input.

Table 21-1. Signals for Analog Comparators (100LQFP) (continued)

Pin Name	Pin Number	Pin Mux / Pin Assignment	Pin Type	Buffer Type <sup>a</sup>	Description
C0-	92	PB4	I	Analog	Analog comparator 0 negative input.
C0o	24 42 90 91 100	PC5 (3) PF4 (2) PB6 (3) PB5 (1) PD7 (2)	O	TTL	Analog comparator 0 output.
C1+	24	PC5	I	Analog	Analog comparator 1 positive input.
C1-	91	PB5	I	Analog	Analog comparator 1 negative input.
C1o	2 22 24 41 84	PE6 (2) PC7 (7) PC5 (2) PF5 (2) PH2 (2)	O	TTL	Analog comparator 1 output.
C2+	23	PC6	I	Analog	Analog comparator 2 positive input.
C2-	22	PC7	I	Analog	Analog comparator 2 negative input.
C2o	1 23	PE7 (2) PC6 (3)	O	TTL	Analog comparator 2 output.

a. The TTL designation indicates the pin has TTL-compatible voltage levels.

Table 21-2. Signals for Analog Comparators (108BGA)

Pin Name	Pin Number	Pin Mux / Pin Assignment	Pin Type	Buffer Type <sup>a</sup>	Description
C0+	A7	PB6	I	Analog	Analog comparator 0 positive input.
C0-	A6	PB4	I	Analog	Analog comparator 0 negative input.
C0o	M1 K4 A7 B7 A2	PC5 (3) PF4 (2) PB6 (3) PB5 (1) PD7 (2)	O	TTL	Analog comparator 0 output.
C1+	M1	PC5	I	Analog	Analog comparator 1 positive input.
C1-	B7	PB5	I	Analog	Analog comparator 1 negative input.
C1o	A1 L2 M1 K3 D11	PE6 (2) PC7 (7) PC5 (2) PF5 (2) PH2 (2)	O	TTL	Analog comparator 1 output.
C2+	M2	PC6	I	Analog	Analog comparator 2 positive input.
C2-	L2	PC7	I	Analog	Analog comparator 2 negative input.
C2o	B1 M2	PE7 (2) PC6 (3)	O	TTL	Analog comparator 2 output.

a. The TTL designation indicates the pin has TTL-compatible voltage levels.

## 21.3 Functional Description

The comparator compares the VIN- and VIN+ inputs to produce an output, VOUT.

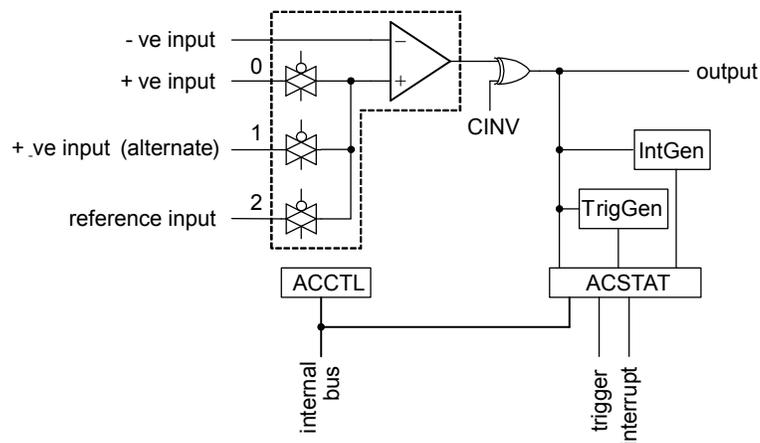
$$VIN- < VIN+, VOUT = 1$$

$$VIN- > VIN+, VOUT = 0$$



As shown in Figure 21-2 on page 1017, the input source for VIN- is an external input,  $C_{n-}$ . In addition to an external input,  $C_{n+}$ , input sources for VIN+ can be the  $C_{0+}$  or an internal reference,  $V_{IREF}$ .

**Figure 21-2. Structure of Comparator Unit**



A comparator is configured through two status/control registers, **Analog Comparator Control (ACCTL)** and **Analog Comparator Status (ACSTAT)**. The internal reference is configured through one control register, **Analog Comparator Reference Voltage Control (ACREFCTL)**. Interrupt status and control are configured through three registers, **Analog Comparator Masked Interrupt Status (ACMIS)**, **Analog Comparator Raw Interrupt Status (ACRIS)**, and **Analog Comparator Interrupt Enable (ACINTEN)**.

Typically, the comparator output is used internally to generate an interrupt as controlled by the  $I_{SEN}$  bit in the **ACCTL** register. The output may also be used to drive an external pin,  $C_o$  or generate an analog-to-digital converter (ADC) trigger.

**Important:** The  $ASRCP$  bits in the **ACCTL** register must be set before using the analog comparators.

### 21.3.1 Internal Reference Programming

The structure of the internal reference is shown in Figure 21-3 on page 1017. The internal reference is controlled by a single configuration register (**ACREFCTL**). Table 21-3 on page 1018 shows the programming options to develop specific internal reference values, to compare an external voltage against a particular voltage generated internally ( $V_{IREF}$ ).

**Figure 21-3. Comparator Internal Reference Structure**

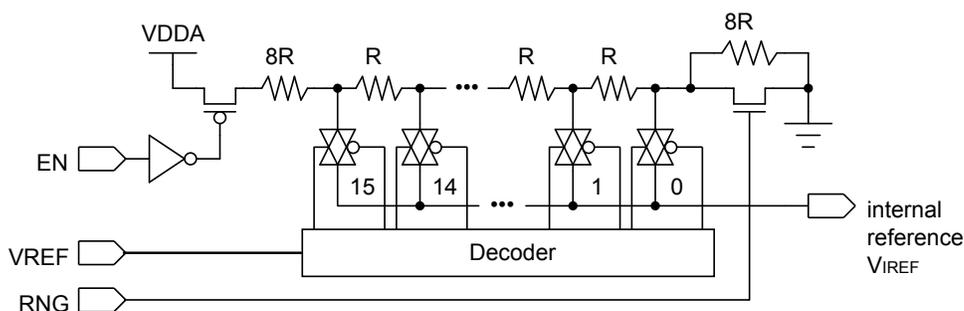


Table 21-3. Internal Reference Voltage and ACREFACTL Field Values

ACREFACTL Register		Output Reference Voltage Based on VREF Field Value
EN Bit Value	RNG Bit Value	
EN=0	RNG=X	0 V (GND) for any value of VREF; however, it is recommended that RNG=1 and VREF=0 for the least noisy ground reference.
EN=1	RNG=0	<p>Total resistance in ladder is 31 R.</p> $V_{IREF} = V_{DDA} \times \frac{RV_{REF}}{R_T}$ $V_{IREF} = V_{DDA} \times \frac{(V_{REF} + 8)}{31}$ $V_{IREF} = 0.85 + 0.106 \times V_{REF}$ <p>The range of internal reference in this mode is 0.85-2.448 V.</p>
	RNG=1	<p>Total resistance in ladder is 23 R.</p> $V_{IREF} = V_{DDA} \times \frac{RV_{REF}}{R_T}$ $V_{IREF} = V_{DDA} \times \frac{V_{REF}}{23}$ $V_{IREF} = 0.143 \times V_{REF}$ <p>The range of internal reference for this mode is 0-2.152 V.</p>

## 21.4 Initialization and Configuration

The following example shows how to configure an analog comparator to read back its output value from an internal register.

1. Enable the analog comparator 0 clock by writing a value of 0x0010.0000 to the **RCGC1** register in the System Control module (see page 181).
2. In the GPIO module, enable the GPIO port/pin associated with the input signals as GPIO inputs. To determine which GPIO to configure, see Table 25-4 on page 1151.
3. Configure the **PMCn** fields in the **GPIOCTL** register to assign the analog comparator output signals to the appropriate pins (see page 346 and Table 25-5 on page 1160).

4. Configure the internal voltage reference to 1.65 V by writing the **ACREFCTL** register with the value 0x0000.030C.
5. Configure the comparator to use the internal voltage reference and to *not* invert the output by writing the **ACCTLn** register with the value of 0x0000.040C.
6. Delay for 10  $\mu$ s.
7. Read the comparator output value by reading the **ACSTATn** register's **OVAL** value.

Change the level of the comparator negative input signal C<sup>-</sup> to see the **OVAL** value change.

## 21.5 Register Map

Table 21-4 on page 1019 lists the comparator registers. The offset listed is a hexadecimal increment to the register's address, relative to the Analog Comparator base address of 0x4003.C000. Note that the analog comparator clock must be enabled before the registers can be programmed (see page 181).

**Table 21-4. Analog Comparators Register Map**

Offset	Name	Type	Reset	Description	See page
0x000	ACMIS	R/W1C	0x0000.0000	Analog Comparator Masked Interrupt Status	1020
0x004	ACRIS	RO	0x0000.0000	Analog Comparator Raw Interrupt Status	1021
0x008	ACINTEN	R/W	0x0000.0000	Analog Comparator Interrupt Enable	1022
0x010	ACREFCTL	R/W	0x0000.0000	Analog Comparator Reference Voltage Control	1023
0x020	ACSTAT0	RO	0x0000.0000	Analog Comparator Status 0	1024
0x024	ACCTL0	R/W	0x0000.0000	Analog Comparator Control 0	1025
0x040	ACSTAT1	RO	0x0000.0000	Analog Comparator Status 1	1024
0x044	ACCTL1	R/W	0x0000.0000	Analog Comparator Control 1	1025
0x060	ACSTAT2	RO	0x0000.0000	Analog Comparator Status 2	1024
0x064	ACCTL2	R/W	0x0000.0000	Analog Comparator Control 2	1025

## 21.6 Register Descriptions

The remainder of this section lists and describes the Analog Comparator registers, in numerical order by address offset.

## Register 1: Analog Comparator Masked Interrupt Status (ACMIS), offset 0x000

This register provides a summary of the interrupt status (masked) of the comparators.

### Analog Comparator Masked Interrupt Status (ACMIS)

Base 0x4003.C000

Offset 0x000

Type R/W1C, reset 0x0000.0000

	31	30	29	28	27	26	25	24	23	22	21	20	19	18	17	16	
	reserved																
Type	RO	RO	RO	RO	RO	RO	RO	RO	RO	RO	RO	RO	RO	RO	RO	RO	
Reset	0	0	0	0	0	0	0	0	0	0	0	0	0	0	0	0	
	15	14	13	12	11	10	9	8	7	6	5	4	3	2	1	0	
	reserved													IN2	IN1	IN0	
Type	RO	RO	RO	RO	RO	RO	RO	RO	RO	RO	RO	RO	RO	RO	R/W1C	R/W1C	R/W1C
Reset	0	0	0	0	0	0	0	0	0	0	0	0	0	0	0	0	0

Bit/Field	Name	Type	Reset	Description
31:3	reserved	RO	0x0000.000	Software should not rely on the value of a reserved bit. To provide compatibility with future products, the value of a reserved bit should be preserved across a read-modify-write operation.
2	IN2	R/W1C	0	<p>Comparator 2 Masked Interrupt Status</p> <p>Value Description</p> <p>1 The <b>IN2</b> bits in the <b>ACRIS</b> register and the <b>ACINTEN</b> registers are set, providing an interrupt to the interrupt controller.</p> <p>0 No interrupt has occurred or the interrupt is masked.</p> <p>This bit is cleared by writing a 1. Clearing this bit also clears the <b>IN2</b> bit in the <b>ACRIS</b> register.</p>
1	IN1	R/W1C	0	<p>Comparator 1 Masked Interrupt Status</p> <p>Value Description</p> <p>1 The <b>IN1</b> bits in the <b>ACRIS</b> register and the <b>ACINTEN</b> registers are set, providing an interrupt to the interrupt controller.</p> <p>0 No interrupt has occurred or the interrupt is masked.</p> <p>This bit is cleared by writing a 1. Clearing this bit also clears the <b>IN1</b> bit in the <b>ACRIS</b> register.</p>
0	IN0	R/W1C	0	<p>Comparator 0 Masked Interrupt Status</p> <p>Value Description</p> <p>1 The <b>IN0</b> bits in the <b>ACRIS</b> register and the <b>ACINTEN</b> registers are set, providing an interrupt to the interrupt controller.</p> <p>0 No interrupt has occurred or the interrupt is masked.</p> <p>This bit is cleared by writing a 1. Clearing this bit also clears the <b>IN0</b> bit in the <b>ACRIS</b> register.</p>

**Register 2: Analog Comparator Raw Interrupt Status (ACRIS), offset 0x004**

This register provides a summary of the interrupt status (raw) of the comparators. The bits in this register must be enabled to generate interrupts using the **ACINTEN** register.

**Analog Comparator Raw Interrupt Status (ACRIS)**

Base 0x4003.C000

Offset 0x004

Type RO, reset 0x0000.0000

	31	30	29	28	27	26	25	24	23	22	21	20	19	18	17	16
	reserved															
Type	RO	RO	RO	RO	RO	RO	RO	RO	RO	RO	RO	RO	RO	RO	RO	RO
Reset	0	0	0	0	0	0	0	0	0	0	0	0	0	0	0	0
	15	14	13	12	11	10	9	8	7	6	5	4	3	2	1	0
	reserved													IN2	IN1	IN0
Type	RO	RO	RO	RO	RO	RO	RO	RO	RO	RO	RO	RO	RO	RO	RO	RO
Reset	0	0	0	0	0	0	0	0	0	0	0	0	0	0	0	0

Bit/Field	Name	Type	Reset	Description
31:3	reserved	RO	0x0000.000	Software should not rely on the value of a reserved bit. To provide compatibility with future products, the value of a reserved bit should be preserved across a read-modify-write operation.
2	IN2	RO	0	<p>Comparator 2 Interrupt Status</p> <p>Value Description</p> <p>1 Comparator 2 has generated an interrupt for an event as configured by the <b>ISEN</b> bit in the <b>ACCTL2</b> register.</p> <p>0 An interrupt has not occurred.</p> <p>This bit is cleared by writing a 1 to the <b>IN2</b> bit in the <b>ACMIS</b> register.</p>
1	IN1	RO	0	<p>Comparator 1 Interrupt Status</p> <p>Value Description</p> <p>1 Comparator 1 has generated an interrupt for an event as configured by the <b>ISEN</b> bit in the <b>ACCTL1</b> register.</p> <p>0 An interrupt has not occurred.</p> <p>This bit is cleared by writing a 1 to the <b>IN1</b> bit in the <b>ACMIS</b> register.</p>
0	IN0	RO	0	<p>Comparator 0 Interrupt Status</p> <p>Value Description</p> <p>1 Comparator 0 has generated an interrupt for an event as configured by the <b>ISEN</b> bit in the <b>ACCTL0</b> register.</p> <p>0 An interrupt has not occurred.</p> <p>This bit is cleared by writing a 1 to the <b>IN0</b> bit in the <b>ACMIS</b> register.</p>

### Register 3: Analog Comparator Interrupt Enable (ACINTEN), offset 0x008

This register provides the interrupt enable for the comparators.

#### Analog Comparator Interrupt Enable (ACINTEN)

Base 0x4003.C000  
 Offset 0x008  
 Type R/W, reset 0x0000.0000

	31	30	29	28	27	26	25	24	23	22	21	20	19	18	17	16	
	reserved																
Type	RO	RO	RO	RO	RO	RO	RO	RO	RO	RO	RO	RO	RO	RO	RO	RO	
Reset	0	0	0	0	0	0	0	0	0	0	0	0	0	0	0	0	
	15	14	13	12	11	10	9	8	7	6	5	4	3	2	1	0	
	reserved													IN2	IN1	IN0	
Type	RO	RO	RO	RO	RO	RO	RO	RO	RO	RO	RO	RO	RO	RO	R/W	R/W	R/W
Reset	0	0	0	0	0	0	0	0	0	0	0	0	0	0	0	0	0

Bit/Field	Name	Type	Reset	Description
31:3	reserved	RO	0x00	Software should not rely on the value of a reserved bit. To provide compatibility with future products, the value of a reserved bit should be preserved across a read-modify-write operation.
2	IN2	R/W	0	Comparator 2 Interrupt Enable  Value Description 1 The raw interrupt signal comparator 2 is sent to the interrupt controller. 0 A comparator 2 interrupt does not affect the interrupt status.
1	IN1	R/W	0	Comparator 1 Interrupt Enable  Value Description 1 The raw interrupt signal comparator 1 is sent to the interrupt controller. 0 A comparator 1 interrupt does not affect the interrupt status.
0	IN0	R/W	0	Comparator 0 Interrupt Enable  Value Description 1 The raw interrupt signal comparator 0 is sent to the interrupt controller. 0 A comparator 0 interrupt does not affect the interrupt status.

## Register 4: Analog Comparator Reference Voltage Control (ACREFCTL), offset 0x010

This register specifies whether the resistor ladder is powered on as well as the range and tap.

### Analog Comparator Reference Voltage Control (ACREFCTL)

Base 0x4003.C000

Offset 0x010

Type R/W, reset 0x0000.0000

	31	30	29	28	27	26	25	24	23	22	21	20	19	18	17	16
	reserved															
Type	RO	RO	RO	RO	RO	RO	RO	RO	RO	RO	RO	RO	RO	RO	RO	RO
Reset	0	0	0	0	0	0	0	0	0	0	0	0	0	0	0	0
	15	14	13	12	11	10	9	8	7	6	5	4	3	2	1	0
	reserved						EN	RNG	reserved				VREF			
Type	RO	RO	RO	RO	RO	RO	R/W	R/W	RO	RO	RO	RO	R/W	R/W	R/W	R/W
Reset	0	0	0	0	0	0	0	0	0	0	0	0	0	0	0	0

Bit/Field	Name	Type	Reset	Description
31:10	reserved	RO	0x0000.0	Software should not rely on the value of a reserved bit. To provide compatibility with future products, the value of a reserved bit should be preserved across a read-modify-write operation.
9	EN	R/W	0	Resistor Ladder Enable  Value Description 0 The resistor ladder is unpowered. 1 Powers on the resistor ladder. The resistor ladder is connected to $V_{DDA}$ .  This bit is cleared at reset so that the internal reference consumes the least amount of power if it is not used.
8	RNG	R/W	0	Resistor Ladder Range  Value Description 0 The resistor ladder has a total resistance of 31 R. 1 The resistor ladder has a total resistance of 23 R.
7:4	reserved	RO	0x0	Software should not rely on the value of a reserved bit. To provide compatibility with future products, the value of a reserved bit should be preserved across a read-modify-write operation.
3:0	VREF	R/W	0x0	Resistor Ladder Voltage Ref  The $V_{REF}$ bit field specifies the resistor ladder tap that is passed through an analog multiplexer. The voltage corresponding to the tap position is the internal reference voltage available for comparison. See Table 21-3 on page 1018 for some output reference voltage examples.

**Register 5: Analog Comparator Status 0 (ACSTAT0), offset 0x020**

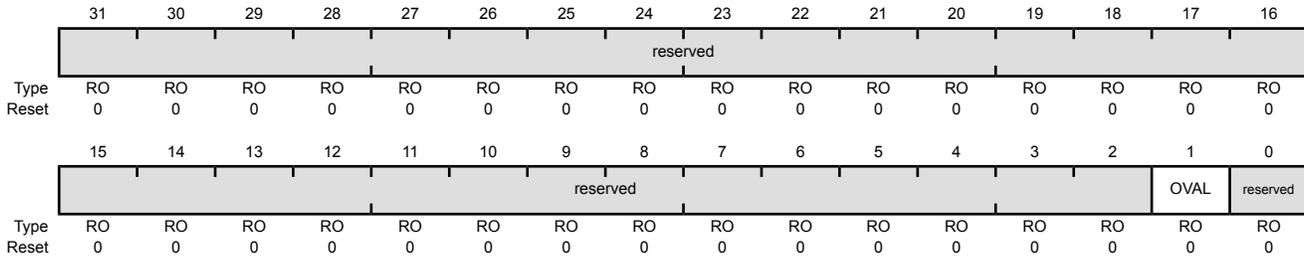
**Register 6: Analog Comparator Status 1 (ACSTAT1), offset 0x040**

**Register 7: Analog Comparator Status 2 (ACSTAT2), offset 0x060**

These registers specify the current output value of the comparator.

Analog Comparator Status 0 (ACSTAT0)

Base 0x4003.C000  
 Offset 0x020  
 Type RO, reset 0x0000.0000



Bit/Field	Name	Type	Reset	Description
31:2	reserved	RO	0x0000.000	Software should not rely on the value of a reserved bit. To provide compatibility with future products, the value of a reserved bit should be preserved across a read-modify-write operation.
1	OVAL	RO	0	Comparator Output Value  Value Description 0 VIN- > VIN+ 1 VIN- < VIN+  VIN- is the voltage on the C <sub>n-</sub> pin. VIN+ is the voltage on the C <sub>n+</sub> pin, the C0+ pin, or the internal voltage reference (V <sub>REF</sub> ) as defined by the ASRCP bit in the ACCTL register.
0	reserved	RO	0	Software should not rely on the value of a reserved bit. To provide compatibility with future products, the value of a reserved bit should be preserved across a read-modify-write operation.



**Register 8: Analog Comparator Control 0 (ACCTL0), offset 0x024****Register 9: Analog Comparator Control 1 (ACCTL1), offset 0x044****Register 10: Analog Comparator Control 2 (ACCTL2), offset 0x064**

These registers configure the comparator's input and output.

**Analog Comparator Control 0 (ACCTL0)**

Base 0x4003.C000

Offset 0x024

Type R/W, reset 0x0000.0000

	31	30	29	28	27	26	25	24	23	22	21	20	19	18	17	16
	reserved															
Type	RO	RO	RO	RO	RO	RO	RO	RO	RO	RO	RO	RO	RO	RO	RO	RO
Reset	0	0	0	0	0	0	0	0	0	0	0	0	0	0	0	0
	15	14	13	12	11	10	9	8	7	6	5	4	3	2	1	0
	reserved				TOEN	ASRCP		reserved	TSLVAL	TSEN		ISLVAL	ISEN		CINV	reserved
Type	RO	RO	RO	RO	R/W	R/W	R/W	RO	R/W	R/W	R/W	R/W	R/W	R/W	R/W	RO
Reset	0	0	0	0	0	0	0	0	0	0	0	0	0	0	0	0

Bit/Field	Name	Type	Reset	Description
31:12	reserved	RO	0x0000.0	Software should not rely on the value of a reserved bit. To provide compatibility with future products, the value of a reserved bit should be preserved across a read-modify-write operation.
11	TOEN	R/W	0	Trigger Output Enable  Value Description 0 ADC events are suppressed and not sent to the ADC. 1 ADC events are sent to the ADC.
10:9	ASRCP	R/W	0x0	Analog Source Positive  The ASRCP field specifies the source of input voltage to the VIN+ terminal of the comparator. The encodings for this field are as follows:  Value Description 0x0 Pin value of Cn+ 0x1 Pin value of C0+ 0x2 Internal voltage reference (V <sub>IREF</sub> ) 0x3 Reserved
8	reserved	RO	0	Software should not rely on the value of a reserved bit. To provide compatibility with future products, the value of a reserved bit should be preserved across a read-modify-write operation.
7	TSLVAL	R/W	0	Trigger Sense Level Value  Value Description 0 An ADC event is generated if the comparator output is Low. 1 An ADC event is generated if the comparator output is High.

Bit/Field	Name	Type	Reset	Description										
6:5	TSEN	R/W	0x0	<p>Trigger Sense</p> <p>The TSEN field specifies the sense of the comparator output that generates an ADC event. The sense conditioning is as follows:</p> <table border="1"> <thead> <tr> <th>Value</th> <th>Description</th> </tr> </thead> <tbody> <tr> <td>0x0</td> <td>Level sense, see TSLVAL</td> </tr> <tr> <td>0x1</td> <td>Falling edge</td> </tr> <tr> <td>0x2</td> <td>Rising edge</td> </tr> <tr> <td>0x3</td> <td>Either edge</td> </tr> </tbody> </table>	Value	Description	0x0	Level sense, see TSLVAL	0x1	Falling edge	0x2	Rising edge	0x3	Either edge
Value	Description													
0x0	Level sense, see TSLVAL													
0x1	Falling edge													
0x2	Rising edge													
0x3	Either edge													
4	ISLVAL	R/W	0	<p>Interrupt Sense Level Value</p> <table border="1"> <thead> <tr> <th>Value</th> <th>Description</th> </tr> </thead> <tbody> <tr> <td>0</td> <td>An interrupt is generated if the comparator output is Low.</td> </tr> <tr> <td>1</td> <td>An interrupt is generated if the comparator output is High.</td> </tr> </tbody> </table>	Value	Description	0	An interrupt is generated if the comparator output is Low.	1	An interrupt is generated if the comparator output is High.				
Value	Description													
0	An interrupt is generated if the comparator output is Low.													
1	An interrupt is generated if the comparator output is High.													
3:2	ISEN	R/W	0x0	<p>Interrupt Sense</p> <p>The ISEN field specifies the sense of the comparator output that generates an interrupt. The sense conditioning is as follows:</p> <table border="1"> <thead> <tr> <th>Value</th> <th>Description</th> </tr> </thead> <tbody> <tr> <td>0x0</td> <td>Level sense, see ISLVAL</td> </tr> <tr> <td>0x1</td> <td>Falling edge</td> </tr> <tr> <td>0x2</td> <td>Rising edge</td> </tr> <tr> <td>0x3</td> <td>Either edge</td> </tr> </tbody> </table>	Value	Description	0x0	Level sense, see ISLVAL	0x1	Falling edge	0x2	Rising edge	0x3	Either edge
Value	Description													
0x0	Level sense, see ISLVAL													
0x1	Falling edge													
0x2	Rising edge													
0x3	Either edge													
1	CINV	R/W	0	<p>Comparator Output Invert</p> <table border="1"> <thead> <tr> <th>Value</th> <th>Description</th> </tr> </thead> <tbody> <tr> <td>0</td> <td>The output of the comparator is unchanged.</td> </tr> <tr> <td>1</td> <td>The output of the comparator is inverted prior to being processed by hardware.</td> </tr> </tbody> </table>	Value	Description	0	The output of the comparator is unchanged.	1	The output of the comparator is inverted prior to being processed by hardware.				
Value	Description													
0	The output of the comparator is unchanged.													
1	The output of the comparator is inverted prior to being processed by hardware.													
0	reserved	RO	0	Software should not rely on the value of a reserved bit. To provide compatibility with future products, the value of a reserved bit should be preserved across a read-modify-write operation.										

## 22 Pulse Width Modulator (PWM)

Pulse width modulation (PWM) is a powerful technique for digitally encoding analog signal levels. High-resolution counters are used to generate a square wave, and the duty cycle of the square wave is modulated to encode an analog signal. Typical applications include switching power supplies and motor control.

The Stellaris® PWM module consists of four PWM generator blocks and a control block. The control block determines the polarity of the PWM signals, and which signals are passed through to the pins.

Each PWM generator block produces two PWM signals that share the same timer and frequency and can either be programmed with independent actions or as a single pair of complementary signals with dead-band delays inserted. The output signals, `pwmA'` and `pwmB'`, of the PWM generation blocks are managed by the output control block before being passed to the device pins as `PWM0` and `PWM1` or `PWM2` and `PWM3`, and so on.

The Stellaris® PWM module provides a great deal of flexibility and can generate simple PWM signals, such as those required by a simple charge pump as well as paired PWM signals with dead-band delays, such as those required by a half-H bridge driver. Three generator blocks can also generate the full six channels of gate controls required by a 3-phase inverter bridge.

The Stellaris LM3S9B96 PWM module consists of four PWM generator blocks and a control block. Each PWM generator block has the following features:

- Four fault-condition handling input to quickly provide low-latency shutdown and prevent damage to the motor being controlled
- One 16-bit counter
  - Runs in Down or Up/Down mode
  - Output frequency controlled by a 16-bit load value
  - Load value updates can be synchronized
  - Produces output signals at zero and load value
- Two PWM comparators
  - Comparator value updates can be synchronized
  - Produces output signals on match
- PWM signal generator
  - Output PWM signal is constructed based on actions taken as a result of the counter and PWM comparator output signals
  - Produces two independent PWM signals
- Dead-band generator
  - Produces two PWM signals with programmable dead-band delays suitable for driving a half-H bridge
  - Can be bypassed, leaving input PWM signals unmodified

- Can initiate an ADC sample sequence

The control block determines the polarity of the PWM signals and which signals are passed through to the pins. The output of the PWM generation blocks are managed by the output control block before being passed to the device pins. The PWM control block has the following options:

- PWM output enable of each PWM signal
- Optional output inversion of each PWM signal (polarity control)
- Optional fault handling for each PWM signal
- Synchronization of timers in the PWM generator blocks
- Synchronization of timer/comparator updates across the PWM generator blocks
- Synchronization of PWM output enables across the PWM generator blocks
- Interrupt status summary of the PWM generator blocks
- Extended fault capabilities with multiple fault signals, programmable polarities, and filtering
- PWM generators can be operated independently or synchronized with other generators

## **22.1 Block Diagram**

Figure 22-1 on page 1029 provides the Stellaris<sup>®</sup> PWM module unit diagram and Figure 22-2 on page 1029 provides a more detailed diagram of a Stellaris<sup>®</sup> PWM generator. The LM3S9B96 controller contains four generator blocks (PWM0, PWM1, PWM2, and PWM3) and generates eight independent PWM signals or four paired PWM signals with dead-band delays inserted.

Figure 22-1. PWM Unit Diagram

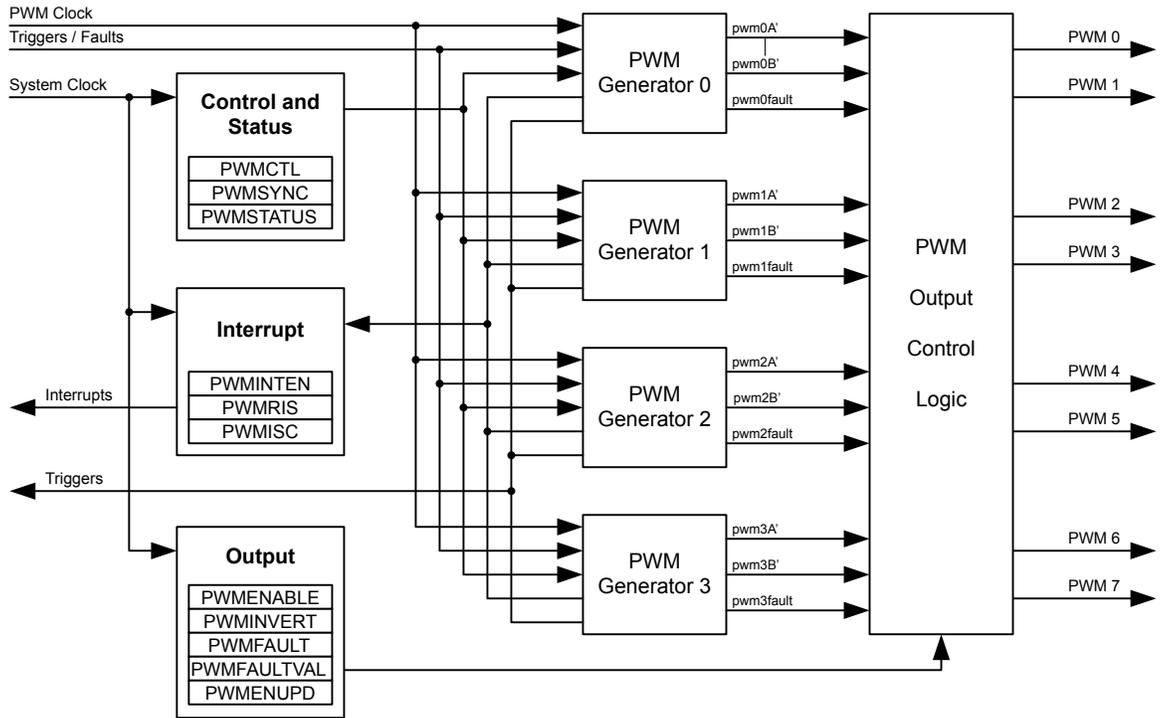
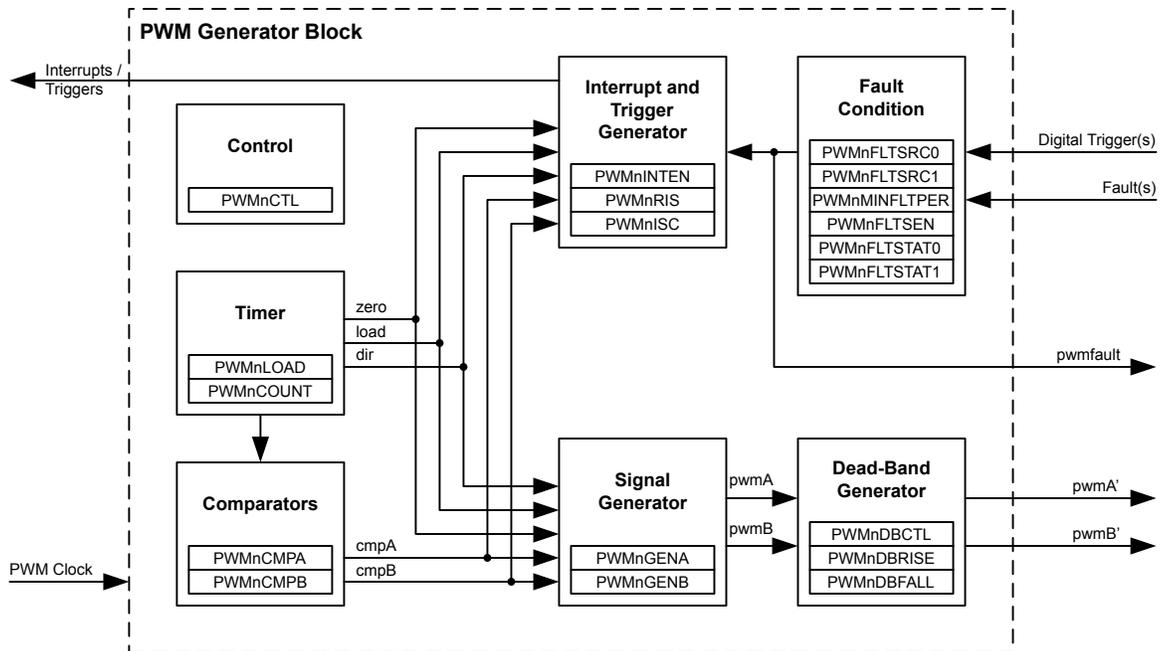


Figure 22-2. PWM Module Block Diagram



## 22.2 Signal Description

Table 22-1 on page 1030 and Table 22-2 on page 1031 list the external signals of the PWM module and describe the function of each. The PWM controller signals are alternate functions for some GPIO

signals and default to be GPIO signals at reset. The column in the table below titled "Pin Mux/Pin Assignment" lists the possible GPIO pin placements for these PWM signals. The **AFSEL** bit in the **GPIO Alternate Function Select (GPIOAFSEL)** register (page 328) should be set to choose the PWM function. The number in parentheses is the encoding that must be programmed into the **PMC<sub>n</sub>** field in the **GPIO Port Control (GPIOPCTL)** register (page 346) to assign the PWM signal to the specified GPIO port pin. For more information on configuring GPIOs, see "General-Purpose Input/Outputs (GPIOs)" on page 304.

**Table 22-1. Signals for PWM (100LQFP)**

Pin Name	Pin Number	Pin Mux / Pin Assignment	Pin Type	Buffer Type <sup>a</sup>	Description
Fault0	6	PE4 (4)	I	TTL	PWM Fault 0.
	39	PJ2 (10)			
	42	PF4 (4)			
	65	PB3 (2)			
	75	PE1 (3)			
	83	PH3 (2)			
	99	PD6 (1)			
Fault1	90	PB6 (4)	I	TTL	PWM Fault 1.
Fault2	24	PC5 (4)	I	TTL	PWM Fault 2.
	63	PH5 (10)			
Fault3	65	PB3 (4)	I	TTL	PWM Fault 3.
	84	PH2 (4)			
PWM0	10	PD0 (1)	O	TTL	PWM 0. This signal is controlled by PWM Generator 0.
	14	PJ0 (10)			
	19	PG0 (2)			
	34	PA6 (4)			
	47	PF0 (3)			
PWM1	11	PD1 (1)	O	TTL	PWM 1. This signal is controlled by PWM Generator 0.
	18	PG1 (2)			
	35	PA7 (4)			
	61	PF1 (3)			
	87	PJ1 (10)			
PWM2	12	PD2 (3)	O	TTL	PWM 2. This signal is controlled by PWM Generator 1.
	60	PF2 (4)			
	66	PB0 (2)			
	86	PH0 (2)			
PWM3	13	PD3 (3)	O	TTL	PWM 3. This signal is controlled by PWM Generator 1.
	59	PF3 (4)			
	67	PB1 (2)			
	85	PH1 (2)			
PWM4	2	PE6 (1)	O	TTL	PWM 4. This signal is controlled by PWM Generator 2.
	19	PG0 (4)			
	28	PA2 (4)			
	34	PA6 (5)			
	60	PF2 (2)			
	62	PH6 (10)			
	74	PE0 (1)			
	86	PH0 (9)			

**Table 22-1. Signals for PWM (100LQFP) (continued)**

Pin Name	Pin Number	Pin Mux / Pin Assignment	Pin Type	Buffer Type <sup>a</sup>	Description
PWM5	1 15 18 29 35 59 75 85	PE7 (1) PH7 (10) PG1 (4) PA3 (4) PA7 (5) PF3 (2) PE1 (1) PH1 (9)	O	TTL	PWM 5. This signal is controlled by PWM Generator 2.
PWM6	25 30	PC4 (4) PA4 (4)	O	TTL	PWM 6. This signal is controlled by PWM Generator 3.
PWM7	23 31 36	PC6 (4) PA5 (4) PG7 (4)	O	TTL	PWM 7. This signal is controlled by PWM Generator 3.

a. The TTL designation indicates the pin has TTL-compatible voltage levels.

**Table 22-2. Signals for PWM (108BGA)**

Pin Name	Pin Number	Pin Mux / Pin Assignment	Pin Type	Buffer Type <sup>a</sup>	Description
Fault0	B2 K6 K4 E11 A12 D10 A3	PE4 (4) PJ2 (10) PF4 (4) PB3 (2) PE1 (3) PH3 (2) PD6 (1)	I	TTL	PWM Fault 0.
Fault1	A7	PB6 (4)	I	TTL	PWM Fault 1.
Fault2	M1 F10	PC5 (4) PH5 (10)	I	TTL	PWM Fault 2.
Fault3	E11 D11	PB3 (4) PH2 (4)	I	TTL	PWM Fault 3.
PWM0	G1 F3 K1 L6 M9	PD0 (1) PJ0 (10) PG0 (2) PA6 (4) PF0 (3)	O	TTL	PWM 0. This signal is controlled by PWM Generator 0.
PWM1	G2 K2 M6 H12 B6	PD1 (1) PG1 (2) PA7 (4) PF1 (3) PJ1 (10)	O	TTL	PWM 1. This signal is controlled by PWM Generator 0.
PWM2	H2 J11 E12 C9	PD2 (3) PF2 (4) PB0 (2) PH0 (2)	O	TTL	PWM 2. This signal is controlled by PWM Generator 1.
PWM3	H1 J12 D12 C8	PD3 (3) PF3 (4) PB1 (2) PH1 (2)	O	TTL	PWM 3. This signal is controlled by PWM Generator 1.

Table 22-2. Signals for PWM (108BGA) (continued)

Pin Name	Pin Number	Pin Mux / Pin Assignment	Pin Type	Buffer Type <sup>a</sup>	Description
PWM4	A1 K1 M4 L6 J11 G3 B11 C9	PE6 (1) PG0 (4) PA2 (4) PA6 (5) PF2 (2) PH6 (10) PE0 (1) PH0 (9)	O	TTL	PWM 4. This signal is controlled by PWM Generator 2.
PWM5	B1 H3 K2 L4 M6 J12 A12 C8	PE7 (1) PH7 (10) PG1 (4) PA3 (4) PA7 (5) PF3 (2) PE1 (1) PH1 (9)	O	TTL	PWM 5. This signal is controlled by PWM Generator 2.
PWM6	L1 L5	PC4 (4) PA4 (4)	O	TTL	PWM 6. This signal is controlled by PWM Generator 3.
PWM7	M2 M5 C10	PC6 (4) PA5 (4) PG7 (4)	O	TTL	PWM 7. This signal is controlled by PWM Generator 3.

a. The TTL designation indicates the pin has TTL-compatible voltage levels.

## 22.3 Functional Description

### 22.3.1 PWM Timer

The timer in each PWM generator runs in one of two modes: Count-Down mode or Count-Up/Down mode. In Count-Down mode, the timer counts from the load value to zero, goes back to the load value, and continues counting down. In Count-Up/Down mode, the timer counts from zero up to the load value, back down to zero, back up to the load value, and so on. Generally, Count-Down mode is used for generating left- or right-aligned PWM signals, while the Count-Up/Down mode is used for generating center-aligned PWM signals.

The timers output three signals that are used in the PWM generation process: the direction signal (this is always Low in Count-Down mode, but alternates between Low and High in Count-Up/Down mode), a single-clock-cycle-width High pulse when the counter is zero, and a single-clock-cycle-width High pulse when the counter is equal to the load value. Note that in Count-Down mode, the zero pulse is immediately followed by the load pulse. In the figures in this chapter, these signals are labelled "dir," "zero," and "load."

### 22.3.2 PWM Comparators

Each PWM generator has two comparators that monitor the value of the counter; when either comparator matches the counter, they output a single-clock-cycle-width High pulse, labelled "cmpA" and "cmpB" in the figures in this chapter. When in Count-Up/Down mode, these comparators match both when counting up and when counting down, and thus are qualified by the counter direction signal. These qualified pulses are used in the PWM generation process. If either comparator match value is greater than the counter load value, then that comparator never outputs a High pulse.

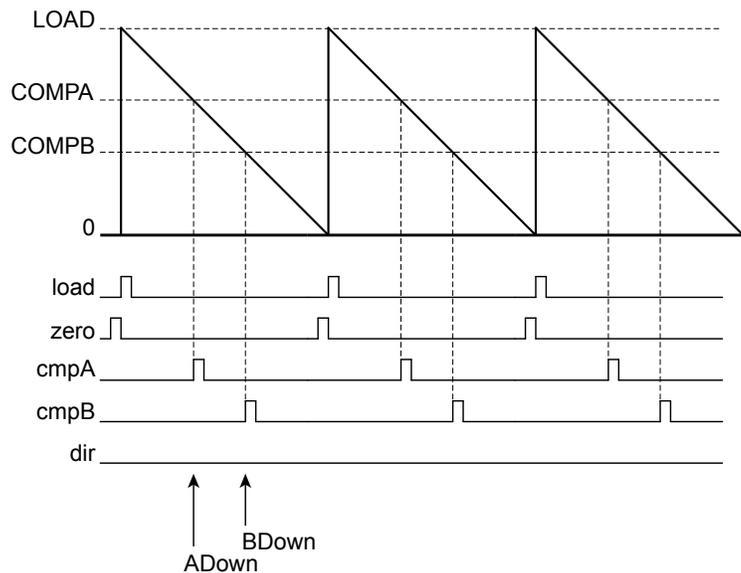
Figure 22-3 on page 1033 shows the behavior of the counter and the relationship of these pulses when the counter is in Count-Down mode. Figure 22-4 on page 1034 shows the behavior of the counter



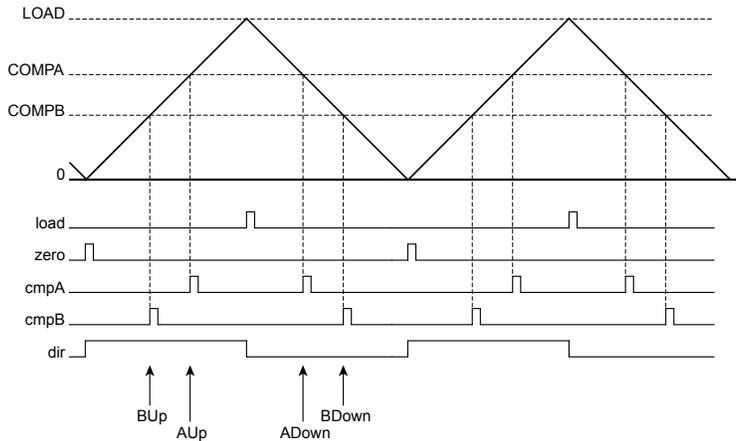
and the relationship of these pulses when the counter is in Count-Up/Down mode. In these figures, the following definitions apply:

- LOAD is the value in the **PWMnLOAD** register
- COMPA is the value in the **PWMnCMPA** register
- COMPB is the value in the **PWMnCMPB** register
- 0 is the value zero
- load is the internal signal that has a single-clock-cycle-width High pulse when the counter is equal to the load value
- zero is the internal signal that has a single-clock-cycle-width High pulse when the counter is zero
- cmpA is the internal signal that has a single-clock-cycle-width High pulse when the counter is equal to COMPA
- cmpB is the internal signal that has a single-clock-cycle-width High pulse when the counter is equal to COMPB
- dir is the internal signal that indicates the count direction

**Figure 22-3. PWM Count-Down Mode**



**Figure 22-4. PWM Count-Up/Down Mode**

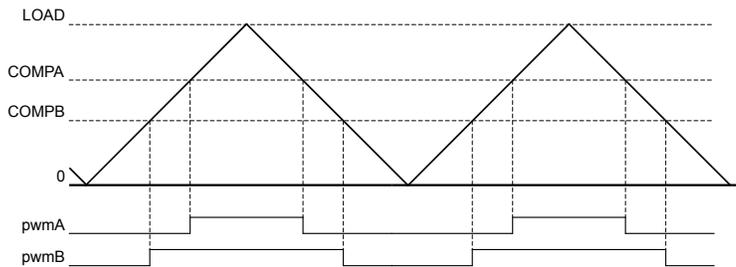


### 22.3.3 PWM Signal Generator

The PWM generator takes the load, zero, cmpA, and cmpB pulses (qualified by the dir signal) and generates two internal PWM signals, pwmA and pwmB. In Count-Down mode, there are four events that can affect these signals: zero, load, match A down, and match B down. In Count-Up/Down mode, there are six events that can affect these signals: zero, load, match A down, match A up, match B down, and match B up. The match A or match B events are ignored when they coincide with the zero or load events. If the match A and match B events coincide, the first signal, pwmA, is generated based only on the match A event, and the second signal, pwmB, is generated based only on the match B event.

For each event, the effect on each output PWM signal is programmable: it can be left alone (ignoring the event), it can be toggled, it can be driven Low, or it can be driven High. These actions can be used to generate a pair of PWM signals of various positions and duty cycles, which do or do not overlap. Figure 22-5 on page 1034 shows the use of Count-Up/Down mode to generate a pair of center-aligned, overlapped PWM signals that have different duty cycles. This figure shows the pwmA and pwmB signals before they have passed through the dead-band generator.

**Figure 22-5. PWM Generation Example In Count-Up/Down Mode**



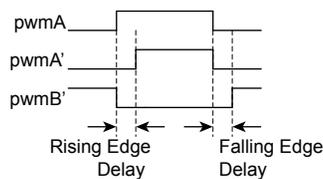
In this example, the first generator is set to drive High on match A up, drive Low on match A down, and ignore the other four events. The second generator is set to drive High on match B up, drive Low on match B down, and ignore the other four events. Changing the value of comparator A changes the duty cycle of the pwmA signal, and changing the value of comparator B changes the duty cycle of the pwmB signal.

### 22.3.4 Dead-Band Generator

The pwmA and pwmB signals produced by the PWM generator are passed to the dead-band generator. If the dead-band generator is disabled, the PWM signals simply pass through to the pwmA' and pwmB' signals unmodified. If the dead-band generator is enabled, the pwmB signal is lost and two PWM signals are generated based on the pwmA signal. The first output PWM signal, pwmA' is the pwmA signal with the rising edge delayed by a programmable amount. The second output PWM signal, pwmB', is the inversion of the pwmA signal with a programmable delay added between the falling edge of the pwmA signal and the rising edge of the pwmB' signal.

The resulting signals are a pair of active High signals where one is always High, except for a programmable amount of time at transitions where both are Low. These signals are therefore suitable for driving a half-H bridge, with the dead-band delays preventing shoot-through current from damaging the power electronics. Figure 22-6 on page 1035 shows the effect of the dead-band generator on the pwmA signal and the resulting pwmA' and pwmB' signals that are transmitted to the output control block.

**Figure 22-6. PWM Dead-Band Generator**



### 22.3.5 Interrupt/ADC-Trigger Selector

The PWM generator also takes the same four (or six) counter events and uses them to generate an interrupt or an ADC trigger. Any of these events or a set of these events can be selected as a source for an interrupt; when any of the selected events occur, an interrupt is generated. Additionally, the same event, a different event, the same set of events, or a different set of events can be selected as a source for an ADC trigger; when any of these selected events occur, an ADC trigger pulse is generated. The selection of events allows the interrupt or ADC trigger to occur at a specific position within the pwmA or pwmB signal. Note that interrupts and ADC triggers are based on the raw events; delays in the PWM signal edges caused by the dead-band generator are not taken into account.

### 22.3.6 Synchronization Methods

The PWM unit provides four PWM generators providing eight PWM outputs that may be used in a wide variety of applications. Generally speaking, the PWM is used in one of two categories of operation:

- **Unsynchronized.** The PWM generator and its two output signals are used alone, independent of other PWM generators.
- **Synchronized.** The PWM generator and its two outputs signals are used in conjunction with other PWM generators using a common, unified time base. If multiple PWM generators are configured with the same counter load value, synchronization can be used to guarantee that they also have the same count value (the PWM generators must be configured before they are synchronized). With this feature, more than two  $PWM_n$  signals can be produced with a known relationship between the edges of those signals because the counters always have the same values. Other states in the unit provide mechanisms to maintain the common time base and mutual synchronization.

The counter in a PWM unit generator can be reset to zero by writing the **PWM Time Base Sync (PWMSYNC)** register and setting the `SYNCn` bit associated with the generator. Multiple PWM generators can be synchronized together by setting all necessary `SYNCn` bits in one access. For example, setting the `SYNC0` and `SYNC1` bits in the **PWMSYNC** register causes the counters in PWM generators 0 and 1 to reset together.

Additional synchronization can occur between multiple PWM generators by updating register contents in one of the following three ways:

- **Immediately.** The write value has immediate effect, and the hardware reacts immediately.
- **Locally Synchronized.** The write value does not affect the logic until the counter reaches the value zero at the end of the PWM cycle. In this case, the effect of the write is deferred, providing a guaranteed defined behavior and preventing overly short or overly long output PWM pulses.
- **Globally Synchronized.** The write value does not affect the logic until two sequential events have occurred: (1) the Update mode for the generator function is programmed for global synchronization in the **PWMnCTL** register, and (2) the counter reaches zero at the end of the PWM cycle. In this case, the effect of the write is deferred until the end of the PWM cycle following the end of all updates. This mode allows multiple items in multiple PWM generators to be updated simultaneously without odd effects during the update; everything runs from the old values until a point at which they all run from the new values. The Update mode of the load and comparator match values can be individually configured in each PWM generator block. It typically makes sense to use the synchronous update mechanism across PWM generator blocks when the timers in those blocks are synchronized, although this is not required in order for this mechanism to function properly.

The following registers provide either local or global synchronization based on the state of various Update mode bits and fields in the **PWMnCTL** register (`LOADUPD`; `CMPAUPD`; `CMPBUPD`):

- Generator Registers: **PWMnLOAD**, **PWMnCMPA**, and **PWMnCMPB**

The following registers default to immediate update, but are provided with the optional functionality of synchronously updating rather than having all updates take immediate effect:

- Module-Level Register: **PWMENABLE** (based on the state of the `ENUPDn` bits in the `PWMENUPD` register).
- Generator Register: **PWMnGENA**, **PWMnGENB**, **PWMnDBCTL**, **PWMnDBRISE**, and **PWMnDBFALL** (based on the state of various Update mode bits and fields in the **PWMnCTL** register (`GENAUPD`; `GENBUPD`; `DBCTLUPD`; `DBRISEUPD`; `DBFALLUPD`)).

All other registers are considered statically provisioned for the execution of an application or are used dynamically for purposes unrelated to maintaining synchronization and therefore do not need synchronous update functionality.

### 22.3.7 Fault Conditions

A fault condition is one in which the controller must be signaled to stop normal PWM function and then set the `PWMn` signals to a safe state. Two basic situations cause fault conditions:

- The microcontroller is stalled and cannot perform the necessary computation in the time required for motion control
- An external error or event is detected

The PWM unit can use the following inputs to generate a fault condition, including:

- **FAULT<sub>n</sub>** pin assertion
- A stall of the controller generated by the debugger
- The trigger of an ADC digital comparator

Fault conditions are calculated on a per-PWM generator basis. Each PWM generator configures the necessary conditions to indicate a fault condition exists. This method allows the development of applications with dependent and independent control.

Four fault input pins (**FAULT0-FAULT3**). These inputs may be used with circuits that generate an active High or active Low signal to indicate an error condition. A **FAULT<sub>n</sub>** pins may be individually programmed for the appropriate logic sense using the **PWMnFLTSEN** register.

The PWM generator's mode control, including fault condition handling, is provided in the **PWMnCTL** register. This register determines whether the **FAULT0** input or a combination of **FAULT<sub>n</sub>** input signals and/or digital comparator triggers (as configured by the **PWMnFLTSRC0** and **PWMnFLTSRC1** registers) is used to generate a fault condition. The **PWMnCTL** register also selects whether the fault condition is maintained as long as the external condition lasts or if it is latched until the fault condition until cleared by software. Finally, this register also enables a counter that may be used to extend the period of a fault condition for external events to assure that the duration is a minimum length. The minimum fault period count is specified in the **PWMnMINFLTPER** register.

Status regarding the specific fault cause is provided in the **PWMnFLTSTAT0** and **PWMnFLTSTAT1** registers.

PWM generator fault conditions may be promoted to a controller interrupt using the **PWMINTEN** register.

### 22.3.8 Output Control Block

The output control block takes care of the final conditioning of the **pwmA'** and **pwmB'** signals before they go to the pins as the **PWM<sub>n</sub>** signals. Via a single register, the **PWM Output Enable (PWENABLE)** register, the set of PWM signals that are actually enabled to the pins can be modified. This function can be used, for example, to perform commutation of a brushless DC motor with a single register write (and without modifying the individual PWM generators, which are modified by the feedback control loop). In addition, the updating of the bits in the **PWENABLE** register can be configured to be immediate or locally or globally synchronized to the next synchronous update using the **PWM Enable Update (PWMENUPE)** register.

During fault conditions, the PWM output signals, **PWM<sub>n</sub>**, usually must be driven to safe values so that external equipment may be safely controlled. The **PWMFAULT** register specifies whether during a fault condition, the generated signal continues to be passed driven or to an encoding specified in the **PWMFAULTVAL** register.

A final inversion can be applied to any of the **PWM<sub>n</sub>** signals, making them active Low instead of the default active High using the **PWM Output Inversion (PWMINVERT)**. The inversion is applied even if a value has been enabled in the **PWMFAULT** register and specified in the **PWMFAULTVAL** register. In other words, if a bit is set in the **PWMFAULT**, **PWMFAULTVAL**, and **PWMINVERT** registers, the output on the **PWM<sub>n</sub>** signal is 0, not 1 as specified in the **PWMFAULTVAL** register.

## 22.4 Initialization and Configuration

The following example shows how to initialize PWM Generator 0 with a 25-kHz frequency, a 25% duty cycle on the `PWM0` pin, and a 75% duty cycle on the `PWM1` pin. This example assumes the system clock is 20 MHz.

1. Enable the PWM clock by writing a value of 0x0010.0000 to the **RCGC0** register in the System Control module (see page 173).
2. Enable the clock to the appropriate GPIO module via the **RCGC2** register in the System Control module (see page 193).
3. In the GPIO module, enable the appropriate pins for their alternate function using the **GPIOAFSEL** register. To determine which GPIOs to configure, see Table 25-4 on page 1151.
4. Configure the `PMCn` fields in the **GPIOPCTL** register to assign the PWM signals to the appropriate pins (see page 346 and Table 25-5 on page 1160).
5. Configure the **Run-Mode Clock Configuration (RCC)** register in the System Control module to use the PWM divide (`USEPWMDIV`) and set the divider (`PWMDIV`) to divide by 2 (000).
6. Configure the PWM generator for countdown mode with immediate updates to the parameters.
  - Write the **PWM0CTL** register with a value of 0x0000.0000.
  - Write the **PWM0GENA** register with a value of 0x0000.008C.
  - Write the **PWM0GENB** register with a value of 0x0000.080C.
7. Set the period. For a 25-KHz frequency, the period = 1/25,000, or 40 microseconds. The PWM clock source is 10 MHz; the system clock divided by 2. Thus there are 400 clock ticks per period. Use this value to set the **PWM0LOAD** register. In Count-Down mode, set the `LOAD` field in the **PWM0LOAD** register to the requested period minus one.
  - Write the **PWM0LOAD** register with a value of 0x0000.018F.
8. Set the pulse width of the `PWM0` pin for a 25% duty cycle.
  - Write the **PWM0CMPA** register with a value of 0x0000.012B.
9. Set the pulse width of the `PWM1` pin for a 75% duty cycle.
  - Write the **PWM0CMPB** register with a value of 0x0000.0063.
10. Start the timers in PWM generator 0.
  - Write the **PWM0CTL** register with a value of 0x0000.0001.
11. Enable PWM outputs.
  - Write the **PWMENABLE** register with a value of 0x0000.0003.

## 22.5 Register Map

Table 22-3 on page 1039 lists the PWM registers. The offset listed is a hexadecimal increment to the register's address, relative to the PWM base address of 0x4002.8000. Note that the PWM module clock must be enabled before the registers can be programmed (see page 173).

**Table 22-3. PWM Register Map**

Offset	Name	Type	Reset	Description	See page
0x000	PWMCTL	R/W	0x0000.0000	PWM Master Control	1042
0x004	PWMSYNC	R/W	0x0000.0000	PWM Time Base Sync	1044
0x008	PWMENABLE	R/W	0x0000.0000	PWM Output Enable	1045
0x00C	PWMINVERT	R/W	0x0000.0000	PWM Output Inversion	1047
0x010	PWMFAULT	R/W	0x0000.0000	PWM Output Fault	1049
0x014	PWMINTEN	R/W	0x0000.0000	PWM Interrupt Enable	1051
0x018	PWMRIS	RO	0x0000.0000	PWM Raw Interrupt Status	1053
0x01C	PWMISC	R/W1C	0x0000.0000	PWM Interrupt Status and Clear	1056
0x020	PWMSTATUS	RO	0x0000.0000	PWM Status	1059
0x024	PWMFAULTVAL	R/W	0x0000.0000	PWM Fault Condition Value	1061
0x028	PWMENUPD	R/W	0x0000.0000	PWM Enable Update	1063
0x040	PWM0CTL	R/W	0x0000.0000	PWM0 Control	1067
0x044	PWM0INTEN	R/W	0x0000.0000	PWM0 Interrupt and Trigger Enable	1072
0x048	PWM0RIS	RO	0x0000.0000	PWM0 Raw Interrupt Status	1075
0x04C	PWM0ISC	R/W1C	0x0000.0000	PWM0 Interrupt Status and Clear	1077
0x050	PWM0LOAD	R/W	0x0000.0000	PWM0 Load	1079
0x054	PWM0COUNT	RO	0x0000.0000	PWM0 Counter	1080
0x058	PWM0CMPA	R/W	0x0000.0000	PWM0 Compare A	1081
0x05C	PWM0CMPB	R/W	0x0000.0000	PWM0 Compare B	1082
0x060	PWM0GENA	R/W	0x0000.0000	PWM0 Generator A Control	1083
0x064	PWM0GENB	R/W	0x0000.0000	PWM0 Generator B Control	1086
0x068	PWM0DBCTL	R/W	0x0000.0000	PWM0 Dead-Band Control	1089
0x06C	PWM0DBRISE	R/W	0x0000.0000	PWM0 Dead-Band Rising-Edge Delay	1090
0x070	PWM0DBFALL	R/W	0x0000.0000	PWM0 Dead-Band Falling-Edge-Delay	1091
0x074	PWM0FLTSRC0	R/W	0x0000.0000	PWM0 Fault Source 0	1092
0x078	PWM0FLTSRC1	R/W	0x0000.0000	PWM0 Fault Source 1	1094
0x07C	PWM0MINFLTPER	R/W	0x0000.0000	PWM0 Minimum Fault Period	1097
0x080	PWM1CTL	R/W	0x0000.0000	PWM1 Control	1067

Table 22-3. PWM Register Map (continued)

Offset	Name	Type	Reset	Description	See page
0x084	PWM1INTEN	R/W	0x0000.0000	PWM1 Interrupt and Trigger Enable	1072
0x088	PWM1RIS	RO	0x0000.0000	PWM1 Raw Interrupt Status	1075
0x08C	PWM1ISC	R/W1C	0x0000.0000	PWM1 Interrupt Status and Clear	1077
0x090	PWM1LOAD	R/W	0x0000.0000	PWM1 Load	1079
0x094	PWM1COUNT	RO	0x0000.0000	PWM1 Counter	1080
0x098	PWM1CMPA	R/W	0x0000.0000	PWM1 Compare A	1081
0x09C	PWM1CMPB	R/W	0x0000.0000	PWM1 Compare B	1082
0x0A0	PWM1GENA	R/W	0x0000.0000	PWM1 Generator A Control	1083
0x0A4	PWM1GENB	R/W	0x0000.0000	PWM1 Generator B Control	1086
0x0A8	PWM1DBCTL	R/W	0x0000.0000	PWM1 Dead-Band Control	1089
0x0AC	PWM1DBRISE	R/W	0x0000.0000	PWM1 Dead-Band Rising-Edge Delay	1090
0x0B0	PWM1DBFALL	R/W	0x0000.0000	PWM1 Dead-Band Falling-Edge-Delay	1091
0x0B4	PWM1FLTSRC0	R/W	0x0000.0000	PWM1 Fault Source 0	1092
0x0B8	PWM1FLTSRC1	R/W	0x0000.0000	PWM1 Fault Source 1	1094
0x0BC	PWM1MINFLTPER	R/W	0x0000.0000	PWM1 Minimum Fault Period	1097
0x0C0	PWM2CTL	R/W	0x0000.0000	PWM2 Control	1067
0x0C4	PWM2INTEN	R/W	0x0000.0000	PWM2 Interrupt and Trigger Enable	1072
0x0C8	PWM2RIS	RO	0x0000.0000	PWM2 Raw Interrupt Status	1075
0x0CC	PWM2ISC	R/W1C	0x0000.0000	PWM2 Interrupt Status and Clear	1077
0x0D0	PWM2LOAD	R/W	0x0000.0000	PWM2 Load	1079
0x0D4	PWM2COUNT	RO	0x0000.0000	PWM2 Counter	1080
0x0D8	PWM2CMPA	R/W	0x0000.0000	PWM2 Compare A	1081
0x0DC	PWM2CMPB	R/W	0x0000.0000	PWM2 Compare B	1082
0x0E0	PWM2GENA	R/W	0x0000.0000	PWM2 Generator A Control	1083
0x0E4	PWM2GENB	R/W	0x0000.0000	PWM2 Generator B Control	1086
0x0E8	PWM2DBCTL	R/W	0x0000.0000	PWM2 Dead-Band Control	1089
0x0EC	PWM2DBRISE	R/W	0x0000.0000	PWM2 Dead-Band Rising-Edge Delay	1090
0x0F0	PWM2DBFALL	R/W	0x0000.0000	PWM2 Dead-Band Falling-Edge-Delay	1091
0x0F4	PWM2FLTSRC0	R/W	0x0000.0000	PWM2 Fault Source 0	1092
0x0F8	PWM2FLTSRC1	R/W	0x0000.0000	PWM2 Fault Source 1	1094
0x0FC	PWM2MINFLTPER	R/W	0x0000.0000	PWM2 Minimum Fault Period	1097
0x100	PWM3CTL	R/W	0x0000.0000	PWM3 Control	1067



Table 22-3. PWM Register Map (continued)

Offset	Name	Type	Reset	Description	See page
0x104	PWM3INTEN	R/W	0x0000.0000	PWM3 Interrupt and Trigger Enable	1072
0x108	PWM3RIS	RO	0x0000.0000	PWM3 Raw Interrupt Status	1075
0x10C	PWM3ISC	R/W1C	0x0000.0000	PWM3 Interrupt Status and Clear	1077
0x110	PWM3LOAD	R/W	0x0000.0000	PWM3 Load	1079
0x114	PWM3COUNT	RO	0x0000.0000	PWM3 Counter	1080
0x118	PWM3CMPA	R/W	0x0000.0000	PWM3 Compare A	1081
0x11C	PWM3CMPB	R/W	0x0000.0000	PWM3 Compare B	1082
0x120	PWM3GENA	R/W	0x0000.0000	PWM3 Generator A Control	1083
0x124	PWM3GENB	R/W	0x0000.0000	PWM3 Generator B Control	1086
0x128	PWM3DBCTL	R/W	0x0000.0000	PWM3 Dead-Band Control	1089
0x12C	PWM3DBRISE	R/W	0x0000.0000	PWM3 Dead-Band Rising-Edge Delay	1090
0x130	PWM3DBFALL	R/W	0x0000.0000	PWM3 Dead-Band Falling-Edge-Delay	1091
0x134	PWM3FLTSRC0	R/W	0x0000.0000	PWM3 Fault Source 0	1092
0x138	PWM3FLTSRC1	R/W	0x0000.0000	PWM3 Fault Source 1	1094
0x13C	PWM3MINFLTPER	R/W	0x0000.0000	PWM3 Minimum Fault Period	1097
0x800	PWM0FLTSEN	R/W	0x0000.0000	PWM0 Fault Pin Logic Sense	1098
0x804	PWM0FLTSTAT0	-	0x0000.0000	PWM0 Fault Status 0	1099
0x808	PWM0FLTSTAT1	-	0x0000.0000	PWM0 Fault Status 1	1101
0x880	PWM1FLTSEN	R/W	0x0000.0000	PWM1 Fault Pin Logic Sense	1098
0x884	PWM1FLTSTAT0	-	0x0000.0000	PWM1 Fault Status 0	1099
0x888	PWM1FLTSTAT1	-	0x0000.0000	PWM1 Fault Status 1	1101
0x900	PWM2FLTSEN	R/W	0x0000.0000	PWM2 Fault Pin Logic Sense	1098
0x904	PWM2FLTSTAT0	-	0x0000.0000	PWM2 Fault Status 0	1099
0x908	PWM2FLTSTAT1	-	0x0000.0000	PWM2 Fault Status 1	1101
0x980	PWM3FLTSEN	R/W	0x0000.0000	PWM3 Fault Pin Logic Sense	1098
0x984	PWM3FLTSTAT0	-	0x0000.0000	PWM3 Fault Status 0	1099
0x988	PWM3FLTSTAT1	-	0x0000.0000	PWM3 Fault Status 1	1101

## 22.6 Register Descriptions

The remainder of this section lists and describes the PWM registers, in numerical order by address offset.

## Register 1: PWM Master Control (PWMCTL), offset 0x000

This register provides master control over the PWM generation blocks.

### PWM Master Control (PWMCTL)

Base 0x4002.8000  
 Offset 0x000  
 Type R/W, reset 0x0000.0000

	31	30	29	28	27	26	25	24	23	22	21	20	19	18	17	16
	reserved															
Type	RO	RO	RO	RO	RO	RO	RO	RO	RO	RO	RO	RO	RO	RO	RO	RO
Reset	0	0	0	0	0	0	0	0	0	0	0	0	0	0	0	0
	15	14	13	12	11	10	9	8	7	6	5	4	3	2	1	0
	reserved												GLOBALSYNC3	GLOBALSYNC2	GLOBALSYNC1	GLOBALSYNC0
Type	RO	RO	RO	RO	RO	RO	RO	RO	RO	RO	RO	RO	R/W	R/W	R/W	R/W
Reset	0	0	0	0	0	0	0	0	0	0	0	0	0	0	0	0

Bit/Field	Name	Type	Reset	Description
31:4	reserved	RO	0x0000	Software should not rely on the value of a reserved bit. To provide compatibility with future products, the value of a reserved bit should be preserved across a read-modify-write operation.
3	GLOBALSYNC3	R/W	0	Update PWM Generator 3  Value Description 1 Any queued update to a load or comparator register in PWM generator 3 is applied the next time the corresponding counter becomes zero. 0 No effect.  This bit automatically clears when the updates have completed; it cannot be cleared by software.
2	GLOBALSYNC2	R/W	0	Update PWM Generator 2  Value Description 1 Any queued update to a load or comparator register in PWM generator 2 is applied the next time the corresponding counter becomes zero. 0 No effect.  This bit automatically clears when the updates have completed; it cannot be cleared by software.
1	GLOBALSYNC1	R/W	0	Update PWM Generator 1  Value Description 1 Any queued update to a load or comparator register in PWM generator 1 is applied the next time the corresponding counter becomes zero. 0 No effect.  This bit automatically clears when the updates have completed; it cannot be cleared by software.

---

Bit/Field	Name	Type	Reset	Description
0	GLOBALSYNC0	R/W	0	Update PWM Generator 0
				Value Description
			1	Any queued update to a load or comparator register in PWM generator 0 is applied the next time the corresponding counter becomes zero.
			0	No effect.
				This bit automatically clears when the updates have completed; it cannot be cleared by software.

## Register 2: PWM Time Base Sync (PWMSYNC), offset 0x004

This register provides a method to perform synchronization of the counters in the PWM generation blocks. Setting a bit in this register causes the specified counter to reset back to 0; setting multiple bits resets multiple counters simultaneously. The bits auto-clear after the reset has occurred; reading them back as zero indicates that the synchronization has completed.

### PWM Time Base Sync (PWMSYNC)

Base 0x4002.8000  
 Offset 0x004  
 Type R/W, reset 0x0000.0000

	31	30	29	28	27	26	25	24	23	22	21	20	19	18	17	16	
	reserved																
Type	RO	RO	RO	RO	RO	RO	RO	RO	RO	RO	RO	RO	RO	RO	RO	RO	
Reset	0	0	0	0	0	0	0	0	0	0	0	0	0	0	0	0	
	15	14	13	12	11	10	9	8	7	6	5	4	3	2	1	0	
	reserved												SYNC3	SYNC2	SYNC1	SYNC0	
Type	RO	RO	RO	RO	RO	RO	RO	RO	RO	RO	RO	RO	RO	R/W	R/W	R/W	R/W
Reset	0	0	0	0	0	0	0	0	0	0	0	0	0	0	0	0	0

Bit/Field	Name	Type	Reset	Description
31:4	reserved	RO	0x0000.000	Software should not rely on the value of a reserved bit. To provide compatibility with future products, the value of a reserved bit should be preserved across a read-modify-write operation.
3	SYNC3	R/W	0	Reset Generator 3 Counter  Value Description 1 Resets the PWM generator 3 counter. 0 No effect.
2	SYNC2	R/W	0	Reset Generator 2 Counter  Value Description 1 Resets the PWM generator 2 counter. 0 No effect.
1	SYNC1	R/W	0	Reset Generator 1 Counter  Value Description 1 Resets the PWM generator 1 counter. 0 No effect.
0	SYNC0	R/W	0	Reset Generator 0 Counter  Value Description 1 Resets the PWM generator 0 counter. 0 No effect.

### Register 3: PWM Output Enable (PWMENABLE), offset 0x008

This register provides a master control of which generated pwmA' and pwmB' signals are output to the  $PWM_n$  pins. By disabling a PWM output, the generation process can continue (for example, when the time bases are synchronized) without driving PWM signals to the pins. When bits in this register are set, the corresponding pwmA' or pwmB' signal is passed through to the output stage. When bits are clear, the pwmA' or pwmB' signal is replaced by a zero value which is also passed to the output stage. The **PWMINVERT** register controls the output stage, so if the corresponding bit is set in that register, the value seen on the  $PWM_n$  signal is inverted from what is configured by the bits in this register. Updates to the bits in this register can be immediate or locally or globally synchronized to the next synchronous update as controlled by the  $ENUPD_n$  fields in the **PWMENUPD** register.

#### PWM Output Enable (PWMENABLE)

Base 0x4002.8000  
Offset 0x008  
Type R/W, reset 0x0000.0000

	31	30	29	28	27	26	25	24	23	22	21	20	19	18	17	16
	reserved															
Type	RO	RO	RO	RO	RO	RO	RO	RO	RO	RO	RO	RO	RO	RO	RO	RO
Reset	0	0	0	0	0	0	0	0	0	0	0	0	0	0	0	0
	15	14	13	12	11	10	9	8	7	6	5	4	3	2	1	0
	reserved								PWM7EN	PWM6EN	PWM5EN	PWM4EN	PWM3EN	PWM2EN	PWM1EN	PWM0EN
Type	RO	RO	RO	RO	RO	RO	RO	RO	R/W	R/W	R/W	R/W	R/W	R/W	R/W	R/W
Reset	0	0	0	0	0	0	0	0	0	0	0	0	0	0	0	0

Bit/Field	Name	Type	Reset	Description
31:8	reserved	RO	0x0000.00	Software should not rely on the value of a reserved bit. To provide compatibility with future products, the value of a reserved bit should be preserved across a read-modify-write operation.
7	PWM7EN	R/W	0	PWM7 Output Enable  Value Description 1 The generated pwm3B' signal is passed to the $PWM7$ pin. 0 The $PWM7$ signal has a zero value.
6	PWM6EN	R/W	0	PWM6 Output Enable  Value Description 1 The generated pwm3A' signal is passed to the $PWM6$ pin. 0 The $PWM6$ signal has a zero value.
5	PWM5EN	R/W	0	PWM5 Output Enable  Value Description 1 The generated pwm2B' signal is passed to the $PWM5$ pin. 0 The $PWM5$ signal has a zero value.

Bit/Field	Name	Type	Reset	Description
4	PWM4EN	R/W	0	PWM4 Output Enable  Value Description 1 The generated pwm2A' signal is passed to the PWM4 pin. 0 The PWM4 signal has a zero value.
3	PWM3EN	R/W	0	PWM3 Output Enable  Value Description 1 The generated pwm1B' signal is passed to the PWM3 pin. 0 The PWM3 signal has a zero value.
2	PWM2EN	R/W	0	PWM2 Output Enable  Value Description 1 The generated pwm1A' signal is passed to the PWM2 pin. 0 The PWM2 signal has a zero value.
1	PWM1EN	R/W	0	PWM1 Output Enable  Value Description 1 The generated pwm0B' signal is passed to the PWM1 pin. 0 The PWM1 signal has a zero value.
0	PWM0EN	R/W	0	PWM0 Output Enable  Value Description 1 The generated pwm0A' signal is passed to the PWM0 pin. 0 The PWM0 signal has a zero value.

## Register 4: PWM Output Inversion (PWMINVERT), offset 0x00C

This register provides a master control of the polarity of the  $PWM_n$  signals on the device pins. The  $pwmA'$  and  $pwmB'$  signals generated by the PWM generator are active High; but can be made active Low via this register. Disabled PWM channels are also passed through the output inverter (if so configured) so that inactive signals can be High. In addition, if the **PWMFAULT** register enables a specific value to be placed on the  $PWM_n$  signals during a fault condition, that value is inverted if the corresponding bit in this register is set.

### PWM Output Inversion (PWMINVERT)

Base 0x4002.8000  
Offset 0x00C  
Type R/W, reset 0x0000.0000

	31	30	29	28	27	26	25	24	23	22	21	20	19	18	17	16
	reserved															
Type	RO	RO	RO	RO	RO	RO	RO	RO	RO	RO	RO	RO	RO	RO	RO	RO
Reset	0	0	0	0	0	0	0	0	0	0	0	0	0	0	0	0
	15	14	13	12	11	10	9	8	7	6	5	4	3	2	1	0
	reserved								PWM7INV	PWM6INV	PWM5INV	PWM4INV	PWM3INV	PWM2INV	PWM1INV	PWM0INV
Type	RO	RO	RO	RO	RO	RO	RO	RO	R/W	R/W	R/W	R/W	R/W	R/W	R/W	R/W
Reset	0	0	0	0	0	0	0	0	0	0	0	0	0	0	0	0

Bit/Field	Name	Type	Reset	Description
31:8	reserved	RO	0x0000.00	Software should not rely on the value of a reserved bit. To provide compatibility with future products, the value of a reserved bit should be preserved across a read-modify-write operation.
7	PWM7INV	R/W	0	Invert $PWM_7$ Signal  Value Description 1 The $PWM_7$ signal is inverted. 0 The $PWM_7$ signal is not inverted.
6	PWM6INV	R/W	0	Invert $PWM_6$ Signal  Value Description 1 The $PWM_6$ signal is inverted. 0 The $PWM_6$ signal is not inverted.
5	PWM5INV	R/W	0	Invert $PWM_5$ Signal  Value Description 1 The $PWM_5$ signal is inverted. 0 The $PWM_5$ signal is not inverted.
4	PWM4INV	R/W	0	Invert $PWM_4$ Signal  Value Description 1 The $PWM_4$ signal is inverted. 0 The $PWM_4$ signal is not inverted.

Bit/Field	Name	Type	Reset	Description
3	PWM3INV	R/W	0	Invert PWM3 Signal  Value Description 1 The PWM3 signal is inverted. 0 The PWM3 signal is not inverted.
2	PWM2INV	R/W	0	Invert PWM2 Signal  Value Description 1 The PWM2 signal is inverted. 0 The PWM2 signal is not inverted.
1	PWM1INV	R/W	0	Invert PWM1 Signal  Value Description 1 The PWM1 signal is inverted. 0 The PWM1 signal is not inverted.
0	PWM0INV	R/W	0	Invert PWM0 Signal  Value Description 1 The PWM0 signal is inverted. 0 The PWM0 signal is not inverted.



## Register 5: PWM Output Fault (PWMFAULT), offset 0x010

This register controls the behavior of the  $PWM_n$  outputs in the presence of fault conditions. Both the fault inputs ( $FAULT_n$  pins and digital comparator outputs) and debug events are considered fault conditions. On a fault condition, each pwmA' or pwmB' signal can be passed through unmodified or driven to the value specified by the corresponding bit in the **PWMFAULTVAL** register. For outputs that are configured for pass-through, the debug event handling on the corresponding PWM generator also determines if the pwmA' or pwmB' signal continues to be generated.

Fault condition control occurs before the output inverter, so PWM signals driven to a specified value on fault are inverted if the channel is configured for inversion (therefore, the pin is driven to the logical complement of the specified value on a fault condition).

### PWM Output Fault (PWMFAULT)

Base 0x4002.8000  
Offset 0x010  
Type R/W, reset 0x0000.0000

	31	30	29	28	27	26	25	24	23	22	21	20	19	18	17	16
	reserved															
Type	RO	RO	RO	RO	RO	RO	RO	RO	RO	RO	RO	RO	RO	RO	RO	RO
Reset	0	0	0	0	0	0	0	0	0	0	0	0	0	0	0	0
	15	14	13	12	11	10	9	8	7	6	5	4	3	2	1	0
	reserved								FAULT7	FAULT6	FAULT5	FAULT4	FAULT3	FAULT2	FAULT1	FAULT0
Type	RO	RO	RO	RO	RO	RO	RO	RO	R/W	R/W	R/W	R/W	R/W	R/W	R/W	R/W
Reset	0	0	0	0	0	0	0	0	0	0	0	0	0	0	0	0

Bit/Field	Name	Type	Reset	Description
31:8	reserved	RO	0x0000.00	Software should not rely on the value of a reserved bit. To provide compatibility with future products, the value of a reserved bit should be preserved across a read-modify-write operation.
7	FAULT7	R/W	0	PWM7 Fault  Value Description 1 The $PWM7$ output signal is driven to the value specified by the $PWM7$ bit in the <b>PWMFAULTVAL</b> register. 0 The generated pwm3B' signal is passed to the $PWM7$ pin.
6	FAULT6	R/W	0	PWM6 Fault  Value Description 1 The $PWM6$ output signal is driven to the value specified by the $PWM6$ bit in the <b>PWMFAULTVAL</b> register. 0 The generated pwm3A' signal is passed to the $PWM6$ pin.
5	FAULT5	R/W	0	PWM5 Fault  Value Description 1 The $PWM5$ output signal is driven to the value specified by the $PWM5$ bit in the <b>PWMFAULTVAL</b> register. 0 The generated pwm2B' signal is passed to the $PWM5$ pin.

Bit/Field	Name	Type	Reset	Description
4	FAULT4	R/W	0	<p>PWM4 Fault</p> <p>Value Description</p> <p>1 The PWM4 output signal is driven to the value specified by the PWM4 bit in the <b>PWMFAULTVAL</b> register.</p> <p>0 The generated pwm2A' signal is passed to the PWM4 pin.</p>
3	FAULT3	R/W	0	<p>PWM3 Fault</p> <p>Value Description</p> <p>1 The PWM3 output signal is driven to the value specified by the PWM3 bit in the <b>PWMFAULTVAL</b> register.</p> <p>0 The generated pwm1B' signal is passed to the PWM3 pin.</p>
2	FAULT2	R/W	0	<p>PWM2 Fault</p> <p>Value Description</p> <p>1 The PWM2 output signal is driven to the value specified by the PWM2 bit in the <b>PWMFAULTVAL</b> register.</p> <p>0 The generated pwm1A' signal is passed to the PWM2 pin.</p>
1	FAULT1	R/W	0	<p>PWM1 Fault</p> <p>Value Description</p> <p>1 The PWM1 output signal is driven to the value specified by the PWM1 bit in the <b>PWMFAULTVAL</b> register.</p> <p>0 The generated pwm0B' signal is passed to the PWM1 pin.</p>
0	FAULT0	R/W	0	<p>PWM0 Fault</p> <p>Value Description</p> <p>1 The PWM0 output signal is driven to the value specified by the PWM0 bit in the <b>PWMFAULTVAL</b> register.</p> <p>0 The generated pwm0A' signal is passed to the PWM0 pin.</p>

**Register 6: PWM Interrupt Enable (PWMINTEN), offset 0x014**

This register controls the global interrupt generation capabilities of the PWM module. The events that can cause an interrupt are the fault input and the individual interrupts from the PWM generators.

**PWM Interrupt Enable (PWMINTEN)**

Base 0x4002.8000  
Offset 0x014  
Type R/W, reset 0x0000.0000

	31	30	29	28	27	26	25	24	23	22	21	20	19	18	17	16
	reserved												INTFAULT3	INTFAULT2	INTFAULT1	INTFAULT0
Type	RO	RO	RO	RO	RO	RO	RO	RO	RO	RO	RO	RO	R/W	R/W	R/W	R/W
Reset	0	0	0	0	0	0	0	0	0	0	0	0	0	0	0	0
	15	14	13	12	11	10	9	8	7	6	5	4	3	2	1	0
	reserved												INTPWM3	INTPWM2	INTPWM1	INTPWM0
Type	RO	RO	RO	RO	RO	RO	RO	RO	RO	RO	RO	RO	R/W	R/W	R/W	R/W
Reset	0	0	0	0	0	0	0	0	0	0	0	0	0	0	0	0

Bit/Field	Name	Type	Reset	Description
31:20	reserved	RO	0x000	Software should not rely on the value of a reserved bit. To provide compatibility with future products, the value of a reserved bit should be preserved across a read-modify-write operation.
19	INTFAULT3	R/W	0	Interrupt Fault 3  Value Description 1 An interrupt is sent to the interrupt controller when the fault condition for PWM generator 3 is asserted. 0 The fault condition for PWM generator 3 is suppressed and not sent to the interrupt controller.
18	INTFAULT2	R/W	0	Interrupt Fault 2  Value Description 1 An interrupt is sent to the interrupt controller when the fault condition for PWM generator 2 is asserted. 0 The fault condition for PWM generator 2 is suppressed and not sent to the interrupt controller.
17	INTFAULT1	R/W	0	Interrupt Fault 1  Value Description 1 An interrupt is sent to the interrupt controller when the fault condition for PWM generator 1 is asserted. 0 The fault condition for PWM generator 1 is suppressed and not sent to the interrupt controller.

Bit/Field	Name	Type	Reset	Description
16	INTFAULT0	R/W	0	<p>Interrupt Fault 0</p> <p>Value Description</p> <p>1 An interrupt is sent to the interrupt controller when the fault condition for PWM generator 0 is asserted.</p> <p>0 The fault condition for PWM generator 0 is suppressed and not sent to the interrupt controller.</p>
15:4	reserved	RO	0x000	Software should not rely on the value of a reserved bit. To provide compatibility with future products, the value of a reserved bit should be preserved across a read-modify-write operation.
3	INTPWM3	R/W	0	<p>PWM3 Interrupt Enable</p> <p>Value Description</p> <p>1 An interrupt is sent to the interrupt controller when the PWM generator 3 block asserts an interrupt.</p> <p>0 The PWM generator 3 interrupt is suppressed and not sent to the interrupt controller.</p>
2	INTPWM2	R/W	0	<p>PWM2 Interrupt Enable</p> <p>Value Description</p> <p>1 An interrupt is sent to the interrupt controller when the PWM generator 2 block asserts an interrupt.</p> <p>0 The PWM generator 2 interrupt is suppressed and not sent to the interrupt controller.</p>
1	INTPWM1	R/W	0	<p>PWM1 Interrupt Enable</p> <p>Value Description</p> <p>1 An interrupt is sent to the interrupt controller when the PWM generator 1 block asserts an interrupt.</p> <p>0 The PWM generator 1 interrupt is suppressed and not sent to the interrupt controller.</p>
0	INTPWM0	R/W	0	<p>PWM0 Interrupt Enable</p> <p>Value Description</p> <p>1 An interrupt is sent to the interrupt controller when the PWM generator 0 block asserts an interrupt.</p> <p>0 The PWM generator 0 interrupt is suppressed and not sent to the interrupt controller.</p>

## Register 7: PWM Raw Interrupt Status (PWMRIS), offset 0x018

This register provides the current set of interrupt sources that are asserted, regardless of whether they are enabled to cause an interrupt to be asserted to the interrupt controller. The fault interrupt is asserted based on the fault condition source that is specified by the **PWMnCTL**, **PWMnFLTSRC0** and **PWMnFLTSRC1** registers. The fault interrupt is latched on detection and must be cleared through the **PWM Interrupt Status and Clear (PWMISC)** register. The actual value of the **FAULTn** signals can be observed using the **PWMSTATUS** register.

The PWM generator interrupts simply reflect the status of the PWM generators and are cleared via the interrupt status register in the PWM generator blocks. If a bit is set, the event is active; if a bit is clear the event is not active.

### PWM Raw Interrupt Status (PWMRIS)

Base 0x4002.8000  
Offset 0x018  
Type RO, reset 0x0000.0000

	31	30	29	28	27	26	25	24	23	22	21	20	19	18	17	16
	reserved												INTFAULT3	INTFAULT2	INTFAULT1	INTFAULT0
Type	RO	RO	RO	RO	RO	RO	RO	RO	RO	RO	RO	RO	RO	RO	RO	RO
Reset	0	0	0	0	0	0	0	0	0	0	0	0	0	0	0	0
	15	14	13	12	11	10	9	8	7	6	5	4	3	2	1	0
	reserved												INTPWM3	INTPWM2	INTPWM1	INTPWM0
Type	RO	RO	RO	RO	RO	RO	RO	RO	RO	RO	RO	RO	RO	RO	RO	RO
Reset	0	0	0	0	0	0	0	0	0	0	0	0	0	0	0	0

Bit/Field	Name	Type	Reset	Description
31:20	reserved	RO	0x000	Software should not rely on the value of a reserved bit. To provide compatibility with future products, the value of a reserved bit should be preserved across a read-modify-write operation.
19	INTFAULT3	RO	0	<p>Interrupt Fault PWM 3</p> <p>Value Description</p> <p>1 The fault condition for PWM generator 3 is asserted.</p> <p>0 The fault condition for PWM generator 3 has not been asserted.</p> <p>This bit is cleared by writing a 1 to the INTFAULT3 bit in the <b>PWMISC</b> register.</p>
18	INTFAULT2	RO	0	<p>Interrupt Fault PWM 2</p> <p>Value Description</p> <p>1 The fault condition for PWM generator 2 is asserted.</p> <p>0 The fault condition for PWM generator 2 has not been asserted.</p> <p>This bit is cleared by writing a 1 to the INTFAULT2 bit in the <b>PWMISC</b> register.</p>

Bit/Field	Name	Type	Reset	Description
17	INTFAULT1	RO	0	<p>Interrupt Fault PWM 1</p> <p>Value Description</p> <p>1 The fault condition for PWM generator 1 is asserted.</p> <p>0 The fault condition for PWM generator 1 has not been asserted.</p> <p>This bit is cleared by writing a 1 to the INTFAULT1 bit in the <b>PWMISC</b> register.</p>
16	INTFAULT0	RO	0	<p>Interrupt Fault PWM 0</p> <p>Value Description</p> <p>1 The fault condition for PWM generator 0 is asserted.</p> <p>0 The fault condition for PWM generator 0 has not been asserted.</p> <p>This bit is cleared by writing a 1 to the INTFAULT0 bit in the <b>PWMISC</b> register.</p>
15:4	reserved	RO	0x000	Software should not rely on the value of a reserved bit. To provide compatibility with future products, the value of a reserved bit should be preserved across a read-modify-write operation.
3	INTPWM3	RO	0	<p>PWM3 Interrupt Asserted</p> <p>Value Description</p> <p>1 The PWM generator 3 block interrupt is asserted.</p> <p>0 The PWM generator 3 block interrupt has not been asserted.</p> <p>The <b>PWM3RIS</b> register shows the source of this interrupt. This bit is cleared by writing a 1 to the corresponding bit in the <b>PWM3ISC</b> register.</p>
2	INTPWM2	RO	0	<p>PWM2 Interrupt Asserted</p> <p>Value Description</p> <p>1 The PWM generator 2 block interrupt is asserted.</p> <p>0 The PWM generator 2 block interrupt has not been asserted.</p> <p>The <b>PWM2RIS</b> register shows the source of this interrupt. This bit is cleared by writing a 1 to the corresponding bit in the <b>PWM2ISC</b> register.</p>
1	INTPWM1	RO	0	<p>PWM1 Interrupt Asserted</p> <p>Value Description</p> <p>1 The PWM generator 1 block interrupt is asserted.</p> <p>0 The PWM generator 1 block interrupt has not been asserted.</p> <p>The <b>PWM1RIS</b> register shows the source of this interrupt. This bit is cleared by writing a 1 to the corresponding bit in the <b>PWM1ISC</b> register.</p>

---

Bit/Field	Name	Type	Reset	Description
0	INTPWM0	RO	0	PWM0 Interrupt Asserted

Value Description

1 The PWM generator 0 block interrupt is asserted.

0 The PWM generator 0 block interrupt has not been asserted.

The **PWM0RIS** register shows the source of this interrupt. This bit is cleared by writing a 1 to the corresponding bit in the **PWM0ISC** register.

### Register 8: PWM Interrupt Status and Clear (PWMISC), offset 0x01C

This register provides a summary of the interrupt status of the individual PWM generator blocks. If a fault interrupt is set, the corresponding `FAULTn` input has caused an interrupt. For the fault interrupt, a write of 1 to that bit position clears the latched interrupt status. If an block interrupt bit is set, the corresponding generator block is asserting an interrupt. The individual interrupt status registers, **PWMnISC**, in each block must be consulted to determine the reason for the interrupt and used to clear the interrupt.

#### PWM Interrupt Status and Clear (PWMISC)

Base 0x4002.8000  
 Offset 0x01C  
 Type R/W1C, reset 0x0000.0000

	31	30	29	28	27	26	25	24	23	22	21	20	19	18	17	16
	reserved												INTFAULT3	INTFAULT2	INTFAULT1	INTFAULT0
Type	RO	RO	RO	RO	RO	RO	RO	RO	RO	RO	RO	RO	R/W1C	R/W1C	R/W1C	R/W1C
Reset	0	0	0	0	0	0	0	0	0	0	0	0	0	0	0	0
	15	14	13	12	11	10	9	8	7	6	5	4	3	2	1	0
	reserved												INTPWM3	INTPWM2	INTPWM1	INTPWM0
Type	RO	RO	RO	RO	RO	RO	RO	RO	RO	RO	RO	RO	RO	RO	RO	RO
Reset	0	0	0	0	0	0	0	0	0	0	0	0	0	0	0	0

Bit/Field	Name	Type	Reset	Description
31:20	reserved	RO	0x000	Software should not rely on the value of a reserved bit. To provide compatibility with future products, the value of a reserved bit should be preserved across a read-modify-write operation.
19	INTFAULT3	R/W1C	0	<p><b>FAULT3</b> Interrupt Asserted</p> <p>Value Description</p> <p>1 An enabled interrupt for the fault condition for PWM generator 3 is asserted or is latched.</p> <p>0 The fault condition for PWM generator 3 has not been asserted or is not enabled.</p> <p>Writing a 1 to this bit clears it and the <code>INTFAULT3</code> bit in the <b>PWMRIS</b> register.</p>
18	INTFAULT2	R/W1C	0	<p><b>FAULT2</b> Interrupt Asserted</p> <p>Value Description</p> <p>1 An enabled interrupt for the fault condition for PWM generator 2 is asserted or is latched.</p> <p>0 The fault condition for PWM generator 2 has not been asserted or is not enabled.</p> <p>Writing a 1 to this bit clears it and the <code>INTFAULT2</code> bit in the <b>PWMRIS</b> register.</p>



Bit/Field	Name	Type	Reset	Description
17	INTFAULT1	R/W1C	0	<p><b>FAULT1</b> Interrupt Asserted</p> <p>Value Description</p> <p>1 An enabled interrupt for the fault condition for PWM generator 1 is asserted or is latched.</p> <p>0 The fault condition for PWM generator 1 has not been asserted or is not enabled.</p> <p>Writing a 1 to this bit clears it and the <b>INTFAULT1</b> bit in the <b>PWMRIS</b> register.</p>
16	INTFAULT0	R/W1C	0	<p><b>FAULT0</b> Interrupt Asserted</p> <p>Value Description</p> <p>1 An enabled interrupt for the fault condition for PWM generator 0 is asserted or is latched.</p> <p>0 The fault condition for PWM generator 0 has not been asserted or is not enabled.</p> <p>Writing a 1 to this bit clears it and the <b>INTFAULT0</b> bit in the <b>PWMRIS</b> register.</p>
15:4	reserved	RO	0x000	Software should not rely on the value of a reserved bit. To provide compatibility with future products, the value of a reserved bit should be preserved across a read-modify-write operation.
3	INTPWM3	RO	0	<p><b>PWM3</b> Interrupt Status</p> <p>Value Description</p> <p>1 An enabled interrupt for the PWM generator 3 block is asserted.</p> <p>0 The PWM generator 3 block interrupt is not asserted or is not enabled.</p> <p>The <b>PWM3RIS</b> register shows the source of this interrupt. This bit is cleared by writing a 1 to the corresponding bit in the <b>PWM3ISC</b> register.</p>
2	INTPWM2	RO	0	<p><b>PWM2</b> Interrupt Status</p> <p>Value Description</p> <p>1 An enabled interrupt for the PWM generator 2 block is asserted.</p> <p>0 The PWM generator 2 block interrupt is not asserted or is not enabled.</p> <p>The <b>PWM2RIS</b> register shows the source of this interrupt. This bit is cleared by writing a 1 to the corresponding bit in the <b>PWM2ISC</b> register.</p>
1	INTPWM1	RO	0	<p><b>PWM1</b> Interrupt Status</p> <p>Value Description</p> <p>1 An enabled interrupt for the PWM generator 1 block is asserted.</p> <p>0 The PWM generator 1 block interrupt is not asserted or is not enabled.</p> <p>The <b>PWM1RIS</b> register shows the source of this interrupt. This bit is cleared by writing a 1 to the corresponding bit in the <b>PWM1ISC</b> register.</p>

Bit/Field	Name	Type	Reset	Description
0	INTPWM0	RO	0	PWM0 Interrupt Status

Value Description

- 1 An enabled interrupt for the PWM generator 0 block is asserted.
- 0 The PWM generator 0 block interrupt is not asserted or is not enabled.

The **PWM0RIS** register shows the source of this interrupt. This bit is cleared by writing a 1 to the corresponding bit in the **PWM0ISC** register.

**Register 9: PWM Status (PWMSTATUS), offset 0x020**

This register provides the unlatched status of the PWM generator fault condition.

**PWM Status (PWMSTATUS)**

Base 0x4002.8000

Offset 0x020

Type RO, reset 0x0000.0000

	31	30	29	28	27	26	25	24	23	22	21	20	19	18	17	16
	reserved															
Type	RO	RO	RO	RO	RO	RO	RO	RO	RO	RO	RO	RO	RO	RO	RO	RO
Reset	0	0	0	0	0	0	0	0	0	0	0	0	0	0	0	0
	15	14	13	12	11	10	9	8	7	6	5	4	3	2	1	0
	reserved												FAULT3	FAULT2	FAULT1	FAULT0
Type	RO	RO	RO	RO	RO	RO	RO	RO	RO	RO	RO	RO	RO	RO	RO	RO
Reset	0	0	0	0	0	0	0	0	0	0	0	0	0	0	0	0

Bit/Field	Name	Type	Reset	Description
31:4	reserved	RO	0x0000.000	Software should not rely on the value of a reserved bit. To provide compatibility with future products, the value of a reserved bit should be preserved across a read-modify-write operation.
3	FAULT3	RO	0	Generator 3 Fault Status  Value Description 1 The fault condition for PWM generator 3 is asserted.  If the <b>FLTSRC</b> bit in the <b>PWM3CTL</b> register is clear, the <b>FAULT0</b> input is the source of the fault condition, and is therefore asserted. 0 The fault condition for PWM generator 3 is not asserted.
2	FAULT2	RO	0	Generator 2 Fault Status  Value Description 1 The fault condition for PWM generator 2 is asserted.  If the <b>FLTSRC</b> bit in the <b>PWM2CTL</b> register is clear, the <b>FAULT0</b> input is the source of the fault condition, and is therefore asserted. 0 The fault condition for PWM generator 2 is not asserted.
1	FAULT1	RO	0	Generator 1 Fault Status  Value Description 1 The fault condition for PWM generator 1 is asserted.  If the <b>FLTSRC</b> bit in the <b>PWM1CTL</b> register is clear, the <b>FAULT0</b> input is the source of the fault condition, and is therefore asserted. 0 The fault condition for PWM generator 1 is not asserted.

Bit/Field	Name	Type	Reset	Description
0	FAULT0	RO	0	Generator 0 Fault Status
				Value Description
				1 The fault condition for PWM generator 0 is asserted. If the <b>FLTSRC</b> bit in the <b>PWM0CTL</b> register is clear, the <b>FAULT0</b> input is the source of the fault condition, and is therefore asserted.
				0 The fault condition for PWM generator 0 is not asserted.

**Register 10: PWM Fault Condition Value (PWMFAULTVAL), offset 0x024**

This register specifies the output value driven on the  $PWM_n$  signals during a fault condition if enabled by the corresponding bit in the **PWMFAULT** register. Note that if the corresponding bit in the **PWMINVERT** register is set, the output value is driven to the logical NOT of the bit value in this register.

**PWM Fault Condition Value (PWMFAULTVAL)**

Base 0x4002.8000  
Offset 0x024  
Type R/W, reset 0x0000.0000

	31	30	29	28	27	26	25	24	23	22	21	20	19	18	17	16
	reserved															
Type	RO	RO	RO	RO	RO	RO	RO	RO	RO	RO	RO	RO	RO	RO	RO	RO
Reset	0	0	0	0	0	0	0	0	0	0	0	0	0	0	0	0
	15	14	13	12	11	10	9	8	7	6	5	4	3	2	1	0
	reserved								PWM7	PWM6	PWM5	PWM4	PWM3	PWM2	PWM1	PWM0
Type	RO	RO	RO	RO	RO	RO	RO	RO	R/W	R/W	R/W	R/W	R/W	R/W	R/W	R/W
Reset	0	0	0	0	0	0	0	0	0	0	0	0	0	0	0	0

Bit/Field	Name	Type	Reset	Description
31:8	reserved	RO	0x0000.00	Software should not rely on the value of a reserved bit. To provide compatibility with future products, the value of a reserved bit should be preserved across a read-modify-write operation.
7	PWM7	R/W	0	PWM7 Fault Value  Value Description 1 The PWM7 output signal is driven High during fault conditions if the FAULT7 bit in the <b>PWMFAULT</b> register is set. 0 The PWM7 output signal is driven Low during fault conditions if the FAULT7 bit in the <b>PWMFAULT</b> register is set.
6	PWM6	R/W	0	PWM6 Fault Value  Value Description 1 The PWM6 output signal is driven High during fault conditions if the FAULT6 bit in the <b>PWMFAULT</b> register is set. 0 The PWM6 output signal is driven Low during fault conditions if the FAULT6 bit in the <b>PWMFAULT</b> register is set.
5	PWM5	R/W	0	PWM5 Fault Value  Value Description 1 The PWM5 output signal is driven High during fault conditions if the FAULT5 bit in the <b>PWMFAULT</b> register is set. 0 The PWM5 output signal is driven Low during fault conditions if the FAULT5 bit in the <b>PWMFAULT</b> register is set.

Bit/Field	Name	Type	Reset	Description
4	PWM4	R/W	0	<p>PWM4 Fault Value</p> <p>Value Description</p> <p>1 The PWM4 output signal is driven High during fault conditions if the FAULT4 bit in the <b>PWMFAULT</b> register is set.</p> <p>0 The PWM4 output signal is driven Low during fault conditions if the FAULT4 bit in the <b>PWMFAULT</b> register is set.</p>
3	PWM3	R/W	0	<p>PWM3 Fault Value</p> <p>Value Description</p> <p>1 The PWM3 output signal is driven High during fault conditions if the FAULT3 bit in the <b>PWMFAULT</b> register is set.</p> <p>0 The PWM3 output signal is driven Low during fault conditions if the FAULT3 bit in the <b>PWMFAULT</b> register is set.</p>
2	PWM2	R/W	0	<p>PWM2 Fault Value</p> <p>Value Description</p> <p>1 The PWM2 output signal is driven High during fault conditions if the FAULT2 bit in the <b>PWMFAULT</b> register is set.</p> <p>0 The PWM2 output signal is driven Low during fault conditions if the FAULT2 bit in the <b>PWMFAULT</b> register is set.</p>
1	PWM1	R/W	0	<p>PWM1 Fault Value</p> <p>Value Description</p> <p>1 The PWM1 output signal is driven High during fault conditions if the FAULT1 bit in the <b>PWMFAULT</b> register is set.</p> <p>0 The PWM1 output signal is driven Low during fault conditions if the FAULT1 bit in the <b>PWMFAULT</b> register is set.</p>
0	PWM0	R/W	0	<p>PWM0 Fault Value</p> <p>Value Description</p> <p>1 The PWM0 output signal is driven High during fault conditions if the FAULT0 bit in the <b>PWMFAULT</b> register is set.</p> <p>0 The PWM0 output signal is driven Low during fault conditions if the FAULT0 bit in the <b>PWMFAULT</b> register is set.</p>

**Register 11: PWM Enable Update (PWMENUPD), offset 0x028**

This register specifies when updates to the  $PWM_nEn$  bit in the **PWMENABLE** register are performed. The  $PWM_nEn$  bit enables the pwmA' or pwmB' output to be passed to the microcontroller's pin. Updates can be immediate or locally or globally synchronized to the next synchronous update.

**PWM Enable Update (PWMENUPD)**

Base 0x4002.8000  
Offset 0x028  
Type R/W, reset 0x0000.0000

	31	30	29	28	27	26	25	24	23	22	21	20	19	18	17	16
	reserved															
Type	RO	RO	RO	RO	RO	RO	RO	RO	RO	RO	RO	RO	RO	RO	RO	RO
Reset	0	0	0	0	0	0	0	0	0	0	0	0	0	0	0	0
	15	14	13	12	11	10	9	8	7	6	5	4	3	2	1	0
	ENUPD7		ENUPD6		ENUPD5		ENUPD4		ENUPD3		ENUPD2		ENUPD1		ENUPD0	
Type	R/W	R/W	R/W	R/W	R/W	R/W	R/W	R/W	R/W	R/W	R/W	R/W	R/W	R/W	R/W	R/W
Reset	0	0	0	0	0	0	0	0	0	0	0	0	0	0	0	0

Bit/Field	Name	Type	Reset	Description
31:16	reserved	RO	0x00	Software should not rely on the value of a reserved bit. To provide compatibility with future products, the value of a reserved bit should be preserved across a read-modify-write operation.
15:14	ENUPD7	R/W	0	PWM7 Enable Update Mode
				Value Description
			0x0	Immediate
				Writes to the $PWM7En$ bit in the <b>PWMENABLE</b> register are used by the PWM generator module immediately.
			0x1	Reserved
			0x2	Locally Synchronized
				Writes to the $PWM7En$ bit in the <b>PWMENABLE</b> register are used by the PWM generator module the next time the counter is 0.
			0x3	Globally Synchronized
				Writes to the $PWM7En$ bit in the <b>PWMENABLE</b> register are used by the PWM generator module the next time the counter is 0 after a synchronous update has been requested through the PWM Master Control ( <b>PWMCTL</b> ) register.

Bit/Field	Name	Type	Reset	Description
13:12	ENUPD6	R/W	0	<p>PWM6 Enable Update Mode</p> <p>Value Description</p> <p>0x0 Immediate</p> <p>Writes to the <code>PWM6En</code> bit in the <b>PWMENABLE</b> register are used by the PWM generator module immediately.</p> <p>0x1 Reserved</p> <p>0x2 Locally Synchronized</p> <p>Writes to the <code>PWM6En</code> bit in the <b>PWMENABLE</b> register are used by the PWM generator module the next time the counter is 0.</p> <p>0x3 Globally Synchronized</p> <p>Writes to the <code>PWM6En</code> bit in the <b>PWMENABLE</b> register are used by the PWM generator module the next time the counter is 0 after a synchronous update has been requested through the PWM Master Control (<b>PWMCTL</b>) register.</p>
11:10	ENUPD5	R/W	0	<p>PWM5 Enable Update Mode</p> <p>Value Description</p> <p>0x0 Immediate</p> <p>Writes to the <code>PWM5En</code> bit in the <b>PWMENABLE</b> register are used by the PWM generator module immediately.</p> <p>0x1 Reserved</p> <p>0x2 Locally Synchronized</p> <p>Writes to the <code>PWM5En</code> bit in the <b>PWMENABLE</b> register are used by the PWM generator module the next time the counter is 0.</p> <p>0x3 Globally Synchronized</p> <p>Writes to the <code>PWM5En</code> bit in the <b>PWMENABLE</b> register are used by the PWM generator module the next time the counter is 0 after a synchronous update has been requested through the PWM Master Control (<b>PWMCTL</b>) register.</p>
9:8	ENUPD4	R/W	0	<p>PWM4 Enable Update Mode</p> <p>Value Description</p> <p>0x0 Immediate</p> <p>Writes to the <code>PWM4En</code> bit in the <b>PWMENABLE</b> register are used by the PWM generator module immediately.</p> <p>0x1 Reserved</p> <p>0x2 Locally Synchronized</p> <p>Writes to the <code>PWM4En</code> bit in the <b>PWMENABLE</b> register are used by the PWM generator module the next time the counter is 0.</p> <p>0x3 Globally Synchronized</p> <p>Writes to the <code>PWM4En</code> bit in the <b>PWMENABLE</b> register are used by the PWM generator module the next time the counter is 0 after a synchronous update has been requested through the PWM Master Control (<b>PWMCTL</b>) register.</p>



Bit/Field	Name	Type	Reset	Description
7:6	ENUPD3	R/W	0	<p>PWM3 Enable Update Mode</p> <p>Value Description</p> <p>0x0 Immediate</p> <p>Writes to the <code>PWM3En</code> bit in the <b>PWMENABLE</b> register are used by the PWM generator module immediately.</p> <p>0x1 Reserved</p> <p>0x2 Locally Synchronized</p> <p>Writes to the <code>PWM3En</code> bit in the <b>PWMENABLE</b> register are used by the PWM generator module the next time the counter is 0.</p> <p>0x3 Globally Synchronized</p> <p>Writes to the <code>PWM3En</code> bit in the <b>PWMENABLE</b> register are used by the PWM generator module the next time the counter is 0 after a synchronous update has been requested through the PWM Master Control (<b>PWMCTL</b>) register.</p>
5:4	ENUPD2	R/W	0	<p>PWM2 Enable Update Mode</p> <p>Value Description</p> <p>0x0 Immediate</p> <p>Writes to the <code>PWM2En</code> bit in the <b>PWMENABLE</b> register are used by the PWM generator module immediately.</p> <p>0x1 Reserved</p> <p>0x2 Locally Synchronized</p> <p>Writes to the <code>PWM2En</code> bit in the <b>PWMENABLE</b> register are used by the PWM generator module the next time the counter is 0.</p> <p>0x3 Globally Synchronized</p> <p>Writes to the <code>PWM2En</code> bit in the <b>PWMENABLE</b> register are used by the PWM generator module the next time the counter is 0 after a synchronous update has been requested through the PWM Master Control (<b>PWMCTL</b>) register.</p>
3:2	ENUPD1	R/W	0	<p>PWM1 Enable Update Mode</p> <p>Value Description</p> <p>0x0 Immediate</p> <p>Writes to the <code>PWM1En</code> bit in the <b>PWMENABLE</b> register are used by the PWM generator module immediately.</p> <p>0x1 Reserved</p> <p>0x2 Locally Synchronized</p> <p>Writes to the <code>PWM1En</code> bit in the <b>PWMENABLE</b> register are used by the PWM generator module the next time the counter is 0.</p> <p>0x3 Globally Synchronized</p> <p>Writes to the <code>PWM1En</code> bit in the <b>PWMENABLE</b> register are used by the PWM generator module the next time the counter is 0 after a synchronous update has been requested through the PWM Master Control (<b>PWMCTL</b>) register.</p>

Bit/Field	Name	Type	Reset	Description
1:0	ENUPD0	R/W	0	PWM0 Enable Update Mode
				Value Description
				0x0 Immediate
				Writes to the <code>PWM0En</code> bit in the <b>PWMENABLE</b> register are used by the PWM generator module immediately.
				0x1 Reserved
				0x2 Locally Synchronized
				Writes to the <code>PWM0En</code> bit in the <b>PWMENABLE</b> register are used by the PWM generator module the next time the counter is 0.
				0x3 Globally Synchronized
				Writes to the <code>PWM0En</code> bit in the <b>PWMENABLE</b> register are used by the PWM generator module the next time the counter is 0 after a synchronous update has been requested through the PWM Master Control ( <b>PWMCTL</b> ) register.

**Register 12: PWM0 Control (PWM0CTL), offset 0x040****Register 13: PWM1 Control (PWM1CTL), offset 0x080****Register 14: PWM2 Control (PWM2CTL), offset 0x0C0****Register 15: PWM3 Control (PWM3CTL), offset 0x100**

These registers configure the PWM signal generation blocks (PWM0CTL controls the PWM generator 0 block, and so on). The Register Update mode, Debug mode, Counting mode, and Block Enable mode are all controlled via these registers. The blocks produce the PWM signals, which can be either two independent PWM signals (from the same counter), or a paired set of PWM signals with dead-band delays added.

The PWM0 block produces the  $PWM0$  and  $PWM1$  outputs, the PWM1 block produces the  $PWM2$  and  $PWM3$  outputs, the PWM2 block produces the  $PWM4$  and  $PWM5$  outputs, and the PWM3 block produces the  $PWM6$  and  $PWM7$  outputs.

## PWM0 Control (PWM0CTL)

Base 0x4002.8000  
Offset 0x040  
Type R/W, reset 0x0000.0000

	31	30	29	28	27	26	25	24	23	22	21	20	19	18	17	16
	reserved													LATCH	MINFLTPER	FLTSRC
Type	RO	RO	RO	RO	RO	RO	RO	RO	RO	RO	RO	RO	RO	R/W	R/W	R/W
Reset	0	0	0	0	0	0	0	0	0	0	0	0	0	0	0	0
	15	14	13	12	11	10	9	8	7	6	5	4	3	2	1	0
	DBFALLUPD		DBRISEUPD		DBCTLUPD		GENBUPD		GENAUPD		CMPBUPD	CMPAUPD	LOADUPD	DEBUG	MODE	ENABLE
Type	R/W	R/W	R/W	R/W	R/W	R/W	R/W	R/W	R/W	R/W	R/W	R/W	R/W	R/W	R/W	R/W
Reset	0	0	0	0	0	0	0	0	0	0	0	0	0	0	0	0

Bit/Field	Name	Type	Reset	Description
31:19	reserved	RO	0x000	Software should not rely on the value of a reserved bit. To provide compatibility with future products, the value of a reserved bit should be preserved across a read-modify-write operation.
18	LATCH	R/W	0	Latch Fault Input
				Value Description
			0	Fault Condition Not Latched
				A fault condition is in effect for as long as the generating source is asserting.
			1	Fault Condition Latched
				A fault condition is set as the result of the assertion of the faulting source and is held (latched) while the <b>PWMISC</b> $INTFAULTn$ bit is set. Clearing the $INTFAULTn$ bit clears the fault condition.

Bit/Field	Name	Type	Reset	Description
17	MINFLTPER	R/W	0	<p>Minimum Fault Period</p> <p>This bit specifies that the PWM generator enables a one-shot counter to provide a minimum fault condition period.</p> <p>The timer begins counting on the rising edge of the fault condition to extend the condition for a minimum duration of the count value. The timer ignores the state of the fault condition while counting.</p> <p>The minimum fault delay is in effect only when the MINFLTPER bit is set. If a detected fault is in the process of being extended when the MINFLTPER bit is cleared, the fault condition extension is aborted.</p> <p>The delay time is specified by the <b>PWMnMINFLTPER</b> register MFP field value. The effect of this is to pulse stretch the fault condition input.</p> <p>The delay value is defined by the PWM clock period. Because the fault input is not synchronized to the PWM clock, the period of the time is <math>PWMClock * (MFP \text{ value} + 1)</math> or <math>PWMClock * (MFP \text{ value} + 2)</math>.</p> <p>The delay function makes sense only if the fault source is unlatched. A latched fault source makes the fault condition appear asserted until cleared by software and negates the utility of the extend feature. It applies to all fault condition sources as specified in the FLTSRC field.</p> <p>Value Description</p> <p>0 The FAULT input deassertion is unaffected.</p> <p>1 The <b>PWMnMINFLTPER</b> one-shot counter is active and extends the period of the fault condition to a minimum period.</p>
16	FLTSRC	R/W	0	<p>Fault Condition Source</p> <p>Value Description</p> <p>0 The Fault condition is determined by the Fault0 input.</p> <p>1 The Fault condition is determined by the configuration of the <b>PWMnFLTSRC0</b> and <b>PWMnFLTSRC1</b> registers.</p>
15:14	DBFALLUPD	R/W	0x0	<p><b>PWMnDBFALL</b> Update Mode</p> <p>Value Description</p> <p>0x0 Immediate</p> <p>The <b>PWMnDBFALL</b> register value is immediately updated on a write.</p> <p>0x1 Reserved</p> <p>0x2 Locally Synchronized</p> <p>Updates to the register are reflected to the generator the next time the counter is 0.</p> <p>0x3 Globally Synchronized</p> <p>Updates to the register are delayed until the next time the counter is 0 after a synchronous update has been requested through the <b>PWMCTL</b> register.</p>

Bit/Field	Name	Type	Reset	Description
13:12	DBRISEUPD	R/W	0x0	<p><b>PWMnDBRISE</b> Update Mode</p> <p>Value Description</p> <p>0x0 Immediate</p> <p>The <b>PWMnDBRISE</b> register value is immediately updated on a write.</p> <p>0x1 Reserved</p> <p>0x2 Locally Synchronized</p> <p>Updates to the register are reflected to the generator the next time the counter is 0.</p> <p>0x3 Globally Synchronized</p> <p>Updates to the register are delayed until the next time the counter is 0 after a synchronous update has been requested through the <b>PWMCTL</b> register.</p>
11:10	DBCTLUPD	R/W	0x0	<p><b>PWMnDBCTL</b> Update Mode</p> <p>Value Description</p> <p>0x0 Immediate</p> <p>The <b>PWMnDBCTL</b> register value is immediately updated on a write.</p> <p>0x1 Reserved</p> <p>0x2 Locally Synchronized</p> <p>Updates to the register are reflected to the generator the next time the counter is 0.</p> <p>0x3 Globally Synchronized</p> <p>Updates to the register are delayed until the next time the counter is 0 after a synchronous update has been requested through the <b>PWMCTL</b> register.</p>
9:8	GENBUPD	R/W	0x0	<p><b>PWMnGENB</b> Update Mode</p> <p>Value Description</p> <p>0x0 Immediate</p> <p>The <b>PWMnGENB</b> register value is immediately updated on a write.</p> <p>0x1 Reserved</p> <p>0x2 Locally Synchronized</p> <p>Updates to the register are reflected to the generator the next time the counter is 0.</p> <p>0x3 Globally Synchronized</p> <p>Updates to the register are delayed until the next time the counter is 0 after a synchronous update has been requested through the <b>PWMCTL</b> register.</p>

Bit/Field	Name	Type	Reset	Description																
7:6	GENAUPD	R/W	0x0	<p><b>PWMnGENA</b> Update Mode</p> <table border="1"> <thead> <tr> <th>Value</th> <th>Description</th> </tr> </thead> <tbody> <tr> <td>0x0</td> <td>Immediate</td> </tr> <tr> <td></td> <td>The <b>PWMnGENA</b> register value is immediately updated on a write.</td> </tr> <tr> <td>0x1</td> <td>Reserved</td> </tr> <tr> <td>0x2</td> <td>Locally Synchronized</td> </tr> <tr> <td></td> <td>Updates to the register are reflected to the generator the next time the counter is 0.</td> </tr> <tr> <td>0x3</td> <td>Globally Synchronized</td> </tr> <tr> <td></td> <td>Updates to the register are delayed until the next time the counter is 0 after a synchronous update has been requested through the <b>PWMCTL</b> register.</td> </tr> </tbody> </table>	Value	Description	0x0	Immediate		The <b>PWMnGENA</b> register value is immediately updated on a write.	0x1	Reserved	0x2	Locally Synchronized		Updates to the register are reflected to the generator the next time the counter is 0.	0x3	Globally Synchronized		Updates to the register are delayed until the next time the counter is 0 after a synchronous update has been requested through the <b>PWMCTL</b> register.
Value	Description																			
0x0	Immediate																			
	The <b>PWMnGENA</b> register value is immediately updated on a write.																			
0x1	Reserved																			
0x2	Locally Synchronized																			
	Updates to the register are reflected to the generator the next time the counter is 0.																			
0x3	Globally Synchronized																			
	Updates to the register are delayed until the next time the counter is 0 after a synchronous update has been requested through the <b>PWMCTL</b> register.																			
5	CMPBUPD	R/W	0	<p>Comparator B Update Mode</p> <table border="1"> <thead> <tr> <th>Value</th> <th>Description</th> </tr> </thead> <tbody> <tr> <td>0</td> <td>Locally Synchronized</td> </tr> <tr> <td></td> <td>Updates to the <b>PWMnCMPB</b> register are reflected to the generator the next time the counter is 0.</td> </tr> <tr> <td>1</td> <td>Globally Synchronized</td> </tr> <tr> <td></td> <td>Updates to the register are delayed until the next time the counter is 0 after a synchronous update has been requested through the <b>PWMCTL</b> register.</td> </tr> </tbody> </table>	Value	Description	0	Locally Synchronized		Updates to the <b>PWMnCMPB</b> register are reflected to the generator the next time the counter is 0.	1	Globally Synchronized		Updates to the register are delayed until the next time the counter is 0 after a synchronous update has been requested through the <b>PWMCTL</b> register.						
Value	Description																			
0	Locally Synchronized																			
	Updates to the <b>PWMnCMPB</b> register are reflected to the generator the next time the counter is 0.																			
1	Globally Synchronized																			
	Updates to the register are delayed until the next time the counter is 0 after a synchronous update has been requested through the <b>PWMCTL</b> register.																			
4	CMPAUPD	R/W	0	<p>Comparator A Update Mode</p> <table border="1"> <thead> <tr> <th>Value</th> <th>Description</th> </tr> </thead> <tbody> <tr> <td>0</td> <td>Locally Synchronized</td> </tr> <tr> <td></td> <td>Updates to the <b>PWMnCMPA</b> register are reflected to the generator the next time the counter is 0.</td> </tr> <tr> <td>1</td> <td>Globally Synchronized</td> </tr> <tr> <td></td> <td>Updates to the register are delayed until the next time the counter is 0 after a synchronous update has been requested through the <b>PWMCTL</b> register.</td> </tr> </tbody> </table>	Value	Description	0	Locally Synchronized		Updates to the <b>PWMnCMPA</b> register are reflected to the generator the next time the counter is 0.	1	Globally Synchronized		Updates to the register are delayed until the next time the counter is 0 after a synchronous update has been requested through the <b>PWMCTL</b> register.						
Value	Description																			
0	Locally Synchronized																			
	Updates to the <b>PWMnCMPA</b> register are reflected to the generator the next time the counter is 0.																			
1	Globally Synchronized																			
	Updates to the register are delayed until the next time the counter is 0 after a synchronous update has been requested through the <b>PWMCTL</b> register.																			
3	LOADUPD	R/W	0	<p>Load Register Update Mode</p> <table border="1"> <thead> <tr> <th>Value</th> <th>Description</th> </tr> </thead> <tbody> <tr> <td>0</td> <td>Locally Synchronized</td> </tr> <tr> <td></td> <td>Updates to the <b>PWMnLOAD</b> register are reflected to the generator the next time the counter is 0.</td> </tr> <tr> <td>1</td> <td>Globally Synchronized</td> </tr> <tr> <td></td> <td>Updates to the register are delayed until the next time the counter is 0 after a synchronous update has been requested through the <b>PWMCTL</b> register.</td> </tr> </tbody> </table>	Value	Description	0	Locally Synchronized		Updates to the <b>PWMnLOAD</b> register are reflected to the generator the next time the counter is 0.	1	Globally Synchronized		Updates to the register are delayed until the next time the counter is 0 after a synchronous update has been requested through the <b>PWMCTL</b> register.						
Value	Description																			
0	Locally Synchronized																			
	Updates to the <b>PWMnLOAD</b> register are reflected to the generator the next time the counter is 0.																			
1	Globally Synchronized																			
	Updates to the register are delayed until the next time the counter is 0 after a synchronous update has been requested through the <b>PWMCTL</b> register.																			

Bit/Field	Name	Type	Reset	Description
2	DEBUG	R/W	0	<p>Debug Mode</p> <p>Value Description</p> <p>0 The counter stops running when it next reaches 0 and continues running again when no longer in Debug mode.</p> <p>1 The counter always runs when in Debug mode.</p>
1	MODE	R/W	0	<p>Counter Mode</p> <p>Value Description</p> <p>0 The counter counts down from the load value to 0 and then wraps back to the load value (Count-Down mode).</p> <p>1 The counter counts up from 0 to the load value, back down to 0, and then repeats (Count-Up/Down mode).</p>
0	ENABLE	R/W	0	<p>PWM Block Enable</p> <p>Value Description</p> <p>0 The entire PWM generation block is disabled and not clocked.</p> <p>1 The PWM generation block is enabled and produces PWM signals.</p>

**Register 16: PWM0 Interrupt and Trigger Enable (PWM0INTEN), offset 0x044**

**Register 17: PWM1 Interrupt and Trigger Enable (PWM1INTEN), offset 0x084**

**Register 18: PWM2 Interrupt and Trigger Enable (PWM2INTEN), offset 0x0C4**

**Register 19: PWM3 Interrupt and Trigger Enable (PWM3INTEN), offset 0x104**

These registers control the interrupt and ADC trigger generation capabilities of the PWM generators (**PWM0INTEN** controls the PWM generator 0 block, and so on). The events that can cause an interrupt or an ADC trigger are:

- The counter being equal to the load register
- The counter being equal to zero
- The counter being equal to the **PWMnCMPA** register while counting up
- The counter being equal to the **PWMnCMPA** register while counting down
- The counter being equal to the **PWMnCMPB** register while counting up
- The counter being equal to the **PWMnCMPB** register while counting down

Any combination of these events can generate either an interrupt or an ADC trigger, though no determination can be made as to the actual event that caused an ADC trigger if more than one is specified. The **PWMnRIS** register provides information about which events have caused raw interrupts.

PWM0 Interrupt and Trigger Enable (PWM0INTEN)

Base 0x4002.8000  
 Offset 0x044  
 Type R/W, reset 0x0000.0000

	31	30	29	28	27	26	25	24	23	22	21	20	19	18	17	16
	reserved															
Type	RO	RO	RO	RO	RO	RO	RO	RO	RO	RO	RO	RO	RO	RO	RO	RO
Reset	0	0	0	0	0	0	0	0	0	0	0	0	0	0	0	0
	15	14	13	12	11	10	9	8	7	6	5	4	3	2	1	0
	reserved		TRCMPBD	TRCMPBU	TRCMPAD	TRCMPAU	TRCNTLOAD	TRCNTZERO	reserved		INTCMPBD	INTCMPBU	INTCMPAD	INTCMPAU	INTCNTLOAD	INTCNTZERO
Type	RO	RO	R/W	R/W	R/W	R/W	R/W	R/W	RO	RO	R/W	R/W	R/W	R/W	R/W	R/W
Reset	0	0	0	0	0	0	0	0	0	0	0	0	0	0	0	0

Bit/Field	Name	Type	Reset	Description
31:14	reserved	RO	0x0000.0	Software should not rely on the value of a reserved bit. To provide compatibility with future products, the value of a reserved bit should be preserved across a read-modify-write operation.
13	TRCMPBD	R/W	0	Trigger for Counter= <b>PWMnCMPB</b> Down
	Value Description			
	1	An ADC trigger pulse is output when the counter matches the value in the <b>PWMnCMPB</b> register value while counting down.		
	0	No ADC trigger is output.		



Bit/Field	Name	Type	Reset	Description
12	TRCMPBU	R/W	0	Trigger for Counter= <b>PWMnCMPB</b> Up  Value Description 1 An ADC trigger pulse is output when the counter matches the value in the <b>PWMnCMPB</b> register value while counting up. 0 No ADC trigger is output.
11	TRCMPAD	R/W	0	Trigger for Counter= <b>PWMnCMPA</b> Down  Value Description 1 An ADC trigger pulse is output when the counter matches the value in the <b>PWMnCMPA</b> register value while counting down. 0 No ADC trigger is output.
10	TRCMPAU	R/W	0	Trigger for Counter= <b>PWMnCMPA</b> Up  Value Description 1 An ADC trigger pulse is output when the counter matches the value in the <b>PWMnCMPA</b> register value while counting up. 0 No ADC trigger is output.
9	TRCNTLOAD	R/W	0	Trigger for Counter= <b>PWMnLOAD</b>  Value Description 1 An ADC trigger pulse is output when the counter matches the <b>PWMnLOAD</b> register. 0 No ADC trigger is output.
8	TRCNTZERO	R/W	0	Trigger for Counter=0  Value Description 1 An ADC trigger pulse is output when the counter is 0. 0 No ADC trigger is output.
7:6	reserved	RO	0x0	Software should not rely on the value of a reserved bit. To provide compatibility with future products, the value of a reserved bit should be preserved across a read-modify-write operation.
5	INTCMPBD	R/W	0	Interrupt for Counter= <b>PWMnCMPB</b> Down  Value Description 1 A raw interrupt occurs when the counter matches the value in the <b>PWMnCMPB</b> register value while counting down. 0 No interrupt.

Bit/Field	Name	Type	Reset	Description
4	INTCMPBU	R/W	0	<p>Interrupt for Counter=<b>PWMnCMPB</b> Up</p> <p>Value Description</p> <p>1 A raw interrupt occurs when the counter matches the value in the <b>PWMnCMPB</b> register value while counting up.</p> <p>0 No interrupt.</p>
3	INTCMPAD	R/W	0	<p>Interrupt for Counter=<b>PWMnCMPA</b> Down</p> <p>Value Description</p> <p>1 A raw interrupt occurs when the counter matches the value in the <b>PWMnCMPA</b> register value while counting down.</p> <p>0 No interrupt.</p>
2	INTCMPAU	R/W	0	<p>Interrupt for Counter=<b>PWMnCMPA</b> Up</p> <p>Value Description</p> <p>1 A raw interrupt occurs when the counter matches the value in the <b>PWMnCMPA</b> register value while counting up.</p> <p>0 No interrupt.</p>
1	INTCNTLOAD	R/W	0	<p>Interrupt for Counter=<b>PWMnLOAD</b></p> <p>Value Description</p> <p>1 A raw interrupt occurs when the counter matches the value in the <b>PWMnLOAD</b> register value.</p> <p>0 No interrupt.</p>
0	INTCNTZERO	R/W	0	<p>Interrupt for Counter=0</p> <p>Value Description</p> <p>1 A raw interrupt occurs when the counter is zero.</p> <p>0 No interrupt.</p>

**Register 20: PWM0 Raw Interrupt Status (PWM0RIS), offset 0x048****Register 21: PWM1 Raw Interrupt Status (PWM1RIS), offset 0x088****Register 22: PWM2 Raw Interrupt Status (PWM2RIS), offset 0x0C8****Register 23: PWM3 Raw Interrupt Status (PWM3RIS), offset 0x108**

These registers provide the current set of interrupt sources that are asserted, regardless of whether they cause an interrupt to be asserted to the controller (**PWM0RIS** controls the PWM generator 0 block, and so on). If a bit is set, the event has occurred; if a bit is clear, the event has not occurred. Bits in this register are cleared by writing a 1 to the corresponding bit in the **PWMnISC** register.

## PWM0 Raw Interrupt Status (PWM0RIS)

Base 0x4002.8000

Offset 0x048

Type RO, reset 0x0000.0000

	31	30	29	28	27	26	25	24	23	22	21	20	19	18	17	16	
	reserved																
Type	RO	RO	RO	RO	RO	RO	RO	RO	RO	RO	RO	RO	RO	RO	RO	RO	
Reset	0	0	0	0	0	0	0	0	0	0	0	0	0	0	0	0	
	15	14	13	12	11	10	9	8	7	6	5	4	3	2	1	0	
	reserved											INTCMPBD	INTCMPBU	INTCMPAD	INTCMPAU	INTCNTLOAD	INTCNTZERO
Type	RO	RO	RO	RO	RO	RO	RO	RO	RO	RO	RO	RO	RO	RO	RO	RO	
Reset	0	0	0	0	0	0	0	0	0	0	0	0	0	0	0	0	

Bit/Field	Name	Type	Reset	Description
31:6	reserved	RO	0x0000.000	Software should not rely on the value of a reserved bit. To provide compatibility with future products, the value of a reserved bit should be preserved across a read-modify-write operation.
5	INTCMPBD	RO	0	<p>Comparator B Down Interrupt Status</p> <p>Value Description</p> <p>1 The counter has matched the value in the <b>PWMnCMPB</b> register while counting down.</p> <p>0 An interrupt has not occurred.</p> <p>This bit is cleared by writing a 1 to the <b>INTCMPBD</b> bit in the <b>PWMnISC</b> register.</p>
4	INTCMPBU	RO	0	<p>Comparator B Up Interrupt Status</p> <p>Value Description</p> <p>1 The counter has matched the value in the <b>PWMnCMPB</b> register while counting up.</p> <p>0 An interrupt has not occurred.</p> <p>This bit is cleared by writing a 1 to the <b>INTCMPBU</b> bit in the <b>PWMnISC</b> register.</p>

Bit/Field	Name	Type	Reset	Description
3	INTCMPAD	RO	0	Comparator A Down Interrupt Status  Value Description 1 The counter has matched the value in the <b>PWMnCMPA</b> register while counting down. 0 An interrupt has not occurred.  This bit is cleared by writing a 1 to the <b>INTCMPAD</b> bit in the <b>PWMnISC</b> register.
2	INTCMPAU	RO	0	Comparator A Up Interrupt Status  Value Description 1 The counter has matched the value in the <b>PWMnCMPA</b> register while counting up. 0 An interrupt has not occurred.  This bit is cleared by writing a 1 to the <b>INTCMPAU</b> bit in the <b>PWMnISC</b> register.
1	INTCNTLOAD	RO	0	Counter=Load Interrupt Status  Value Description 1 The counter has matched the value in the <b>PWMnLOAD</b> register. 0 An interrupt has not occurred.  This bit is cleared by writing a 1 to the <b>INTCNTLOAD</b> bit in the <b>PWMnISC</b> register.
0	INTCNTZERO	RO	0	Counter=0 Interrupt Status  Value Description 1 The counter has matched zero. 0 An interrupt has not occurred.  This bit is cleared by writing a 1 to the <b>INTCNTZERO</b> bit in the <b>PWMnISC</b> register.

**Register 24: PWM0 Interrupt Status and Clear (PWM0ISC), offset 0x04C****Register 25: PWM1 Interrupt Status and Clear (PWM1ISC), offset 0x08C****Register 26: PWM2 Interrupt Status and Clear (PWM2ISC), offset 0x0CC****Register 27: PWM3 Interrupt Status and Clear (PWM3ISC), offset 0x10C**

These registers provide the current set of interrupt sources that are asserted to the interrupt controller (**PWM0ISC** controls the PWM generator 0 block, and so on). A bit is set if the event has occurred and is enabled in the **PWMnINTEN** register; if a bit is clear, the event has not occurred or is not enabled. These are R/W1C registers; writing a 1 to a bit position clears the corresponding interrupt reason.

## PWM0 Interrupt Status and Clear (PWM0ISC)

Base 0x4002.8000

Offset 0x04C

Type R/W1C, reset 0x0000.0000

	31	30	29	28	27	26	25	24	23	22	21	20	19	18	17	16	
	reserved																
Type	RO	RO	RO	RO	RO	RO	RO	RO	RO	RO	RO	RO	RO	RO	RO	RO	
Reset	0	0	0	0	0	0	0	0	0	0	0	0	0	0	0	0	
	15	14	13	12	11	10	9	8	7	6	5	4	3	2	1	0	
	reserved											INTCMPBD	INTCMPBU	INTCMPAD	INTCMPAU	INTCNTLOAD	INTCNTZERO
Type	RO	RO	RO	RO	RO	RO	RO	RO	RO	RO	RO	R/W1C	R/W1C	R/W1C	R/W1C	R/W1C	
Reset	0	0	0	0	0	0	0	0	0	0	0	0	0	0	0	0	

Bit/Field	Name	Type	Reset	Description
31:6	reserved	RO	0x0000.00	Software should not rely on the value of a reserved bit. To provide compatibility with future products, the value of a reserved bit should be preserved across a read-modify-write operation.
5	INTCMPBD	R/W1C	0	Comparator B Down Interrupt  Value Description 1 The <b>INTCMPBD</b> bits in the <b>PWMnRIS</b> and <b>PWMnINTEN</b> registers are set, providing an interrupt to the interrupt controller. 0 No interrupt has occurred or the interrupt is masked.  This bit is cleared by writing a 1. Clearing this bit also clears the <b>INTCMPBD</b> bit in the <b>PWMnRIS</b> register.
4	INTCMPBU	R/W1C	0	Comparator B Up Interrupt  Value Description 1 The <b>INTCMPBU</b> bits in the <b>PWMnRIS</b> and <b>PWMnINTEN</b> registers are set, providing an interrupt to the interrupt controller. 0 No interrupt has occurred or the interrupt is masked.  This bit is cleared by writing a 1. Clearing this bit also clears the <b>INTCMPBU</b> bit in the <b>PWMnRIS</b> register.

Bit/Field	Name	Type	Reset	Description
3	INTCMPAD	R/W1C	0	<p>Comparator A Down Interrupt</p> <p>Value Description</p> <p>1 The <code>INTCMPAD</code> bits in the <b>PWMnRIS</b> and <b>PWMnINTEN</b> registers are set, providing an interrupt to the interrupt controller.</p> <p>0 No interrupt has occurred or the interrupt is masked.</p> <p>This bit is cleared by writing a 1. Clearing this bit also clears the <code>INTCMPAD</code> bit in the <b>PWMnRIS</b> register.</p>
2	INTCMPAU	R/W1C	0	<p>Comparator A Up Interrupt</p> <p>Value Description</p> <p>1 The <code>INTCMPAU</code> bits in the <b>PWMnRIS</b> and <b>PWMnINTEN</b> registers are set, providing an interrupt to the interrupt controller.</p> <p>0 No interrupt has occurred or the interrupt is masked.</p> <p>This bit is cleared by writing a 1. Clearing this bit also clears the <code>INTCMPAU</code> bit in the <b>PWMnRIS</b> register.</p>
1	INTCNTLOAD	R/W1C	0	<p>Counter=Load Interrupt</p> <p>Value Description</p> <p>1 The <code>INTCNTLOAD</code> bits in the <b>PWMnRIS</b> and <b>PWMnINTEN</b> registers are set, providing an interrupt to the interrupt controller.</p> <p>0 No interrupt has occurred or the interrupt is masked.</p> <p>This bit is cleared by writing a 1. Clearing this bit also clears the <code>INTCNTLOAD</code> bit in the <b>PWMnRIS</b> register.</p>
0	INTCNTZERO	R/W1C	0	<p>Counter=0 Interrupt</p> <p>Value Description</p> <p>1 The <code>INTCNTZERO</code> bits in the <b>PWMnRIS</b> and <b>PWMnINTEN</b> registers are set, providing an interrupt to the interrupt controller.</p> <p>0 No interrupt has occurred or the interrupt is masked.</p> <p>This bit is cleared by writing a 1. Clearing this bit also clears the <code>INTCNTZERO</code> bit in the <b>PWMnRIS</b> register.</p>

**Register 28: PWM0 Load (PWM0LOAD), offset 0x050****Register 29: PWM1 Load (PWM1LOAD), offset 0x090****Register 30: PWM2 Load (PWM2LOAD), offset 0x0D0****Register 31: PWM3 Load (PWM3LOAD), offset 0x110**

These registers contain the load value for the PWM counter (**PWM0LOAD** controls the PWM generator 0 block, and so on). Based on the counter mode configured by the **MODE** bit in the **PWMnCTL** register, this value is either loaded into the counter after it reaches zero or is the limit of up-counting after which the counter decrements back to zero. When this value matches the counter, a pulse is output which can be configured to drive the generation of the pwmA and/or pwmB signal (via the **PWMnGENA/PWMnGENB** register) or drive an interruptor ADC trigger (via the **PWMnINTEN** register).

If the Load Value Update mode is locally synchronized (based on the **LOADUPD** field encoding in the **PWMnCTL** register), the 16-bit **LOAD** value is used the next time the counter reaches zero. If the update mode is globally synchronized, it is used the next time the counter reaches zero after a synchronous update has been requested through the **PWM Master Control (PWMCTL)** register (see page 1042). If this register is re-written before the actual update occurs, the previous value is never used and is lost.

## PWM0 Load (PWM0LOAD)

Base 0x4002.8000  
Offset 0x050  
Type R/W, reset 0x0000.0000

	31	30	29	28	27	26	25	24	23	22	21	20	19	18	17	16
	reserved															
Type	RO	RO	RO	RO	RO	RO	RO	RO	RO	RO	RO	RO	RO	RO	RO	RO
Reset	0	0	0	0	0	0	0	0	0	0	0	0	0	0	0	0
	15	14	13	12	11	10	9	8	7	6	5	4	3	2	1	0
	LOAD															
Type	R/W	R/W	R/W	R/W	R/W	R/W	R/W	R/W	R/W	R/W	R/W	R/W	R/W	R/W	R/W	R/W
Reset	0	0	0	0	0	0	0	0	0	0	0	0	0	0	0	0

Bit/Field	Name	Type	Reset	Description
31:16	reserved	RO	0x0000	Software should not rely on the value of a reserved bit. To provide compatibility with future products, the value of a reserved bit should be preserved across a read-modify-write operation.
15:0	LOAD	R/W	0x0000	Counter Load Value The counter load value.

**Register 32: PWM0 Counter (PWM0COUNT), offset 0x054**

**Register 33: PWM1 Counter (PWM1COUNT), offset 0x094**

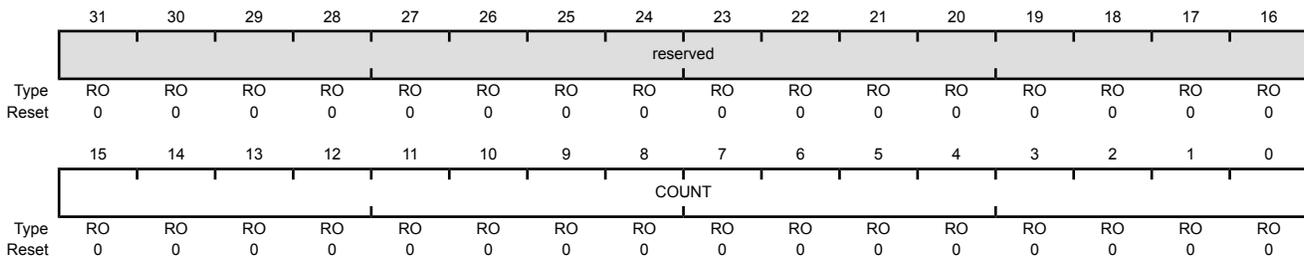
**Register 34: PWM2 Counter (PWM2COUNT), offset 0x0D4**

**Register 35: PWM3 Counter (PWM3COUNT), offset 0x114**

These registers contain the current value of the PWM counter. When this value matches zero or the value in the **PWMnLOAD**, **PWMnCMPA**, or **PWMnCMPB** registers, a pulse is output which can be configured to drive the generation of a PWM signal or drive an interrupt or ADC trigger.

PWM0 Counter (PWM0COUNT)

Base 0x4002.8000  
 Offset 0x054  
 Type RO, reset 0x0000.0000



Bit/Field	Name	Type	Reset	Description
31:16	reserved	RO	0x0000	Software should not rely on the value of a reserved bit. To provide compatibility with future products, the value of a reserved bit should be preserved across a read-modify-write operation.
15:0	COUNT	RO	0x0000	Counter Value The current value of the counter.



**Register 36: PWM0 Compare A (PWM0CMPA), offset 0x058****Register 37: PWM1 Compare A (PWM1CMPA), offset 0x098****Register 38: PWM2 Compare A (PWM2CMPA), offset 0x0D8****Register 39: PWM3 Compare A (PWM3CMPA), offset 0x118**

These registers contain a value to be compared against the counter (**PWM0CMPA** controls the PWM generator 0 block, and so on). When this value matches the counter, a pulse is output which can be configured to drive the generation of the pwmA and pwmB signals (via the **PWMnGENA** and **PWMnGENB** registers) or drive an interrupt or ADC trigger (via the **PWMnINTEN** register). If the value of this register is greater than the **PWMnLOAD** register (see page 1079), then no pulse is ever output.

If the comparator A update mode is locally synchronized (based on the **COMPAUPD** bit in the **PWMnCTL** register), the 16-bit **COMPA** value is used the next time the counter reaches zero. If the update mode is globally synchronized, it is used the next time the counter reaches zero after a synchronous update has been requested through the **PWM Master Control (PWMCTL)** register (see page 1042). If this register is rewritten before the actual update occurs, the previous value is never used and is lost.

## PWM0 Compare A (PWM0CMPA)

Base 0x4002.8000

Offset 0x058

Type R/W, reset 0x0000.0000

	31	30	29	28	27	26	25	24	23	22	21	20	19	18	17	16
	reserved															
Type	RO	RO	RO	RO	RO	RO	RO	RO	RO	RO	RO	RO	RO	RO	RO	RO
Reset	0	0	0	0	0	0	0	0	0	0	0	0	0	0	0	0
	15	14	13	12	11	10	9	8	7	6	5	4	3	2	1	0
	COMPA															
Type	R/W	R/W	R/W	R/W	R/W	R/W	R/W	R/W	R/W	R/W	R/W	R/W	R/W	R/W	R/W	R/W
Reset	0	0	0	0	0	0	0	0	0	0	0	0	0	0	0	0

Bit/Field	Name	Type	Reset	Description
31:16	reserved	RO	0x00	Software should not rely on the value of a reserved bit. To provide compatibility with future products, the value of a reserved bit should be preserved across a read-modify-write operation.
15:0	COMPA	R/W	0x00	Comparator A Value The value to be compared against the counter.

**Register 40: PWM0 Compare B (PWM0CMPB), offset 0x05C**

**Register 41: PWM1 Compare B (PWM1CMPB), offset 0x09C**

**Register 42: PWM2 Compare B (PWM2CMPB), offset 0x0DC**

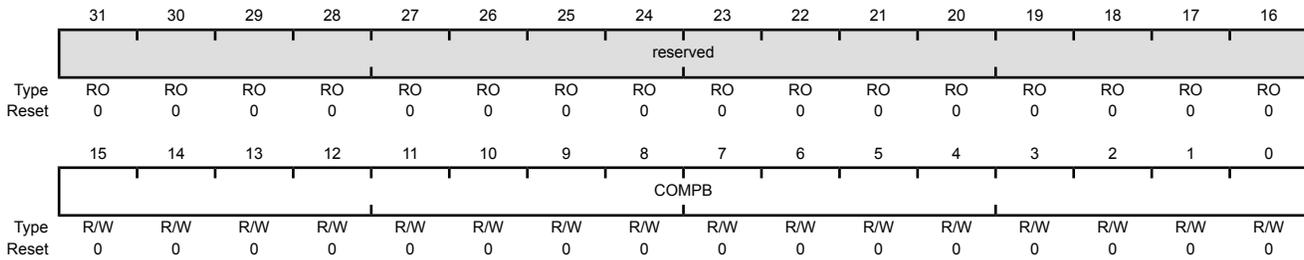
**Register 43: PWM3 Compare B (PWM3CMPB), offset 0x11C**

These registers contain a value to be compared against the counter (**PWM0CMPB** controls the PWM generator 0 block, and so on). When this value matches the counter, a pulse is output which can be configured to drive the generation of the pwmA and pwmB signals (via the **PWMnGENA** and **PWMnGENB** registers) or drive an interrupt or ADC trigger (via the **PWMnINTEN** register). If the value of this register is greater than the **PWMnLOAD** register, no pulse is ever output.

If the comparator B update mode is locally synchronized (based on the **COMPBUPD** bit in the **PWMnCTL** register), the 16-bit **COMPB** value is used the next time the counter reaches zero. If the update mode is globally synchronized, it is used the next time the counter reaches zero after a synchronous update has been requested through the **PWM Master Control (PWMCTL)** register (see page 1042). If this register is rewritten before the actual update occurs, the previous value is never used and is lost.

PWM0 Compare B (PWM0CMPB)

Base 0x4002.8000  
 Offset 0x05C  
 Type R/W, reset 0x0000.0000



Bit/Field	Name	Type	Reset	Description
31:16	reserved	RO	0x0000	Software should not rely on the value of a reserved bit. To provide compatibility with future products, the value of a reserved bit should be preserved across a read-modify-write operation.
15:0	COMPB	R/W	0x0000	Comparator B Value The value to be compared against the counter.

**Register 44: PWM0 Generator A Control (PWM0GENA), offset 0x060****Register 45: PWM1 Generator A Control (PWM1GENA), offset 0x0A0****Register 46: PWM2 Generator A Control (PWM2GENA), offset 0x0E0****Register 47: PWM3 Generator A Control (PWM3GENA), offset 0x120**

These registers control the generation of the pwmA signal based on the load and zero output pulses from the counter, as well as the compare A and compare B pulses from the comparators (**PWM0GENA** controls the PWM generator 0 block, and so on). When the counter is running in Count-Down mode, only four of these events occur; when running in Count-Up/Down mode, all six occur. These events provide great flexibility in the positioning and duty cycle of the resulting PWM signal.

The **PWM0GENA** register controls generation of the pwm0A signal; **PWM1GENA**, the pwm1A signal; **PWM2GENA**, the pwm2A signal; and **PWM3GENA**, the pwm3A signal.

If a zero or load event coincides with a compare A or compare B event, the zero or load action is taken and the compare A or compare B action is ignored. If a compare A event coincides with a compare B event, the compare A action is taken and the compare B action is ignored.

If the Generator A update mode is immediate (based on the **GENAUPD** field encoding in the **PWMnCTL** register), the **ACTCMPBD**, **ACTCMPBU**, **ACTCMPAD**, **ACTCMPAU**, **ACTLOAD**, and **ACTZERO** values are used immediately. If the update mode is locally synchronized, these values are used the next time the counter reaches zero. If the update mode is globally synchronized, these values are used the next time the counter reaches zero after a synchronous update has been requested through the **PWM Master Control (PWMCTL)** register (see page 1042). If this register is rewritten before the actual update occurs, the previous value is never used and is lost.

## PWM0 Generator A Control (PWM0GENA)

Base 0x4002.8000  
Offset 0x060  
Type R/W, reset 0x0000.0000

	31	30	29	28	27	26	25	24	23	22	21	20	19	18	17	16
	reserved															
Type	RO	RO	RO	RO	RO	RO	RO	RO	RO	RO	RO	RO	RO	RO	RO	RO
Reset	0	0	0	0	0	0	0	0	0	0	0	0	0	0	0	0
	15	14	13	12	11	10	9	8	7	6	5	4	3	2	1	0
	reserved				ACTCMPBD		ACTCMPBU		ACTCMPAD		ACTCMPAU		ACTLOAD		ACTZERO	
Type	RO	RO	RO	RO	R/W	R/W	R/W	R/W	R/W	R/W	R/W	R/W	R/W	R/W	R/W	R/W
Reset	0	0	0	0	0	0	0	0	0	0	0	0	0	0	0	0

Bit/Field	Name	Type	Reset	Description
31:12	reserved	RO	0x0000.0	Software should not rely on the value of a reserved bit. To provide compatibility with future products, the value of a reserved bit should be preserved across a read-modify-write operation.

Bit/Field	Name	Type	Reset	Description
11:10	ACTCMPBD	R/W	0x0	<p>Action for Comparator B Down</p> <p>This field specifies the action to be taken when the counter matches comparator B while counting down.</p> <p>Value Description</p> <p>0x0 Do nothing.</p> <p>0x1 Invert pwmA.</p> <p>0x2 Drive pwmA Low.</p> <p>0x3 Drive pwmA High.</p>
9:8	ACTCMPBU	R/W	0x0	<p>Action for Comparator B Up</p> <p>This field specifies the action to be taken when the counter matches comparator B while counting up. This action can only occur when the <code>MODE</code> bit in the <b>PWMnCTL</b> register is set.</p> <p>Value Description</p> <p>0x0 Do nothing.</p> <p>0x1 Invert pwmA.</p> <p>0x2 Drive pwmA Low.</p> <p>0x3 Drive pwmA High.</p>
7:6	ACTCMPAD	R/W	0x0	<p>Action for Comparator A Down</p> <p>This field specifies the action to be taken when the counter matches comparator A while counting down.</p> <p>Value Description</p> <p>0x0 Do nothing.</p> <p>0x1 Invert pwmA.</p> <p>0x2 Drive pwmA Low.</p> <p>0x3 Drive pwmA High.</p>
5:4	ACTCMPAU	R/W	0x0	<p>Action for Comparator A Up</p> <p>This field specifies the action to be taken when the counter matches comparator A while counting up. This action can only occur when the <code>MODE</code> bit in the <b>PWMnCTL</b> register is set.</p> <p>Value Description</p> <p>0x0 Do nothing.</p> <p>0x1 Invert pwmA.</p> <p>0x2 Drive pwmA Low.</p> <p>0x3 Drive pwmA High.</p>

Bit/Field	Name	Type	Reset	Description										
3:2	ACTLOAD	R/W	0x0	<p>Action for Counter=LOAD</p> <p>This field specifies the action to be taken when the counter matches the value in the <b>PWMnLOAD</b> register.</p> <table border="1"> <thead> <tr> <th>Value</th> <th>Description</th> </tr> </thead> <tbody> <tr> <td>0x0</td> <td>Do nothing.</td> </tr> <tr> <td>0x1</td> <td>Invert pwmA.</td> </tr> <tr> <td>0x2</td> <td>Drive pwmA Low.</td> </tr> <tr> <td>0x3</td> <td>Drive pwmA High.</td> </tr> </tbody> </table>	Value	Description	0x0	Do nothing.	0x1	Invert pwmA.	0x2	Drive pwmA Low.	0x3	Drive pwmA High.
Value	Description													
0x0	Do nothing.													
0x1	Invert pwmA.													
0x2	Drive pwmA Low.													
0x3	Drive pwmA High.													
1:0	ACTZERO	R/W	0x0	<p>Action for Counter=0</p> <p>This field specifies the action to be taken when the counter is zero.</p> <table border="1"> <thead> <tr> <th>Value</th> <th>Description</th> </tr> </thead> <tbody> <tr> <td>0x0</td> <td>Do nothing.</td> </tr> <tr> <td>0x1</td> <td>Invert pwmA.</td> </tr> <tr> <td>0x2</td> <td>Drive pwmA Low.</td> </tr> <tr> <td>0x3</td> <td>Drive pwmA High.</td> </tr> </tbody> </table>	Value	Description	0x0	Do nothing.	0x1	Invert pwmA.	0x2	Drive pwmA Low.	0x3	Drive pwmA High.
Value	Description													
0x0	Do nothing.													
0x1	Invert pwmA.													
0x2	Drive pwmA Low.													
0x3	Drive pwmA High.													

**Register 48: PWM0 Generator B Control (PWM0GENB), offset 0x064**

**Register 49: PWM1 Generator B Control (PWM1GENB), offset 0x0A4**

**Register 50: PWM2 Generator B Control (PWM2GENB), offset 0x0E4**

**Register 51: PWM3 Generator B Control (PWM3GENB), offset 0x124**

These registers control the generation of the pwmB signal based on the load and zero output pulses from the counter, as well as the compare A and compare B pulses from the comparators (**PWM0GENB** controls the PWM generator 0 block, and so on). When the counter is running in Count-Down mode, only four of these events occur; when running in Count-Up/Down mode, all six occur. These events provide great flexibility in the positioning and duty cycle of the resulting PWM signal.

The **PWM0GENB** register controls generation of the pwm0B signal; **PWM1GENB**, the pwm1B signal; **PWM2GENB**, the pwm2B signal; and **PWM3GENB**, the pwm3B signal.

If a zero or load event coincides with a compare A or compare B event, the zero or load action is taken and the compare A or compare B action is ignored. If a compare A event coincides with a compare B event, the compare B action is taken and the compare A action is ignored.

If the Generator B update mode is immediate (based on the **GENBUPD** field encoding in the **PWMnCTL** register), the **ACTCMPBD**, **ACTCMPBU**, **ACTCMPAD**, **ACTCMPAU**, **ACTLOAD**, and **ACTZERO** values are used immediately. If the update mode is locally synchronized, these values are used the next time the counter reaches zero. If the update mode is globally synchronized, these values are used the next time the counter reaches zero after a synchronous update has been requested through the **PWM Master Control (PWMCTL)** register (see page 1042). If this register is rewritten before the actual update occurs, the previous value is never used and is lost.

PWM0 Generator B Control (PWM0GENB)

Base 0x4002.8000  
Offset 0x064  
Type R/W, reset 0x0000.0000

	31	30	29	28	27	26	25	24	23	22	21	20	19	18	17	16
	reserved															
Type	RO	RO	RO	RO	RO	RO	RO	RO	RO	RO	RO	RO	RO	RO	RO	RO
Reset	0	0	0	0	0	0	0	0	0	0	0	0	0	0	0	0
	15	14	13	12	11	10	9	8	7	6	5	4	3	2	1	0
	reserved				ACTCMPBD		ACTCMPBU		ACTCMPAD		ACTCMPAU		ACTLOAD		ACTZERO	
Type	RO	RO	RO	RO	R/W	R/W	R/W	R/W	R/W	R/W	R/W	R/W	R/W	R/W	R/W	R/W
Reset	0	0	0	0	0	0	0	0	0	0	0	0	0	0	0	0

Bit/Field	Name	Type	Reset	Description
31:12	reserved	RO	0x0000.0	Software should not rely on the value of a reserved bit. To provide compatibility with future products, the value of a reserved bit should be preserved across a read-modify-write operation.

Bit/Field	Name	Type	Reset	Description
11:10	ACTCMPBD	R/W	0x0	<p>Action for Comparator B Down</p> <p>This field specifies the action to be taken when the counter matches comparator B while counting down.</p> <p>Value Description</p> <p>0x0 Do nothing.</p> <p>0x1 Invert pwmB.</p> <p>0x2 Drive pwmB Low.</p> <p>0x3 Drive pwmB High.</p>
9:8	ACTCMPBU	R/W	0x0	<p>Action for Comparator B Up</p> <p>This field specifies the action to be taken when the counter matches comparator B while counting up. This action can only occur when the <b>MODE</b> bit in the <b>PWMnCTL</b> register is set.</p> <p>Value Description</p> <p>0x0 Do nothing.</p> <p>0x1 Invert pwmB.</p> <p>0x2 Drive pwmB Low.</p> <p>0x3 Drive pwmB High.</p>
7:6	ACTCMPAD	R/W	0x0	<p>Action for Comparator A Down</p> <p>This field specifies the action to be taken when the counter matches comparator A while counting down.</p> <p>Value Description</p> <p>0x0 Do nothing.</p> <p>0x1 Invert pwmB.</p> <p>0x2 Drive pwmB Low.</p> <p>0x3 Drive pwmB High.</p>
5:4	ACTCMPAU	R/W	0x0	<p>Action for Comparator A Up</p> <p>This field specifies the action to be taken when the counter matches comparator A while counting up. This action can only occur when the <b>MODE</b> bit in the <b>PWMnCTL</b> register is set.</p> <p>Value Description</p> <p>0x0 Do nothing.</p> <p>0x1 Invert pwmB.</p> <p>0x2 Drive pwmB Low.</p> <p>0x3 Drive pwmB High.</p>

Bit/Field	Name	Type	Reset	Description
3:2	ACTLOAD	R/W	0x0	Action for Counter=LOAD  This field specifies the action to be taken when the counter matches the load value.  Value Description 0x0 Do nothing. 0x1 Invert pwmB. 0x2 Drive pwmB Low. 0x3 Drive pwmB High.
1:0	ACTZERO	R/W	0x0	Action for Counter=0  This field specifies the action to be taken when the counter is 0.  Value Description 0x0 Do nothing. 0x1 Invert pwmB. 0x2 Drive pwmB Low. 0x3 Drive pwmB High.



**Register 52: PWM0 Dead-Band Control (PWM0DBCTL), offset 0x068****Register 53: PWM1 Dead-Band Control (PWM1DBCTL), offset 0x0A8****Register 54: PWM2 Dead-Band Control (PWM2DBCTL), offset 0x0E8****Register 55: PWM3 Dead-Band Control (PWM3DBCTL), offset 0x128**

The **PWMnDBCTL** register controls the dead-band generator, which produces the **PWMn** signals based on the **pwmA** and **pwmB** signals. When disabled, the **pwmA** signal passes through to the **pwmA'** signal and the **pwmB** signal passes through to the **pwmB'** signal. When dead-band control is enabled, the **pwmB** signal is ignored, the **pwmA'** signal is generated by delaying the rising edge(s) of the **pwmA** signal by the value in the **PWMnDBRISE** register (see page 1090), and the **pwmB'** signal is generated by inverting the **pwmA** signal and delaying the falling edge(s) of the **pwmA** signal by the value in the **PWMnDBFALL** register (see page 1091). The Output Control block outputs the **pwm0A'** signal on the **PWM0** signal and the **pwm0B'** signal on the **PWM1** signal. In a similar manner, **PWM2** and **PWM3** are produced from the **pwm1A'** and **pwm1B'** signals, **PWM4** and **PWM5** are produced from the **pwm2A'** and **pwm2B'** signals, and **PWM6** and **PWM7** are produced from the **pwm3A'** and **pwm3B'** signals.

If the Dead-Band Control mode is immediate (based on the **DBCTLUPD** field encoding in the **PWMnCTL** register), the **ENABLE** bit value is used immediately. If the update mode is locally synchronized, this value is used the next time the counter reaches zero. If the update mode is globally synchronized, this value is used the next time the counter reaches zero after a synchronous update has been requested through the **PWM Master Control (PWMCTL)** register (see page 1042). If this register is rewritten before the actual update occurs, the previous value is never used and is lost.

**PWM0 Dead-Band Control (PWM0DBCTL)**

Base 0x4002.8000  
Offset 0x068  
Type R/W, reset 0x0000.0000

	31	30	29	28	27	26	25	24	23	22	21	20	19	18	17	16	
	reserved																
Type	RO	RO	RO	RO	RO	RO	RO	RO	RO	RO	RO	RO	RO	RO	RO	RO	
Reset	0	0	0	0	0	0	0	0	0	0	0	0	0	0	0	0	
	15	14	13	12	11	10	9	8	7	6	5	4	3	2	1	0	
	reserved																
																ENABLE	
Type	RO	RO	RO	RO	RO	RO	RO	RO	RO	RO	RO	RO	RO	RO	RO	RO	R/W
Reset	0	0	0	0	0	0	0	0	0	0	0	0	0	0	0	0	0

Bit/Field	Name	Type	Reset	Description
31:1	reserved	RO	0x0000.000	Software should not rely on the value of a reserved bit. To provide compatibility with future products, the value of a reserved bit should be preserved across a read-modify-write operation.
0	ENABLE	R/W	0	Dead-Band Generator Enable

## Value Description

1	The dead-band generator modifies the <b>pwmA</b> signal by inserting dead bands into the <b>pwmA'</b> and <b>pwmB'</b> signals.
0	The <b>pwmA</b> and <b>pwmB</b> signals pass through to the <b>pwmA'</b> and <b>pwmB'</b> signals unmodified.

**Register 56: PWM0 Dead-Band Rising-Edge Delay (PWM0DBRISE), offset 0x06C**

**Register 57: PWM1 Dead-Band Rising-Edge Delay (PWM1DBRISE), offset 0x0AC**

**Register 58: PWM2 Dead-Band Rising-Edge Delay (PWM2DBRISE), offset 0x0EC**

**Register 59: PWM3 Dead-Band Rising-Edge Delay (PWM3DBRISE), offset 0x12C**

The **PWMnDBRISE** register contains the number of clock cycles to delay the rising edge of the pwmA signal when generating the pwmA' signal. If the dead-band generator is disabled through the **PWMnDBCTL** register, this register is ignored. If the value of this register is larger than the width of a High pulse on the pwmA signal, the rising-edge delay consumes the entire High time of the signal, resulting in no High time on the output. Care must be taken to ensure that the pwmA High time always exceeds the rising-edge delay.

If the Dead-Band Rising-Edge Delay mode is immediate (based on the **DBRISEUPD** field encoding in the **PWMnCTL** register), the 12-bit **RISEDELAY** value is used immediately. If the update mode is locally synchronized, this value is used the next time the counter reaches zero. If the update mode is globally synchronized, this value is used the next time the counter reaches zero after a synchronous update has been requested through the **PWM Master Control (PWMCTL)** register (see page 1042). If this register is rewritten before the actual update occurs, the previous value is never used and is lost.

**PWM0 Dead-Band Rising-Edge Delay (PWM0DBRISE)**

Base 0x4002.8000  
 Offset 0x06C  
 Type R/W, reset 0x0000.0000

	31	30	29	28	27	26	25	24	23	22	21	20	19	18	17	16
	reserved															
Type	RO	RO	RO	RO	RO	RO	RO	RO	RO	RO	RO	RO	RO	RO	RO	RO
Reset	0	0	0	0	0	0	0	0	0	0	0	0	0	0	0	0
	15	14	13	12	11	10	9	8	7	6	5	4	3	2	1	0
	reserved				RISEDELAY											
Type	RO	RO	RO	RO	R/W	R/W	R/W	R/W	R/W	R/W	R/W	R/W	R/W	R/W	R/W	R/W
Reset	0	0	0	0	0	0	0	0	0	0	0	0	0	0	0	0

Bit/Field	Name	Type	Reset	Description
31:12	reserved	RO	0x0000.0	Software should not rely on the value of a reserved bit. To provide compatibility with future products, the value of a reserved bit should be preserved across a read-modify-write operation.
11:0	RISEDELAY	R/W	0x000	Dead-Band Rise Delay  The number of clock cycles to delay the rising edge of pwmA' after the rising edge of pwmA.

**Register 60: PWM0 Dead-Band Falling-Edge-Delay (PWM0DBFALL), offset 0x070**

**Register 61: PWM1 Dead-Band Falling-Edge-Delay (PWM1DBFALL), offset 0x0B0**

**Register 62: PWM2 Dead-Band Falling-Edge-Delay (PWM2DBFALL), offset 0x0F0**

**Register 63: PWM3 Dead-Band Falling-Edge-Delay (PWM3DBFALL), offset 0x130**

The **PWMnDBFALL** register contains the number of clock cycles to delay the rising edge of the pwmB' signal from the falling edge of the pwmA signal. If the dead-band generator is disabled through the **PWMnDBCTL** register, this register is ignored. If the value of this register is larger than the width of a Low pulse on the pwmA signal, the falling-edge delay consumes the entire Low time of the signal, resulting in no Low time on the output. Care must be taken to ensure that the pwmA Low time always exceeds the falling-edge delay.

If the Dead-Band Falling-Edge-Delay mode is immediate (based on the **DBFALLUP** field encoding in the **PWMnCTL** register), the 12-bit **FALLDELAY** value is used immediately. If the update mode is locally synchronized, this value is used the next time the counter reaches zero. If the update mode is globally synchronized, this value is used the next time the counter reaches zero after a synchronous update has been requested through the **PWM Master Control (PWMCTL)** register (see page 1042). If this register is rewritten before the actual update occurs, the previous value is never used and is lost.

#### PWM0 Dead-Band Falling-Edge-Delay (PWM0DBFALL)

Base 0x4002.8000  
Offset 0x070  
Type R/W, reset 0x0000.0000

	31	30	29	28	27	26	25	24	23	22	21	20	19	18	17	16
	reserved															
Type	RO	RO	RO	RO	RO	RO	RO	RO	RO	RO	RO	RO	RO	RO	RO	RO
Reset	0	0	0	0	0	0	0	0	0	0	0	0	0	0	0	0
	15	14	13	12	11	10	9	8	7	6	5	4	3	2	1	0
	reserved				FALLDELAY											
Type	RO	RO	RO	RO	R/W	R/W	R/W	R/W	R/W	R/W	R/W	R/W	R/W	R/W	R/W	R/W
Reset	0	0	0	0	0	0	0	0	0	0	0	0	0	0	0	0

Bit/Field	Name	Type	Reset	Description
31:12	reserved	RO	0x0000.0	Software should not rely on the value of a reserved bit. To provide compatibility with future products, the value of a reserved bit should be preserved across a read-modify-write operation.
11:0	FALLDELAY	R/W	0x000	Dead-Band Fall Delay  The number of clock cycles to delay the falling edge of pwmB' from the rising edge of pwmA.

**Register 64: PWM0 Fault Source 0 (PWM0FLTSRC0), offset 0x074**

**Register 65: PWM1 Fault Source 0 (PWM1FLTSRC0), offset 0x0B4**

**Register 66: PWM2 Fault Source 0 (PWM2FLTSRC0), offset 0x0F4**

**Register 67: PWM3 Fault Source 0 (PWM3FLTSRC0), offset 0x134**

This register specifies which fault pin inputs are used to generate a fault condition. Each bit in the following register indicates whether the corresponding fault pin is included in the fault condition. All enabled fault pins are ORed together to form the **PWMnFLTSRC0** portion of the fault condition. The **PWMnFLTSRC0** fault condition is then ORed with the **PWMnFLTSRC1** fault condition to generate the final fault condition for the PWM generator.

If the **FLTSRC** bit in the **PWMnCTL** register (see page 1067) is clear, only the **Fault0** signal affects the fault condition generated. Otherwise, sources defined in **PWMnFLTSRC0** and **PWMnFLTSRC1** affect the fault condition generated.

PWM0 Fault Source 0 (PWM0FLTSRC0)

Base 0x4002.8000  
 Offset 0x074  
 Type R/W, reset 0x0000.0000

	31	30	29	28	27	26	25	24	23	22	21	20	19	18	17	16
	reserved															
Type	RO	RO	RO	RO	RO	RO	RO	RO	RO	RO	RO	RO	RO	RO	RO	RO
Reset	0	0	0	0	0	0	0	0	0	0	0	0	0	0	0	0
	15	14	13	12	11	10	9	8	7	6	5	4	3	2	1	0
	reserved												FAULT3	FAULT2	FAULT1	FAULT0
Type	RO	RO	RO	RO	RO	RO	RO	RO	RO	RO	RO	RO	R/W	R/W	R/W	R/W
Reset	0	0	0	0	0	0	0	0	0	0	0	0	0	0	0	0

Bit/Field	Name	Type	Reset	Description
31:4	reserved	RO	0x0000	Software should not rely on the value of a reserved bit. To provide compatibility with future products, the value of a reserved bit should be preserved across a read-modify-write operation.
3	FAULT3	R/W	0	<p><b>Fault3</b> Input</p> <p><b>Value Description</b></p> <p>0 The <b>Fault3</b> signal is suppressed and cannot generate a fault condition.</p> <p>1 The <b>Fault3</b> signal value is ORed with all other fault condition generation inputs (<b>Faultn</b> signals and digital comparators).</p> <p><b>Note:</b> The <b>FLTSRC</b> bit in the <b>PWMnCTL</b> register must be set for this bit to affect fault condition generation.</p>

Bit/Field	Name	Type	Reset	Description
2	FAULT2	R/W	0	<p>Fault2 Input</p> <p>Value Description</p> <p>0 The Fault2 signal is suppressed and cannot generate a fault condition.</p> <p>1 The Fault2 signal value is ORed with all other fault condition generation inputs (Faultn signals and digital comparators).</p> <p><b>Note:</b> The FLTSRC bit in the PWMnCTL register must be set for this bit to affect fault condition generation.</p>
1	FAULT1	R/W	0	<p>Fault1 Input</p> <p>Value Description</p> <p>0 The Fault1 signal is suppressed and cannot generate a fault condition.</p> <p>1 The Fault1 signal value is ORed with all other fault condition generation inputs (Faultn signals and digital comparators).</p> <p><b>Note:</b> The FLTSRC bit in the PWMnCTL register must be set for this bit to affect fault condition generation.</p>
0	FAULT0	R/W	0	<p>Fault0 Input</p> <p>Value Description</p> <p>0 The Fault0 signal is suppressed and cannot generate a fault condition.</p> <p>1 The Fault0 signal value is ORed with all other fault condition generation inputs (Faultn signals and digital comparators).</p> <p><b>Note:</b> The FLTSRC bit in the PWMnCTL register must be set for this bit to affect fault condition generation.</p>

**Register 68: PWM0 Fault Source 1 (PWM0FLTSRC1), offset 0x078**

**Register 69: PWM1 Fault Source 1 (PWM1FLTSRC1), offset 0x0B8**

**Register 70: PWM2 Fault Source 1 (PWM2FLTSRC1), offset 0x0F8**

**Register 71: PWM3 Fault Source 1 (PWM3FLTSRC1), offset 0x138**

This register specifies which digital comparator triggers from the ADC are used to generate a fault condition. Each bit in the following register indicates whether the corresponding digital comparator trigger is included in the fault condition. All enabled digital comparator triggers are ORed together to form the **PWMnFLTSRC1** portion of the fault condition. The **PWMnFLTSRC1** fault condition is then ORed with the **PWMnFLTSRC0** fault condition to generate the final fault condition for the PWM generator.

If the **FLTSRC** bit in the **PWMnCTL** register (see page 1067) is clear, only the PWM<sub>Fault0</sub> pin affects the fault condition generated. Otherwise, sources defined in **PWMnFLTSRC0** and **PWMnFLTSRC1** affect the fault condition generated.

PWM0 Fault Source 1 (PWM0FLTSRC1)

Base 0x4002.8000  
Offset 0x078  
Type R/W, reset 0x0000.0000

	31	30	29	28	27	26	25	24	23	22	21	20	19	18	17	16
	reserved															
Type	RO	RO	RO	RO	RO	RO	RO	RO	RO	RO	RO	RO	RO	RO	RO	RO
Reset	0	0	0	0	0	0	0	0	0	0	0	0	0	0	0	0
	15	14	13	12	11	10	9	8	7	6	5	4	3	2	1	0
	reserved								DCMP7	DCMP6	DCMP5	DCMP4	DCMP3	DCMP2	DCMP1	DCMP0
Type	RO	RO	RO	RO	RO	RO	RO	RO	R/W	R/W	R/W	R/W	R/W	R/W	R/W	R/W
Reset	0	0	0	0	0	0	0	0	0	0	0	0	0	0	0	0

Bit/Field	Name	Type	Reset	Description
31:8	reserved	RO	0x0000.00	Software should not rely on the value of a reserved bit. To provide compatibility with future products, the value of a reserved bit should be preserved across a read-modify-write operation.
7	DCMP7	R/W	0	Digital Comparator 7  Value Description 0 The trigger from digital comparator 7 is suppressed and cannot generate a fault condition. 1 The trigger from digital comparator 7 is ORed with all other fault condition generation inputs (Faultn signals and digital comparators).

**Note:** The **FLTSRC** bit in the **PWMnCTL** register must be set for this bit to affect fault condition generation.

Bit/Field	Name	Type	Reset	Description
6	DCMP6	R/W	0	<p>Digital Comparator 6</p> <p>Value Description</p> <p>0 The trigger from digital comparator 6 is suppressed and cannot generate a fault condition.</p> <p>1 The trigger from digital comparator 6 is ORed with all other fault condition generation inputs (Faultn signals and digital comparators).</p> <p><b>Note:</b> The FLTSRC bit in the PWMnCTL register must be set for this bit to affect fault condition generation.</p>
5	DCMP5	R/W	0	<p>Digital Comparator 5</p> <p>Value Description</p> <p>0 The trigger from digital comparator 5 is suppressed and cannot generate a fault condition.</p> <p>1 The trigger from digital comparator 5 is ORed with all other fault condition generation inputs (Faultn signals and digital comparators).</p> <p><b>Note:</b> The FLTSRC bit in the PWMnCTL register must be set for this bit to affect fault condition generation.</p>
4	DCMP4	R/W	0	<p>Digital Comparator 4</p> <p>Value Description</p> <p>0 The trigger from digital comparator 4 is suppressed and cannot generate a fault condition.</p> <p>1 The trigger from digital comparator 4 is ORed with all other fault condition generation inputs (Faultn signals and digital comparators).</p> <p><b>Note:</b> The FLTSRC bit in the PWMnCTL register must be set for this bit to affect fault condition generation.</p>
3	DCMP3	R/W	0	<p>Digital Comparator 3</p> <p>Value Description</p> <p>0 The trigger from digital comparator 3 is suppressed and cannot generate a fault condition.</p> <p>1 The trigger from digital comparator 3 is ORed with all other fault condition generation inputs (Faultn signals and digital comparators).</p> <p><b>Note:</b> The FLTSRC bit in the PWMnCTL register must be set for this bit to affect fault condition generation.</p>

Bit/Field	Name	Type	Reset	Description
2	DCMP2	R/W	0	<p>Digital Comparator 2</p> <p>Value Description</p> <p>0 The trigger from digital comparator 2 is suppressed and cannot generate a fault condition.</p> <p>1 The trigger from digital comparator 2 is ORed with all other fault condition generation inputs (Faultn signals and digital comparators).</p> <p><b>Note:</b> The FLTSRC bit in the PWMnCTL register must be set for this bit to affect fault condition generation.</p>
1	DCMP1	R/W	0	<p>Digital Comparator 1</p> <p>Value Description</p> <p>0 The trigger from digital comparator 1 is suppressed and cannot generate a fault condition.</p> <p>1 The trigger from digital comparator 1 is ORed with all other fault condition generation inputs (Faultn signals and digital comparators).</p> <p><b>Note:</b> The FLTSRC bit in the PWMnCTL register must be set for this bit to affect fault condition generation.</p>
0	DCMP0	R/W	0	<p>Digital Comparator 0</p> <p>Value Description</p> <p>0 The trigger from digital comparator 0 is suppressed and cannot generate a fault condition.</p> <p>1 The trigger from digital comparator 0 is ORed with all other fault condition generation inputs (Faultn signals and digital comparators).</p> <p><b>Note:</b> The FLTSRC bit in the PWMnCTL register must be set for this bit to affect fault condition generation.</p>



**Register 72: PWM0 Minimum Fault Period (PWM0MINFLTPER), offset 0x07C**

**Register 73: PWM1 Minimum Fault Period (PWM1MINFLTPER), offset 0x0BC**

**Register 74: PWM2 Minimum Fault Period (PWM2MINFLTPER), offset 0x0FC**

**Register 75: PWM3 Minimum Fault Period (PWM3MINFLTPER), offset 0x13C**

If the `MINFLTPER` bit in the `PWMnCTL` register is set, this register specifies the 16-bit time-extension value to be used in extending the fault condition. The value is loaded into a 16-bit down counter, and the counter value is used to extend the fault condition. The fault condition is released in the clock immediately after the counter value reaches 0. The fault condition is asynchronous to the PWM clock; and the delay value is the product of the PWM clock period and the (MFP field value + 1) or (MFP field value + 2) depending on when the fault condition asserts with respect to the PWM clock. The counter decrements at the PWM clock rate, without pause or condition.

#### PWM0 Minimum Fault Period (PWM0MINFLTPER)

Base 0x4002.8000  
Offset 0x07C  
Type R/W, reset 0x0000.0000

	31	30	29	28	27	26	25	24	23	22	21	20	19	18	17	16
	reserved															
Type	R/W	R/W	R/W	R/W	R/W	R/W	R/W	R/W	R/W	R/W	R/W	R/W	R/W	R/W	R/W	R/W
Reset	0	0	0	0	0	0	0	0	0	0	0	0	0	0	0	0
	15	14	13	12	11	10	9	8	7	6	5	4	3	2	1	0
	MFP															
Type	RO	RO	RO	RO	RO	RO	RO	RO	RO	RO	RO	RO	RO	RO	RO	RO
Reset	0	0	0	0	0	0	0	0	0	0	0	0	0	0	0	0

Bit/Field	Name	Type	Reset	Description
31:16	reserved	R/W	0x0000	Software should not rely on the value of a reserved bit. To provide compatibility with future products, the value of a reserved bit should be preserved across a read-modify-write operation.
15:0	MFP	RO	0x0000	Minimum Fault Period  The number of PWM clocks by which a fault condition is extended when the delay is enabled by <code>PWMnCTL</code> <code>MINFLTPER</code> .

**Register 76: PWM0 Fault Pin Logic Sense (PWM0FLTSEN), offset 0x800**

**Register 77: PWM1 Fault Pin Logic Sense (PWM1FLTSEN), offset 0x880**

**Register 78: PWM2 Fault Pin Logic Sense (PWM2FLTSEN), offset 0x900**

**Register 79: PWM3 Fault Pin Logic Sense (PWM3FLTSEN), offset 0x980**

This register defines the PWM fault pin logic sense.

PWM0 Fault Pin Logic Sense (PWM0FLTSEN)

Base 0x4002.8000  
 Offset 0x800  
 Type R/W, reset 0x0000.0000

	31	30	29	28	27	26	25	24	23	22	21	20	19	18	17	16
	reserved															
Type	RO	RO	RO	RO	RO	RO	RO	RO	RO	RO	RO	RO	RO	RO	RO	RO
Reset	0	0	0	0	0	0	0	0	0	0	0	0	0	0	0	0
	15	14	13	12	11	10	9	8	7	6	5	4	3	2	1	0
	reserved												FAULT3	FAULT2	FAULT1	FAULT0
Type	RO	RO	RO	RO	RO	RO	RO	RO	RO	RO	RO	RO	R/W	R/W	R/W	R/W
Reset	0	0	0	0	0	0	0	0	0	0	0	0	0	0	0	0

Bit/Field	Name	Type	Reset	Description
31:4	reserved	RO	0x0000.000	Software should not rely on the value of a reserved bit. To provide compatibility with future products, the value of a reserved bit should be preserved across a read-modify-write operation.
3	FAULT3	R/W	0	Fault3 Sense  Value Description 0 An error is indicated if the <code>Fault3</code> signal is High. 1 An error is indicated if the <code>Fault3</code> signal is Low.
2	FAULT2	R/W	0	Fault2 Sense  Value Description 0 An error is indicated if the <code>Fault2</code> signal is High. 1 An error is indicated if the <code>Fault2</code> signal is Low.
1	FAULT1	R/W	0	Fault1 Sense  Value Description 0 An error is indicated if the <code>Fault1</code> signal is High. 1 An error is indicated if the <code>Fault1</code> signal is Low.
0	FAULT0	R/W	0	Fault0 Sense  Value Description 0 An error is indicated if the <code>Fault0</code> signal is High. 1 An error is indicated if the <code>Fault0</code> signal is Low.

**Register 80: PWM0 Fault Status 0 (PWM0FLTSTAT0), offset 0x804**

**Register 81: PWM1 Fault Status 0 (PWM1FLTSTAT0), offset 0x884**

**Register 82: PWM2 Fault Status 0 (PWM2FLTSTAT0), offset 0x904**

**Register 83: PWM3 Fault Status 0 (PWM3FLTSTAT0), offset 0x984**

Along with the **PWMnFLTSTAT1** register, this register provides status regarding the fault condition inputs.

If the **LATCH** bit in the **PWMnCTL** register is clear, the contents of the **PWMnFLTSTAT0** register are read-only (RO) and provide the current state of the **FAULTn** inputs.

If the **LATCH** bit in the **PWMnCTL** register is set, the contents of the **PWMnFLTSTAT0** register are read / write 1 to clear (R/W1C) and provide a latched version of the **FAULTn** inputs. In this mode, the register bits are cleared by writing a 1 to a set bit. The **FAULTn** inputs are recorded after their sense is adjusted in the generator.

The contents of this register can only be written if the fault source extensions are enabled (the **FLTSRC** bit in the **PWMnCTL** register is set).

#### PWM0 Fault Status 0 (PWM0FLTSTAT0)

Base 0x4002.8000

Offset 0x804

Type -, reset 0x0000.0000

	31	30	29	28	27	26	25	24	23	22	21	20	19	18	17	16	
	reserved																
Type	RO	RO	RO	RO	RO	RO	RO	RO	RO	RO	RO	RO	RO	RO	RO	RO	
Reset	0	0	0	0	0	0	0	0	0	0	0	0	0	0	0	0	
	15	14	13	12	11	10	9	8	7	6	5	4	3	2	1	0	
	reserved													FAULT3	FAULT2	FAULT1	FAULT0
Type	RO	RO	RO	RO	RO	RO	RO	RO	RO	RO	RO	RO	RO	-	-	-	-
Reset	0	0	0	0	0	0	0	0	0	0	0	0	0	0	0	0	0

Bit/Field	Name	Type	Reset	Description
31:4	reserved	RO	0x0000	Software should not rely on the value of a reserved bit. To provide compatibility with future products, the value of a reserved bit should be preserved across a read-modify-write operation.
3	FAULT3	-	0	<p>Fault Input 3</p> <p>If the <b>PWMnCTL</b> register <b>LATCH</b> bit is clear, this bit is RO and represents the current state of the <b>FAULT3</b> input signal after the logic sense adjustment.</p> <p>If the <b>PWMnCTL</b> register <b>LATCH</b> bit is set, this bit is R/W1C and represents a sticky version of the <b>FAULT3</b> input signal after the logic sense adjustment.</p> <ul style="list-style-type: none"> <li>■ If <b>FAULT3</b> is set, the input transitioned to the active state previously.</li> <li>■ If <b>FAULT3</b> is clear, the input has not transitioned to the active state since the last time it was cleared.</li> <li>■ The <b>FAULT3</b> bit is cleared by writing it with the value 1.</li> </ul>

Bit/Field	Name	Type	Reset	Description
2	FAULT2	-	0	<p>Fault Input 2</p> <p>If the <b>PWMnCTL</b> register <b>LATCH</b> bit is clear, this bit is RO and represents the current state of the <b>FAULT2</b> input signal after the logic sense adjustment.</p> <p>If the <b>PWMnCTL</b> register <b>LATCH</b> bit is set, this bit is R/W1C and represents a sticky version of the <b>FAULT2</b> input signal after the logic sense adjustment.</p> <ul style="list-style-type: none"> <li>■ If <b>FAULT2</b> is set, the input transitioned to the active state previously.</li> <li>■ If <b>FAULT2</b> is clear, the input has not transitioned to the active state since the last time it was cleared.</li> <li>■ The <b>FAULT2</b> bit is cleared by writing it with the value 1.</li> </ul>
1	FAULT1	-	0	<p>Fault Input 1</p> <p>If the <b>PWMnCTL</b> register <b>LATCH</b> bit is clear, this bit is RO and represents the current state of the <b>FAULT1</b> input signal after the logic sense adjustment.</p> <p>If the <b>PWMnCTL</b> register <b>LATCH</b> bit is set, this bit is R/W1C and represents a sticky version of the <b>FAULT1</b> input signal after the logic sense adjustment.</p> <ul style="list-style-type: none"> <li>■ If <b>FAULT1</b> is set, the input transitioned to the active state previously.</li> <li>■ If <b>FAULT1</b> is clear, the input has not transitioned to the active state since the last time it was cleared.</li> <li>■ The <b>FAULT1</b> bit is cleared by writing it with the value 1.</li> </ul>
0	FAULT0	-	0	<p>Fault Input 0</p> <p>If the <b>PWMnCTL</b> register <b>LATCH</b> bit is clear, this bit is RO and represents the current state of the <b>FAULT0</b> input signal after the logic sense adjustment.</p> <p>If the <b>PWMnCTL</b> register <b>LATCH</b> bit is set, this bit is R/W1C and represents a sticky version of the <b>FAULT0</b> input signal after the logic sense adjustment.</p> <ul style="list-style-type: none"> <li>■ If <b>FAULT0</b> is set, the input transitioned to the active state previously.</li> <li>■ If <b>FAULT0</b> is clear, the input has not transitioned to the active state since the last time it was cleared.</li> <li>■ The <b>FAULT0</b> bit is cleared by writing it with the value 1.</li> </ul>

**Register 84: PWM0 Fault Status 1 (PWM0FLTSTAT1), offset 0x808****Register 85: PWM1 Fault Status 1 (PWM1FLTSTAT1), offset 0x888****Register 86: PWM2 Fault Status 1 (PWM2FLTSTAT1), offset 0x908****Register 87: PWM3 Fault Status 1 (PWM3FLTSTAT1), offset 0x988**

Along with the **PWMnFLTSTAT0** register, this register provides status regarding the fault condition inputs.

If the **LATCH** bit in the **PWMnCTL** register is clear, the contents of the **PWMnFLTSTAT1** register are read-only (RO) and provide the current state of the digital comparator triggers.

If the **LATCH** bit in the **PWMnCTL** register is set, the contents of the **PWMnFLTSTAT1** register are read / write 1 to clear (R/W1C) and provide a latched version of the digital comparator triggers. In this mode, the register bits are cleared by writing a 1 to a set bit. The contents of this register can only be written if the fault source extensions are enabled (the **FLTSRC** bit in the **PWMnCTL** register is set).

**PWM0 Fault Status 1 (PWM0FLTSTAT1)**

Base 0x4002.8000  
Offset 0x808  
Type -, reset 0x0000.0000

	31	30	29	28	27	26	25	24	23	22	21	20	19	18	17	16
	reserved															
Type	RO	RO	RO	RO	RO	RO	RO	RO	RO	RO	RO	RO	RO	RO	RO	RO
Reset	0	0	0	0	0	0	0	0	0	0	0	0	0	0	0	0
	15	14	13	12	11	10	9	8	7	6	5	4	3	2	1	0
	reserved								DCMP7	DCMP6	DCMP5	DCMP4	DCMP3	DCMP2	DCMP1	DCMP0
Type	RO	RO	RO	RO	RO	RO	RO	RO	-	-	-	-	-	-	-	-
Reset	0	0	0	0	0	0	0	0	0	0	0	0	0	0	0	0

Bit/Field	Name	Type	Reset	Description
31:8	reserved	RO	0x0000.00	Software should not rely on the value of a reserved bit. To provide compatibility with future products, the value of a reserved bit should be preserved across a read-modify-write operation.
7	DCMP7	-	0	<p>Digital Comparator 7 Trigger</p> <p>If the <b>PWMnCTL</b> register <b>LATCH</b> bit is clear, this bit represents the current state of the Digital Comparator 7 trigger input.</p> <p>If the <b>PWMnCTL</b> register <b>LATCH</b> bit is set, this bit represents a sticky version of the trigger.</p> <ul style="list-style-type: none"> <li>■ If <b>DCMP7</b> is set, the trigger transitioned to the active state previously.</li> <li>■ If <b>DCMP7</b> is clear, the trigger has not transitioned to the active state since the last time it was cleared.</li> <li>■ The <b>DCMP7</b> bit is cleared by writing it with the value 1.</li> </ul>

Bit/Field	Name	Type	Reset	Description
6	DCMP6	-	0	<p>Digital Comparator 6 Trigger</p> <p>If the <b>PWMnCTL</b> register <i>LATCH</i> bit is clear, this bit represents the current state of the Digital Comparator 6 trigger input.</p> <p>If the <b>PWMnCTL</b> register <i>LATCH</i> bit is set, this bit represents a sticky version of the trigger.</p> <ul style="list-style-type: none"> <li>■ If DCMP6 is set, the trigger transitioned to the active state previously.</li> <li>■ If DCMP6 is clear, the trigger has not transitioned to the active state since the last time it was cleared.</li> <li>■ The DCMP6 bit is cleared by writing it with the value 1.</li> </ul>
5	DCMP5	-	0	<p>Digital Comparator 5 Trigger</p> <p>If the <b>PWMnCTL</b> register <i>LATCH</i> bit is clear, this bit represents the current state of the Digital Comparator 5 trigger input.</p> <p>If the <b>PWMnCTL</b> register <i>LATCH</i> bit is set, this bit represents a sticky version of the trigger.</p> <ul style="list-style-type: none"> <li>■ If DCMP5 is set, the trigger transitioned to the active state previously.</li> <li>■ If DCMP5 is clear, the trigger has not transitioned to the active state since the last time it was cleared.</li> <li>■ The DCMP5 bit is cleared by writing it with the value 1.</li> </ul>
4	DCMP4	-	0	<p>Digital Comparator 4 Trigger</p> <p>If the <b>PWMnCTL</b> register <i>LATCH</i> bit is clear, this bit represents the current state of the Digital Comparator 4 trigger input.</p> <p>If the <b>PWMnCTL</b> register <i>LATCH</i> bit is set, this bit represents a sticky version of the trigger.</p> <ul style="list-style-type: none"> <li>■ If DCMP4 is set, the trigger transitioned to the active state previously.</li> <li>■ If DCMP4 is clear, the trigger has not transitioned to the active state since the last time it was cleared.</li> <li>■ The DCMP4 bit is cleared by writing it with the value 1.</li> </ul>
3	DCMP3	-	0	<p>Digital Comparator 3 Trigger</p> <p>If the <b>PWMnCTL</b> register <i>LATCH</i> bit is clear, this bit represents the current state of the Digital Comparator 3 trigger input.</p> <p>If the <b>PWMnCTL</b> register <i>LATCH</i> bit is set, this bit represents a sticky version of the trigger.</p> <ul style="list-style-type: none"> <li>■ If DCMP3 is set, the trigger transitioned to the active state previously.</li> <li>■ If DCMP3 is clear, the trigger has not transitioned to the active state since the last time it was cleared.</li> <li>■ The DCMP3 bit is cleared by writing it with the value 1.</li> </ul>

Bit/Field	Name	Type	Reset	Description
2	DCMP2	-	0	<p>Digital Comparator 2 Trigger</p> <p>If the <b>PWMnCTL</b> register <b>LATCH</b> bit is clear, this bit represents the current state of the Digital Comparator 2 trigger input.</p> <p>If the <b>PWMnCTL</b> register <b>LATCH</b> bit is set, this bit represents a sticky version of the trigger.</p> <ul style="list-style-type: none"> <li>■ If <b>DCMP2</b> is set, the trigger transitioned to the active state previously.</li> <li>■ If <b>DCMP2</b> is clear, the trigger has not transitioned to the active state since the last time it was cleared.</li> <li>■ The <b>DCMP2</b> bit is cleared by writing it with the value 1.</li> </ul>
1	DCMP1	-	0	<p>Digital Comparator 1 Trigger</p> <p>If the <b>PWMnCTL</b> register <b>LATCH</b> bit is clear, this bit represents the current state of the Digital Comparator 1 trigger input.</p> <p>If the <b>PWMnCTL</b> register <b>LATCH</b> bit is set, this bit represents a sticky version of the trigger.</p> <ul style="list-style-type: none"> <li>■ If <b>DCMP1</b> is set, the trigger transitioned to the active state previously.</li> <li>■ If <b>DCMP1</b> is clear, the trigger has not transitioned to the active state since the last time it was cleared.</li> <li>■ The <b>DCMP1</b> bit is cleared by writing it with the value 1.</li> </ul>
0	DCMP0	-	0	<p>Digital Comparator 0 Trigger</p> <p>If the <b>PWMnCTL</b> register <b>LATCH</b> bit is clear, this bit represents the current state of the Digital Comparator 0 trigger input.</p> <p>If the <b>PWMnCTL</b> register <b>LATCH</b> bit is set, this bit represents a sticky version of the trigger.</p> <ul style="list-style-type: none"> <li>■ If <b>DCMP0</b> is set, the trigger transitioned to the active state previously.</li> <li>■ If <b>DCMP0</b> is clear, the trigger has not transitioned to the active state since the last time it was cleared.</li> <li>■ The <b>DCMP0</b> bit is cleared by writing it with the value 1.</li> </ul>

## 23 Quadrature Encoder Interface (QEI)

A quadrature encoder, also known as a 2-channel incremental encoder, converts linear displacement into a pulse signal. By monitoring both the number of pulses and the relative phase of the two signals, you can track the position, direction of rotation, and speed. In addition, a third channel, or index signal, can be used to reset the position counter.

The LM3S9B96 microcontroller includes two quadrature encoder interface (QEI) modules. Each QEI module interprets the code produced by a quadrature encoder wheel to integrate position over time and determine direction of rotation. In addition, it can capture a running estimate of the velocity of the encoder wheel.

The Stellaris<sup>®</sup> LM3S9B96 microcontroller includes two QEI modules providing control of two motors at the same time with the following features:

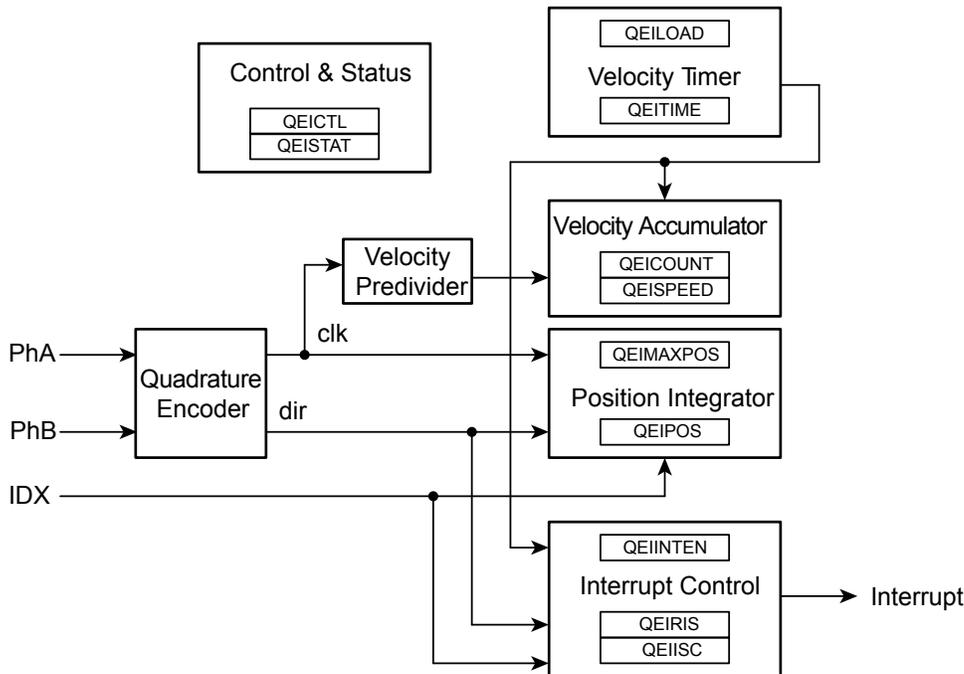
- Position integrator that tracks the encoder position
- Programmable noise filter on the inputs
- Velocity capture using built-in timer
- The input frequency of the QEI inputs may be as high as 1/4 of the processor frequency (for example, 12.5 MHz for a 50-MHz system)
- Interrupt generation on:
  - Index pulse
  - Velocity-timer expiration
  - Direction change
  - Quadrature error detection

### 23.1 Block Diagram

Figure 23-1 on page 1105 provides a block diagram of a Stellaris<sup>®</sup> QEI module.



Figure 23-1. QEI Block Diagram



## 23.2 Signal Description

Table 23-1 on page 1105 and Table 23-2 on page 1106 list the external signals of the QEI module and describe the function of each. The QEI signals are alternate functions for some GPIO signals and default to be GPIO signals at reset. The column in the table below titled "Pin Mux/Pin Assignment" lists the possible GPIO pin placements for these QEI signals. The **AFSEL** bit in the **GPIO Alternate Function Select (GPIOAFSEL)** register (page 328) should be set to choose the QEI function. The number in parentheses is the encoding that must be programmed into the **PMC<sub>n</sub>** field in the **GPIO Port Control (GPIOPTCL)** register (page 346) to assign the QEI signal to the specified GPIO port pin. For more information on configuring GPIOs, see "General-Purpose Input/Outputs (GPIOs)" on page 304.

Table 23-1. Signals for QEI (100LQFP)

Pin Name	Pin Number	Pin Mux / Pin Assignment	Pin Type	Buffer Type <sup>a</sup>	Description
IDX0	10	PD0 (3)	I	TTL	QEI module 0 index.
	72	PB2 (2)			
	90	PB6 (5)			
	92	PB4 (6)			
	100	PD7 (1)			
IDX1	61	PF1 (2)	I	TTL	QEI module 1 index.
	84	PH2 (1)			
PhA0	11	PD1 (3)	I	TTL	QEI module 0 phase A.
	25	PC4 (2)			
	95	PE2 (4)			
PhA1	96	PE3 (3)	I	TTL	QEI module 1 phase A.

**Table 23-1. Signals for QEI (100LQFP) (continued)**

Pin Name	Pin Number	Pin Mux / Pin Assignment	Pin Type	Buffer Type <sup>a</sup>	Description
PhB0	22	PC7 (2)	I	TTL	QEI module 0 phase B.
	23	PC6 (2)			
	47	PF0 (2)			
	83	PH3 (1)			
	96	PE3 (4)			
PhB1	11	PD1 (11)	I	TTL	QEI module 1 phase B.
	36	PG7 (1)			
	95	PE2 (3)			

a. The TTL designation indicates the pin has TTL-compatible voltage levels.

**Table 23-2. Signals for QEI (108BGA)**

Pin Name	Pin Number	Pin Mux / Pin Assignment	Pin Type	Buffer Type <sup>a</sup>	Description
IDX0	G1	PD0 (3)	I	TTL	QEI module 0 index.
	A11	PB2 (2)			
	A7	PB6 (5)			
	A6	PB4 (6)			
	A2	PD7 (1)			
IDX1	H12	PF1 (2)	I	TTL	QEI module 1 index.
	D11	PH2 (1)			
PhA0	G2	PD1 (3)	I	TTL	QEI module 0 phase A.
	L1	PC4 (2)			
	A4	PE2 (4)			
PhA1	B4	PE3 (3)	I	TTL	QEI module 1 phase A.
PhB0	L2	PC7 (2)	I	TTL	QEI module 0 phase B.
	M2	PC6 (2)			
	M9	PF0 (2)			
	D10	PH3 (1)			
	B4	PE3 (4)			
PhB1	G2	PD1 (11)	I	TTL	QEI module 1 phase B.
	C10	PG7 (1)			
	A4	PE2 (3)			

a. The TTL designation indicates the pin has TTL-compatible voltage levels.

## 23.3 Functional Description

The QEI module interprets the two-bit gray code produced by a quadrature encoder wheel to integrate position over time and determine direction of rotation. In addition, it can capture a running estimate of the velocity of the encoder wheel.

The position integrator and velocity capture can be independently enabled, though the position integrator must be enabled before the velocity capture can be enabled. The two phase signals, PhA and PhB, can be swapped before being interpreted by the QEI module to change the meaning of forward and backward and to correct for miswiring of the system. Alternatively, the phase signals can be interpreted as a clock and direction signal as output by some encoders.

The QEI module input signals have a digital noise filter on them that can be enabled to prevent spurious operation. The noise filter requires that the inputs be stable for a specified number of consecutive clock cycles before updating the edge detector. The filter is enabled by the `FILTEN` bit in the **QEI Control (QEICTL)** register. The frequency of the input update is programmable using the `FILTCNT` bit field in the **QEICTL** register.



The period of the timer is configurable by specifying the load value for the timer in the **QEI Timer Load (QEILOAD)** register. When the timer reaches zero, an interrupt can be triggered, and the hardware reloads the timer with the **QEILOAD** value and continues to count down. At lower encoder speeds, a longer timer period is required to be able to capture enough edges to have a meaningful result. At higher encoder speeds, both a shorter timer period and/or the velocity predivider can be used.

The following equation converts the velocity counter value into an rpm value:

$$\text{rpm} = (\text{clock} * (2 \wedge \text{VELDIV}) * \text{SPEED} * 60) \div (\text{LOAD} * \text{ppr} * \text{edges})$$

where:

`clock` is the controller clock rate

`ppr` is the number of pulses per revolution of the physical encoder

`edges` is 2 or 4, based on the capture mode set in the **QEICTL** register (2 for `CAPMODE` clear and 4 for `CAPMODE` set)

For example, consider a motor running at 600 rpm. A 2048 pulse per revolution quadrature encoder is attached to the motor, producing 8192 phase edges per revolution. With a velocity predivider of  $\div 1$  (`VELDIV` is clear) and clocking on both `PhA` and `PhB` edges, this results in 81,920 pulses per second (the motor turns 10 times per second). If the timer were clocked at 10,000 Hz, and the load value was 2,500 ( $\frac{1}{4}$  of a second), it would count 20,480 pulses per update. Using the above equation:

$$\text{rpm} = (10000 * 1 * 20480 * 60) \div (2500 * 2048 * 4) = 600 \text{ rpm}$$

Now, consider that the motor is sped up to 3000 rpm. This results in 409,600 pulses per second, or 102,400 every  $\frac{1}{4}$  of a second. Again, the above equation gives:

$$\text{rpm} = (10000 * 1 * 102400 * 60) \div (2500 * 2048 * 4) = 3000 \text{ rpm}$$

Care must be taken when evaluating this equation because intermediate values may exceed the capacity of a 32-bit integer. In the above examples, the clock is 10,000 and the divisor is 2,500; both could be predivided by 100 (at compile time if they are constants) and therefore be 100 and 25. In fact, if they were compile-time constants, they could also be reduced to a simple multiply by 4, cancelled by the  $\div 4$  for the edge-count factor.

---

**Important:** Reducing constant factors at compile time is the best way to control the intermediate values of this equation and reduce the processing requirement of computing this equation.

---

The division can be avoided by selecting a timer load value such that the divisor is a power of 2; a simple shift can therefore be done in place of the division. For encoders with a power of 2 pulses per revolution, the load value can be a power of 2. For other encoders, a load value must be selected such that the product is very close to a power of 2. For example, a 100 pulse-per-revolution encoder could use a load value of 82, resulting in 32,800 as the divisor, which is 0.09% above  $2^{14}$ . In this case a shift by 15 would be an adequate approximation of the divide in most cases. If absolute accuracy were required, the microcontroller's divide instruction could be used.

The QEI module can produce a controller interrupt on several events: phase error, direction change, reception of the index pulse, and expiration of the velocity timer. Standard masking, raw interrupt status, interrupt status, and interrupt clear capabilities are provided.

## 23.4 Initialization and Configuration

The following example shows how to configure the Quadrature Encoder module to read back an absolute position:

1. Enable the QEI clock by writing a value of 0x0000.0100 to the **RCGC1** register in the System Control module (see page 181).
2. Enable the clock to the appropriate GPIO module via the **RCGC2** register in the System Control module (see page 193).
3. In the GPIO module, enable the appropriate pins for their alternate function using the **GPIOAFSEL** register. To determine which GPIOs to configure, see Table 25-4 on page 1151.
4. Configure the **PMC<sub>n</sub>** fields in the **GPIOPCTL** register to assign the QEI signals to the appropriate pins (see page 346 and Table 25-5 on page 1160).
5. Configure the quadrature encoder to capture edges on both signals and maintain an absolute position by resetting on index pulses. A 1000-line encoder with four edges per line, results in 4000 pulses per revolution; therefore, set the maximum position to 3999 (0xF9F) as the count is zero-based.
  - Write the **QEICTL** register with the value of 0x0000.0018.
  - Write the **QEIMAXPOS** register with the value of 0x0000.0F9F.
6. Enable the quadrature encoder by setting bit 0 of the **QEICTL** register.
7. Delay until the encoder position is required.
8. Read the encoder position by reading the **QEI Position (QEIPOS)** register value.

## 23.5 Register Map

Table 23-3 on page 1109 lists the QEI registers. The offset listed is a hexadecimal increment to the register's address, relative to the module's base address:

- QEI0: 0x4002.C000
- QEI1: 0x4002.D000

Note that the QEI module clock must be enabled before the registers can be programmed (see page 181).

**Table 23-3. QEI Register Map**

Offset	Name	Type	Reset	Description	See page
0x000	QEICTL	R/W	0x0000.0000	QEI Control	1111
0x004	QEISTAT	RO	0x0000.0000	QEI Status	1114
0x008	QEIPOS	R/W	0x0000.0000	QEI Position	1115
0x00C	QEIMAXPOS	R/W	0x0000.0000	QEI Maximum Position	1116
0x010	QEILOAD	R/W	0x0000.0000	QEI Timer Load	1117
0x014	QEITIME	RO	0x0000.0000	QEI Timer	1118
0x018	QEICOUNT	RO	0x0000.0000	QEI Velocity Counter	1119
0x01C	QEISPEED	RO	0x0000.0000	QEI Velocity	1120

**Table 23-3. QEI Register Map (continued)**

Offset	Name	Type	Reset	Description	See page
0x020	QEIINTEN	R/W	0x0000.0000	QEI Interrupt Enable	1121
0x024	QEIRIS	RO	0x0000.0000	QEI Raw Interrupt Status	1123
0x028	QEIISC	R/W1C	0x0000.0000	QEI Interrupt Status and Clear	1125

## 23.6 Register Descriptions

The remainder of this section lists and describes the QEI registers, in numerical order by address offset.

## Register 1: QEI Control (QEICTL), offset 0x000

This register contains the configuration of the QEI module. Separate enables are provided for the quadrature encoder and the velocity capture blocks; the quadrature encoder must be enabled in order to capture the velocity, but the velocity does not need to be captured in applications that do not need it. The phase signal interpretation, phase swap, Position Update mode, Position Reset mode, and velocity predivider are all set via this register.

### QEI Control (QEICTL)

QEI0 base: 0x4002.C000

QEI1 base: 0x4002.D000

Offset 0x000

Type R/W, reset 0x0000.0000

	31	30	29	28	27	26	25	24	23	22	21	20	19	18	17	16
	reserved												FILTCNT			
Type	RO	RO	RO	RO	RO	RO	RO	RO	RO	RO	RO	RO	R/W	R/W	R/W	R/W
Reset	0	0	0	0	0	0	0	0	0	0	0	0	0	0	0	0
	15	14	13	12	11	10	9	8	7	6	5	4	3	2	1	0
	reserved		FILTEN	STALLEN	INVI	INVB	INVA	VELDIV			VELEN	RESMODE	CAPMODE	SIGMODE	SWAP	ENABLE
Type	RO	RO	R/W	R/W	R/W	R/W	R/W	R/W	R/W	R/W	R/W	R/W	R/W	R/W	R/W	R/W
Reset	0	0	0	0	0	0	0	0	0	0	0	0	0	0	0	0

Bit/Field	Name	Type	Reset	Description
31:20	reserved	RO	0x000	Software should not rely on the value of a reserved bit. To provide compatibility with future products, the value of a reserved bit should be preserved across a read-modify-write operation.
19:16	FILTCNT	R/W	0x0	Input Filter Prescale Count  This field controls the frequency of the input update.  When this field is clear, the input is sampled after 2 system clocks. When this field is 0x1, the input is sampled after 3 system clocks. Similarly, when this field is 0xF, the input is sampled after 17 clocks.
15:14	reserved	RO	0x0	Software should not rely on the value of a reserved bit. To provide compatibility with future products, the value of a reserved bit should be preserved across a read-modify-write operation.
13	FILTEN	R/W	0	Enable Input Filter  Value Description 0 The QEI inputs are not filtered. 1 Enables the digital noise filter on the QEI input signals. Inputs must be stable for 3 consecutive clock edges before the edge detector is updated.
12	STALLEN	R/W	0	Stall QEI  Value Description 0 The QEI module does not stall when the microcontroller is stopped by a debugger. 1 The QEI module stalls when the microcontroller is stopped by a debugger.

Bit/Field	Name	Type	Reset	Description
11	INVI	R/W	0	<p>Invert Index Pulse</p> <p>Value Description</p> <p>0 No effect.</p> <p>1 Inverts the <code>IDX</code> input.</p>
10	INVB	R/W	0	<p>Invert PhB</p> <p>Value Description</p> <p>0 No effect.</p> <p>1 Inverts the <code>PhB</code> input.</p>
9	INVA	R/W	0	<p>Invert PhA</p> <p>Value Description</p> <p>0 No effect.</p> <p>1 Inverts the <code>PhA</code> input.</p>
8:6	VELDIV	R/W	0x0	<p>Predivide Velocity</p> <p>This field defines the predivider of the input quadrature pulses before being applied to the <code>QEICOUNT</code> accumulator.</p> <p>Value Predivider</p> <p>0x0 +1</p> <p>0x1 +2</p> <p>0x2 +4</p> <p>0x3 +8</p> <p>0x4 +16</p> <p>0x5 +32</p> <p>0x6 +64</p> <p>0x7 +128</p>
5	VELEN	R/W	0	<p>Capture Velocity</p> <p>Value Description</p> <p>0 No effect.</p> <p>1 Enables capture of the velocity of the quadrature encoder.</p>
4	RESMODE	R/W	0	<p>Reset Mode</p> <p>Value Description</p> <p>0 The position counter is reset when it reaches the maximum as defined by the <code>MAXPOS</code> field in the <code>QEIMAXPOS</code> register.</p> <p>1 The position counter is reset when the index pulse is captured.</p>



Bit/Field	Name	Type	Reset	Description
3	CAPMODE	R/W	0	Capture Mode  Value Description 0 Only the $P_{hA}$ edges are counted. 1 The $P_{hA}$ and $P_{hB}$ edges are counted, providing twice the positional resolution but half the range.
2	SIGMODE	R/W	0	Signal Mode  Value Description 0 The $P_{hA}$ and $P_{hB}$ signals operate as quadrature phase signals. 1 The $P_{hA}$ and $P_{hB}$ signals operate as clock and direction.
1	SWAP	R/W	0	Swap Signals  Value Description 0 No effect. 1 Swaps the $P_{hA}$ and $P_{hB}$ signals.
0	ENABLE	R/W	0	Enable QEI  Value Description 0 No effect. 1 Enables the quadrature encoder module.

## Register 2: QEI Status (QEISTAT), offset 0x004

This register provides status about the operation of the QEI module.

### QEI Status (QEISTAT)

QEI0 base: 0x4002.C000

QEI1 base: 0x4002.D000

Offset 0x004

Type RO, reset 0x0000.0000

	31	30	29	28	27	26	25	24	23	22	21	20	19	18	17	16	
	reserved																
Type	RO	RO	RO	RO	RO	RO	RO	RO	RO	RO	RO	RO	RO	RO	RO	RO	
Reset	0	0	0	0	0	0	0	0	0	0	0	0	0	0	0	0	
	15	14	13	12	11	10	9	8	7	6	5	4	3	2	1	0	
	reserved															DIRECTION	ERROR
Type	RO	RO	RO	RO	RO	RO	RO	RO	RO	RO	RO	RO	RO	RO	RO	RO	RO
Reset	0	0	0	0	0	0	0	0	0	0	0	0	0	0	0	0	0

Bit/Field	Name	Type	Reset	Description
31:2	reserved	RO	0x0000.000	Software should not rely on the value of a reserved bit. To provide compatibility with future products, the value of a reserved bit should be preserved across a read-modify-write operation.
1	DIRECTION	RO	0	Direction of Rotation Indicates the direction the encoder is rotating.  Value Description 0 The encoder is rotating forward. 1 The encoder is rotating in reverse.
0	ERROR	RO	0	Error Detected  Value Description 0 No error. 1 An error was detected in the gray code sequence (that is, both signals changing at the same time).

**Register 3: QEI Position (QEIP0S), offset 0x008**

This register contains the current value of the position integrator. The value is updated by the status of the QEI phase inputs and can be set to a specific value by writing to it.

**QEI Position (QEIP0S)**

QEI0 base: 0x4002.C000

QEI1 base: 0x4002.D000

Offset 0x008

Type R/W, reset 0x0000.0000

	31	30	29	28	27	26	25	24	23	22	21	20	19	18	17	16
	POSITION															
Type	R/W	R/W	R/W	R/W	R/W	R/W	R/W	R/W	R/W	R/W	R/W	R/W	R/W	R/W	R/W	R/W
Reset	0	0	0	0	0	0	0	0	0	0	0	0	0	0	0	0
	15	14	13	12	11	10	9	8	7	6	5	4	3	2	1	0
	POSITION															
Type	R/W	R/W	R/W	R/W	R/W	R/W	R/W	R/W	R/W	R/W	R/W	R/W	R/W	R/W	R/W	R/W
Reset	0	0	0	0	0	0	0	0	0	0	0	0	0	0	0	0

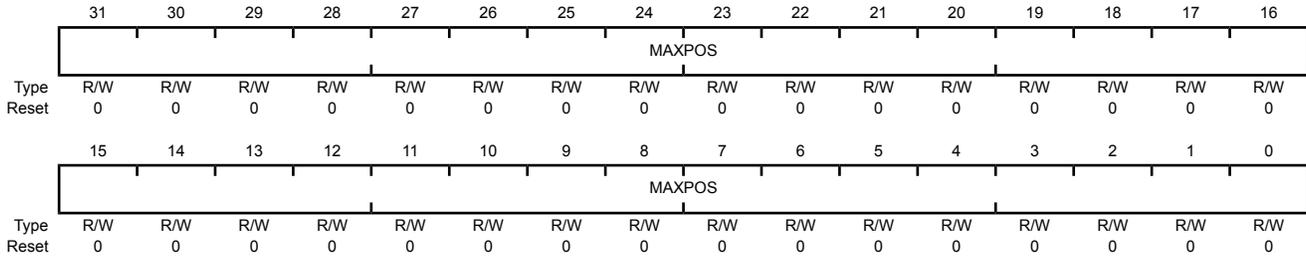
Bit/Field	Name	Type	Reset	Description
31:0	POSITION	R/W	0x0000.0000	Current Position Integrator Value The current value of the position integrator.

**Register 4: QEI Maximum Position (QEIMAXPOS), offset 0x00C**

This register contains the maximum value of the position integrator. When moving forward, the position register resets to zero when it increments past this value. When moving in reverse, the position register resets to this value when it decrements from zero.

QEI Maximum Position (QEIMAXPOS)

QEI0 base: 0x4002.C000  
 QEI1 base: 0x4002.D000  
 Offset 0x00C  
 Type R/W, reset 0x0000.0000



Bit/Field	Name	Type	Reset	Description
31:0	MAXPOS	R/W	0x0000.0000	Maximum Position Integrator Value The maximum value of the position integrator.

**Register 5: QEI Timer Load (QEILOAD), offset 0x010**

This register contains the load value for the velocity timer. Because this value is loaded into the timer on the clock cycle after the timer is zero, this value should be one less than the number of clocks in the desired period. So, for example, to have 2000 decimal clocks per timer period, this register should contain 1999 decimal.

**QEI Timer Load (QEILOAD)**

QEI0 base: 0x4002.C000

QEI1 base: 0x4002.D000

Offset 0x010

Type R/W, reset 0x0000.0000

	31	30	29	28	27	26	25	24	23	22	21	20	19	18	17	16
	LOAD															
Type	R/W	R/W	R/W	R/W	R/W	R/W	R/W	R/W	R/W	R/W	R/W	R/W	R/W	R/W	R/W	R/W
Reset	0	0	0	0	0	0	0	0	0	0	0	0	0	0	0	0
	15	14	13	12	11	10	9	8	7	6	5	4	3	2	1	0
	LOAD															
Type	R/W	R/W	R/W	R/W	R/W	R/W	R/W	R/W	R/W	R/W	R/W	R/W	R/W	R/W	R/W	R/W
Reset	0	0	0	0	0	0	0	0	0	0	0	0	0	0	0	0

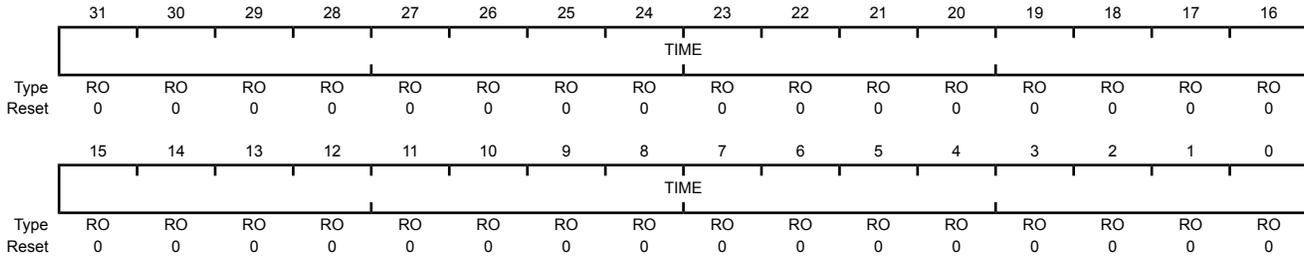
Bit/Field	Name	Type	Reset	Description
31:0	LOAD	R/W	0x0000.0000	Velocity Timer Load Value The load value for the velocity timer.

**Register 6: QEI Timer (QEITIME), offset 0x014**

This register contains the current value of the velocity timer. This counter does not increment when the VELEN bit in the QEICTL register is clear.

QEI Timer (QEITIME)

QEI0 base: 0x4002.C000  
 QEI1 base: 0x4002.D000  
 Offset 0x014  
 Type RO, reset 0x0000.0000



Bit/Field	Name	Type	Reset	Description
31:0	TIME	RO	0x0000.0000	Velocity Timer Current Value The current value of the velocity timer.

## Register 7: QEI Velocity Counter (QEICOUNT), offset 0x018

This register contains the running count of velocity pulses for the current time period. Because this count is a running total, the time period to which it applies cannot be known with precision (that is, a read of this register does not necessarily correspond to the time returned by the **QEITIME** register because there is a small window of time between the two reads, during which either value may have changed). The **QEISPEED** register should be used to determine the actual encoder velocity; this register is provided for information purposes only. This counter does not increment when the **VELEN** bit in the **QEICTL** register is clear.

### QEI Velocity Counter (QEICOUNT)

QEI0 base: 0x4002.C000

QEI1 base: 0x4002.D000

Offset 0x018

Type RO, reset 0x0000.0000

	31	30	29	28	27	26	25	24	23	22	21	20	19	18	17	16
	COUNT															
Type	RO	RO	RO	RO	RO	RO	RO	RO	RO	RO	RO	RO	RO	RO	RO	RO
Reset	0	0	0	0	0	0	0	0	0	0	0	0	0	0	0	0
	15	14	13	12	11	10	9	8	7	6	5	4	3	2	1	0
	COUNT															
Type	RO	RO	RO	RO	RO	RO	RO	RO	RO	RO	RO	RO	RO	RO	RO	RO
Reset	0	0	0	0	0	0	0	0	0	0	0	0	0	0	0	0

Bit/Field	Name	Type	Reset	Description
31:0	COUNT	RO	0x0000.0000	Velocity Pulse Count

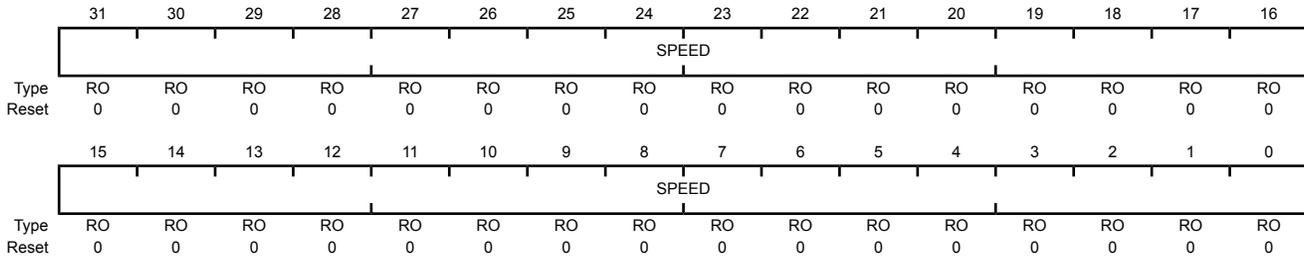
The running total of encoder pulses during this velocity timer period.

### Register 8: QEI Velocity (QEISPEED), offset 0x01C

This register contains the most recently measured velocity of the quadrature encoder. This value corresponds to the number of velocity pulses counted in the previous velocity timer period. This register does not update when the `VELEN` bit in the `QEICTL` register is clear.

#### QEI Velocity (QEISPEED)

QEI0 base: 0x4002.C000  
 QEI1 base: 0x4002.D000  
 Offset 0x01C  
 Type RO, reset 0x0000.0000



Bit/Field	Name	Type	Reset	Description
31:0	SPEED	RO	0x0000.0000	Velocity

The measured speed of the quadrature encoder in pulses per period.



**Register 9: QEI Interrupt Enable (QEIINTEN), offset 0x020**

This register contains enables for each of the QEI module interrupts. An interrupt is asserted to the interrupt controller if the corresponding bit in this register is set.

**QEI Interrupt Enable (QEIINTEN)**

QEI0 base: 0x4002.C000

QEI1 base: 0x4002.D000

Offset 0x020

Type R/W, reset 0x0000.0000

	31	30	29	28	27	26	25	24	23	22	21	20	19	18	17	16	
	reserved																
Type	RO	RO	RO	RO	RO	RO	RO	RO	RO	RO	RO	RO	RO	RO	RO	RO	
Reset	0	0	0	0	0	0	0	0	0	0	0	0	0	0	0	0	
	15	14	13	12	11	10	9	8	7	6	5	4	3	2	1	0	
	reserved												INTERROR	INTDIR	INTTIMER	INTINDEX	
Type	RO	RO	RO	RO	RO	RO	RO	RO	RO	RO	RO	RO	RO	R/W	R/W	R/W	R/W
Reset	0	0	0	0	0	0	0	0	0	0	0	0	0	0	0	0	0

Bit/Field	Name	Type	Reset	Description
31:4	reserved	RO	0x0000.000	Software should not rely on the value of a reserved bit. To provide compatibility with future products, the value of a reserved bit should be preserved across a read-modify-write operation.
3	INTERROR	R/W	0	Phase Error Interrupt Enable  Value Description 1 An interrupt is sent to the interrupt controller when the <b>INTERROR</b> bit in the <b>QEIRIS</b> register is set. 0 The <b>INTERROR</b> interrupt is suppressed and not sent to the interrupt controller.
2	INTDIR	R/W	0	Direction Change Interrupt Enable  Value Description 1 An interrupt is sent to the interrupt controller when the <b>INTDIR</b> bit in the <b>QEIRIS</b> register is set. 0 The <b>INTDIR</b> interrupt is suppressed and not sent to the interrupt controller.
1	INTTIMER	R/W	0	Timer Expires Interrupt Enable  Value Description 1 An interrupt is sent to the interrupt controller when the <b>INTTIMER</b> bit in the <b>QEIRIS</b> register is set. 0 The <b>INTTIMER</b> interrupt is suppressed and not sent to the interrupt controller.

Bit/Field	Name	Type	Reset	Description
0	INTINDEX	R/W	0	Index Pulse Detected Interrupt Enable
				Value Description
				1 An interrupt is sent to the interrupt controller when the INTINDEX bit in the <b>QEIRIS</b> register is set.
				0 The INTINDEX interrupt is suppressed and not sent to the interrupt controller.

## Register 10: QEI Raw Interrupt Status (QEIRIS), offset 0x024

This register provides the current set of interrupt sources that are asserted, regardless of whether they cause an interrupt to be asserted to the controller (configured through the **QEINTEN** register). If a bit is set, the latched event has occurred; if a bit is clear, the event in question has not occurred.

### QEI Raw Interrupt Status (QEIRIS)

QEI0 base: 0x4002.C000  
QEI1 base: 0x4002.D000  
Offset 0x024  
Type RO, reset 0x0000.0000

	31	30	29	28	27	26	25	24	23	22	21	20	19	18	17	16
	reserved															
Type	RO	RO	RO	RO	RO	RO	RO	RO	RO	RO	RO	RO	RO	RO	RO	RO
Reset	0	0	0	0	0	0	0	0	0	0	0	0	0	0	0	0
	15	14	13	12	11	10	9	8	7	6	5	4	3	2	1	0
	reserved												INTERROR	INTDIR	INTTIMER	INTINDEX
Type	RO	RO	RO	RO	RO	RO	RO	RO	RO	RO	RO	RO	RO	RO	RO	RO
Reset	0	0	0	0	0	0	0	0	0	0	0	0	0	0	0	0

Bit/Field	Name	Type	Reset	Description
31:4	reserved	RO	0x0000.000	Software should not rely on the value of a reserved bit. To provide compatibility with future products, the value of a reserved bit should be preserved across a read-modify-write operation.
3	INTERROR	RO	0	Phase Error Detected  Value Description 1 A phase error has been detected. 0 An interrupt has not occurred.  This bit is cleared by writing a 1 to the <code>INTERROR</code> bit in the <b>QEISC</b> register.
2	INTDIR	RO	0	Direction Change Detected  Value Description 1 The rotation direction has changed 0 An interrupt has not occurred.  This bit is cleared by writing a 1 to the <code>INTDIR</code> bit in the <b>QEISC</b> register.
1	INTTIMER	RO	0	Velocity Timer Expired  Value Description 1 The velocity timer has expired. 0 An interrupt has not occurred.  This bit is cleared by writing a 1 to the <code>INTTIMER</code> bit in the <b>QEISC</b> register.

Bit/Field	Name	Type	Reset	Description
0	INTINDEX	RO	0	Index Pulse Asserted
				Value Description
				1 The index pulse has occurred.
				0 An interrupt has not occurred.
				This bit is cleared by writing a 1 to the INTINDEX bit in the <b>QEISC</b> register.

## Register 11: QEI Interrupt Status and Clear (QEIISC), offset 0x028

This register provides the current set of interrupt sources that are asserted to the controller. If a bit is set, the latched event has occurred and is enabled to generate an interrupt; if a bit is clear the event in question has not occurred or is not enabled to generate an interrupt. This register is R/W1C; writing a 1 to a bit position clears the bit and the corresponding interrupt reason.

### QEI Interrupt Status and Clear (QEIISC)

QEI0 base: 0x4002.C000

QEI1 base: 0x4002.D000

Offset 0x028

Type R/W1C, reset 0x0000.0000

	31	30	29	28	27	26	25	24	23	22	21	20	19	18	17	16	
	reserved																
Type	RO	RO	RO	RO	RO	RO	RO	RO	RO	RO	RO	RO	RO	RO	RO	RO	
Reset	0	0	0	0	0	0	0	0	0	0	0	0	0	0	0	0	
	15	14	13	12	11	10	9	8	7	6	5	4	3	2	1	0	
	reserved												INTERROR	INTDIR	INTTIMER	INTINDEX	
Type	RO	RO	RO	RO	RO	RO	RO	RO	RO	RO	RO	RO	RO	R/W1C	R/W1C	R/W1C	R/W1C
Reset	0	0	0	0	0	0	0	0	0	0	0	0	0	0	0	0	0

Bit/Field	Name	Type	Reset	Description
31:4	reserved	RO	0x0000.000	Software should not rely on the value of a reserved bit. To provide compatibility with future products, the value of a reserved bit should be preserved across a read-modify-write operation.
3	INTERROR	R/W1C	0	Phase Error Interrupt  Value Description 1 The <b>INTERROR</b> bits in the <b>QEIRIS</b> register and the <b>QEINTEN</b> registers are set, providing an interrupt to the interrupt controller. 0 No interrupt has occurred or the interrupt is masked.  This bit is cleared by writing a 1. Clearing this bit also clears the <b>INTERROR</b> bit in the <b>QEIRIS</b> register.
2	INTDIR	R/W1C	0	Direction Change Interrupt  Value Description 1 The <b>INTDIR</b> bits in the <b>QEIRIS</b> register and the <b>QEINTEN</b> registers are set, providing an interrupt to the interrupt controller. 0 No interrupt has occurred or the interrupt is masked.  This bit is cleared by writing a 1. Clearing this bit also clears the <b>INTDIR</b> bit in the <b>QEIRIS</b> register.
1	INTTIMER	R/W1C	0	Velocity Timer Expired Interrupt  Value Description 1 The <b>INTTIMER</b> bits in the <b>QEIRIS</b> register and the <b>QEINTEN</b> registers are set, providing an interrupt to the interrupt controller. 0 No interrupt has occurred or the interrupt is masked.  This bit is cleared by writing a 1. Clearing this bit also clears the <b>INTTIMER</b> bit in the <b>QEIRIS</b> register.

Bit/Field	Name	Type	Reset	Description
0	INTINDEX	R/W1C	0	Index Pulse Interrupt
				Value Description
				1 The <code>INTINDEX</code> bits in the <b>QEIRIS</b> register and the <b>QEINTEN</b> registers are set, providing an interrupt to the interrupt controller.
				0 No interrupt has occurred or the interrupt is masked.
				This bit is cleared by writing a 1. Clearing this bit also clears the <code>INTINDEX</code> bit in the <b>QEIRIS</b> register.

# 24 Pin Diagram

The LM3S9B96 microcontroller pin diagrams are shown below.

Each GPIO signal is identified by its GPIO port unless it defaults to an alternate function on reset. In this case, the GPIO port name is followed by the default alternate function. To see a complete list of possible functions for each pin, see Table 25-5 on page 1160.

Figure 24-1. 100-Pin LQFP Package Pin Diagram

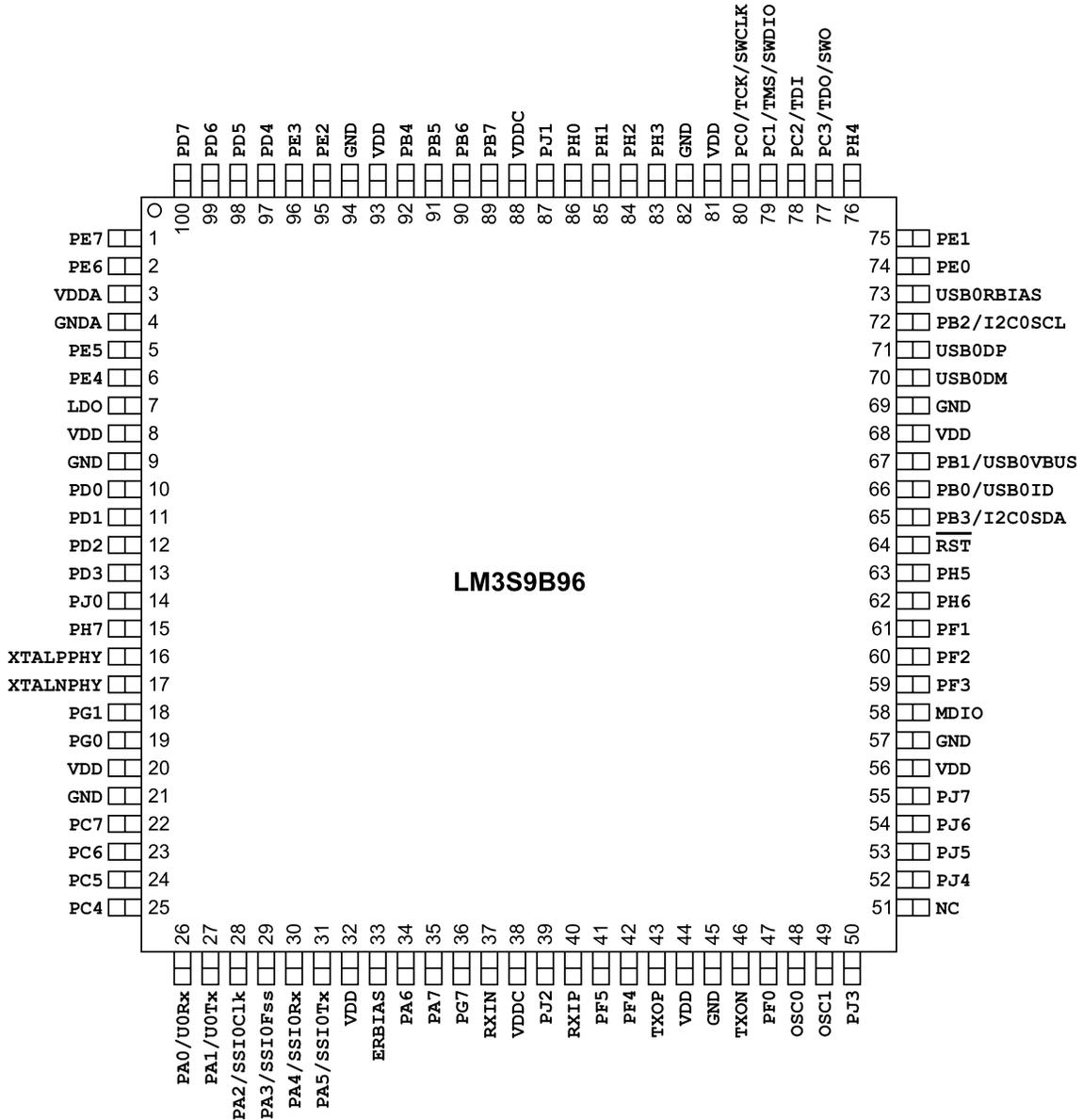
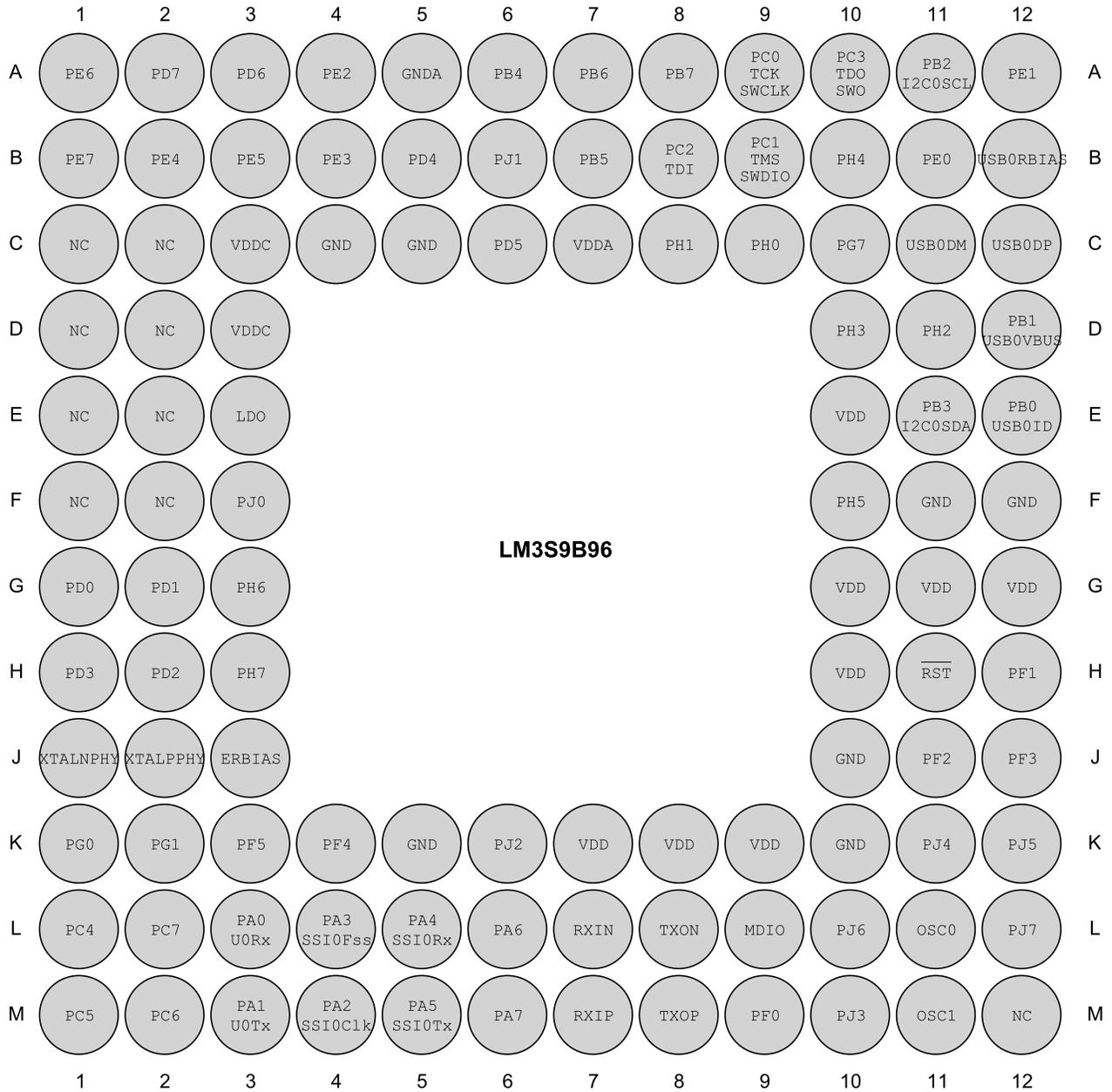


Figure 24-2. 108-Ball BGA Package Pin Diagram (Top View)





## 25 Signal Tables

The following tables list the signals available for each pin. Signals are configured as GPIOs on reset, except for those noted below. Use the **GPIOAMSEL** register (see page 344) to select analog mode. For a GPIO pin to be used for an alternate digital function, the corresponding bit in the **GPIOAFSEL** register (see page 328) must be set. Further pin muxing options are provided through the  $PMC_x$  bit field in the **GPIOPCTL** register (see page 346), which selects one of several available peripheral functions for that GPIO.

**Important:** All GPIO pins are configured as GPIOs by default with the exception of the pins shown in the table below. A Power-On-Reset ( $\overline{POR}$ ) or asserting  $\overline{RST}$  puts the pins back to their default state.

**Table 25-1. GPIO Pins With Default Alternate Functions**

GPIO Pin	Default State	GPIOAFSEL Bit	GPIOPCTL $PMC_x$ Bit Field
PA[1:0]	UART0	1	0x1
PA[5:2]	SSI0	1	0x1
PB[3:2]	I <sup>2</sup> C0	1	0x1
PC[3:0]	JTAG/SWD	1	0x3

Table 25-2 on page 1130 shows the pin-to-signal-name mapping, including functional characteristics of the signals. Each possible alternate analog and digital function is listed for each pin.

Table 25-3 on page 1141 lists the signals in alphabetical order by signal name. If it is possible for a signal to be on multiple pins, each possible pin assignment is listed. The "Pin Mux" column indicates the GPIO and the encoding needed in the  $PMC_x$  bit field in the **GPIOPCTL** register.

Table 25-4 on page 1151 groups the signals by functionality, except for GPIOs. If it is possible for a signal to be on multiple pins, each possible pin assignment is listed.

Table 25-5 on page 1160 lists the GPIO pins and their analog and digital alternate functions. The  $A_{INx}$  and  $V_{REFA}$  analog signals are not 5-V tolerant and go through an isolation circuit before reaching their circuitry. These signals are configured by clearing the corresponding  $DEN$  bit in the **GPIO Digital Enable (GPIODEN)** register and setting the corresponding  $AMSEL$  bit in the **GPIO Analog Mode Select (GPIOAMSEL)** register. Other analog signals are 5-V tolerant and are connected directly to their circuitry ( $C0-$ ,  $C0+$ ,  $C1-$ ,  $C1+$ ,  $C2-$ ,  $C2+$ ,  $USB0VBUS$ ,  $USB0ID$ ). These signals are configured by clearing the  $DEN$  bit in the **GPIO Digital Enable (GPIODEN)** register. The digital signals are enabled by setting the appropriate bit in the **GPIO Alternate Function Select (GPIOAFSEL)** and **GPIODEN** registers and configuring the  $PMC_x$  bit field in the **GPIO Port Control (GPIOPCTL)** register to the numeric encoding shown in the table below. Table entries that are shaded gray are the default values for the corresponding GPIO pin.

Table 25-6 on page 1163 lists the signals based on number of possible pin assignments. This table can be used to plan how to configure the pins for a particular functionality. Application Note AN01274 Configuring Stellaris® Microcontrollers with Pin Multiplexing provides an overview of the pin muxing implementation, an explanation of how a system designer defines a pin configuration, and examples of the pin configuration process.

## 25.1 100-Pin LQFP Package Pin Tables

Table 25-2. Signals by Pin Number

Pin Number	Pin Name	Pin Type	Buffer Type <sup>a</sup>	Description
1	PE7	I/O	TTL	GPIO port E bit 7.
	AIN0	I	Analog	Analog-to-digital converter input 0.
	C2o	O	TTL	Analog comparator 2 output.
	PWM5	O	TTL	PWM 5. This signal is controlled by PWM Generator 2.
	U1DCD	I	TTL	UART module 1 Data Carrier Detect modem status input signal.
2	PE6	I/O	TTL	GPIO port E bit 6.
	AIN1	I	Analog	Analog-to-digital converter input 1.
	C1o	O	TTL	Analog comparator 1 output.
	PWM4	O	TTL	PWM 4. This signal is controlled by PWM Generator 2.
	U1CTS	I	TTL	UART module 1 Clear To Send modem status input signal.
3	VDDA	-	Power	The positive supply (3.3 V) for the analog circuits (ADC, Analog Comparators, etc.). These are separated from VDD to minimize the electrical noise contained on VDD from affecting the analog functions. VDDA pins must be connected to 3.3 V, regardless of system implementation.
4	GNDA	-	Power	The ground reference for the analog circuits (ADC, Analog Comparators, etc.). These are separated from GND to minimize the electrical noise contained on VDD from affecting the analog functions.
5	PE5	I/O	TTL	GPIO port E bit 5.
	AIN2	I	Analog	Analog-to-digital converter input 2.
	CCP5	I/O	TTL	Capture/Compare/PWM 5.
	I2S0TXSD	I/O	TTL	I <sup>2</sup> S module 0 transmit data.
6	PE4	I/O	TTL	GPIO port E bit 4.
	AIN3	I	Analog	Analog-to-digital converter input 3.
	CCP2	I/O	TTL	Capture/Compare/PWM 2.
	CCP3	I/O	TTL	Capture/Compare/PWM 3.
	Fault0	I	TTL	PWM Fault 0.
	I2S0TXWS	I/O	TTL	I <sup>2</sup> S module 0 transmit word select.
	U2Tx	O	TTL	UART module 2 transmit. When in IrDA mode, this signal has IrDA modulation.
7	LDO	-	Power	Low drop-out regulator output voltage. This pin requires an external capacitor between the pin and GND of 1 $\mu$ F or greater. When the on-chip LDO is used to provide power to the logic, the LDO pin must also be connected to the VDDC pins at the board level in addition to the decoupling capacitor(s).
8	VDD	-	Power	Positive supply for I/O and some logic.
9	GND	-	Power	Ground reference for logic and I/O pins.

Table 25-2. Signals by Pin Number (continued)

Pin Number	Pin Name	Pin Type	Buffer Type <sup>a</sup>	Description
10	PD0	I/O	TTL	GPIO port D bit 0.
	AIN15	I	Analog	Analog-to-digital converter input 15.
	CAN0Rx	I	TTL	CAN module 0 receive.
	CCP6	I/O	TTL	Capture/Compare/PWM 6.
	I2S0RXSCK	I/O	TTL	I <sup>2</sup> S module 0 receive clock.
	IDX0	I	TTL	QEI module 0 index.
	PWM0	O	TTL	PWM 0. This signal is controlled by PWM Generator 0.
	U1CTS	I	TTL	UART module 1 Clear To Send modem status input signal.
	U1Rx	I	TTL	UART module 1 receive. When in IrDA mode, this signal has IrDA modulation.
	U2Rx	I	TTL	UART module 2 receive. When in IrDA mode, this signal has IrDA modulation.
11	PD1	I/O	TTL	GPIO port D bit 1.
	AIN14	I	Analog	Analog-to-digital converter input 14.
	CAN0Tx	O	TTL	CAN module 0 transmit.
	CCP2	I/O	TTL	Capture/Compare/PWM 2.
	CCP7	I/O	TTL	Capture/Compare/PWM 7.
	I2S0RXWS	I/O	TTL	I <sup>2</sup> S module 0 receive word select.
	PWM1	O	TTL	PWM 1. This signal is controlled by PWM Generator 0.
	PhA0	I	TTL	QEI module 0 phase A.
	PhB1	I	TTL	QEI module 1 phase B.
	U1DCD	I	TTL	UART module 1 Data Carrier Detect modem status input signal.
	U1Tx	O	TTL	UART module 1 transmit. When in IrDA mode, this signal has IrDA modulation.
	U2Tx	O	TTL	UART module 2 transmit. When in IrDA mode, this signal has IrDA modulation.
12	PD2	I/O	TTL	GPIO port D bit 2.
	AIN13	I	Analog	Analog-to-digital converter input 13.
	CCP5	I/O	TTL	Capture/Compare/PWM 5.
	CCP6	I/O	TTL	Capture/Compare/PWM 6.
	EPI0S20	I/O	TTL	EPI module 0 signal 20.
	PWM2	O	TTL	PWM 2. This signal is controlled by PWM Generator 1.
	U1Rx	I	TTL	UART module 1 receive. When in IrDA mode, this signal has IrDA modulation.
13	PD3	I/O	TTL	GPIO port D bit 3.
	AIN12	I	Analog	Analog-to-digital converter input 12.
	CCP0	I/O	TTL	Capture/Compare/PWM 0.
	CCP7	I/O	TTL	Capture/Compare/PWM 7.
	EPI0S21	I/O	TTL	EPI module 0 signal 21.
	PWM3	O	TTL	PWM 3. This signal is controlled by PWM Generator 1.
	U1Tx	O	TTL	UART module 1 transmit. When in IrDA mode, this signal has IrDA modulation.

Table 25-2. Signals by Pin Number (continued)

Pin Number	Pin Name	Pin Type	Buffer Type <sup>a</sup>	Description
14	EPIOS16	I/O	TTL	EPI module 0 signal 16.
	I2C1SCL	I/O	OD	I <sup>2</sup> C module 1 clock.
	PJ0	I/O	TTL	GPIO port J bit 0.
	PWM0	O	TTL	PWM 0. This signal is controlled by PWM Generator 0.
15	PH7	I/O	TTL	GPIO port H bit 7.
	EPIOS27	I/O	TTL	EPI module 0 signal 27.
	PWM5	O	TTL	PWM 5. This signal is controlled by PWM Generator 2.
	SSI1Tx	O	TTL	SSI module 1 transmit.
16	XTALPPHY	I	Analog	Ethernet PHY XTALP 25-MHz oscillator crystal input.
17	XTALNPHY	O	Analog	Ethernet PHY XTALN 25-MHz oscillator crystal output.
18	PG1	I/O	TTL	GPIO port G bit 1.
	EPIOS14	I/O	TTL	EPI module 0 signal 14.
	I2C1SDA	I/O	OD	I <sup>2</sup> C module 1 data.
	PWM1	O	TTL	PWM 1. This signal is controlled by PWM Generator 0.
	PWM5	O	TTL	PWM 5. This signal is controlled by PWM Generator 2.
	U2Tx	O	TTL	UART module 2 transmit. When in IrDA mode, this signal has IrDA modulation.
19	PG0	I/O	TTL	GPIO port G bit 0.
	EPIOS13	I/O	TTL	EPI module 0 signal 13.
	I2C1SCL	I/O	OD	I <sup>2</sup> C module 1 clock.
	PWM0	O	TTL	PWM 0. This signal is controlled by PWM Generator 0.
	PWM4	O	TTL	PWM 4. This signal is controlled by PWM Generator 2.
	U2Rx	I	TTL	UART module 2 receive. When in IrDA mode, this signal has IrDA modulation.
	USB0EPEN	O	TTL	Optionally used in Host mode to control an external power source to supply power to the USB bus.
20	VDD	-	Power	Positive supply for I/O and some logic.
21	GND	-	Power	Ground reference for logic and I/O pins.
22	PC7	I/O	TTL	GPIO port C bit 7.
	C1o	O	TTL	Analog comparator 1 output.
	C2-	I	Analog	Analog comparator 2 negative input.
	CCP0	I/O	TTL	Capture/Compare/PWM 0.
	CCP4	I/O	TTL	Capture/Compare/PWM 4.
	EPIOS5	I/O	TTL	EPI module 0 signal 5.
	PhB0	I	TTL	QEI module 0 phase B.
	U1Tx	O	TTL	UART module 1 transmit. When in IrDA mode, this signal has IrDA modulation.
	USB0PFLT	I	TTL	Optionally used in Host mode by an external power source to indicate an error state by that power source.

Table 25-2. Signals by Pin Number (continued)

Pin Number	Pin Name	Pin Type	Buffer Type <sup>a</sup>	Description
23	PC6	I/O	TTL	GPIO port C bit 6.
	C2+	I	Analog	Analog comparator 2 positive input.
	C2o	O	TTL	Analog comparator 2 output.
	CCP0	I/O	TTL	Capture/Compare/PWM 0.
	CCP3	I/O	TTL	Capture/Compare/PWM 3.
	EPI0S4	I/O	TTL	EPI module 0 signal 4.
	PWM7	O	TTL	PWM 7. This signal is controlled by PWM Generator 3.
	PhB0	I	TTL	QEI module 0 phase B.
	U1Rx	I	TTL	UART module 1 receive. When in IrDA mode, this signal has IrDA modulation.
USB0PFLT	I	TTL	Optionally used in Host mode by an external power source to indicate an error state by that power source.	
24	PC5	I/O	TTL	GPIO port C bit 5.
	C0o	O	TTL	Analog comparator 0 output.
	C1+	I	Analog	Analog comparator 1 positive input.
	C1o	O	TTL	Analog comparator 1 output.
	CCP1	I/O	TTL	Capture/Compare/PWM 1.
	CCP3	I/O	TTL	Capture/Compare/PWM 3.
	EPI0S3	I/O	TTL	EPI module 0 signal 3.
	Fault2	I	TTL	PWM Fault 2.
	USB0EPEN	O	TTL	Optionally used in Host mode to control an external power source to supply power to the USB bus.
25	PC4	I/O	TTL	GPIO port C bit 4.
	CCP1	I/O	TTL	Capture/Compare/PWM 1.
	CCP2	I/O	TTL	Capture/Compare/PWM 2.
	CCP4	I/O	TTL	Capture/Compare/PWM 4.
	CCP5	I/O	TTL	Capture/Compare/PWM 5.
	EPI0S2	I/O	TTL	EPI module 0 signal 2.
	PWM6	O	TTL	PWM 6. This signal is controlled by PWM Generator 3.
	PhA0	I	TTL	QEI module 0 phase A.
26	PA0	I/O	TTL	GPIO port A bit 0.
	I2C1SCL	I/O	OD	I <sup>2</sup> C module 1 clock.
	U0Rx	I	TTL	UART module 0 receive. When in IrDA mode, this signal has IrDA modulation.
	U1Rx	I	TTL	UART module 1 receive. When in IrDA mode, this signal has IrDA modulation.
27	PA1	I/O	TTL	GPIO port A bit 1.
	I2C1SDA	I/O	OD	I <sup>2</sup> C module 1 data.
	U0Tx	O	TTL	UART module 0 transmit. When in IrDA mode, this signal has IrDA modulation.
	U1Tx	O	TTL	UART module 1 transmit. When in IrDA mode, this signal has IrDA modulation.

Table 25-2. Signals by Pin Number (continued)

Pin Number	Pin Name	Pin Type	Buffer Type <sup>a</sup>	Description
28	PA2	I/O	TTL	GPIO port A bit 2.
	I2S0RXSD	I/O	TTL	I <sup>2</sup> S module 0 receive data.
	PWM4	O	TTL	PWM 4. This signal is controlled by PWM Generator 2.
	SSI0Clk	I/O	TTL	SSI module 0 clock.
29	PA3	I/O	TTL	GPIO port A bit 3.
	I2S0XMCLK	I/O	TTL	I <sup>2</sup> S module 0 receive master clock.
	PWM5	O	TTL	PWM 5. This signal is controlled by PWM Generator 2.
	SSI0Fss	I/O	TTL	SSI module 0 frame.
30	PA4	I/O	TTL	GPIO port A bit 4.
	CAN0Rx	I	TTL	CAN module 0 receive.
	I2S0TXSCK	I/O	TTL	I <sup>2</sup> S module 0 transmit clock.
	PWM6	O	TTL	PWM 6. This signal is controlled by PWM Generator 3.
	SSI0Rx	I	TTL	SSI module 0 receive.
31	PA5	I/O	TTL	GPIO port A bit 5.
	CAN0Tx	O	TTL	CAN module 0 transmit.
	I2S0TXWS	I/O	TTL	I <sup>2</sup> S module 0 transmit word select.
	PWM7	O	TTL	PWM 7. This signal is controlled by PWM Generator 3.
	SSI0Tx	O	TTL	SSI module 0 transmit.
32	VDD	-	Power	Positive supply for I/O and some logic.
33	ERBIAS	O	Analog	12.4-kΩ resistor (1% precision) used internally for Ethernet PHY.
34	PA6	I/O	TTL	GPIO port A bit 6.
	CAN0Rx	I	TTL	CAN module 0 receive.
	CCP1	I/O	TTL	Capture/Compare/PWM 1.
	I2C1SCL	I/O	OD	I <sup>2</sup> C module 1 clock.
	PWM0	O	TTL	PWM 0. This signal is controlled by PWM Generator 0.
	PWM4	O	TTL	PWM 4. This signal is controlled by PWM Generator 2.
	U1CTS	I	TTL	UART module 1 Clear To Send modem status input signal.
	USB0EPEN	O	TTL	Optionally used in Host mode to control an external power source to supply power to the USB bus.
35	PA7	I/O	TTL	GPIO port A bit 7.
	CAN0Tx	O	TTL	CAN module 0 transmit.
	CCP3	I/O	TTL	Capture/Compare/PWM 3.
	CCP4	I/O	TTL	Capture/Compare/PWM 4.
	I2C1SDA	I/O	OD	I <sup>2</sup> C module 1 data.
	PWM1	O	TTL	PWM 1. This signal is controlled by PWM Generator 0.
	PWM5	O	TTL	PWM 5. This signal is controlled by PWM Generator 2.
	U1DCD	I	TTL	UART module 1 Data Carrier Detect modem status input signal.
	USB0PFLT	I	TTL	Optionally used in Host mode by an external power source to indicate an error state by that power source.

Table 25-2. Signals by Pin Number (continued)

Pin Number	Pin Name	Pin Type	Buffer Type <sup>a</sup>	Description
36	PG7	I/O	TTL	GPIO port G bit 7.
	CCP5	I/O	TTL	Capture/Compare/PWM 5.
	EPI0S31	I/O	TTL	EPI module 0 signal 31.
	PWM7	O	TTL	PWM 7. This signal is controlled by PWM Generator 3.
	PhB1	I	TTL	QE1 module 1 phase B.
37	RXIN	I	Analog	RXIN of the Ethernet PHY.
38	VDDC	-	Power	Positive supply for most of the logic function, including the processor core and most peripherals.
39	CCP0	I/O	TTL	Capture/Compare/PWM 0.
	EPI0S18	I/O	TTL	EPI module 0 signal 18.
	Fault0	I	TTL	PWM Fault 0.
	PJ2	I/O	TTL	GPIO port J bit 2.
40	RXIP	I	Analog	RXIP of the Ethernet PHY.
41	PF5	I/O	TTL	GPIO port F bit 5.
	C1o	O	TTL	Analog comparator 1 output.
	CCP2	I/O	TTL	Capture/Compare/PWM 2.
	EPI0S15	I/O	TTL	EPI module 0 signal 15.
	SSI1Tx	O	TTL	SSI module 1 transmit.
42	PF4	I/O	TTL	GPIO port F bit 4.
	C0o	O	TTL	Analog comparator 0 output.
	CCP0	I/O	TTL	Capture/Compare/PWM 0.
	EPI0S12	I/O	TTL	EPI module 0 signal 12.
	Fault0	I	TTL	PWM Fault 0.
	SSI1Rx	I	TTL	SSI module 1 receive.
43	TXOP	O	TTL	TXOP of the Ethernet PHY.
44	VDD	-	Power	Positive supply for I/O and some logic.
45	GND	-	Power	Ground reference for logic and I/O pins.
46	TXON	O	TTL	TXON of the Ethernet PHY.
47	PF0	I/O	TTL	GPIO port F bit 0.
	CAN1Rx	I	TTL	CAN module 1 receive.
	I2S0TXSD	I/O	TTL	I <sup>2</sup> S module 0 transmit data.
	PWM0	O	TTL	PWM 0. This signal is controlled by PWM Generator 0.
	PhB0	I	TTL	QE1 module 0 phase B.
	U1DSR	I	TTL	UART module 1 Data Set Ready modem output control line.
48	OSC0	I	Analog	Main oscillator crystal input or an external clock reference input.
49	OSC1	O	Analog	Main oscillator crystal output. Leave unconnected when using a single-ended clock source.
50	CCP6	I/O	TTL	Capture/Compare/PWM 6.
	EPI0S19	I/O	TTL	EPI module 0 signal 19.
	PJ3	I/O	TTL	GPIO port J bit 3.
	U1CTS	I	TTL	UART module 1 Clear To Send modem status input signal.
51	NC	-	-	No connect. Leave the pin electrically unconnected/isolated.

Table 25-2. Signals by Pin Number (continued)

Pin Number	Pin Name	Pin Type	Buffer Type <sup>a</sup>	Description
52	CCP4	I/O	TTL	Capture/Compare/PWM 4.
	EPIOS28	I/O	TTL	EPI module 0 signal 28.
	PJ4	I/O	TTL	GPIO port J bit 4.
	U1DCD	I	TTL	UART module 1 Data Carrier Detect modem status input signal.
53	CCP2	I/O	TTL	Capture/Compare/PWM 2.
	EPIOS29	I/O	TTL	EPI module 0 signal 29.
	PJ5	I/O	TTL	GPIO port J bit 5.
	U1DSR	I	TTL	UART module 1 Data Set Ready modem output control line.
54	CCP1	I/O	TTL	Capture/Compare/PWM 1.
	EPIOS30	I/O	TTL	EPI module 0 signal 30.
	PJ6	I/O	TTL	GPIO port J bit 6.
	U1RTS	O	TTL	UART module 1 Request to Send modem output control line.
55	CCP0	I/O	TTL	Capture/Compare/PWM 0.
	PJ7	I/O	TTL	GPIO port J bit 7.
	U1DTR	O	TTL	UART module 1 Data Terminal Ready modem status input signal.
56	VDD	-	Power	Positive supply for I/O and some logic.
57	GND	-	Power	Ground reference for logic and I/O pins.
58	MDIO	I/O	OD	MDIO of the Ethernet PHY.
59	PF3	I/O	TTL	GPIO port F bit 3.
	LED0	O	TTL	Ethernet LED 0.
	PWM3	O	TTL	PWM 3. This signal is controlled by PWM Generator 1.
	PWM5	O	TTL	PWM 5. This signal is controlled by PWM Generator 2.
	SSI1Fss	I/O	TTL	SSI module 1 frame.
60	PF2	I/O	TTL	GPIO port F bit 2.
	LED1	O	TTL	Ethernet LED 1.
	PWM2	O	TTL	PWM 2. This signal is controlled by PWM Generator 1.
	PWM4	O	TTL	PWM 4. This signal is controlled by PWM Generator 2.
	SSI1Clk	I/O	TTL	SSI module 1 clock.
61	PF1	I/O	TTL	GPIO port F bit 1.
	CAN1Tx	O	TTL	CAN module 1 transmit.
	CCP3	I/O	TTL	Capture/Compare/PWM 3.
	I2S0TXMCLK	I/O	TTL	I <sup>2</sup> S module 0 transmit master clock.
	IDX1	I	TTL	QEI module 1 index.
	PWM1	O	TTL	PWM 1. This signal is controlled by PWM Generator 0.
	U1RTS	O	TTL	UART module 1 Request to Send modem output control line.
62	PH6	I/O	TTL	GPIO port H bit 6.
	EPIOS26	I/O	TTL	EPI module 0 signal 26.
	PWM4	O	TTL	PWM 4. This signal is controlled by PWM Generator 2.
	SSI1Rx	I	TTL	SSI module 1 receive.



Table 25-2. Signals by Pin Number (continued)

Pin Number	Pin Name	Pin Type	Buffer Type <sup>a</sup>	Description
63	PH5	I/O	TTL	GPIO port H bit 5.
	EPIOS11	I/O	TTL	EPI module 0 signal 11.
	Fault2	I	TTL	PWM Fault 2.
	SSI1Fss	I/O	TTL	SSI module 1 frame.
64	RST	I	TTL	System reset input.
65	PB3	I/O	TTL	GPIO port B bit 3.
	Fault0	I	TTL	PWM Fault 0.
	Fault3	I	TTL	PWM Fault 3.
	I2C0SDA	I/O	OD	I <sup>2</sup> C module 0 data.
	USB0PFLT	I	TTL	Optionally used in Host mode by an external power source to indicate an error state by that power source.
66	PB0	I/O	TTL	GPIO port B bit 0.
	CCP0	I/O	TTL	Capture/Compare/PWM 0.
	PWM2	O	TTL	PWM 2. This signal is controlled by PWM Generator 1.
	U1Rx	I	TTL	UART module 1 receive. When in IrDA mode, this signal has IrDA modulation.
	USB0ID	I	Analog	This signal senses the state of the USB ID signal. The USB PHY enables an integrated pull-up, and an external element (USB connector) indicates the initial state of the USB controller (pulled down is the A side of the cable and pulled up is the B side).
67	PB1	I/O	TTL	GPIO port B bit 1.
	CCP1	I/O	TTL	Capture/Compare/PWM 1.
	CCP2	I/O	TTL	Capture/Compare/PWM 2.
	PWM3	O	TTL	PWM 3. This signal is controlled by PWM Generator 1.
	U1Tx	O	TTL	UART module 1 transmit. When in IrDA mode, this signal has IrDA modulation.
	USB0VBUS	I/O	Analog	This signal is used during the session request protocol. This signal allows the USB PHY to both sense the voltage level of VBUS, and pull up VBUS momentarily during VBUS pulsing.
68	VDD	-	Power	Positive supply for I/O and some logic.
69	GND	-	Power	Ground reference for logic and I/O pins.
70	USB0DM	I/O	Analog	Bidirectional differential data pin (D- per USB specification).
71	USB0DP	I/O	Analog	Bidirectional differential data pin (D+ per USB specification).
72	PB2	I/O	TTL	GPIO port B bit 2.
	CCP0	I/O	TTL	Capture/Compare/PWM 0.
	CCP3	I/O	TTL	Capture/Compare/PWM 3.
	I2C0SCL	I/O	OD	I <sup>2</sup> C module 0 clock.
	IDX0	I	TTL	QEI module 0 index.
	USB0EPEN	O	TTL	Optionally used in Host mode to control an external power source to supply power to the USB bus.
73	USB0RBIAS	O	Analog	9.1-kΩ resistor (1% precision) used internally for USB analog circuitry.

Table 25-2. Signals by Pin Number (continued)

Pin Number	Pin Name	Pin Type	Buffer Type <sup>a</sup>	Description
74	PE0	I/O	TTL	GPIO port E bit 0.
	CCP3	I/O	TTL	Capture/Compare/PWM 3.
	EPI0S8	I/O	TTL	EPI module 0 signal 8.
	PWM4	O	TTL	PWM 4. This signal is controlled by PWM Generator 2.
	SSI1Clk	I/O	TTL	SSI module 1 clock.
	USB0PFLT	I	TTL	Optionally used in Host mode by an external power source to indicate an error state by that power source.
75	PE1	I/O	TTL	GPIO port E bit 1.
	CCP2	I/O	TTL	Capture/Compare/PWM 2.
	CCP6	I/O	TTL	Capture/Compare/PWM 6.
	EPI0S9	I/O	TTL	EPI module 0 signal 9.
	Fault0	I	TTL	PWM Fault 0.
	PWM5	O	TTL	PWM 5. This signal is controlled by PWM Generator 2.
	SSI1Fss	I/O	TTL	SSI module 1 frame.
76	PH4	I/O	TTL	GPIO port H bit 4.
	EPI0S10	I/O	TTL	EPI module 0 signal 10.
	SSI1Clk	I/O	TTL	SSI module 1 clock.
	USB0PFLT	I	TTL	Optionally used in Host mode by an external power source to indicate an error state by that power source.
77	PC3	I/O	TTL	GPIO port C bit 3.
	SWO	O	TTL	JTAG TDO and SWO.
	TDO	O	TTL	JTAG TDO and SWO.
78	PC2	I/O	TTL	GPIO port C bit 2.
	TDI	I	TTL	JTAG TDI.
79	PC1	I/O	TTL	GPIO port C bit 1.
	SWDIO	I/O	TTL	JTAG TMS and SWDIO.
	TMS	I	TTL	JTAG TMS and SWDIO.
80	PC0	I/O	TTL	GPIO port C bit 0.
	SWCLK	I	TTL	JTAG/SWD CLK.
	TCK	I	TTL	JTAG/SWD CLK.
81	VDD	-	Power	Positive supply for I/O and some logic.
82	GND	-	Power	Ground reference for logic and I/O pins.
83	PH3	I/O	TTL	GPIO port H bit 3.
	EPI0S0	I/O	TTL	EPI module 0 signal 0.
	Fault0	I	TTL	PWM Fault 0.
	PhB0	I	TTL	QEI module 0 phase B.
	USB0EPEN	O	TTL	Optionally used in Host mode to control an external power source to supply power to the USB bus.

Table 25-2. Signals by Pin Number (continued)

Pin Number	Pin Name	Pin Type	Buffer Type <sup>a</sup>	Description
84	PH2	I/O	TTL	GPIO port H bit 2.
	C1o	O	TTL	Analog comparator 1 output.
	EPI0S1	I/O	TTL	EPI module 0 signal 1.
	Fault3	I	TTL	PWM Fault 3.
	IDX1	I	TTL	QE1 module 1 index.
85	PH1	I/O	TTL	GPIO port H bit 1.
	CCP7	I/O	TTL	Capture/Compare/PWM 7.
	EPI0S7	I/O	TTL	EPI module 0 signal 7.
	PWM3	O	TTL	PWM 3. This signal is controlled by PWM Generator 1.
	PWM5	O	TTL	PWM 5. This signal is controlled by PWM Generator 2.
86	PH0	I/O	TTL	GPIO port H bit 0.
	CCP6	I/O	TTL	Capture/Compare/PWM 6.
	EPI0S6	I/O	TTL	EPI module 0 signal 6.
	PWM2	O	TTL	PWM 2. This signal is controlled by PWM Generator 1.
	PWM4	O	TTL	PWM 4. This signal is controlled by PWM Generator 2.
87	EPI0S17	I/O	TTL	EPI module 0 signal 17.
	I2C1SDA	I/O	OD	I <sup>2</sup> C module 1 data.
	PJ1	I/O	TTL	GPIO port J bit 1.
	PWM1	O	TTL	PWM 1. This signal is controlled by PWM Generator 0.
	USB0PFLT	I	TTL	Optionally used in Host mode by an external power source to indicate an error state by that power source.
88	VDDC	-	Power	Positive supply for most of the logic function, including the processor core and most peripherals.
89	PB7	I/O	TTL	GPIO port B bit 7.
	NMI	I	TTL	Non-maskable interrupt.
90	PB6	I/O	TTL	GPIO port B bit 6.
	C0+	I	Analog	Analog comparator 0 positive input.
	C0o	O	TTL	Analog comparator 0 output.
	CCP1	I/O	TTL	Capture/Compare/PWM 1.
	CCP5	I/O	TTL	Capture/Compare/PWM 5.
	CCP7	I/O	TTL	Capture/Compare/PWM 7.
	Fault1	I	TTL	PWM Fault 1.
	I2S0TXSCK	I/O	TTL	I <sup>2</sup> S module 0 transmit clock.
	IDX0	I	TTL	QE1 module 0 index.
	VREFA	I	Analog	This input provides a reference voltage used to specify the input voltage at which the ADC converts to a maximum value. In other words, the voltage that is applied to VREFA is the voltage with which an AIN <sub>n</sub> signal is converted to 1023. The VREFA input is limited to the range specified in Table 27-2 on page 1205.

Table 25-2. Signals by Pin Number (continued)

Pin Number	Pin Name	Pin Type	Buffer Type <sup>a</sup>	Description
91	PB5	I/O	TTL	GPIO port B bit 5.
	AIN11	I	Analog	Analog-to-digital converter input 11.
	C0o	O	TTL	Analog comparator 0 output.
	C1-	I	Analog	Analog comparator 1 negative input.
	CAN0Tx	O	TTL	CAN module 0 transmit.
	CCP0	I/O	TTL	Capture/Compare/PWM 0.
	CCP2	I/O	TTL	Capture/Compare/PWM 2.
	CCP5	I/O	TTL	Capture/Compare/PWM 5.
	CCP6	I/O	TTL	Capture/Compare/PWM 6.
	EPI0S22	I/O	TTL	EPI module 0 signal 22.
U1Tx	O	TTL	UART module 1 transmit. When in IrDA mode, this signal has IrDA modulation.	
92	PB4	I/O	TTL	GPIO port B bit 4.
	AIN10	I	Analog	Analog-to-digital converter input 10.
	C0-	I	Analog	Analog comparator 0 negative input.
	CAN0Rx	I	TTL	CAN module 0 receive.
	EPI0S23	I/O	TTL	EPI module 0 signal 23.
	IDX0	I	TTL	QEI module 0 index.
	U1Rx	I	TTL	UART module 1 receive. When in IrDA mode, this signal has IrDA modulation.
	U2Rx	I	TTL	UART module 2 receive. When in IrDA mode, this signal has IrDA modulation.
93	VDD	-	Power	Positive supply for I/O and some logic.
94	GND	-	Power	Ground reference for logic and I/O pins.
95	PE2	I/O	TTL	GPIO port E bit 2.
	AIN9	I	Analog	Analog-to-digital converter input 9.
	CCP2	I/O	TTL	Capture/Compare/PWM 2.
	CCP4	I/O	TTL	Capture/Compare/PWM 4.
	EPI0S24	I/O	TTL	EPI module 0 signal 24.
	PhA0	I	TTL	QEI module 0 phase A.
	PhB1	I	TTL	QEI module 1 phase B.
SSI1Rx	I	TTL	SSI module 1 receive.	
96	PE3	I/O	TTL	GPIO port E bit 3.
	AIN8	I	Analog	Analog-to-digital converter input 8.
	CCP1	I/O	TTL	Capture/Compare/PWM 1.
	CCP7	I/O	TTL	Capture/Compare/PWM 7.
	EPI0S25	I/O	TTL	EPI module 0 signal 25.
	PhA1	I	TTL	QEI module 1 phase A.
	PhB0	I	TTL	QEI module 0 phase B.
	SSI1Tx	O	TTL	SSI module 1 transmit.

Table 25-2. Signals by Pin Number (continued)

Pin Number	Pin Name	Pin Type	Buffer Type <sup>a</sup>	Description
97	PD4	I/O	TTL	GPIO port D bit 4.
	AIN7	I	Analog	Analog-to-digital converter input 7.
	CCP0	I/O	TTL	Capture/Compare/PWM 0.
	CCP3	I/O	TTL	Capture/Compare/PWM 3.
	EPI0S19	I/O	TTL	EPI module 0 signal 19.
	I2S0RXSD	I/O	TTL	I <sup>2</sup> S module 0 receive data.
	U1RI	I	TTL	UART module 1 Ring Indicator modem status input signal.
98	PD5	I/O	TTL	GPIO port D bit 5.
	AIN6	I	Analog	Analog-to-digital converter input 6.
	CCP2	I/O	TTL	Capture/Compare/PWM 2.
	CCP4	I/O	TTL	Capture/Compare/PWM 4.
	EPI0S28	I/O	TTL	EPI module 0 signal 28.
	I2S0RXMCLK	I/O	TTL	I <sup>2</sup> S module 0 receive master clock.
	U2Rx	I	TTL	UART module 2 receive. When in IrDA mode, this signal has IrDA modulation.
99	PD6	I/O	TTL	GPIO port D bit 6.
	AIN5	I	Analog	Analog-to-digital converter input 5.
	EPI0S29	I/O	TTL	EPI module 0 signal 29.
	Fault0	I	TTL	PWM Fault 0.
	I2S0TXSCK	I/O	TTL	I <sup>2</sup> S module 0 transmit clock.
U2Tx	O	TTL	UART module 2 transmit. When in IrDA mode, this signal has IrDA modulation.	
100	PD7	I/O	TTL	GPIO port D bit 7.
	AIN4	I	Analog	Analog-to-digital converter input 4.
	CO0	O	TTL	Analog comparator 0 output.
	CCP1	I/O	TTL	Capture/Compare/PWM 1.
	EPI0S30	I/O	TTL	EPI module 0 signal 30.
	I2S0TXWS	I/O	TTL	I <sup>2</sup> S module 0 transmit word select.
	IDX0	I	TTL	QEI module 0 index.
U1DTR	O	TTL	UART module 1 Data Terminal Ready modem status input signal.	

a. The TTL designation indicates the pin has TTL-compatible voltage levels.

Table 25-3. Signals by Signal Name

Pin Name	Pin Number	Pin Mux / Pin Assignment	Pin Type	Buffer Type <sup>a</sup>	Description
AIN0	1	PE7	I	Analog	Analog-to-digital converter input 0.
AIN1	2	PE6	I	Analog	Analog-to-digital converter input 1.
AIN2	5	PE5	I	Analog	Analog-to-digital converter input 2.
AIN3	6	PE4	I	Analog	Analog-to-digital converter input 3.
AIN4	100	PD7	I	Analog	Analog-to-digital converter input 4.
AIN5	99	PD6	I	Analog	Analog-to-digital converter input 5.
AIN6	98	PD5	I	Analog	Analog-to-digital converter input 6.

Table 25-3. Signals by Signal Name (continued)

Pin Name	Pin Number	Pin Mux / Pin Assignment	Pin Type	Buffer Type <sup>a</sup>	Description
AIN7	97	PD4	I	Analog	Analog-to-digital converter input 7.
AIN8	96	PE3	I	Analog	Analog-to-digital converter input 8.
AIN9	95	PE2	I	Analog	Analog-to-digital converter input 9.
AIN10	92	PB4	I	Analog	Analog-to-digital converter input 10.
AIN11	91	PB5	I	Analog	Analog-to-digital converter input 11.
AIN12	13	PD3	I	Analog	Analog-to-digital converter input 12.
AIN13	12	PD2	I	Analog	Analog-to-digital converter input 13.
AIN14	11	PD1	I	Analog	Analog-to-digital converter input 14.
AIN15	10	PD0	I	Analog	Analog-to-digital converter input 15.
C0+	90	PB6	I	Analog	Analog comparator 0 positive input.
C0-	92	PB4	I	Analog	Analog comparator 0 negative input.
C0o	24 42 90 91 100	PC5 (3) PF4 (2) PB6 (3) PB5 (1) PD7 (2)	O	TTL	Analog comparator 0 output.
C1+	24	PC5	I	Analog	Analog comparator 1 positive input.
C1-	91	PB5	I	Analog	Analog comparator 1 negative input.
C1o	2 22 24 41 84	PE6 (2) PC7 (7) PC5 (2) PF5 (2) PH2 (2)	O	TTL	Analog comparator 1 output.
C2+	23	PC6	I	Analog	Analog comparator 2 positive input.
C2-	22	PC7	I	Analog	Analog comparator 2 negative input.
C2o	1 23	PE7 (2) PC6 (3)	O	TTL	Analog comparator 2 output.
CAN0Rx	10 30 34 92	PD0 (2) PA4 (5) PA6 (6) PB4 (5)	I	TTL	CAN module 0 receive.
CAN0Tx	11 31 35 91	PD1 (2) PA5 (5) PA7 (6) PB5 (5)	O	TTL	CAN module 0 transmit.
CAN1Rx	47	PF0 (1)	I	TTL	CAN module 1 receive.
CAN1Tx	61	PF1 (1)	O	TTL	CAN module 1 transmit.
CCP0	13 22 23 39 42 55 66 72 91 97	PD3 (4) PC7 (4) PC6 (6) PJ2 (9) PF4 (1) PJ7 (10) PB0 (1) PB2 (5) PB5 (4) PD4 (1)	I/O	TTL	Capture/Compare/PWM 0.

Table 25-3. Signals by Signal Name (continued)

Pin Name	Pin Number	Pin Mux / Pin Assignment	Pin Type	Buffer Type <sup>a</sup>	Description
CCP1	24 25 34 54 67 90 96 100	PC5 (1) PC4 (9) PA6 (2) PJ6 (10) PB1 (4) PB6 (1) PE3 (1) PD7 (3)	I/O	TTL	Capture/Compare/PWM 1.
CCP2	6 11 25 41 53 67 75 91 95 98	PE4 (6) PD1 (10) PC4 (5) PF5 (1) PJ5 (10) PB1 (1) PE1 (4) PB5 (6) PE2 (5) PD5 (1)	I/O	TTL	Capture/Compare/PWM 2.
CCP3	6 23 24 35 61 72 74 97	PE4 (1) PC6 (1) PC5 (5) PA7 (7) PF1 (10) PB2 (4) PE0 (3) PD4 (2)	I/O	TTL	Capture/Compare/PWM 3.
CCP4	22 25 35 52 95 98	PC7 (1) PC4 (6) PA7 (2) PJ4 (10) PE2 (1) PD5 (2)	I/O	TTL	Capture/Compare/PWM 4.
CCP5	5 12 25 36 90 91	PE5 (1) PD2 (4) PC4 (1) PG7 (8) PB6 (6) PB5 (2)	I/O	TTL	Capture/Compare/PWM 5.
CCP6	10 12 50 75 86 91	PD0 (6) PD2 (2) PJ3 (10) PE1 (5) PH0 (1) PB5 (3)	I/O	TTL	Capture/Compare/PWM 6.
CCP7	11 13 85 90 96	PD1 (6) PD3 (2) PH1 (1) PB6 (2) PE3 (5)	I/O	TTL	Capture/Compare/PWM 7.
EPI0S0	83	PH3 (8)	I/O	TTL	EPI module 0 signal 0.
EPI0S1	84	PH2 (8)	I/O	TTL	EPI module 0 signal 1.
EPI0S2	25	PC4 (8)	I/O	TTL	EPI module 0 signal 2.
EPI0S3	24	PC5 (8)	I/O	TTL	EPI module 0 signal 3.

Table 25-3. Signals by Signal Name (continued)

Pin Name	Pin Number	Pin Mux / Pin Assignment	Pin Type	Buffer Type <sup>a</sup>	Description
EPI0S4	23	PC6 (8)	I/O	TTL	EPI module 0 signal 4.
EPI0S5	22	PC7 (8)	I/O	TTL	EPI module 0 signal 5.
EPI0S6	86	PH0 (8)	I/O	TTL	EPI module 0 signal 6.
EPI0S7	85	PH1 (8)	I/O	TTL	EPI module 0 signal 7.
EPI0S8	74	PE0 (8)	I/O	TTL	EPI module 0 signal 8.
EPI0S9	75	PE1 (8)	I/O	TTL	EPI module 0 signal 9.
EPI0S10	76	PH4 (8)	I/O	TTL	EPI module 0 signal 10.
EPI0S11	63	PH5 (8)	I/O	TTL	EPI module 0 signal 11.
EPI0S12	42	PF4 (8)	I/O	TTL	EPI module 0 signal 12.
EPI0S13	19	PG0 (8)	I/O	TTL	EPI module 0 signal 13.
EPI0S14	18	PG1 (8)	I/O	TTL	EPI module 0 signal 14.
EPI0S15	41	PF5 (8)	I/O	TTL	EPI module 0 signal 15.
EPI0S16	14	PJ0 (8)	I/O	TTL	EPI module 0 signal 16.
EPI0S17	87	PJ1 (8)	I/O	TTL	EPI module 0 signal 17.
EPI0S18	39	PJ2 (8)	I/O	TTL	EPI module 0 signal 18.
EPI0S19	50 97	PJ3 (8) PD4 (10)	I/O	TTL	EPI module 0 signal 19.
EPI0S20	12	PD2 (8)	I/O	TTL	EPI module 0 signal 20.
EPI0S21	13	PD3 (8)	I/O	TTL	EPI module 0 signal 21.
EPI0S22	91	PB5 (8)	I/O	TTL	EPI module 0 signal 22.
EPI0S23	92	PB4 (8)	I/O	TTL	EPI module 0 signal 23.
EPI0S24	95	PE2 (8)	I/O	TTL	EPI module 0 signal 24.
EPI0S25	96	PE3 (8)	I/O	TTL	EPI module 0 signal 25.
EPI0S26	62	PH6 (8)	I/O	TTL	EPI module 0 signal 26.
EPI0S27	15	PH7 (8)	I/O	TTL	EPI module 0 signal 27.
EPI0S28	52 98	PJ4 (8) PD5 (10)	I/O	TTL	EPI module 0 signal 28.
EPI0S29	53 99	PJ5 (8) PD6 (10)	I/O	TTL	EPI module 0 signal 29.
EPI0S30	54 100	PJ6 (8) PD7 (10)	I/O	TTL	EPI module 0 signal 30.
EPI0S31	36	PG7 (9)	I/O	TTL	EPI module 0 signal 31.
ERBIAS	33	fixed	O	Analog	12.4-kΩ resistor (1% precision) used internally for Ethernet PHY.
Fault0	6 39 42 65 75 83 99	PE4 (4) PJ2 (10) PF4 (4) PB3 (2) PE1 (3) PH3 (2) PD6 (1)	I	TTL	PWM Fault 0.
Fault1	90	PB6 (4)	I	TTL	PWM Fault 1.
Fault2	24 63	PC5 (4) PH5 (10)	I	TTL	PWM Fault 2.



Table 25-3. Signals by Signal Name (continued)

Pin Name	Pin Number	Pin Mux / Pin Assignment	Pin Type	Buffer Type <sup>a</sup>	Description
Fault3	65 84	PB3 (4) PH2 (4)	I	TTL	PWM Fault 3.
GND	9 21 45 57 69 82 94	fixed	-	Power	Ground reference for logic and I/O pins.
GNDA	4	fixed	-	Power	The ground reference for the analog circuits (ADC, Analog Comparators, etc.). These are separated from GND to minimize the electrical noise contained on VDD from affecting the analog functions.
I2C0SCL	72	PB2 (1)	I/O	OD	I <sup>2</sup> C module 0 clock.
I2C0SDA	65	PB3 (1)	I/O	OD	I <sup>2</sup> C module 0 data.
I2C1SCL	14 19 26 34	PJ0 (11) PG0 (3) PA0 (8) PA6 (1)	I/O	OD	I <sup>2</sup> C module 1 clock.
I2C1SDA	18 27 35 87	PG1 (3) PA1 (8) PA7 (1) PJ1 (11)	I/O	OD	I <sup>2</sup> C module 1 data.
I2S0RXMCLK	29 98	PA3 (9) PD5 (8)	I/O	TTL	I <sup>2</sup> S module 0 receive master clock.
I2S0RXSCK	10	PD0 (8)	I/O	TTL	I <sup>2</sup> S module 0 receive clock.
I2S0RXSD	28 97	PA2 (9) PD4 (8)	I/O	TTL	I <sup>2</sup> S module 0 receive data.
I2S0RXWS	11	PD1 (8)	I/O	TTL	I <sup>2</sup> S module 0 receive word select.
I2S0TXMCLK	61	PF1 (8)	I/O	TTL	I <sup>2</sup> S module 0 transmit master clock.
I2S0TXSCK	30 90 99	PA4 (9) PB6 (9) PD6 (8)	I/O	TTL	I <sup>2</sup> S module 0 transmit clock.
I2S0TXSD	5 47	PE5 (9) PF0 (8)	I/O	TTL	I <sup>2</sup> S module 0 transmit data.
I2S0TXWS	6 31 100	PE4 (9) PA5 (9) PD7 (8)	I/O	TTL	I <sup>2</sup> S module 0 transmit word select.
IDX0	10 72 90 92 100	PD0 (3) PB2 (2) PB6 (5) PB4 (6) PD7 (1)	I	TTL	QEI module 0 index.
IDX1	61 84	PF1 (2) PH2 (1)	I	TTL	QEI module 1 index.
LDO	7	fixed	-	Power	Low drop-out regulator output voltage. This pin requires an external capacitor between the pin and GND of 1 µF or greater. When the on-chip LDO is used to provide power to the logic, the LDO pin must also be connected to the VDDC pins at the board level in addition to the decoupling capacitor(s).

Table 25-3. Signals by Signal Name (continued)

Pin Name	Pin Number	Pin Mux / Pin Assignment	Pin Type	Buffer Type <sup>a</sup>	Description
LED0	59	PF3 (1)	O	TTL	Ethernet LED 0.
LED1	60	PF2 (1)	O	TTL	Ethernet LED 1.
MDIO	58	fixed	I/O	OD	MDIO of the Ethernet PHY.
NC	51	fixed	-	-	No connect. Leave the pin electrically unconnected/isolated.
NMI	89	PB7 (4)	I	TTL	Non-maskable interrupt.
OSC0	48	fixed	I	Analog	Main oscillator crystal input or an external clock reference input.
OSC1	49	fixed	O	Analog	Main oscillator crystal output. Leave unconnected when using a single-ended clock source.
PA0	26	-	I/O	TTL	GPIO port A bit 0.
PA1	27	-	I/O	TTL	GPIO port A bit 1.
PA2	28	-	I/O	TTL	GPIO port A bit 2.
PA3	29	-	I/O	TTL	GPIO port A bit 3.
PA4	30	-	I/O	TTL	GPIO port A bit 4.
PA5	31	-	I/O	TTL	GPIO port A bit 5.
PA6	34	-	I/O	TTL	GPIO port A bit 6.
PA7	35	-	I/O	TTL	GPIO port A bit 7.
PB0	66	-	I/O	TTL	GPIO port B bit 0.
PB1	67	-	I/O	TTL	GPIO port B bit 1.
PB2	72	-	I/O	TTL	GPIO port B bit 2.
PB3	65	-	I/O	TTL	GPIO port B bit 3.
PB4	92	-	I/O	TTL	GPIO port B bit 4.
PB5	91	-	I/O	TTL	GPIO port B bit 5.
PB6	90	-	I/O	TTL	GPIO port B bit 6.
PB7	89	-	I/O	TTL	GPIO port B bit 7.
PC0	80	-	I/O	TTL	GPIO port C bit 0.
PC1	79	-	I/O	TTL	GPIO port C bit 1.
PC2	78	-	I/O	TTL	GPIO port C bit 2.
PC3	77	-	I/O	TTL	GPIO port C bit 3.
PC4	25	-	I/O	TTL	GPIO port C bit 4.
PC5	24	-	I/O	TTL	GPIO port C bit 5.
PC6	23	-	I/O	TTL	GPIO port C bit 6.
PC7	22	-	I/O	TTL	GPIO port C bit 7.
PD0	10	-	I/O	TTL	GPIO port D bit 0.
PD1	11	-	I/O	TTL	GPIO port D bit 1.
PD2	12	-	I/O	TTL	GPIO port D bit 2.
PD3	13	-	I/O	TTL	GPIO port D bit 3.
PD4	97	-	I/O	TTL	GPIO port D bit 4.
PD5	98	-	I/O	TTL	GPIO port D bit 5.
PD6	99	-	I/O	TTL	GPIO port D bit 6.

Table 25-3. Signals by Signal Name (continued)

Pin Name	Pin Number	Pin Mux / Pin Assignment	Pin Type	Buffer Type <sup>a</sup>	Description
PD7	100	-	I/O	TTL	GPIO port D bit 7.
PE0	74	-	I/O	TTL	GPIO port E bit 0.
PE1	75	-	I/O	TTL	GPIO port E bit 1.
PE2	95	-	I/O	TTL	GPIO port E bit 2.
PE3	96	-	I/O	TTL	GPIO port E bit 3.
PE4	6	-	I/O	TTL	GPIO port E bit 4.
PE5	5	-	I/O	TTL	GPIO port E bit 5.
PE6	2	-	I/O	TTL	GPIO port E bit 6.
PE7	1	-	I/O	TTL	GPIO port E bit 7.
PF0	47	-	I/O	TTL	GPIO port F bit 0.
PF1	61	-	I/O	TTL	GPIO port F bit 1.
PF2	60	-	I/O	TTL	GPIO port F bit 2.
PF3	59	-	I/O	TTL	GPIO port F bit 3.
PF4	42	-	I/O	TTL	GPIO port F bit 4.
PF5	41	-	I/O	TTL	GPIO port F bit 5.
PG0	19	-	I/O	TTL	GPIO port G bit 0.
PG1	18	-	I/O	TTL	GPIO port G bit 1.
PG7	36	-	I/O	TTL	GPIO port G bit 7.
PH0	86	-	I/O	TTL	GPIO port H bit 0.
PH1	85	-	I/O	TTL	GPIO port H bit 1.
PH2	84	-	I/O	TTL	GPIO port H bit 2.
PH3	83	-	I/O	TTL	GPIO port H bit 3.
PH4	76	-	I/O	TTL	GPIO port H bit 4.
PH5	63	-	I/O	TTL	GPIO port H bit 5.
PH6	62	-	I/O	TTL	GPIO port H bit 6.
PH7	15	-	I/O	TTL	GPIO port H bit 7.
PhA0	11 25 95	PD1 (3) PC4 (2) PE2 (4)	I	TTL	QEI module 0 phase A.
PhA1	96	PE3 (3)	I	TTL	QEI module 1 phase A.
PhB0	22 23 47 83 96	PC7 (2) PC6 (2) PF0 (2) PH3 (1) PE3 (4)	I	TTL	QEI module 0 phase B.
PhB1	11 36 95	PD1 (11) PG7 (1) PE2 (3)	I	TTL	QEI module 1 phase B.
PJ0	14	-	I/O	TTL	GPIO port J bit 0.
PJ1	87	-	I/O	TTL	GPIO port J bit 1.
PJ2	39	-	I/O	TTL	GPIO port J bit 2.
PJ3	50	-	I/O	TTL	GPIO port J bit 3.
PJ4	52	-	I/O	TTL	GPIO port J bit 4.

Table 25-3. Signals by Signal Name (continued)

Pin Name	Pin Number	Pin Mux / Pin Assignment	Pin Type	Buffer Type <sup>a</sup>	Description
PJ5	53	-	I/O	TTL	GPIO port J bit 5.
PJ6	54	-	I/O	TTL	GPIO port J bit 6.
PJ7	55	-	I/O	TTL	GPIO port J bit 7.
PWM0	10 14 19 34 47	PD0 (1) PJ0 (10) PG0 (2) PA6 (4) PF0 (3)	O	TTL	PWM 0. This signal is controlled by PWM Generator 0.
PWM1	11 18 35 61 87	PD1 (1) PG1 (2) PA7 (4) PF1 (3) PJ1 (10)	O	TTL	PWM 1. This signal is controlled by PWM Generator 0.
PWM2	12 60 66 86	PD2 (3) PF2 (4) PB0 (2) PH0 (2)	O	TTL	PWM 2. This signal is controlled by PWM Generator 1.
PWM3	13 59 67 85	PD3 (3) PF3 (4) PB1 (2) PH1 (2)	O	TTL	PWM 3. This signal is controlled by PWM Generator 1.
PWM4	2 19 28 34 60 62 74 86	PE6 (1) PG0 (4) PA2 (4) PA6 (5) PF2 (2) PH6 (10) PE0 (1) PH0 (9)	O	TTL	PWM 4. This signal is controlled by PWM Generator 2.
PWM5	1 15 18 29 35 59 75 85	PE7 (1) PH7 (10) PG1 (4) PA3 (4) PA7 (5) PF3 (2) PE1 (1) PH1 (9)	O	TTL	PWM 5. This signal is controlled by PWM Generator 2.
PWM6	25 30	PC4 (4) PA4 (4)	O	TTL	PWM 6. This signal is controlled by PWM Generator 3.
PWM7	23 31 36	PC6 (4) PA5 (4) PG7 (4)	O	TTL	PWM 7. This signal is controlled by PWM Generator 3.
RST	64	fixed	I	TTL	System reset input.
RXIN	37	fixed	I	Analog	RXIN of the Ethernet PHY.
RXIP	40	fixed	I	Analog	RXIP of the Ethernet PHY.
SSI0Clk	28	PA2 (1)	I/O	TTL	SSI module 0 clock.
SSI0Fss	29	PA3 (1)	I/O	TTL	SSI module 0 frame.
SSI0Rx	30	PA4 (1)	I	TTL	SSI module 0 receive.
SSI0Tx	31	PA5 (1)	O	TTL	SSI module 0 transmit.

Table 25-3. Signals by Signal Name (continued)

Pin Name	Pin Number	Pin Mux / Pin Assignment	Pin Type	Buffer Type <sup>a</sup>	Description
SSI1Clk	60	PF2 (9)	I/O	TTL	SSI module 1 clock.
	74	PE0 (2)			
	76	PH4 (11)			
SSI1Fss	59	PF3 (9)	I/O	TTL	SSI module 1 frame.
	63	PH5 (11)			
	75	PE1 (2)			
SSI1Rx	42	PF4 (9)	I	TTL	SSI module 1 receive.
	62	PH6 (11)			
	95	PE2 (2)			
SSI1Tx	15	PH7 (11)	O	TTL	SSI module 1 transmit.
	41	PF5 (9)			
	96	PE3 (2)			
SWCLK	80	PC0 (3)	I	TTL	JTAG/SWD CLK.
SWDIO	79	PC1 (3)	I/O	TTL	JTAG TMS and SWDIO.
SWO	77	PC3 (3)	O	TTL	JTAG TDO and SWO.
TCK	80	PC0 (3)	I	TTL	JTAG/SWD CLK.
TDI	78	PC2 (3)	I	TTL	JTAG TDI.
TDO	77	PC3 (3)	O	TTL	JTAG TDO and SWO.
TMS	79	PC1 (3)	I	TTL	JTAG TMS and SWDIO.
TXON	46	fixed	O	TTL	TXON of the Ethernet PHY.
TXOP	43	fixed	O	TTL	TXOP of the Ethernet PHY.
U0Rx	26	PA0 (1)	I	TTL	UART module 0 receive. When in IrDA mode, this signal has IrDA modulation.
U0Tx	27	PA1 (1)	O	TTL	UART module 0 transmit. When in IrDA mode, this signal has IrDA modulation.
U1CTS	2	PE6 (9)	I	TTL	UART module 1 Clear To Send modem status input signal.
	10	PD0 (9)			
	34	PA6 (9)			
	50	PJ3 (9)			
U1DCD	1	PE7 (9)	I	TTL	UART module 1 Data Carrier Detect modem status input signal.
	11	PD1 (9)			
	35	PA7 (9)			
	52	PJ4 (9)			
U1DSR	47	PF0 (9)	I	TTL	UART module 1 Data Set Ready modem output control line.
	53	PJ5 (9)			
U1DTR	55	PJ7 (9)	O	TTL	UART module 1 Data Terminal Ready modem status input signal.
	100	PD7 (9)			
U1RI	97	PD4 (9)	I	TTL	UART module 1 Ring Indicator modem status input signal.
U1RTS	54	PJ6 (9)	O	TTL	UART module 1 Request to Send modem output control line.
	61	PF1 (9)			
U1Rx	10	PD0 (5)	I	TTL	UART module 1 receive. When in IrDA mode, this signal has IrDA modulation.
	12	PD2 (1)			
	23	PC6 (5)			
	26	PA0 (9)			
	66	PB0 (5)			
	92	PB4 (7)			

Table 25-3. Signals by Signal Name (continued)

Pin Name	Pin Number	Pin Mux / Pin Assignment	Pin Type	Buffer Type <sup>a</sup>	Description
U1Tx	11 13 22 27 67 91	PD1 (5) PD3 (1) PC7 (5) PA1 (9) PB1 (5) PB5 (7)	O	TTL	UART module 1 transmit. When in IrDA mode, this signal has IrDA modulation.
U2Rx	10 19 92 98	PD0 (4) PG0 (1) PB4 (4) PD5 (9)	I	TTL	UART module 2 receive. When in IrDA mode, this signal has IrDA modulation.
U2Tx	6 11 18 99	PE4 (5) PD1 (4) PG1 (1) PD6 (9)	O	TTL	UART module 2 transmit. When in IrDA mode, this signal has IrDA modulation.
USB0DM	70	fixed	I/O	Analog	Bidirectional differential data pin (D- per USB specification).
USB0DP	71	fixed	I/O	Analog	Bidirectional differential data pin (D+ per USB specification).
USB0EPEN	19 24 34 72 83	PG0 (7) PC5 (6) PA6 (8) PB2 (8) PH3 (4)	O	TTL	Optionally used in Host mode to control an external power source to supply power to the USB bus.
USB0ID	66	PB0	I	Analog	This signal senses the state of the USB ID signal. The USB PHY enables an integrated pull-up, and an external element (USB connector) indicates the initial state of the USB controller (pulled down is the A side of the cable and pulled up is the B side).
USB0PFLT	22 23 35 65 74 76 87	PC7 (6) PC6 (7) PA7 (8) PB3 (8) PE0 (9) PH4 (4) PJ1 (9)	I	TTL	Optionally used in Host mode by an external power source to indicate an error state by that power source.
USB0RBIAS	73	fixed	O	Analog	9.1-kΩ resistor (1% precision) used internally for USB analog circuitry.
USB0VBUS	67	PB1	I/O	Analog	This signal is used during the session request protocol. This signal allows the USB PHY to both sense the voltage level of VBUS, and pull up VBUS momentarily during VBUS pulsing.
VDD	8 20 32 44 56 68 81 93	fixed	-	Power	Positive supply for I/O and some logic.

Table 25-3. Signals by Signal Name (continued)

Pin Name	Pin Number	Pin Mux / Pin Assignment	Pin Type	Buffer Type <sup>a</sup>	Description
VDDA	3	fixed	-	Power	The positive supply (3.3 V) for the analog circuits (ADC, Analog Comparators, etc.). These are separated from VDD to minimize the electrical noise contained on VDD from affecting the analog functions. VDDA pins must be connected to 3.3 V, regardless of system implementation.
VDDC	38 88	fixed	-	Power	Positive supply for most of the logic function, including the processor core and most peripherals.
VREFA	90	PB6	I	Analog	This input provides a reference voltage used to specify the input voltage at which the ADC converts to a maximum value. In other words, the voltage that is applied to VREFA is the voltage with which an AIN <sub>n</sub> signal is converted to 1023. The VREFA input is limited to the range specified in Table 27-2 on page 1205.
XTALNPHY	17	fixed	O	Analog	Ethernet PHY XTALN 25-MHz oscillator crystal output.
XTALPPHY	16	fixed	I	Analog	Ethernet PHY XTALP 25-MHz oscillator crystal input.

a. The TTL designation indicates the pin has TTL-compatible voltage levels.

Table 25-4. Signals by Function, Except for GPIO

Function	Pin Name	Pin Number	Pin Type	Buffer Type <sup>a</sup>	Description
ADC	AIN0	1	I	Analog	Analog-to-digital converter input 0.
	AIN1	2	I	Analog	Analog-to-digital converter input 1.
	AIN2	5	I	Analog	Analog-to-digital converter input 2.
	AIN3	6	I	Analog	Analog-to-digital converter input 3.
	AIN4	100	I	Analog	Analog-to-digital converter input 4.
	AIN5	99	I	Analog	Analog-to-digital converter input 5.
	AIN6	98	I	Analog	Analog-to-digital converter input 6.
	AIN7	97	I	Analog	Analog-to-digital converter input 7.
	AIN8	96	I	Analog	Analog-to-digital converter input 8.
	AIN9	95	I	Analog	Analog-to-digital converter input 9.
	AIN10	92	I	Analog	Analog-to-digital converter input 10.
	AIN11	91	I	Analog	Analog-to-digital converter input 11.
	AIN12	13	I	Analog	Analog-to-digital converter input 12.
	AIN13	12	I	Analog	Analog-to-digital converter input 13.
	AIN14	11	I	Analog	Analog-to-digital converter input 14.
	AIN15	10	I	Analog	Analog-to-digital converter input 15.
	VREFA	90	I	Analog	This input provides a reference voltage used to specify the input voltage at which the ADC converts to a maximum value. In other words, the voltage that is applied to VREFA is the voltage with which an AIN <sub>n</sub> signal is converted to 1023. The VREFA input is limited to the range specified in Table 27-2 on page 1205.

Table 25-4. Signals by Function, Except for GPIO (continued)

Function	Pin Name	Pin Number	Pin Type	Buffer Type <sup>a</sup>	Description
Analog Comparators	C0+	90	I	Analog	Analog comparator 0 positive input.
	C0-	92	I	Analog	Analog comparator 0 negative input.
	C0o	24	O	TTL	Analog comparator 0 output.
		42			
		90			
		91			
	100				
	C1+	24	I	Analog	Analog comparator 1 positive input.
	C1-	91	I	Analog	Analog comparator 1 negative input.
	C1o	2	O	TTL	Analog comparator 1 output.
22					
24					
41					
84					
C2+	23	I	Analog	Analog comparator 2 positive input.	
C2-	22	I	Analog	Analog comparator 2 negative input.	
C2o	1	O	TTL	Analog comparator 2 output.	
	23				
Controller Area Network	CAN0Rx	10	I	TTL	CAN module 0 receive.
		30			
		34			
		92			
	CAN0Tx	11	O	TTL	CAN module 0 transmit.
31					
35					
91					
CAN1Rx	47	I	TTL	CAN module 1 receive.	
CAN1Tx	61	O	TTL	CAN module 1 transmit.	
Ethernet	ERBIAS	33	O	Analog	12.4-kΩ resistor (1% precision) used internally for Ethernet PHY.
	LED0	59	O	TTL	Ethernet LED 0.
	LED1	60	O	TTL	Ethernet LED 1.
	MDIO	58	I/O	OD	MDIO of the Ethernet PHY.
	RXIN	37	I	Analog	RXIN of the Ethernet PHY.
	RXIP	40	I	Analog	RXIP of the Ethernet PHY.
	TXON	46	O	TTL	TXON of the Ethernet PHY.
	TXOP	43	O	TTL	TXOP of the Ethernet PHY.
	XTALNPHY	17	O	Analog	Ethernet PHY XTALN 25-MHz oscillator crystal output.
	XTALPPHY	16	I	Analog	Ethernet PHY XTALP 25-MHz oscillator crystal input.



Table 25-4. Signals by Function, Except for GPIO (continued)

Function	Pin Name	Pin Number	Pin Type	Buffer Type <sup>a</sup>	Description
External Peripheral Interface	EPI0S0	83	I/O	TTL	EPI module 0 signal 0.
	EPI0S1	84	I/O	TTL	EPI module 0 signal 1.
	EPI0S2	25	I/O	TTL	EPI module 0 signal 2.
	EPI0S3	24	I/O	TTL	EPI module 0 signal 3.
	EPI0S4	23	I/O	TTL	EPI module 0 signal 4.
	EPI0S5	22	I/O	TTL	EPI module 0 signal 5.
	EPI0S6	86	I/O	TTL	EPI module 0 signal 6.
	EPI0S7	85	I/O	TTL	EPI module 0 signal 7.
	EPI0S8	74	I/O	TTL	EPI module 0 signal 8.
	EPI0S9	75	I/O	TTL	EPI module 0 signal 9.
	EPI0S10	76	I/O	TTL	EPI module 0 signal 10.
	EPI0S11	63	I/O	TTL	EPI module 0 signal 11.
	EPI0S12	42	I/O	TTL	EPI module 0 signal 12.
	EPI0S13	19	I/O	TTL	EPI module 0 signal 13.
	EPI0S14	18	I/O	TTL	EPI module 0 signal 14.
	EPI0S15	41	I/O	TTL	EPI module 0 signal 15.
	EPI0S16	14	I/O	TTL	EPI module 0 signal 16.
	EPI0S17	87	I/O	TTL	EPI module 0 signal 17.
	EPI0S18	39	I/O	TTL	EPI module 0 signal 18.
	EPI0S19	50 97	I/O	TTL	EPI module 0 signal 19.
	EPI0S20	12	I/O	TTL	EPI module 0 signal 20.
	EPI0S21	13	I/O	TTL	EPI module 0 signal 21.
	EPI0S22	91	I/O	TTL	EPI module 0 signal 22.
	EPI0S23	92	I/O	TTL	EPI module 0 signal 23.
	EPI0S24	95	I/O	TTL	EPI module 0 signal 24.
	EPI0S25	96	I/O	TTL	EPI module 0 signal 25.
	EPI0S26	62	I/O	TTL	EPI module 0 signal 26.
	EPI0S27	15	I/O	TTL	EPI module 0 signal 27.
	EPI0S28	52 98	I/O	TTL	EPI module 0 signal 28.
	EPI0S29	53 99	I/O	TTL	EPI module 0 signal 29.
	EPI0S30	54 100	I/O	TTL	EPI module 0 signal 30.
EPI0S31	36	I/O	TTL	EPI module 0 signal 31.	

Table 25-4. Signals by Function, Except for GPIO (continued)

Function	Pin Name	Pin Number	Pin Type	Buffer Type <sup>a</sup>	Description
General-Purpose Timers	CCP0	13	I/O	TTL	Capture/Compare/PWM 0.
		22			
		23			
		39			
		42			
		55			
		66			
		72			
		91			
97					
CCP1	24	25	I/O	TTL	Capture/Compare/PWM 1.
		34			
		54			
		67			
		90			
		96			
		100			
CCP2	6	11	I/O	TTL	Capture/Compare/PWM 2.
		25			
		41			
		53			
		67			
		75			
		91			
		95			
98					
CCP3	6	23	I/O	TTL	Capture/Compare/PWM 3.
		24			
		35			
		61			
		72			
		74			
		97			
CCP4	22	25	I/O	TTL	Capture/Compare/PWM 4.
		35			
		52			
		95			
		98			
CCP5	5	12	I/O	TTL	Capture/Compare/PWM 5.
		25			
		36			
		90			
		91			
CCP6	10	12	I/O	TTL	Capture/Compare/PWM 6.
		50			
		75			
		86			
		91			
CCP7			I/O	TTL	Capture/Compare/PWM 7.

Table 25-4. Signals by Function, Except for GPIO (continued)

Function	Pin Name	Pin Number	Pin Type	Buffer Type <sup>a</sup>	Description
		11 13 85 90 96			
I2C	I2C0SCL	72	I/O	OD	I <sup>2</sup> C module 0 clock.
	I2C0SDA	65	I/O	OD	I <sup>2</sup> C module 0 data.
	I2C1SCL	14 19 26 34	I/O	OD	I <sup>2</sup> C module 1 clock.
	I2C1SDA	18 27 35 87	I/O	OD	I <sup>2</sup> C module 1 data.
I2S	I2S0RXMCLK	29 98	I/O	TTL	I <sup>2</sup> S module 0 receive master clock.
	I2S0RXSCK	10	I/O	TTL	I <sup>2</sup> S module 0 receive clock.
	I2S0RXSD	28 97	I/O	TTL	I <sup>2</sup> S module 0 receive data.
	I2S0RXWS	11	I/O	TTL	I <sup>2</sup> S module 0 receive word select.
	I2S0TXMCLK	61	I/O	TTL	I <sup>2</sup> S module 0 transmit master clock.
	I2S0TXSCK	30 90 99	I/O	TTL	I <sup>2</sup> S module 0 transmit clock.
	I2S0TXSD	5 47	I/O	TTL	I <sup>2</sup> S module 0 transmit data.
	I2S0TXWS	6 31 100	I/O	TTL	I <sup>2</sup> S module 0 transmit word select.
JTAG/SWD/SWO	SWCLK	80	I	TTL	JTAG/SWD CLK.
	SWDIO	79	I/O	TTL	JTAG TMS and SWDIO.
	SWO	77	O	TTL	JTAG TDO and SWO.
	TCK	80	I	TTL	JTAG/SWD CLK.
	TDI	78	I	TTL	JTAG TDI.
	TDO	77	O	TTL	JTAG TDO and SWO.
	TMS	79	I	TTL	JTAG TMS and SWDIO.

Table 25-4. Signals by Function, Except for GPIO (continued)

Function	Pin Name	Pin Number	Pin Type	Buffer Type <sup>a</sup>	Description
PWM	Fault0	6	I	TTL	PWM Fault 0.
		39			
		42			
		65			
		75			
	Fault1	90	I	TTL	PWM Fault 1.
		63			
	Fault2	24	I	TTL	PWM Fault 2.
		63			
	Fault3	65	I	TTL	PWM Fault 3.
		84			
	PWM0		10	O	TTL
14					
19					
34					
47					
PWM1		11	O	TTL	PWM 1. This signal is controlled by PWM Generator 0.
		18			
		35			
		61			
PWM2		12	O	TTL	PWM 2. This signal is controlled by PWM Generator 1.
		60			
		66			
PWM3		13	O	TTL	PWM 3. This signal is controlled by PWM Generator 1.
		59			
		67			
PWM4		2	O	TTL	PWM 4. This signal is controlled by PWM Generator 2.
		19			
		28			
		34			
		60			
		62			
PWM5		1	O	TTL	PWM 5. This signal is controlled by PWM Generator 2.
		15			
		18			
		29			
		35			
PWM6		25	O	TTL	PWM 6. This signal is controlled by PWM Generator 3.
		30			
		30			
PWM7		23	O	TTL	PWM 7. This signal is controlled by PWM Generator 3.
		31			
		36			

Table 25-4. Signals by Function, Except for GPIO (continued)

Function	Pin Name	Pin Number	Pin Type	Buffer Type <sup>a</sup>	Description
Power	GND	9 21 45 57 69 82 94	-	Power	Ground reference for logic and I/O pins.
	GNDA	4	-	Power	The ground reference for the analog circuits (ADC, Analog Comparators, etc.). These are separated from GND to minimize the electrical noise contained on VDD from affecting the analog functions.
	LDO	7	-	Power	Low drop-out regulator output voltage. This pin requires an external capacitor between the pin and GND of 1 $\mu$ F or greater. When the on-chip LDO is used to provide power to the logic, the LDO pin must also be connected to the VDDC pins at the board level in addition to the decoupling capacitor(s).
	VDD	8 20 32 44 56 68 81 93	-	Power	Positive supply for I/O and some logic.
	VDDA	3	-	Power	The positive supply (3.3 V) for the analog circuits (ADC, Analog Comparators, etc.). These are separated from VDD to minimize the electrical noise contained on VDD from affecting the analog functions. VDDA pins must be connected to 3.3 V, regardless of system implementation.
	VDDC	38 88	-	Power	Positive supply for most of the logic function, including the processor core and most peripherals.
QEI	IDX0	10 72 90 92 100	I	TTL	QEI module 0 index.
	IDX1	61 84	I	TTL	QEI module 1 index.
	PhA0	11 25 95	I	TTL	QEI module 0 phase A.
	PhA1	96	I	TTL	QEI module 1 phase A.
	PhB0	22 23 47 83 96	I	TTL	QEI module 0 phase B.
	PhB1	11 36 95	I	TTL	QEI module 1 phase B.

Table 25-4. Signals by Function, Except for GPIO (continued)

Function	Pin Name	Pin Number	Pin Type	Buffer Type <sup>a</sup>	Description
SSI	SSI0Clk	28	I/O	TTL	SSI module 0 clock.
	SSI0Fss	29	I/O	TTL	SSI module 0 frame.
	SSI0Rx	30	I	TTL	SSI module 0 receive.
	SSI0Tx	31	O	TTL	SSI module 0 transmit.
	SSI1Clk	60 74 76	I/O	TTL	SSI module 1 clock.
	SSI1Fss	59 63 75	I/O	TTL	SSI module 1 frame.
	SSI1Rx	42 62 95	I	TTL	SSI module 1 receive.
	SSI1Tx	15 41 96	O	TTL	SSI module 1 transmit.
System Control & Clocks	NMI	89	I	TTL	Non-maskable interrupt.
	OSC0	48	I	Analog	Main oscillator crystal input or an external clock reference input.
	OSC1	49	O	Analog	Main oscillator crystal output. Leave unconnected when using a single-ended clock source.
	RST	64	I	TTL	System reset input.

Table 25-4. Signals by Function, Except for GPIO (continued)

Function	Pin Name	Pin Number	Pin Type	Buffer Type <sup>a</sup>	Description
UART	U0Rx	26	I	TTL	UART module 0 receive. When in IrDA mode, this signal has IrDA modulation.
	U0Tx	27	O	TTL	UART module 0 transmit. When in IrDA mode, this signal has IrDA modulation.
	U1CTS	2 10 34 50	I	TTL	UART module 1 Clear To Send modem status input signal.
	U1DCD	1 11 35 52	I	TTL	UART module 1 Data Carrier Detect modem status input signal.
	U1DSR	47 53	I	TTL	UART module 1 Data Set Ready modem output control line.
	U1DTR	55 100	O	TTL	UART module 1 Data Terminal Ready modem status input signal.
	U1RI	97	I	TTL	UART module 1 Ring Indicator modem status input signal.
	U1RTS	54 61	O	TTL	UART module 1 Request to Send modem output control line.
	U1Rx	10 12 23 26 66 92	I	TTL	UART module 1 receive. When in IrDA mode, this signal has IrDA modulation.
	U1Tx	11 13 22 27 67 91	O	TTL	UART module 1 transmit. When in IrDA mode, this signal has IrDA modulation.
	U2Rx	10 19 92 98	I	TTL	UART module 2 receive. When in IrDA mode, this signal has IrDA modulation.
	U2Tx	6 11 18 99	O	TTL	UART module 2 transmit. When in IrDA mode, this signal has IrDA modulation.

Table 25-4. Signals by Function, Except for GPIO (continued)

Function	Pin Name	Pin Number	Pin Type	Buffer Type <sup>a</sup>	Description
USB	USB0DM	70	I/O	Analog	Bidirectional differential data pin (D- per USB specification).
	USB0DP	71	I/O	Analog	Bidirectional differential data pin (D+ per USB specification).
	USB0EPEN	19 24 34 72 83	O	TTL	Optionally used in Host mode to control an external power source to supply power to the USB bus.
	USB0ID	66	I	Analog	This signal senses the state of the USB ID signal. The USB PHY enables an integrated pull-up, and an external element (USB connector) indicates the initial state of the USB controller (pulled down is the A side of the cable and pulled up is the B side).
	USB0PFLT	22 23 35 65 74 76 87	I	TTL	Optionally used in Host mode by an external power source to indicate an error state by that power source.
	USB0RBIAS	73	O	Analog	9.1-kΩ resistor (1% precision) used internally for USB analog circuitry.
	USB0VBUS	67	I/O	Analog	This signal is used during the session request protocol. This signal allows the USB PHY to both sense the voltage level of VBUS, and pull up VBUS momentarily during VBUS pulsing.

a. The TTL designation indicates the pin has TTL-compatible voltage levels.

Table 25-5. GPIO Pins and Alternate Functions

IO	Pin	Analog Function	Digital Function (GPIOCTL PMCx Bit Field Encoding) <sup>a</sup>											
			1	2	3	4	5	6	7	8	9	10	11	
PA0	26	-	U0Rx	-	-	-	-	-	-	-	I2C1SCL	U1Rx	-	-
PA1	27	-	U0Tx	-	-	-	-	-	-	-	I2C1SDA	U1Tx	-	-
PA2	28	-	SSI0Clk	-	-	PWM4	-	-	-	-	I2S0RXSD	-	-	-
PA3	29	-	SSI0Fss	-	-	PWM5	-	-	-	-	I2S0RXCLK	-	-	-
PA4	30	-	SSI0Rx	-	-	PWM6	CAN0Rx	-	-	-	I2S0TXSCK	-	-	-
PA5	31	-	SSI0Tx	-	-	PWM7	CAN0Tx	-	-	-	I2S0TXWS	-	-	-
PA6	34	-	I2C1SCL	CCP1	-	PWM0	PWM4	CAN0Rx	-	USB0EPEN	U1CTS	-	-	-
PA7	35	-	I2C1SDA	CCP4	-	PWM1	PWM5	CAN0Tx	CCP3	USB0PFLT	U1DCD	-	-	-
PB0	66	USB0ID	CCP0	PWM2	-	-	U1Rx	-	-	-	-	-	-	-
PB1	67	USB0VBUS	CCP2	PWM3	-	CCP1	U1Tx	-	-	-	-	-	-	-
PB2	72	-	I2C0SCL	IDX0	-	CCP3	CCP0	-	-	USB0EPEN	-	-	-	-
PB3	65	-	I2C0SDA	Fault0	-	Fault3	-	-	-	USB0PFLT	-	-	-	-
PB4	92	AIN10 C0-	-	-	-	U2Rx	CAN0Rx	IDX0	U1Rx	EPI0S23	-	-	-	-
PB5	91	AIN11 C1-	C0o	CCP5	CCP6	CCP0	CAN0Tx	CCP2	U1Tx	EPI0S22	-	-	-	-



Table 25-5. GPIO Pins and Alternate Functions (continued)

IO	Pin	Analog Function	Digital Function (GPIOCTL PMCx Bit Field Encoding) <sup>a</sup>										
			1	2	3	4	5	6	7	8	9	10	11
PB6	90	VREFA C0+	CCP1	CCP7	C0o	Fault1	IDX0	CCP5	-	-	I2S0TXSCK	-	-
PB7	89	-	-	-	-	NMI	-	-	-	-	-	-	-
PC0	80	-	-	-	TCK SWCLK	-	-	-	-	-	-	-	-
PC1	79	-	-	-	TMS SWDIO	-	-	-	-	-	-	-	-
PC2	78	-	-	-	TDI	-	-	-	-	-	-	-	-
PC3	77	-	-	-	TDO SWO	-	-	-	-	-	-	-	-
PC4	25	-	CCP5	PhA0	-	PWM6	CCP2	CCP4	-	EPI0S2	CCP1	-	-
PC5	24	C1+	CCP1	C1o	C0o	Fault2	CCP3	USB0EPEN	-	EPI0S3	-	-	-
PC6	23	C2+	CCP3	PhB0	C2o	PWM7	U1Rx	CCP0	USB0PFLT	EPI0S4	-	-	-
PC7	22	C2-	CCP4	PhB0	-	CCP0	U1Tx	USB0PFLT	C1o	EPI0S5	-	-	-
PD0	10	AIN15	PWM0	CAN0Rx	IDX0	U2Rx	U1Rx	CCP6	-	I2S0RXSCK	U1CTS	-	-
PD1	11	AIN14	PWM1	CAN0Tx	PhA0	U2Tx	U1Tx	CCP7	-	I2S0RXWS	U1DCD	CCP2	PhB1
PD2	12	AIN13	U1Rx	CCP6	PWM2	CCP5	-	-	-	EPI0S20	-	-	-
PD3	13	AIN12	U1Tx	CCP7	PWM3	CCP0	-	-	-	EPI0S21	-	-	-
PD4	97	AIN7	CCP0	CCP3	-	-	-	-	-	I2S0RXSD	U1RI	EPI0S19	-
PD5	98	AIN6	CCP2	CCP4	-	-	-	-	-	I2S0RXCLK	U2Rx	EPI0S28	-
PD6	99	AIN5	Fault0	-	-	-	-	-	-	I2S0TXSCK	U2Tx	EPI0S29	-
PD7	100	AIN4	IDX0	C0o	CCP1	-	-	-	-	I2S0TXWS	U1DTR	EPI0S30	-
PE0	74	-	PWM4	SSI1Clk	CCP3	-	-	-	-	EPI0S8	USB0PFLT	-	-
PE1	75	-	PWM5	SSI1Fss	Fault0	CCP2	CCP6	-	-	EPI0S9	-	-	-
PE2	95	AIN9	CCP4	SSI1Rx	PhB1	PhA0	CCP2	-	-	EPI0S24	-	-	-
PE3	96	AIN8	CCP1	SSI1Tx	PhA1	PhB0	CCP7	-	-	EPI0S25	-	-	-
PE4	6	AIN3	CCP3	-	-	Fault0	U2Tx	CCP2	-	-	I2S0TXWS	-	-
PE5	5	AIN2	CCP5	-	-	-	-	-	-	-	I2S0TXSD	-	-
PE6	2	AIN1	PWM4	C1o	-	-	-	-	-	-	U1CTS	-	-
PE7	1	AIN0	PWM5	C2o	-	-	-	-	-	-	U1DCD	-	-
PF0	47	-	CAN1Rx	PhB0	PWM0	-	-	-	-	I2S0TXSD	U1DSR	-	-
PF1	61	-	CAN1Tx	IDX1	PWM1	-	-	-	-	I2S0TXCLK	U1RTS	CCP3	-
PF2	60	-	LED1	PWM4	-	PWM2	-	-	-	-	SSI1Clk	-	-
PF3	59	-	LED0	PWM5	-	PWM3	-	-	-	-	SSI1Fss	-	-
PF4	42	-	CCP0	C0o	-	Fault0	-	-	-	EPI0S12	SSI1Rx	-	-
PF5	41	-	CCP2	C1o	-	-	-	-	-	EPI0S15	SSI1Tx	-	-
PG0	19	-	U2Rx	PWM0	I2C1SCL	PWM4	-	-	USB0EPEN	EPI0S13	-	-	-
PG1	18	-	U2Tx	PWM1	I2C1SDA	PWM5	-	-	-	EPI0S14	-	-	-
PG7	36	-	PhB1	-	-	PWM7	-	-	-	CCP5	EPI0S31	-	-
PH0	86	-	CCP6	PWM2	-	-	-	-	-	EPI0S6	PWM4	-	-
PH1	85	-	CCP7	PWM3	-	-	-	-	-	EPI0S7	PWM5	-	-
PH2	84	-	IDX1	C1o	-	Fault3	-	-	-	EPI0S1	-	-	-

Table 25-5. GPIO Pins and Alternate Functions (continued)

IO	Pin	Analog Function	Digital Function (GPIOCTL PMCx Bit Field Encoding) <sup>a</sup>										
			1	2	3	4	5	6	7	8	9	10	11
PH3	83	-	PhB0	Fault0	-	USBOEPEN	-	-	-	EPIOS0	-	-	-
PH4	76	-	-	-	-	USB0PFLT	-	-	-	EPIOS10	-	-	SSI1Clk
PH5	63	-	-	-	-	-	-	-	-	EPIOS11	-	Fault2	SSI1Fss
PH6	62	-	-	-	-	-	-	-	-	EPIOS26	-	PWM4	SSI1Rx
PH7	15	-	-	-	-	-	-	-	-	EPIOS27	-	PWM5	SSI1Tx
PJ0	14	-	-	-	-	-	-	-	-	EPIOS16	-	PWM0	I2C1SCL
PJ1	87	-	-	-	-	-	-	-	-	EPIOS17	USB0PFLT	PWM1	I2C1SDA
PJ2	39	-	-	-	-	-	-	-	-	EPIOS18	CCP0	Fault0	-
PJ3	50	-	-	-	-	-	-	-	-	EPIOS19	U1CTS	CCP6	-
PJ4	52	-	-	-	-	-	-	-	-	EPIOS28	U1DCD	CCP4	-
PJ5	53	-	-	-	-	-	-	-	-	EPIOS29	U1DSR	CCP2	-
PJ6	54	-	-	-	-	-	-	-	-	EPIOS30	U1RTS	CCP1	-
PJ7	55	-	-	-	-	-	-	-	-	-	U1DTR	CCP0	-

a. The digital signals that are shaded gray are the power-on default values for the corresponding GPIO pin.

Table 25-6. Possible Pin Assignments for Alternate Functions

# of Possible Assignments	Alternate Function	GPIO Function
one	AIN0	PE7
	AIN1	PE6
	AIN10	PB4
	AIN11	PB5
	AIN12	PD3
	AIN13	PD2
	AIN14	PD1
	AIN15	PD0
	AIN2	PE5
	AIN3	PE4
	AIN4	PD7
	AIN5	PD6
	AIN6	PD5
	AIN7	PD4
	AIN8	PE3
	AIN9	PE2
	C0+	PB6
	C0-	PB4
	C1+	PC5
	C1-	PB5
	C2+	PC6
	C2-	PC7
	CAN1Rx	PF0
	CAN1Tx	PF1
	Fault1	PB6
	I2C0SCL	PB2
	I2C0SDA	PB3
	I2S0RXSCK	PD0
	I2S0RXWS	PD1
	I2S0TXMCLK	PF1
	LED0	PF3
	LED1	PF2
	NMI	PB7
	PhA1	PE3
	SSI0Clk	PA2
	SSI0Fss	PA3
	SSI0Rx	PA4
	SSI0Tx	PA5
	SWCLK	PC0
	SWDIO	PC1
	SWO	PC3

Table 25-6. Possible Pin Assignments for Alternate Functions (continued)

# of Possible Assignments	Alternate Function	GPIO Function
	TCK	PC0
	TDI	PC2
	TDO	PC3
	TMS	PC1
	U0Rx	PA0
	U0Tx	PA1
	U1RI	PD4
	USB0ID	PB0
	USB0VBUS	PB1
	VREFA	PB6
two	C2o	PC6 PE7
	Fault2	PC5 PH5
	Fault3	PB3 PH2
	I2S0RXMCLK	PA3 PD5
	I2S0RXSD	PA2 PD4
	I2S0TXSD	PE5 PF0
	IDX1	PF1 PH2
	PWM6	PA4 PC4
	U1DSR	PF0 PJ5
	U1DTR	PD7 PJ7
	U1RTS	PF1 PJ6
three	I2S0TXSCK	PA4 PB6 PD6
	I2S0TXWS	PA5 PD7 PE4
	PWM7	PA5 PC6 PG7
	PhA0	PC4 PD1 PE2
	PhB1	PD1 PE2 PG7
	SSI1Clk	PE0 PF2 PH4
	SSI1Fss	PE1 PF3 PH5
	SSI1Rx	PE2 PF4 PH6
	SSI1Tx	PE3 PF5 PH7
four	CAN0Rx	PA4 PA6 PB4 PD0
	CAN0Tx	PA5 PA7 PB5 PD1
	I2C1SCL	PA0 PA6 PG0 PJ0
	I2C1SDA	PA1 PA7 PG1 PJ1
	PWM2	PB0 PD2 PF2 PH0
	PWM3	PB1 PD3 PF3 PH1
	U1CTS	PA6 PD0 PE6 PJ3
	U1DCD	PA7 PD1 PE7 PJ4
	U2Rx	PB4 PD0 PD5 PG0
	U2Tx	PD1 PD6 PE4 PG1

Table 25-6. Possible Pin Assignments for Alternate Functions (continued)

# of Possible Assignments	Alternate Function	GPIO Function
five	C0o	PB5 PB6 PC5 PD7 PF4
	C1o	PC5 PC7 PE6 PF5 PH2
	CCP7	PB6 PD1 PD3 PE3 PH1
	IDX0	PB2 PB4 PB6 PD0 PD7
	PWM0	PA6 PD0 PF0 PG0 PJ0
	PWM1	PA7 PD1 PF1 PG1 PJ1
	PhB0	PC6 PC7 PE3 PF0 PH3
	USB0EPEN	PA6 PB2 PC5 PG0 PH3
six	CCP4	PA7 PC4 PC7 PD5 PE2 PJ4
	CCP5	PB5 PB6 PC4 PD2 PE5 PG7
	CCP6	PB5 PD0 PD2 PE1 PH0 PJ3
	U1Rx	PA0 PB0 PB4 PC6 PD0 PD2
	U1Tx	PA1 PB1 PB5 PC7 PD1 PD3
seven	Fault0	PB3 PD6 PE1 PE4 PF4 PH3 PJ2
	USB0PFLT	PA7 PB3 PC6 PC7 PE0 PH4 PJ1
eight	CCP1	PA6 PB1 PB6 PC4 PC5 PD7 PE3 PJ6
	CCP3	PA7 PB2 PC5 PC6 PD4 PE0 PE4 PF1
	PWM4	PA2 PA6 PE0 PE6 PF2 PG0 PH0 PH6
	PWM5	PA3 PA7 PE1 PE7 PF3 PG1 PH1 PH7
ten	CCP0	PB0 PB2 PB5 PC6 PC7 PD3 PD4 PF4 PJ2 PJ7
	CCP2	PB1 PB5 PC4 PD1 PD5 PE1 PE2 PE4 PF5 PJ5

## 25.2 108-Pin BGA Package Pin Tables

Table 25-7. Signals by Pin Number

Pin Number	Pin Name	Pin Type	Buffer Type <sup>a</sup>	Description
A1	PE6	I/O	TTL	GPIO port E bit 6.
	AIN1	I	Analog	Analog-to-digital converter input 1.
	C1o	O	TTL	Analog comparator 1 output.
	PWM4	O	TTL	PWM 4. This signal is controlled by PWM Generator 2.
	U1CTS	I	TTL	UART module 1 Clear To Send modem status input signal.
A2	PD7	I/O	TTL	GPIO port D bit 7.
	AIN4	I	Analog	Analog-to-digital converter input 4.
	C0o	O	TTL	Analog comparator 0 output.
	CCP1	I/O	TTL	Capture/Compare/PWM 1.
	EPI0S30	I/O	TTL	EPI module 0 signal 30.
	I2S0TXWS	I/O	TTL	I <sup>2</sup> S module 0 transmit word select.
	IDX0	I	TTL	QE1 module 0 index.
	U1DTR	O	TTL	UART module 1 Data Terminal Ready modem status input signal.

Table 25-7. Signals by Pin Number (continued)

Pin Number	Pin Name	Pin Type	Buffer Type <sup>a</sup>	Description
A3	PD6	I/O	TTL	GPIO port D bit 6.
	AIN5	I	Analog	Analog-to-digital converter input 5.
	EPI0S29	I/O	TTL	EPI module 0 signal 29.
	Fault0	I	TTL	PWM Fault 0.
	I2S0TXSCK	I/O	TTL	I <sup>2</sup> S module 0 transmit clock.
	U2Tx	O	TTL	UART module 2 transmit. When in IrDA mode, this signal has IrDA modulation.
A4	PE2	I/O	TTL	GPIO port E bit 2.
	AIN9	I	Analog	Analog-to-digital converter input 9.
	CCP2	I/O	TTL	Capture/Compare/PWM 2.
	CCP4	I/O	TTL	Capture/Compare/PWM 4.
	EPI0S24	I/O	TTL	EPI module 0 signal 24.
	PhA0	I	TTL	QE1 module 0 phase A.
	PhB1	I	TTL	QE1 module 1 phase B.
	SSI1Rx	I	TTL	SSI module 1 receive.
A5	GNDA	-	Power	The ground reference for the analog circuits (ADC, Analog Comparators, etc.). These are separated from GND to minimize the electrical noise contained on VDD from affecting the analog functions.
A6	PB4	I/O	TTL	GPIO port B bit 4.
	AIN10	I	Analog	Analog-to-digital converter input 10.
	C0-	I	Analog	Analog comparator 0 negative input.
	CAN0Rx	I	TTL	CAN module 0 receive.
	EPI0S23	I/O	TTL	EPI module 0 signal 23.
	IDX0	I	TTL	QE1 module 0 index.
	U1Rx	I	TTL	UART module 1 receive. When in IrDA mode, this signal has IrDA modulation.
	U2Rx	I	TTL	UART module 2 receive. When in IrDA mode, this signal has IrDA modulation.
A7	PB6	I/O	TTL	GPIO port B bit 6.
	C0+	I	Analog	Analog comparator 0 positive input.
	C0o	O	TTL	Analog comparator 0 output.
	CCP1	I/O	TTL	Capture/Compare/PWM 1.
	CCP5	I/O	TTL	Capture/Compare/PWM 5.
	CCP7	I/O	TTL	Capture/Compare/PWM 7.
	Fault1	I	TTL	PWM Fault 1.
	I2S0TXSCK	I/O	TTL	I <sup>2</sup> S module 0 transmit clock.
	IDX0	I	TTL	QE1 module 0 index.
	VREFA	I	Analog	This input provides a reference voltage used to specify the input voltage at which the ADC converts to a maximum value. In other words, the voltage that is applied to VREFA is the voltage with which an AIN <sub>n</sub> signal is converted to 1023. The VREFA input is limited to the range specified in Table 27-2 on page 1205.

Table 25-7. Signals by Pin Number (continued)

Pin Number	Pin Name	Pin Type	Buffer Type <sup>a</sup>	Description
A8	PB7	I/O	TTL	GPIO port B bit 7.
	NMI	I	TTL	Non-maskable interrupt.
A9	PC0	I/O	TTL	GPIO port C bit 0.
	SWCLK	I	TTL	JTAG/SWD CLK.
	TCK	I	TTL	JTAG/SWD CLK.
A10	PC3	I/O	TTL	GPIO port C bit 3.
	SWO	O	TTL	JTAG TDO and SWO.
	TDO	O	TTL	JTAG TDO and SWO.
A11	PB2	I/O	TTL	GPIO port B bit 2.
	CCP0	I/O	TTL	Capture/Compare/PWM 0.
	CCP3	I/O	TTL	Capture/Compare/PWM 3.
	I2C0SCL	I/O	OD	I <sup>2</sup> C module 0 clock.
	IDX0	I	TTL	QEI module 0 index.
	USB0EPEN	O	TTL	Optionally used in Host mode to control an external power source to supply power to the USB bus.
A12	PE1	I/O	TTL	GPIO port E bit 1.
	CCP2	I/O	TTL	Capture/Compare/PWM 2.
	CCP6	I/O	TTL	Capture/Compare/PWM 6.
	EPI0S9	I/O	TTL	EPI module 0 signal 9.
	Fault0	I	TTL	PWM Fault 0.
	PWM5	O	TTL	PWM 5. This signal is controlled by PWM Generator 2.
	SSI1Fss	I/O	TTL	SSI module 1 frame.
B1	PE7	I/O	TTL	GPIO port E bit 7.
	AIN0	I	Analog	Analog-to-digital converter input 0.
	C2o	O	TTL	Analog comparator 2 output.
	PWM5	O	TTL	PWM 5. This signal is controlled by PWM Generator 2.
	U1DCD	I	TTL	UART module 1 Data Carrier Detect modem status input signal.
B2	PE4	I/O	TTL	GPIO port E bit 4.
	AIN3	I	Analog	Analog-to-digital converter input 3.
	CCP2	I/O	TTL	Capture/Compare/PWM 2.
	CCP3	I/O	TTL	Capture/Compare/PWM 3.
	Fault0	I	TTL	PWM Fault 0.
	I2S0TXWS	I/O	TTL	I <sup>2</sup> S module 0 transmit word select.
	U2Tx	O	TTL	UART module 2 transmit. When in IrDA mode, this signal has IrDA modulation.
B3	PE5	I/O	TTL	GPIO port E bit 5.
	AIN2	I	Analog	Analog-to-digital converter input 2.
	CCP5	I/O	TTL	Capture/Compare/PWM 5.
	I2S0TXSD	I/O	TTL	I <sup>2</sup> S module 0 transmit data.

Table 25-7. Signals by Pin Number (continued)

Pin Number	Pin Name	Pin Type	Buffer Type <sup>a</sup>	Description
B4	PE3	I/O	TTL	GPIO port E bit 3.
	AIN8	I	Analog	Analog-to-digital converter input 8.
	CCP1	I/O	TTL	Capture/Compare/PWM 1.
	CCP7	I/O	TTL	Capture/Compare/PWM 7.
	EPI0S25	I/O	TTL	EPI module 0 signal 25.
	PhA1	I	TTL	QEI module 1 phase A.
	PhB0	I	TTL	QEI module 0 phase B.
	SSI1Tx	O	TTL	SSI module 1 transmit.
B5	PD4	I/O	TTL	GPIO port D bit 4.
	AIN7	I	Analog	Analog-to-digital converter input 7.
	CCP0	I/O	TTL	Capture/Compare/PWM 0.
	CCP3	I/O	TTL	Capture/Compare/PWM 3.
	EPI0S19	I/O	TTL	EPI module 0 signal 19.
	I2S0RXSD	I/O	TTL	I <sup>2</sup> S module 0 receive data.
	U1RI	I	TTL	UART module 1 Ring Indicator modem status input signal.
B6	EPI0S17	I/O	TTL	EPI module 0 signal 17.
	I2C1SDA	I/O	OD	I <sup>2</sup> C module 1 data.
	PJ1	I/O	TTL	GPIO port J bit 1.
	PWM1	O	TTL	PWM 1. This signal is controlled by PWM Generator 0.
	USB0PFLT	I	TTL	Optionally used in Host mode by an external power source to indicate an error state by that power source.
B7	PB5	I/O	TTL	GPIO port B bit 5.
	AIN11	I	Analog	Analog-to-digital converter input 11.
	C0o	O	TTL	Analog comparator 0 output.
	C1-	I	Analog	Analog comparator 1 negative input.
	CAN0Tx	O	TTL	CAN module 0 transmit.
	CCP0	I/O	TTL	Capture/Compare/PWM 0.
	CCP2	I/O	TTL	Capture/Compare/PWM 2.
	CCP5	I/O	TTL	Capture/Compare/PWM 5.
	CCP6	I/O	TTL	Capture/Compare/PWM 6.
	EPI0S22	I/O	TTL	EPI module 0 signal 22.
	U1Tx	O	TTL	UART module 1 transmit. When in IrDA mode, this signal has IrDA modulation.
B8	PC2	I/O	TTL	GPIO port C bit 2.
	TDI	I	TTL	JTAG TDI.
B9	PC1	I/O	TTL	GPIO port C bit 1.
	SWDIO	I/O	TTL	JTAG TMS and SWDIO.
	TMS	I	TTL	JTAG TMS and SWDIO.



Table 25-7. Signals by Pin Number (continued)

Pin Number	Pin Name	Pin Type	Buffer Type <sup>a</sup>	Description
B10	PH4	I/O	TTL	GPIO port H bit 4.
	EPI0S10	I/O	TTL	EPI module 0 signal 10.
	SSI1Clk	I/O	TTL	SSI module 1 clock.
	USB0PFLT	I	TTL	Optionally used in Host mode by an external power source to indicate an error state by that power source.
B11	PE0	I/O	TTL	GPIO port E bit 0.
	CCP3	I/O	TTL	Capture/Compare/PWM 3.
	EPI0S8	I/O	TTL	EPI module 0 signal 8.
	PWM4	O	TTL	PWM 4. This signal is controlled by PWM Generator 2.
	SSI1Clk	I/O	TTL	SSI module 1 clock.
	USB0PFLT	I	TTL	Optionally used in Host mode by an external power source to indicate an error state by that power source.
B12	USB0RBIAS	O	Analog	9.1-kΩ resistor (1% precision) used internally for USB analog circuitry.
C1	NC	-	-	No connect. Leave the pin electrically unconnected/isolated.
C2	NC	-	-	No connect. Leave the pin electrically unconnected/isolated.
C3	VDDC	-	Power	Positive supply for most of the logic function, including the processor core and most peripherals.
C4	GND	-	Power	Ground reference for logic and I/O pins.
C5	GND	-	Power	Ground reference for logic and I/O pins.
C6	PD5	I/O	TTL	GPIO port D bit 5.
	AIN6	I	Analog	Analog-to-digital converter input 6.
	CCP2	I/O	TTL	Capture/Compare/PWM 2.
	CCP4	I/O	TTL	Capture/Compare/PWM 4.
	EPI0S28	I/O	TTL	EPI module 0 signal 28.
	I2S0RXMCLK	I/O	TTL	I <sup>2</sup> S module 0 receive master clock.
	U2Rx	I	TTL	UART module 2 receive. When in IrDA mode, this signal has IrDA modulation.
C7	VDDA	-	Power	The positive supply (3.3 V) for the analog circuits (ADC, Analog Comparators, etc.). These are separated from VDD to minimize the electrical noise contained on VDD from affecting the analog functions. VDDA pins must be connected to 3.3 V, regardless of system implementation.
C8	PH1	I/O	TTL	GPIO port H bit 1.
	CCP7	I/O	TTL	Capture/Compare/PWM 7.
	EPI0S7	I/O	TTL	EPI module 0 signal 7.
	PWM3	O	TTL	PWM 3. This signal is controlled by PWM Generator 1.
	PWM5	O	TTL	PWM 5. This signal is controlled by PWM Generator 2.
C9	PH0	I/O	TTL	GPIO port H bit 0.
	CCP6	I/O	TTL	Capture/Compare/PWM 6.
	EPI0S6	I/O	TTL	EPI module 0 signal 6.
	PWM2	O	TTL	PWM 2. This signal is controlled by PWM Generator 1.
	PWM4	O	TTL	PWM 4. This signal is controlled by PWM Generator 2.

Table 25-7. Signals by Pin Number (continued)

Pin Number	Pin Name	Pin Type	Buffer Type <sup>a</sup>	Description
C10	PG7	I/O	TTL	GPIO port G bit 7.
	CCP5	I/O	TTL	Capture/Compare/PWM 5.
	EPI0S31	I/O	TTL	EPI module 0 signal 31.
	PWM7	O	TTL	PWM 7. This signal is controlled by PWM Generator 3.
	PhB1	I	TTL	QE1 module 1 phase B.
C11	USB0DM	I/O	Analog	Bidirectional differential data pin (D- per USB specification).
C12	USB0DP	I/O	Analog	Bidirectional differential data pin (D+ per USB specification).
D1	NC	-	-	No connect. Leave the pin electrically unconnected/isolated.
D2	NC	-	-	No connect. Leave the pin electrically unconnected/isolated.
D3	VDDC	-	Power	Positive supply for most of the logic function, including the processor core and most peripherals.
D10	PH3	I/O	TTL	GPIO port H bit 3.
	EPI0S0	I/O	TTL	EPI module 0 signal 0.
	Fault0	I	TTL	PWM Fault 0.
	PhB0	I	TTL	QE1 module 0 phase B.
	USB0EPEN	O	TTL	Optionally used in Host mode to control an external power source to supply power to the USB bus.
D11	PH2	I/O	TTL	GPIO port H bit 2.
	C1o	O	TTL	Analog comparator 1 output.
	EPI0S1	I/O	TTL	EPI module 0 signal 1.
	Fault3	I	TTL	PWM Fault 3.
	IDX1	I	TTL	QE1 module 1 index.
D12	PB1	I/O	TTL	GPIO port B bit 1.
	CCP1	I/O	TTL	Capture/Compare/PWM 1.
	CCP2	I/O	TTL	Capture/Compare/PWM 2.
	PWM3	O	TTL	PWM 3. This signal is controlled by PWM Generator 1.
	U1Tx	O	TTL	UART module 1 transmit. When in IrDA mode, this signal has IrDA modulation.
	USB0VBUS	I/O	Analog	This signal is used during the session request protocol. This signal allows the USB PHY to both sense the voltage level of VBUS, and pull up VBUS momentarily during VBUS pulsing.
E1	NC	-	-	No connect. Leave the pin electrically unconnected/isolated.
E2	NC	-	-	No connect. Leave the pin electrically unconnected/isolated.
E3	LDO	-	Power	Low drop-out regulator output voltage. This pin requires an external capacitor between the pin and GND of 1 $\mu$ F or greater. When the on-chip LDO is used to provide power to the logic, the LDO pin must also be connected to the VDDC pins at the board level in addition to the decoupling capacitor(s).
E10	VDD	-	Power	Positive supply for I/O and some logic.

Table 25-7. Signals by Pin Number (continued)

Pin Number	Pin Name	Pin Type	Buffer Type <sup>a</sup>	Description
E11	PB3	I/O	TTL	GPIO port B bit 3.
	Fault0	I	TTL	PWM Fault 0.
	Fault3	I	TTL	PWM Fault 3.
	I2C0SDA	I/O	OD	I <sup>2</sup> C module 0 data.
	USB0PFLT	I	TTL	Optionally used in Host mode by an external power source to indicate an error state by that power source.
E12	PB0	I/O	TTL	GPIO port B bit 0.
	CCP0	I/O	TTL	Capture/Compare/PWM 0.
	PWM2	O	TTL	PWM 2. This signal is controlled by PWM Generator 1.
	U1Rx	I	TTL	UART module 1 receive. When in IrDA mode, this signal has IrDA modulation.
	USB0ID	I	Analog	This signal senses the state of the USB ID signal. The USB PHY enables an integrated pull-up, and an external element (USB connector) indicates the initial state of the USB controller (pulled down is the A side of the cable and pulled up is the B side).
F1	NC	-	-	No connect. Leave the pin electrically unconnected/isolated.
F2	NC	-	-	No connect. Leave the pin electrically unconnected/isolated.
F3	EPI0S16	I/O	TTL	EPI module 0 signal 16.
	I2C1SCL	I/O	OD	I <sup>2</sup> C module 1 clock.
	PJ0	I/O	TTL	GPIO port J bit 0.
	PWM0	O	TTL	PWM 0. This signal is controlled by PWM Generator 0.
F10	PH5	I/O	TTL	GPIO port H bit 5.
	EPI0S11	I/O	TTL	EPI module 0 signal 11.
	Fault2	I	TTL	PWM Fault 2.
	SSI1Fss	I/O	TTL	SSI module 1 frame.
F11	GND	-	Power	Ground reference for logic and I/O pins.
F12	GND	-	Power	Ground reference for logic and I/O pins.
G1	PD0	I/O	TTL	GPIO port D bit 0.
	AIN15	I	Analog	Analog-to-digital converter input 15.
	CAN0Rx	I	TTL	CAN module 0 receive.
	CCP6	I/O	TTL	Capture/Compare/PWM 6.
	I2S0RXSCK	I/O	TTL	I <sup>2</sup> S module 0 receive clock.
	IDX0	I	TTL	QEI module 0 index.
	PWM0	O	TTL	PWM 0. This signal is controlled by PWM Generator 0.
	U1CTS	I	TTL	UART module 1 Clear To Send modem status input signal.
	U1Rx	I	TTL	UART module 1 receive. When in IrDA mode, this signal has IrDA modulation.
	U2Rx	I	TTL	UART module 2 receive. When in IrDA mode, this signal has IrDA modulation.

Table 25-7. Signals by Pin Number (continued)

Pin Number	Pin Name	Pin Type	Buffer Type <sup>a</sup>	Description
G2	PD1	I/O	TTL	GPIO port D bit 1.
	AIN14	I	Analog	Analog-to-digital converter input 14.
	CAN0Tx	O	TTL	CAN module 0 transmit.
	CCP2	I/O	TTL	Capture/Compare/PWM 2.
	CCP7	I/O	TTL	Capture/Compare/PWM 7.
	I2S0RXWS	I/O	TTL	I <sup>2</sup> S module 0 receive word select.
	PWM1	O	TTL	PWM 1. This signal is controlled by PWM Generator 0.
	PhA0	I	TTL	QEI module 0 phase A.
	PhB1	I	TTL	QEI module 1 phase B.
	U1DCD	I	TTL	UART module 1 Data Carrier Detect modem status input signal.
	U1Tx	O	TTL	UART module 1 transmit. When in IrDA mode, this signal has IrDA modulation.
U2Tx	O	TTL	UART module 2 transmit. When in IrDA mode, this signal has IrDA modulation.	
G3	PH6	I/O	TTL	GPIO port H bit 6.
	EPI0S26	I/O	TTL	EPI module 0 signal 26.
	PWM4	O	TTL	PWM 4. This signal is controlled by PWM Generator 2.
	SSI1Rx	I	TTL	SSI module 1 receive.
G10	VDD	-	Power	Positive supply for I/O and some logic.
G11	VDD	-	Power	Positive supply for I/O and some logic.
G12	VDD	-	Power	Positive supply for I/O and some logic.
H1	PD3	I/O	TTL	GPIO port D bit 3.
	AIN12	I	Analog	Analog-to-digital converter input 12.
	CCP0	I/O	TTL	Capture/Compare/PWM 0.
	CCP7	I/O	TTL	Capture/Compare/PWM 7.
	EPI0S21	I/O	TTL	EPI module 0 signal 21.
	PWM3	O	TTL	PWM 3. This signal is controlled by PWM Generator 1.
	U1Tx	O	TTL	UART module 1 transmit. When in IrDA mode, this signal has IrDA modulation.
H2	PD2	I/O	TTL	GPIO port D bit 2.
	AIN13	I	Analog	Analog-to-digital converter input 13.
	CCP5	I/O	TTL	Capture/Compare/PWM 5.
	CCP6	I/O	TTL	Capture/Compare/PWM 6.
	EPI0S20	I/O	TTL	EPI module 0 signal 20.
	PWM2	O	TTL	PWM 2. This signal is controlled by PWM Generator 1.
	U1Rx	I	TTL	UART module 1 receive. When in IrDA mode, this signal has IrDA modulation.
H3	PH7	I/O	TTL	GPIO port H bit 7.
	EPI0S27	I/O	TTL	EPI module 0 signal 27.
	PWM5	O	TTL	PWM 5. This signal is controlled by PWM Generator 2.
	SSI1Tx	O	TTL	SSI module 1 transmit.
H10	VDD	-	Power	Positive supply for I/O and some logic.

Table 25-7. Signals by Pin Number (continued)

Pin Number	Pin Name	Pin Type	Buffer Type <sup>a</sup>	Description
H11	RST	I	TTL	System reset input.
H12	PF1	I/O	TTL	GPIO port F bit 1.
	CAN1Tx	O	TTL	CAN module 1 transmit.
	CCP3	I/O	TTL	Capture/Compare/PWM 3.
	I2S0TXMCLK	I/O	TTL	I <sup>2</sup> S module 0 transmit master clock.
	IDX1	I	TTL	QEI module 1 index.
	PWM1	O	TTL	PWM 1. This signal is controlled by PWM Generator 0.
	U1RTS	O	TTL	UART module 1 Request to Send modem output control line.
J1	XTALNPHY	O	Analog	Ethernet PHY XTALN 25-MHz oscillator crystal output.
J2	XTALPPHY	I	Analog	Ethernet PHY XTALP 25-MHz oscillator crystal input.
J3	ERBIAS	O	Analog	12.4-kΩ resistor (1% precision) used internally for Ethernet PHY.
J10	GND	-	Power	Ground reference for logic and I/O pins.
J11	PF2	I/O	TTL	GPIO port F bit 2.
	LED1	O	TTL	Ethernet LED 1.
	PWM2	O	TTL	PWM 2. This signal is controlled by PWM Generator 1.
	PWM4	O	TTL	PWM 4. This signal is controlled by PWM Generator 2.
	SSI1Clk	I/O	TTL	SSI module 1 clock.
J12	PF3	I/O	TTL	GPIO port F bit 3.
	LED0	O	TTL	Ethernet LED 0.
	PWM3	O	TTL	PWM 3. This signal is controlled by PWM Generator 1.
	PWM5	O	TTL	PWM 5. This signal is controlled by PWM Generator 2.
	SSI1Fss	I/O	TTL	SSI module 1 frame.
K1	PG0	I/O	TTL	GPIO port G bit 0.
	EPI0S13	I/O	TTL	EPI module 0 signal 13.
	I2C1SCL	I/O	OD	I <sup>2</sup> C module 1 clock.
	PWM0	O	TTL	PWM 0. This signal is controlled by PWM Generator 0.
	PWM4	O	TTL	PWM 4. This signal is controlled by PWM Generator 2.
	U2Rx	I	TTL	UART module 2 receive. When in IrDA mode, this signal has IrDA modulation.
	USB0EPEN	O	TTL	Optionally used in Host mode to control an external power source to supply power to the USB bus.
K2	PG1	I/O	TTL	GPIO port G bit 1.
	EPI0S14	I/O	TTL	EPI module 0 signal 14.
	I2C1SDA	I/O	OD	I <sup>2</sup> C module 1 data.
	PWM1	O	TTL	PWM 1. This signal is controlled by PWM Generator 0.
	PWM5	O	TTL	PWM 5. This signal is controlled by PWM Generator 2.
	U2Tx	O	TTL	UART module 2 transmit. When in IrDA mode, this signal has IrDA modulation.

Table 25-7. Signals by Pin Number (continued)

Pin Number	Pin Name	Pin Type	Buffer Type <sup>a</sup>	Description
K3	PF5	I/O	TTL	GPIO port F bit 5.
	C1o	O	TTL	Analog comparator 1 output.
	CCP2	I/O	TTL	Capture/Compare/PWM 2.
	EPI0S15	I/O	TTL	EPI module 0 signal 15.
	SSI1Tx	O	TTL	SSI module 1 transmit.
K4	PF4	I/O	TTL	GPIO port F bit 4.
	C0o	O	TTL	Analog comparator 0 output.
	CCP0	I/O	TTL	Capture/Compare/PWM 0.
	EPI0S12	I/O	TTL	EPI module 0 signal 12.
	Fault0	I	TTL	PWM Fault 0.
	SSI1Rx	I	TTL	SSI module 1 receive.
K5	GND	-	Power	Ground reference for logic and I/O pins.
K6	CCP0	I/O	TTL	Capture/Compare/PWM 0.
	EPI0S18	I/O	TTL	EPI module 0 signal 18.
	Fault0	I	TTL	PWM Fault 0.
	PJ2	I/O	TTL	GPIO port J bit 2.
K7	VDD	-	Power	Positive supply for I/O and some logic.
K8	VDD	-	Power	Positive supply for I/O and some logic.
K9	VDD	-	Power	Positive supply for I/O and some logic.
K10	GND	-	Power	Ground reference for logic and I/O pins.
K11	CCP4	I/O	TTL	Capture/Compare/PWM 4.
	EPI0S28	I/O	TTL	EPI module 0 signal 28.
	PJ4	I/O	TTL	GPIO port J bit 4.
	U1DCD	I	TTL	UART module 1 Data Carrier Detect modem status input signal.
K12	CCP2	I/O	TTL	Capture/Compare/PWM 2.
	EPI0S29	I/O	TTL	EPI module 0 signal 29.
	PJ5	I/O	TTL	GPIO port J bit 5.
	U1DSR	I	TTL	UART module 1 Data Set Ready modem output control line.
L1	PC4	I/O	TTL	GPIO port C bit 4.
	CCP1	I/O	TTL	Capture/Compare/PWM 1.
	CCP2	I/O	TTL	Capture/Compare/PWM 2.
	CCP4	I/O	TTL	Capture/Compare/PWM 4.
	CCP5	I/O	TTL	Capture/Compare/PWM 5.
	EPI0S2	I/O	TTL	EPI module 0 signal 2.
	PWM6	O	TTL	PWM 6. This signal is controlled by PWM Generator 3.
	PhA0	I	TTL	QEI module 0 phase A.

Table 25-7. Signals by Pin Number (continued)

Pin Number	Pin Name	Pin Type	Buffer Type <sup>a</sup>	Description
L2	PC7	I/O	TTL	GPIO port C bit 7.
	C1o	O	TTL	Analog comparator 1 output.
	C2-	I	Analog	Analog comparator 2 negative input.
	CCP0	I/O	TTL	Capture/Compare/PWM 0.
	CCP4	I/O	TTL	Capture/Compare/PWM 4.
	EPI0S5	I/O	TTL	EPI module 0 signal 5.
	PhB0	I	TTL	QEI module 0 phase B.
	U1Tx	O	TTL	UART module 1 transmit. When in IrDA mode, this signal has IrDA modulation.
L3	USB0PFLT	I	TTL	Optionally used in Host mode by an external power source to indicate an error state by that power source.
	PA0	I/O	TTL	GPIO port A bit 0.
	I2C1SCL	I/O	OD	I <sup>2</sup> C module 1 clock.
	U0Rx	I	TTL	UART module 0 receive. When in IrDA mode, this signal has IrDA modulation.
L4	U1Rx	I	TTL	UART module 1 receive. When in IrDA mode, this signal has IrDA modulation.
	PA3	I/O	TTL	GPIO port A bit 3.
	I2S0RXMCLK	I/O	TTL	I <sup>2</sup> S module 0 receive master clock.
	PWM5	O	TTL	PWM 5. This signal is controlled by PWM Generator 2.
L5	SSI0FSS	I/O	TTL	SSI module 0 frame.
	PA4	I/O	TTL	GPIO port A bit 4.
	CAN0Rx	I	TTL	CAN module 0 receive.
	I2S0TXSCK	I/O	TTL	I <sup>2</sup> S module 0 transmit clock.
	PWM6	O	TTL	PWM 6. This signal is controlled by PWM Generator 3.
L6	SSI0Rx	I	TTL	SSI module 0 receive.
	PA6	I/O	TTL	GPIO port A bit 6.
	CAN0Rx	I	TTL	CAN module 0 receive.
	CCP1	I/O	TTL	Capture/Compare/PWM 1.
	I2C1SCL	I/O	OD	I <sup>2</sup> C module 1 clock.
	PWM0	O	TTL	PWM 0. This signal is controlled by PWM Generator 0.
	PWM4	O	TTL	PWM 4. This signal is controlled by PWM Generator 2.
	U1CTS	I	TTL	UART module 1 Clear To Send modem status input signal.
USB0EPEN	O	TTL	Optionally used in Host mode to control an external power source to supply power to the USB bus.	
L7	RXIN	I	Analog	RXIN of the Ethernet PHY.
L8	TXON	O	TTL	TXON of the Ethernet PHY.
L9	MDIO	I/O	OD	MDIO of the Ethernet PHY.
L10	CCP1	I/O	TTL	Capture/Compare/PWM 1.
	EPI0S30	I/O	TTL	EPI module 0 signal 30.
	PJ6	I/O	TTL	GPIO port J bit 6.
	U1RTS	O	TTL	UART module 1 Request to Send modem output control line.
L11	OSC0	I	Analog	Main oscillator crystal input or an external clock reference input.

Table 25-7. Signals by Pin Number (continued)

Pin Number	Pin Name	Pin Type	Buffer Type <sup>a</sup>	Description
L12	CCP0	I/O	TTL	Capture/Compare/PWM 0.
	PJ7	I/O	TTL	GPIO port J bit 7.
	U1DTR	O	TTL	UART module 1 Data Terminal Ready modem status input signal.
M1	PC5	I/O	TTL	GPIO port C bit 5.
	C0o	O	TTL	Analog comparator 0 output.
	C1+	I	Analog	Analog comparator 1 positive input.
	C1o	O	TTL	Analog comparator 1 output.
	CCP1	I/O	TTL	Capture/Compare/PWM 1.
	CCP3	I/O	TTL	Capture/Compare/PWM 3.
	EPI0S3	I/O	TTL	EPI module 0 signal 3.
	Fault2	I	TTL	PWM Fault 2.
	USB0EPEN	O	TTL	Optionally used in Host mode to control an external power source to supply power to the USB bus.
M2	PC6	I/O	TTL	GPIO port C bit 6.
	C2+	I	Analog	Analog comparator 2 positive input.
	C2o	O	TTL	Analog comparator 2 output.
	CCP0	I/O	TTL	Capture/Compare/PWM 0.
	CCP3	I/O	TTL	Capture/Compare/PWM 3.
	EPI0S4	I/O	TTL	EPI module 0 signal 4.
	PWM7	O	TTL	PWM 7. This signal is controlled by PWM Generator 3.
	PhB0	I	TTL	QEI module 0 phase B.
	U1Rx	I	TTL	UART module 1 receive. When in IrDA mode, this signal has IrDA modulation.
USB0PFLT	I	TTL	Optionally used in Host mode by an external power source to indicate an error state by that power source.	
M3	PA1	I/O	TTL	GPIO port A bit 1.
	I2C1SDA	I/O	OD	I <sup>2</sup> C module 1 data.
	U0Tx	O	TTL	UART module 0 transmit. When in IrDA mode, this signal has IrDA modulation.
	U1Tx	O	TTL	UART module 1 transmit. When in IrDA mode, this signal has IrDA modulation.
M4	PA2	I/O	TTL	GPIO port A bit 2.
	I2S0RXSD	I/O	TTL	I <sup>2</sup> S module 0 receive data.
	PWM4	O	TTL	PWM 4. This signal is controlled by PWM Generator 2.
	SSI0Clk	I/O	TTL	SSI module 0 clock.
M5	PA5	I/O	TTL	GPIO port A bit 5.
	CAN0Tx	O	TTL	CAN module 0 transmit.
	I2S0TXWS	I/O	TTL	I <sup>2</sup> S module 0 transmit word select.
	PWM7	O	TTL	PWM 7. This signal is controlled by PWM Generator 3.
	SSI0Tx	O	TTL	SSI module 0 transmit.



Table 25-7. Signals by Pin Number (continued)

Pin Number	Pin Name	Pin Type	Buffer Type <sup>a</sup>	Description
M6	PA7	I/O	TTL	GPIO port A bit 7.
	CAN0Tx	O	TTL	CAN module 0 transmit.
	CCP3	I/O	TTL	Capture/Compare/PWM 3.
	CCP4	I/O	TTL	Capture/Compare/PWM 4.
	I2C1SDA	I/O	OD	I <sup>2</sup> C module 1 data.
	PWM1	O	TTL	PWM 1. This signal is controlled by PWM Generator 0.
	PWM5	O	TTL	PWM 5. This signal is controlled by PWM Generator 2.
	U1DCD	I	TTL	UART module 1 Data Carrier Detect modem status input signal.
	USB0PFLT	I	TTL	Optionally used in Host mode by an external power source to indicate an error state by that power source.
M7	RXIP	I	Analog	RXIP of the Ethernet PHY.
M8	TXOP	O	TTL	TXOP of the Ethernet PHY.
M9	PF0	I/O	TTL	GPIO port F bit 0.
	CAN1Rx	I	TTL	CAN module 1 receive.
	I2S0TXSD	I/O	TTL	I <sup>2</sup> S module 0 transmit data.
	PWM0	O	TTL	PWM 0. This signal is controlled by PWM Generator 0.
	PhB0	I	TTL	QEI module 0 phase B.
	U1DSR	I	TTL	UART module 1 Data Set Ready modem output control line.
M10	CCP6	I/O	TTL	Capture/Compare/PWM 6.
	EPI0S19	I/O	TTL	EPI module 0 signal 19.
	PJ3	I/O	TTL	GPIO port J bit 3.
	U1CTS	I	TTL	UART module 1 Clear To Send modem status input signal.
M11	OSC1	O	Analog	Main oscillator crystal output. Leave unconnected when using a single-ended clock source.
M12	NC	-	-	No connect. Leave the pin electrically unconnected/isolated.

a. The TTL designation indicates the pin has TTL-compatible voltage levels.

Table 25-8. Signals by Signal Name

Pin Name	Pin Number	Pin Mux / Pin Assignment	Pin Type	Buffer Type <sup>a</sup>	Description
AIN0	B1	PE7	I	Analog	Analog-to-digital converter input 0.
AIN1	A1	PE6	I	Analog	Analog-to-digital converter input 1.
AIN2	B3	PE5	I	Analog	Analog-to-digital converter input 2.
AIN3	B2	PE4	I	Analog	Analog-to-digital converter input 3.
AIN4	A2	PD7	I	Analog	Analog-to-digital converter input 4.
AIN5	A3	PD6	I	Analog	Analog-to-digital converter input 5.
AIN6	C6	PD5	I	Analog	Analog-to-digital converter input 6.
AIN7	B5	PD4	I	Analog	Analog-to-digital converter input 7.
AIN8	B4	PE3	I	Analog	Analog-to-digital converter input 8.
AIN9	A4	PE2	I	Analog	Analog-to-digital converter input 9.
AIN10	A6	PB4	I	Analog	Analog-to-digital converter input 10.
AIN11	B7	PB5	I	Analog	Analog-to-digital converter input 11.

Table 25-8. Signals by Signal Name (continued)

Pin Name	Pin Number	Pin Mux / Pin Assignment	Pin Type	Buffer Type <sup>a</sup>	Description
AIN12	H1	PD3	I	Analog	Analog-to-digital converter input 12.
AIN13	H2	PD2	I	Analog	Analog-to-digital converter input 13.
AIN14	G2	PD1	I	Analog	Analog-to-digital converter input 14.
AIN15	G1	PD0	I	Analog	Analog-to-digital converter input 15.
C0+	A7	PB6	I	Analog	Analog comparator 0 positive input.
C0-	A6	PB4	I	Analog	Analog comparator 0 negative input.
C0o	M1 K4 A7 B7 A2	PC5 (3) PF4 (2) PB6 (3) PB5 (1) PD7 (2)	O	TTL	Analog comparator 0 output.
C1+	M1	PC5	I	Analog	Analog comparator 1 positive input.
C1-	B7	PB5	I	Analog	Analog comparator 1 negative input.
C1o	A1 L2 M1 K3 D11	PE6 (2) PC7 (7) PC5 (2) PF5 (2) PH2 (2)	O	TTL	Analog comparator 1 output.
C2+	M2	PC6	I	Analog	Analog comparator 2 positive input.
C2-	L2	PC7	I	Analog	Analog comparator 2 negative input.
C2o	B1 M2	PE7 (2) PC6 (3)	O	TTL	Analog comparator 2 output.
CAN0Rx	G1 L5 L6 A6	PD0 (2) PA4 (5) PA6 (6) PB4 (5)	I	TTL	CAN module 0 receive.
CAN0Tx	G2 M5 M6 B7	PD1 (2) PA5 (5) PA7 (6) PB5 (5)	O	TTL	CAN module 0 transmit.
CAN1Rx	M9	PF0 (1)	I	TTL	CAN module 1 receive.
CAN1Tx	H12	PF1 (1)	O	TTL	CAN module 1 transmit.
CCP0	H1 L2 M2 K6 K4 L12 E12 A11 B7 B5	PD3 (4) PC7 (4) PC6 (6) PJ2 (9) PF4 (1) PJ7 (10) PB0 (1) PB2 (5) PB5 (4) PD4 (1)	I/O	TTL	Capture/Compare/PWM 0.
CCP1	M1 L1 L6 L10 D12 A7 B4 A2	PC5 (1) PC4 (9) PA6 (2) PJ6 (10) PB1 (4) PB6 (1) PE3 (1) PD7 (3)	I/O	TTL	Capture/Compare/PWM 1.

Table 25-8. Signals by Signal Name (continued)

Pin Name	Pin Number	Pin Mux / Pin Assignment	Pin Type	Buffer Type <sup>a</sup>	Description
CCP2	B2 G2 L1 K3 K12 D12 A12 B7 A4 C6	PE4 (6) PD1 (10) PC4 (5) PF5 (1) PJ5 (10) PB1 (1) PE1 (4) PB5 (6) PE2 (5) PD5 (1)	I/O	TTL	Capture/Compare/PWM 2.
CCP3	B2 M2 M1 M6 H12 A11 B11 B5	PE4 (1) PC6 (1) PC5 (5) PA7 (7) PF1 (10) PB2 (4) PE0 (3) PD4 (2)	I/O	TTL	Capture/Compare/PWM 3.
CCP4	L2 L1 M6 K11 A4 C6	PC7 (1) PC4 (6) PA7 (2) PJ4 (10) PE2 (1) PD5 (2)	I/O	TTL	Capture/Compare/PWM 4.
CCP5	B3 H2 L1 C10 A7 B7	PE5 (1) PD2 (4) PC4 (1) PG7 (8) PB6 (6) PB5 (2)	I/O	TTL	Capture/Compare/PWM 5.
CCP6	G1 H2 M10 A12 C9 B7	PD0 (6) PD2 (2) PJ3 (10) PE1 (5) PH0 (1) PB5 (3)	I/O	TTL	Capture/Compare/PWM 6.
CCP7	G2 H1 C8 A7 B4	PD1 (6) PD3 (2) PH1 (1) PB6 (2) PE3 (5)	I/O	TTL	Capture/Compare/PWM 7.
EPI0S0	D10	PH3 (8)	I/O	TTL	EPI module 0 signal 0.
EPI0S1	D11	PH2 (8)	I/O	TTL	EPI module 0 signal 1.
EPI0S2	L1	PC4 (8)	I/O	TTL	EPI module 0 signal 2.
EPI0S3	M1	PC5 (8)	I/O	TTL	EPI module 0 signal 3.
EPI0S4	M2	PC6 (8)	I/O	TTL	EPI module 0 signal 4.
EPI0S5	L2	PC7 (8)	I/O	TTL	EPI module 0 signal 5.
EPI0S6	C9	PH0 (8)	I/O	TTL	EPI module 0 signal 6.
EPI0S7	C8	PH1 (8)	I/O	TTL	EPI module 0 signal 7.
EPI0S8	B11	PE0 (8)	I/O	TTL	EPI module 0 signal 8.
EPI0S9	A12	PE1 (8)	I/O	TTL	EPI module 0 signal 9.

Table 25-8. Signals by Signal Name (continued)

Pin Name	Pin Number	Pin Mux / Pin Assignment	Pin Type	Buffer Type <sup>a</sup>	Description
EPIOS10	B10	PH4 (8)	I/O	TTL	EPI module 0 signal 10.
EPIOS11	F10	PH5 (8)	I/O	TTL	EPI module 0 signal 11.
EPIOS12	K4	PF4 (8)	I/O	TTL	EPI module 0 signal 12.
EPIOS13	K1	PG0 (8)	I/O	TTL	EPI module 0 signal 13.
EPIOS14	K2	PG1 (8)	I/O	TTL	EPI module 0 signal 14.
EPIOS15	K3	PF5 (8)	I/O	TTL	EPI module 0 signal 15.
EPIOS16	F3	PJ0 (8)	I/O	TTL	EPI module 0 signal 16.
EPIOS17	B6	PJ1 (8)	I/O	TTL	EPI module 0 signal 17.
EPIOS18	K6	PJ2 (8)	I/O	TTL	EPI module 0 signal 18.
EPIOS19	M10 B5	PJ3 (8) PD4 (10)	I/O	TTL	EPI module 0 signal 19.
EPIOS20	H2	PD2 (8)	I/O	TTL	EPI module 0 signal 20.
EPIOS21	H1	PD3 (8)	I/O	TTL	EPI module 0 signal 21.
EPIOS22	B7	PB5 (8)	I/O	TTL	EPI module 0 signal 22.
EPIOS23	A6	PB4 (8)	I/O	TTL	EPI module 0 signal 23.
EPIOS24	A4	PE2 (8)	I/O	TTL	EPI module 0 signal 24.
EPIOS25	B4	PE3 (8)	I/O	TTL	EPI module 0 signal 25.
EPIOS26	G3	PH6 (8)	I/O	TTL	EPI module 0 signal 26.
EPIOS27	H3	PH7 (8)	I/O	TTL	EPI module 0 signal 27.
EPIOS28	K11 C6	PJ4 (8) PD5 (10)	I/O	TTL	EPI module 0 signal 28.
EPIOS29	K12 A3	PJ5 (8) PD6 (10)	I/O	TTL	EPI module 0 signal 29.
EPIOS30	L10 A2	PJ6 (8) PD7 (10)	I/O	TTL	EPI module 0 signal 30.
EPIOS31	C10	PG7 (9)	I/O	TTL	EPI module 0 signal 31.
ERBIAS	J3	fixed	O	Analog	12.4-kΩ resistor (1% precision) used internally for Ethernet PHY.
Fault0	B2 K6 K4 E11 A12 D10 A3	PE4 (4) PJ2 (10) PF4 (4) PB3 (2) PE1 (3) PH3 (2) PD6 (1)	I	TTL	PWM Fault 0.
Fault1	A7	PB6 (4)	I	TTL	PWM Fault 1.
Fault2	M1 F10	PC5 (4) PH5 (10)	I	TTL	PWM Fault 2.
Fault3	E11 D11	PB3 (4) PH2 (4)	I	TTL	PWM Fault 3.

Table 25-8. Signals by Signal Name (continued)

Pin Name	Pin Number	Pin Mux / Pin Assignment	Pin Type	Buffer Type <sup>a</sup>	Description
GND	C4 C5 K5 K10 J10 F11 F12	fixed	-	Power	Ground reference for logic and I/O pins.
GNDA	A5	fixed	-	Power	The ground reference for the analog circuits (ADC, Analog Comparators, etc.). These are separated from GND to minimize the electrical noise contained on VDD from affecting the analog functions.
I2C0SCL	A11	PB2 (1)	I/O	OD	I <sup>2</sup> C module 0 clock.
I2C0SDA	E11	PB3 (1)	I/O	OD	I <sup>2</sup> C module 0 data.
I2C1SCL	F3 K1 L3 L6	PJ0 (11) PG0 (3) PA0 (8) PA6 (1)	I/O	OD	I <sup>2</sup> C module 1 clock.
I2C1SDA	K2 M3 M6 B6	PG1 (3) PA1 (8) PA7 (1) PJ1 (11)	I/O	OD	I <sup>2</sup> C module 1 data.
I2S0RXMCLK	L4 C6	PA3 (9) PD5 (8)	I/O	TTL	I <sup>2</sup> S module 0 receive master clock.
I2S0RXSCK	G1	PD0 (8)	I/O	TTL	I <sup>2</sup> S module 0 receive clock.
I2S0RXSD	M4 B5	PA2 (9) PD4 (8)	I/O	TTL	I <sup>2</sup> S module 0 receive data.
I2S0RXWS	G2	PD1 (8)	I/O	TTL	I <sup>2</sup> S module 0 receive word select.
I2S0TXMCLK	H12	PF1 (8)	I/O	TTL	I <sup>2</sup> S module 0 transmit master clock.
I2S0TXSCK	L5 A7 A3	PA4 (9) PB6 (9) PD6 (8)	I/O	TTL	I <sup>2</sup> S module 0 transmit clock.
I2S0TXSD	B3 M9	PE5 (9) PF0 (8)	I/O	TTL	I <sup>2</sup> S module 0 transmit data.
I2S0TXWS	B2 M5 A2	PE4 (9) PA5 (9) PD7 (8)	I/O	TTL	I <sup>2</sup> S module 0 transmit word select.
IDX0	G1 A11 A7 A6 A2	PD0 (3) PB2 (2) PB6 (5) PB4 (6) PD7 (1)	I	TTL	QEI module 0 index.
IDX1	H12 D11	PF1 (2) PH2 (1)	I	TTL	QEI module 1 index.
LDO	E3	fixed	-	Power	Low drop-out regulator output voltage. This pin requires an external capacitor between the pin and GND of 1 $\mu$ F or greater. When the on-chip LDO is used to provide power to the logic, the LDO pin must also be connected to the VDDC pins at the board level in addition to the decoupling capacitor(s).
LED0	J12	PF3 (1)	O	TTL	Ethernet LED 0.

Table 25-8. Signals by Signal Name (continued)

Pin Name	Pin Number	Pin Mux / Pin Assignment	Pin Type	Buffer Type <sup>a</sup>	Description
LED1	J11	PF2 (1)	O	TTL	Ethernet LED 1.
MDIO	L9	fixed	I/O	OD	MDIO of the Ethernet PHY.
NC	M12 C1 C2 D2 D1 E1 E2 F1 F2	fixed	-	-	No connect. Leave the pin electrically unconnected/isolated.
NMI	A8	PB7 (4)	I	TTL	Non-maskable interrupt.
OSC0	L11	fixed	I	Analog	Main oscillator crystal input or an external clock reference input.
OSC1	M11	fixed	O	Analog	Main oscillator crystal output. Leave unconnected when using a single-ended clock source.
PA0	L3	-	I/O	TTL	GPIO port A bit 0.
PA1	M3	-	I/O	TTL	GPIO port A bit 1.
PA2	M4	-	I/O	TTL	GPIO port A bit 2.
PA3	L4	-	I/O	TTL	GPIO port A bit 3.
PA4	L5	-	I/O	TTL	GPIO port A bit 4.
PA5	M5	-	I/O	TTL	GPIO port A bit 5.
PA6	L6	-	I/O	TTL	GPIO port A bit 6.
PA7	M6	-	I/O	TTL	GPIO port A bit 7.
PB0	E12	-	I/O	TTL	GPIO port B bit 0.
PB1	D12	-	I/O	TTL	GPIO port B bit 1.
PB2	A11	-	I/O	TTL	GPIO port B bit 2.
PB3	E11	-	I/O	TTL	GPIO port B bit 3.
PB4	A6	-	I/O	TTL	GPIO port B bit 4.
PB5	B7	-	I/O	TTL	GPIO port B bit 5.
PB6	A7	-	I/O	TTL	GPIO port B bit 6.
PB7	A8	-	I/O	TTL	GPIO port B bit 7.
PC0	A9	-	I/O	TTL	GPIO port C bit 0.
PC1	B9	-	I/O	TTL	GPIO port C bit 1.
PC2	B8	-	I/O	TTL	GPIO port C bit 2.
PC3	A10	-	I/O	TTL	GPIO port C bit 3.
PC4	L1	-	I/O	TTL	GPIO port C bit 4.
PC5	M1	-	I/O	TTL	GPIO port C bit 5.
PC6	M2	-	I/O	TTL	GPIO port C bit 6.
PC7	L2	-	I/O	TTL	GPIO port C bit 7.
PD0	G1	-	I/O	TTL	GPIO port D bit 0.
PD1	G2	-	I/O	TTL	GPIO port D bit 1.
PD2	H2	-	I/O	TTL	GPIO port D bit 2.
PD3	H1	-	I/O	TTL	GPIO port D bit 3.

Table 25-8. Signals by Signal Name (continued)

Pin Name	Pin Number	Pin Mux / Pin Assignment	Pin Type	Buffer Type <sup>a</sup>	Description
PD4	B5	-	I/O	TTL	GPIO port D bit 4.
PD5	C6	-	I/O	TTL	GPIO port D bit 5.
PD6	A3	-	I/O	TTL	GPIO port D bit 6.
PD7	A2	-	I/O	TTL	GPIO port D bit 7.
PE0	B11	-	I/O	TTL	GPIO port E bit 0.
PE1	A12	-	I/O	TTL	GPIO port E bit 1.
PE2	A4	-	I/O	TTL	GPIO port E bit 2.
PE3	B4	-	I/O	TTL	GPIO port E bit 3.
PE4	B2	-	I/O	TTL	GPIO port E bit 4.
PE5	B3	-	I/O	TTL	GPIO port E bit 5.
PE6	A1	-	I/O	TTL	GPIO port E bit 6.
PE7	B1	-	I/O	TTL	GPIO port E bit 7.
PF0	M9	-	I/O	TTL	GPIO port F bit 0.
PF1	H12	-	I/O	TTL	GPIO port F bit 1.
PF2	J11	-	I/O	TTL	GPIO port F bit 2.
PF3	J12	-	I/O	TTL	GPIO port F bit 3.
PF4	K4	-	I/O	TTL	GPIO port F bit 4.
PF5	K3	-	I/O	TTL	GPIO port F bit 5.
PG0	K1	-	I/O	TTL	GPIO port G bit 0.
PG1	K2	-	I/O	TTL	GPIO port G bit 1.
PG7	C10	-	I/O	TTL	GPIO port G bit 7.
PH0	C9	-	I/O	TTL	GPIO port H bit 0.
PH1	C8	-	I/O	TTL	GPIO port H bit 1.
PH2	D11	-	I/O	TTL	GPIO port H bit 2.
PH3	D10	-	I/O	TTL	GPIO port H bit 3.
PH4	B10	-	I/O	TTL	GPIO port H bit 4.
PH5	F10	-	I/O	TTL	GPIO port H bit 5.
PH6	G3	-	I/O	TTL	GPIO port H bit 6.
PH7	H3	-	I/O	TTL	GPIO port H bit 7.
PhA0	G2 L1 A4	PD1 (3) PC4 (2) PE2 (4)	I	TTL	QE1 module 0 phase A.
PhA1	B4	PE3 (3)	I	TTL	QE1 module 1 phase A.
PhB0	L2 M2 M9 D10 B4	PC7 (2) PC6 (2) PF0 (2) PH3 (1) PE3 (4)	I	TTL	QE1 module 0 phase B.
PhB1	G2 C10 A4	PD1 (11) PG7 (1) PE2 (3)	I	TTL	QE1 module 1 phase B.
PJ0	F3	-	I/O	TTL	GPIO port J bit 0.
PJ1	B6	-	I/O	TTL	GPIO port J bit 1.

Table 25-8. Signals by Signal Name (continued)

Pin Name	Pin Number	Pin Mux / Pin Assignment	Pin Type	Buffer Type <sup>a</sup>	Description
PJ2	K6	-	I/O	TTL	GPIO port J bit 2.
PJ3	M10	-	I/O	TTL	GPIO port J bit 3.
PJ4	K11	-	I/O	TTL	GPIO port J bit 4.
PJ5	K12	-	I/O	TTL	GPIO port J bit 5.
PJ6	L10	-	I/O	TTL	GPIO port J bit 6.
PJ7	L12	-	I/O	TTL	GPIO port J bit 7.
PWM0	G1 F3 K1 L6 M9	PD0 (1) PJ0 (10) PG0 (2) PA6 (4) PF0 (3)	O	TTL	PWM 0. This signal is controlled by PWM Generator 0.
PWM1	G2 K2 M6 H12 B6	PD1 (1) PG1 (2) PA7 (4) PF1 (3) PJ1 (10)	O	TTL	PWM 1. This signal is controlled by PWM Generator 0.
PWM2	H2 J11 E12 C9	PD2 (3) PF2 (4) PB0 (2) PH0 (2)	O	TTL	PWM 2. This signal is controlled by PWM Generator 1.
PWM3	H1 J12 D12 C8	PD3 (3) PF3 (4) PB1 (2) PH1 (2)	O	TTL	PWM 3. This signal is controlled by PWM Generator 1.
PWM4	A1 K1 M4 L6 J11 G3 B11 C9	PE6 (1) PG0 (4) PA2 (4) PA6 (5) PF2 (2) PH6 (10) PE0 (1) PH0 (9)	O	TTL	PWM 4. This signal is controlled by PWM Generator 2.
PWM5	B1 H3 K2 L4 M6 J12 A12 C8	PE7 (1) PH7 (10) PG1 (4) PA3 (4) PA7 (5) PF3 (2) PE1 (1) PH1 (9)	O	TTL	PWM 5. This signal is controlled by PWM Generator 2.
PWM6	L1 L5	PC4 (4) PA4 (4)	O	TTL	PWM 6. This signal is controlled by PWM Generator 3.
PWM7	M2 M5 C10	PC6 (4) PA5 (4) PG7 (4)	O	TTL	PWM 7. This signal is controlled by PWM Generator 3.
RST	H11	fixed	I	TTL	System reset input.
RXIN	L7	fixed	I	Analog	RXIN of the Ethernet PHY.
RXIP	M7	fixed	I	Analog	RXIP of the Ethernet PHY.
SSI0Clk	M4	PA2 (1)	I/O	TTL	SSI module 0 clock.
SSI0Fss	L4	PA3 (1)	I/O	TTL	SSI module 0 frame.



Table 25-8. Signals by Signal Name (continued)

Pin Name	Pin Number	Pin Mux / Pin Assignment	Pin Type	Buffer Type <sup>a</sup>	Description
SSI0Rx	L5	PA4 (1)	I	TTL	SSI module 0 receive.
SSI0Tx	M5	PA5 (1)	O	TTL	SSI module 0 transmit.
SSI1Clk	J11 B11 B10	PF2 (9) PE0 (2) PH4 (11)	I/O	TTL	SSI module 1 clock.
SSI1Fss	J12 F10 A12	PF3 (9) PH5 (11) PE1 (2)	I/O	TTL	SSI module 1 frame.
SSI1Rx	K4 G3 A4	PF4 (9) PH6 (11) PE2 (2)	I	TTL	SSI module 1 receive.
SSI1Tx	H3 K3 B4	PH7 (11) PF5 (9) PE3 (2)	O	TTL	SSI module 1 transmit.
SWCLK	A9	PC0 (3)	I	TTL	JTAG/SWD CLK.
SWDIO	B9	PC1 (3)	I/O	TTL	JTAG TMS and SWDIO.
SWO	A10	PC3 (3)	O	TTL	JTAG TDO and SWO.
TCK	A9	PC0 (3)	I	TTL	JTAG/SWD CLK.
TDI	B8	PC2 (3)	I	TTL	JTAG TDI.
TDO	A10	PC3 (3)	O	TTL	JTAG TDO and SWO.
TMS	B9	PC1 (3)	I	TTL	JTAG TMS and SWDIO.
TXON	L8	fixed	O	TTL	TXON of the Ethernet PHY.
TXOP	M8	fixed	O	TTL	TXOP of the Ethernet PHY.
U0Rx	L3	PA0 (1)	I	TTL	UART module 0 receive. When in IrDA mode, this signal has IrDA modulation.
U0Tx	M3	PA1 (1)	O	TTL	UART module 0 transmit. When in IrDA mode, this signal has IrDA modulation.
U1CTS	A1 G1 L6 M10	PE6 (9) PD0 (9) PA6 (9) PJ3 (9)	I	TTL	UART module 1 Clear To Send modem status input signal.
U1DCD	B1 G2 M6 K11	PE7 (9) PD1 (9) PA7 (9) PJ4 (9)	I	TTL	UART module 1 Data Carrier Detect modem status input signal.
U1DSR	M9 K12	PF0 (9) PJ5 (9)	I	TTL	UART module 1 Data Set Ready modem output control line.
U1DTR	L12 A2	PJ7 (9) PD7 (9)	O	TTL	UART module 1 Data Terminal Ready modem status input signal.
U1RI	B5	PD4 (9)	I	TTL	UART module 1 Ring Indicator modem status input signal.
U1RTS	L10 H12	PJ6 (9) PF1 (9)	O	TTL	UART module 1 Request to Send modem output control line.

Table 25-8. Signals by Signal Name (continued)

Pin Name	Pin Number	Pin Mux / Pin Assignment	Pin Type	Buffer Type <sup>a</sup>	Description
U1Rx	G1 H2 M2 L3 E12 A6	PD0 (5) PD2 (1) PC6 (5) PA0 (9) PB0 (5) PB4 (7)	I	TTL	UART module 1 receive. When in IrDA mode, this signal has IrDA modulation.
U1Tx	G2 H1 L2 M3 D12 B7	PD1 (5) PD3 (1) PC7 (5) PA1 (9) PB1 (5) PB5 (7)	O	TTL	UART module 1 transmit. When in IrDA mode, this signal has IrDA modulation.
U2Rx	G1 K1 A6 C6	PD0 (4) PG0 (1) PB4 (4) PD5 (9)	I	TTL	UART module 2 receive. When in IrDA mode, this signal has IrDA modulation.
U2Tx	B2 G2 K2 A3	PE4 (5) PD1 (4) PG1 (1) PD6 (9)	O	TTL	UART module 2 transmit. When in IrDA mode, this signal has IrDA modulation.
USB0DM	C11	fixed	I/O	Analog	Bidirectional differential data pin (D- per USB specification).
USB0DP	C12	fixed	I/O	Analog	Bidirectional differential data pin (D+ per USB specification).
USB0EPEN	K1 M1 L6 A11 D10	PG0 (7) PC5 (6) PA6 (8) PB2 (8) PH3 (4)	O	TTL	Optionally used in Host mode to control an external power source to supply power to the USB bus.
USB0ID	E12	PB0	I	Analog	This signal senses the state of the USB ID signal. The USB PHY enables an integrated pull-up, and an external element (USB connector) indicates the initial state of the USB controller (pulled down is the A side of the cable and pulled up is the B side).
USB0PFLT	L2 M2 M6 E11 B11 B10 B6	PC7 (6) PC6 (7) PA7 (8) PB3 (8) PE0 (9) PH4 (4) PJ1 (9)	I	TTL	Optionally used in Host mode by an external power source to indicate an error state by that power source.
USB0RBIAS	B12	fixed	O	Analog	9.1-kΩ resistor (1% precision) used internally for USB analog circuitry.
USB0VBUS	D12	PB1	I/O	Analog	This signal is used during the session request protocol. This signal allows the USB PHY to both sense the voltage level of VBUS, and pull up VBUS momentarily during VBUS pulsing.

Table 25-8. Signals by Signal Name (continued)

Pin Name	Pin Number	Pin Mux / Pin Assignment	Pin Type	Buffer Type <sup>a</sup>	Description
VDD	K7 G12 K8 K9 H10 G10 E10 G11	fixed	-	Power	Positive supply for I/O and some logic.
VDDA	C7	fixed	-	Power	The positive supply (3.3 V) for the analog circuits (ADC, Analog Comparators, etc.). These are separated from VDD to minimize the electrical noise contained on VDD from affecting the analog functions. VDDA pins must be connected to 3.3 V, regardless of system implementation.
VDDC	D3 C3	fixed	-	Power	Positive supply for most of the logic function, including the processor core and most peripherals.
VREFA	A7	PB6	I	Analog	This input provides a reference voltage used to specify the input voltage at which the ADC converts to a maximum value. In other words, the voltage that is applied to VREFA is the voltage with which an AIN <sub>n</sub> signal is converted to 1023. The VREFA input is limited to the range specified in Table 27-2 on page 1205.
XTALNPHY	J1	fixed	O	Analog	Ethernet PHY XTALN 25-MHz oscillator crystal output.
XTALPPHY	J2	fixed	I	Analog	Ethernet PHY XTALP 25-MHz oscillator crystal input.

a. The TTL designation indicates the pin has TTL-compatible voltage levels.

Table 25-9. Signals by Function, Except for GPIO

Function	Pin Name	Pin Number	Pin Type	Buffer Type <sup>a</sup>	Description
ADC	AIN0	B1	I	Analog	Analog-to-digital converter input 0.
	AIN1	A1	I	Analog	Analog-to-digital converter input 1.
	AIN2	B3	I	Analog	Analog-to-digital converter input 2.
	AIN3	B2	I	Analog	Analog-to-digital converter input 3.
	AIN4	A2	I	Analog	Analog-to-digital converter input 4.
	AIN5	A3	I	Analog	Analog-to-digital converter input 5.
	AIN6	C6	I	Analog	Analog-to-digital converter input 6.
	AIN7	B5	I	Analog	Analog-to-digital converter input 7.
	AIN8	B4	I	Analog	Analog-to-digital converter input 8.
	AIN9	A4	I	Analog	Analog-to-digital converter input 9.
	AIN10	A6	I	Analog	Analog-to-digital converter input 10.
	AIN11	B7	I	Analog	Analog-to-digital converter input 11.
	AIN12	H1	I	Analog	Analog-to-digital converter input 12.
	AIN13	H2	I	Analog	Analog-to-digital converter input 13.
	AIN14	G2	I	Analog	Analog-to-digital converter input 14.
	AIN15	G1	I	Analog	Analog-to-digital converter input 15.
	VREFA	A7	I	Analog	This input provides a reference voltage used to specify the input voltage at which the ADC converts to a maximum value. In other words, the voltage that is applied to VREFA is the voltage with which an AIN <sub>n</sub> signal is converted to 1023. The VREFA input is limited to the range specified in Table 27-2 on page 1205.
Analog Comparators	C0+	A7	I	Analog	Analog comparator 0 positive input.
	C0-	A6	I	Analog	Analog comparator 0 negative input.
	C0o	M1 K4 A7 B7 A2	O	TTL	Analog comparator 0 output.
	C1+	M1	I	Analog	Analog comparator 1 positive input.
	C1-	B7	I	Analog	Analog comparator 1 negative input.
	C1o	A1 L2 M1 K3 D11	O	TTL	Analog comparator 1 output.
	C2+	M2	I	Analog	Analog comparator 2 positive input.
	C2-	L2	I	Analog	Analog comparator 2 negative input.
	C2o	B1 M2	O	TTL	Analog comparator 2 output.

Table 25-9. Signals by Function, Except for GPIO (continued)

Function	Pin Name	Pin Number	Pin Type	Buffer Type <sup>a</sup>	Description
Controller Area Network	CAN0Rx	G1 L5 L6 A6	I	TTL	CAN module 0 receive.
	CAN0Tx	G2 M5 M6 B7	O	TTL	CAN module 0 transmit.
	CAN1Rx	M9	I	TTL	CAN module 1 receive.
	CAN1Tx	H12	O	TTL	CAN module 1 transmit.
Ethernet	ERBIAS	J3	O	Analog	12.4-kΩ resistor (1% precision) used internally for Ethernet PHY.
	LED0	J12	O	TTL	Ethernet LED 0.
	LED1	J11	O	TTL	Ethernet LED 1.
	MDIO	L9	I/O	OD	MDIO of the Ethernet PHY.
	RXIN	L7	I	Analog	RXIN of the Ethernet PHY.
	RXIP	M7	I	Analog	RXIP of the Ethernet PHY.
	TXON	L8	O	TTL	TXON of the Ethernet PHY.
	TXOP	M8	O	TTL	TXOP of the Ethernet PHY.
	XTALNPHY	J1	O	Analog	Ethernet PHY XTALN 25-MHz oscillator crystal output.
XTALPPHY	J2	I	Analog	Ethernet PHY XTALP 25-MHz oscillator crystal input.	

Table 25-9. Signals by Function, Except for GPIO (*continued*)

Function	Pin Name	Pin Number	Pin Type	Buffer Type <sup>a</sup>	Description
External Peripheral Interface	EPI0S0	D10	I/O	TTL	EPI module 0 signal 0.
	EPI0S1	D11	I/O	TTL	EPI module 0 signal 1.
	EPI0S2	L1	I/O	TTL	EPI module 0 signal 2.
	EPI0S3	M1	I/O	TTL	EPI module 0 signal 3.
	EPI0S4	M2	I/O	TTL	EPI module 0 signal 4.
	EPI0S5	L2	I/O	TTL	EPI module 0 signal 5.
	EPI0S6	C9	I/O	TTL	EPI module 0 signal 6.
	EPI0S7	C8	I/O	TTL	EPI module 0 signal 7.
	EPI0S8	B11	I/O	TTL	EPI module 0 signal 8.
	EPI0S9	A12	I/O	TTL	EPI module 0 signal 9.
	EPI0S10	B10	I/O	TTL	EPI module 0 signal 10.
	EPI0S11	F10	I/O	TTL	EPI module 0 signal 11.
	EPI0S12	K4	I/O	TTL	EPI module 0 signal 12.
	EPI0S13	K1	I/O	TTL	EPI module 0 signal 13.
	EPI0S14	K2	I/O	TTL	EPI module 0 signal 14.
	EPI0S15	K3	I/O	TTL	EPI module 0 signal 15.
	EPI0S16	F3	I/O	TTL	EPI module 0 signal 16.
	EPI0S17	B6	I/O	TTL	EPI module 0 signal 17.
	EPI0S18	K6	I/O	TTL	EPI module 0 signal 18.
	EPI0S19	M10 B5	I/O	TTL	EPI module 0 signal 19.
	EPI0S20	H2	I/O	TTL	EPI module 0 signal 20.
	EPI0S21	H1	I/O	TTL	EPI module 0 signal 21.
	EPI0S22	B7	I/O	TTL	EPI module 0 signal 22.
	EPI0S23	A6	I/O	TTL	EPI module 0 signal 23.
	EPI0S24	A4	I/O	TTL	EPI module 0 signal 24.
	EPI0S25	B4	I/O	TTL	EPI module 0 signal 25.
	EPI0S26	G3	I/O	TTL	EPI module 0 signal 26.
	EPI0S27	H3	I/O	TTL	EPI module 0 signal 27.
	EPI0S28	K11 C6	I/O	TTL	EPI module 0 signal 28.
	EPI0S29	K12 A3	I/O	TTL	EPI module 0 signal 29.
	EPI0S30	L10 A2	I/O	TTL	EPI module 0 signal 30.
EPI0S31	C10	I/O	TTL	EPI module 0 signal 31.	

Table 25-9. Signals by Function, Except for GPIO (continued)

Function	Pin Name	Pin Number	Pin Type	Buffer Type <sup>a</sup>	Description
General-Purpose Timers	CCP0	H1 L2 M2 K6 K4 L12 E12 A11 B7 B5	I/O	TTL	Capture/Compare/PWM 0.
	CCP1	M1 L1 L6 L10 D12 A7 B4 A2	I/O	TTL	Capture/Compare/PWM 1.
	CCP2	B2 G2 L1 K3 K12 D12 A12 B7 A4 C6	I/O	TTL	Capture/Compare/PWM 2.
	CCP3	B2 M2 M1 M6 H12 A11 B11 B5	I/O	TTL	Capture/Compare/PWM 3.
	CCP4	L2 L1 M6 K11 A4 C6	I/O	TTL	Capture/Compare/PWM 4.
	CCP5	B3 H2 L1 C10 A7 B7	I/O	TTL	Capture/Compare/PWM 5.
	CCP6	G1 H2 M10 A12 C9 B7	I/O	TTL	Capture/Compare/PWM 6.
	CCP7		I/O	TTL	Capture/Compare/PWM 7.

Table 25-9. Signals by Function, Except for GPIO (continued)

Function	Pin Name	Pin Number	Pin Type	Buffer Type <sup>a</sup>	Description
		G2 H1 C8 A7 B4			
I2C	I2C0SCL	A11	I/O	OD	I <sup>2</sup> C module 0 clock.
	I2C0SDA	E11	I/O	OD	I <sup>2</sup> C module 0 data.
	I2C1SCL	F3 K1 L3 L6	I/O	OD	I <sup>2</sup> C module 1 clock.
	I2C1SDA	K2 M3 M6 B6	I/O	OD	I <sup>2</sup> C module 1 data.
I2S	I2S0RXMCLK	L4 C6	I/O	TTL	I <sup>2</sup> S module 0 receive master clock.
	I2S0RXSCK	G1	I/O	TTL	I <sup>2</sup> S module 0 receive clock.
	I2S0RXSD	M4 B5	I/O	TTL	I <sup>2</sup> S module 0 receive data.
	I2S0RXWS	G2	I/O	TTL	I <sup>2</sup> S module 0 receive word select.
	I2S0TXMCLK	H12	I/O	TTL	I <sup>2</sup> S module 0 transmit master clock.
	I2S0TXSCK	L5 A7 A3	I/O	TTL	I <sup>2</sup> S module 0 transmit clock.
	I2S0TXSD	B3 M9	I/O	TTL	I <sup>2</sup> S module 0 transmit data.
	I2S0TXWS	B2 M5 A2	I/O	TTL	I <sup>2</sup> S module 0 transmit word select.
JTAG/SWD/SWO	SWCLK	A9	I	TTL	JTAG/SWD CLK.
	SWDIO	B9	I/O	TTL	JTAG TMS and SWDIO.
	SWO	A10	O	TTL	JTAG TDO and SWO.
	TCK	A9	I	TTL	JTAG/SWD CLK.
	TDI	B8	I	TTL	JTAG TDI.
	TDO	A10	O	TTL	JTAG TDO and SWO.
	TMS	B9	I	TTL	JTAG TMS and SWDIO.



Table 25-9. Signals by Function, Except for GPIO (continued)

Function	Pin Name	Pin Number	Pin Type	Buffer Type <sup>a</sup>	Description
PWM	Fault0	B2 K6 K4 E11 A12 D10 A3	I	TTL	PWM Fault 0.
	Fault1	A7	I	TTL	PWM Fault 1.
	Fault2	M1 F10	I	TTL	PWM Fault 2.
	Fault3	E11 D11	I	TTL	PWM Fault 3.
	PWM0	G1 F3 K1 L6 M9	O	TTL	PWM 0. This signal is controlled by PWM Generator 0.
	PWM1	G2 K2 M6 H12 B6	O	TTL	PWM 1. This signal is controlled by PWM Generator 0.
	PWM2	H2 J11 E12 C9	O	TTL	PWM 2. This signal is controlled by PWM Generator 1.
	PWM3	H1 J12 D12 C8	O	TTL	PWM 3. This signal is controlled by PWM Generator 1.
	PWM4	A1 K1 M4 L6 J11 G3 B11 C9	O	TTL	PWM 4. This signal is controlled by PWM Generator 2.
	PWM5	B1 H3 K2 L4 M6 J12 A12 C8	O	TTL	PWM 5. This signal is controlled by PWM Generator 2.
	PWM6	L1 L5	O	TTL	PWM 6. This signal is controlled by PWM Generator 3.
	PWM7	M2 M5 C10	O	TTL	PWM 7. This signal is controlled by PWM Generator 3.

Table 25-9. Signals by Function, Except for GPIO (continued)

Function	Pin Name	Pin Number	Pin Type	Buffer Type <sup>a</sup>	Description
Power	GND	C4 C5 K5 K10 J10 F11 F12	-	Power	Ground reference for logic and I/O pins.
	GNDA	A5	-	Power	The ground reference for the analog circuits (ADC, Analog Comparators, etc.). These are separated from GND to minimize the electrical noise contained on VDD from affecting the analog functions.
	LDO	E3	-	Power	Low drop-out regulator output voltage. This pin requires an external capacitor between the pin and GND of 1 $\mu$ F or greater. When the on-chip LDO is used to provide power to the logic, the LDO pin must also be connected to the VDDC pins at the board level in addition to the decoupling capacitor(s).
	VDD	K7 G12 K8 K9 H10 G10 E10 G11	-	Power	Positive supply for I/O and some logic.
	VDDA	C7	-	Power	The positive supply (3.3 V) for the analog circuits (ADC, Analog Comparators, etc.). These are separated from VDD to minimize the electrical noise contained on VDD from affecting the analog functions. VDDA pins must be connected to 3.3 V, regardless of system implementation.
	VDDC	D3 C3	-	Power	Positive supply for most of the logic function, including the processor core and most peripherals.
QEI	IDX0	G1 A11 A7 A6 A2	I	TTL	QEI module 0 index.
	IDX1	H12 D11	I	TTL	QEI module 1 index.
	PhA0	G2 L1 A4	I	TTL	QEI module 0 phase A.
	PhA1	B4	I	TTL	QEI module 1 phase A.
	PhB0	L2 M2 M9 D10 B4	I	TTL	QEI module 0 phase B.
	PhB1	G2 C10 A4	I	TTL	QEI module 1 phase B.

Table 25-9. Signals by Function, Except for GPIO (continued)

Function	Pin Name	Pin Number	Pin Type	Buffer Type <sup>a</sup>	Description
SSI	SSI0Clk	M4	I/O	TTL	SSI module 0 clock.
	SSI0Fss	L4	I/O	TTL	SSI module 0 frame.
	SSI0Rx	L5	I	TTL	SSI module 0 receive.
	SSI0Tx	M5	O	TTL	SSI module 0 transmit.
	SSI1Clk	J11 B11 B10	I/O	TTL	SSI module 1 clock.
	SSI1Fss	J12 F10 A12	I/O	TTL	SSI module 1 frame.
	SSI1Rx	K4 G3 A4	I	TTL	SSI module 1 receive.
	SSI1Tx	H3 K3 B4	O	TTL	SSI module 1 transmit.
System Control & Clocks	NMI	A8	I	TTL	Non-maskable interrupt.
	OSC0	L11	I	Analog	Main oscillator crystal input or an external clock reference input.
	OSC1	M11	O	Analog	Main oscillator crystal output. Leave unconnected when using a single-ended clock source.
	RST	H11	I	TTL	System reset input.

Table 25-9. Signals by Function, Except for GPIO (continued)

Function	Pin Name	Pin Number	Pin Type	Buffer Type <sup>a</sup>	Description
UART	U0Rx	L3	I	TTL	UART module 0 receive. When in IrDA mode, this signal has IrDA modulation.
	U0Tx	M3	O	TTL	UART module 0 transmit. When in IrDA mode, this signal has IrDA modulation.
	U1CTS	A1 G1 L6 M10	I	TTL	UART module 1 Clear To Send modem status input signal.
	U1DCD	B1 G2 M6 K11	I	TTL	UART module 1 Data Carrier Detect modem status input signal.
	U1DSR	M9 K12	I	TTL	UART module 1 Data Set Ready modem output control line.
	U1DTR	L12 A2	O	TTL	UART module 1 Data Terminal Ready modem status input signal.
	U1RI	B5	I	TTL	UART module 1 Ring Indicator modem status input signal.
	U1RTS	L10 H12	O	TTL	UART module 1 Request to Send modem output control line.
	U1Rx	G1 H2 M2 L3 E12 A6	I	TTL	UART module 1 receive. When in IrDA mode, this signal has IrDA modulation.
	U1Tx	G2 H1 L2 M3 D12 B7	O	TTL	UART module 1 transmit. When in IrDA mode, this signal has IrDA modulation.
	U2Rx	G1 K1 A6 C6	I	TTL	UART module 2 receive. When in IrDA mode, this signal has IrDA modulation.
	U2Tx	B2 G2 K2 A3	O	TTL	UART module 2 transmit. When in IrDA mode, this signal has IrDA modulation.

Table 25-9. Signals by Function, Except for GPIO (continued)

Function	Pin Name	Pin Number	Pin Type	Buffer Type <sup>a</sup>	Description
USB	USB0DM	C11	I/O	Analog	Bidirectional differential data pin (D- per USB specification).
	USB0DP	C12	I/O	Analog	Bidirectional differential data pin (D+ per USB specification).
	USB0EPEN	K1 M1 L6 A11 D10	O	TTL	Optionally used in Host mode to control an external power source to supply power to the USB bus.
	USB0ID	E12	I	Analog	This signal senses the state of the USB ID signal. The USB PHY enables an integrated pull-up, and an external element (USB connector) indicates the initial state of the USB controller (pulled down is the A side of the cable and pulled up is the B side).
	USB0PFLT	L2 M2 M6 E11 B11 B10 B6	I	TTL	Optionally used in Host mode by an external power source to indicate an error state by that power source.
	USB0RBIAS	B12	O	Analog	9.1-kΩ resistor (1% precision) used internally for USB analog circuitry.
	USB0VBUS	D12	I/O	Analog	This signal is used during the session request protocol. This signal allows the USB PHY to both sense the voltage level of VBUS, and pull up VBUS momentarily during VBUS pulsing.

a. The TTL designation indicates the pin has TTL-compatible voltage levels.

Table 25-10. GPIO Pins and Alternate Functions

IO	Pin	Analog Function	Digital Function (GPIOPCTL PMCx Bit Field Encoding) <sup>a</sup>											
			1	2	3	4	5	6	7	8	9	10	11	
PA0	L3	-	U0Rx	-	-	-	-	-	-	-	I2C1SCL	U1Rx	-	-
PA1	M3	-	U0Tx	-	-	-	-	-	-	-	I2C1SDA	U1Tx	-	-
PA2	M4	-	SSI0Clk	-	-	PWM4	-	-	-	-	I2S0RXSD	-	-	-
PA3	L4	-	SSI0Fss	-	-	PWM5	-	-	-	-	I2S0RMCLK	-	-	-
PA4	L5	-	SSI0Rx	-	-	PWM6	CAN0Rx	-	-	-	I2S0TXSCK	-	-	-
PA5	M5	-	SSI0Tx	-	-	PWM7	CAN0Tx	-	-	-	I2S0TXWS	-	-	-
PA6	L6	-	I2C1SCL	CCP1	-	PWM0	PWM4	CAN0Rx	-	USB0EPEN	U1CTS	-	-	-
PA7	M6	-	I2C1SDA	CCP4	-	PWM1	PWM5	CAN0Tx	CCP3	USB0PFLT	U1DCD	-	-	-
PB0	E12	USB0ID	CCP0	PWM2	-	-	U1Rx	-	-	-	-	-	-	-
PB1	D12	USB0VBUS	CCP2	PWM3	-	CCP1	U1Tx	-	-	-	-	-	-	-
PB2	A11	-	I2C0SCL	IDX0	-	CCP3	CCP0	-	-	USB0EPEN	-	-	-	-
PB3	E11	-	I2C0SDA	Fault0	-	Fault3	-	-	-	USB0PFLT	-	-	-	-
PB4	A6	AIN10 C0-	-	-	-	U2Rx	CAN0Rx	IDX0	U1Rx	EPI0S23	-	-	-	-
PB5	B7	AIN11 C1-	C0o	CCP5	CCP6	CCP0	CAN0Tx	CCP2	U1Tx	EPI0S22	-	-	-	-

Table 25-10. GPIO Pins and Alternate Functions (continued)

IO	Pin	Analog Function	Digital Function (GPIOCTL PMCx Bit Field Encoding) <sup>a</sup>										
			1	2	3	4	5	6	7	8	9	10	11
PB6	A7	VREFA C0+	CCP1	CCP7	C0o	Fault1	IDX0	CCP5	-	-	I2S0TXSCK	-	-
PB7	A8	-	-	-	-	NMI	-	-	-	-	-	-	-
PC0	A9	-	-	-	TCK SWCLK	-	-	-	-	-	-	-	-
PC1	B9	-	-	-	TMS SWDIO	-	-	-	-	-	-	-	-
PC2	B8	-	-	-	TDI	-	-	-	-	-	-	-	-
PC3	A10	-	-	-	TDO SWO	-	-	-	-	-	-	-	-
PC4	L1	-	CCP5	PhA0	-	PWM6	CCP2	CCP4	-	EPI0S2	CCP1	-	-
PC5	M1	C1+	CCP1	C1o	C0o	Fault2	CCP3	USB0EPEN	-	EPI0S3	-	-	-
PC6	M2	C2+	CCP3	PhB0	C2o	PWM7	U1Rx	CCP0	USB0PFLT	EPI0S4	-	-	-
PC7	L2	C2-	CCP4	PhB0	-	CCP0	U1Tx	USB0PFLT	C1o	EPI0S5	-	-	-
PD0	G1	AIN15	PWM0	CAN0Rx	IDX0	U2Rx	U1Rx	CCP6	-	I2S0RXSCK	U1CTS	-	-
PD1	G2	AIN14	PWM1	CAN0Tx	PhA0	U2Tx	U1Tx	CCP7	-	I2S0RXWS	U1DCD	CCP2	PhB1
PD2	H2	AIN13	U1Rx	CCP6	PWM2	CCP5	-	-	-	EPI0S20	-	-	-
PD3	H1	AIN12	U1Tx	CCP7	PWM3	CCP0	-	-	-	EPI0S21	-	-	-
PD4	B5	AIN7	CCP0	CCP3	-	-	-	-	-	I2S0RXSD	U1RI	EPI0S19	-
PD5	C6	AIN6	CCP2	CCP4	-	-	-	-	-	I2S0RMCLK	U2Rx	EPI0S28	-
PD6	A3	AIN5	Fault0	-	-	-	-	-	-	I2S0TXSCK	U2Tx	EPI0S29	-
PD7	A2	AIN4	IDX0	C0o	CCP1	-	-	-	-	I2S0TXWS	U1DTR	EPI0S30	-
PE0	B11	-	PWM4	SSI1Clk	CCP3	-	-	-	-	EPI0S8	USB0PFLT	-	-
PE1	A12	-	PWM5	SSI1Fss	Fault0	CCP2	CCP6	-	-	EPI0S9	-	-	-
PE2	A4	AIN9	CCP4	SSI1Rx	PhB1	PhA0	CCP2	-	-	EPI0S24	-	-	-
PE3	B4	AIN8	CCP1	SSI1Tx	PhA1	PhB0	CCP7	-	-	EPI0S25	-	-	-
PE4	B2	AIN3	CCP3	-	-	Fault0	U2Tx	CCP2	-	-	I2S0TXWS	-	-
PE5	B3	AIN2	CCP5	-	-	-	-	-	-	-	I2S0TXSD	-	-
PE6	A1	AIN1	PWM4	C1o	-	-	-	-	-	-	U1CTS	-	-
PE7	B1	AIN0	PWM5	C2o	-	-	-	-	-	-	U1DCD	-	-
PF0	M9	-	CAN1Rx	PhB0	PWM0	-	-	-	-	I2S0TXSD	U1DSR	-	-
PF1	H12	-	CAN1Tx	IDX1	PWM1	-	-	-	-	I2S0RMCLK	U1RTS	CCP3	-
PF2	J11	-	LED1	PWM4	-	PWM2	-	-	-	-	SSI1Clk	-	-
PF3	J12	-	LED0	PWM5	-	PWM3	-	-	-	-	SSI1Fss	-	-
PF4	K4	-	CCP0	C0o	-	Fault0	-	-	-	EPI0S12	SSI1Rx	-	-
PF5	K3	-	CCP2	C1o	-	-	-	-	-	EPI0S15	SSI1Tx	-	-
PG0	K1	-	U2Rx	PWM0	I2C1SCL	PWM4	-	-	USB0EPEN	EPI0S13	-	-	-
PG1	K2	-	U2Tx	PWM1	I2C1SDA	PWM5	-	-	-	EPI0S14	-	-	-
PG7	C10	-	PhB1	-	-	PWM7	-	-	-	CCP5	EPI0S31	-	-
PH0	C9	-	CCP6	PWM2	-	-	-	-	-	EPI0S6	PWM4	-	-
PH1	C8	-	CCP7	PWM3	-	-	-	-	-	EPI0S7	PWM5	-	-
PH2	D11	-	IDX1	C1o	-	Fault3	-	-	-	EPI0S1	-	-	-

Table 25-10. GPIO Pins and Alternate Functions (continued)

IO	Pin	Analog Function	Digital Function (GPIOCTL PMCx Bit Field Encoding) <sup>a</sup>										
			1	2	3	4	5	6	7	8	9	10	11
PH3	D10	-	PhB0	Fault0	-	USB0EPEN	-	-	-	EPI0S0	-	-	-
PH4	B10	-	-	-	-	USB0PFLT	-	-	-	EPI0S10	-	-	SSI1Clk
PH5	F10	-	-	-	-	-	-	-	-	EPI0S11	-	Fault2	SSI1Fss
PH6	G3	-	-	-	-	-	-	-	-	EPI0S26	-	PWM4	SSI1Rx
PH7	H3	-	-	-	-	-	-	-	-	EPI0S27	-	PWM5	SSI1Tx
PJ0	F3	-	-	-	-	-	-	-	-	EPI0S16	-	PWM0	I2C1SCL
PJ1	B6	-	-	-	-	-	-	-	-	EPI0S17	USB0PFLT	PWM1	I2C1SDA
PJ2	K6	-	-	-	-	-	-	-	-	EPI0S18	CCP0	Fault0	-
PJ3	M10	-	-	-	-	-	-	-	-	EPI0S19	U1CTS	CCP6	-
PJ4	K11	-	-	-	-	-	-	-	-	EPI0S28	U1DCD	CCP4	-
PJ5	K12	-	-	-	-	-	-	-	-	EPI0S29	U1DSR	CCP2	-
PJ6	L10	-	-	-	-	-	-	-	-	EPI0S30	U1RTS	CCP1	-
PJ7	L12	-	-	-	-	-	-	-	-	-	U1DTR	CCP0	-

a. The digital signals that are shaded gray are the power-on default values for the corresponding GPIO pin.

Table 25-11. Possible Pin Assignments for Alternate Functions

# of Possible Assignments	Alternate Function	GPIO Function
one	AIN0	PE7
	AIN1	PE6
	AIN10	PB4
	AIN11	PB5
	AIN12	PD3
	AIN13	PD2
	AIN14	PD1
	AIN15	PD0
	AIN2	PE5
	AIN3	PE4
	AIN4	PD7
	AIN5	PD6
	AIN6	PD5
	AIN7	PD4
	AIN8	PE3
	AIN9	PE2
	C0+	PB6
	C0-	PB4
	C1+	PC5
	C1-	PB5
	C2+	PC6
	C2-	PC7
	CAN1Rx	PF0
	CAN1Tx	PF1
	Fault1	PB6
	I2C0SCL	PB2
	I2C0SDA	PB3
	I2S0RXSCK	PD0
	I2S0RXWS	PD1
	I2S0TXMCLK	PF1
	LED0	PF3
	LED1	PF2
	NMI	PB7
	PhA1	PE3
	SSI0Clk	PA2
	SSI0Fss	PA3
	SSI0Rx	PA4
	SSI0Tx	PA5
	SWCLK	PC0
	SWDIO	PC1
SWO	PC3	



Table 25-11. Possible Pin Assignments for Alternate Functions (continued)

# of Possible Assignments	Alternate Function	GPIO Function
	TCK	PC0
	TDI	PC2
	TDO	PC3
	TMS	PC1
	U0Rx	PA0
	U0Tx	PA1
	U1RI	PD4
	USB0ID	PB0
	USB0VBUS	PB1
	VREFA	PB6
two	C2o	PE7 PC6
	Fault2	PC5 PH5
	Fault3	PB3 PH2
	I2S0RXCLK	PA3 PD5
	I2S0RXSD	PA2 PD4
	I2S0TXSD	PE5 PF0
	IDX1	PF1 PH2
	PWM6	PC4 PA4
	U1DSR	PF0 PJ5
	U1DTR	PJ7 PD7
	U1RTS	PJ6 PF1
three	I2S0TXSCK	PA4 PB6 PD6
	I2S0TXWS	PE4 PA5 PD7
	PWM7	PC6 PA5 PG7
	PhA0	PD1 PC4 PE2
	PhB1	PD1 PG7 PE2
	SSI1Clk	PF2 PE0 PH4
	SSI1Fss	PF3 PH5 PE1
	SSI1Rx	PF4 PH6 PE2
	SSI1Tx	PH7 PF5 PE3
four	CAN0Rx	PD0 PA4 PA6 PB4
	CAN0Tx	PD1 PA5 PA7 PB5
	I2C1SCL	PJ0 PG0 PA0 PA6
	I2C1SDA	PG1 PA1 PA7 PJ1
	PWM2	PD2 PF2 PB0 PH0
	PWM3	PD3 PF3 PB1 PH1
	U1CTS	PE6 PD0 PA6 PJ3
	U1DCD	PE7 PD1 PA7 PJ4
	U2Rx	PD0 PG0 PB4 PD5
	U2Tx	PE4 PD1 PG1 PD6

Table 25-11. Possible Pin Assignments for Alternate Functions (continued)

# of Possible Assignments	Alternate Function	GPIO Function
five	C0o	PC5 PF4 PB6 PB5 PD7
	C1o	PE6 PC7 PC5 PF5 PH2
	CCP7	PD1 PD3 PH1 PB6 PE3
	IDX0	PD0 PB2 PB6 PB4 PD7
	PWM0	PD0 PJ0 PG0 PA6 PF0
	PWM1	PD1 PG1 PA7 PF1 PJ1
	PhB0	PC7 PC6 PF0 PH3 PE3
six	USB0EPEN	PG0 PC5 PA6 PB2 PH3
	CCP4	PC7 PC4 PA7 PJ4 PE2 PD5
	CCP5	PE5 PD2 PC4 PG7 PB6 PB5
	CCP6	PD0 PD2 PJ3 PE1 PH0 PB5
	U1Rx	PD0 PD2 PC6 PA0 PB0 PB4
seven	U1Tx	PD1 PD3 PC7 PA1 PB1 PB5
	Fault0	PE4 PJ2 PF4 PB3 PE1 PH3 PD6
eight	USB0PFLT	PC7 PC6 PA7 PB3 PE0 PH4 PJ1
	CCP1	PC5 PC4 PA6 PJ6 PB1 PB6 PE3 PD7
	CCP3	PE4 PC6 PC5 PA7 PF1 PB2 PE0 PD4
	PWM4	PE6 PG0 PA2 PA6 PF2 PH6 PE0 PH0
ten	PWM5	PE7 PH7 PG1 PA3 PA7 PF3 PE1 PH1
	CCP0	PD3 PC7 PC6 PJ2 PF4 PJ7 PB0 PB2 PB5 PD4
	CCP2	PE4 PD1 PC4 PF5 PJ5 PB1 PE1 PB5 PE2 PD5

## 25.3 Connections for Unused Signals

Table 25-12 on page 1202 show how to handle signals for functions that are not used in a particular system implementation for devices that are in a 100-pin LQFP package. Two options are shown in the table: an acceptable practice and a preferred practice for reduced power consumption and improved EMC characteristics. If a module is not used in a system, and its inputs are grounded, it is important that the clock to the module is never enabled by setting the corresponding bit in the **RCGCx** register.

Table 25-12. Connections for Unused Signals (100-pin LQFP)

Function	Signal Name	Pin Number	Acceptable Practice	Preferred Practice
Ethernet	ERBIAS	33	Connect to GND through 12.4-kΩ resistor.	Connect to GND through 12.4-kΩ resistor.
	MDIO	58	NC	NC
	RXIN	37	NC	GND
	RXIP	40	NC	GND
	TXON	46	NC	GND
	TXOP	43	NC	GND
	XTALNPHY	17	NC	NC
	XTALPPHY	16	NC	GND
GPIO	All unused GPIOs	-	NC	GND

**Table 25-12. Connections for Unused Signals (100-pin LQFP) (continued)**

Function	Signal Name	Pin Number	Acceptable Practice	Preferred Practice
No Connects	NC	-	NC	NC
System Control	OSC0	48	NC	GND
	OSC1	49	NC	NC
	$\overline{\text{RST}}$	48	Pull up as shown in Figure 6-1 on page 103	Connect through a capacitor to GND as close to pin as possible
USB	USB0RBIAS	73	Connect to GND through 10-k $\Omega$ resistor.	Connect to GND through 10-k $\Omega$ resistor.
	USB0DM	70	NC	GND
	USB0DP	71	NC	GND

Table 25-13 on page 1203 show how to handle signals for functions that are not used in a particular system implementation for devices that are in a 108-pin BGA package. Two options are shown in the table: an acceptable practice and a preferred practice for reduced power consumption and improved EMC characteristics. If a module is not used in a system, and its inputs are grounded, it is important that the clock to the module is never enabled by setting the corresponding bit in the **RCGCx** register.

**Table 25-13. Connections for Unused Signals, 108-pin BGA**

Function	Signal Name	Pin Number	Acceptable Practice	Preferred Practice
Ethernet	ERBIAS	J3	Connect to GND through 12.4-k $\Omega$ resistor.	Connect to GND through 12.4-k $\Omega$ resistor.
	MDIO	L9	NC	NC
	RXIN	L7	NC	GND
	RXIP	M7	NC	GND
	TXON	L8	NC	GND
	TXOP	M8	NC	GND
	XTALNPHY	J1	NC	NC
	XTALPPHY	J2	NC	GND
GPIO	All unused GPIOs	-	NC	GND
No Connects	NC	-	NC	NC
System Control	OSC0	L11	NC	GND
	OSC1	M11	NC	NC
	$\overline{\text{RST}}$	H11	Pull up as shown in Figure 6-1 on page 103	Connect through a capacitor to GND as close to pin as possible
USB	USB0RBIAS	B12	Connect to GND through 10-k $\Omega$ resistor.	Connect to GND through 10-k $\Omega$ resistor.
	USB0DM	C11	NC	GND
	USB0DP	C12	NC	GND

## 26 Operating Characteristics

**Table 26-1. Temperature Characteristics**

Characteristic	Symbol	Value	Unit
Industrial operating temperature range	$T_A$	-40 to +85	°C
Unpowered storage temperature range	$T_S$	-65 to +150	°C

**Table 26-2. Thermal Characteristics**

Characteristic	Symbol	Value	Unit
Thermal resistance (junction to ambient) <sup>a</sup>	$\Theta_{JA}$	34	°C/W
Average junction temperature <sup>b</sup>	$T_J$	$T_A + (P_{AVG} \cdot \Theta_{JA})$	°C

a. Junction to ambient thermal resistance  $\Theta_{JA}$  numbers are determined by a package simulator.

b. Power dissipation is a function of temperature.

**Table 26-3. ESD Absolute Maximum Ratings<sup>a</sup>**

Parameter Name	Min	Nom	Max	Unit
$V_{ESDHBM}$	-	-	2.0	kV
$V_{ESDCDM}$	-	-	1.0	kV
$V_{ESDMM}$	-	-	100	V

a. All Stellaris parts are ESD tested following the JEDEC standard.

## 27 Electrical Characteristics

### 27.1 DC Characteristics

#### 27.1.1 Maximum Ratings

The maximum ratings are the limits to which the device can be subjected without permanently damaging the device.

**Note:** The device is not guaranteed to operate properly at the maximum ratings.

**Table 27-1. Maximum Ratings**

Parameter	Parameter Name <sup>a</sup>	Value		Unit
		Min	Max	
V <sub>DD</sub>	I/O supply voltage (V <sub>DD</sub> )	0	4	V
V <sub>DDA</sub>	Analog supply voltage (V <sub>DDA</sub> )	0	4	V
V <sub>IN</sub>	Input voltage	-0.3	5.5	V
I	Maximum current per output pins	-	25	mA

a. Voltages are measured with respect to GND.

**Important:** This device contains circuitry to protect the inputs against damage due to high-static voltages or electric fields; however, it is advised that normal precautions be taken to avoid application of any voltage higher than maximum-rated voltages to this high-impedance circuit. Reliability of operation is enhanced if unused inputs are connected to an appropriate logic voltage level (for example, either GND or V<sub>DD</sub>).

#### 27.1.2 Recommended DC Operating Conditions

For special high-current applications, the GPIO output buffers may be used with the following restrictions. With the GPIO pins configured as 8-mA output drivers, a total of four GPIO outputs may be used to sink current loads up to 18 mA each. At 18-mA sink current loading, the V<sub>OL</sub> value is specified as 1.2 V. The high-current GPIO package pins must be selected such that there are only a maximum of two per side of the physical package or BGA pin group with the total number of high-current GPIO outputs not exceeding four for the entire package.

**Table 27-2. Recommended DC Operating Conditions**

Parameter	Parameter Name	Min	Nom	Max	Unit
V <sub>DD</sub>	I/O supply voltage	3.0	3.3	3.6	V
V <sub>DDA</sub>	Analog supply voltage	3.0	3.3	3.6	V
V <sub>DDC</sub> <sup>a</sup>	Core supply voltage	1.08	1.2	1.32	V
V <sub>IH</sub>	High-level input voltage	2.0	-	5.0	V
V <sub>IL</sub>	Low-level input voltage	-0.3	-	1.3	V
V <sub>OH</sub> <sup>b</sup>	High-level output voltage	2.4	-	-	V
V <sub>OL</sub> <sup>a</sup>	Low-level output voltage	-	-	0.4	V

Table 27-2. Recommended DC Operating Conditions (continued)

Parameter	Parameter Name	Min	Nom	Max	Unit
I <sub>OH</sub>	High-level source current, V <sub>OH</sub> =2.4 V				
	2-mA Drive	2.0	-	-	mA
	4-mA Drive	4.0	-	-	mA
	8-mA Drive	8.0	-	-	mA
I <sub>OL</sub>	Low-level sink current, V <sub>OL</sub> =0.4 V				
	2-mA Drive	2.0	-	-	mA
	4-mA Drive	4.0	-	-	mA
	8-mA Drive	8.0	-	-	mA

a. V<sub>DDC</sub> is supplied from the output of the LDO.

b. V<sub>OL</sub> and V<sub>OH</sub> shift to 1.2 V when using high-current GPIOs.

### 27.1.3 On-Chip Low Drop-Out (LDO) Regulator Characteristics

Table 27-3. LDO Regulator Characteristics

Parameter	Parameter Name	Min	Nom	Max	Unit
C <sub>LDO</sub>	External filter capacitor size for internal power supply	1.0	-	3.0	μF
V <sub>LDO</sub>	LDO output voltage	1.08	1.2	1.32	V

### 27.1.4 Flash Memory Characteristics

Table 27-4. Flash Memory Characteristics

Parameter	Parameter Name	Min	Nom	Max	Unit
P <sub>E</sub> CYC	Number of guaranteed mass program/erase cycles before failure <sup>a</sup>	15,000	-	-	cycles
T <sub>RET</sub>	Data retention at average operating temperature of 125°C	10	-	-	years
T <sub>PROG</sub>	Word program time	-	-	1	ms
T <sub>BPROG</sub>	Buffer program time	-	-	1	ms
T <sub>ERASE</sub>	Page erase time	-	-	12	ms
T <sub>ME</sub>	Mass erase time	-	-	16	ms

a. A program/erase cycle is defined as switching the bits from 1-> 0 -> 1. Caution should be used when performing block erases, as repeated block erases can shorten the number of guaranteed erase cycles, see "Flash Memory Programming" on page 214.

### 27.1.5 GPIO Module Characteristics

Table 27-5. GPIO Module DC Characteristics

Parameter	Parameter Name	Min	Nom	Max	Unit
R <sub>GPIOPU</sub>	GPIO internal pull-up resistor	50	-	110	kΩ
R <sub>GPIOPD</sub>	GPIO internal pull-down resistor	55	-	180	kΩ

## 27.1.6 USB Module Characteristics

The Stellaris® USB controller DC electrical specifications are compliant with the *Universal Serial Bus Specification Rev. 2.0* (full-speed and low-speed support) and the *On-The-Go Supplement to the USB 2.0 Specification Rev. 1.0*. Some components of the USB system are integrated within the LM3S9B96 microcontroller and specific to the Stellaris® microcontroller design. An external component resistor is needed as specified in Table 27-6.

**Table 27-6. USB Controller DC Characteristics**

Parameter	Parameter Name	Value	Unit
R <sub>UBIAS</sub>	Value of the pull-down resistor on the USB0RBIAS pin	9.1K ± 1 %	Ω

## 27.1.7 Ethernet Controller Characteristics

**Table 27-7. Ethernet Controller DC Characteristics**

Parameter	Parameter Name	Value	Unit
R <sub>EBIAS</sub>	Value of the pull-down resistor on the ERBIAS pin	12.4K ± 1 %	Ω

## 27.1.8 Current Specifications

This section provides information on typical and maximum power consumption under various conditions.

### 27.1.8.1 Preliminary Current Consumption Specifications

The following table provides preliminary figures for current consumption while ongoing characterization is completed.

**Table 27-8. Preliminary Current Consumption**

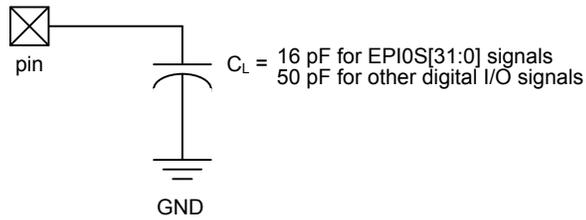
Parameter	Parameter Name	Conditions	Nom	Max	Unit
I <sub>DD_RUN</sub>	Run mode 1 (Flash loop)	V <sub>DD</sub> = 3.3 V Code= while(1){} executed in Flash Peripherals = All ON System Clock = 50 MHz (with PLL) Temp = 25°C	80	-	mA
I <sub>DD_SLEEP</sub>	Sleep mode	V <sub>DD</sub> = 3.3 V Peripherals = All clock gated System Clock = 50 MHz (with PLL) Temp = 25°C	8	-	mA
I <sub>DD_DEEPSLEEP</sub>	Deep-sleep mode	Peripherals = All OFF System Clock = IOS30KHZ/64 Temp = 25°C	550	-	μA

## 27.2 AC Characteristics

### 27.2.1 Load Conditions

Unless otherwise specified, the following conditions are true for all timing measurements.

Figure 27-1. Load Conditions



## 27.2.2 Clocks

The following sections provide specifications on the various clock sources and mode.

### 27.2.2.1 PLL Specifications

The following tables provide specifications for using the PLL.

Table 27-9. Phase Locked Loop (PLL) Characteristics

Parameter	Parameter Name	Min	Nom	Max	Unit
$f_{REF\_XTAL}$	Crystal reference <sup>a</sup>	3.579545	-	16.384	MHz
$f_{REF\_EXT}$	External clock reference <sup>a</sup>	3.579545	-	16.384	MHz
$f_{PLL}$	PLL frequency <sup>b</sup>	-	400	-	MHz
$T_{READY}$	PLL lock time	0.562 <sup>c</sup>	-	1.38 <sup>d</sup>	ms

a. The exact value is determined by the crystal value programmed into the  $XTAL$  field of the **Run-Mode Clock Configuration (RCC)** register.

b. PLL frequency is automatically calculated by the hardware based on the  $XTAL$  field of the **RCC** register.

c. Using a 16.384-MHz crystal

d. Using 3.5795-MHz crystal

Table 27-10 on page 1208 shows the actual frequency of the PLL based on the crystal frequency used (defined by the  $XTAL$  field in the **RCC** register).

Table 27-10. Actual PLL Frequency

$XTAL$	Crystal Frequency (MHz)	PLL Frequency (MHz)	Error
0x04	3.5795	400.904	0.0023%
0x05	3.6864	398.1312	0.0047%
0x06	4.0	400	-
0x07	4.096	401.408	0.0035%
0x08	4.9152	398.1312	0.0047%
0x09	5.0	400	-
0x0A	5.12	399.36	0.0016%
0x0B	6.0	400	-
0x0C	6.144	399.36	0.0016%
0x0D	7.3728	398.1312	0.0047%
0x0E	8.0	400	0.0047%
0x0F	8.192	398.6773333	0.0033%
0x10	10.0	400	-
0x11	12.0	400	-



**Table 27-10. Actual PLL Frequency (continued)**

XTAL	Crystal Frequency (MHz)	PLL Frequency (MHz)	Error
0x12	12.288	401.408	0.0035%
0x13	13.56	397.76	0.0056%
0x14	14.318	400.90904	0.0023%
0x15	16.0	400	-
0x16	16.384	404.1386667	0.010%

**27.2.2.2 PIOSC Specifications****Table 27-11. PIOSC Clock Characteristics**

Parameter	Parameter Name	Min	Nom	Max	Unit
f <sub>PIOSC25</sub>	Internal 16-MHz precision oscillator frequency variance, factory calibrated at 25 °C	-	±0.25%	±1%	-
f <sub>PIOST</sub>	Internal 16-MHz precision oscillator frequency variance, factory calibrated at 25 °C, across specified temperature range	-	-	±3%	-

**27.2.2.3 Internal 30-kHz Oscillator Specifications****Table 27-12. 30-kHz Clock Characteristics**

Parameter	Parameter Name	Min	Nom	Max	Unit
f <sub>IOSC30KHZ</sub>	Internal 30-KHz oscillator frequency	15	30	45	KHz

**27.2.2.4 Main Oscillator Specifications****Table 27-13. Main Oscillator Clock Characteristics**

Parameter	Parameter Name	Min	Nom	Max	Unit
f <sub>MOSC</sub>	Main oscillator frequency	1	-	16.384	MHz
t <sub>MOSC_PER</sub>	Main oscillator period	61	-	1000	ns
t <sub>MOSC_SETTLE</sub>	Main oscillator settling time	17.5	-	20	ms
f <sub>REF_XTAL_BYPASS</sub>	Crystal reference using the main oscillator (PLL in BYPASS mode) <sup>a</sup>	1	-	16.384	MHz
f <sub>REF_EXT_BYPASS</sub>	External clock reference (PLL in BYPASS mode) <sup>a</sup>	0	-	80	MHz

a. The ADC must be clocked from the PLL or directly from a 14- to 18-MHz clock source to operate properly.

**Table 27-14. MOSC Oscillator Input Characteristics**

Name	Value						Condition
Frequency	16	12	8	6	4	3.5	MHz
Frequency tolerance	±100	±100	±100	±100	±100	±100	PPM
Oscillation mode	parallel	parallel	parallel	parallel	parallel	parallel	-
Equivalent series resistance (max)	70	90	120	160	200	220	Ω
Load capacitance	16	16	16	16	16	16	pF
Drive level (typ)	100	100	100	100	100	100	μw

27.2.2.5 System Clock Specifications with ADC Operation

Table 27-15. System Clock Characteristics with ADC Operation

Parameter	Parameter Name	Min	Nom	Max	Unit
$f_{\text{sysadc}}$	System clock frequency when the ADC module is operating (when PLL is bypassed)	16	-	-	MHz

27.2.3 JTAG and Boundary Scan

Table 27-16. JTAG Characteristics

Parameter No.	Parameter	Parameter Name	Min	Nom	Max	Unit
J1	$f_{\text{TCK}}$	TCK operational clock frequency	0	-	10	MHz
J2	$t_{\text{TCK}}$	TCK operational clock period	100	-	-	ns
J3	$t_{\text{TCK\_LOW}}$	TCK clock Low time	-	$t_{\text{TCK}}$	-	ns
J4	$t_{\text{TCK\_HIGH}}$	TCK clock High time	-	$t_{\text{TCK}}$	-	ns
J5	$t_{\text{TCK\_R}}$	TCK rise time	0	-	10	ns
J6	$t_{\text{TCK\_F}}$	TCK fall time	0	-	10	ns
J7	$t_{\text{TMS\_SU}}$	TMS setup time to TCK rise	20	-	-	ns
J8	$t_{\text{TMS\_HLD}}$	TMS hold time from TCK rise	20	-	-	ns
J9	$t_{\text{TDI\_SU}}$	TDI setup time to TCK rise	25	-	-	ns
J10	$t_{\text{TDI\_HLD}}$	TDI hold time from TCK rise	25	-	-	ns
J11 $t_{\text{TDO\_ZDV}}$	TCK fall to Data Valid from High-Z	2-mA drive	-	23	35	ns
		4-mA drive	-	15	26	ns
		8-mA drive	-	14	25	ns
		8-mA drive with slew rate control	-	18	29	ns
J12 $t_{\text{TDO\_DV}}$	TCK fall to Data Valid from Data Valid	2-mA drive	-	21	35	ns
		4-mA drive	-	14	25	ns
		8-mA drive	-	13	24	ns
		8-mA drive with slew rate control	-	18	28	ns
J13 $t_{\text{TDO\_DVZ}}$	TCK fall to High-Z from Data Valid	2-mA drive	-	9	11	ns
		4-mA drive	-	7	9	ns
		8-mA drive	-	6	8	ns
		8-mA drive with slew rate control	-	7	9	ns

Figure 27-2. JTAG Test Clock Input Timing

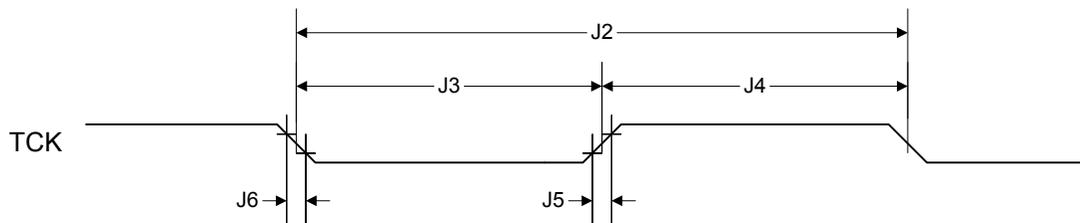
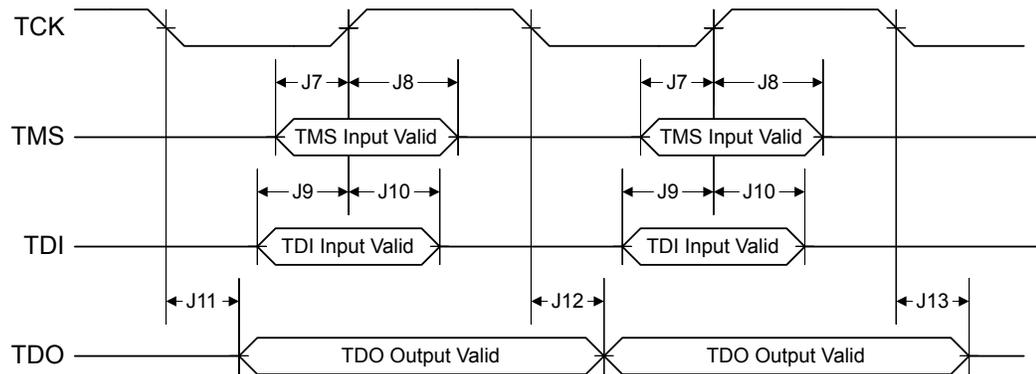


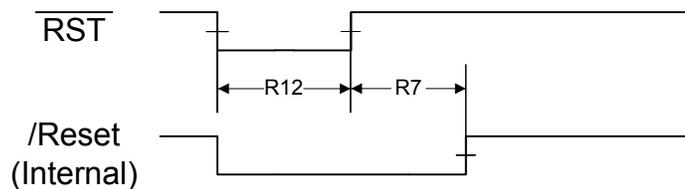
Figure 27-3. JTAG Test Access Port (TAP) Timing



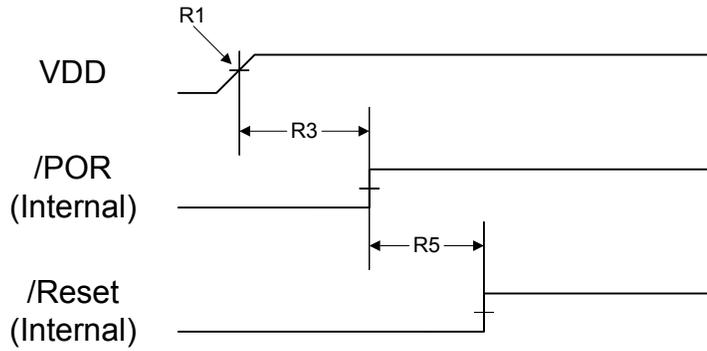
## 27.2.4 Reset

Table 27-17. Reset Characteristics

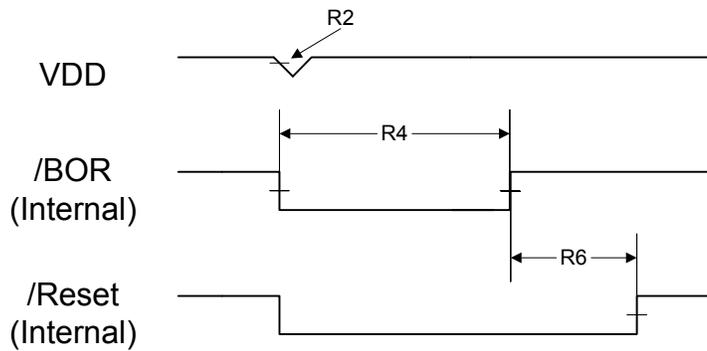
Parameter No.	Parameter	Parameter Name	Min	Nom	Max	Unit
R1	$V_{TH}$	Reset threshold	-	2.0	-	V
R2	$V_{BTH}$	Brown-Out threshold	2.85	2.9	2.95	V
R3	$T_{POR}$	Power-On Reset timeout	6	-	18	ms
R4	$T_{BOR}$	Brown-Out timeout	-	500	-	$\mu$ s
R5	$T_{IRPOR}$	Internal reset timeout after POR	-	-	95	system clocks
R6	$T_{IRBOR}$	Internal reset timeout after BOR	-	-	7	system clocks
R7	$T_{IRHWR}$	Internal reset timeout after hardware reset ( $\overline{RST}$ pin)	-	-	7	system clocks
R8	$T_{IRSWR}$	Internal reset timeout after software-initiated system reset	-	-	16	system clocks
R9	$T_{IRWDR}$	Internal reset timeout after watchdog reset	-	-	16	system clocks
R10	$T_{IRMFR}$	Internal reset timeout after MOSC failure reset	-	-	32	system clocks
R11	$T_{VDDRISE}$	Supply voltage ( $V_{DD}$ ) rise time (0V-3.3V)	-	-	10	ms
R12	$T_{MIN}$	Minimum $\overline{RST}$ pulse width	2	-	-	$\mu$ s

Figure 27-4. External Reset Timing ( $\overline{RST}$ )

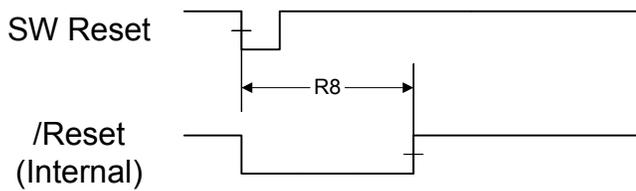
**Figure 27-5. Power-On Reset Timing**



**Figure 27-6. Brown-Out Reset Timing**



**Figure 27-7. Software Reset Timing**



**Figure 27-8. Watchdog Reset Timing**

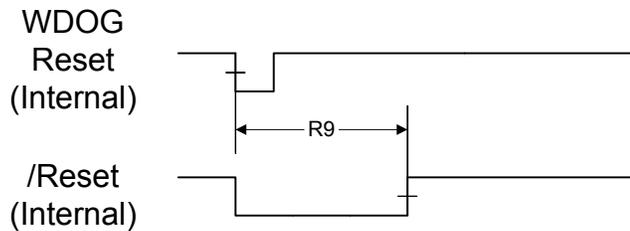
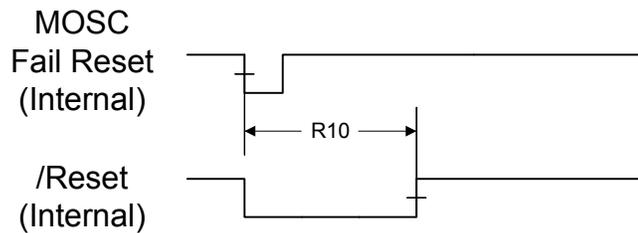


Figure 27-9. MOSC Failure Reset Timing



## 27.2.5 Sleep Modes

Table 27-18. Sleep Modes AC Characteristics<sup>a</sup>

Parameter No	Parameter	Parameter Name	Min	Nom	Max	Unit
D1	$t_{WAKE\_S}$	Time to wake from interrupt in sleep or deep-sleep mode, not using the PLL	-	-	7	system clocks
D2	$t_{WAKE\_PLL\_S}$	Time to wake from interrupt in sleep or deep-sleep mode when using the PLL	-	-	$T_{READY}$	ms
D3	$t_{ENTER\_DS}$	Time to enter deep-sleep mode from sleep request	-	0	$16^b$	ms

a. Values in this table assume the IOSC is the clock source during sleep or deep-sleep mode.

b. Nominal specification occurs 99.9995% of the time.

## 27.2.6 General-Purpose I/O (GPIO)

**Note:** All GPIOs are 5-V tolerant.

Table 27-19. GPIO Characteristics

Parameter	Parameter Name	Condition	Min	Nom	Max	Unit
$t_{GPIO\text{R}}$	GPIO Rise Time (from 20% to 80% of $V_{DD}$ )	2-mA drive	-	14	20	ns
		4-mA drive		7	10	ns
		8-mA drive		4	5	ns
		8-mA drive with slew rate control		6	8	ns
$t_{GPIO\text{F}}$	GPIO Fall Time (from 80% to 20% of $V_{DD}$ )	2-mA drive	-	14	21	ns
		4-mA drive		7	11	ns
		8-mA drive		4	6	ns
		8-mA drive with slew rate control		6	8	ns

## 27.2.7 External Peripheral Interface (EPI)

When the EPI module is in SDRAM mode, the drive strength must be configured to 8 mA. Table 27-20 on page 1213 shows the rise and fall times in SDRAM mode with 16 pF load conditions. When the EPI module is in Host-Bus or General-Purpose mode, the values in Table 27-19 on page 1213 should be used.

Table 27-20. EPI SDRAM Characteristics

Parameter	Parameter Name	Condition	Min	Nom	Max	Unit
$t_{SDRAM\text{R}}$	EPI Rise Time (from 20% to 80% of $V_{DD}$ )	8-mA drive, $C_L = 16$ pF	-	2	3	ns

Table 27-20. EPI SDRAM Characteristics (continued)

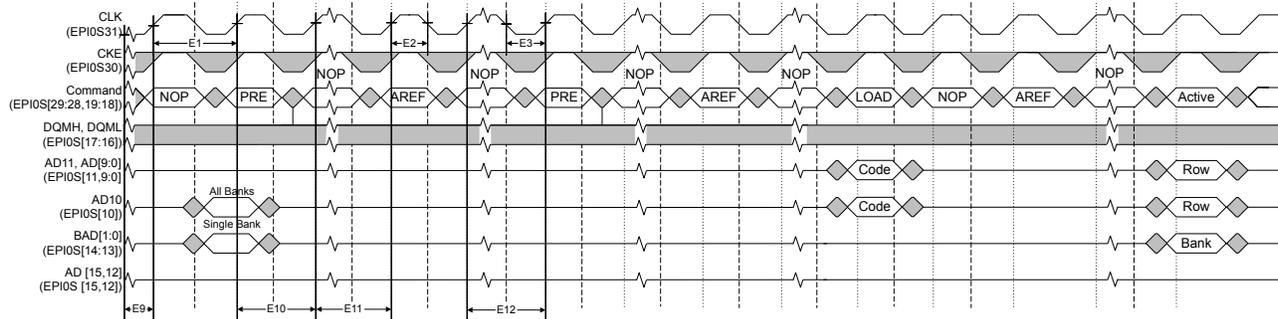
Parameter	Parameter Name	Condition	Min	Nom	Max	Unit
$t_{SDRAMF}$	EPI Fall Time (from 80% to 20% of $V_{DD}$ )	8-mA drive, $C_L = 16$ pF	-	2	3	ns

Table 27-21. EPI SDRAM Interface Characteristics<sup>a</sup>

Parameter No	Parameter	Parameter Name	Min	Nom	Max	Unit
E1	$t_{CK}$	SDRAM Clock period	20	-	-	ns
E2	$t_{CH}$	SDRAM Clock high time	10	-	-	ns
E3	$t_{CL}$	SDRAM Clock low time	10	-	-	ns
E4	$t_{COV}$	CLK to output valid	-5	-	5	ns
E5	$t_{COI}$	CLK to output invalid	-5	-	5	ns
E6	$t_{COT}$	CLK to output tristate	-5	-	5	ns
E7	$t_S$	Input set up to CLK	10	-	-	ns
E8	$t_H$	CLK to input hold	0	-	-	ns
E9	$t_{PU}$	Power-up time	100	-	-	$\mu$ s
E10	$t_{RP}$	Precharge all banks	20	-	-	ns
E11	$t_{RFC}$	Auto refresh	66	-	-	ns
E12	$t_{MRD}$	Program mode register	40	40	40	ns

a. The EPI SDRAM interface must use 8-mA drive.

Figure 27-10. SDRAM Initialization and Load Mode Register Timing



- Notes:
1. If CS is high at clock high time, all applied commands are NOP.
  2. The **Mode** register may be loaded prior to the auto refresh cycles if desired.
  3. JEDEC and PC100 specify three clocks.
  4. Outputs are guaranteed High-Z after command is issued.

Figure 27-11. SDRAM Read Timing

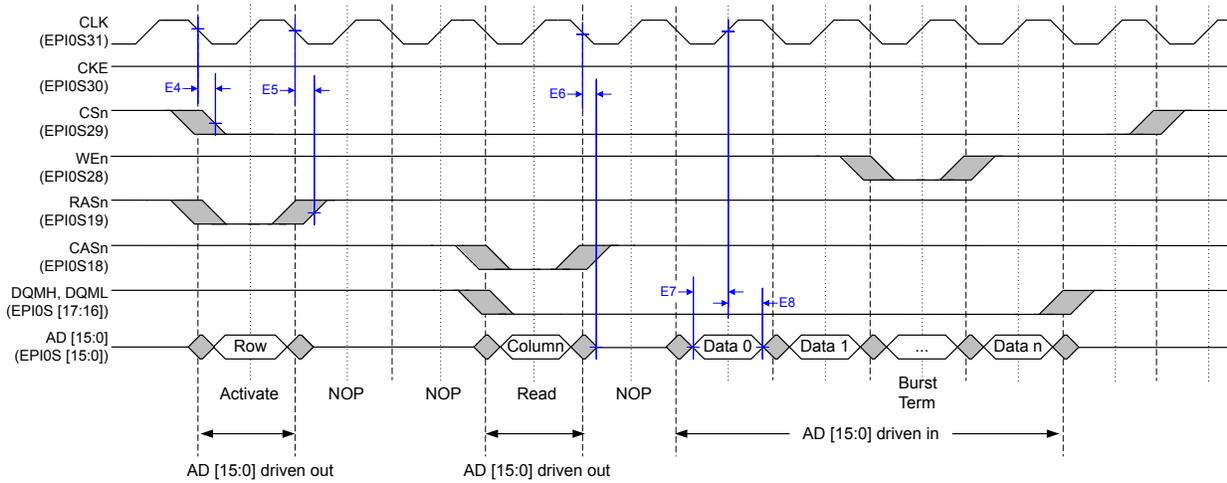


Figure 27-12. SDRAM Write Timing

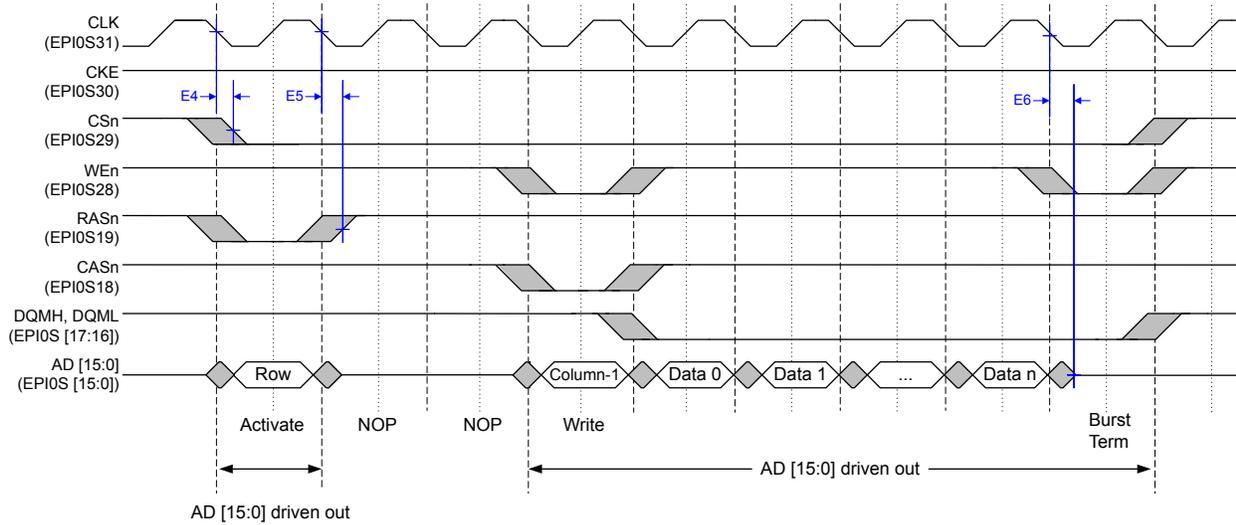


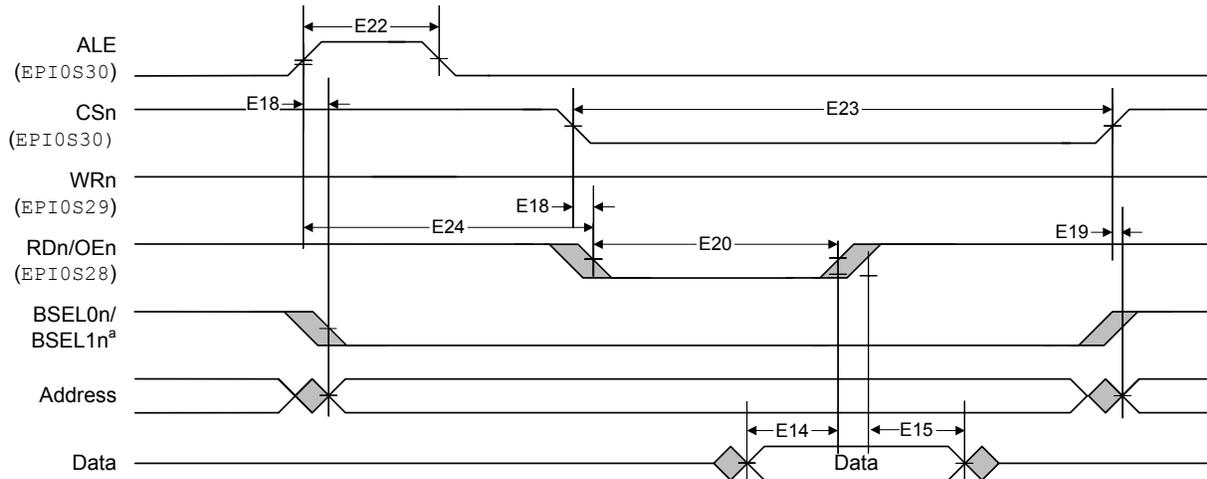
Table 27-22. EPI Host-Bus 8 and Host-Bus 16 Interface Characteristics

Parameter No	Parameter	Parameter Name	Min	Nom	Max	Unit
E14	$t_{ISU}$	Read data set up time	10	-	-	ns
E15	$t_{IH}$	Read data hold time	0	-	-	ns
E16	$t_{DV}$	WEn to write data valid	-	-	5	ns
E17	$t_{DI}$	Data hold from WEn invalid	2	-	-	EPI Clocks
E18	$t_{OV}$	CSn to output valid	-5	-	5	ns
E19	$t_{OINV}$	CSn to output invalid	-5	-	5	ns
E20	$t_{STLOW}$	WEn / RDn strobe width low	2	-	-	EPI Clocks
E21	$t_{FIFO}$	FEMPTY and FFULL setup time to clock edge	2	-	-	System Clocks
E22	$t_{ALEHIGH}$	ALE width high	-	1	-	EPI Clocks

**Table 27-22. EPI Host-Bus 8 and Host-Bus 16 Interface Characteristics (continued)**

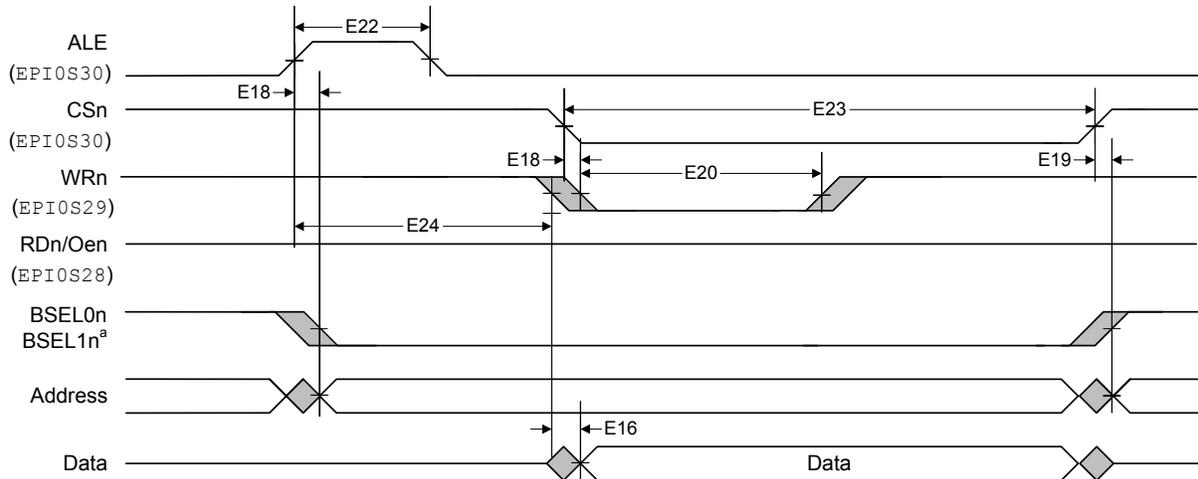
Parameter No	Parameter	Parameter Name	Min	Nom	Max	Unit
E23	$t_{CSLOW}$	CSn width low	4	-	-	EPI Clocks
E24	$t_{ALEST}$	ALE rising to WEn / RDn strobe falling	2	-	-	EPI Clocks

**Figure 27-13. Host-Bus 8/16 Mode Read Timing**



<sup>a</sup> BSEL0n and BSEL1n are available in Host-Bus 16 mode only.

**Figure 27-14. Host-Bus 8/16 Mode Write Timing**



<sup>a</sup> BSEL0n and BSEL1n are available in Host-Bus 16 mode only.

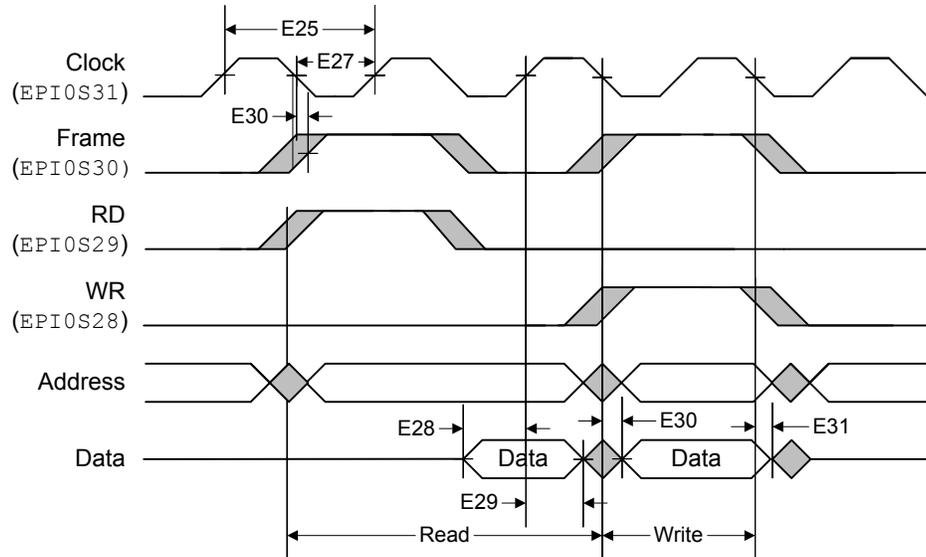
**Table 27-23. EPI General-Purpose Interface Characteristics**

Parameter No	Parameter	Parameter Name	Min	Nom	Max	Unit
E25	$t_{CK}$	General-Purpose Clock period	20	-	-	ns
E26	$t_{CH}$	General-Purpose Clock high time	10	-	-	ns
E27	$t_{CL}$	General-Purpose Clock low time	10	-	-	ns
E28	$t_{ISU}$	Input signal set up time to rising clock edge	10	-	-	ns

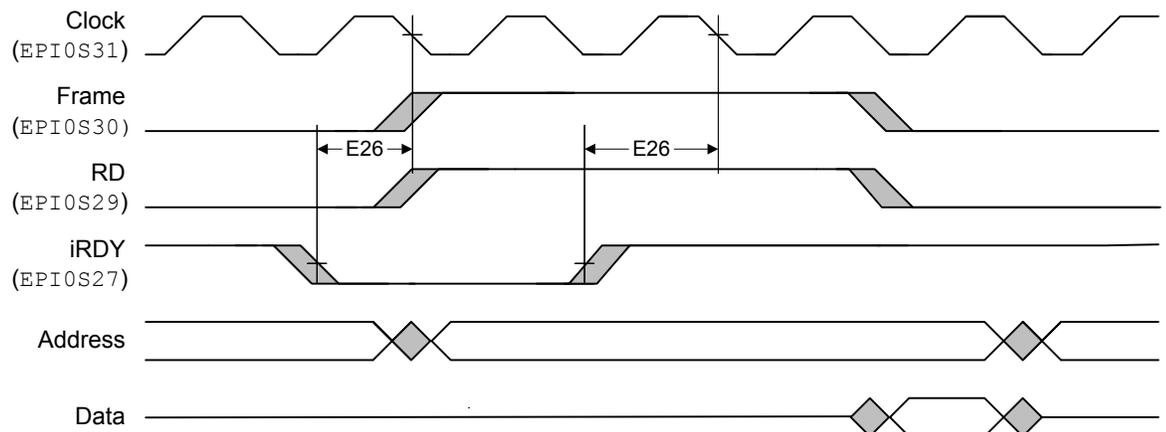


**Table 27-23. EPI General-Purpose Interface Characteristics (continued)**

Parameter No	Parameter	Parameter Name	Min	Nom	Max	Unit
E29	$t_{IH}$	Input signal hold time from rising clock edge	10	-	-	ns
E30	$t_{DV}$	Falling clock edge to output valid	-5	-	5	ns
E31	$t_{DI}$	Falling clock edge to output invalid	-5	-	5	ns
E32	$t_{RDYSU}$	iRDY assertion or deassertion set up time to falling clock edge	20	-	-	ns

**Figure 27-15. General-Purpose Mode Read and Write Timing**

The above figure illustrates accesses where the FRM50 bit is clear, the FRMCNT field is 0x0, the RD2CYC bit is clear, and the WR2CYC bit is clear.

**Figure 27-16. General-Purpose Mode iRDY Timing**

## 27.2.8 Analog-to-Digital Converter

Table 27-24. ADC Characteristics<sup>a</sup>

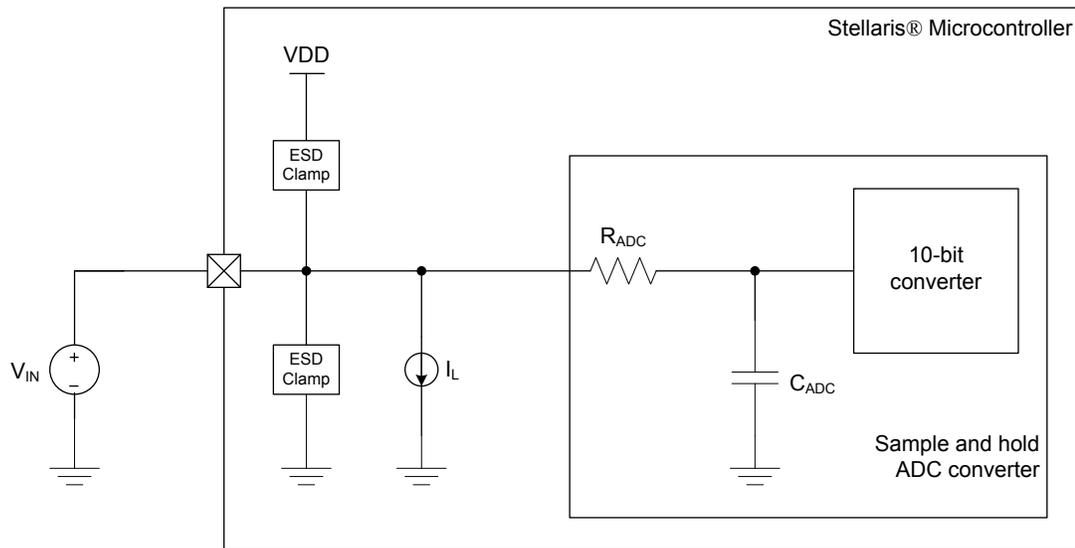
Parameter	Parameter Name	Min	Nom	Max	Unit
V <sub>ADCIN</sub>	Maximum single-ended, full-scale analog input voltage, using internal reference	-	-	3.0	V
	Maximum single-ended, full-scale analog input voltage, using external reference	-	-	V <sub>REFA</sub>	V
	Minimum single-ended, full-scale analog input voltage	0.0	-	-	V
	Maximum differential, full-scale analog input voltage, using internal reference	-	-	1.5	V
	Maximum differential, full-scale analog input voltage, using external reference	-	-	V <sub>REFA</sub> /2	V
	Minimum differential, full-scale analog input voltage	0.0	-	-	V
N	Resolution	10			bits
f <sub>ADC</sub>	ADC internal clock frequency <sup>b</sup>	14	16	18	MHz
t <sub>ADCCONV</sub>	Conversion time <sup>c</sup>	1			μs
f <sub>ADCCONV</sub>	Conversion rate <sup>c</sup>	1000			k samples/s
t <sub>LT</sub>	Latency from trigger to start of conversion	-	2	-	system clocks
I <sub>L</sub>	ADC input leakage	-	-	±1.0	μA
R <sub>ADC</sub>	ADC equivalent resistance	-	-	10	kΩ
C <sub>ADC</sub>	ADC equivalent capacitance	0.9	1.0	1.1	pF
E <sub>L</sub>	Integral nonlinearity error	-	-	±1	LSB
E <sub>D</sub>	Differential nonlinearity error	-	-	±1	LSB
E <sub>O</sub>	Offset error	-	-	±1	LSB
E <sub>G</sub>	Full-scale gain error	-	-	±3	LSB
E <sub>TS</sub>	Temperature sensor accuracy	-	-	±5	°C

a. The ADC reference voltage is 3.0 V. This reference voltage is internally generated from the 3.3 VDDA supply by a band gap circuit.

b. The ADC must be clocked from the PLL or directly from an external clock source to operate properly.

c. The conversion time and rate scale from the specified number if the ADC internal clock frequency is any value other than 16 MHz.

Figure 27-17. ADC Input Equivalency Diagram

Table 27-25. ADC Module External Reference Characteristics<sup>a</sup>

Parameter	Parameter Name	Min	Nom	Max	Unit
$V_{REFA}$	External voltage reference for ADC <sup>b</sup>	2.4	-	$V_{DD}$	V
$I_L$	External voltage reference leakage current	-	$\pm 1.0$	-	$\mu A$

a. Care must be taken to supply a reference voltage of acceptable quality.

b. Ground is always used as the reference level for the minimum conversion value.

Table 27-26. ADC Module Internal Reference Characteristics

Parameter	Parameter Name	Min	Nom	Max	Unit
$V_{REFI}$	Internal voltage reference for ADC	-	3.0	-	V
$E_{IR}$	Internal voltage reference error	-	-	$\pm 2.5$	%

## 27.2.9 Synchronous Serial Interface (SSI)

Table 27-27. SSI Characteristics

Parameter No.	Parameter	Parameter Name	Min	Nom	Max	Unit
S1	$t_{CLK\_PER}$	SSIClk cycle time	2	-	65024	system clocks
S2	$t_{CLK\_HIGH}$	SSIClk high time	-	0.5	-	t clk_per
S3	$t_{CLK\_LOW}$	SSIClk low time	-	0.5	-	t clk_per
S4	$t_{CLKRF}$	SSIClk rise/fall time	-	7.4	26	ns
S5	$t_{DMD}$	Data from master valid delay time	0	-	1	system clocks
S6	$t_{DMS}$	Data from master setup time	1	-	-	system clocks
S7	$t_{DMH}$	Data from master hold time	2	-	-	system clocks
S8	$t_{DSS}$	Data from slave setup time	1	-	-	system clocks
S9	$t_{DSH}$	Data from slave hold time	2	-	-	system clocks

Figure 27-18. SSI Timing for TI Frame Format (FRF=01), Single Transfer Timing Measurement

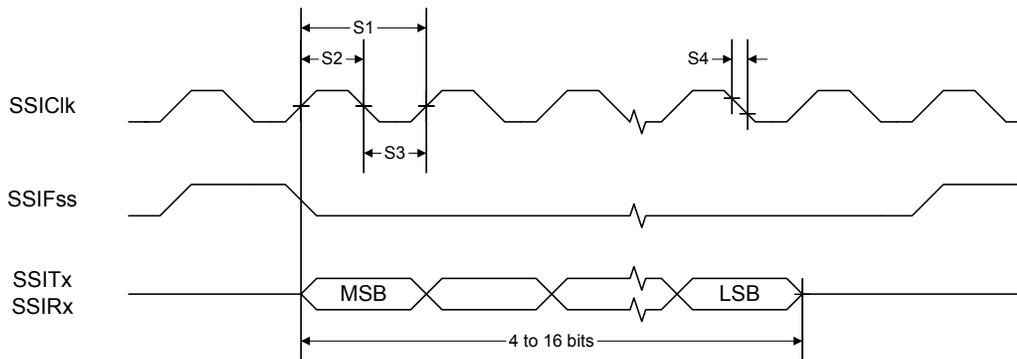


Figure 27-19. SSI Timing for MICROWIRE Frame Format (FRF=10), Single Transfer

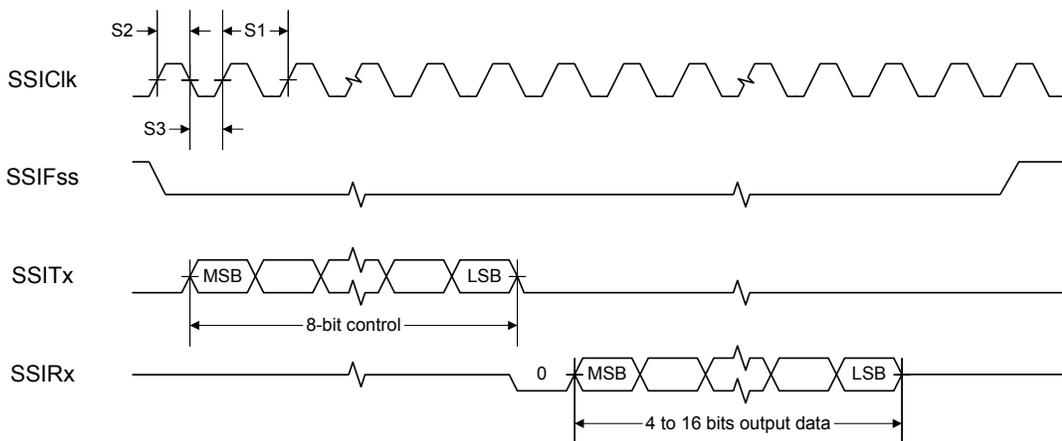
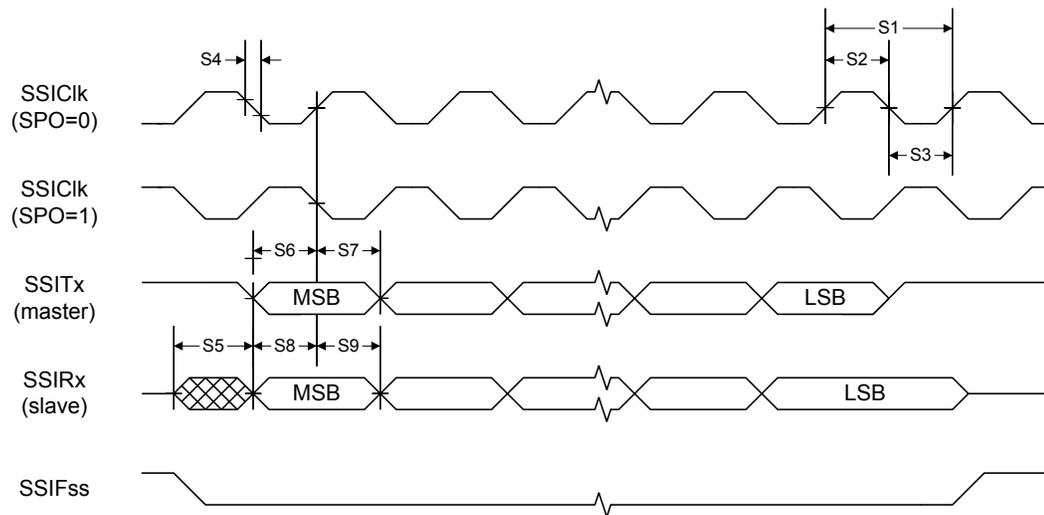
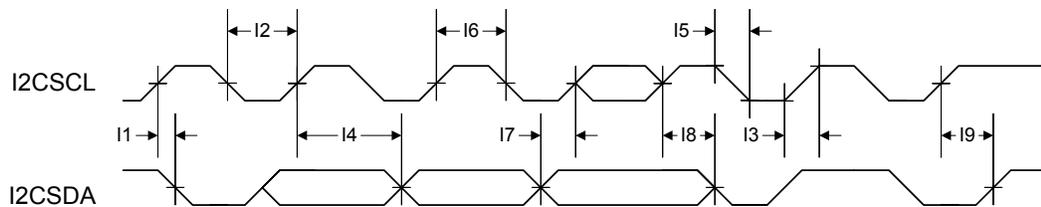


Figure 27-20. SSI Timing for SPI Frame Format (FRF=00), with SPH=1



## 27.2.10 Inter-Integrated Circuit (I<sup>2</sup>C) Interface

Figure 27-21. I<sup>2</sup>C Timing

## 27.2.11 Inter-Integrated Circuit Sound (I<sup>2</sup>S) Interface

Table 27-28. I<sup>2</sup>S Master Clock (Receive and Transmit)

Parameter No.	Parameter	Parameter Name	Min	Nom	Max	Unit
M1	$t_{MCLK\_PER}$	Cycle time	20.3	-	-	ns
M2	$t_{MCLKRF}$	Rise/fall time	See Table 27-19 on page 1213.			ns
M3	$t_{MCLK\_HIGH}$	High time	10	-	-	ns
M4	$t_{MCLK\_LOW}$	Low time	10	-	-	ns
M5	$t_{MDC}$	Duty cycle	48	-	52	%
M6	$t_{MJITTER}$	Jitter	-	-	2.5	ns

Table 27-29. I<sup>2</sup>S Slave Clock (Receive and Transmit)

Parameter No.	Parameter	Parameter Name	Min	Nom	Max	Unit
M7	$t_{SCLK\_PER}$	Cycle time	80	-	-	ns
M8	$t_{SCLK\_HIGH}$	High time	40	-	-	ns

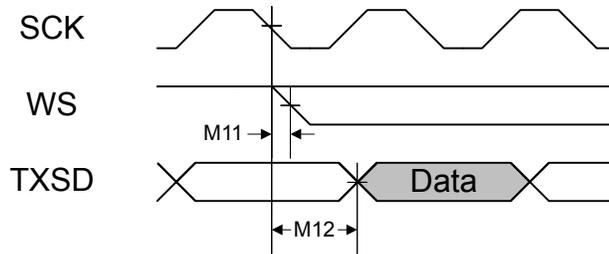
**Table 27-29. I<sup>2</sup>S Slave Clock (Receive and Transmit) (continued)**

Parameter No.	Parameter	Parameter Name	Min	Nom	Max	Unit
M9	$t_{SCLK\_LOW}$	Low time	40	-	-	ns
M10	$t_{SDC}$	Duty cycle	-	50	-	%

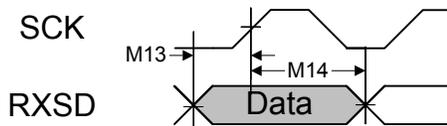
**Table 27-30. I<sup>2</sup>S Master Mode**

Parameter No.	Parameter	Parameter Name	Min	Nom	Max	Unit
M11	$t_{MSWS}$	SCK fall to WS valid	-	-	10	ns
M12	$t_{MSD}$	SCK fall to TXSD valid	-	-	10	ns
M13	$t_{MSDS}$	RXSD setup time to SCK rise	10	-	-	ns
M14	$t_{MSDH}$	RXSD hold time from SCK rise	10	-	-	ns

**Figure 27-22. I<sup>2</sup>S Master Mode Transmit Timing**

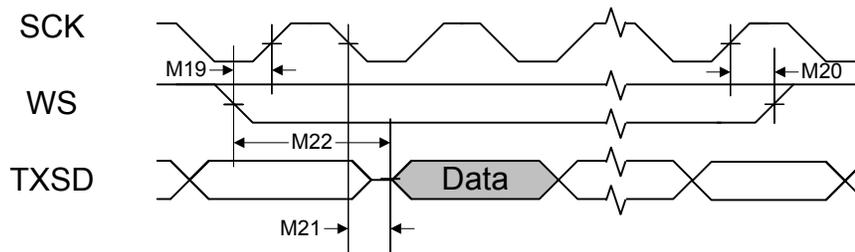
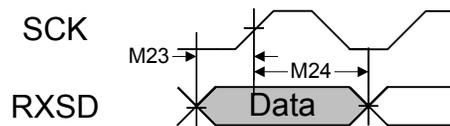


**Figure 27-23. I<sup>2</sup>S Master Mode Receive Timing**



**Table 27-31. I<sup>2</sup>S Slave Mode**

Parameter No.	Parameter	Parameter Name	Min	Nom	Max	Unit
M15	$t_{SCLK\_PER}$	Cycle time	80	-	-	ns
M16	$t_{SCLK\_HIGH}$	High time	40	-	-	ns
M17	$t_{SCLK\_LOW}$	Low time	40	-	-	ns
M18	$t_{SDC}$	Duty cycle	-	50	-	%
M19	$t_{SSETUP}$	WS setup time to SCK rise	-	-	25	ns
M20	$t_{SHOLD}$	WS hold time from SCK rise	-	-	10	ns
M21	$t_{SSD}$	SCK fall to TXSD valid	-	-	20	ns
M22	$t_{SLSD}$	Left-justified mode, WS to TXSD	-	-	20	ns
M23	$t_{SSDS}$	RXSD setup time to SCK rise	10	-	-	ns
M24	$t_{SSDH}$	RXSD hold time from SCK rise	10	-	-	ns

Figure 27-24. I<sup>2</sup>S Slave Mode Transmit TimingFigure 27-25. I<sup>2</sup>S Slave Mode Receive Timing

## 27.2.12 Ethernet Controller

Table 27-32. 100BASE-TX Transmitter Characteristics<sup>a</sup>

Parameter Name	Min	Nom	Max	Unit
Peak output amplitude	950	-	1050	mVpk
Output amplitude symmetry	98	-	102	%
Output overshoot	-	-	5	%
Rise/Fall time	3	-	5	ns
Rise/Fall time imbalance	-	-	500	ps
Duty cycle distortion	-	-	-	ps
Jitter	-	-	1.4	ns

a. Measured at the line side of the transformer.

Table 27-33. 100BASE-TX Transmitter Characteristics (informative)<sup>a</sup>

Parameter Name	Min	Nom	Max	Unit
Return loss	16	-	-	dB
Open-circuit inductance	350	-	-	μH

a. The specifications in this table are included for information only. They are mainly a function of the external transformer and termination resistors used for measurements.

Table 27-34. 100BASE-TX Receiver Characteristics

Parameter Name	Min	Nom	Max	Unit
Signal detect assertion threshold	600	700	-	mVppd
Signal detect de-assertion threshold	350	425	-	mVppd
Differential input resistance	-	3.6	-	kΩ
Jitter tolerance (pk-pk)	4	-	-	ns
Baseline wander tracking	-80	-	+80	%

**Table 27-34. 100BASE-TX Receiver Characteristics (continued)**

Parameter Name	Min	Nom	Max	Unit
Signal detect assertion time	-	-	1000	μs
Signal detect de-assertion time	-	-	4	μs

**Table 27-35. 10BASE-T Transmitter Characteristics<sup>a</sup>**

Parameter Name	Min	Nom	Max	Unit
Peak differential output signal	2.2	-	2.7	V
Harmonic content	27	-	-	dB
Link pulse width	-	100	-	ns
Start-of-idle pulse width	-	300 350	-	ns

a. The Manchester-encoded data pulses, the link pulse and the start-of-idle pulse are tested against the templates and using the procedures found in Clause 14 of *IEEE 802.3*.

**Table 27-36. 10BASE-T Transmitter Characteristics (informative)<sup>a</sup>**

Parameter Name	Min	Nom	Max	Unit
Output return loss	15	-	-	dB
Output impedance balance	$29-17\log(f/10)$	-	-	dB
Peak common-mode output voltage	-	-	50	mV
Common-mode rejection	-	-	100	mV
Common-mode rejection jitter	-	-	1	ns

a. The specifications in this table are included for information only. They are mainly a function of the external transformer and termination resistors used for measurements.

**Table 27-37. 10BASE-T Receiver Characteristics**

Parameter Name	Min	Nom	Max	Unit
Jitter tolerance (pk-pk)	30	26	-	ns
Input squelched threshold	340	440	540	mVppd
Differential input resistance	-	3.6	-	kΩ
Common-mode rejection	25	-	-	V

**Table 27-38. Isolation Transformers<sup>a</sup>**

Name	Value	Condition
Turns ratio	1 CT : 1 CT	+/- 5%
Open-circuit inductance	350 uH (min)	@ 10 mV, 10 kHz
Leakage inductance	0.40 uH (max)	@ 1 MHz (min)
Inter-winding capacitance	25 pF (max)	
DC resistance	0.9 Ohm (max)	
Insertion loss	0.4 dB (typ)	0-65 MHz
HIPOT	1500	Vrms

a. Two simple 1:1 isolation transformers are required at the line interface. Transformers with integrated common-mode chokes are recommended for exceeding FCC requirements. This table gives the recommended line transformer characteristics.



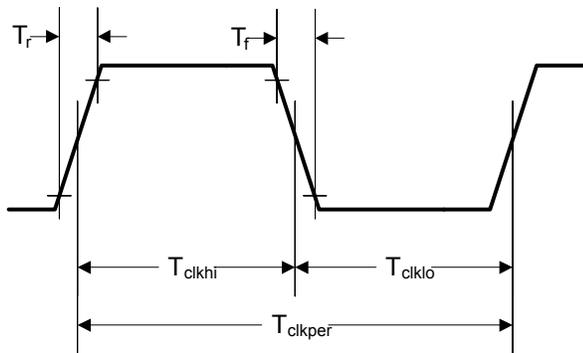
**Note:** The 100Base-TX amplitude specifications assume a transformer loss of 0.4 dB.

**Table 27-39. Ethernet Reference Crystal**

Name	Value	Condition
Frequency	25.00000	MHz
Frequency tolerance <sup>a</sup>	±50	PPM
Oscillation mode	Parallel resonance, fundamental mode	
Parameters at 25° C ±2° C; Drive level = 0.5 mW		
Drive level (typ)	50-100	µW
Shunt capacitance (max)	10	pF
Motional capacitance (min)	10	fF
Series resistance (max)	60	Ω
Spurious response (max)	> 5 dB below main within 500 kHz	

a. This tolerance provides a guard band for temperature stability and aging drift.

**Figure 27-26. External XTLP Oscillator Characteristics**



**Table 27-40. External XTLP Oscillator Characteristics**

Parameter	Parameter Name	Min	Nom	Max	Unit
XTLN <sub>ILV</sub>	XTLN Input Low Voltage	-	-	0.8	-
XTLP <sub>F</sub>	XTLP Frequency <sup>a</sup>	-	25.0	-	-
T <sub>CLKPER</sub>	XTLP Period <sup>a</sup>	-	40	-	-
XTLP <sub>DC</sub>	XTLP Duty Cycle	40	-	60	%
T <sub>r</sub> , T <sub>f</sub>	Rise/Fall Time	-	-	4.0	ns
T <sub>JITTER</sub>	Absolute Jitter	-	-	0.1	ns

a. IEEE 802.3 frequency tolerance ±50 ppm.

### 27.2.13 Universal Serial Bus (USB) Controller

The Stellaris<sup>®</sup> USB controller AC electrical specifications are compliant with the *Universal Serial Bus Specification Rev. 2.0* (full-speed and low-speed support) and the *On-The-Go Supplement to the USB 2.0 Specification Rev. 1.0*.

### 27.2.14 Analog Comparator

**Table 27-41. Analog Comparator Characteristics**

Parameter	Parameter Name	Min	Nom	Max	Unit
V <sub>OS</sub>	Input offset voltage	-	±10	±25	mV
V <sub>CM</sub>	Input common mode voltage range	0	-	V <sub>DD</sub> -1.5	V
C <sub>MRR</sub>	Common mode rejection ratio	50	-	-	dB
T <sub>RT</sub>	Response time	-	-	1	µs
T <sub>MC</sub>	Comparator mode change to Output Valid	-	-	10	µs

**Table 27-42. Analog Comparator Voltage Reference Characteristics**

Parameter	Parameter Name	Min	Nom	Max	Unit
R <sub>HR</sub>	Resolution high range	-	V <sub>DD</sub> /31	-	LSB
R <sub>LR</sub>	Resolution low range	-	V <sub>DD</sub> /23	-	LSB
A <sub>HR</sub>	Absolute accuracy high range	-	-	±1/2	LSB
A <sub>LR</sub>	Absolute accuracy low range	-	-	±1/4	LSB

# A Register Quick Reference

31	30	29	28	27	26	25	24	23	22	21	20	19	18	17	16						
15	14	13	12	11	10	9	8	7	6	5	4	3	2	1	0						
<b>System Control</b>																					
Base 0x400F.E000																					
<b>DID0, type RO, offset 0x000, reset -</b>																					
VER								CLASS													
MAJOR								MINOR													
<b>PBORCTL, type R/W, offset 0x030, reset 0x0000.7FFD</b>																					
														BORIOR							
<b>RIS, type RO, offset 0x050, reset 0x0000.0000</b>																					
								MOSCPUPRIS		USBPLLRIS		PLLRIS		BORRIS							
<b>IMC, type R/W, offset 0x054, reset 0x0000.0000</b>																					
								MOSCPUPIM		USBPLLIIM		PLLIIM		BORIM							
<b>MISC, type R/W1C, offset 0x058, reset 0x0000.0000</b>																					
								MOSCPUPMS		USBPLLMIS		PLLMIS		BORMIS							
<b>RESC, type R/W, offset 0x05C, reset -</b>																					
														MOSCFAIL							
				WDT1				SW		WDT0		BOR		POR		EXT					
<b>RCC, type R/W, offset 0x060, reset 0x078E.3AD1</b>																					
PWRDN				ACG		SYSDIV				USESYSIDV		USEPWMDIV		PWMDIV							
				BYPASS		XTAL				OSCSRC				IOSCDIS		MOSCDIS					
<b>PLLCFG, type RO, offset 0x064, reset -</b>																					
F								R													
<b>GPIOHBCTL, type R/W, offset 0x06C, reset 0x0000.0000</b>																					
				PORTJ		PORTH		PORTG		PORTF		PORTE		PORTD		PORTC		PORTB		PORTA	
<b>RCC2, type R/W, offset 0x070, reset 0x07C0.6810</b>																					
USERCC2		DIV400		SYSDIV2						SYSDIV2LSB											
		USBPWRDN		PWRDN2		BYPASS2				OSCSRC2											
<b>MOSCCTL, type R/W, offset 0x07C, reset 0x0000.0000</b>																					
														CVAL							
<b>DSLCLKCFG, type R/W, offset 0x144, reset 0x0780.0000</b>																					
DSDIVORIDE								DSOSCSRC													
<b>PIOSCCAL, type R/W, offset 0x150, reset 0x0000.0000</b>																					
UTEN				UPDATE				UT													
<b>I2SMCLKCFG, type R/W, offset 0x170, reset 0x0000.0000</b>																					
RXEN				RXI				RXF													
TXEN				TXI				TXF													
<b>DID1, type RO, offset 0x004, reset -</b>																					
VER				FAM				PARTNO													
PINCOUNT				TEMP				PKG		ROHS		QUAL									
<b>DC0, type RO, offset 0x008, reset 0x017F.007F</b>																					
								SRAMSZ													
								FLASHSZ													

31	30	29	28	27	26	25	24	23	22	21	20	19	18	17	16	
15	14	13	12	11	10	9	8	7	6	5	4	3	2	1	0	
<b>DC1, type RO, offset 0x010, reset -</b>																
			WDT1			CAN1	CAN0				PWM			ADC1	ADC0	
	MINSYSDIV				MAXADC1SPD	MAXADC0SPD		MPU		TEMPSNS	PLL	WDT0	SWO	SWD	JTAG	
<b>DC2, type RO, offset 0x014, reset 0x570F.5337</b>																
	EPI0		I2S0		COMP2	COMP1	COMP0					TIMER3	TIMER2	TIMER1	TIMER0	
	I2C1		I2C0			QE1	QE0			SSI1	SSI0		UART2	UART1	UART0	
<b>DC3, type RO, offset 0x018, reset 0xBFFF.FFFF</b>																
32KHZ		CCP5	CCP4	CCP3	CCP2	CCP1	CCP0	ADC0AIN7	ADC0AIN6	ADC0AIN5	ADC0AIN4	ADC0AIN3	ADC0AIN2	ADC0AIN1	ADC0AIN0	
PWMFAULT	C20	C2PLUS	C2MINUS	C10	C1PLUS	C1MINUS	C00	C0PLUS	C0MINUS	PWM5	PWM4	PWM3	PWM2	PWM1	PWM0	
<b>DC4, type RO, offset 0x01C, reset 0x5100.F1FF</b>																
	EPHY0		EMAC0				E1588									
CCP7	CCP6	UDMA	ROM				GPIQJ	GPIOH	GPIOG	GPIOF	GPIOE	GPIOD	GPIOC	GPIOB	GPIOA	
<b>DC5, type RO, offset 0x020, reset 0x0F30.00FF</b>																
					PWMFAULT3	PWMFAULT2	PWMFAULT1	PWMFAULT0			PWMEFLT	PWME SYNC				
									PWM7	PWM6	PWM5	PWM4	PWM3	PWM2	PWM1	PWM0
<b>DC6, type RO, offset 0x024, reset 0x0000.0013</b>																
												USB0PHY			USB0	
<b>DC7, type RO, offset 0x028, reset 0xFFFF.FFFF</b>																
	DMACH30	DMACH29	DMACH28	DMACH27	DMACH26	DMACH25	DMACH24	DMACH23	DMACH22	DMACH21	DMACH20	DMACH19	DMACH18	DMACH17	DMACH16	
DMACH15	DMACH14	DMACH13	DMACH12	DMACH11	DMACH10	DMACH9	DMACH8	DMACH7	DMACH6	DMACH5	DMACH4	DMACH3	DMACH2	DMACH1	DMACH0	
<b>DC8, type RO, offset 0x02C, reset 0xFFFF.FFFF</b>																
ADC1AIN15	ADC1AIN14	ADC1AIN13	ADC1AIN12	ADC1AIN11	ADC1AIN10	ADC1AIN9	ADC1AIN8	ADC1AIN7	ADC1AIN6	ADC1AIN5	ADC1AIN4	ADC1AIN3	ADC1AIN2	ADC1AIN1	ADC1AIN0	
ADC0AIN15	ADC0AIN14	ADC0AIN13	ADC0AIN12	ADC0AIN11	ADC0AIN10	ADC0AIN9	ADC0AIN8	ADC0AIN7	ADC0AIN6	ADC0AIN5	ADC0AIN4	ADC0AIN3	ADC0AIN2	ADC0AIN1	ADC0AIN0	
<b>DC9, type RO, offset 0x190, reset 0x00FF.00FF</b>																
								ADC1DC7	ADC1DC6	ADC1DC5	ADC1DC4	ADC1DC3	ADC1DC2	ADC1DC1	ADC1DC0	
								ADC0DC7	ADC0DC6	ADC0DC5	ADC0DC4	ADC0DC3	ADC0DC2	ADC0DC1	ADC0DC0	
<b>NVMSTAT, type RO, offset 0x1A0, reset 0x0000.0011</b>																
												TPSW			FWB	
<b>RCGC0, type R/W, offset 0x100, reset 0x00000040</b>																
			WDT1			CAN1	CAN0				PWM			ADC1	ADC0	
				MAXADC1SPD	MAXADC0SPD							WDT0				
<b>SCGC0, type R/W, offset 0x110, reset 0x00000040</b>																
			WDT1			CAN1	CAN0				PWM			ADC1	ADC0	
				MAXADC1SPD	MAXADC0SPD							WDT0				
<b>DCGC0, type R/W, offset 0x120, reset 0x00000040</b>																
			WDT1			CAN1	CAN0				PWM			ADC1	ADC0	
												WDT0				
<b>RCGC1, type R/W, offset 0x104, reset 0x00000000</b>																
	EPI0		I2S0		COMP2	COMP1	COMP0					TIMER3	TIMER2	TIMER1	TIMER0	
	I2C1		I2C0			QE1	QE0			SSI1	SSI0		UART2	UART1	UART0	
<b>SCGC1, type R/W, offset 0x114, reset 0x00000000</b>																
	EPI0		I2S0		COMP2	COMP1	COMP0					TIMER3	TIMER2	TIMER1	TIMER0	
	I2C1		I2C0			QE1	QE0			SSI1	SSI0		UART2	UART1	UART0	
<b>DCGC1, type R/W, offset 0x124, reset 0x00000000</b>																
	EPI0		I2S0		COMP2	COMP1	COMP0					TIMER3	TIMER2	TIMER1	TIMER0	
	I2C1		I2C0			QE1	QE0			SSI1	SSI0		UART2	UART1	UART0	
<b>RCGC2, type R/W, offset 0x108, reset 0x00000000</b>																
	EPHY0		EMAC0												USB0	
		UDMA					GPIQJ	GPIOH	GPIOG	GPIOF	GPIOE	GPIOD	GPIOC	GPIOB	GPIOA	

31	30	29	28	27	26	25	24	23	22	21	20	19	18	17	16
15	14	13	12	11	10	9	8	7	6	5	4	3	2	1	0
<b>SCGC2, type R/W, offset 0x118, reset 0x00000000</b>															
	EPHY0		EMAC0												USB0
		UDMA					GPIOJ	GPIOH	GPIOG	GPIOF	GPIOE	GPIOD	GPIOC	GPIOB	GPIOA
<b>DCGC2, type R/W, offset 0x128, reset 0x00000000</b>															
	EPHY0		EMAC0												USB0
		UDMA					GPIOJ	GPIOH	GPIOG	GPIOF	GPIOE	GPIOD	GPIOC	GPIOB	GPIOA
<b>SRCR0, type R/W, offset 0x040, reset 0x00000000</b>															
			WDT1			CAN1	CAN0				PWM			ADC1	ADC0
												WDT0			
<b>SRCR1, type R/W, offset 0x044, reset 0x00000000</b>															
	EPI0		I2S0		COMP2	COMP1	COMP0					TIMER3	TIMER2	TIMER1	TIMER0
	I2C1		I2C0			QE1	QE0			SSI1	SSI0		UART2	UART1	UART0
<b>SRCR2, type R/W, offset 0x048, reset 0x00000000</b>															
	EPHY0		EMAC0												USB0
		UDMA					GPIOJ	GPIOH	GPIOG	GPIOF	GPIOE	GPIOD	GPIOC	GPIOB	GPIOA
<b>Internal Memory</b>															
<b>Flash Memory Registers (Flash Control Offset)</b>															
Base 0x400F.D000															
<b>FMA, type R/W, offset 0x000, reset 0x0000.0000</b>															
															OFFSET
															OFFSET
<b>FMD, type R/W, offset 0x004, reset 0x0000.0000</b>															
															DATA
															DATA
<b>FMC, type R/W, offset 0x008, reset 0x0000.0000</b>															
															WRKEY
												COMT	MERASE	ERASE	WRITE
<b>FCRIS, type RO, offset 0x00C, reset 0x0000.0000</b>															
															PRIS
															ARIS
<b>FCIM, type R/W, offset 0x010, reset 0x0000.0000</b>															
															PMASK
															AMASK
<b>FCMISC, type R/W1C, offset 0x014, reset 0x0000.0000</b>															
															PMISC
															AMISC
<b>FMC2, type R/W, offset 0x020, reset 0x0000.0000</b>															
															WRKEY
															WRBUF
<b>FWBVAL, type R/W, offset 0x030, reset 0x0000.0000</b>															
															FWB[n]
															FWB[n]
<b>FWBn, type R/W, offset 0x100 - 0x17C, reset 0x0000.0000</b>															
															DATA
															DATA
<b>FCTL, type R/W, offset 0x0F8, reset 0x0000.0000</b>															
															USDACK
															USDREQ



31	30	29	28	27	26	25	24	23	22	21	20	19	18	17	16		
15	14	13	12	11	10	9	8	7	6	5	4	3	2	1	0		
<b>Micro Direct Memory Access (μDMA)</b>																	
<b>μDMA Channel Control Structure (Offset from Channel Control Table Base)</b>																	
Base n/a																	
<b>DMASRCENDP, type R/W, offset 0x000, reset -</b>																	
												ADDR					
												ADDR					
<b>DMADSTENDP, type R/W, offset 0x004, reset -</b>																	
												ADDR					
												ADDR					
<b>DMACHCTL, type R/W, offset 0x008, reset -</b>																	
DSTINC				DSTSIZE				SRCINC				SRCSIZE					
ARBSIZE								XFERSIZE				NXTUSEBURST		ARBSIZE			
<b>Micro Direct Memory Access (μDMA)</b>																	
<b>μDMA Registers (Offset from μDMA Base Address)</b>																	
Base 0x400F.F000																	
<b>DMASTAT, type RO, offset 0x000, reset 0x001F.0000</b>																	
												DMACHANS					
												STATE				MASTEN	
<b>DMACFG, type WO, offset 0x004, reset -</b>																	
																MASTEN	
<b>DMACTLBASE, type R/W, offset 0x008, reset 0x0000.0000</b>																	
												ADDR					
ADDR																	
<b>DMAALTBASE, type RO, offset 0x00C, reset 0x0000.0200</b>																	
												ADDR					
												ADDR					
<b>DMAWAITSTAT, type RO, offset 0x010, reset 0x0000.0000</b>																	
												WAITREQ[n]					
												WAITREQ[n]					
<b>DMASWREQ, type WO, offset 0x014, reset -</b>																	
												SWREQ[n]					
												SWREQ[n]					
<b>DMAUSEBURSTSET, type R/W, offset 0x018, reset 0x0000.0000</b>																	
												SET[n]					
												SET[n]					
<b>DMAUSEBURSTCLR, type WO, offset 0x01C, reset -</b>																	
												CLR[n]					
												CLR[n]					
<b>DMAREQMASKSET, type R/W, offset 0x020, reset 0x0000.0000</b>																	
												SET[n]					
												SET[n]					
<b>DMAREQMASKCLR, type WO, offset 0x024, reset -</b>																	
												CLR[n]					
												CLR[n]					
<b>DMAENASET, type R/W, offset 0x028, reset 0x0000.0000</b>																	
												SET[n]					
												SET[n]					
<b>DMAENACL, type WO, offset 0x02C, reset -</b>																	
												CLR[n]					
												CLR[n]					

31	30	29	28	27	26	25	24	23	22	21	20	19	18	17	16
15	14	13	12	11	10	9	8	7	6	5	4	3	2	1	0
<b>DMAALTSET, type R/W, offset 0x030, reset 0x0000.0000</b>															
SET[n]															
SET[n]															
<b>DMAALTCLR, type WO, offset 0x034, reset -</b>															
CLR[n]															
CLR[n]															
<b>DMAPRIOSET, type R/W, offset 0x038, reset 0x0000.0000</b>															
SET[n]															
SET[n]															
<b>DMAPRIOCLR, type WO, offset 0x03C, reset -</b>															
CLR[n]															
CLR[n]															
<b>DMAERRCLR, type R/W, offset 0x04C, reset 0x0000.0000</b>															
															ERRCLR
<b>DMACHASGN, type R/W, offset 0x500, reset 0x0000.0000</b>															
CHASGN[n]															
CHASGN[n]															
<b>DMAPeriphID0, type RO, offset 0xFE0, reset 0x0000.0030</b>															
															PID0
<b>DMAPeriphID1, type RO, offset 0xFE4, reset 0x0000.00B2</b>															
															PID1
<b>DMAPeriphID2, type RO, offset 0xFE8, reset 0x0000.000B</b>															
															PID2
<b>DMAPeriphID3, type RO, offset 0xFEC, reset 0x0000.0000</b>															
															PID3
<b>DMAPeriphID4, type RO, offset 0xFD0, reset 0x0000.0004</b>															
															PID4
<b>DMAPCellID0, type RO, offset 0xFF0, reset 0x0000.000D</b>															
															CID0
<b>DMAPCellID1, type RO, offset 0xFF4, reset 0x0000.00F0</b>															
															CID1
<b>DMAPCellID2, type RO, offset 0xFF8, reset 0x0000.0005</b>															
															CID2
<b>DMAPCellID3, type RO, offset 0xFFC, reset 0x0000.00B1</b>															
															CID3



31	30	29	28	27	26	25	24	23	22	21	20	19	18	17	16
15	14	13	12	11	10	9	8	7	6	5	4	3	2	1	0
<b>General-Purpose Input/Outputs (GPIOs)</b>															
GPIO Port A (APB) base: 0x4000.4000															
GPIO Port A (AHB) base: 0x4005.8000															
GPIO Port B (APB) base: 0x4000.5000															
GPIO Port B (AHB) base: 0x4005.9000															
GPIO Port C (APB) base: 0x4000.6000															
GPIO Port C (AHB) base: 0x4005.A000															
GPIO Port D (APB) base: 0x4000.7000															
GPIO Port D (AHB) base: 0x4005.B000															
GPIO Port E (APB) base: 0x4002.4000															
GPIO Port E (AHB) base: 0x4005.C000															
GPIO Port F (APB) base: 0x4002.5000															
GPIO Port F (AHB) base: 0x4005.D000															
GPIO Port G (APB) base: 0x4002.6000															
GPIO Port G (AHB) base: 0x4005.E000															
GPIO Port H (APB) base: 0x4002.7000															
GPIO Port H (AHB) base: 0x4005.F000															
GPIO Port J (APB) base: 0x4003.D000															
GPIO Port J (AHB) base: 0x4006.0000															
<b>GPIODATA, type R/W, offset 0x000, reset 0x0000.0000</b>															
DATA															
<b>GPIODIR, type R/W, offset 0x400, reset 0x0000.0000</b>															
DIR															
<b>GPIOIS, type R/W, offset 0x404, reset 0x0000.0000</b>															
IS															
<b>GPIOIBE, type R/W, offset 0x408, reset 0x0000.0000</b>															
IBE															
<b>GPIOIEV, type R/W, offset 0x40C, reset 0x0000.0000</b>															
IEV															
<b>GPIOIM, type R/W, offset 0x410, reset 0x0000.0000</b>															
IME															
<b>GPORIS, type RO, offset 0x414, reset 0x0000.0000</b>															
RIS															
<b>GPOMIS, type RO, offset 0x418, reset 0x0000.0000</b>															
MIS															
<b>GPIOICR, type W1C, offset 0x41C, reset 0x0000.0000</b>															
IC															
<b>GPIOAFSEL, type R/W, offset 0x420, reset -</b>															
AFSEL															
<b>GPIDR2R, type R/W, offset 0x500, reset 0x0000.00FF</b>															
DRV2															
<b>GPIDR4R, type R/W, offset 0x504, reset 0x0000.0000</b>															
DRV4															
<b>GPIDR8R, type R/W, offset 0x508, reset 0x0000.0000</b>															
DRV8															

31	30	29	28	27	26	25	24	23	22	21	20	19	18	17	16
15	14	13	12	11	10	9	8	7	6	5	4	3	2	1	0
GPIOODR, type R/W, offset 0x50C, reset 0x0000.0000															
												ODE			
GPIOPUR, type R/W, offset 0x510, reset -															
												PUE			
GPIOPDR, type R/W, offset 0x514, reset 0x0000.0000															
												PDE			
GPIOSLR, type R/W, offset 0x518, reset 0x0000.0000															
												SRL			
GPIODEN, type R/W, offset 0x51C, reset -															
												DEN			
GPIOLOCK, type R/W, offset 0x520, reset 0x0000.0001															
												LOCK			
												LOCK			
GPIOCR, type -, offset 0x524, reset -															
												CR			
GPIOAMSEL, type R/W, offset 0x528, reset 0x0000.0000															
												GPIOAMSEL			
GPIOPCTL, type R/W, offset 0x52C, reset -															
PMC7				PMC6				PMC5				PMC4			
PMC3				PMC2				PMC1				PMC0			
GPIOPeriphID4, type RO, offset 0xFD0, reset 0x0000.0000															
												PID4			
GPIOPeriphID5, type RO, offset 0xFD4, reset 0x0000.0000															
												PID5			
GPIOPeriphID6, type RO, offset 0xFD8, reset 0x0000.0000															
												PID6			
GPIOPeriphID7, type RO, offset 0xFDC, reset 0x0000.0000															
												PID7			
GPIOPeriphID0, type RO, offset 0xFE0, reset 0x0000.0061															
												PID0			
GPIOPeriphID1, type RO, offset 0xFE4, reset 0x0000.0000															
												PID1			
GPIOPeriphID2, type RO, offset 0xFE8, reset 0x0000.0018															
												PID2			
GPIOPeriphID3, type RO, offset 0xFEC, reset 0x0000.0001															
												PID3			

31	30	29	28	27	26	25	24	23	22	21	20	19	18	17	16		
15	14	13	12	11	10	9	8	7	6	5	4	3	2	1	0		
<b>GPIOPCellID0, type RO, offset 0xFF0, reset 0x0000.000D</b>																	
												CID0					
<b>GPIOPCellID1, type RO, offset 0xFF4, reset 0x0000.00F0</b>																	
												CID1					
<b>GPIOPCellID2, type RO, offset 0xFF8, reset 0x0000.0005</b>																	
												CID2					
<b>GPIOPCellID3, type RO, offset 0xFFC, reset 0x0000.00B1</b>																	
												CID3					
<b>External Peripheral Interface (EPI)</b> Base 0x400D.0000																	
<b>EPICFG, type R/W, offset 0x000, reset 0x0000.0000</b>																	
												BLKEN		MODE			
<b>EPIBAUD, type R/W, offset 0x004, reset 0x0000.0000</b>																	
												COUNT1					
												COUNT0					
<b>EPISDRAMCFG, type R/W, offset 0x010, reset 0x42EE.0000</b>																	
FREQ						RFSH											
						SLEEP						SIZE					
<b>EPIHB8CFG, type R/W, offset 0x010, reset 0x0000.0000</b>																	
MAXWAIT						XFFEN		XFEEN		WRHIGH		RDHIGH					
						WRWS		RDWS						MODE			
<b>EPIHB16CFG, type R/W, offset 0x010, reset 0x0000.0000</b>																	
MAXWAIT						XFFEN		XFEEN		WRHIGH		RDHIGH					
						WRWS		RDWS				BSEL		MODE			
<b>EPIGPCFG, type R/W, offset 0x010, reset 0x0000.0000</b>																	
CLKPIN		CLKGATE		RDYEN		FRMPIN		FRM50		FRMCNT		RW		WR2CYC		RD2CYC	
MAXWAIT										ASIZE				DSIZE			
<b>EPIHB8CFG2, type R/W, offset 0x014, reset 0x0000.0000</b>																	
WORD				CSBAUD				CSCFG									
<b>EPIHB16CFG2, type R/W, offset 0x014, reset 0x0000.0000</b>																	
WORD				CSBAUD				CSCFG									
<b>EPIGPCFG2, type R/W, offset 0x014, reset 0x0000.0000</b>																	
WORD																	
<b>EPIADDRMAP, type R/W, offset 0x01C, reset 0x0000.0000</b>																	
						EPSZ		EPADR		ERSZ		ERADR					
<b>EPIRSIZE0, type R/W, offset 0x020, reset 0x0000.0003</b>																	
												SIZE					
<b>EPIRSIZE1, type R/W, offset 0x030, reset 0x0000.0003</b>																	
												SIZE					
<b>EPIRADDR0, type R/W, offset 0x024, reset 0x0000.0000</b>																	
												ADDR					
												ADDR					

31	30	29	28	27	26	25	24	23	22	21	20	19	18	17	16
15	14	13	12	11	10	9	8	7	6	5	4	3	2	1	0
<b>EPIRADDR1, type R/W, offset 0x034, reset 0x0000.0000</b>															
ADDR															
ADDR															
<b>EPIRPSTD0, type R/W, offset 0x028, reset 0x0000.0000</b>															
POSTCNT															
POSTCNT															
<b>EPIRPSTD1, type R/W, offset 0x038, reset 0x0000.0000</b>															
POSTCNT															
POSTCNT															
<b>EPISTAT, type RO, offset 0x060, reset 0x0000.0000</b>															
CELOW XFFULL XFEMPTY INITSEQ WBUSY NBRBUSY ACTIVE															
<b>EPIRFIFOCNT, type RO, offset 0x06C, reset -</b>															
COUNT															
<b>EPIREADFIFO, type RO, offset 0x070, reset -</b>															
DATA															
DATA															
<b>EPIREADFIFO1, type RO, offset 0x074, reset -</b>															
DATA															
DATA															
<b>EPIREADFIFO2, type RO, offset 0x078, reset -</b>															
DATA															
DATA															
<b>EPIREADFIFO3, type RO, offset 0x07C, reset -</b>															
DATA															
DATA															
<b>EPIREADFIFO4, type RO, offset 0x080, reset -</b>															
DATA															
DATA															
<b>EPIREADFIFO5, type RO, offset 0x084, reset -</b>															
DATA															
DATA															
<b>EPIREADFIFO6, type RO, offset 0x088, reset -</b>															
DATA															
DATA															
<b>EPIREADFIFO7, type RO, offset 0x08C, reset -</b>															
DATA															
DATA															
<b>EPIFIFOLVL, type R/W, offset 0x200, reset 0x0000.0033</b>															
WRFIFO WERR RERR															
RDFIFO															
<b>EPIWFIFOCNT, type RO, offset 0x204, reset 0x0000.0004</b>															
WTAV															
<b>EPIIM, type R/W, offset 0x210, reset 0x0000.0000</b>															
WRIM RDIM ERRIM															
<b>EPIRIS, type RO, offset 0x214, reset 0x0000.0004</b>															
WRRIS RDRIS ERRIS															

31	30	29	28	27	26	25	24	23	22	21	20	19	18	17	16	
15	14	13	12	11	10	9	8	7	6	5	4	3	2	1	0	
<b>EPIMIS, type RO, offset 0x218, reset 0x0000.0000</b>																
												WRMIS	RDMIS	ERRMIS		
<b>EPIEISC, type R/W1C, offset 0x21C, reset 0x0000.0000</b>																
												WTFULL	RSTALL	TOUT		
<b>General-Purpose Timers</b>																
Timer0 base: 0x4003.0000 Timer1 base: 0x4003.1000 Timer2 base: 0x4003.2000 Timer3 base: 0x4003.3000																
<b>GPTMCFG, type R/W, offset 0x000, reset 0x0000.0000</b>																
												GPTMCFG				
<b>GPTMTAMR, type R/W, offset 0x004, reset 0x0000.0000</b>																
								TASNAPS	TAWOT	TAMIE	TACDIR	TAAMS	TACMR	TAMR		
<b>GPTMTBMR, type R/W, offset 0x008, reset 0x0000.0000</b>																
								TBSNAPS	TBWOT	TBMIE	TBCDIR	TBAMS	TBCMR	TBMR		
<b>GPTMCTL, type R/W, offset 0x00C, reset 0x0000.0000</b>																
TBPWML		TBOTE	TBEVENT			TBSTALL	TBEN	TAPWML		TAOTE	RTCEN	TAEVENT		TASTALL	TAEN	
<b>GPTMIMR, type R/W, offset 0x018, reset 0x0000.0000</b>																
				TBMIM	CBEIM	CBMIM	TBTOIM					TAMIM	RTCIM	CAEIM	CAMIM	TATOIM
<b>GPTMRIS, type RO, offset 0x01C, reset 0x0000.0000</b>																
				TBMRIS	CBERIS	CBMRIS	TBTORIS					TAMRIS	RTCIS	CAERIS	CAMRIS	TATORIS
<b>GPTMMIS, type RO, offset 0x020, reset 0x0000.0000</b>																
				TBMMIS	CBEMIS	CBMMIS	TBTOMIS					TAMMIS	RTCMIS	CAEMIS	CAMMIS	TATOMIS
<b>GPTMICR, type W1C, offset 0x024, reset 0x0000.0000</b>																
				TBMCINT	CBECINT	CBMCINT	TBTCINT					TAMCINT	RTCCINT	CAECINT	CAMCINT	TATOCINT
<b>GPTMTAILR, type R/W, offset 0x028, reset 0xFFFF.FFFF</b>																
								TAILRH								
								TAILRL								
<b>GPTMTBILR, type R/W, offset 0x02C, reset 0x0000.FFFF</b>																
								TBILRL								
<b>GPTMTAMATCHR, type R/W, offset 0x030, reset 0xFFFF.FFFF</b>																
								TAMRH								
								TAMRL								
<b>GPTMTBMATCHR, type R/W, offset 0x034, reset 0x0000.FFFF</b>																
								TBMRL								
<b>GPTMTAPR, type R/W, offset 0x038, reset 0x0000.0000</b>																
												TAPSR				
<b>GPTMTBPR, type R/W, offset 0x03C, reset 0x0000.0000</b>																
												TBPSR				

31	30	29	28	27	26	25	24	23	22	21	20	19	18	17	16
15	14	13	12	11	10	9	8	7	6	5	4	3	2	1	0
<b>GPTMTAPMR, type R/W, offset 0x040, reset 0x0000.0000</b>															
TAPSMR															
<b>GPTMTBPMR, type R/W, offset 0x044, reset 0x0000.0000</b>															
TBPSMR															
<b>GPTMTAR, type RO, offset 0x048, reset 0xFFFF.FFFF</b>															
TARH															
TARL															
<b>GPTMTBR, type RO, offset 0x04C, reset 0x0000.FFFF (Input Edge-Count Mode)</b>															
TBRL															
<b>GPTMTBR, type RO, offset 0x04C, reset 0x0000.FFFF (All Modes Except Input Edge-Count Mode)</b>															
TBRL															
<b>GPTMTAV, type RW, offset 0x050, reset 0xFFFF.FFFF</b>															
TAVH															
TAVL															
<b>GPTMTBV, type RW, offset 0x054, reset 0x0000.FFFF</b>															
TBVL															
<b>Watchdog Timers</b>															
WDT0 base: 0x4000.0000															
WDT1 base: 0x4000.1000															
<b>WDTLOAD, type R/W, offset 0x000, reset 0xFFFF.FFFF</b>															
WDTLOAD															
WDTLOAD															
<b>WDTVALUE, type RO, offset 0x004, reset 0xFFFF.FFFF</b>															
WDTVALUE															
WDTVALUE															
<b>WDTCTL, type R/W, offset 0x008, reset 0x0000.0000 (WDT0) and 0x8000.0000 (WDT1)</b>															
WRC															
RESEN															
INTEN															
<b>WDTICR, type WO, offset 0x00C, reset -</b>															
WDTINTCLR															
WDTINTCLR															
<b>WDTRIS, type RO, offset 0x010, reset 0x0000.0000</b>															
WDTRIS															
<b>WDTMIS, type RO, offset 0x014, reset 0x0000.0000</b>															
WDTMIS															
<b>WDTTEST, type R/W, offset 0x418, reset 0x0000.0000</b>															
STALL															
<b>WDTLOCK, type R/W, offset 0xC00, reset 0x0000.0000</b>															
WDTLOCK															
WDTLOCK															
<b>WDTPeriphID4, type RO, offset 0xFD0, reset 0x0000.0000</b>															
PID4															

31	30	29	28	27	26	25	24	23	22	21	20	19	18	17	16
15	14	13	12	11	10	9	8	7	6	5	4	3	2	1	0
<b>WDTPeriphID5, type RO, offset 0xFD4, reset 0x0000.0000</b>															
												PID5			
<b>WDTPeriphID6, type RO, offset 0xFD8, reset 0x0000.0000</b>															
												PID6			
<b>WDTPeriphID7, type RO, offset 0xFDC, reset 0x0000.0000</b>															
												PID7			
<b>WDTPeriphID0, type RO, offset 0xFE0, reset 0x0000.0005</b>															
												PID0			
<b>WDTPeriphID1, type RO, offset 0xFE4, reset 0x0000.0018</b>															
												PID1			
<b>WDTPeriphID2, type RO, offset 0xFE8, reset 0x0000.0018</b>															
												PID2			
<b>WDTPeriphID3, type RO, offset 0xFEC, reset 0x0000.0001</b>															
												PID3			
<b>WDTPCellID0, type RO, offset 0xFF0, reset 0x0000.000D</b>															
												CID0			
<b>WDTPCellID1, type RO, offset 0xFF4, reset 0x0000.00F0</b>															
												CID1			
<b>WDTPCellID2, type RO, offset 0xFF8, reset 0x0000.0006</b>															
												CID2			
<b>WDTPCellID3, type RO, offset 0xFFC, reset 0x0000.00B1</b>															
												CID3			
<b>Analog-to-Digital Converter (ADC)</b>															
ADC0 base: 0x4003.8000															
ADC1 base: 0x4003.9000															
<b>ADCACTSS, type R/W, offset 0x000, reset 0x0000.0000</b>															
												ASEN3	ASEN2	ASEN1	ASEN0
<b>ADCRIS, type RO, offset 0x004, reset 0x0000.0000</b>															
												INR3	INR2	INR1	INR0
<b>ADCIM, type R/W, offset 0x008, reset 0x0000.0000</b>															
												DCINSS3	DCINSS2	DCINSS1	DCINSS0
												MASK3	MASK2	MASK1	MASK0
<b>ADCISC, type R/W1C, offset 0x00C, reset 0x0000.0000</b>															
												DCINSS3	DCINSS2	DCINSS1	DCINSS0
												IN3	IN2	IN1	IN0
<b>ADCOSTAT, type R/W1C, offset 0x010, reset 0x0000.0000</b>															
												OV3	OV2	OV1	OV0

31	30	29	28	27	26	25	24	23	22	21	20	19	18	17	16
15	14	13	12	11	10	9	8	7	6	5	4	3	2	1	0
<b>ADCEMUX, type R/W, offset 0x014, reset 0x0000.0000</b>															
EM3				EM2				EM1				EM0			
<b>ADCUSTAT, type R/W1C, offset 0x018, reset 0x0000.0000</b>															
												UV3	UV2	UV1	UV0
<b>ADCSSPRI, type R/W, offset 0x020, reset 0x0000.3210</b>															
SS3				SS2				SS1				SS0			
<b>ADCSPC, type R/W, offset 0x024, reset 0x0000.0000</b>															
												PHASE			
<b>ADCPSSI, type R/W, offset 0x028, reset -</b>															
GSYNC				SYNCWAIT								SS3 SS2 SS1 SS0			
<b>ADCSSAC, type R/W, offset 0x030, reset 0x0000.0000</b>															
												AVG			
<b>ADCDCISC, type R/W1C, offset 0x034, reset 0x0000.0000</b>															
								DCINT7	DCINT6	DCINT5	DCINT4	DCINT3	DCINT2	DCINT1	DCINT0
<b>ADCCTL, type R/W, offset 0x038, reset 0x0000.0000</b>															
												VREF			
<b>ADCSSMUX0, type R/W, offset 0x040, reset 0x0000.0000</b>															
MUX7				MUX6				MUX5				MUX4			
MUX3				MUX2				MUX1				MUX0			
<b>ADCSSCTL0, type R/W, offset 0x044, reset 0x0000.0000</b>															
TS7	IE7	END7	D7	TS6	IE6	END6	D6	TS5	IE5	END5	D5	TS4	IE4	END4	D4
TS3	IE3	END3	D3	TS2	IE2	END2	D2	TS1	IE1	END1	D1	TS0	IE0	END0	D0
<b>ADCSSFIFO0, type RO, offset 0x048, reset -</b>															
												DATA			
<b>ADCSSFIFO1, type RO, offset 0x068, reset -</b>															
												DATA			
<b>ADCSSFIFO2, type RO, offset 0x088, reset -</b>															
												DATA			
<b>ADCSSFIFO3, type RO, offset 0x0A8, reset -</b>															
												DATA			
<b>ADCSSFSTAT0, type RO, offset 0x04C, reset 0x0000.0100</b>															
FULL				EMPTY				HPTR				TPTR			
<b>ADCSSFSTAT1, type RO, offset 0x06C, reset 0x0000.0100</b>															
FULL				EMPTY				HPTR				TPTR			
<b>ADCSSFSTAT2, type RO, offset 0x08C, reset 0x0000.0100</b>															
FULL				EMPTY				HPTR				TPTR			



31	30	29	28	27	26	25	24	23	22	21	20	19	18	17	16								
15	14	13	12	11	10	9	8	7	6	5	4	3	2	1	0								
<b>ADCSSFSTAT3, type RO, offset 0x0AC, reset 0x0000.0100</b>																							
FULL				EMPTY				HPTR				TPTR											
<b>ADCSSOP0, type R/W, offset 0x050, reset 0x0000.0000</b>																							
S7DCOP				S6DCOP				S5DCOP				S4DCOP											
S3DCOP				S2DCOP				S1DCOP				S0DCOP											
<b>ADCSSDC0, type R/W, offset 0x054, reset 0x0000.0000</b>																							
S7DCSEL				S6DCSEL				S5DCSEL				S4DCSEL											
S3DCSEL				S2DCSEL				S1DCSEL				S0DCSEL											
<b>ADCSSMUX1, type R/W, offset 0x060, reset 0x0000.0000</b>																							
MUX3				MUX2				MUX1				MUX0											
<b>ADCSSMUX2, type R/W, offset 0x080, reset 0x0000.0000</b>																							
MUX3				MUX2				MUX1				MUX0											
<b>ADCSSCTL1, type R/W, offset 0x064, reset 0x0000.0000</b>																							
TS3	IE3	END3	D3	TS2	IE2	END2	D2	TS1	IE1	END1	D1	TS0	IE0	END0	D0								
<b>ADCSSCTL2, type R/W, offset 0x084, reset 0x0000.0000</b>																							
TS3	IE3	END3	D3	TS2	IE2	END2	D2	TS1	IE1	END1	D1	TS0	IE0	END0	D0								
<b>ADCSSOP1, type R/W, offset 0x070, reset 0x0000.0000</b>																							
S3DCOP				S2DCOP				S1DCOP				S0DCOP											
<b>ADCSSOP2, type R/W, offset 0x090, reset 0x0000.0000</b>																							
S3DCOP				S2DCOP				S1DCOP				S0DCOP											
<b>ADCSSDC1, type R/W, offset 0x074, reset 0x0000.0000</b>																							
S3DCSEL				S2DCSEL				S1DCSEL				S0DCSEL											
<b>ADCSSDC2, type R/W, offset 0x094, reset 0x0000.0000</b>																							
S3DCSEL				S2DCSEL				S1DCSEL				S0DCSEL											
<b>ADCSSMUX3, type R/W, offset 0x0A0, reset 0x0000.0000</b>																							
												MUX0											
<b>ADCSSCTL3, type R/W, offset 0x0A4, reset 0x0000.0002</b>																							
												TS0	IE0	END0	D0								
<b>ADCSSOP3, type R/W, offset 0x0B0, reset 0x0000.0000</b>																							
												S0DCOP											
<b>ADCSSDC3, type R/W, offset 0x0B4, reset 0x0000.0000</b>																							
												S0DCSEL											
<b>ADCDCRIC, type R/W, offset 0xD00, reset 0x0000.0000</b>																							
								DCTRIG7	DCTRIG6	DCTRIG5	DCTRIG4	DCTRIG3	DCTRIG2	DCTRIG1	DCTRIG0								
								DCINT7	DCINT6	DCINT5	DCINT4	DCINT3	DCINT2	DCINT1	DCINT0								
<b>ADCDCCTL0, type R/W, offset 0xE00, reset 0x0000.0000</b>																							
CTE				CTC				CTM				CIE				CIC				CIM			



31	30	29	28	27	26	25	24	23	22	21	20	19	18	17	16		
15	14	13	12	11	10	9	8	7	6	5	4	3	2	1	0		
<b>UARTSR/UARTECR, type RO, offset 0x004, reset 0x0000.0000 (Read-Only Status Register)</b>																	
													OE	BE	PE	FE	
<b>UARTSR/UARTECR, type WO, offset 0x004, reset 0x0000.0000 (Write-Only Error Clear Register)</b>																	
DATA																	
<b>UARTFR, type RO, offset 0x018, reset 0x0000.0090</b>																	
							RI	TXFE	RXFF	TXFF	RXFE	BUSY	DCD	DSR	CTS		
<b>UARTLPR, type R/W, offset 0x020, reset 0x0000.0000</b>																	
ILPDVSR																	
<b>UARTIBRD, type R/W, offset 0x024, reset 0x0000.0000</b>																	
DIVINT																	
<b>UARTFBRD, type R/W, offset 0x028, reset 0x0000.0000</b>																	
DIVFRAC																	
<b>UARTLCRH, type R/W, offset 0x02C, reset 0x0000.0000</b>																	
								SPS	WLEN	FEN	STP2	EPS	PEN	BRK			
<b>UARTCTL, type R/W, offset 0x030, reset 0x0000.0300</b>																	
CTSEN	RTSEN			RTS	DTR	RXE	TXE	LBE	LIN	HSE	EOT	SMART	SIRLP	SIREN	UARTEN		
<b>UARTIFLS, type R/W, offset 0x034, reset 0x0000.0012</b>																	
RXIFLSEL												TXIFLSEL					
<b>UARTIM, type R/W, offset 0x038, reset 0x0000.0000</b>																	
LME5IM	LME1IM	LMSBIM			OEIM	BEIM	PEIM	FEIM	RTIM	TXIM	RXIM	DSRIM	DCDIM	CTSIM	RIIM		
<b>UARTRIS, type RO, offset 0x03C, reset 0x0000.000F</b>																	
LME5RIS	LME1RIS	LMSBRIS			OERIS	BERIS	PERIS	FERIS	RTRIS	TXRIS	RXRIS	DSRRIS	DCDRIS	CTSRIS	RIRIS		
<b>UARTMIS, type RO, offset 0x040, reset 0x0000.0000</b>																	
LME5MIS	LME1MIS	LMSBMIS			OEMIS	BEMIS	PEMIS	FEMIS	RTMIS	TXMIS	RXMIS	DSRMIS	DCDMIS	CTSMIS	RIMIS		
<b>UARTICR, type W1C, offset 0x044, reset 0x0000.0000</b>																	
LME5MIC	LME1MIC	LMSBMIC			OEIC	BEIC	PEIC	FEIC	RTIC	TXIC	RXIC	DSRMIC	DCDMIC	CTSMIC	RIMIC		
<b>UARTDMACTL, type R/W, offset 0x048, reset 0x0000.0000</b>																	
															DMAERR	TXDMAE	RXDMAE
<b>UARTLCTL, type R/W, offset 0x090, reset 0x0000.0000</b>																	
BLEN												MASTER					
<b>UARTLSS, type RO, offset 0x094, reset 0x0000.0000</b>																	
TSS																	
<b>UARTLTIM, type RO, offset 0x098, reset 0x0000.0000</b>																	
TIMER																	

31	30	29	28	27	26	25	24	23	22	21	20	19	18	17	16						
15	14	13	12	11	10	9	8	7	6	5	4	3	2	1	0						
<b>UARTPeriphID4, type RO, offset 0xFD0, reset 0x0000.0000</b>																					
												PID4									
<b>UARTPeriphID5, type RO, offset 0xFD4, reset 0x0000.0000</b>																					
												PID5									
<b>UARTPeriphID6, type RO, offset 0xFD8, reset 0x0000.0000</b>																					
												PID6									
<b>UARTPeriphID7, type RO, offset 0xFDC, reset 0x0000.0000</b>																					
												PID7									
<b>UARTPeriphID0, type RO, offset 0xFE0, reset 0x0000.0060</b>																					
												PID0									
<b>UARTPeriphID1, type RO, offset 0xFE4, reset 0x0000.0000</b>																					
												PID1									
<b>UARTPeriphID2, type RO, offset 0xFE8, reset 0x0000.0018</b>																					
												PID2									
<b>UARTPeriphID3, type RO, offset 0xFEC, reset 0x0000.0001</b>																					
												PID3									
<b>UARTPCellID0, type RO, offset 0xFF0, reset 0x0000.000D</b>																					
												CID0									
<b>UARTPCellID1, type RO, offset 0xFF4, reset 0x0000.00F0</b>																					
												CID1									
<b>UARTPCellID2, type RO, offset 0xFF8, reset 0x0000.0005</b>																					
												CID2									
<b>UARTPCellID3, type RO, offset 0xFFC, reset 0x0000.00B1</b>																					
												CID3									
<b>Synchronous Serial Interface (SSI)</b> SSI0 base: 0x4000.8000 SSI1 base: 0x4000.9000																					
<b>SSICR0, type R/W, offset 0x000, reset 0x0000.0000</b>																					
SCR								SPH		SPO		FRF		DSS							
<b>SSICR1, type R/W, offset 0x004, reset 0x0000.0000</b>																					
												EOT		SOD		MS		SSE		LBM	
<b>SSIDR, type R/W, offset 0x008, reset 0x0000.0000</b>																					
DATA																					
<b>SSISR, type RO, offset 0x00C, reset 0x0000.0003</b>																					
												BSY		RFF		RNE		TNF		TFE	

31	30	29	28	27	26	25	24	23	22	21	20	19	18	17	16
15	14	13	12	11	10	9	8	7	6	5	4	3	2	1	0
<b>SSICPSR, type R/W, offset 0x010, reset 0x0000.0000</b>															
												CPSDVSR			
<b>SSIIM, type R/W, offset 0x014, reset 0x0000.0000</b>															
												TXIM	RXIM	RTIM	RORIM
<b>SSIRIS, type RO, offset 0x018, reset 0x0000.0008</b>															
												TXRIS	RXRIS	RTRIS	RORRIS
<b>SSIMIS, type RO, offset 0x01C, reset 0x0000.0000</b>															
												TXMIS	RXMIS	RTMIS	RORMIS
<b>SSIICR, type W1C, offset 0x020, reset 0x0000.0000</b>															
														RTIC	RORIC
<b>SSIDMACTL, type R/W, offset 0x024, reset 0x0000.0000</b>															
														TXDMAE	RXDMAE
<b>SSIPeriphID4, type RO, offset 0xFD0, reset 0x0000.0000</b>															
												PID4			
<b>SSIPeriphID5, type RO, offset 0xFD4, reset 0x0000.0000</b>															
												PID5			
<b>SSIPeriphID6, type RO, offset 0xFD8, reset 0x0000.0000</b>															
												PID6			
<b>SSIPeriphID7, type RO, offset 0xFDC, reset 0x0000.0000</b>															
												PID7			
<b>SSIPeriphID0, type RO, offset 0xFE0, reset 0x0000.0022</b>															
												PID0			
<b>SSIPeriphID1, type RO, offset 0xFE4, reset 0x0000.0000</b>															
												PID1			
<b>SSIPeriphID2, type RO, offset 0xFE8, reset 0x0000.0018</b>															
												PID2			
<b>SSIPeriphID3, type RO, offset 0xFEC, reset 0x0000.0001</b>															
												PID3			
<b>SSIPCellID0, type RO, offset 0xFF0, reset 0x0000.000D</b>															
												CID0			
<b>SSIPCellID1, type RO, offset 0xFF4, reset 0x0000.00F0</b>															
												CID1			
<b>SSIPCellID2, type RO, offset 0xFF8, reset 0x0000.0005</b>															
												CID2			

31	30	29	28	27	26	25	24	23	22	21	20	19	18	17	16
15	14	13	12	11	10	9	8	7	6	5	4	3	2	1	0
SSIPCellID3, type RO, offset 0xFFC, reset 0x0000.00B1															
CID3															
<b>Inter-Integrated Circuit (I<sup>2</sup>C) Interface</b>															
<b>I<sup>2</sup>C Master</b>															
I2C Master 0 base: 0x4002.0000															
I2C Master 1 base: 0x4002.1000															
I2CMSA, type R/W, offset 0x000, reset 0x0000.0000															
SA															
R/S															
I2CMCS, type RO, offset 0x004, reset 0x0000.0000 (Read-Only Status Register)															
BUSBSY IDLE ARBLST DATAACK ADRACK ERROR BUSY															
I2CMCS, type WO, offset 0x004, reset 0x0000.0000 (Write-Only Control Register)															
ACK STOP START RUN															
I2CMDR, type R/W, offset 0x008, reset 0x0000.0000															
DATA															
I2CMTPR, type R/W, offset 0x00C, reset 0x0000.0001															
TPR															
I2CMIMR, type R/W, offset 0x010, reset 0x0000.0000															
IM															
I2CMRIS, type RO, offset 0x014, reset 0x0000.0000															
RIS															
I2CMMIS, type RO, offset 0x018, reset 0x0000.0000															
MIS															
I2CMICR, type WO, offset 0x01C, reset 0x0000.0000															
IC															
I2CMCR, type R/W, offset 0x020, reset 0x0000.0000															
SFE MFE															
LPBK															
<b>Inter-Integrated Circuit (I<sup>2</sup>C) Interface</b>															
<b>I<sup>2</sup>C Slave</b>															
I2C Slave 0 base: 0x4002.0800															
I2C Slave 1 base: 0x4002.1800															
I2CSOAR, type R/W, offset 0x000, reset 0x0000.0000															
OAR															
I2CSCSR, type RO, offset 0x004, reset 0x0000.0000 (Read-Only Status Register)															
FBR TREQ RREQ															
I2CSCSR, type WO, offset 0x004, reset 0x0000.0000 (Write-Only Control Register)															
DA															
I2CSDR, type R/W, offset 0x008, reset 0x0000.0000															
DATA															

31	30	29	28	27	26	25	24	23	22	21	20	19	18	17	16
15	14	13	12	11	10	9	8	7	6	5	4	3	2	1	0
<b>I2CSIMR, type R/W, offset 0x00C, reset 0x0000.0000</b>															
												STOPIM	STARTIM	DATAIM	
<b>I2CSRIS, type RO, offset 0x010, reset 0x0000.0000</b>															
												STOPRIS	STARTRIS	DATARIS	
<b>I2CSMIS, type RO, offset 0x014, reset 0x0000.0000</b>															
												STOPMIS	STARTMIS	DATAMIS	
<b>I2CSICR, type WO, offset 0x018, reset 0x0000.0000</b>															
												STOPIC	STARTIC	DATAIC	
<b>Inter-Integrated Circuit Sound (I<sup>2</sup>S) Interface</b>															
Base 0x4005.4000															
<b>I2STXFIFO, type WO, offset 0x000, reset 0x0000.0000</b>															
												TXFIFO			
												TXFIFO			
<b>I2STXFIFOCFG, type R/W, offset 0x004, reset 0x0000.0000</b>															
												CSS	LRS		
<b>I2STXCFG, type R/W, offset 0x008, reset 0x1400.7DF0</b>															
				JST	DLY	SCP	LRP	WM	FMT	MSL					
SSZ						SDSZ									
<b>I2STXLIMIT, type R/W, offset 0x00C, reset 0x0000.0000</b>															
												LIMIT			
<b>I2STXISM, type R/W, offset 0x010, reset 0x0000.0000</b>															
												FFI	FFM		
<b>I2STXLEV, type RO, offset 0x018, reset 0x0000.0000</b>															
												LEVEL			
<b>I2SRXFIFO, type RO, offset 0x800, reset 0x0000.0000</b>															
												RXFIFO			
												RXFIFO			
<b>I2SRXFIFOCFG, type R/W, offset 0x804, reset 0x0000.0000</b>															
												FMM	CSS	LRS	
<b>I2SRXCFG, type R/W, offset 0x808, reset 0x1400.7DF0</b>															
				JST	DLY	SCP	LRP	RM	MSL						
SSZ						SDSZ									
<b>I2SRXLIMIT, type R/W, offset 0x80C, reset 0x0000.7FFF</b>															
												LIMIT			
<b>I2SRXISM, type R/W, offset 0x810, reset 0x0000.0000</b>															
												FFI	FFM		
<b>I2SRXLEV, type RO, offset 0x818, reset 0x0000.0000</b>															
												LEVEL			

31	30	29	28	27	26	25	24	23	22	21	20	19	18	17	16
15	14	13	12	11	10	9	8	7	6	5	4	3	2	1	0
<b>I2SCFG, type R/W, offset 0xC00, reset 0x0000.0000</b>															
										RXSLV	TXSLV			RXEN	TXEN
<b>I2SIM, type R/W, offset 0xC10, reset 0x0000.0000</b>															
										RXREIM	RXSRIM			TXWEIM	TXSRIM
<b>I2SRIS, type RO, offset 0xC14, reset 0x0000.0000</b>															
										RXRERIS	RXSRIS			TXWERIS	TXSRIS
<b>I2SMIS, type RO, offset 0xC18, reset 0x0000.0000</b>															
										RXREMIS	RXSRMIS			TXWEMIS	TXSRMIS
<b>I2SIC, type WO, offset 0xC1C, reset 0x0000.0000</b>															
										RXREIC				TXWEIC	
<b>Controller Area Network (CAN) Module</b>															
CAN0 base: 0x4004.0000															
CAN1 base: 0x4004.1000															
<b>CANCTL, type R/W, offset 0x000, reset 0x0000.0001</b>															
								TEST	CCE	DAR		EIE	SIE	IE	INIT
<b>CANSTS, type R/W, offset 0x004, reset 0x0000.0000</b>															
								BOFF	EWARN	EPASS	RXOK	TXOK		LEC	
<b>CANERR, type RO, offset 0x008, reset 0x0000.0000</b>															
	RP				REC									TEC	
<b>CANBIT, type R/W, offset 0x00C, reset 0x0000.2301</b>															
			TSEG2			TSEG1			SJW					BRP	
<b>CANINT, type RO, offset 0x010, reset 0x0000.0000</b>															
														INTID	
<b>CANTST, type R/W, offset 0x014, reset 0x0000.0000</b>															
								RX		TX	LBACK	SILENT	BASIC		
<b>CANBRPE, type R/W, offset 0x018, reset 0x0000.0000</b>															
														BRPE	
<b>CANIF1CRQ, type R/W, offset 0x020, reset 0x0000.0001</b>															
	BUSY													MNUM	
<b>CANIF2CRQ, type R/W, offset 0x080, reset 0x0000.0001</b>															
	BUSY													MNUM	
<b>CANIF1CMSK, type R/W, offset 0x024, reset 0x0000.0000</b>															
								WRNRD	MASK	ARB	CONTROL	CLRINTPND	NEWDAT / TXRST	DATAA	DATAB
<b>CANIF2CMSK, type R/W, offset 0x084, reset 0x0000.0000</b>															
								WRNRD	MASK	ARB	CONTROL	CLRINTPND	NEWDAT / TXRST	DATAA	DATAB



31	30	29	28	27	26	25	24	23	22	21	20	19	18	17	16				
15	14	13	12	11	10	9	8	7	6	5	4	3	2	1	0				
<b>CANIF1MSK1, type R/W, offset 0x028, reset 0x0000.FFFF</b>																			
MSK																			
<b>CANIF2MSK1, type R/W, offset 0x088, reset 0x0000.FFFF</b>																			
MSK																			
<b>CANIF1MSK2, type R/W, offset 0x02C, reset 0x0000.FFFF</b>																			
MXTD		MDIR		MSK															
<b>CANIF2MSK2, type R/W, offset 0x08C, reset 0x0000.FFFF</b>																			
MXTD		MDIR		MSK															
<b>CANIF1ARB1, type R/W, offset 0x030, reset 0x0000.0000</b>																			
ID																			
<b>CANIF2ARB1, type R/W, offset 0x090, reset 0x0000.0000</b>																			
ID																			
<b>CANIF1ARB2, type R/W, offset 0x034, reset 0x0000.0000</b>																			
MSGVAL		XTD		DIR		ID													
<b>CANIF2ARB2, type R/W, offset 0x094, reset 0x0000.0000</b>																			
MSGVAL		XTD		DIR		ID													
<b>CANIF1MCTL, type R/W, offset 0x038, reset 0x0000.0000</b>																			
NEWDAT		MSGLST		INTPND		UMASK		TXIE		RXIE		RMTEN		TXRQST		EOB		DLC	
<b>CANIF2MCTL, type R/W, offset 0x098, reset 0x0000.0000</b>																			
NEWDAT		MSGLST		INTPND		UMASK		TXIE		RXIE		RMTEN		TXRQST		EOB		DLC	
<b>CANIF1DA1, type R/W, offset 0x03C, reset 0x0000.0000</b>																			
DATA																			
<b>CANIF1DA2, type R/W, offset 0x040, reset 0x0000.0000</b>																			
DATA																			
<b>CANIF1DB1, type R/W, offset 0x044, reset 0x0000.0000</b>																			
DATA																			
<b>CANIF1DB2, type R/W, offset 0x048, reset 0x0000.0000</b>																			
DATA																			
<b>CANIF2DA1, type R/W, offset 0x09C, reset 0x0000.0000</b>																			
DATA																			
<b>CANIF2DA2, type R/W, offset 0x0A0, reset 0x0000.0000</b>																			
DATA																			
<b>CANIF2DB1, type R/W, offset 0x0A4, reset 0x0000.0000</b>																			
DATA																			

31	30	29	28	27	26	25	24	23	22	21	20	19	18	17	16
15	14	13	12	11	10	9	8	7	6	5	4	3	2	1	0
<b>CANIF2DB2, type R/W, offset 0x0A8, reset 0x0000.0000</b>															
DATA															
<b>CANTXRQ1, type RO, offset 0x100, reset 0x0000.0000</b>															
TXRQST															
<b>CANTXRQ2, type RO, offset 0x104, reset 0x0000.0000</b>															
TXRQST															
<b>CANNWDA1, type RO, offset 0x120, reset 0x0000.0000</b>															
NEWDAT															
<b>CANNWDA2, type RO, offset 0x124, reset 0x0000.0000</b>															
NEWDAT															
<b>CANMSG1INT, type RO, offset 0x140, reset 0x0000.0000</b>															
INTPND															
<b>CANMSG2INT, type RO, offset 0x144, reset 0x0000.0000</b>															
INTPND															
<b>CANMSG1VAL, type RO, offset 0x160, reset 0x0000.0000</b>															
MSGVAL															
<b>CANMSG2VAL, type RO, offset 0x164, reset 0x0000.0000</b>															
MSGVAL															
<b>Ethernet Controller</b>															
<b>Ethernet MAC (Ethernet Offset)</b>															
Base 0x4004.8000															
<b>MACRIS/MACIACK, type R/W1C, offset 0x000, reset 0x0000.0000</b>															
PHYINT MDINT RXER FOV TXEMP TXER RXINT															
<b>MACIM, type R/W, offset 0x004, reset 0x0000.007F</b>															
PHYINTM MDINTM RXERM FOVM TXEMPM TXERM RXINTM															
<b>MACRCTL, type R/W, offset 0x008, reset 0x0000.0008</b>															
RSTFIFO BADCRC PRMS AMUL RXEN															
<b>MACTCTL, type R/W, offset 0x00C, reset 0x0000.0000</b>															
DUPLEX CRC PADEN TXEN															
<b>MACDATA, type RO, offset 0x010, reset 0x0000.0000 (Reads)</b>															
RXDATA															
RXDATA															
<b>MACDATA, type WO, offset 0x010, reset 0x0000.0000 (Writes)</b>															
TXDATA															
TXDATA															
<b>MACIA0, type R/W, offset 0x014, reset 0x0000.0000</b>															
MACOCT4 MACOCT3															
MACOCT2 MACOCT1															

31	30	29	28	27	26	25	24	23	22	21	20	19	18	17	16		
15	14	13	12	11	10	9	8	7	6	5	4	3	2	1	0		
<b>MACIA1, type R/W, offset 0x018, reset 0x0000.0000</b>																	
MACOCT6								MACOCT5									
<b>MACTHR, type R/W, offset 0x01C, reset 0x0000.003F</b>																	
												THRESH					
<b>MACMCTL, type R/W, offset 0x020, reset 0x0000.0000</b>																	
												REGADR		WRITE		START	
<b>MACMDV, type R/W, offset 0x024, reset 0x0000.0080</b>																	
												DIV					
<b>MACMTXD, type R/W, offset 0x02C, reset 0x0000.0000</b>																	
MDTX																	
<b>MACMRXD, type R/W, offset 0x030, reset 0x0000.0000</b>																	
MDRX																	
<b>MACNP, type RO, offset 0x034, reset 0x0000.0000</b>																	
NPR																	
<b>MACTR, type R/W, offset 0x038, reset 0x0000.0000</b>																	
NEWTX																	
<b>MACTS, type R/W, offset 0x03C, reset 0x0000.0000</b>																	
TSEN																	
<b>MACLED, type R/W, offset 0x040, reset 0x0000.0100</b>																	
LED1								LED0									
<b>MDIX, type R/W, offset 0x044, reset 0x0000.0000</b>																	
EN																	
<b>Ethernet Controller</b>																	
<b>MII Management (Accessed through the MACMCTL register)</b>																	
<b>MR0, type R/W, address 0x00, reset 0x1000</b>																	
RESET	LOOPBK	SPEEDSL	ANEGEN	PWRDN	ISO	RANEG	DUPLEX	COLT									
<b>MR1, type RO, address 0x01, reset 0x7809</b>																	
100X_F		100X_H		10T_F		10T_H				ANEGC	RFAULT	ANEGA	LINK	JAB	EXTD		
<b>MR2, type RO, address 0x02, reset 0x0161</b>																	
OUI[21:6]																	
<b>MR3, type RO, address 0x03, reset 0xB410</b>																	
OUI[5:0]								MN				RN					
<b>MR4, type R/W, address 0x04, reset 0x01E1</b>																	
NP	RF						A3	A2	A1	A0	S						
<b>MR5, type RO, address 0x05, reset 0x0001</b>																	
NP	ACK	RF	A						S								
<b>MR6, type RO, address 0x06, reset 0x0000</b>																	
												PDF	LPNPA	PRX		LPANEGA	
<b>MR16, type RO, address 0x10, reset 0x0040</b>																	
SR																	

31	30	29	28	27	26	25	24	23	22	21	20	19	18	17	16
15	14	13	12	11	10	9	8	7	6	5	4	3	2	1	0
<b>MR17, type R/W, address 0x11, reset 0x0002</b>															
	FASTRIP	EDPD		LSQE			FASTEST						FGLS	ENON	
<b>MR27, type RO, address 0x1B, reset -</b>															
											XPOL				
<b>MR29, type RO, address 0x1D, reset 0x0000</b>															
								EONIS	ANCOMPIS	RFLTIS	LDIS	LPACKIS	PDFIS	PRXIS	
<b>MR30, type R/W, address 0x1E, reset 0x0000</b>															
								EONIM	ANCOMPIM	RFLTIM	LDIM	LPACKIM	PDFIM	PRXIM	
<b>MR31, type R/W, address 0x1F, reset 0x00040</b>															
			AUTODONE									SPEED			SCRDIS
<b>Universal Serial Bus (USB) Controller</b>															
Base 0x4005.0000															
<b>USBFADDR, type R/W, offset 0x000, reset 0x00</b>															
															FUNCADDR
<b>USBPOWER, type R/W, offset 0x001, reset 0x20 (OTG A / Host Mode)</b>															
												RESET	RESUME	SUSPEND	PWRDNPHY
<b>USBPOWER, type R/W, offset 0x001, reset 0x20 (OTG B / Device Mode)</b>															
								ISOUP	SOFTCONN			RESET	RESUME	SUSPEND	PWRDNPHY
<b>USBTXIS, type RO, offset 0x002, reset 0x0000</b>															
EP15	EP14	EP13	EP12	EP11	EP10	EP9	EP8	EP7	EP6	EP5	EP4	EP3	EP2	EP1	EP0
<b>USBRXIS, type RO, offset 0x004, reset 0x0000</b>															
EP15	EP14	EP13	EP12	EP11	EP10	EP9	EP8	EP7	EP6	EP5	EP4	EP3	EP2	EP1	
<b>USBTXIE, type R/W, offset 0x006, reset 0xFFFF</b>															
EP15	EP14	EP13	EP12	EP11	EP10	EP9	EP8	EP7	EP6	EP5	EP4	EP3	EP2	EP1	EP0
<b>USBRXIE, type R/W, offset 0x008, reset 0xFFFFE</b>															
EP15	EP14	EP13	EP12	EP11	EP10	EP9	EP8	EP7	EP6	EP5	EP4	EP3	EP2	EP1	
<b>USBIS, type RO, offset 0x00A, reset 0x00 (OTG A / Host Mode)</b>															
								VBUSERR	SESREQ	DISCON	CONN	SOF	BABBLE	RESUME	
<b>USBIS, type RO, offset 0x00A, reset 0x00 (OTG B / Device Mode)</b>															
										DISCON		SOF	RESET	RESUME	SUSPEND
<b>USBIE, type R/W, offset 0x00B, reset 0x06 (OTG A / Host Mode)</b>															
								VBUSERR	SESREQ	DISCON	CONN	SOF	BABBLE	RESUME	
<b>USBIE, type R/W, offset 0x00B, reset 0x06 (OTG B / Device Mode)</b>															
										DISCON		SOF	RESET	RESUME	SUSPEND
<b>USBFRAME, type RO, offset 0x00C, reset 0x0000</b>															
															FRAME
<b>USBEPIDX, type R/W, offset 0x00E, reset 0x00</b>															
															EPIDX
<b>USBTTEST, type R/W, offset 0x00F, reset 0x00 (OTG A / Host Mode)</b>															
								FORCEH	FIFOACC	FORCEFS					
<b>USBTTEST, type R/W, offset 0x00F, reset 0x00 (OTG B / Device Mode)</b>															
									FIFOACC	FORCEFS					
<b>USBFIFO0, type R/W, offset 0x020, reset 0x0000.0000</b>															
															EPDATA
															EPDATA
<b>USBFIFO1, type R/W, offset 0x024, reset 0x0000.0000</b>															
															EPDATA
															EPDATA
<b>USBFIFO2, type R/W, offset 0x028, reset 0x0000.0000</b>															
															EPDATA
															EPDATA

31	30	29	28	27	26	25	24	23	22	21	20	19	18	17	16
15	14	13	12	11	10	9	8	7	6	5	4	3	2	1	0
<b>USBFIFO3, type R/W, offset 0x02C, reset 0x0000.0000</b>															
EPDATA															
EPDATA															
<b>USBFIFO4, type R/W, offset 0x030, reset 0x0000.0000</b>															
EPDATA															
EPDATA															
<b>USBFIFO5, type R/W, offset 0x034, reset 0x0000.0000</b>															
EPDATA															
EPDATA															
<b>USBFIFO6, type R/W, offset 0x038, reset 0x0000.0000</b>															
EPDATA															
EPDATA															
<b>USBFIFO7, type R/W, offset 0x03C, reset 0x0000.0000</b>															
EPDATA															
EPDATA															
<b>USBFIFO8, type R/W, offset 0x040, reset 0x0000.0000</b>															
EPDATA															
EPDATA															
<b>USBFIFO9, type R/W, offset 0x044, reset 0x0000.0000</b>															
EPDATA															
EPDATA															
<b>USBFIFO10, type R/W, offset 0x048, reset 0x0000.0000</b>															
EPDATA															
EPDATA															
<b>USBFIFO11, type R/W, offset 0x04C, reset 0x0000.0000</b>															
EPDATA															
EPDATA															
<b>USBFIFO12, type R/W, offset 0x050, reset 0x0000.0000</b>															
EPDATA															
EPDATA															
<b>USBFIFO13, type R/W, offset 0x054, reset 0x0000.0000</b>															
EPDATA															
EPDATA															
<b>USBFIFO14, type R/W, offset 0x058, reset 0x0000.0000</b>															
EPDATA															
EPDATA															
<b>USBFIFO15, type R/W, offset 0x05C, reset 0x0000.0000</b>															
EPDATA															
EPDATA															
<b>USBDEVCTL, type R/W, offset 0x060, reset 0x80</b>															
DEV FSDEV LSDEV VBUS HOST HOSTREQ SESSION															
<b>USBTXFIFOSZ, type R/W, offset 0x062, reset 0x00</b>															
DPB SIZE															
<b>USBRXFIFOSZ, type R/W, offset 0x063, reset 0x00</b>															
DPB SIZE															
<b>USBTXFIFOADD, type R/W, offset 0x064, reset 0x0000</b>															
ADDR															
<b>USBRXFIFOADD, type R/W, offset 0x066, reset 0x0000</b>															
ADDR															
<b>USBCONTIM, type R/W, offset 0x07A, reset 0x5C</b>															
WTCON WTID															

31	30	29	28	27	26	25	24	23	22	21	20	19	18	17	16
15	14	13	12	11	10	9	8	7	6	5	4	3	2	1	0
USBVPLEN, type R/W, offset 0x07B, reset 0x3C															
												VPLEN			
USBFSEOF, type R/W, offset 0x07D, reset 0x77															
												FSEOFG			
USBLSEOF, type R/W, offset 0x07E, reset 0x72															
												LSEOFG			
USBTXFUNCADDR0, type R/W, offset 0x080, reset 0x00															
												ADDR			
USBTXFUNCADDR1, type R/W, offset 0x088, reset 0x00															
												ADDR			
USBTXFUNCADDR2, type R/W, offset 0x090, reset 0x00															
												ADDR			
USBTXFUNCADDR3, type R/W, offset 0x098, reset 0x00															
												ADDR			
USBTXFUNCADDR4, type R/W, offset 0x0A0, reset 0x00															
												ADDR			
USBTXFUNCADDR5, type R/W, offset 0x0A8, reset 0x00															
												ADDR			
USBTXFUNCADDR6, type R/W, offset 0x0B0, reset 0x00															
												ADDR			
USBTXFUNCADDR7, type R/W, offset 0x0B8, reset 0x00															
												ADDR			
USBTXFUNCADDR8, type R/W, offset 0x0C0, reset 0x00															
												ADDR			
USBTXFUNCADDR9, type R/W, offset 0x0C8, reset 0x00															
												ADDR			
USBTXFUNCADDR10, type R/W, offset 0x0D0, reset 0x00															
												ADDR			
USBTXFUNCADDR11, type R/W, offset 0x0D8, reset 0x00															
												ADDR			
USBTXFUNCADDR12, type R/W, offset 0x0E0, reset 0x00															
												ADDR			
USBTXFUNCADDR13, type R/W, offset 0x0E8, reset 0x00															
												ADDR			
USBTXFUNCADDR14, type R/W, offset 0x0F0, reset 0x00															
												ADDR			
USBTXFUNCADDR15, type R/W, offset 0x0F8, reset 0x00															
												ADDR			
USBTXHUBADDR0, type R/W, offset 0x082, reset 0x00															
												MULTTRAN		ADDR	
USBTXHUBADDR1, type R/W, offset 0x08A, reset 0x00															
												MULTTRAN		ADDR	
USBTXHUBADDR2, type R/W, offset 0x092, reset 0x00															
												MULTTRAN		ADDR	
USBTXHUBADDR3, type R/W, offset 0x09A, reset 0x00															
												MULTTRAN		ADDR	
USBTXHUBADDR4, type R/W, offset 0x0A2, reset 0x00															
												MULTTRAN		ADDR	
USBTXHUBADDR5, type R/W, offset 0x0AA, reset 0x00															
												MULTTRAN		ADDR	
USBTXHUBADDR6, type R/W, offset 0x0B2, reset 0x00															
												MULTTRAN		ADDR	

31	30	29	28	27	26	25	24	23	22	21	20	19	18	17	16		
15	14	13	12	11	10	9	8	7	6	5	4	3	2	1	0		
USBTXHUBADDR7, type R/W, offset 0x0BA, reset 0x00																	
								MULTTRAN									ADDR
USBTXHUBADDR8, type R/W, offset 0x0C2, reset 0x00																	
								MULTTRAN									ADDR
USBTXHUBADDR9, type R/W, offset 0x0CA, reset 0x00																	
								MULTTRAN									ADDR
USBTXHUBADDR10, type R/W, offset 0x0D2, reset 0x00																	
								MULTTRAN									ADDR
USBTXHUBADDR11, type R/W, offset 0x0DA, reset 0x00																	
								MULTTRAN									ADDR
USBTXHUBADDR12, type R/W, offset 0x0E2, reset 0x00																	
								MULTTRAN									ADDR
USBTXHUBADDR13, type R/W, offset 0x0EA, reset 0x00																	
								MULTTRAN									ADDR
USBTXHUBADDR14, type R/W, offset 0x0F2, reset 0x00																	
								MULTTRAN									ADDR
USBTXHUBADDR15, type R/W, offset 0x0FA, reset 0x00																	
								MULTTRAN									ADDR
USBTXHUBPORT0, type R/W, offset 0x083, reset 0x00																	
																	PORT
USBTXHUBPORT1, type R/W, offset 0x08B, reset 0x00																	
																	PORT
USBTXHUBPORT2, type R/W, offset 0x093, reset 0x00																	
																	PORT
USBTXHUBPORT3, type R/W, offset 0x09B, reset 0x00																	
																	PORT
USBTXHUBPORT4, type R/W, offset 0x0A3, reset 0x00																	
																	PORT
USBTXHUBPORT5, type R/W, offset 0x0AB, reset 0x00																	
																	PORT
USBTXHUBPORT6, type R/W, offset 0x0B3, reset 0x00																	
																	PORT
USBTXHUBPORT7, type R/W, offset 0x0BB, reset 0x00																	
																	PORT
USBTXHUBPORT8, type R/W, offset 0x0C3, reset 0x00																	
																	PORT
USBTXHUBPORT9, type R/W, offset 0x0CB, reset 0x00																	
																	PORT
USBTXHUBPORT10, type R/W, offset 0x0D3, reset 0x00																	
																	PORT
USBTXHUBPORT11, type R/W, offset 0x0DB, reset 0x00																	
																	PORT
USBTXHUBPORT12, type R/W, offset 0x0E3, reset 0x00																	
																	PORT
USBTXHUBPORT13, type R/W, offset 0x0EB, reset 0x00																	
																	PORT
USBTXHUBPORT14, type R/W, offset 0x0F3, reset 0x00																	
																	PORT
USBTXHUBPORT15, type R/W, offset 0x0FB, reset 0x00																	
																	PORT
USBRXFUNCADDR1, type R/W, offset 0x08C, reset 0x00																	
																	ADDR

31	30	29	28	27	26	25	24	23	22	21	20	19	18	17	16	
15	14	13	12	11	10	9	8	7	6	5	4	3	2	1	0	
USBRXFUNCADDR2, type R/W, offset 0x094, reset 0x00																
								ADDR								
USBRXFUNCADDR3, type R/W, offset 0x09C, reset 0x00																
								ADDR								
USBRXFUNCADDR4, type R/W, offset 0x0A4, reset 0x00																
								ADDR								
USBRXFUNCADDR5, type R/W, offset 0x0AC, reset 0x00																
								ADDR								
USBRXFUNCADDR6, type R/W, offset 0x0B4, reset 0x00																
								ADDR								
USBRXFUNCADDR7, type R/W, offset 0x0BC, reset 0x00																
								ADDR								
USBRXFUNCADDR8, type R/W, offset 0x0C4, reset 0x00																
								ADDR								
USBRXFUNCADDR9, type R/W, offset 0x0CC, reset 0x00																
								ADDR								
USBRXFUNCADDR10, type R/W, offset 0x0D4, reset 0x00																
								ADDR								
USBRXFUNCADDR11, type R/W, offset 0x0DC, reset 0x00																
								ADDR								
USBRXFUNCADDR12, type R/W, offset 0x0E4, reset 0x00																
								ADDR								
USBRXFUNCADDR13, type R/W, offset 0x0EC, reset 0x00																
								ADDR								
USBRXFUNCADDR14, type R/W, offset 0x0F4, reset 0x00																
								ADDR								
USBRXFUNCADDR15, type R/W, offset 0x0FC, reset 0x00																
								ADDR								
USBRXHUBADDR1, type R/W, offset 0x08E, reset 0x00																
								MULTTRAN	ADDR							
USBRXHUBADDR2, type R/W, offset 0x096, reset 0x00																
								MULTTRAN	ADDR							
USBRXHUBADDR3, type R/W, offset 0x09E, reset 0x00																
								MULTTRAN	ADDR							
USBRXHUBADDR4, type R/W, offset 0x0A6, reset 0x00																
								MULTTRAN	ADDR							
USBRXHUBADDR5, type R/W, offset 0x0AE, reset 0x00																
								MULTTRAN	ADDR							
USBRXHUBADDR6, type R/W, offset 0x0B6, reset 0x00																
								MULTTRAN	ADDR							
USBRXHUBADDR7, type R/W, offset 0x0BE, reset 0x00																
								MULTTRAN	ADDR							
USBRXHUBADDR8, type R/W, offset 0x0C6, reset 0x00																
								MULTTRAN	ADDR							
USBRXHUBADDR9, type R/W, offset 0x0CE, reset 0x00																
								MULTTRAN	ADDR							
USBRXHUBADDR10, type R/W, offset 0x0D6, reset 0x00																
								MULTTRAN	ADDR							
USBRXHUBADDR11, type R/W, offset 0x0DE, reset 0x00																
								MULTTRAN	ADDR							
USBRXHUBADDR12, type R/W, offset 0x0E6, reset 0x00																
								MULTTRAN	ADDR							



31	30	29	28	27	26	25	24	23	22	21	20	19	18	17	16	
15	14	13	12	11	10	9	8	7	6	5	4	3	2	1	0	
USBXHUBADDR13, type R/W, offset 0x0EE, reset 0x00																
								MULTTRAN	ADDR							
USBXHUBADDR14, type R/W, offset 0x0F6, reset 0x00																
								MULTTRAN	ADDR							
USBXHUBADDR15, type R/W, offset 0x0FE, reset 0x00																
								MULTTRAN	ADDR							
USBXHUBPORT1, type R/W, offset 0x08F, reset 0x00																
									PORT							
USBXHUBPORT2, type R/W, offset 0x097, reset 0x00																
									PORT							
USBXHUBPORT3, type R/W, offset 0x09F, reset 0x00																
									PORT							
USBXHUBPORT4, type R/W, offset 0x0A7, reset 0x00																
									PORT							
USBXHUBPORT5, type R/W, offset 0x0AF, reset 0x00																
									PORT							
USBXHUBPORT6, type R/W, offset 0x0B7, reset 0x00																
									PORT							
USBXHUBPORT7, type R/W, offset 0x0BF, reset 0x00																
									PORT							
USBXHUBPORT8, type R/W, offset 0x0C7, reset 0x00																
									PORT							
USBXHUBPORT9, type R/W, offset 0x0CF, reset 0x00																
									PORT							
USBXHUBPORT10, type R/W, offset 0x0D7, reset 0x00																
									PORT							
USBXHUBPORT11, type R/W, offset 0x0DF, reset 0x00																
									PORT							
USBXHUBPORT12, type R/W, offset 0x0E7, reset 0x00																
									PORT							
USBXHUBPORT13, type R/W, offset 0x0EF, reset 0x00																
									PORT							
USBXHUBPORT14, type R/W, offset 0x0F7, reset 0x00																
									PORT							
USBXHUBPORT15, type R/W, offset 0x0FF, reset 0x00																
									PORT							
USBTXMAXP1, type R/W, offset 0x110, reset 0x0000																
									MAXLOAD							
USBTXMAXP2, type R/W, offset 0x120, reset 0x0000																
									MAXLOAD							
USBTXMAXP3, type R/W, offset 0x130, reset 0x0000																
									MAXLOAD							
USBTXMAXP4, type R/W, offset 0x140, reset 0x0000																
									MAXLOAD							
USBTXMAXP5, type R/W, offset 0x150, reset 0x0000																
									MAXLOAD							
USBTXMAXP6, type R/W, offset 0x160, reset 0x0000																
									MAXLOAD							
USBTXMAXP7, type R/W, offset 0x170, reset 0x0000																
									MAXLOAD							
USBTXMAXP8, type R/W, offset 0x180, reset 0x0000																
									MAXLOAD							

31	30	29	28	27	26	25	24	23	22	21	20	19	18	17	16
15	14	13	12	11	10	9	8	7	6	5	4	3	2	1	0
USBTXMAXP9, type R/W, offset 0x190, reset 0x0000															
MAXLOAD															
USBTXMAXP10, type R/W, offset 0x1A0, reset 0x0000															
MAXLOAD															
USBTXMAXP11, type R/W, offset 0x1B0, reset 0x0000															
MAXLOAD															
USBTXMAXP12, type R/W, offset 0x1C0, reset 0x0000															
MAXLOAD															
USBTXMAXP13, type R/W, offset 0x1D0, reset 0x0000															
MAXLOAD															
USBTXMAXP14, type R/W, offset 0x1E0, reset 0x0000															
MAXLOAD															
USBTXMAXP15, type R/W, offset 0x1F0, reset 0x0000															
MAXLOAD															
USBCSRL0, type W1C, offset 0x102, reset 0x00 (OTG A / Host Mode)															
NAKTO STATUS REQPKT ERROR SETUP STALLED TXRDY RXRDY															
USBCSRL0, type W1C, offset 0x102, reset 0x00 (OTG B / Device Mode)															
SETENDC RXRDYC STALL SETEND DATAEND STALLED TXRDY RXRDY															
USBCSRH0, type W1C, offset 0x103, reset 0x00 (OTG A / Host Mode)															
DTWE DT FLUSH															
USBCSRH0, type W1C, offset 0x103, reset 0x00 (OTG B / Device Mode)															
FLUSH															
USBCOUNT0, type RO, offset 0x108, reset 0x00															
COUNT															
USBTYP0, type R/W, offset 0x10A, reset 0x00															
SPEED															
USBNAKLMT, type R/W, offset 0x10B, reset 0x00															
NAKLMT															
USBTXCSRL1, type R/W, offset 0x112, reset 0x00 (OTG A / Host Mode)															
NAKTO CLRDT STALLED SETUP FLUSH ERROR FIFONE TXRDY															
USBTXCSRL2, type R/W, offset 0x122, reset 0x00 (OTG A / Host Mode)															
NAKTO CLRDT STALLED SETUP FLUSH ERROR FIFONE TXRDY															
USBTXCSRL3, type R/W, offset 0x132, reset 0x00 (OTG A / Host Mode)															
NAKTO CLRDT STALLED SETUP FLUSH ERROR FIFONE TXRDY															
USBTXCSRL4, type R/W, offset 0x142, reset 0x00 (OTG A / Host Mode)															
NAKTO CLRDT STALLED SETUP FLUSH ERROR FIFONE TXRDY															
USBTXCSRL5, type R/W, offset 0x152, reset 0x00 (OTG A / Host Mode)															
NAKTO CLRDT STALLED SETUP FLUSH ERROR FIFONE TXRDY															
USBTXCSRL6, type R/W, offset 0x162, reset 0x00 (OTG A / Host Mode)															
NAKTO CLRDT STALLED SETUP FLUSH ERROR FIFONE TXRDY															
USBTXCSRL7, type R/W, offset 0x172, reset 0x00 (OTG A / Host Mode)															
NAKTO CLRDT STALLED SETUP FLUSH ERROR FIFONE TXRDY															
USBTXCSRL8, type R/W, offset 0x182, reset 0x00 (OTG A / Host Mode)															
NAKTO CLRDT STALLED SETUP FLUSH ERROR FIFONE TXRDY															
USBTXCSRL9, type R/W, offset 0x192, reset 0x00 (OTG A / Host Mode)															
NAKTO CLRDT STALLED SETUP FLUSH ERROR FIFONE TXRDY															
USBTXCSRL10, type R/W, offset 0x1A2, reset 0x00 (OTG A / Host Mode)															
NAKTO CLRDT STALLED SETUP FLUSH ERROR FIFONE TXRDY															
USBTXCSRL11, type R/W, offset 0x1B2, reset 0x00 (OTG A / Host Mode)															
NAKTO CLRDT STALLED SETUP FLUSH ERROR FIFONE TXRDY															
USBTXCSRL12, type R/W, offset 0x1C2, reset 0x00 (OTG A / Host Mode)															
NAKTO CLRDT STALLED SETUP FLUSH ERROR FIFONE TXRDY															

31	30	29	28	27	26	25	24	23	22	21	20	19	18	17	16
15	14	13	12	11	10	9	8	7	6	5	4	3	2	1	0
USBTXCSR13, type R/W, offset 0x1D2, reset 0x00 (OTG A / Host Mode)															
								NAKTO	CLRDT	STALLED	SETUP	FLUSH	ERROR	FIFONE	TXRDY
USBTXCSR14, type R/W, offset 0x1E2, reset 0x00 (OTG A / Host Mode)															
								NAKTO	CLRDT	STALLED	SETUP	FLUSH	ERROR	FIFONE	TXRDY
USBTXCSR15, type R/W, offset 0x1F2, reset 0x00 (OTG A / Host Mode)															
								NAKTO	CLRDT	STALLED	SETUP	FLUSH	ERROR	FIFONE	TXRDY
USBTXCSR1, type R/W, offset 0x112, reset 0x00 (OTG B / Device Mode)															
									CLRDT	STALLED	STALL	FLUSH	UNDRN	FIFONE	TXRDY
USBTXCSR2, type R/W, offset 0x122, reset 0x00 (OTG B / Device Mode)															
									CLRDT	STALLED	STALL	FLUSH	UNDRN	FIFONE	TXRDY
USBTXCSR3, type R/W, offset 0x132, reset 0x00 (OTG B / Device Mode)															
									CLRDT	STALLED	STALL	FLUSH	UNDRN	FIFONE	TXRDY
USBTXCSR4, type R/W, offset 0x142, reset 0x00 (OTG B / Device Mode)															
									CLRDT	STALLED	STALL	FLUSH	UNDRN	FIFONE	TXRDY
USBTXCSR5, type R/W, offset 0x152, reset 0x00 (OTG B / Device Mode)															
									CLRDT	STALLED	STALL	FLUSH	UNDRN	FIFONE	TXRDY
USBTXCSR6, type R/W, offset 0x162, reset 0x00 (OTG B / Device Mode)															
									CLRDT	STALLED	STALL	FLUSH	UNDRN	FIFONE	TXRDY
USBTXCSR7, type R/W, offset 0x172, reset 0x00 (OTG B / Device Mode)															
									CLRDT	STALLED	STALL	FLUSH	UNDRN	FIFONE	TXRDY
USBTXCSR8, type R/W, offset 0x182, reset 0x00 (OTG B / Device Mode)															
									CLRDT	STALLED	STALL	FLUSH	UNDRN	FIFONE	TXRDY
USBTXCSR9, type R/W, offset 0x192, reset 0x00 (OTG B / Device Mode)															
									CLRDT	STALLED	STALL	FLUSH	UNDRN	FIFONE	TXRDY
USBTXCSR10, type R/W, offset 0x1A2, reset 0x00 (OTG B / Device Mode)															
									CLRDT	STALLED	STALL	FLUSH	UNDRN	FIFONE	TXRDY
USBTXCSR11, type R/W, offset 0x1B2, reset 0x00 (OTG B / Device Mode)															
									CLRDT	STALLED	STALL	FLUSH	UNDRN	FIFONE	TXRDY
USBTXCSR12, type R/W, offset 0x1C2, reset 0x00 (OTG B / Device Mode)															
									CLRDT	STALLED	STALL	FLUSH	UNDRN	FIFONE	TXRDY
USBTXCSR13, type R/W, offset 0x1D2, reset 0x00 (OTG B / Device Mode)															
									CLRDT	STALLED	STALL	FLUSH	UNDRN	FIFONE	TXRDY
USBTXCSR14, type R/W, offset 0x1E2, reset 0x00 (OTG B / Device Mode)															
									CLRDT	STALLED	STALL	FLUSH	UNDRN	FIFONE	TXRDY
USBTXCSR15, type R/W, offset 0x1F2, reset 0x00 (OTG B / Device Mode)															
									CLRDT	STALLED	STALL	FLUSH	UNDRN	FIFONE	TXRDY
USBTXCSRH1, type R/W, offset 0x113, reset 0x00 (OTG A / Host Mode)															
								AUTOSET		MODE	DMAEN	FDT	DMAMOD	DTWE	DT
USBTXCSRH2, type R/W, offset 0x123, reset 0x00 (OTG A / Host Mode)															
								AUTOSET		MODE	DMAEN	FDT	DMAMOD	DTWE	DT
USBTXCSRH3, type R/W, offset 0x133, reset 0x00 (OTG A / Host Mode)															
								AUTOSET		MODE	DMAEN	FDT	DMAMOD	DTWE	DT
USBTXCSRH4, type R/W, offset 0x143, reset 0x00 (OTG A / Host Mode)															
								AUTOSET		MODE	DMAEN	FDT	DMAMOD	DTWE	DT
USBTXCSRH5, type R/W, offset 0x153, reset 0x00 (OTG A / Host Mode)															
								AUTOSET		MODE	DMAEN	FDT	DMAMOD	DTWE	DT
USBTXCSRH6, type R/W, offset 0x163, reset 0x00 (OTG A / Host Mode)															
								AUTOSET		MODE	DMAEN	FDT	DMAMOD	DTWE	DT
USBTXCSRH7, type R/W, offset 0x173, reset 0x00 (OTG A / Host Mode)															
								AUTOSET		MODE	DMAEN	FDT	DMAMOD	DTWE	DT
USBTXCSRH8, type R/W, offset 0x183, reset 0x00 (OTG A / Host Mode)															
								AUTOSET		MODE	DMAEN	FDT	DMAMOD	DTWE	DT

31	30	29	28	27	26	25	24	23	22	21	20	19	18	17	16
15	14	13	12	11	10	9	8	7	6	5	4	3	2	1	0
USBTXCSRH9, type R/W, offset 0x193, reset 0x00 (OTG A / Host Mode)															
								AUTOSET		MODE	DMAEN	FDT	DMAMOD	DTWE	DT
USBTXCSRH10, type R/W, offset 0x1A3, reset 0x00 (OTG A / Host Mode)															
								AUTOSET		MODE	DMAEN	FDT	DMAMOD	DTWE	DT
USBTXCSRH11, type R/W, offset 0x1B3, reset 0x00 (OTG A / Host Mode)															
								AUTOSET		MODE	DMAEN	FDT	DMAMOD	DTWE	DT
USBTXCSRH12, type R/W, offset 0x1C3, reset 0x00 (OTG A / Host Mode)															
								AUTOSET		MODE	DMAEN	FDT	DMAMOD	DTWE	DT
USBTXCSRH13, type R/W, offset 0x1D3, reset 0x00 (OTG A / Host Mode)															
								AUTOSET		MODE	DMAEN	FDT	DMAMOD	DTWE	DT
USBTXCSRH14, type R/W, offset 0x1E3, reset 0x00 (OTG A / Host Mode)															
								AUTOSET		MODE	DMAEN	FDT	DMAMOD	DTWE	DT
USBTXCSRH15, type R/W, offset 0x1F3, reset 0x00 (OTG A / Host Mode)															
								AUTOSET		MODE	DMAEN	FDT	DMAMOD	DTWE	DT
USBTXCSRH1, type R/W, offset 0x113, reset 0x00 (OTG B / Device Mode)															
								AUTOSET	ISO	MODE	DMAEN	FDT	DMAMOD		
USBTXCSRH2, type R/W, offset 0x123, reset 0x00 (OTG B / Device Mode)															
								AUTOSET	ISO	MODE	DMAEN	FDT	DMAMOD		
USBTXCSRH3, type R/W, offset 0x133, reset 0x00 (OTG B / Device Mode)															
								AUTOSET	ISO	MODE	DMAEN	FDT	DMAMOD		
USBTXCSRH4, type R/W, offset 0x143, reset 0x00 (OTG B / Device Mode)															
								AUTOSET	ISO	MODE	DMAEN	FDT	DMAMOD		
USBTXCSRH5, type R/W, offset 0x153, reset 0x00 (OTG B / Device Mode)															
								AUTOSET	ISO	MODE	DMAEN	FDT	DMAMOD		
USBTXCSRH6, type R/W, offset 0x163, reset 0x00 (OTG B / Device Mode)															
								AUTOSET	ISO	MODE	DMAEN	FDT	DMAMOD		
USBTXCSRH7, type R/W, offset 0x173, reset 0x00 (OTG B / Device Mode)															
								AUTOSET	ISO	MODE	DMAEN	FDT	DMAMOD		
USBTXCSRH8, type R/W, offset 0x183, reset 0x00 (OTG B / Device Mode)															
								AUTOSET	ISO	MODE	DMAEN	FDT	DMAMOD		
USBTXCSRH9, type R/W, offset 0x193, reset 0x00 (OTG B / Device Mode)															
								AUTOSET	ISO	MODE	DMAEN	FDT	DMAMOD		
USBTXCSRH10, type R/W, offset 0x1A3, reset 0x00 (OTG B / Device Mode)															
								AUTOSET	ISO	MODE	DMAEN	FDT	DMAMOD		
USBTXCSRH11, type R/W, offset 0x1B3, reset 0x00 (OTG B / Device Mode)															
								AUTOSET	ISO	MODE	DMAEN	FDT	DMAMOD		
USBTXCSRH12, type R/W, offset 0x1C3, reset 0x00 (OTG B / Device Mode)															
								AUTOSET	ISO	MODE	DMAEN	FDT	DMAMOD		
USBTXCSRH13, type R/W, offset 0x1D3, reset 0x00 (OTG B / Device Mode)															
								AUTOSET	ISO	MODE	DMAEN	FDT	DMAMOD		
USBTXCSRH14, type R/W, offset 0x1E3, reset 0x00 (OTG B / Device Mode)															
								AUTOSET	ISO	MODE	DMAEN	FDT	DMAMOD		
USBTXCSRH15, type R/W, offset 0x1F3, reset 0x00 (OTG B / Device Mode)															
								AUTOSET	ISO	MODE	DMAEN	FDT	DMAMOD		
USBRXMAXP1, type R/W, offset 0x114, reset 0x0000															
															MAXLOAD
USBRXMAXP2, type R/W, offset 0x124, reset 0x0000															
															MAXLOAD
USBRXMAXP3, type R/W, offset 0x134, reset 0x0000															
															MAXLOAD
USBRXMAXP4, type R/W, offset 0x144, reset 0x0000															
															MAXLOAD

31	30	29	28	27	26	25	24	23	22	21	20	19	18	17	16
15	14	13	12	11	10	9	8	7	6	5	4	3	2	1	0
USBXMAXP5, type R/W, offset 0x154, reset 0x0000															
MAXLOAD															
USBXMAXP6, type R/W, offset 0x164, reset 0x0000															
MAXLOAD															
USBXMAXP7, type R/W, offset 0x174, reset 0x0000															
MAXLOAD															
USBXMAXP8, type R/W, offset 0x184, reset 0x0000															
MAXLOAD															
USBXMAXP9, type R/W, offset 0x194, reset 0x0000															
MAXLOAD															
USBXMAXP10, type R/W, offset 0x1A4, reset 0x0000															
MAXLOAD															
USBXMAXP11, type R/W, offset 0x1B4, reset 0x0000															
MAXLOAD															
USBXMAXP12, type R/W, offset 0x1C4, reset 0x0000															
MAXLOAD															
USBXMAXP13, type R/W, offset 0x1D4, reset 0x0000															
MAXLOAD															
USBXMAXP14, type R/W, offset 0x1E4, reset 0x0000															
MAXLOAD															
USBXMAXP15, type R/W, offset 0x1F4, reset 0x0000															
MAXLOAD															
USBXCSRL1, type R/W, offset 0x116, reset 0x00 (OTG A / Host Mode)															
CLRDT STALLED REQPKT FLUSH DATAERR / NAKTO ERROR FULL RXRDY															
USBXCSRL2, type R/W, offset 0x126, reset 0x00 (OTG A / Host Mode)															
CLRDT STALLED REQPKT FLUSH DATAERR / NAKTO ERROR FULL RXRDY															
USBXCSRL3, type R/W, offset 0x136, reset 0x00 (OTG A / Host Mode)															
CLRDT STALLED REQPKT FLUSH DATAERR / NAKTO ERROR FULL RXRDY															
USBXCSRL4, type R/W, offset 0x146, reset 0x00 (OTG A / Host Mode)															
CLRDT STALLED REQPKT FLUSH DATAERR / NAKTO ERROR FULL RXRDY															
USBXCSRL5, type R/W, offset 0x156, reset 0x00 (OTG A / Host Mode)															
CLRDT STALLED REQPKT FLUSH DATAERR / NAKTO ERROR FULL RXRDY															
USBXCSRL6, type R/W, offset 0x166, reset 0x00 (OTG A / Host Mode)															
CLRDT STALLED REQPKT FLUSH DATAERR / NAKTO ERROR FULL RXRDY															
USBXCSRL7, type R/W, offset 0x176, reset 0x00 (OTG A / Host Mode)															
CLRDT STALLED REQPKT FLUSH DATAERR / NAKTO ERROR FULL RXRDY															
USBXCSRL8, type R/W, offset 0x186, reset 0x00 (OTG A / Host Mode)															
CLRDT STALLED REQPKT FLUSH DATAERR / NAKTO ERROR FULL RXRDY															
USBXCSRL9, type R/W, offset 0x196, reset 0x00 (OTG A / Host Mode)															
CLRDT STALLED REQPKT FLUSH DATAERR / NAKTO ERROR FULL RXRDY															
USBXCSRL10, type R/W, offset 0x1A6, reset 0x00 (OTG A / Host Mode)															
CLRDT STALLED REQPKT FLUSH DATAERR / NAKTO ERROR FULL RXRDY															
USBXCSRL11, type R/W, offset 0x1B6, reset 0x00 (OTG A / Host Mode)															
CLRDT STALLED REQPKT FLUSH DATAERR / NAKTO ERROR FULL RXRDY															

31	30	29	28	27	26	25	24	23	22	21	20	19	18	17	16
15	14	13	12	11	10	9	8	7	6	5	4	3	2	1	0
USBRXCSRL12, type R/W, offset 0x1C6, reset 0x00 (OTG A / Host Mode)															
								CLRDT	STALLED	REQPKT	FLUSH	DATAERR / NAKTO	ERROR	FULL	RXRDY
USBRXCSRL13, type R/W, offset 0x1D6, reset 0x00 (OTG A / Host Mode)															
								CLRDT	STALLED	REQPKT	FLUSH	DATAERR / NAKTO	ERROR	FULL	RXRDY
USBRXCSRL14, type R/W, offset 0x1E6, reset 0x00 (OTG A / Host Mode)															
								CLRDT	STALLED	REQPKT	FLUSH	DATAERR / NAKTO	ERROR	FULL	RXRDY
USBRXCSRL15, type R/W, offset 0x1F6, reset 0x00 (OTG A / Host Mode)															
								CLRDT	STALLED	REQPKT	FLUSH	DATAERR / NAKTO	ERROR	FULL	RXRDY
USBRXCSR1, type R/W, offset 0x116, reset 0x00 (OTG B / Device Mode)															
								CLRDT	STALLED	STALL	FLUSH	DATAERR	OVER	FULL	RXRDY
USBRXCSR2, type R/W, offset 0x126, reset 0x00 (OTG B / Device Mode)															
								CLRDT	STALLED	STALL	FLUSH	DATAERR	OVER	FULL	RXRDY
USBRXCSR3, type R/W, offset 0x136, reset 0x00 (OTG B / Device Mode)															
								CLRDT	STALLED	STALL	FLUSH	DATAERR	OVER	FULL	RXRDY
USBRXCSR4, type R/W, offset 0x146, reset 0x00 (OTG B / Device Mode)															
								CLRDT	STALLED	STALL	FLUSH	DATAERR	OVER	FULL	RXRDY
USBRXCSR5, type R/W, offset 0x156, reset 0x00 (OTG B / Device Mode)															
								CLRDT	STALLED	STALL	FLUSH	DATAERR	OVER	FULL	RXRDY
USBRXCSR6, type R/W, offset 0x166, reset 0x00 (OTG B / Device Mode)															
								CLRDT	STALLED	STALL	FLUSH	DATAERR	OVER	FULL	RXRDY
USBRXCSR7, type R/W, offset 0x176, reset 0x00 (OTG B / Device Mode)															
								CLRDT	STALLED	STALL	FLUSH	DATAERR	OVER	FULL	RXRDY
USBRXCSR8, type R/W, offset 0x186, reset 0x00 (OTG B / Device Mode)															
								CLRDT	STALLED	STALL	FLUSH	DATAERR	OVER	FULL	RXRDY
USBRXCSR9, type R/W, offset 0x196, reset 0x00 (OTG B / Device Mode)															
								CLRDT	STALLED	STALL	FLUSH	DATAERR	OVER	FULL	RXRDY
USBRXCSR10, type R/W, offset 0x1A6, reset 0x00 (OTG B / Device Mode)															
								CLRDT	STALLED	STALL	FLUSH	DATAERR	OVER	FULL	RXRDY
USBRXCSR11, type R/W, offset 0x1B6, reset 0x00 (OTG B / Device Mode)															
								CLRDT	STALLED	STALL	FLUSH	DATAERR	OVER	FULL	RXRDY
USBRXCSR12, type R/W, offset 0x1C6, reset 0x00 (OTG B / Device Mode)															
								CLRDT	STALLED	STALL	FLUSH	DATAERR	OVER	FULL	RXRDY
USBRXCSR13, type R/W, offset 0x1D6, reset 0x00 (OTG B / Device Mode)															
								CLRDT	STALLED	STALL	FLUSH	DATAERR	OVER	FULL	RXRDY
USBRXCSR14, type R/W, offset 0x1E6, reset 0x00 (OTG B / Device Mode)															
								CLRDT	STALLED	STALL	FLUSH	DATAERR	OVER	FULL	RXRDY
USBRXCSR15, type R/W, offset 0x1F6, reset 0x00 (OTG B / Device Mode)															
								CLRDT	STALLED	STALL	FLUSH	DATAERR	OVER	FULL	RXRDY
USBRXCSRH1, type R/W, offset 0x117, reset 0x00 (OTG A / Host Mode)															
								AUTOCL	AUTORQ	DMAEN	PIDERR	DMAMOD	DTWE	DT	
USBRXCSRH2, type R/W, offset 0x127, reset 0x00 (OTG A / Host Mode)															
								AUTOCL	AUTORQ	DMAEN	PIDERR	DMAMOD	DTWE	DT	
USBRXCSRH3, type R/W, offset 0x137, reset 0x00 (OTG A / Host Mode)															
								AUTOCL	AUTORQ	DMAEN	PIDERR	DMAMOD	DTWE	DT	
USBRXCSRH4, type R/W, offset 0x147, reset 0x00 (OTG A / Host Mode)															
								AUTOCL	AUTORQ	DMAEN	PIDERR	DMAMOD	DTWE	DT	
USBRXCSRH5, type R/W, offset 0x157, reset 0x00 (OTG A / Host Mode)															
								AUTOCL	AUTORQ	DMAEN	PIDERR	DMAMOD	DTWE	DT	

31	30	29	28	27	26	25	24	23	22	21	20	19	18	17	16
15	14	13	12	11	10	9	8	7	6	5	4	3	2	1	0
USBRXCSRH6, type R/W, offset 0x167, reset 0x00 (OTG A / Host Mode)															
								AUTOCL	AUTORQ	DMAEN	PIDERR	DMAMOD	DTWE	DT	
USBRXCSRH7, type R/W, offset 0x177, reset 0x00 (OTG A / Host Mode)															
								AUTOCL	AUTORQ	DMAEN	PIDERR	DMAMOD	DTWE	DT	
USBRXCSRH8, type R/W, offset 0x187, reset 0x00 (OTG A / Host Mode)															
								AUTOCL	AUTORQ	DMAEN	PIDERR	DMAMOD	DTWE	DT	
USBRXCSRH9, type R/W, offset 0x197, reset 0x00 (OTG A / Host Mode)															
								AUTOCL	AUTORQ	DMAEN	PIDERR	DMAMOD	DTWE	DT	
USBRXCSRH10, type R/W, offset 0x1A7, reset 0x00 (OTG A / Host Mode)															
								AUTOCL	AUTORQ	DMAEN	PIDERR	DMAMOD	DTWE	DT	
USBRXCSRH11, type R/W, offset 0x1B7, reset 0x00 (OTG A / Host Mode)															
								AUTOCL	AUTORQ	DMAEN	PIDERR	DMAMOD	DTWE	DT	
USBRXCSRH12, type R/W, offset 0x1C7, reset 0x00 (OTG A / Host Mode)															
								AUTOCL	AUTORQ	DMAEN	PIDERR	DMAMOD	DTWE	DT	
USBRXCSRH13, type R/W, offset 0x1D7, reset 0x00 (OTG A / Host Mode)															
								AUTOCL	AUTORQ	DMAEN	PIDERR	DMAMOD	DTWE	DT	
USBRXCSRH14, type R/W, offset 0x1E7, reset 0x00 (OTG A / Host Mode)															
								AUTOCL	AUTORQ	DMAEN	PIDERR	DMAMOD	DTWE	DT	
USBRXCSRH15, type R/W, offset 0x1F7, reset 0x00 (OTG A / Host Mode)															
								AUTOCL	AUTORQ	DMAEN	PIDERR	DMAMOD	DTWE	DT	
USBRXCSRH1, type R/W, offset 0x117, reset 0x00 (OTG B / Device Mode)															
								AUTOCL	ISO	DMAEN	DISNYET / PIDERR	DMAMOD			
USBRXCSRH2, type R/W, offset 0x127, reset 0x00 (OTG B / Device Mode)															
								AUTOCL	ISO	DMAEN	DISNYET / PIDERR	DMAMOD			
USBRXCSRH3, type R/W, offset 0x137, reset 0x00 (OTG B / Device Mode)															
								AUTOCL	ISO	DMAEN	DISNYET / PIDERR	DMAMOD			
USBRXCSRH4, type R/W, offset 0x147, reset 0x00 (OTG B / Device Mode)															
								AUTOCL	ISO	DMAEN	DISNYET / PIDERR	DMAMOD			
USBRXCSRH5, type R/W, offset 0x157, reset 0x00 (OTG B / Device Mode)															
								AUTOCL	ISO	DMAEN	DISNYET / PIDERR	DMAMOD			
USBRXCSRH6, type R/W, offset 0x167, reset 0x00 (OTG B / Device Mode)															
								AUTOCL	ISO	DMAEN	DISNYET / PIDERR	DMAMOD			
USBRXCSRH7, type R/W, offset 0x177, reset 0x00 (OTG B / Device Mode)															
								AUTOCL	ISO	DMAEN	DISNYET / PIDERR	DMAMOD			
USBRXCSRH8, type R/W, offset 0x187, reset 0x00 (OTG B / Device Mode)															
								AUTOCL	ISO	DMAEN	DISNYET / PIDERR	DMAMOD			
USBRXCSRH9, type R/W, offset 0x197, reset 0x00 (OTG B / Device Mode)															
								AUTOCL	ISO	DMAEN	DISNYET / PIDERR	DMAMOD			
USBRXCSRH10, type R/W, offset 0x1A7, reset 0x00 (OTG B / Device Mode)															
								AUTOCL	ISO	DMAEN	DISNYET / PIDERR	DMAMOD			
USBRXCSRH11, type R/W, offset 0x1B7, reset 0x00 (OTG B / Device Mode)															
								AUTOCL	ISO	DMAEN	DISNYET / PIDERR	DMAMOD			
USBRXCSRH12, type R/W, offset 0x1C7, reset 0x00 (OTG B / Device Mode)															
								AUTOCL	ISO	DMAEN	DISNYET / PIDERR	DMAMOD			

31	30	29	28	27	26	25	24	23	22	21	20	19	18	17	16
15	14	13	12	11	10	9	8	7	6	5	4	3	2	1	0
USBXCSRH13, type R/W, offset 0x1D7, reset 0x00 (OTG B / Device Mode)															
								AUTOCL	ISO	DMAEN	DISNYET / PIDERR	DMAMOD			
USBXCSRH14, type R/W, offset 0x1E7, reset 0x00 (OTG B / Device Mode)															
								AUTOCL	ISO	DMAEN	DISNYET / PIDERR	DMAMOD			
USBXCSRH15, type R/W, offset 0x1F7, reset 0x00 (OTG B / Device Mode)															
								AUTOCL	ISO	DMAEN	DISNYET / PIDERR	DMAMOD			
USBXCOUNT1, type RO, offset 0x118, reset 0x0000															
								COUNT							
USBXCOUNT2, type RO, offset 0x128, reset 0x0000															
								COUNT							
USBXCOUNT3, type RO, offset 0x138, reset 0x0000															
								COUNT							
USBXCOUNT4, type RO, offset 0x148, reset 0x0000															
								COUNT							
USBXCOUNT5, type RO, offset 0x158, reset 0x0000															
								COUNT							
USBXCOUNT6, type RO, offset 0x168, reset 0x0000															
								COUNT							
USBXCOUNT7, type RO, offset 0x178, reset 0x0000															
								COUNT							
USBXCOUNT8, type RO, offset 0x188, reset 0x0000															
								COUNT							
USBXCOUNT9, type RO, offset 0x198, reset 0x0000															
								COUNT							
USBXCOUNT10, type RO, offset 0x1A8, reset 0x0000															
								COUNT							
USBXCOUNT11, type RO, offset 0x1B8, reset 0x0000															
								COUNT							
USBXCOUNT12, type RO, offset 0x1C8, reset 0x0000															
								COUNT							
USBXCOUNT13, type RO, offset 0x1D8, reset 0x0000															
								COUNT							
USBXCOUNT14, type RO, offset 0x1E8, reset 0x0000															
								COUNT							
USBXCOUNT15, type RO, offset 0x1F8, reset 0x0000															
								COUNT							
USBTXTYPE1, type R/W, offset 0x11A, reset 0x00															
								SPEED		PROTO		TEP			
USBTXTYPE2, type R/W, offset 0x12A, reset 0x00															
								SPEED		PROTO		TEP			
USBTXTYPE3, type R/W, offset 0x13A, reset 0x00															
								SPEED		PROTO		TEP			
USBTXTYPE4, type R/W, offset 0x14A, reset 0x00															
								SPEED		PROTO		TEP			
USBTXTYPE5, type R/W, offset 0x15A, reset 0x00															
								SPEED		PROTO		TEP			
USBTXTYPE6, type R/W, offset 0x16A, reset 0x00															
								SPEED		PROTO		TEP			
USBTXTYPE7, type R/W, offset 0x17A, reset 0x00															
								SPEED		PROTO		TEP			



31	30	29	28	27	26	25	24	23	22	21	20	19	18	17	16
15	14	13	12	11	10	9	8	7	6	5	4	3	2	1	0
USBTXTYPE8, type R/W, offset 0x18A, reset 0x00															
								SPEED		PROTO		TEP			
USBTXTYPE9, type R/W, offset 0x19A, reset 0x00															
								SPEED		PROTO		TEP			
USBTXTYPE10, type R/W, offset 0x1AA, reset 0x00															
								SPEED		PROTO		TEP			
USBTXTYPE11, type R/W, offset 0x1BA, reset 0x00															
								SPEED		PROTO		TEP			
USBTXTYPE12, type R/W, offset 0x1CA, reset 0x00															
								SPEED		PROTO		TEP			
USBTXTYPE13, type R/W, offset 0x1DA, reset 0x00															
								SPEED		PROTO		TEP			
USBTXTYPE14, type R/W, offset 0x1EA, reset 0x00															
								SPEED		PROTO		TEP			
USBTXTYPE15, type R/W, offset 0x1FA, reset 0x00															
								SPEED		PROTO		TEP			
USBTXINTERVAL1, type R/W, offset 0x11B, reset 0x00															
								TXPOLL / NAKLMT							
USBTXINTERVAL2, type R/W, offset 0x12B, reset 0x00															
								TXPOLL / NAKLMT							
USBTXINTERVAL3, type R/W, offset 0x13B, reset 0x00															
								TXPOLL / NAKLMT							
USBTXINTERVAL4, type R/W, offset 0x14B, reset 0x00															
								TXPOLL / NAKLMT							
USBTXINTERVAL5, type R/W, offset 0x15B, reset 0x00															
								TXPOLL / NAKLMT							
USBTXINTERVAL6, type R/W, offset 0x16B, reset 0x00															
								TXPOLL / NAKLMT							
USBTXINTERVAL7, type R/W, offset 0x17B, reset 0x00															
								TXPOLL / NAKLMT							
USBTXINTERVAL8, type R/W, offset 0x18B, reset 0x00															
								TXPOLL / NAKLMT							
USBTXINTERVAL9, type R/W, offset 0x19B, reset 0x00															
								TXPOLL / NAKLMT							
USBTXINTERVAL10, type R/W, offset 0x1AB, reset 0x00															
								TXPOLL / NAKLMT							
USBTXINTERVAL11, type R/W, offset 0x1BB, reset 0x00															
								TXPOLL / NAKLMT							
USBTXINTERVAL12, type R/W, offset 0x1CB, reset 0x00															
								TXPOLL / NAKLMT							
USBTXINTERVAL13, type R/W, offset 0x1DB, reset 0x00															
								TXPOLL / NAKLMT							
USBTXINTERVAL14, type R/W, offset 0x1EB, reset 0x00															
								TXPOLL / NAKLMT							
USBTXINTERVAL15, type R/W, offset 0x1FB, reset 0x00															
								TXPOLL / NAKLMT							
USBRXTYPE1, type R/W, offset 0x11C, reset 0x00															
								SPEED		PROTO		TEP			
USBRXTYPE2, type R/W, offset 0x12C, reset 0x00															
								SPEED		PROTO		TEP			
USBRXTYPE3, type R/W, offset 0x13C, reset 0x00															
								SPEED		PROTO		TEP			

31	30	29	28	27	26	25	24	23	22	21	20	19	18	17	16
15	14	13	12	11	10	9	8	7	6	5	4	3	2	1	0
USBRXTYPE4, type R/W, offset 0x14C, reset 0x00															
								SPEED		PROTO		TEP			
USBRXTYPE5, type R/W, offset 0x15C, reset 0x00															
								SPEED		PROTO		TEP			
USBRXTYPE6, type R/W, offset 0x16C, reset 0x00															
								SPEED		PROTO		TEP			
USBRXTYPE7, type R/W, offset 0x17C, reset 0x00															
								SPEED		PROTO		TEP			
USBRXTYPE8, type R/W, offset 0x18C, reset 0x00															
								SPEED		PROTO		TEP			
USBRXTYPE9, type R/W, offset 0x19C, reset 0x00															
								SPEED		PROTO		TEP			
USBRXTYPE10, type R/W, offset 0x1AC, reset 0x00															
								SPEED		PROTO		TEP			
USBRXTYPE11, type R/W, offset 0x1BC, reset 0x00															
								SPEED		PROTO		TEP			
USBRXTYPE12, type R/W, offset 0x1CC, reset 0x00															
								SPEED		PROTO		TEP			
USBRXTYPE13, type R/W, offset 0x1DC, reset 0x00															
								SPEED		PROTO		TEP			
USBRXTYPE14, type R/W, offset 0x1EC, reset 0x00															
								SPEED		PROTO		TEP			
USBRXTYPE15, type R/W, offset 0x1FC, reset 0x00															
								SPEED		PROTO		TEP			
USBRXINTERVAL1, type R/W, offset 0x11D, reset 0x00															
								TXPOLL / NAKLMT							
USBRXINTERVAL2, type R/W, offset 0x12D, reset 0x00															
								TXPOLL / NAKLMT							
USBRXINTERVAL3, type R/W, offset 0x13D, reset 0x00															
								TXPOLL / NAKLMT							
USBRXINTERVAL4, type R/W, offset 0x14D, reset 0x00															
								TXPOLL / NAKLMT							
USBRXINTERVAL5, type R/W, offset 0x15D, reset 0x00															
								TXPOLL / NAKLMT							
USBRXINTERVAL6, type R/W, offset 0x16D, reset 0x00															
								TXPOLL / NAKLMT							
USBRXINTERVAL7, type R/W, offset 0x17D, reset 0x00															
								TXPOLL / NAKLMT							
USBRXINTERVAL8, type R/W, offset 0x18D, reset 0x00															
								TXPOLL / NAKLMT							
USBRXINTERVAL9, type R/W, offset 0x19D, reset 0x00															
								TXPOLL / NAKLMT							
USBRXINTERVAL10, type R/W, offset 0x1AD, reset 0x00															
								TXPOLL / NAKLMT							
USBRXINTERVAL11, type R/W, offset 0x1BD, reset 0x00															
								TXPOLL / NAKLMT							
USBRXINTERVAL12, type R/W, offset 0x1CD, reset 0x00															
								TXPOLL / NAKLMT							
USBRXINTERVAL13, type R/W, offset 0x1DD, reset 0x00															
								TXPOLL / NAKLMT							
USBRXINTERVAL14, type R/W, offset 0x1ED, reset 0x00															
								TXPOLL / NAKLMT							

31	30	29	28	27	26	25	24	23	22	21	20	19	18	17	16
15	14	13	12	11	10	9	8	7	6	5	4	3	2	1	0
USBXRINTERVAL15, type R/W, offset 0x1FD, reset 0x00															
TXPOLL / NAKLMT															
USBRQPKTCOUNT1, type R/W, offset 0x304, reset 0x0000															
COUNT															
USBRQPKTCOUNT2, type R/W, offset 0x308, reset 0x0000															
COUNT															
USBRQPKTCOUNT3, type R/W, offset 0x30C, reset 0x0000															
COUNT															
USBRQPKTCOUNT4, type R/W, offset 0x310, reset 0x0000															
COUNT															
USBRQPKTCOUNT5, type R/W, offset 0x314, reset 0x0000															
COUNT															
USBRQPKTCOUNT6, type R/W, offset 0x318, reset 0x0000															
COUNT															
USBRQPKTCOUNT7, type R/W, offset 0x31C, reset 0x0000															
COUNT															
USBRQPKTCOUNT8, type R/W, offset 0x320, reset 0x0000															
COUNT															
USBRQPKTCOUNT9, type R/W, offset 0x324, reset 0x0000															
COUNT															
USBRQPKTCOUNT10, type R/W, offset 0x328, reset 0x0000															
COUNT															
USBRQPKTCOUNT11, type R/W, offset 0x32C, reset 0x0000															
COUNT															
USBRQPKTCOUNT12, type R/W, offset 0x330, reset 0x0000															
COUNT															
USBRQPKTCOUNT13, type R/W, offset 0x334, reset 0x0000															
COUNT															
USBRQPKTCOUNT14, type R/W, offset 0x338, reset 0x0000															
COUNT															
USBRQPKTCOUNT15, type R/W, offset 0x33C, reset 0x0000															
COUNT															
USBXDPKTBUFDIS, type R/W, offset 0x340, reset 0x0000															
EP15	EP14	EP13	EP12	EP11	EP10	EP9	EP8	EP7	EP6	EP5	EP4	EP3	EP2	EP1	
USBTXDPKTBUFDIS, type R/W, offset 0x342, reset 0x0000															
EP15	EP14	EP13	EP12	EP11	EP10	EP9	EP8	EP7	EP6	EP5	EP4	EP3	EP2	EP1	
USBEPCC, type R/W, offset 0x400, reset 0x0000.0000															
							PFLTACT		PFLTAEN	PFLTSEN	PFLTEN		EPENDE	EPEN	
USBEPCCRIS, type RO, offset 0x404, reset 0x0000.0000															
															PF
USBEPCCIM, type R/W, offset 0x408, reset 0x0000.0000															
															PF
USBEPCCISC, type R/W, offset 0x40C, reset 0x0000.0000															
															PF
USBDRRIS, type RO, offset 0x410, reset 0x0000.0000															
															RESUME



31	30	29	28	27	26	25	24	23	22	21	20	19	18	17	16
15	14	13	12	11	10	9	8	7	6	5	4	3	2	1	0
<b>ACSTAT2, type RO, offset 0x060, reset 0x0000.0000</b>															
														OVAL	
<b>ACCTL0, type R/W, offset 0x024, reset 0x0000.0000</b>															
				TOEN	ASRCP			TSLVAL	TSEN	ISLVAL		ISEN	CINV		
<b>ACCTL1, type R/W, offset 0x044, reset 0x0000.0000</b>															
				TOEN	ASRCP			TSLVAL	TSEN	ISLVAL		ISEN	CINV		
<b>ACCTL2, type R/W, offset 0x064, reset 0x0000.0000</b>															
				TOEN	ASRCP			TSLVAL	TSEN	ISLVAL		ISEN	CINV		
<b>Pulse Width Modulator (PWM)</b>															
Base 0x4002.8000															
<b>PWMCTL, type R/W, offset 0x000, reset 0x0000.0000</b>															
												GLOBALSYNC3	GLOBALSYNC2	GLOBALSYNC1	GLOBALSYNC0
<b>PWMSYNC, type R/W, offset 0x004, reset 0x0000.0000</b>															
												SYNC3	SYNC2	SYNC1	SYNC0
<b>PWMENABLE, type R/W, offset 0x008, reset 0x0000.0000</b>															
								PWM7EN	PWM6EN	PWM5EN	PWM4EN	PWM3EN	PWM2EN	PWM1EN	PWM0EN
<b>PWMINVERT, type R/W, offset 0x00C, reset 0x0000.0000</b>															
								PWM7INV	PWM6INV	PWM5INV	PWM4INV	PWM3INV	PWM2INV	PWM1INV	PWM0INV
<b>PWMFAULT, type R/W, offset 0x010, reset 0x0000.0000</b>															
								FAULT7	FAULT6	FAULT5	FAULT4	FAULT3	FAULT2	FAULT1	FAULT0
<b>PWMINTEN, type R/W, offset 0x014, reset 0x0000.0000</b>															
												INTFAULT3	INTFAULT2	INTFAULT1	INTFAULT0
												INTPWM3	INTPWM2	INTPWM1	INTPWM0
<b>PWMRIS, type RO, offset 0x018, reset 0x0000.0000</b>															
												INTFAULT3	INTFAULT2	INTFAULT1	INTFAULT0
												INTPWM3	INTPWM2	INTPWM1	INTPWM0
<b>PWMISC, type R/W1C, offset 0x01C, reset 0x0000.0000</b>															
												INTFAULT3	INTFAULT2	INTFAULT1	INTFAULT0
												INTPWM3	INTPWM2	INTPWM1	INTPWM0
<b>PWMSTATUS, type RO, offset 0x020, reset 0x0000.0000</b>															
												FAULT3	FAULT2	FAULT1	FAULT0
<b>PWMFAULTVAL, type R/W, offset 0x024, reset 0x0000.0000</b>															
								PWM7	PWM6	PWM5	PWM4	PWM3	PWM2	PWM1	PWM0
<b>PWMENUPD, type R/W, offset 0x028, reset 0x0000.0000</b>															
	ENUPD7	ENUPD6	ENUPD5	ENUPD4	ENUPD3	ENUPD2	ENUPD1	ENUPD0							
<b>PWM0CTL, type R/W, offset 0x040, reset 0x0000.0000</b>															
												LATCH	MINFLTPER	FLTSRC	
	DBFALLUPD	DBRISEUPD	DBCTLUPD	GENBUPD	GENAUPD	CMPBUPD	CMPAUPD	LOADUPD	DEBUG	MODE	ENABLE				
<b>PWM1CTL, type R/W, offset 0x080, reset 0x0000.0000</b>															
												LATCH	MINFLTPER	FLTSRC	
	DBFALLUPD	DBRISEUPD	DBCTLUPD	GENBUPD	GENAUPD	CMPBUPD	CMPAUPD	LOADUPD	DEBUG	MODE	ENABLE				

31	30	29	28	27	26	25	24	23	22	21	20	19	18	17	16																												
15	14	13	12	11	10	9	8	7	6	5	4	3	2	1	0																												
<b>PWM2CTL, type R/W, offset 0x0C0, reset 0x0000.0000</b>																																											
												LATCH	MINFLTPER	FLTSRC																													
DBFALLUPD				DBRISEUPD				DBCTLUPD				GENBUPD				GENAUPD				CMPBUPD		CMPAUPD		LOADUPD		DEBUG		MODE		ENABLE													
<b>PWM3CTL, type R/W, offset 0x100, reset 0x0000.0000</b>																																											
												LATCH	MINFLTPER	FLTSRC																													
DBFALLUPD				DBRISEUPD				DBCTLUPD				GENBUPD				GENAUPD				CMPBUPD		CMPAUPD		LOADUPD		DEBUG		MODE		ENABLE													
<b>PWM0INTEN, type R/W, offset 0x044, reset 0x0000.0000</b>																																											
				TRCMPBD				TRCMPBU				TRCMPAD				TRCMPAU				TRCNTLOAD				TRCNTZERO																			
																INTCMPBD				INTCMPBU				INTCMPAD				INTCMPAU				INTCNTLOAD				INTCNTZERO							
<b>PWM1INTEN, type R/W, offset 0x084, reset 0x0000.0000</b>																																											
				TRCMPBD				TRCMPBU				TRCMPAD				TRCMPAU				TRCNTLOAD				TRCNTZERO																			
																INTCMPBD				INTCMPBU				INTCMPAD				INTCMPAU				INTCNTLOAD				INTCNTZERO							
<b>PWM2INTEN, type R/W, offset 0x0C4, reset 0x0000.0000</b>																																											
				TRCMPBD				TRCMPBU				TRCMPAD				TRCMPAU				TRCNTLOAD				TRCNTZERO																			
																INTCMPBD				INTCMPBU				INTCMPAD				INTCMPAU				INTCNTLOAD				INTCNTZERO							
<b>PWM3INTEN, type R/W, offset 0x104, reset 0x0000.0000</b>																																											
				TRCMPBD				TRCMPBU				TRCMPAD				TRCMPAU				TRCNTLOAD				TRCNTZERO																			
																INTCMPBD				INTCMPBU				INTCMPAD				INTCMPAU				INTCNTLOAD				INTCNTZERO							
<b>PWM0RIS, type RO, offset 0x048, reset 0x0000.0000</b>																																											
																				INTCMPBD				INTCMPBU				INTCMPAD				INTCMPAU				INTCNTLOAD				INTCNTZERO			
<b>PWM1RIS, type RO, offset 0x088, reset 0x0000.0000</b>																																											
																				INTCMPBD				INTCMPBU				INTCMPAD				INTCMPAU				INTCNTLOAD				INTCNTZERO			
<b>PWM2RIS, type RO, offset 0x0C8, reset 0x0000.0000</b>																																											
																				INTCMPBD				INTCMPBU				INTCMPAD				INTCMPAU				INTCNTLOAD				INTCNTZERO			
<b>PWM3RIS, type RO, offset 0x108, reset 0x0000.0000</b>																																											
																				INTCMPBD				INTCMPBU				INTCMPAD				INTCMPAU				INTCNTLOAD				INTCNTZERO			
<b>PWM0ISC, type R/W1C, offset 0x04C, reset 0x0000.0000</b>																																											
																				INTCMPBD				INTCMPBU				INTCMPAD				INTCMPAU				INTCNTLOAD				INTCNTZERO			
<b>PWM1ISC, type R/W1C, offset 0x08C, reset 0x0000.0000</b>																																											
																				INTCMPBD				INTCMPBU				INTCMPAD				INTCMPAU				INTCNTLOAD				INTCNTZERO			
<b>PWM2ISC, type R/W1C, offset 0x0CC, reset 0x0000.0000</b>																																											
																				INTCMPBD				INTCMPBU				INTCMPAD				INTCMPAU				INTCNTLOAD				INTCNTZERO			
<b>PWM3ISC, type R/W1C, offset 0x10C, reset 0x0000.0000</b>																																											
																				INTCMPBD				INTCMPBU				INTCMPAD				INTCMPAU				INTCNTLOAD				INTCNTZERO			
<b>PWM0LOAD, type R/W, offset 0x050, reset 0x0000.0000</b>																																											
LOAD																																											
<b>PWM1LOAD, type R/W, offset 0x090, reset 0x0000.0000</b>																																											
LOAD																																											
<b>PWM2LOAD, type R/W, offset 0x0D0, reset 0x0000.0000</b>																																											
LOAD																																											

31	30	29	28	27	26	25	24	23	22	21	20	19	18	17	16				
15	14	13	12	11	10	9	8	7	6	5	4	3	2	1	0				
<b>PWM3LOAD, type R/W, offset 0x110, reset 0x0000.0000</b>																			
LOAD																			
<b>PWM0COUNT, type RO, offset 0x054, reset 0x0000.0000</b>																			
COUNT																			
<b>PWM1COUNT, type RO, offset 0x094, reset 0x0000.0000</b>																			
COUNT																			
<b>PWM2COUNT, type RO, offset 0x0D4, reset 0x0000.0000</b>																			
COUNT																			
<b>PWM3COUNT, type RO, offset 0x114, reset 0x0000.0000</b>																			
COUNT																			
<b>PWM0CMPA, type R/W, offset 0x058, reset 0x0000.0000</b>																			
COMPA																			
<b>PWM1CMPA, type R/W, offset 0x098, reset 0x0000.0000</b>																			
COMPA																			
<b>PWM2CMPA, type R/W, offset 0x0D8, reset 0x0000.0000</b>																			
COMPA																			
<b>PWM3CMPA, type R/W, offset 0x118, reset 0x0000.0000</b>																			
COMPA																			
<b>PWM0CMPB, type R/W, offset 0x05C, reset 0x0000.0000</b>																			
COMPB																			
<b>PWM1CMPB, type R/W, offset 0x09C, reset 0x0000.0000</b>																			
COMPB																			
<b>PWM2CMPB, type R/W, offset 0x0DC, reset 0x0000.0000</b>																			
COMPB																			
<b>PWM3CMPB, type R/W, offset 0x11C, reset 0x0000.0000</b>																			
COMPB																			
<b>PWM0GENA, type R/W, offset 0x060, reset 0x0000.0000</b>																			
ACTCMPBD				ACTCMPBU				ACTCMPAD				ACTCMPAU				ACTLOAD		ACTZERO	
<b>PWM1GENA, type R/W, offset 0x0A0, reset 0x0000.0000</b>																			
ACTCMPBD				ACTCMPBU				ACTCMPAD				ACTCMPAU				ACTLOAD		ACTZERO	
<b>PWM2GENA, type R/W, offset 0x0E0, reset 0x0000.0000</b>																			
ACTCMPBD				ACTCMPBU				ACTCMPAD				ACTCMPAU				ACTLOAD		ACTZERO	
<b>PWM3GENA, type R/W, offset 0x120, reset 0x0000.0000</b>																			
ACTCMPBD				ACTCMPBU				ACTCMPAD				ACTCMPAU				ACTLOAD		ACTZERO	

31	30	29	28	27	26	25	24	23	22	21	20	19	18	17	16												
15	14	13	12	11	10	9	8	7	6	5	4	3	2	1	0												
<b>PWM0GENB, type R/W, offset 0x064, reset 0x0000.0000</b>																											
				ACTCMPBD				ACTCMPBU				ACTCMPAD				ACTCMPAU				ACTLOAD				ACTZERO			
<b>PWM1GENB, type R/W, offset 0x0A4, reset 0x0000.0000</b>																											
				ACTCMPBD				ACTCMPBU				ACTCMPAD				ACTCMPAU				ACTLOAD				ACTZERO			
<b>PWM2GENB, type R/W, offset 0x0E4, reset 0x0000.0000</b>																											
				ACTCMPBD				ACTCMPBU				ACTCMPAD				ACTCMPAU				ACTLOAD				ACTZERO			
<b>PWM3GENB, type R/W, offset 0x124, reset 0x0000.0000</b>																											
				ACTCMPBD				ACTCMPBU				ACTCMPAD				ACTCMPAU				ACTLOAD				ACTZERO			
<b>PWM0DBCTL, type R/W, offset 0x068, reset 0x0000.0000</b>																											
														ENABLE													
<b>PWM1DBCTL, type R/W, offset 0x0A8, reset 0x0000.0000</b>																											
														ENABLE													
<b>PWM2DBCTL, type R/W, offset 0x0E8, reset 0x0000.0000</b>																											
														ENABLE													
<b>PWM3DBCTL, type R/W, offset 0x128, reset 0x0000.0000</b>																											
														ENABLE													
<b>PWM0DBRISE, type R/W, offset 0x06C, reset 0x0000.0000</b>																											
														RISEDELAY													
<b>PWM1DBRISE, type R/W, offset 0x0AC, reset 0x0000.0000</b>																											
														RISEDELAY													
<b>PWM2DBRISE, type R/W, offset 0x0EC, reset 0x0000.0000</b>																											
														RISEDELAY													
<b>PWM3DBRISE, type R/W, offset 0x12C, reset 0x0000.0000</b>																											
														RISEDELAY													
<b>PWM0DBFALL, type R/W, offset 0x070, reset 0x0000.0000</b>																											
														FALLDELAY													
<b>PWM1DBFALL, type R/W, offset 0x0B0, reset 0x0000.0000</b>																											
														FALLDELAY													
<b>PWM2DBFALL, type R/W, offset 0x0F0, reset 0x0000.0000</b>																											
														FALLDELAY													
<b>PWM3DBFALL, type R/W, offset 0x130, reset 0x0000.0000</b>																											
														FALLDELAY													
<b>PWM0FLTSRC0, type R/W, offset 0x074, reset 0x0000.0000</b>																											
												FAULT3		FAULT2		FAULT1		FAULT0									



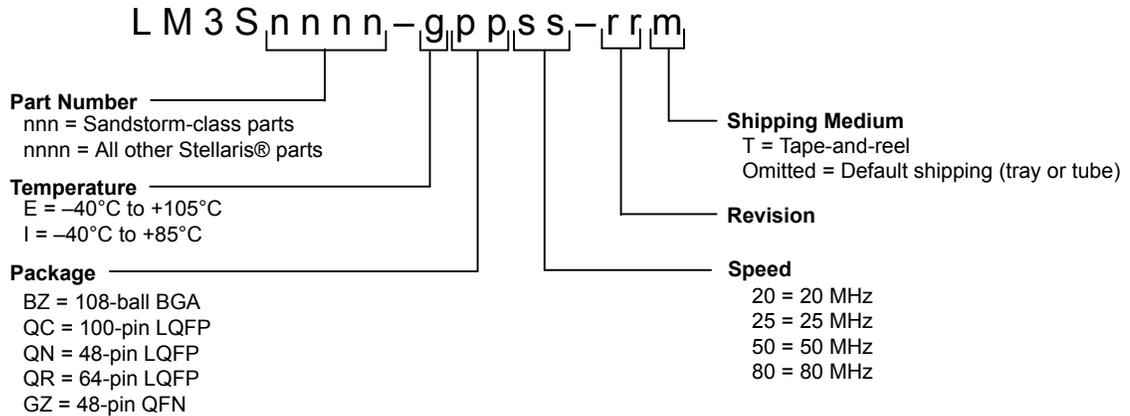
31	30	29	28	27	26	25	24	23	22	21	20	19	18	17	16	
15	14	13	12	11	10	9	8	7	6	5	4	3	2	1	0	
<b>PWM1FLTSRC0, type R/W, offset 0x0B4, reset 0x0000.0000</b>																
													FAULT3	FAULT2	FAULT1	FAULT0
<b>PWM2FLTSRC0, type R/W, offset 0x0F4, reset 0x0000.0000</b>																
													FAULT3	FAULT2	FAULT1	FAULT0
<b>PWM3FLTSRC0, type R/W, offset 0x134, reset 0x0000.0000</b>																
													FAULT3	FAULT2	FAULT1	FAULT0
<b>PWM0FLTSRC1, type R/W, offset 0x078, reset 0x0000.0000</b>																
								DCMP7	DCMP6	DCMP5	DCMP4	DCMP3	DCMP2	DCMP1	DCMP0	
<b>PWM1FLTSRC1, type R/W, offset 0x0B8, reset 0x0000.0000</b>																
								DCMP7	DCMP6	DCMP5	DCMP4	DCMP3	DCMP2	DCMP1	DCMP0	
<b>PWM2FLTSRC1, type R/W, offset 0x0F8, reset 0x0000.0000</b>																
								DCMP7	DCMP6	DCMP5	DCMP4	DCMP3	DCMP2	DCMP1	DCMP0	
<b>PWM3FLTSRC1, type R/W, offset 0x138, reset 0x0000.0000</b>																
								DCMP7	DCMP6	DCMP5	DCMP4	DCMP3	DCMP2	DCMP1	DCMP0	
<b>PWM0MINFLTPER, type R/W, offset 0x07C, reset 0x0000.0000</b>																
MFP																
<b>PWM1MINFLTPER, type R/W, offset 0x0BC, reset 0x0000.0000</b>																
MFP																
<b>PWM2MINFLTPER, type R/W, offset 0x0FC, reset 0x0000.0000</b>																
MFP																
<b>PWM3MINFLTPER, type R/W, offset 0x13C, reset 0x0000.0000</b>																
MFP																
<b>PWM0FLTSEN, type R/W, offset 0x800, reset 0x0000.0000</b>																
													FAULT3	FAULT2	FAULT1	FAULT0
<b>PWM1FLTSEN, type R/W, offset 0x880, reset 0x0000.0000</b>																
													FAULT3	FAULT2	FAULT1	FAULT0
<b>PWM2FLTSEN, type R/W, offset 0x900, reset 0x0000.0000</b>																
													FAULT3	FAULT2	FAULT1	FAULT0
<b>PWM3FLTSEN, type R/W, offset 0x980, reset 0x0000.0000</b>																
													FAULT3	FAULT2	FAULT1	FAULT0
<b>PWM0FLTSTAT0, type -, offset 0x804, reset 0x0000.0000</b>																
													FAULT3	FAULT2	FAULT1	FAULT0
<b>PWM1FLTSTAT0, type -, offset 0x884, reset 0x0000.0000</b>																
													FAULT3	FAULT2	FAULT1	FAULT0

31	30	29	28	27	26	25	24	23	22	21	20	19	18	17	16
15	14	13	12	11	10	9	8	7	6	5	4	3	2	1	0
<b>PWM2FLTSTAT0, type -, offset 0x904, reset 0x0000.0000</b>															
												FAULT3	FAULT2	FAULT1	FAULT0
<b>PWM3FLTSTAT0, type -, offset 0x984, reset 0x0000.0000</b>															
												FAULT3	FAULT2	FAULT1	FAULT0
<b>PWM0FLTSTAT1, type -, offset 0x808, reset 0x0000.0000</b>															
								DCMP7	DCMP6	DCMP5	DCMP4	DCMP3	DCMP2	DCMP1	DCMP0
<b>PWM1FLTSTAT1, type -, offset 0x888, reset 0x0000.0000</b>															
								DCMP7	DCMP6	DCMP5	DCMP4	DCMP3	DCMP2	DCMP1	DCMP0
<b>PWM2FLTSTAT1, type -, offset 0x908, reset 0x0000.0000</b>															
								DCMP7	DCMP6	DCMP5	DCMP4	DCMP3	DCMP2	DCMP1	DCMP0
<b>PWM3FLTSTAT1, type -, offset 0x988, reset 0x0000.0000</b>															
								DCMP7	DCMP6	DCMP5	DCMP4	DCMP3	DCMP2	DCMP1	DCMP0
<b>Quadrature Encoder Interface (QEI)</b>															
QEI0 base: 0x4002.C000															
QEI1 base: 0x4002.D000															
<b>QEICTL, type R/W, offset 0x000, reset 0x0000.0000</b>															
												FILTCNT			
	FILTEN	STALLEN	INVI	INVB	INVA		VELDIV	VELEN	RESMODE	CAPMODE	SIGMODE	SWAP	ENABLE		
<b>QEISTAT, type RO, offset 0x004, reset 0x0000.0000</b>															
												DIRECTION	ERROR		
<b>QEIPOS, type R/W, offset 0x008, reset 0x0000.0000</b>															
POSITION															
POSITION															
<b>QEIMAXPOS, type R/W, offset 0x00C, reset 0x0000.0000</b>															
MAXPOS															
MAXPOS															
<b>QEILOAD, type R/W, offset 0x010, reset 0x0000.0000</b>															
LOAD															
LOAD															
<b>QEITIME, type RO, offset 0x014, reset 0x0000.0000</b>															
TIME															
TIME															
<b>QEICOUNT, type RO, offset 0x018, reset 0x0000.0000</b>															
COUNT															
COUNT															
<b>QEISPEED, type RO, offset 0x01C, reset 0x0000.0000</b>															
SPEED															
SPEED															
<b>QEIIINTEN, type R/W, offset 0x020, reset 0x0000.0000</b>															
												INTERROR	INTDIR	INTTIMER	INTINDEX
<b>QEIRIS, type RO, offset 0x024, reset 0x0000.0000</b>															
												INTERROR	INTDIR	INTTIMER	INTINDEX

31	30	29	28	27	26	25	24	23	22	21	20	19	18	17	16
15	14	13	12	11	10	9	8	7	6	5	4	3	2	1	0
<b>QEIISC, type R/W1C, offset 0x028, reset 0x0000.0000</b>															
												INTERROR	INTDIR	INTTIMER	INTINDEX

## B Ordering and Contact Information

### B.1 Ordering Information



**Table B-1. Part Ordering Information**

Orderable Part Number	Description
LM3S9B96-IQC80-C1	Stellaris® LM3S9B96 Microcontroller Industrial Temperature 100-pin LQFP
LM3S9B96-IBZ80-C1	Stellaris® LM3S9B96 Microcontroller Industrial Temperature 108-ball BGA
LM3S9B96-IQC80-C1T	Stellaris® LM3S9B96 Microcontroller Industrial Temperature 100-pin LQFP Tape-and-reel
LM3S9B96-IBZ80-C1T	Stellaris® LM3S9B96 Microcontroller Industrial Temperature 108-ball BGA Tape-and-reel

### B.2 Part Markings

The Stellaris® microcontrollers are marked with an identifying number. This code contains the following information:

- The first line indicates the part number. In the example below, this is the LM3S9B90.
- In the second line, the first seven characters indicate the temperature, package, speed, and revision. In the example below, this is an Industrial temperature (I), 100-pin LQFP package (QC), 80-MHz (80), revision C0 (C0) device.
- The third line contain internal tracking numbers.



### B.3 Kits

The Stellaris® Family provides the hardware and software tools that engineers need to begin development quickly.

- Reference Design Kits accelerate product development by providing ready-to-run hardware and comprehensive documentation including hardware design files
- Evaluation Kits provide a low-cost and effective means of evaluating Stellaris® microcontrollers before purchase
- Development Kits provide you with all the tools you need to develop and prototype embedded applications right out of the box

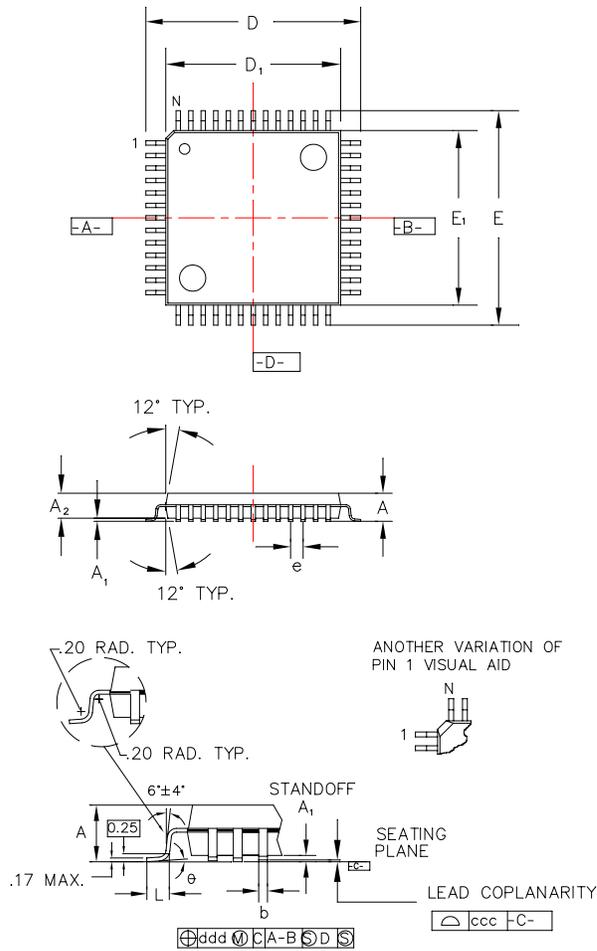
See the website at [www.ti.com/stellaris](http://www.ti.com/stellaris) for the latest tools available, or ask your distributor.

### B.4 Support Information

For support on Stellaris® products, contact the TI Worldwide Product Information Center nearest you: <http://www-k.ext.ti.com/sc/technical-support/product-information-centers.htm>.

# C Package Information

Figure C-1. 100-Pin LQFP Package

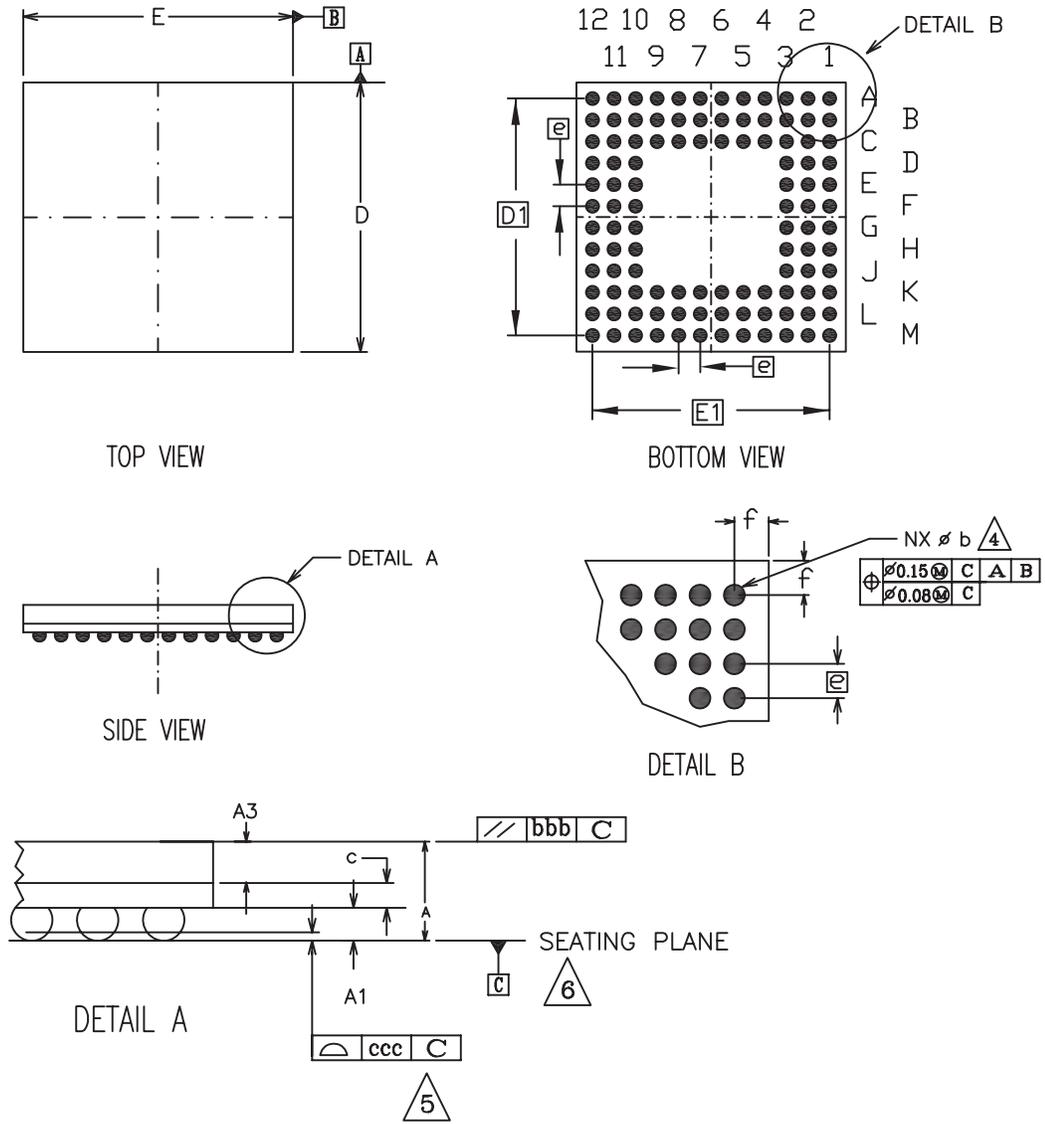


**Note:** The following notes apply to the package drawing.

1. All dimensions shown in mm.
2. Dimensions shown are nominal with tolerances indicated.
3. Foot length 'L' is measured at gage plane 0.25 mm above seating plane.

Body +2.00 mm Footprint, 1.4 mm package thickness		
Symbols	Leads	100L
A	Max.	1.60
A <sub>1</sub>	-	0.05 Min./0.15 Max.
A <sub>2</sub>	±0.05	1.40
D	±0.20	16.00
D <sub>1</sub>	±0.05	14.00
E	±0.20	16.00
E <sub>1</sub>	±0.05	14.00
L	+0.15/-0.10	0.60
e	Basic	0.50
b	+0.05	0.22
θ	-	0°-7°
ddd	Max.	0.08
ccc	Max.	0.08
JEDEC Reference Drawing		MS-026
Variation Designator		BED

Figure C-2. 108-Ball BGA Package





**Note:** The following notes apply to the package drawing.

1. ALL DIMENSIONS ARE IN MILLIMETERS.
  2. 'e' REPRESENTS THE BASIC SOLDER BALL GRID PITCH.
  3. 'M' REPRESENTS THE BASIC SOLDER BALL MATRIX SIZE.  
AND SYMBOL 'N' IS THE NUMBER OF BALLS AFTER DEPOPULATING.
  4. 'b' IS MEASURABLE AT THE MAXIMUM SOLDER BALL DIAMETER AFTER REFLOW  
PARALLEL TO PRIMARY DATUM [C].
  5. DIMENSION 'ccc' IS MEASURED PARALLEL TO PRIMARY DATUM [C].
  6. PRIMARY DATUM [C] AND SEATING PLANE ARE DEFINED BY THE SPHERICAL  
CROWNS OF THE SOLDER BALLS.
  7. PACKAGE SURFACE SHALL BE MATTE FINISH CHARMILLES 24 TO 27.
  8. SUBSTRATE MATERIAL BASE IS BT RESIN.
  9. THE OVERALL PACKAGE THICKNESS "A" ALREADY CONSIDERS COLLAPSE BALLS
  10. DIMENSIONING AND TOLERANCING PER ASME Y14.5M 1994.
11. EXCEPT DIMENSION b.

Symbols	MIN	NOM	MAX
A	1.22	1.36	1.50
A1	0.29	0.34	0.39
A3	0.65	0.70	0.75
c	0.28	0.32	0.36
D	9.85	10.00	10.15
D1	8.80 BSC		
E	9.85	10.00	10.15
E1	8.80 BSC		
b	0.43	0.48	0.53
bbb	.20		
ddd	.12		
e	0.80 BSC		
f	-	0.60	-
M	12		
n	108		
REF: JEDEC MO-219F			

## IMPORTANT NOTICE

Texas Instruments Incorporated and its subsidiaries (TI) reserve the right to make corrections, modifications, enhancements, improvements, and other changes to its products and services at any time and to discontinue any product or service without notice. Customers should obtain the latest relevant information before placing orders and should verify that such information is current and complete. All products are sold subject to TI's terms and conditions of sale supplied at the time of order acknowledgment.

TI warrants performance of its hardware products to the specifications applicable at the time of sale in accordance with TI's standard warranty. Testing and other quality control techniques are used to the extent TI deems necessary to support this warranty. Except where mandated by government requirements, testing of all parameters of each product is not necessarily performed.

TI assumes no liability for applications assistance or customer product design. Customers are responsible for their products and applications using TI components. To minimize the risks associated with customer products and applications, customers should provide adequate design and operating safeguards.

TI does not warrant or represent that any license, either express or implied, is granted under any TI patent right, copyright, mask work right, or other TI intellectual property right relating to any combination, machine, or process in which TI products or services are used. Information published by TI regarding third-party products or services does not constitute a license from TI to use such products or services or a warranty or endorsement thereof. Use of such information may require a license from a third party under the patents or other intellectual property of the third party, or a license from TI under the patents or other intellectual property of TI.

Reproduction of TI information in TI data books or data sheets is permissible only if reproduction is without alteration and is accompanied by all associated warranties, conditions, limitations, and notices. Reproduction of this information with alteration is an unfair and deceptive business practice. TI is not responsible or liable for such altered documentation. Information of third parties may be subject to additional restrictions.

Resale of TI products or services with statements different from or beyond the parameters stated by TI for that product or service voids all express and any implied warranties for the associated TI product or service and is an unfair and deceptive business practice. TI is not responsible or liable for any such statements.

TI products are not authorized for use in safety-critical applications (such as life support) where a failure of the TI product would reasonably be expected to cause severe personal injury or death, unless officers of the parties have executed an agreement specifically governing such use. Buyers represent that they have all necessary expertise in the safety and regulatory ramifications of their applications, and acknowledge and agree that they are solely responsible for all legal, regulatory and safety-related requirements concerning their products and any use of TI products in such safety-critical applications, notwithstanding any applications-related information or support that may be provided by TI. Further, Buyers must fully indemnify TI and its representatives against any damages arising out of the use of TI products in such safety-critical applications.

TI products are neither designed nor intended for use in military/aerospace applications or environments unless the TI products are specifically designated by TI as military-grade or "enhanced plastic." Only products designated by TI as military-grade meet military specifications. Buyers acknowledge and agree that any such use of TI products which TI has not designated as military-grade is solely at the Buyer's risk, and that they are solely responsible for compliance with all legal and regulatory requirements in connection with such use.

TI products are neither designed nor intended for use in automotive applications or environments unless the specific TI products are designated by TI as compliant with ISO/TS 16949 requirements. Buyers acknowledge and agree that, if they use any non-designated products in automotive applications, TI will not be responsible for any failure to meet such requirements.

Following are URLs where you can obtain information on other Texas Instruments products and application solutions:

<b>Products</b>		<b>Applications</b>	
Amplifiers	<a href="http://amplifier.ti.com">amplifier.ti.com</a>	Audio	<a href="http://www.ti.com/audio">www.ti.com/audio</a>
Data Converters	<a href="http://dataconverter.ti.com">dataconverter.ti.com</a>	Automotive	<a href="http://www.ti.com/automotive">www.ti.com/automotive</a>
DLP® Products	<a href="http://www.dlp.com">www.dlp.com</a>	Communications and Telecom	<a href="http://www.ti.com/communications">www.ti.com/communications</a>
DSP	<a href="http://dsp.ti.com">dsp.ti.com</a>	Computers and Peripherals	<a href="http://www.ti.com/computers">www.ti.com/computers</a>
Clocks and Timers	<a href="http://www.ti.com/clocks">www.ti.com/clocks</a>	Consumer Electronics	<a href="http://www.ti.com/consumer-apps">www.ti.com/consumer-apps</a>
Interface	<a href="http://interface.ti.com">interface.ti.com</a>	Energy	<a href="http://www.ti.com/energy">www.ti.com/energy</a>
Logic	<a href="http://logic.ti.com">logic.ti.com</a>	Industrial	<a href="http://www.ti.com/industrial">www.ti.com/industrial</a>
Power Mgmt	<a href="http://power.ti.com">power.ti.com</a>	Medical	<a href="http://www.ti.com/medical">www.ti.com/medical</a>
Microcontrollers	<a href="http://microcontroller.ti.com">microcontroller.ti.com</a>	Security	<a href="http://www.ti.com/security">www.ti.com/security</a>
RFID	<a href="http://www.ti-rfid.com">www.ti-rfid.com</a>	Space, Avionics & Defense	<a href="http://www.ti.com/space-avionics-defense">www.ti.com/space-avionics-defense</a>
RF/IF and ZigBee® Solutions	<a href="http://www.ti.com/lprf">www.ti.com/lprf</a>	Video and Imaging	<a href="http://www.ti.com/video">www.ti.com/video</a>
		Wireless	<a href="http://www.ti.com/wireless-apps">www.ti.com/wireless-apps</a>