



# Ultra-High-Precision, Ultra-Low-Noise, Series Voltage Reference

MAX6126

## General Description

The MAX6126 is an ultra-low-noise, high-precision, low-dropout voltage reference. This family of voltage references feature curvature-correction circuitry and high-stability, laser-trimmed, thin-film resistors that result in 3ppm/°C (max) temperature coefficients and an excellent  $\pm 0.02\%$  (max) initial accuracy. The proprietary low-noise reference architecture produces a low flicker noise of  $1.3\mu\text{Vp-p}$  and wideband noise as low as  $60\text{nV}/\sqrt{\text{Hz}}$  (2.048V output) without the increased supply current usually found in low-noise references. Improve wideband noise to  $35\text{nV}/\sqrt{\text{Hz}}$  and AC power-supply rejection by adding a  $0.1\mu\text{F}$  capacitor at the noise reduction pin. The MAX6126 series mode reference operates from a wide 2.7V to 12.6V supply voltage range and load-regulation specifications are guaranteed to be less than  $0.025\Omega$  for sink and source currents up to 10mA. These devices are available over the automotive temperature range of  $-40^\circ\text{C}$  to  $+125^\circ\text{C}$ .

The MAX6126 typically draws  $380\mu\text{A}$  of supply current and is available in 2.048V, 2.500V, 3.000V, 4.096V, and 5.000V output voltages. These devices also feature dropout voltages as low as 200mV. Unlike conventional shunt-mode (two-terminal) references that waste supply current and require an external resistor, the MAX6126 offers supply current that is virtually independent of supply voltage and does not require an external resistor. The MAX6126 is stable with  $0.1\mu\text{F}$  to  $10\mu\text{F}$  of load capacitance.

The MAX6126 is available in the tiny 8-pin  $\mu\text{MAX}$ , as well as 8-pin SO packages.

## Applications

- High-Resolution A/D and D/A Converters
- ATE Equipment
- High-Accuracy Reference Standard
- Precision Current Sources
- Digital Voltmeters
- High-Accuracy Industrial and Process Control

## Features

- ◆ Ultra-Low  $1.3\mu\text{Vp-p}$  Noise (0.1Hz to 10Hz, 2.048V Output)
- ◆ Ultra-Low 3ppm/°C (max) Temperature Coefficient
- ◆  $\pm 0.02\%$  (max) Initial Accuracy
- ◆ Wide ( $V_{\text{OUT}} + 200\text{mV}$ ) to 12.6V Supply Voltage Range
- ◆ Low 200mV (max) Dropout Voltage
- ◆ 380 $\mu\text{A}$  Quiescent Supply Current
- ◆ 10mA Sink/Source-Current Capability
- ◆ Stable with  $C_{\text{LOAD}} = 0.1\mu\text{F}$  to  $10\mu\text{F}$
- ◆ Low 20ppm/1000hr Long-Term Stability
- ◆  $0.025\Omega$  (max) Load Regulation
- ◆ 20 $\mu\text{V/V}$  (max) Line Regulation
- ◆ Force and Sense Outputs for Remote Sensing

## Pin Configuration

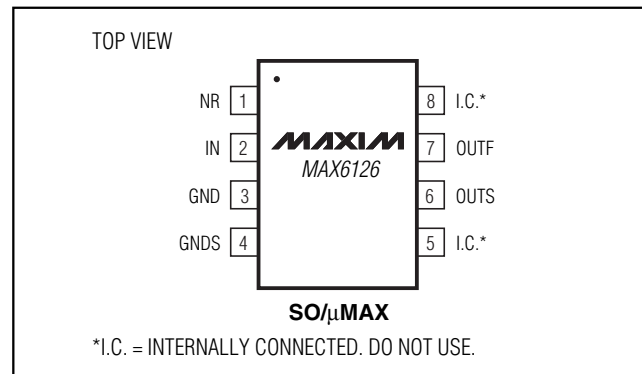

## Ordering Information

PART	TEMP RANGE	PIN-PACKAGE	OUTPUT VOLTAGE (V)	MAXIMUM INITIAL ACCURACY (%)	MAXIMUM TEMPCO ( $-40^\circ\text{C}$ to $+85^\circ\text{C}$ ) (ppm/°C)	TOP MARK
MAX6126AASA21	$-40^\circ\text{C}$ to $+125^\circ\text{C}$	8 SO	2.048	0.02	3	—
MAX6126BASA21	$-40^\circ\text{C}$ to $+125^\circ\text{C}$	8 SO	2.048	0.06	5	—
MAX6126AAUA21	$-40^\circ\text{C}$ to $+125^\circ\text{C}$	8 $\mu\text{MAX}$	2.048	0.06	3	6126A21

Ordering Information continued at end of data sheet.



**For pricing, delivery, and ordering information, please contact Maxim/Dallas Direct! at 1-888-629-4642, or visit Maxim's website at [www.maxim-ic.com](http://www.maxim-ic.com).**

# Ultra-High-Precision, Ultra-Low-Noise, Series Voltage Reference

## ABSOLUTE MAXIMUM RATINGS

(All voltages referenced to GND)

GNDS .....	-0.3V to +0.3V
IN .....	-0.3V to +13V
OUTF, OUTS, NR.....	-0.3V to the lesser of (V <sub>IN</sub> + 0.3V) or +6V
Output Short Circuit to GND or IN .....	.60s
Continuous Power Dissipation (T <sub>A</sub> = +70°C)	
8-Pin $\mu$ MAX (derate 4.5mW/°C above +70°C) .....	362mW
8-Pin SO (derate 5.88mW/°C above +70°C) .....	471mW

Operating Temperature Range .....	-40°C to +125°C
Junction Temperature .....	+150°C
Storage Temperature Range .....	-65°C to +150°C
Lead Temperature (soldering, 10s) .....	+300°C

Stresses beyond those listed under "Absolute Maximum Ratings" may cause permanent damage to the device. These are stress ratings only, and functional operation of the device at these or any other conditions beyond those indicated in the operational sections of the specifications is not implied. Exposure to absolute maximum rating conditions for extended periods may affect device reliability.

## ELECTRICAL CHARACTERISTICS—MAX6126\_21 (V<sub>OUT</sub> = 2.048V)

(V<sub>IN</sub> = 5V, C<sub>LOAD</sub> = 0.1 $\mu$ F, I<sub>OUT</sub> = 0, T<sub>A</sub> = T<sub>MIN</sub> to T<sub>MAX</sub>, unless otherwise noted. Typical values are at T<sub>A</sub> = +25°C.)

PARAMETER	SYMBOL	CONDITIONS	MIN	TYP	MAX	UNITS
<b>OUTPUT</b>						
Output Voltage	V <sub>OUT</sub>	T <sub>A</sub> = +25°C		2.048		V
Output Voltage Accuracy		Referred to V <sub>OUT</sub> , T <sub>A</sub> = +25°C	A grade SO	-0.02	+0.02	%
			B grade SO	-0.06	+0.06	
			A grade $\mu$ MAX	-0.06	+0.06	
			B grade $\mu$ MAX	-0.1	+0.1	
Output Voltage Temperature Coefficient (Note 1)	TCV <sub>OUT</sub>	T <sub>A</sub> = -40°C to +85°C	A grade SO	0.5	3	ppm/°C
			B grade SO	1	5	
			A grade $\mu$ MAX	1	3	
			B grade $\mu$ MAX	2	7	
		T <sub>A</sub> = -40°C to +125°C	A grade SO	1	5	
			B grade SO	2	10	
			A grade $\mu$ MAX	2	5	
			B grade $\mu$ MAX	3	12	
Line Regulation	$\Delta V_{OUT} / \Delta V_{IN}$	2.7V $\leq$ V <sub>IN</sub> $\leq$ 12.6V	T <sub>A</sub> = +25°C	2	20	$\mu$ V/V
			T <sub>A</sub> = -40°C to +125°C			
Load Regulation	$\Delta V_{OUT} / \Delta I_{OUT}$	Sourcing: 0 $\leq$ I <sub>OUT</sub> $\leq$ 10mA		0.7	25	$\mu$ V/mA
		Sinking: -10mA $\leq$ I <sub>OUT</sub> $\leq$ 0		1.3	25	
OUT Short-Circuit Current	I <sub>SC</sub>	Short to GND		160		mA
		Short to IN		20		
Thermal Hysteresis (Note 2)	$\Delta V_{OUT} / \text{cycle}$	SO		25		ppm
		$\mu$ MAX		80		
Long-Term Stability	$\Delta V_{OUT} / \text{time}$	1000hr at T <sub>A</sub> = +25°C	SO		20	ppm/ 1000hr
			$\mu$ MAX		100	

# Ultra-High-Precision, Ultra-Low-Noise, Series Voltage Reference

**MAX6126**

## ELECTRICAL CHARACTERISTICS—MAX6126\_21 (V<sub>OUT</sub> = 2.048V) (continued)

(V<sub>IN</sub> = 5V, C<sub>LOAD</sub> = 0.1μF, I<sub>OUT</sub> = 0, T<sub>A</sub> = T<sub>MIN</sub> to T<sub>MAX</sub>, unless otherwise noted. Typical values are at T<sub>A</sub> = +25°C.)

PARAMETER	SYMBOL	CONDITIONS	MIN	TYP	MAX	UNITS
<b>DYNAMIC CHARACTERISTICS</b>						
Noise Voltage	e <sub>OUT</sub>	f = 0.1Hz to 10Hz		1.3		μV <sub>P-P</sub>
		f = 1kHz, C <sub>NR</sub> = 0		60		nV/√Hz
		f = 1kHz, C <sub>NR</sub> = 0.1μF		35		
Turn-On Settling Time	t <sub>R</sub>	To V <sub>OUT</sub> = 0.01% of final value	C <sub>NR</sub> = 0	0.8		ms
			C <sub>NR</sub> = 0.1μF	20		
Capacitive-Load Stability Range	C <sub>LOAD</sub>	No sustained oscillations		0.1 to 10		μF
<b>INPUT</b>						
Supply Voltage Range	V <sub>IN</sub>	Guaranteed by line-regulation test	2.7		12.6	V
Quiescent Supply Current	I <sub>IN</sub>	T <sub>A</sub> = +25°C		380	550	μA
		T <sub>A</sub> = -40°C to +125°C			725	

## ELECTRICAL CHARACTERISTICS—MAX6126\_25 (V<sub>OUT</sub> = 2.500V)

(V<sub>IN</sub> = 5V, C<sub>LOAD</sub> = 0.1μF, I<sub>OUT</sub> = 0, T<sub>A</sub> = T<sub>MIN</sub> to T<sub>MAX</sub>, unless otherwise noted. Typical values are at T<sub>A</sub> = +25°C.)

PARAMETER	SYMBOL	CONDITIONS	MIN	TYP	MAX	UNITS
<b>OUTPUT</b>						
Output Voltage	V <sub>OUT</sub>	T <sub>A</sub> = +25°C		2.500		V
Output Voltage Accuracy		Referred to V <sub>OUT</sub> , T <sub>A</sub> = +25°C	A grade SO	-0.02	+0.02	%
			B grade SO	-0.06	+0.06	
			A grade μMAX	-0.06	+0.06	
			B grade μMAX	-0.1	+0.1	
Output Voltage Temperature Coefficient (Note 1)	TCV <sub>OUT</sub>	T <sub>A</sub> = -40°C to +85°C	A grade SO	0.5	3	ppm/°C
			B grade SO	1	5	
			A grade μMAX	1	3	
			B grade μMAX	2	7	
		T <sub>A</sub> = -40°C to +125°C	A grade SO	1	5	
			B grade SO	2	10	
			A grade μMAX	2	5	
			B grade μMAX	3	12	
Line Regulation	ΔV <sub>OUT</sub> /ΔV <sub>IN</sub>	2.7V ≤ V <sub>IN</sub> ≤ 12.6V	T <sub>A</sub> = +25°C	3	20	μV/V
			T <sub>A</sub> = -40°C to +125°C		40	
Load Regulation	ΔV <sub>OUT</sub> /ΔI <sub>OUT</sub>	Sourcing: 0 ≤ I <sub>OUT</sub> ≤ 10mA		1	25	μV/mA
		Sinking: -10mA ≤ I <sub>OUT</sub> ≤ 0		1.8	25	

# Ultra-High-Precision, Ultra-Low-Noise, Series Voltage Reference

## ELECTRICAL CHARACTERISTICS—MAX6126\_25 (V<sub>OUT</sub> = 2.500V) (continued)

(V<sub>IN</sub> = 5V, C<sub>LOAD</sub> = 0.1μF, I<sub>OUT</sub> = 0, T<sub>A</sub> = T<sub>MIN</sub> to T<sub>MAX</sub>, unless otherwise noted. Typical values are at T<sub>A</sub> = +25°C.)

PARAMETER	SYMBOL	CONDITIONS		MIN	TYP	MAX	UNITS
Dropout Voltage (Note 3)	V <sub>IN</sub> - V <sub>OUT</sub>	ΔV <sub>OUT</sub> = 0.1%	I <sub>OUT</sub> = 5mA	0.06	0.2	V	
			I <sub>OUT</sub> = 10mA	0.12	0.4		
OUT Short-Circuit Current	I <sub>SC</sub>	Short to GND		160		mA	
		Short to I <sub>N</sub>		20			
Thermal Hysteresis (Note 2)	ΔV <sub>OUT</sub> /cycle	SO		35		ppm	
		μMAX		80			
Long-Term Stability	ΔV <sub>OUT</sub> /time	1000hr at T <sub>A</sub> = +25°C	SO	20		ppm/1000hr	
			μMAX	100			
<b>DYNAMIC CHARACTERISTICS</b>							
Noise Voltage	e <sub>OUT</sub>	f = 0.1Hz to 10Hz		1.45		μV <sub>P-P</sub>	
		f = 1kHz, C <sub>NR</sub> = 0		75			
		f = 1kHz, C <sub>NR</sub> = 0.1μF		45			
Turn-On Settling Time	t <sub>R</sub>	To V <sub>OUT</sub> = 0.01% of final value	C <sub>NR</sub> = 0	1		ms	
			C <sub>NR</sub> = 0.1μF	20			
Capacitive-Load Stability Range	C <sub>LOAD</sub>	No sustained oscillations		0.1 to 10		μF	
<b>INPUT</b>							
Supply Voltage Range	V <sub>IN</sub>	Guaranteed by line-regulation test		2.7	12.6	V	
Quiescent Supply Current	I <sub>IN</sub>	T <sub>A</sub> = +25°C		380	550	μA	
		T <sub>A</sub> = -40°C to +125°C		725			

## ELECTRICAL CHARACTERISTICS—MAX6126\_30 (V<sub>OUT</sub> = 3.000V)

(V<sub>IN</sub> = 5V, C<sub>LOAD</sub> = 0.1μF, I<sub>OUT</sub> = 0, T<sub>A</sub> = T<sub>MIN</sub> to T<sub>MAX</sub>, unless otherwise noted. Typical values are at T<sub>A</sub> = +25°C.)

PARAMETER	SYMBOL	CONDITIONS		MIN	TYP	MAX	UNITS
<b>OUTPUT</b>							
Output Voltage	V <sub>OUT</sub>	T <sub>A</sub> = +25°C		3.000		V	
Output Voltage Accuracy		Referred to V <sub>OUT</sub> , T <sub>A</sub> = +25°C	A grade SO	-0.02	+0.02		%
			B grade SO	-0.06	+0.06		
			A grade μMAX	-0.06	+0.06		
			B grade μMAX	-0.1	+0.1		
Output Voltage Temperature Coefficient (Note 1)	TCV <sub>OUT</sub>	T <sub>A</sub> = -40°C to +85°C	A grade SO	0.5		3	ppm/°C
			B grade SO	1		5	
			A grade μMAX	1		3	
			B grade μMAX	2		7	
		T <sub>A</sub> = -40°C to +125°C	A grade SO	1		5	
			B grade SO	2		10	
			A grade μMAX	2		5	
			B grade μMAX	3		12	

# Ultra-High-Precision, Ultra-Low-Noise, Series Voltage Reference

**MAX6126**

## ELECTRICAL CHARACTERISTICS—MAX6126\_30 (V<sub>OUT</sub> = 3.000V) (continued)

(V<sub>IN</sub> = 5V, C<sub>LOAD</sub> = 0.1μF, I<sub>OUT</sub> = 0, T<sub>A</sub> = T<sub>MIN</sub> to T<sub>MAX</sub>, unless otherwise noted. Typical values are at T<sub>A</sub> = +25°C.)

PARAMETER	SYMBOL	CONDITIONS		MIN	TYP	MAX	UNITS
Line Regulation	$\frac{\Delta V_{OUT}}{\Delta V_{IN}}$	3.2V ≤ V <sub>IN</sub> ≤ 12.6V	T <sub>A</sub> = +25°C		4	25	μV/V
			T <sub>A</sub> = -40°C to +125°C			50	
Load Regulation	$\frac{\Delta V_{OUT}}{\Delta I_{OUT}}$	Sourcing: 0 ≤ I <sub>OUT</sub> ≤ 10mA			1.5	30	μV/mA
		Sinking: -10mA ≤ I <sub>OUT</sub> ≤ 0			2.8	30	
Dropout Voltage (Note 3)	V <sub>IN</sub> - V <sub>OUT</sub>	ΔV <sub>OUT</sub> = 0.1%	I <sub>OUT</sub> = 5mA		0.06	0.2	V
			I <sub>OUT</sub> = 10mA		0.11	0.4	
OUT Short-Circuit Current	I <sub>SC</sub>	Short to GND			160		mA
		Short to IN			20		
Thermal Hysteresis (Note 2)	$\frac{\Delta V_{OUT}}{\text{cycle}}$	SO			20		ppm
		μMAX			80		
Long-Term Stability	$\frac{\Delta V_{OUT}}{\text{time}}$	1000hr at T <sub>A</sub> = +25°C	SO		20		ppm/ 1000hr
			μMAX		100		
<b>DYNAMIC CHARACTERISTICS</b>							
Noise Voltage	e <sub>OUT</sub>	f = 0.1Hz to 10Hz			1.75		μV <sub>P-P</sub>
		f = 1kHz, C <sub>NR</sub> = 0			90		
		f = 1kHz, C <sub>NR</sub> = 0.1μF			55		nV/√Hz
Capacitive-Load Stability Range	C <sub>LOAD</sub>	No sustained oscillations			0.1 to 10		μF
Turn-On Settling Time	t <sub>R</sub>	To V <sub>OUT</sub> = 0.01% of final value	C <sub>NR</sub> = 0		1.2		ms
			C <sub>NR</sub> = 0.1μF		20		
<b>INPUT</b>							
Supply Voltage Range	V <sub>IN</sub>	Guaranteed by line-regulation test		3.2		12.6	V
Quiescent Supply Current	I <sub>IN</sub>	T <sub>A</sub> = +25°C			380	550	μA
		T <sub>A</sub> = -40°C to +125°C				725	

## ELECTRICAL CHARACTERISTICS—MAX6126\_41 (V<sub>OUT</sub> = 4.096V)

(V<sub>IN</sub> = 5V, C<sub>LOAD</sub> = 0.1μF, I<sub>OUT</sub> = 0, T<sub>A</sub> = T<sub>MIN</sub> to T<sub>MAX</sub>, unless otherwise noted. Typical values are at T<sub>A</sub> = +25°C.)

PARAMETER	SYMBOL	CONDITIONS		MIN	TYP	MAX	UNITS
<b>OUTPUT</b>							
Output Voltage	V <sub>OUT</sub>	T <sub>A</sub> = +25°C			4.096		V
Output Voltage Accuracy		Referred to V <sub>OUT</sub> , T <sub>A</sub> = +25°C	A grade SO		-0.02	+0.02	%
			B grade SO		-0.06	+0.06	
			A grade μMAX		-0.06	+0.06	
			B grade μMAX		-0.1	+0.1	

# Ultra-High-Precision, Ultra-Low-Noise, Series Voltage Reference

## ELECTRICAL CHARACTERISTICS—MAX6126\_41 (V<sub>OUT</sub> = 4.096V) (continued)

(V<sub>IN</sub> = 5V, C<sub>LOAD</sub> = 0.1μF, I<sub>OUT</sub> = 0, T<sub>A</sub> = T<sub>MIN</sub> to T<sub>MAX</sub>, unless otherwise noted. Typical values are at T<sub>A</sub> = +25°C.)

PARAMETER	SYMBOL	CONDITIONS		MIN	TYP	MAX	UNITS
Output Voltage Temperature Coefficient (Note 1)	TCV <sub>OUT</sub>	T <sub>A</sub> = -40°C to +85°C	A grade SO	0.5	3	ppm/°C	
			B grade SO	1	5		
			A grade μMAX	1	3		
			B grade μMAX	2	7		
		T <sub>A</sub> = -40°C to +125°C	A grade SO	1	5		
			B grade SO	2	10		
			A grade μMAX	2	5		
			B grade μMAX	3	12		
Line Regulation	ΔV <sub>OUT</sub> /ΔV <sub>IN</sub>	4.3V ≤ V <sub>IN</sub> ≤ 12.6V	T <sub>A</sub> = +25°C	4.5	30	μV/V	
			T <sub>A</sub> = -40°C to +125°C		60		
Load Regulation	ΔV <sub>OUT</sub> /ΔI <sub>OUT</sub>	Sourcing: 0 ≤ I <sub>OUT</sub> ≤ 10mA		2	40	μV/mA	
		Sinking: -10mA ≤ I <sub>OUT</sub> ≤ 0		5	40		
Dropout Voltage (Note 3)	V <sub>IN</sub> - V <sub>OUT</sub>	ΔV <sub>OUT</sub> = 0.1%	I <sub>OUT</sub> = 5mA	0.05	0.2	V	
			I <sub>OUT</sub> = 10mA	0.1	0.4		
OUT Short-Circuit Current	I <sub>SC</sub>	Short to GND		160		mA	
		Short to I <sub>N</sub>		20			
Thermal Hysteresis (Note 2)	ΔV <sub>OUT</sub> /cycle	SO		20		ppm	
		μMAX		80			
Long-Term Stability	ΔV <sub>OUT</sub> /time	1000hr at T <sub>A</sub> = +25°C	SO	20		ppm/1000hr	
			μMAX	100			
<b>DYNAMIC CHARACTERISTICS</b>							
Noise Voltage	e <sub>OUT</sub>	f = 0.1Hz to 10Hz		2.4		μV <sub>P-P</sub>	
		f = 1kHz, C <sub>NR</sub> = 0		120			
		f = 1kHz, C <sub>NR</sub> = 0.1μF		80		nV/√Hz	
Capacitive-Load Stability Range	C <sub>LOAD</sub>	No sustained oscillations		0.1 to 10		μF	
Turn-On Settling Time	t <sub>R</sub>	To V <sub>OUT</sub> = 0.01% of final value	C <sub>NR</sub> = 0	1.6		ms	
			C <sub>NR</sub> = 0.1μF	20			
<b>INPUT</b>							
Supply Voltage Range	V <sub>IN</sub>	Guaranteed by line-regulation test		4.3		12.6	V
Quiescent Supply Current	I <sub>IN</sub>	T <sub>A</sub> = +25°C		380		550	μA
		T <sub>A</sub> = -40°C to +125°C				725	

# Ultra-High-Precision, Ultra-Low-Noise, Series Voltage Reference

**MAX6126**

## ELECTRICAL CHARACTERISTICS—MAX6126\_50 (V<sub>OUT</sub> = 5.000V)

(V<sub>IN</sub> = 5.5V, C<sub>LOAD</sub> = 0.1μF, I<sub>OUT</sub> = 0, T<sub>A</sub> = T<sub>MIN</sub> to T<sub>MAX</sub>, unless otherwise noted. Typical values are at T<sub>A</sub> = +25°C.)

PARAMETER	SYMBOL	CONDITIONS		MIN	TYP	MAX	UNITS
<b>OUTPUT</b>							
Output Voltage	V <sub>OUT</sub>	T <sub>A</sub> = +25°C		5.000			V
Output Voltage Accuracy		T <sub>A</sub> = +25°C	A grade SO	-0.02		+0.02	%
			B grade SO	-0.06		+0.06	
			A grade μMAX	-0.06		+0.06	
			B grade μMAX	-0.1		+0.1	
Output Voltage Temperature Coefficient (Note 1)	TCV <sub>OUT</sub>	T <sub>A</sub> = -40°C to +85°C	A grade SO		0.5	3	ppm/°C
			B grade SO		1	5	
			A grade μMAX		1	3	
			B grade μMAX		2	7	
		T <sub>A</sub> = -40°C to +125°C	A grade SO		1	5	
			B grade SO		2	10	
			A grade μMAX		2	5	
			B grade μMAX		3	12	
Line Regulation	ΔV <sub>OUT</sub> /ΔV <sub>IN</sub>	5.2V ≤ V <sub>IN</sub> ≤ 12.6V	T <sub>A</sub> = +25°C		3	40	μV/V
			T <sub>A</sub> = -40°C to +125°C			80	
Load Regulation	ΔV <sub>OUT</sub> /ΔI <sub>OUT</sub>	Sourcing: 0 ≤ I <sub>OUT</sub> ≤ 10mA			2.5	50	μV/mA
		Sinking: -10mA ≤ I <sub>OUT</sub> ≤ 0			6.5	50	
Dropout Voltage (Note 3)	V <sub>IN</sub> - V <sub>OUT</sub>	ΔV <sub>OUT</sub> = 0.1%	I <sub>OUT</sub> = 5mA		0.05	0.2	V
			I <sub>OUT</sub> = 10mA		0.1	0.4	
OUT Short-Circuit Current	I <sub>SC</sub>	Short to GND			160		mA
		Short to IN			20		
Thermal Hysteresis (Note 2)	ΔV <sub>OUT</sub> /cycle	SO			15		ppm
		μMAX			80		
Long-Term Stability	ΔV <sub>OUT</sub> /time	1000hr at T <sub>A</sub> = +25°C	SO		20		ppm/1000hr
			μMAX		100		
<b>DYNAMIC CHARACTERISTICS</b>							
Noise Voltage	e <sub>OUT</sub>	f = 0.1Hz to 10Hz			2.85		μV <sub>P-P</sub>
		f = 1kHz, CNR = 0			145		nV/√Hz
		f = 1kHz, CNR = 0.1μF			95		
Capacitive-Load Stability Range	C <sub>LOAD</sub>	No sustained oscillations			0.1 to 10		μF

# Ultra-High-Precision, Ultra-Low-Noise, Series Voltage Reference

## ELECTRICAL CHARACTERISTICS—MAX6126\_50 (V<sub>OUT</sub> = 5.000V) (continued)

(V<sub>IN</sub> = 5.5V, C<sub>LOAD</sub> = 0.1μF, I<sub>OUT</sub> = 0, T<sub>A</sub> = T<sub>MIN</sub> to T<sub>MAX</sub>, unless otherwise noted. Typical values are at T<sub>A</sub> = +25°C.)

PARAMETER	SYMBOL	CONDITIONS	MIN	TYP	MAX	UNITS
Turn-On Settling Time	t <sub>R</sub>	To V <sub>OUT</sub> = 0.01% of final value		2		ms
			C <sub>NR</sub> = 0			
				20		
<b>INPUT</b>						
Supply Voltage Range	V <sub>IN</sub>	Guaranteed by line-regulation test	5.2		12.6	V
Quiescent Supply Current	I <sub>IN</sub>	T <sub>A</sub> = +25°C		380	550	μA
		T <sub>A</sub> = -40°C to +125°C			725	

- Note 1:** Temperature coefficient is measured by the “box” method, i.e., the maximum ΔV<sub>OUT</sub> / V<sub>OUT</sub> is divided by the maximum ΔT.  
**Note 2:** Thermal hysteresis is defined as the change in +25°C output voltage before and after cycling the device from T<sub>MAX</sub> to T<sub>MIN</sub>.  
**Note 3:** Dropout voltage is defined as the minimum differential voltage (V<sub>IN</sub> - V<sub>OUT</sub>) at which V<sub>OUT</sub> decreases by 0.1% from its original value at V<sub>IN</sub> = 5.0V (V<sub>IN</sub> = 5.5V for V<sub>OUT</sub> = 5.0V).

## Typical Operating Characteristics

(V<sub>IN</sub> = 5V for MAX6126\_21/25/30/41, V<sub>IN</sub> = 5.5V for MAX6126\_50, C<sub>LOAD</sub> = 0.1μF, I<sub>OUT</sub> = 0, T<sub>A</sub> = +25°C, unless otherwise specified.) (Note 5)

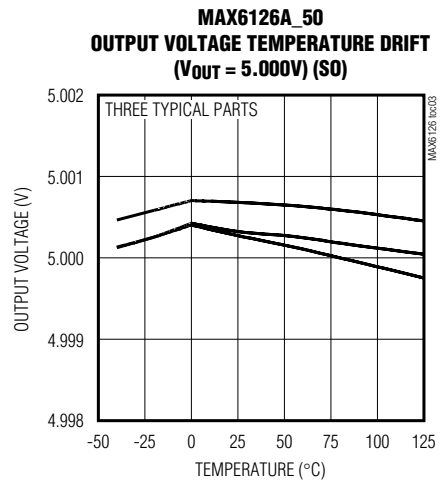
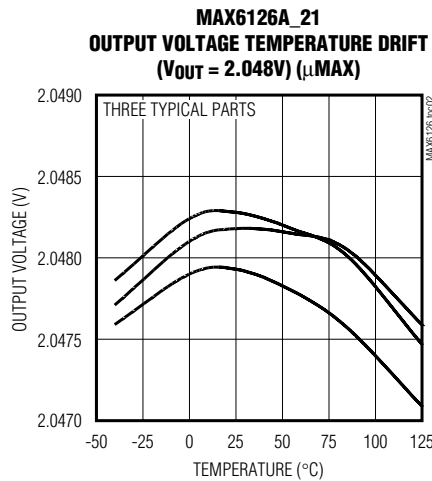
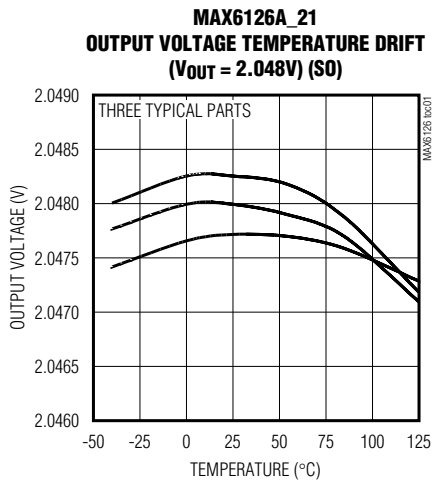



# Ultra-High-Precision, Ultra-Low-Noise, Series Voltage Reference

MAX6126

## Typical Operating Characteristics (continued)

( $V_{IN} = 5V$  for MAX6126\_21/25/30/41,  $V_{IN} = 5.5V$  for MAX6126\_50,  $C_{LOAD} = 0.1\mu F$ ,  $I_{OUT} = 0$ ,  $T_A = +25^\circ C$ , unless otherwise specified.)  
(Note 5)

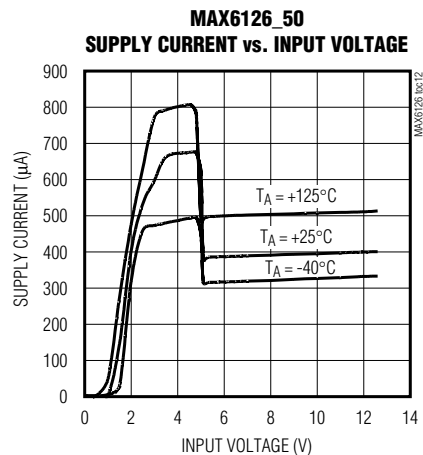
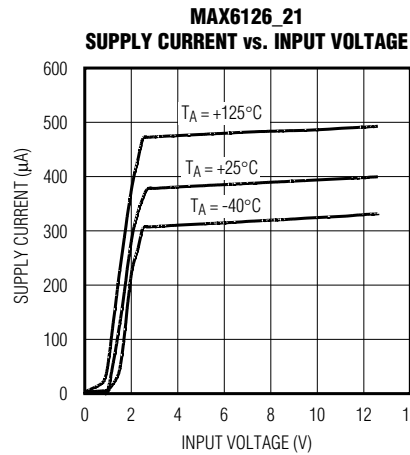
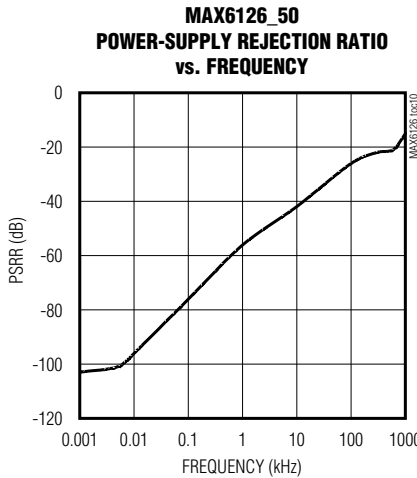
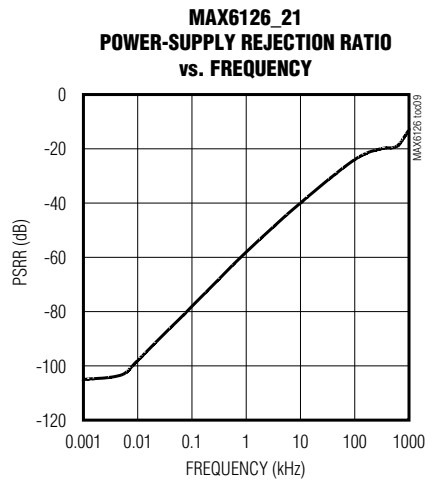
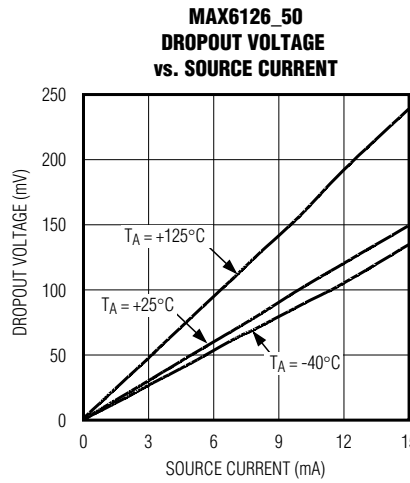
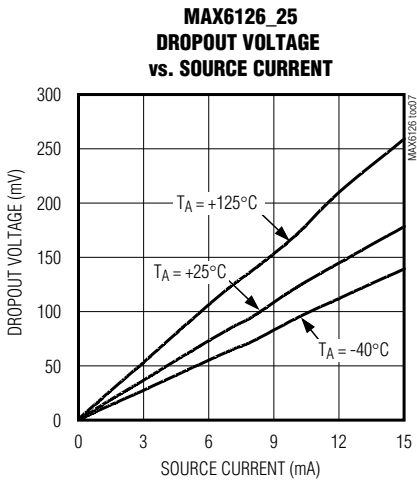
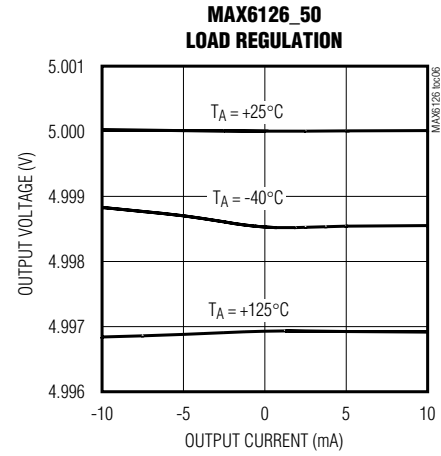
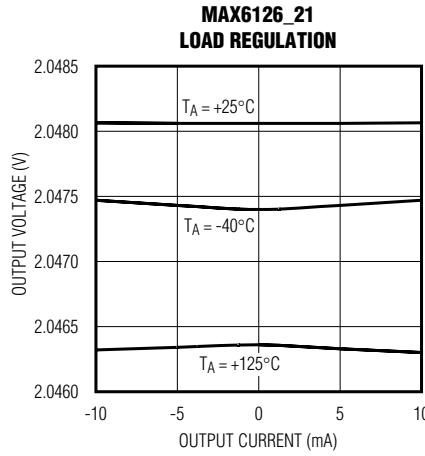
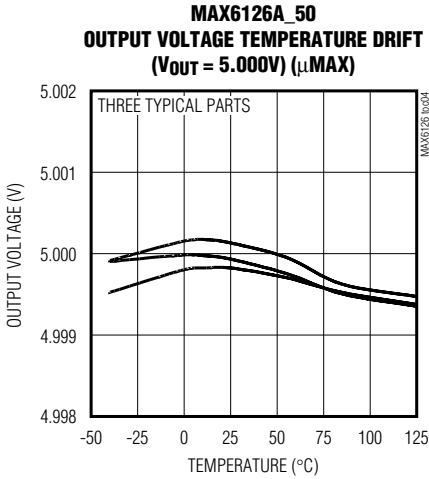

# Ultra-High-Precision, Ultra-Low-Noise, Series Voltage Reference

## Typical Operating Characteristics (continued)

( $V_{IN} = 5V$  for MAX6126\_21/25/30/41,  $V_{IN} = 5.5V$  for MAX6126\_50,  $C_{LOAD} = 0.1\mu F$ ,  $I_{OUT} = 0$ ,  $T_A = +25^\circ C$ , unless otherwise specified.)  
(Note 5)

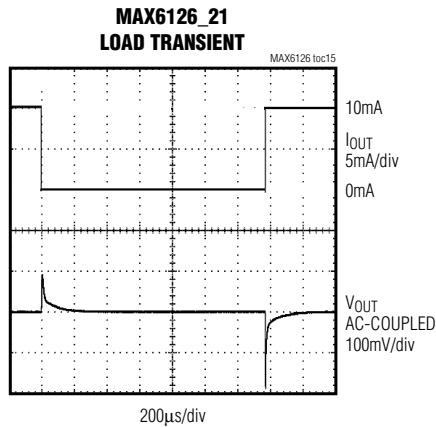
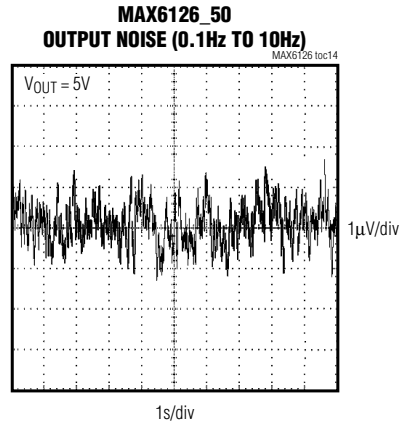
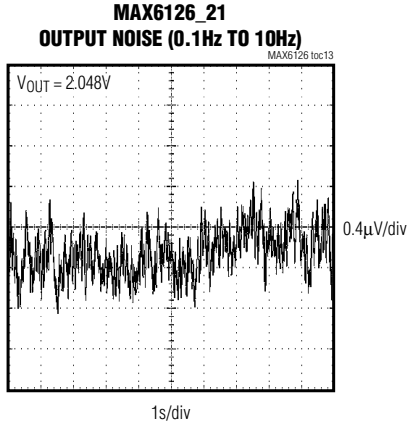

$C_{LOAD} = 0.1\mu F$   $I_{OUT} = 0$  TO 10mA  
 $V_{IN} = 5V$   $V_{OUT} = 2.048V$

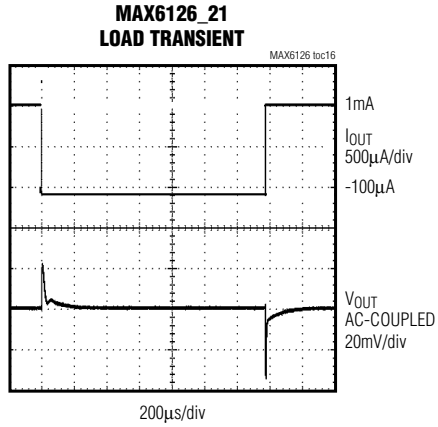

$C_{LOAD} = 0.1\mu F$   $I_{OUT} = -100\mu A$  TO 1mA  
 $V_{IN} = 5V$   $V_{OUT} = 2.048V$

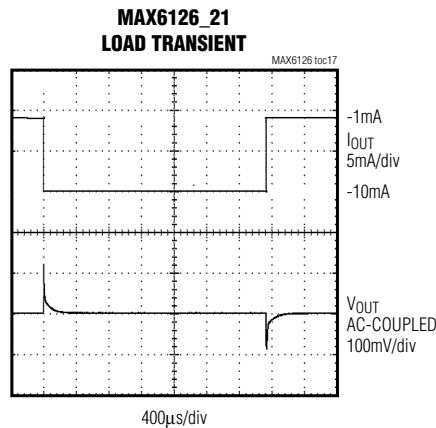

$C_{LOAD} = 0.1\mu F$   $I_{OUT} = -1mA$  TO -10mA  
 $V_{IN} = 5V$   $V_{OUT} = 2.048V$

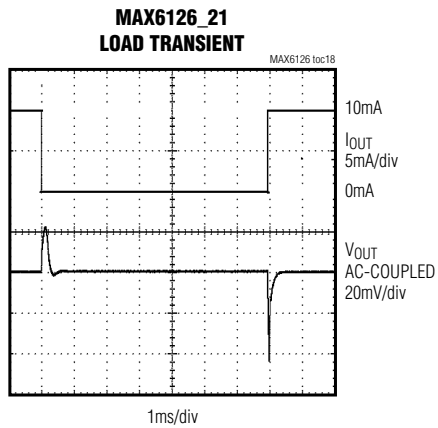

$C_{LOAD} = 10\mu F$   $I_{OUT} = 0$  TO 10mA  
 $V_{IN} = 5V$   $V_{OUT} = 2.048V$

# Ultra-High-Precision, Ultra-Low-Noise, Series Voltage Reference

MAX6126

## Typical Operating Characteristics (continued)

( $V_{IN} = 5V$  for MAX6126\_21/25/30/41,  $V_{IN} = 5.5V$  for MAX6126\_50,  $C_{LOAD} = 0.1\mu F$ ,  $I_{OUT} = 0$ ,  $T_A = +25^\circ C$ , unless otherwise specified.)  
(Note 5)

**MAX6126\_21  
LOAD TRANSIENT**

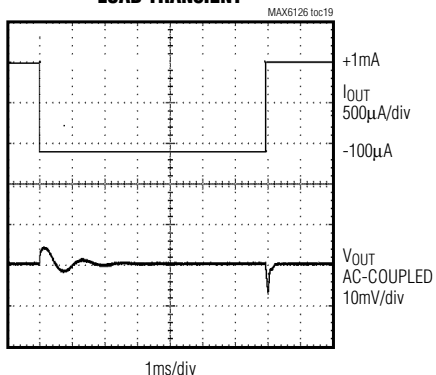

$C_{LOAD} = 10\mu F$   $I_{OUT} = -100\mu A$  TO  $1mA$   
 $V_{IN} = 5V$   $V_{OUT} = 2.048V$

**MAX6126\_21  
LOAD TRANSIENT**

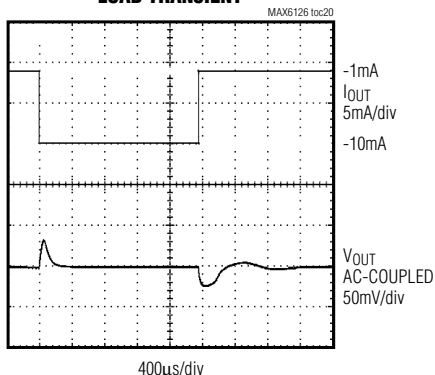

$C_{LOAD} = 10\mu F$   $I_{OUT} = -1mA$  TO  $-10mA$   
 $V_{IN} = 5V$   $V_{OUT} = 2.048V$

**MAX6126\_21  
LINE TRANSIENT**

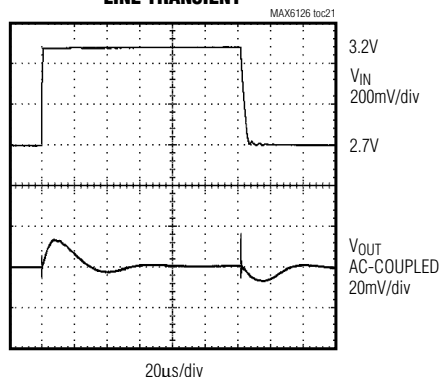

$V_{OUT} = 2.048V$   $C_{LOAD} = 0.1\mu F$

**MAX6126\_50  
LINE TRANSIENT**

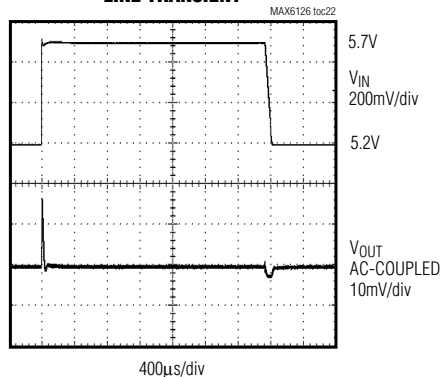

$V_{IN} = 5.2V$  TO  $5.7V$   $C_{LOAD} = 0.1\mu F$   
 $V_{OUT} = 5V$

**MAX6126\_21  
TURN-ON TRANSIENT**

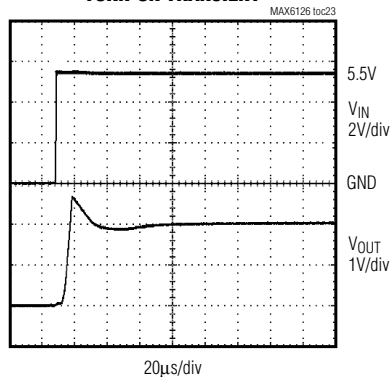

$C_{LOAD} = 0.1\mu F$   
 $V_{OUT} = 2.048V$

**MAX6126\_50  
TURN-ON TRANSIENT**

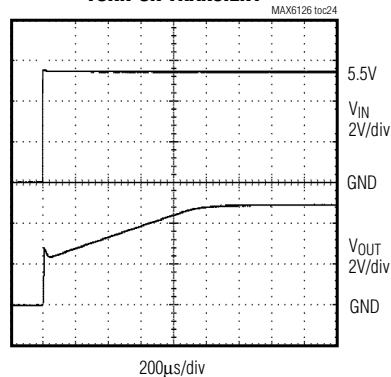

$C_{LOAD} = 0.1\mu F$   
 $V_{OUT} = 5V$

# Ultra-High-Precision, Ultra-Low-Noise, Series Voltage Reference

## Typical Operating Characteristics (continued)

( $V_{IN} = 5V$  for MAX6126\_21/25/30/41,  $V_{IN} = 5.5V$  for MAX6126\_50,  $C_{LOAD} = 0.1\mu F$ ,  $I_{OUT} = 0$ ,  $T_A = +25^\circ C$ , unless otherwise specified.)  
(Note 5)

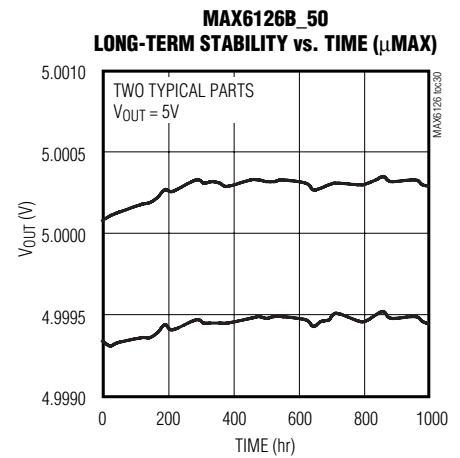
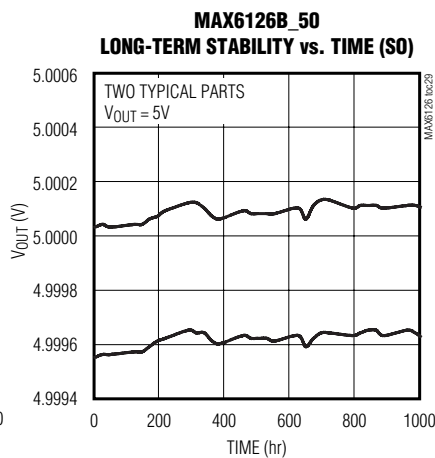
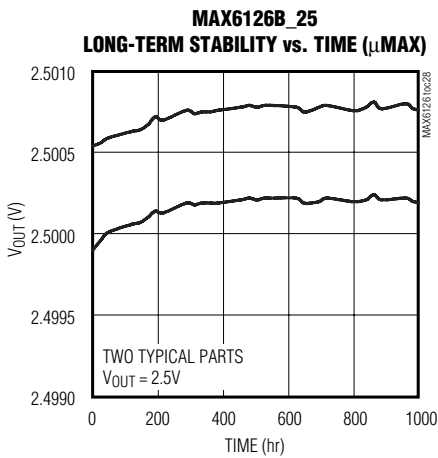
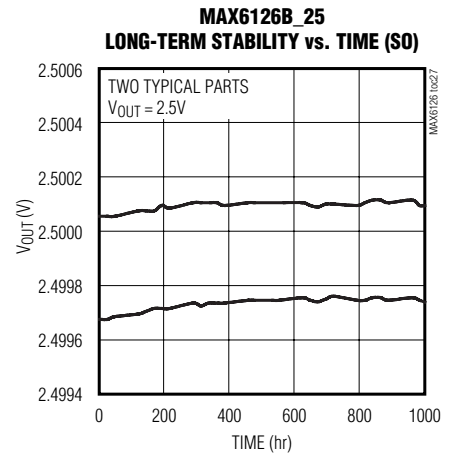
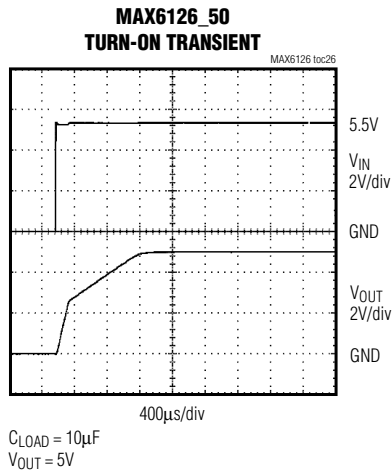
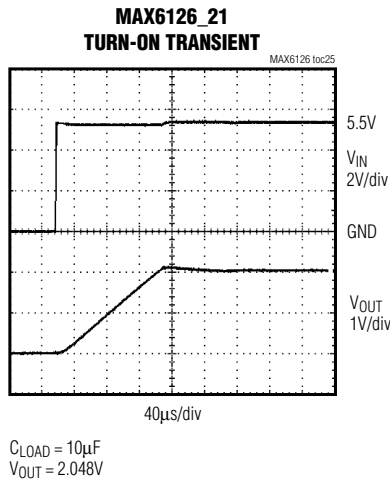

**Note 5:** Many of the MAX6126 *Typical Operating Characteristics* are extremely similar. The extremes of these characteristics are found in the MAX6126\_21 (2.048V output) and the MAX6126\_50 (5.000V output). The *Typical Operating Characteristics* of the remainder of the MAX6126 family typically lie between those two extremes and can be estimated based on their output voltages.

# Ultra-High-Precision, Ultra-Low-Noise, Series Voltage Reference

MAX6126

## Pin Description

PIN	NAME	FUNCTION
1	NR	Noise Reduction. Connect a 0.1μF capacitor to improve wideband noise. Leave unconnected if not used (see Figure 1).
2	IN	Positive Power-Supply Input
3	GND	Ground
4	GNDS	Ground-Sense Connection. Connect to ground connection at load.
5, 8	I.C.	Internally Connected. <b>Do not connect anything to these pins.</b>
6	OUTS	Voltage Reference Sense Output
7	OUTF	Voltage Reference Force Output. Short OUTF to OUTS as close to the load as possible. Bypass OUTF with a capacitor (0.1μF to 10μF) to GND.

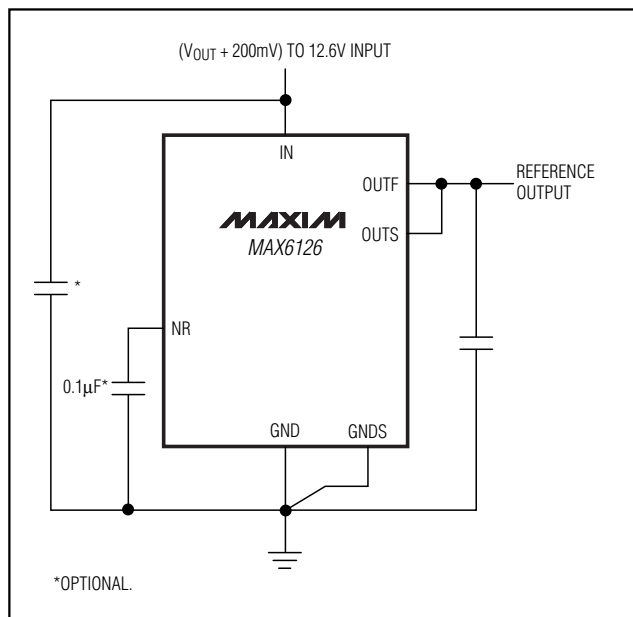

Figure 1. Noise-Reduction Capacitor

## Detailed Description

### Wideband Noise Reduction

To improve wideband noise and transient power-supply noise, add a 0.1μF capacitor to NR (Figure 1). Larger values do not improve noise appreciably. A 0.1μF NR capacitor reduces the noise from 60nV/√Hz to 35nV/√Hz for the 2.048V output. Noise in the power-supply input can affect output noise, but can be reduced by adding an optional bypass capacitor between IN and GND, as shown in the *Typical Operating Circuit*.

### Output Bypassing

The MAX6126 requires an output capacitor between 0.1μF and 10μF. Locate the output capacitor as close to OUTF as possible. For applications driving switching capacitive loads or rapidly changing load currents, it is advantageous to use a 10μF capacitor in parallel with a 0.1μF capacitor. Larger capacitor values reduce transients on the reference output.

### Supply Current

The quiescent supply current of the series-mode MAX6126 family is typically 380μA and is virtually independent of the supply voltage, with only a 2μA/V (max) variation with supply voltage.

When the supply voltage is below the minimum specified input voltage during turn-on, the device can draw

up to 300μA beyond the nominal supply current. The input voltage source must be capable of providing this current to ensure reliable turn-on.

### Thermal Hysteresis

Thermal hysteresis is the change of output voltage at  $T_A = +25^\circ\text{C}$  before and after the device is cycled over its entire operating temperature range. The typical thermal hysteresis value is 20ppm (SO package).

### Turn-On Time

These devices typically turn on and settle to within 0.1% of their final value in 200μs to 2ms depending on the device. The turn-on time can increase up to 4ms with the device operating at the minimum dropout voltage and the maximum load. A noise reduction capacitor of 0.1μF increases the turn-on time to 20ms.

### Output Force and Sense

The MAX6126 provides independent connections for the power-circuit output (OUTF) supplying current into a load, and for the circuit input regulating the voltage applied to that load (OUTS). This configuration allows for the cancellation of the voltage drop on the lines connecting the MAX6126 and the load. When using the Kelvin connection made possible by the independent current and voltage connections, take the power connection to the load from OUTF, and bring a line from OUTS to join the line from OUTF, at the point where the voltage accu-

# Ultra-High-Precision, Ultra-Low-Noise, Series Voltage Reference

racy is needed. The MAX6126 has the same type of Kelvin connection to cancel drops in the ground return line. Connect the load to ground and bring a connection from GNDS to exactly the same point.

## Applications Information

### Precision Current Source

Figure 2 shows a typical circuit providing a precision current source. The OUTF output provides the bias current for the bipolar transistor. OUTS and GNDS sense the voltage across the resistor and adjust the current sourced by OUTF accordingly. For even higher precision, use a MOSFET to eliminate base current errors.

### High-Resolution DAC and Reference from a Single Supply

Figure 3 shows a typical circuit providing the reference for a high-resolution, 16-bit MAX541 D/A converter.

### Temperature Coefficient vs. Operating Temperature Range for a 1 LSB Maximum Error

In a data converter application, the reference voltage of the converter must stay within a certain limit to keep the error in the data converter smaller than the resolution limit through the operating temperature range. Figure 4 shows the maximum allowable reference voltage temperature coefficient to keep the conversion error to less than 1 LSB, as a function of the operating temperature range ( $T_{MAX} - T_{MIN}$ ) with the converter resolution as a parameter. The graph assumes the reference voltage temperature coefficient as the only parameter affecting accuracy.

In reality, the absolute static accuracy of a data converter is dependent on the combination of many parameters such as integral nonlinearity, differential nonlinearity, offset error, gain error, as well as voltage reference changes.

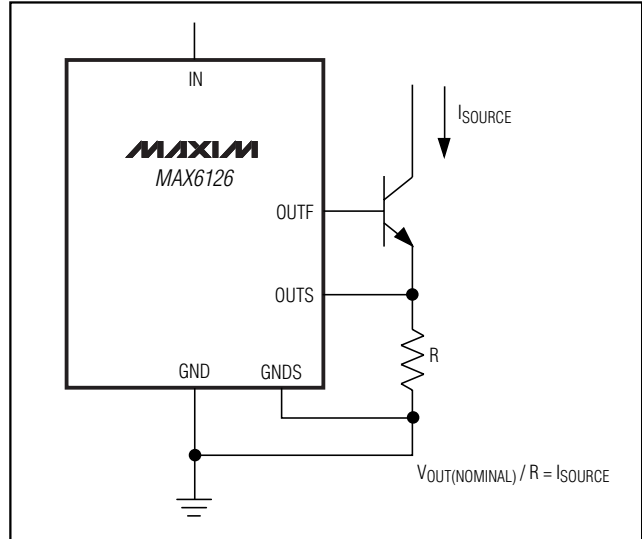

Figure 2. Precision Current Source

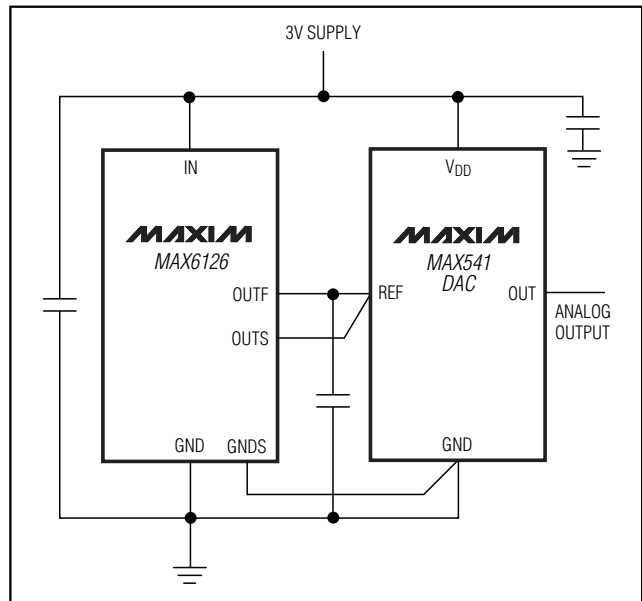

Figure 3. 14-Bit High-Resolution DAC and Positive Reference from a Single 3V Supply

# Ultra-High-Precision, Ultra-Low-Noise, Series Voltage Reference

**MAX6126**

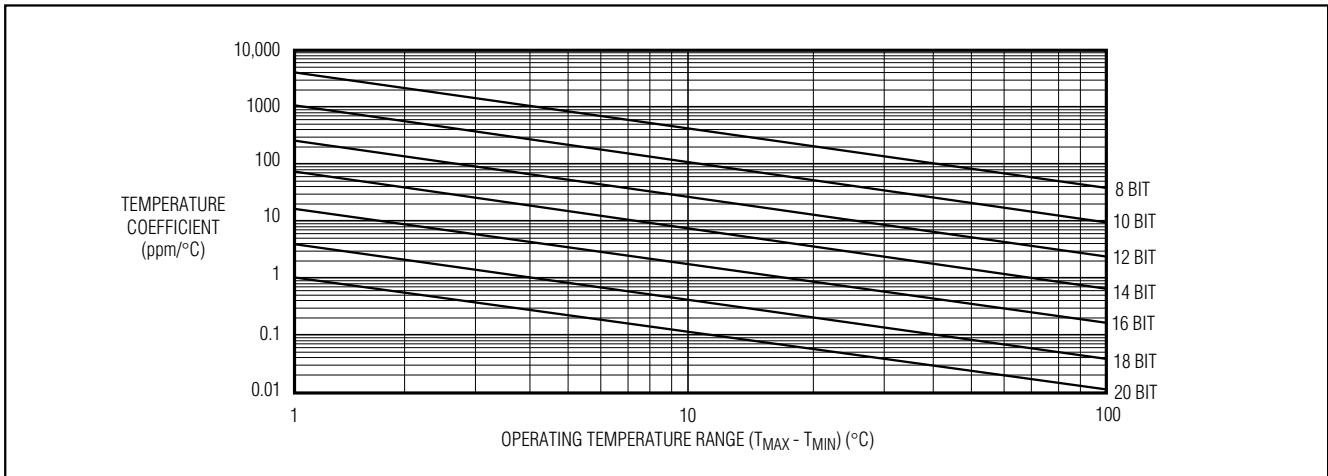
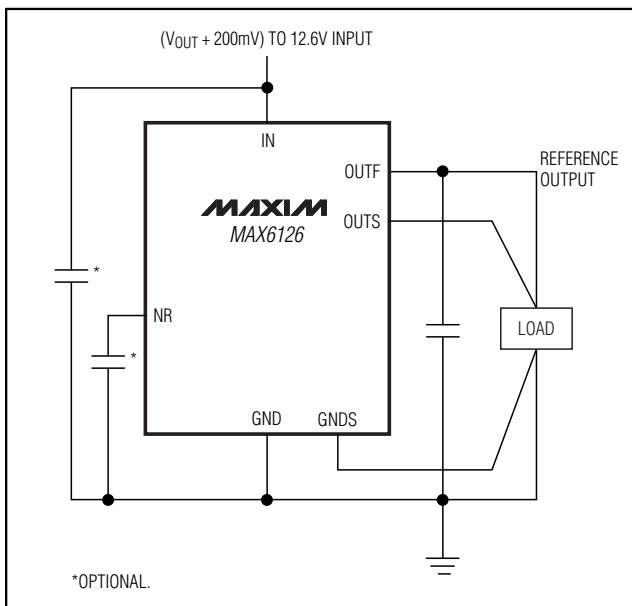

Figure 4. Temperature Coefficient vs. Operating Temperature Range for a 1 LSB Maximum Error

## Typical Operating Circuit



## Chip Information

TRANSISTOR COUNT: 1171  
PROCESS: BiCMOS

# Ultra-High-Precision, Ultra-Low-Noise, Series Voltage Reference

**MAX6126**

## Ordering Information (continued)

PART	TEMP RANGE	PIN-PACKAGE	OUTPUT VOLTAGE (V)	MAXIMUM INITIAL ACCURACY (%)	MAXIMUM TEMPCO (-40°C to +85°C) (ppm/°C)	TOP MARK
MAX6126BAUA21	-40°C to +125°C	8 $\mu$ MAX	2.048	0.1	7	6126B21
MAX6126AASA25	-40°C to +125°C	8 SO	2.500	0.02	3	—
MAX6126BASA25	-40°C to +125°C	8 SO	2.500	0.06	5	—
MAX6126AAUA25	-40°C to +125°C	8 $\mu$ MAX	2.500	0.06	3	6126A25
MAX6126BAUA25	-40°C to +125°C	8 $\mu$ MAX	2.500	0.1	7	6126B25
MAX6126AASA30	-40°C to +125°C	8 SO	3.000	0.02	3	—
MAX6126BASA30	-40°C to +125°C	8 SO	3.000	0.06	5	—
MAX6126AAUA30	-40°C to +125°C	8 $\mu$ MAX	3.000	0.06	3	6126A30
MAX6126BAUA30	-40°C to +125°C	8 $\mu$ MAX	3.000	0.1	7	6126B30
MAX6126AASA41	-40°C to +125°C	8 SO	4.096	0.02	3	—
MAX6126BASA41	-40°C to +125°C	8 SO	4.096	0.06	5	—
MAX6126AAUA41	-40°C to +125°C	8 $\mu$ MAX	4.096	0.06	3	6126A41
MAX6126BAUA41	-40°C to +125°C	8 $\mu$ MAX	4.096	0.1	7	6126B41
MAX6126AASA50	-40°C to +125°C	8 SO	5.000	0.02	3	—
MAX6126BASA50	-40°C to +125°C	8 SO	5.000	0.06	5	—
MAX6126AAUA50	-40°C to +125°C	8 $\mu$ MAX	5.000	0.06	3	6126A50
MAX6126BAUA50	-40°C to +125°C	8 $\mu$ MAX	5.000	0.1	7	6126B50



# Ultra-High-Precision, Ultra-Low-Noise, Series Voltage Reference

## Package Information

(The package drawing(s) in this data sheet may not reflect the most current specifications. For the latest package outline information, go to [www.maxim-ic.com/packages](http://www.maxim-ic.com/packages).

MAX6126

SOICN EPSS

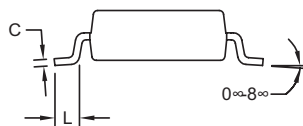
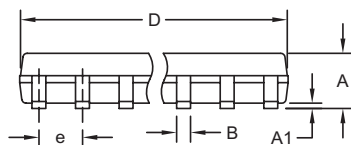
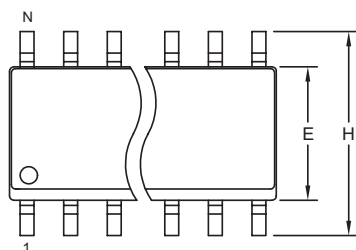

DIM	INCHES		MILLIMETERS	
	MIN	MAX	MIN	MAX
A	0.053	0.069	1.35	1.75
A1	0.004	0.010	0.10	0.25
B	0.014	0.019	0.35	0.49
C	0.007	0.010	0.19	0.25
e	0.050 BSC		1.27 BSC	
E	0.150	0.157	3.80	4.00
H	0.228	0.244	5.80	6.20
L	0.016	0.050	0.40	1.27

### VARIATIONS:

DIM	INCHES		MILLIMETERS		N	MS012
	MIN	MAX	MIN	MAX		
D	0.189	0.197	4.80	5.00	8	AA
D	0.337	0.344	8.55	8.75	14	AB
D	0.386	0.394	9.80	10.00	16	AC

### NOTES:

1. D&E DO NOT INCLUDE MOLD FLASH.
2. MOLD FLASH OR PROTRUSIONS NOT TO EXCEED 0.15mm (.006").
3. LEADS TO BE COPLANAR WITHIN 0.10mm (.004").
4. CONTROLLING DIMENSION: MILLIMETERS.
5. MEETS JEDEC MS012.
6. N = NUMBER OF PINS.

<small>PROPRIETARY INFORMATION</small>	
<small>TITLE:</small> PACKAGE OUTLINE, .150" SOIC	
<small>APPROVAL</small>	<small>DOCUMENT CONTROL NO.</small> 21-0041
<small>REV.</small> B	<small>1/1</small>

# Ultra-High-Precision, Ultra-Low-Noise, Series Voltage Reference

## Package Information (continued)

(The package drawing(s) in this data sheet may not reflect the most current specifications. For the latest package outline information, go to [www.maxim-ic.com/packages](http://www.maxim-ic.com/packages).

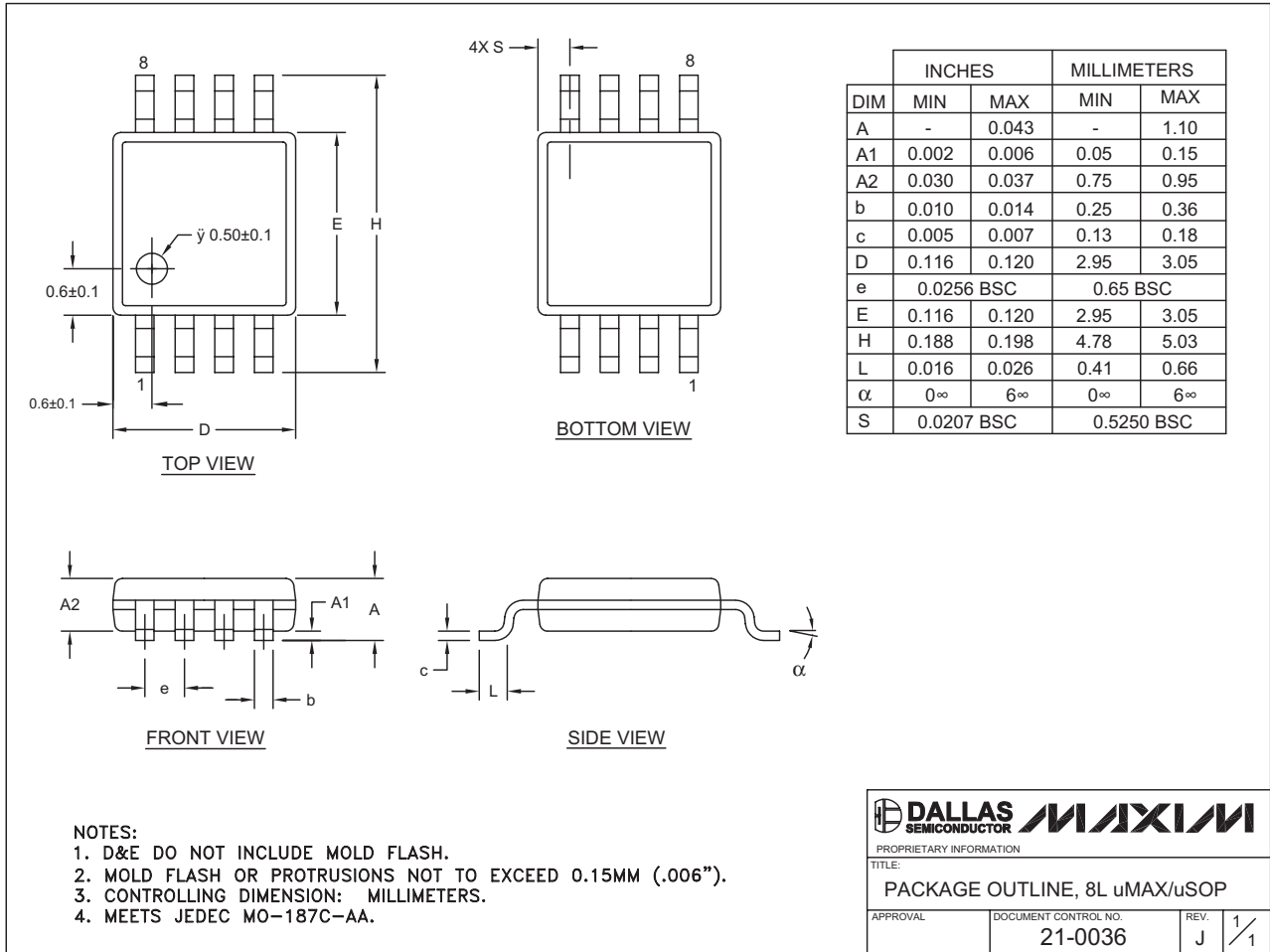

Maxim cannot assume responsibility for use of any circuitry other than circuitry entirely embodied in a Maxim product. No circuit patent licenses are implied. Maxim reserves the right to change the circuitry and specifications without notice at any time.

18 Maxim Integrated Products, 120 San Gabriel Drive, Sunnyvale, CA 94086 408-737-7600