

High Voltage Power Transistors

DPAK For Surface Mount Applications

Designed for line operated audio output amplifier, switchmode power supply drivers and other switching applications.

- Lead Formed for Surface Mount Applications in Plastic Sleeves (No Suffix)
- Straight Lead Version in Plastic Sleeves (“-1” Suffix)
- Lead Formed Version in 16 mm Tape and Reel (“T4” Suffix)
- Electrically Similar to Popular MJE340 and MJE350
- 300 V (Min) — $V_{CEO(sus)}$
- 0.5 A Rated Collector Current

MAXIMUM RATINGS

Rating	Symbol	Value	Unit
Collector–Emitter Voltage	V_{CEO}	300	Vdc
Collector–Base Voltage	V_{CB}	300	Vdc
Emitter–Base Voltage	V_{EB}	3	Vdc
Collector Current — Continuous — Peak	I_C	0.5 0.75	Adc
Total Power Dissipation @ $T_C = 25^\circ\text{C}$ Derate above 25°C	P_D	15 0.12	Watts W/ $^\circ\text{C}$
Total Power Dissipation* @ $T_A = 25^\circ\text{C}$ Derate above 25°C	P_D	1.56 0.012	Watts W/ $^\circ\text{C}$
Operating and Storage Junction Temperature Range	T_J, T_{stg}	-65 to +150	$^\circ\text{C}$

THERMAL CHARACTERISTICS

Characteristic	Symbol	Max	Unit
Thermal Resistance, Junction to Case	$R_{\theta JC}$	8.33	$^\circ\text{C/W}$
Thermal Resistance, Junction to Ambient*	$R_{\theta JA}$	80	$^\circ\text{C/W}$
Lead Temperature for Soldering Purpose	T_L	260	$^\circ\text{C}$

ELECTRICAL CHARACTERISTICS ($T_C = 25^\circ\text{C}$ unless otherwise noted)

Characteristic	Symbol	Min	Max	Unit
----------------	--------	-----	-----	------

OFF CHARACTERISTICS

Collector–Emitter Sustaining Voltage (1) ($I_C = 1 \text{ mAdc}, I_B = 0$)	$V_{CEO(sus)}$	300	—	Vdc
Collector Cutoff Current ($V_{CB} = 300 \text{ Vdc}, I_E = 0$)	I_{CBO}	—	0.1	mAdc
Emitter Cutoff Current ($V_{BE} = 3 \text{ Vdc}, I_C = 0$)	I_{EBO}	—	0.1	mAdc

ON CHARACTERISTICS (1)

DC Current Gain ($I_C = 50 \text{ mAdc}, V_{CE} = 10 \text{ Vdc}$)	h_{FE}	30	240	—
--	----------	----	-----	---

*When surface mounted on minimum pad sizes recommended.

(1) Pulse Test: Pulse Width $\leq 300 \mu\text{s}$, Duty Cycle $\leq 2\%$.

Preferred devices are ON Semiconductor recommended choices for future use and best overall value.

NPN
MJD340*
PNP
MJD350*

*ON Semiconductor Preferred Device

SILICON
POWER TRANSISTORS
0.5 AMPERE
300 VOLTS
15 WATTS



CASE 369A-13

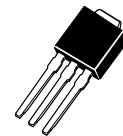

CASE 369-07

MINIMUM PAD SIZES RECOMMENDED FOR SURFACE MOUNTED APPLICATIONS

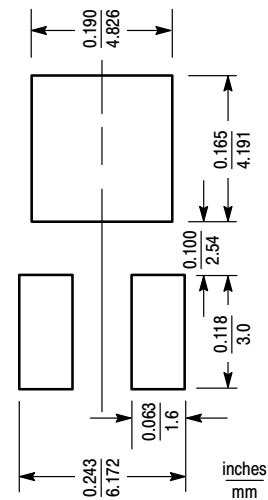

MJD340 MJD350

TYPICAL CHARACTERISTICS

MJD340

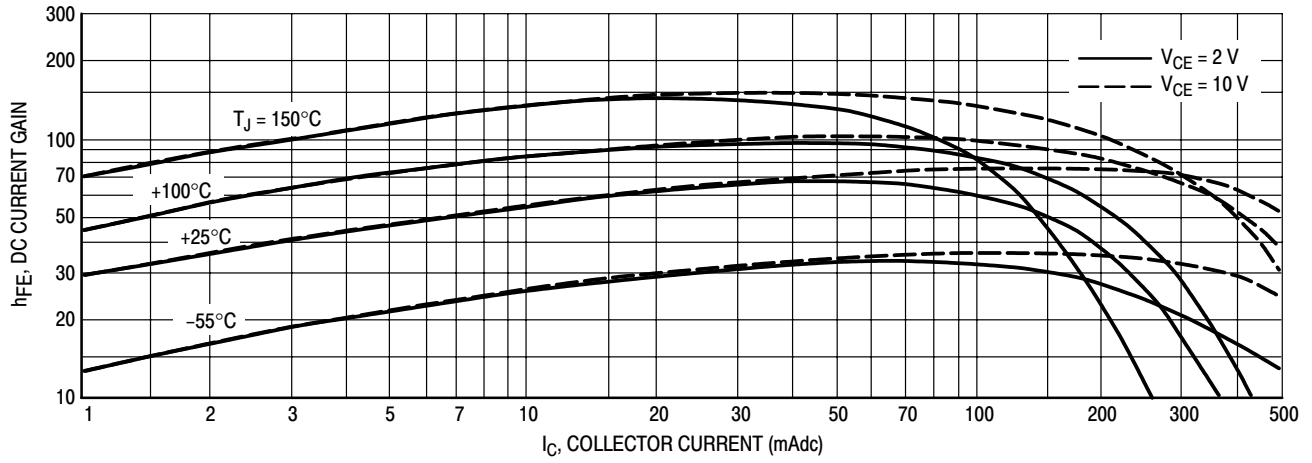

Figure 1. DC Current Gain

MJD340

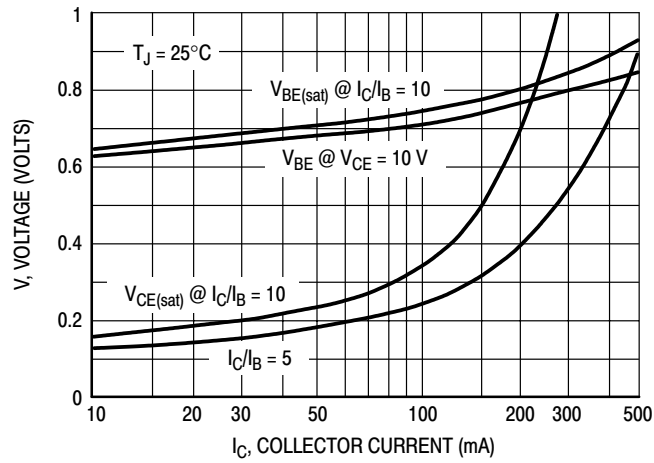

Figure 2. "On" Voltages

MJD340 MJD350

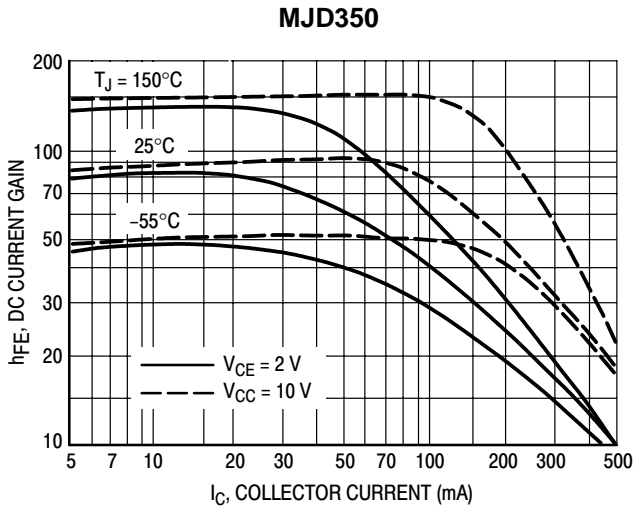

Figure 3. DC Current Gain

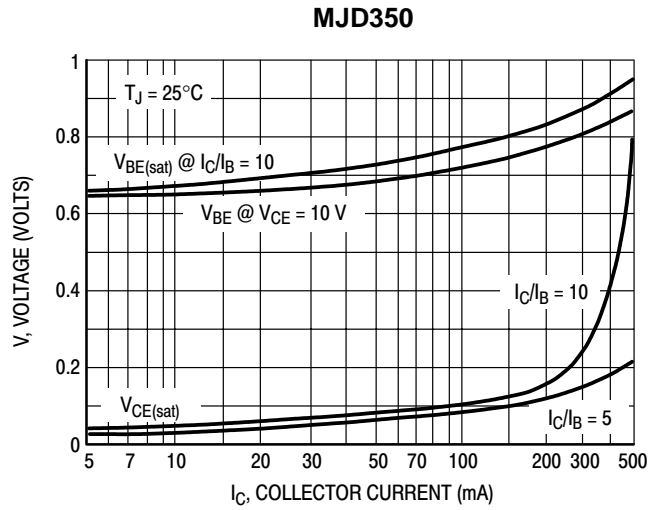

Figure 4. "On" Voltages

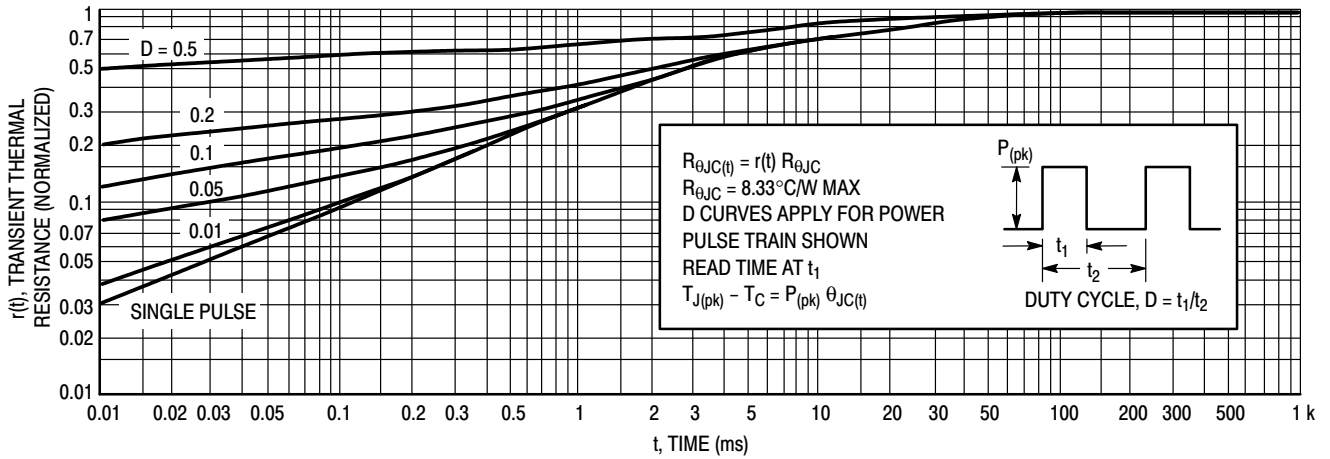

Figure 5. Thermal Response

MJD340 MJD350

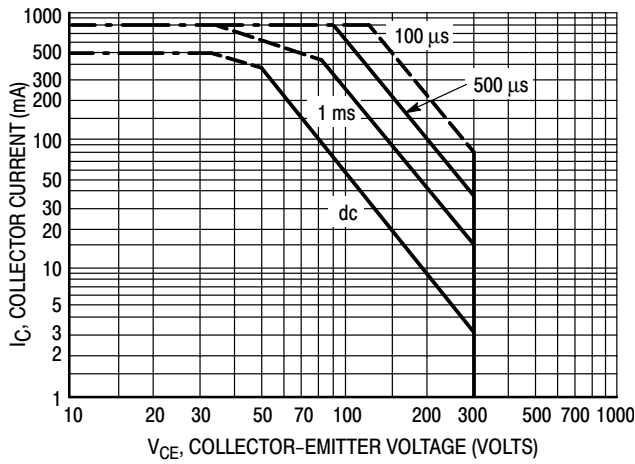

Figure 6. Active Region Safe Operating Area

There are two limitations on the power handling ability of a transistor: average junction temperature and second breakdown. Safe operating area curves indicate $I_C - V_{CE}$ limits of the transistor that must be observed for reliable operation; i.e., the transistor must not be subjected to greater dissipation than the curves indicate.

The data of Figure 6 is based on $T_{J(pk)} = 150^\circ\text{C}$; T_C is variable depending on conditions. Second breakdown pulse limits are valid for duty cycles to 10% provided $T_{J(pk)} \leq 150^\circ\text{C}$. $T_{J(pk)}$ may be calculated from the data in Figure 5. At high case temperatures, thermal limitations will reduce the power that can be handled to values less than the limitations imposed by second breakdown.

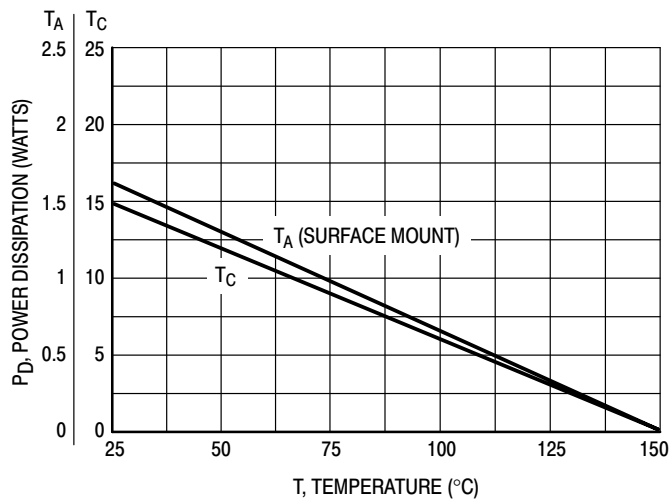
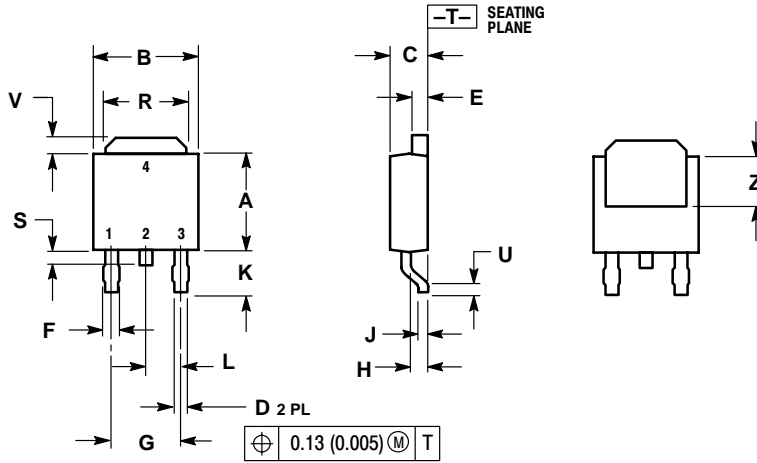

Figure 7. Power Derating

MJD340 MJD350

PACKAGE DIMENSIONS

DPAK CASE 369A-13 ISSUE AA



- NOTES:
 1. DIMENSIONING AND TOLERANCING PER ANSI Y14.5M, 1982.
 2. CONTROLLING DIMENSION: INCH.

DIM	INCHES		MILLIMETERS	
	MIN	MAX	MIN	MAX
A	0.235	0.250	5.97	6.35
B	0.250	0.265	6.35	6.73
C	0.086	0.094	2.19	2.38
D	0.027	0.035	0.69	0.88
E	0.033	0.040	0.84	1.01
F	0.037	0.047	0.94	1.19
G	0.180 BSC		4.58 BSC	
H	0.034	0.040	0.87	1.01
J	0.018	0.023	0.46	0.58
K	0.102	0.114	2.60	2.89
L	0.090 BSC		2.29 BSC	
R	0.175	0.215	4.45	5.46
S	0.020	0.050	0.51	1.27
U	0.020	---	0.51	---
V	0.030	0.050	0.77	1.27
Z	0.138	---	3.51	---

MJD340 MJD350

PACKAGE DIMENSIONS

DPAK CASE 369-07 ISSUE M

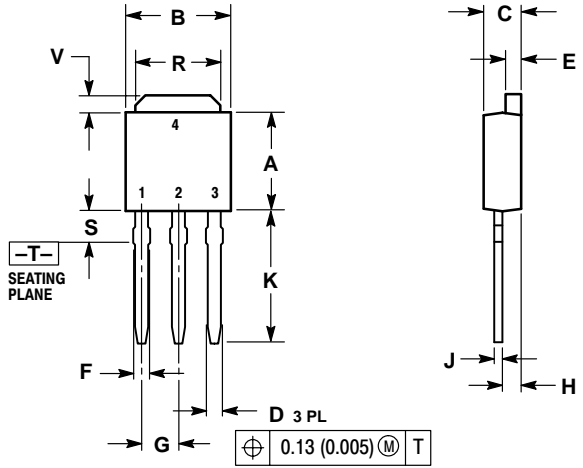

NOTES:

1. DIMENSIONING AND TOLERANCING PER ANSI Y14.5M, 1982.
2. CONTROLLING DIMENSION: INCH.

DIM	INCHES		MILLIMETERS	
	MIN	MAX	MIN	MAX
A	0.235	0.250	5.97	6.35
B	0.250	0.265	6.35	6.73
C	0.086	0.094	2.19	2.38
D	0.027	0.035	0.69	0.88
E	0.033	0.040	0.84	1.01
F	0.037	0.047	0.94	1.19
G	0.090 BSC		2.29 BSC	
H	0.034	0.040	0.87	1.01
J	0.018	0.023	0.46	0.58
K	0.350	0.380	8.89	9.65
R	0.175	0.215	4.45	5.46
S	0.050	0.090	1.27	2.28
V	0.030	0.050	0.77	1.27

Notes

ON Semiconductor and  are trademarks of Semiconductor Components Industries, LLC (SCILLC). SCILLC reserves the right to make changes without further notice to any products herein. SCILLC makes no warranty, representation or guarantee regarding the suitability of its products for any particular purpose, nor does SCILLC assume any liability arising out of the application or use of any product or circuit, and specifically disclaims any and all liability, including without limitation special, consequential or incidental damages. "Typical" parameters which may be provided in SCILLC data sheets and/or specifications can and do vary in different applications and actual performance may vary over time. All operating parameters, including "Typicals" must be validated for each customer application by customer's technical experts. SCILLC does not convey any license under its patent rights nor the rights of others. SCILLC products are not designed, intended, or authorized for use as components in systems intended for surgical implant into the body, or other applications intended to support or sustain life, or for any other application in which the failure of the SCILLC product could create a situation where personal injury or death may occur. Should Buyer purchase or use SCILLC products for any such unintended or unauthorized application, Buyer shall indemnify and hold SCILLC and its officers, employees, subsidiaries, affiliates, and distributors harmless against all claims, costs, damages, and expenses, and reasonable attorney fees arising out of, directly or indirectly, any claim of personal injury or death associated with such unintended or unauthorized use, even if such claim alleges that SCILLC was negligent regarding the design or manufacture of the part. SCILLC is an Equal Opportunity/Affirmative Action Employer.

PUBLICATION ORDERING INFORMATION

Literature Fulfillment:

Literature Distribution Center for ON Semiconductor
P.O. Box 5163, Denver, Colorado 80217 USA
Phone: 303-675-2175 or 800-344-3860 Toll Free USA/Canada
Fax: 303-675-2176 or 800-344-3867 Toll Free USA/Canada
Email: ONlit@hibbertco.com

N. American Technical Support: 800-282-9855 Toll Free USA/Canada

JAPAN: ON Semiconductor, Japan Customer Focus Center
4-32-1 Nishi-Gotanda, Shinagawa-ku, Tokyo, Japan 141-0031
Phone: 81-3-5740-2700
Email: r14525@onsemi.com

ON Semiconductor Website: <http://onsemi.com>

For additional information, please contact your local Sales Representative.