

# Advanced Information

## Proximity Capacitive Touch Sensor Controller

### MPR121 OVERVIEW

The MPR121 is the second generation sensor controller after the initial release of the MPR03x series devices. The MPR121 will feature increased internal intelligence in addition to Freescale's second generation capacitance detection engine. Some of the major additions include an increased electrode count, a hardware configurable I<sup>2</sup>C address, an expanded filtering system with debounce, and completely independent electrodes with auto-configuration built in. The device also features a 13<sup>th</sup> simulated electrode that represents the simultaneous charging of all the electrodes connected together to allow for increased proximity detection in a touch panel or touch screen array.

### Features

- 1.71 V to 3.6 V operation
- 29  $\mu$ A supply current at 16 ms sample period
- 3  $\mu$ A shutdown current
- 12 electrodes
- Continuous independent auto-calibration for each electrode input
- Separate touch and release trip thresholds for each electrode, providing hysteresis and electrode independence
- I<sup>2</sup>C interface, with  $\overline{\text{IRQ}}$  output to advise electrode status changes
- 3 mm x 3 mm x 0.65 mm 20 lead QFN package
- LED driver functionality with 8 shared LEDs
- -40°C to +85°C operating temperature range

### Implementations

- Switch Replacements
- Touch Pads

### Typical Applications

- PC Peripherals
- MP3 Players
- Remote Controls
- Mobile Phones
- Lighting Controls

**MPR121**

**Capacitive Touch Sensor Controller**

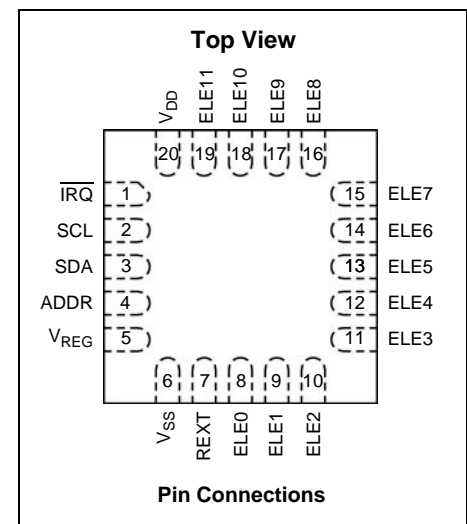
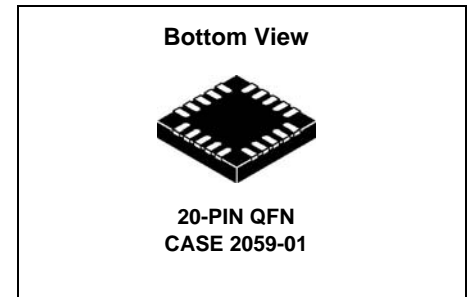

| ORDERING INFORMATION |                   |                   |            |             |             |
|----------------------|-------------------|-------------------|------------|-------------|-------------|
| Device Name          | Temperature Range | Case Number       | Touch Pads | IRC Address | Shipping    |
| MPR121QR2            | -40°C to +85°C    | 2059 (20-Pin QFN) | 12-pads    | 0x5A - 0x5D | Tape & Reel |

This document contains a product under development. Freescale Semiconductor reserves the right to change or discontinue this product without notice.

## PIN DESCRIPTION

| Pin Description |                         |                                   |
|-----------------|-------------------------|-----------------------------------|
| Pin No.         | Pin Name                | Description                       |
| 1               | $\overline{\text{IRQ}}$ | Open Collector Interrupt pin      |
| 2               | SCL                     | I <sup>2</sup> C Clock            |
| 3               | SDA                     | I <sup>2</sup> C Data             |
| 4               | ADDR                    | I <sup>2</sup> C Address Select   |
| 5               | VREG                    | VREG – 0.1 $\mu$ F cap connect    |
| 6               | VSS                     | Ground                            |
| 7               | REXT                    | External Resistor – 75 k $\Omega$ |
| 8               | ELE0                    | Electrode 0                       |
| 9               | ELE1                    | Electrode 1                       |
| 10              | ELE2                    | Electrode 2                       |
| 11              | ELE3                    | Electrode 3                       |
| 12              | ELE4<br>(LED0)          | Electrode 4                       |
| 13              | ELE5<br>(LED1)          | Electrode 5                       |
| 14              | ELE6<br>(LED2)          | Electrode 6                       |
| 15              | ELE7<br>(LED3)          | Electrode 7                       |
| 16              | ELE8<br>(LED4)          | Electrode 8                       |
| 17              | ELE9<br>(LED5)          | Electrode 9                       |
| 18              | ELE10<br>(LED6)         | Electrode 10                      |
| 19              | ELE11<br>(LED7)         | Electrode 11                      |
| 20              | VDD                     | VDD                               |

## SCHEMATIC DRAWINGS AND IMPLEMENTATION

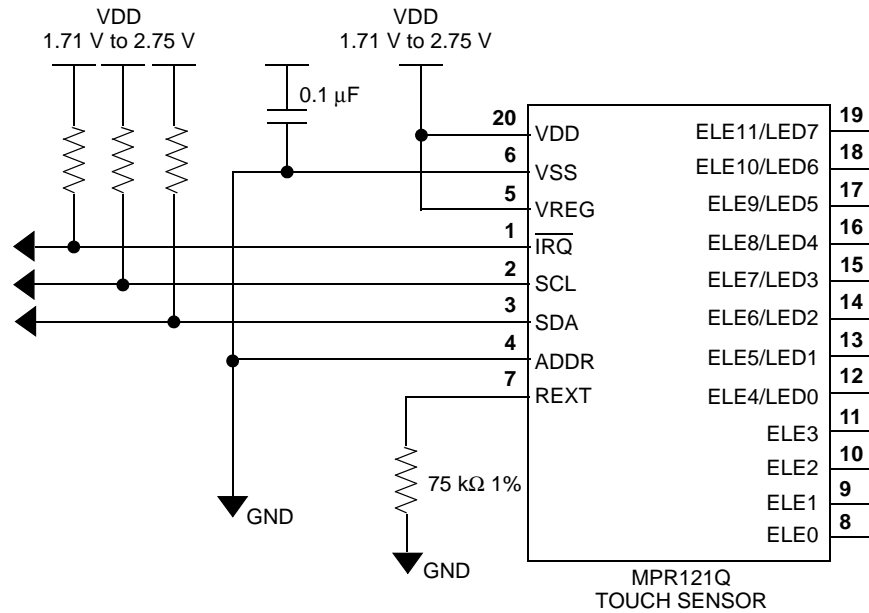

Figure 1. Configuration 1: MPR121 runs from a 1.71 V to 2.75 V supply.

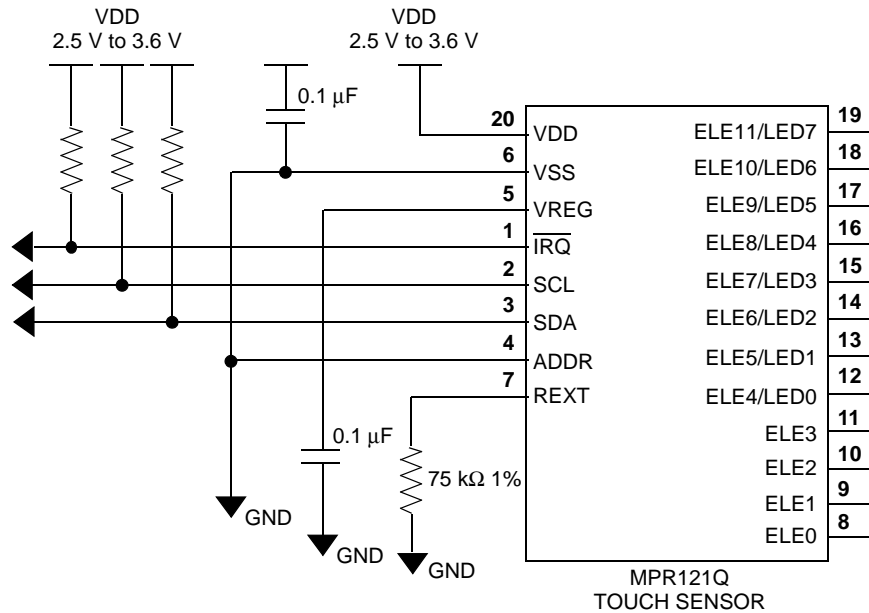

Figure 2. Configuration 2: MPR121 runs from a 2.5 V to 3.6 V supply.

### Capacitance Sensing

The MPR121 uses a constant current touch sensor system with two primary types of control. It can measure capacitances ranging from 10 pF to 2000 pF by varying the current and the amount of time supplied to each electrode. The electrodes are controlled independently allowing for a great deal of flexibility in electrode pattern design. To make setup of the device easier, an automatic configuration system can be used to set the ideal capacitance of each electrode. For information on how to set up this system refer to application note AN3889.

Once capacitance is calculated, it runs through a couple of levels of digital filtering allowing for good noise immunity in different environments without sacrificing response time or power consumption. The MPR121 can be configured for sample rates between 1 ms and 128 ms. For information on how to set up this system refer to application note AN3890.

## Touch Sensing

Once the capacitance is determined at any given moment, this information must then be translated into intelligent touch recognition. The MPR121 has a couple of systems that have improved over the previous generation in the MPR03x series devices. A baseline tracking system allows the system to track the untouched capacitance in the system. For information on how to set up the baseline capacitance system refer to application note AN3891. The baseline value is then compared with the current value to determine if a touch has occurred. A designer has the ability to set both the rising and falling thresholds in addition to a debounce to eliminate jitter and false touches due to noise. These elements are described in application note AN3892.

## Proximity Sensing

A new feature of the MPR121 is the use of a proximity sensing system whereby all of a system's electrodes can be shorted together internally and create a single large electrode. The capacitance of this electrode is larger and projected capacitance can be measured. When enabled, this "13<sup>th</sup>" electrode will be included at the end of a normal detection cycle and will have its own independent set of configuration registers. This system is described in application note AN3893.

## LED Driver

The MPR121 includes eight shared LED driving pins. When these pins are not configured as electrodes, they may be used to drive LEDs. The system allows for both pull up and pull down LED configurations as well as general GPIO push/pull functionality. The configuration of the LED driver system is described in application note AN3894.

## Serial Communication

The MPR121 is an Inter-Integrated Circuit (I<sup>2</sup>C) compliant device with an additional interrupt that is triggered any time a touch or release of a button is detected. The device has a configurable I<sup>2</sup>C address by connecting the ADDR pin to the VSS, VDD, SDA or SCL lines. The resulting I<sup>2</sup>C addresses are 0x5A, 0x5B, 0x5C and 0x5D respectively. The specific details of this system are described in AN3895. For reference the register map of the MPR121 is included in [Table 1](#).

**Table 1. Register Map**

| REGISTER                            | Fields    |      |      |         |       |       |      |           | Register Address | Initial Value | Auto Increment Address |
|-------------------------------------|-----------|------|------|---------|-------|-------|------|-----------|------------------|---------------|------------------------|
| ELE0 - ELE7 Touch Status            | ELE7      | ELE6 | ELE5 | ELE4    | ELE3  | ELE2  | ELE1 | ELE0      | 0x00             | 0x00          | Register Address + 1   |
| ELE8 - ELE11, ELEPROX Touch Status  | OVCF      |      |      | ELEPROX | ELE11 | ELE10 | ELE9 | ELE8      | 0x01             | 0x00          |                        |
| ELE0-7 OOR Status                   | ELE7      | ELE6 | ELE5 | ELE4    | ELE3  | ELE2  | ELE1 | ELE0      | 0x02             | 0x00          |                        |
| ELE8-11, ELEPROX OOR Status         | ARFF      | ACFF |      | ELEPROX | ELE11 | ELE10 | ELE9 | ELE8      | 0x03             | 0x00          |                        |
| ELE0 Electrode Filtered Data LSB    | EFD0LB    |      |      |         |       |       |      |           | 0x04             | 0x00          |                        |
| ELE0 Electrode Filtered Data MSB    |           |      |      |         |       |       |      | EFD0HB    | 0x05             | 0x00          |                        |
| ELE1 Electrode Filtered Data LSB    | EFD1LB    |      |      |         |       |       |      |           | 0x06             | 0x00          |                        |
| ELE1 Electrode Filtered Data MSB    |           |      |      |         |       |       |      | EFD1HB    | 0x07             | 0x00          |                        |
| ELE2 Electrode Filtered Data LSB    | EFD2LB    |      |      |         |       |       |      |           | 0x08             | 0x00          |                        |
| ELE2 Electrode Filtered Data MSB    |           |      |      |         |       |       |      | EFD2HB    | 0x09             | 0x00          |                        |
| ELE3 Electrode Filtered Data LSB    | EFD3LB    |      |      |         |       |       |      |           | 0x0A             | 0x00          |                        |
| ELE3 Electrode Filtered Data MSB    |           |      |      |         |       |       |      | EFD3HB    | 0x0B             | 0x00          |                        |
| ELE4 Electrode Filtered Data LSB    | EFD4LB    |      |      |         |       |       |      |           | 0x0C             | 0x00          |                        |
| ELE4 Electrode Filtered Data MSB    |           |      |      |         |       |       |      | EFD4HB    | 0x0D             | 0x00          |                        |
| ELE5 Electrode Filtered Data LSB    | EFD5LB    |      |      |         |       |       |      |           | 0x0E             | 0x00          |                        |
| ELE5 Electrode Filtered Data MSB    |           |      |      |         |       |       |      | EFD5HB    | 0x0F             | 0x00          |                        |
| ELE6 Electrode Filtered Data LSB    | EFD6LB    |      |      |         |       |       |      |           | 0x10             | 0x00          |                        |
| ELE6 Electrode Filtered Data MSB    |           |      |      |         |       |       |      | EFD6HB    | 0x11             | 0x00          |                        |
| ELE7 Electrode Filtered Data LSB    | EFD7LB    |      |      |         |       |       |      |           | 0x12             | 0x00          |                        |
| ELE7 Electrode Filtered Data MSB    |           |      |      |         |       |       |      | EFD7HB    | 0x13             | 0x00          |                        |
| ELE8 Electrode Filtered Data LSB    | EFD8LB    |      |      |         |       |       |      |           | 0x14             | 0x00          |                        |
| ELE8 Electrode Filtered Data MSB    |           |      |      |         |       |       |      | EFD8HB    | 0x15             | 0x00          |                        |
| ELE9 Electrode Filtered Data LSB    | EFD9LB    |      |      |         |       |       |      |           | 0x16             | 0x00          |                        |
| ELE9 Electrode Filtered Data MSB    |           |      |      |         |       |       |      | EFD9HB    | 0x17             | 0x00          |                        |
| ELE10 Electrode Filtered Data LSB   | EFD10LB   |      |      |         |       |       |      |           | 0x18             | 0x00          |                        |
| ELE10 Electrode Filtered Data MSB   |           |      |      |         |       |       |      | EFD10HB   | 0x19             | 0x00          |                        |
| ELE11 Electrode Filtered Data LSB   | EFD11LB   |      |      |         |       |       |      |           | 0x1A             | 0x00          |                        |
| ELE11 Electrode Filtered Data MSB   |           |      |      |         |       |       |      | EFD11HB   | 0x1B             | 0x00          |                        |
| ELEPROX Electrode Filtered Data LSB | EFDPROXLB |      |      |         |       |       |      |           | 0x1C             | 0x00          |                        |
| ELEPROX Electrode Filtered Data MSB |           |      |      |         |       |       |      | EFDPROXHB | 0x1D             | 0x00          |                        |
| ELE0 Baseline Value                 | E0BV      |      |      |         |       |       |      |           | 0x1E             | 0x00          |                        |
| ELE1 Baseline Value                 | E1BV      |      |      |         |       |       |      |           | 0x1F             | 0x00          |                        |
| ELE2 Baseline Value                 | E2BV      |      |      |         |       |       |      |           | 0x20             | 0x00          |                        |
| ELE3 Baseline Value                 | E3BV      |      |      |         |       |       |      |           | 0x21             | 0x00          |                        |
| ELE4 Baseline Value                 | E4BV      |      |      |         |       |       |      |           | 0x22             | 0x00          |                        |
| ELE5 Baseline Value                 | E5BV      |      |      |         |       |       |      |           | 0x23             | 0x00          |                        |
| ELE6 Baseline Value                 | E6BV      |      |      |         |       |       |      |           | 0x24             | 0x00          |                        |
| ELE7 Baseline Value                 | E7BV      |      |      |         |       |       |      |           | 0x25             | 0x00          |                        |
| ELE8 Baseline Value                 | E8BV      |      |      |         |       |       |      |           | 0x26             | 0x00          |                        |
| ELE9 Baseline Value                 | E9BV      |      |      |         |       |       |      |           | 0x27             | 0x00          |                        |
| ELE10 Baseline Value                | E10BV     |      |      |         |       |       |      |           | 0x28             | 0x00          |                        |
| ELE11 Baseline Value                | E11BV     |      |      |         |       |       |      |           | 0x29             | 0x00          |                        |
| ELEPROX Baseline Value              | EPROXBV   |      |      |         |       |       |      |           | 0x2A             | 0x00          |                        |
| MHD Rising                          |           |      |      |         |       |       |      | MHDR      | 0x2B             | 0x00          |                        |
| NHD Amount Rising                   |           |      |      |         |       |       |      | NHDR      | 0x2C             | 0x00          |                        |
| NCL Rising                          | NCLR      |      |      |         |       |       |      |           | 0x2D             | 0x00          |                        |
| FDL Rising                          | FDLR      |      |      |         |       |       |      |           | 0x2E             | 0x00          |                        |
| MHD Falling                         |           |      |      |         |       |       |      | MHDF      | 0x2F             | 0x00          |                        |
| NHD Amount Falling                  |           |      |      |         |       |       |      | NHDF      | 0x30             | 0x00          |                        |

**Table 1. Register Map**

| REGISTER                   | Fields   |    |          | Register Address | Initial Value | Auto Increment Address |
|----------------------------|----------|----|----------|------------------|---------------|------------------------|
| NCL Falling                | NCLF     |    |          | 0x31             | 0x00          | Register Address + 1   |
| FDL Falling                | FDLF     |    |          | 0x32             | 0x00          |                        |
| NHD Amount Touched         |          |    | NHDT     | 0x33             | 0x00          |                        |
| NCL Touched                | NCLT     |    |          | 0x34             | 0x00          |                        |
| FDL Touched                | FDLT     |    |          | 0x35             | 0x00          |                        |
| ELEPROX MHD Rising         |          |    | MHDPROXR | 0x36             | 0x00          |                        |
| ELEPROX NHD Amount Rising  |          |    | NHDPROXR | 0x37             | 0x00          |                        |
| ELEPROX NCL Rising         | NCLPROXR |    |          | 0x38             | 0x00          |                        |
| ELEPROX FDL Rising         | FDLPROXR |    |          | 0x39             | 0x00          |                        |
| ELEPROX MHD Falling        |          |    | MHDPROXF | 0x3A             | 0x00          |                        |
| ELEPROX NHD Amount Falling |          |    | NHDPROXF | 0x3B             | 0x00          |                        |
| ELEPROX NCL Falling        | NCLPROXF |    |          | 0x3C             | 0x00          |                        |
| ELEPROX FDL Falling        | FDLPROXF |    |          | 0x3D             | 0x00          |                        |
| ELEPROX NHD Amount Touched |          |    | NHDPROXT | 0x3E             | 0x00          |                        |
| ELEPROX NCL Touched        | NCLPROXT |    |          | 0x3F             | 0x00          |                        |
| ELEPROX FDL Touched        | FDLPROXT |    |          | 0x40             | 0x00          |                        |
| ELE0 Touch Threshold       | E0TTH    |    |          | 0x41             | 0x00          |                        |
| ELE0 Release Threshold     | E0RTH    |    |          | 0x42             | 0x00          |                        |
| ELE1 Touch Threshold       | E1TTH    |    |          | 0x43             | 0x00          |                        |
| ELE1 Release Threshold     | E1RTH    |    |          | 0x44             | 0x00          |                        |
| ELE2 Touch Threshold       | E2TTH    |    |          | 0x45             | 0x00          |                        |
| ELE2 Release Threshold     | E2RTH    |    |          | 0x46             | 0x00          |                        |
| ELE3 Touch Threshold       | E3TTH    |    |          | 0x47             | 0x00          |                        |
| ELE3 Release Threshold     | E3RTH    |    |          | 0x48             | 0x00          |                        |
| ELE4 Touch Threshold       | E4TTH    |    |          | 0x49             | 0x00          |                        |
| ELE4 Release Threshold     | E4RTH    |    |          | 0x4A             | 0x00          |                        |
| ELE5 Touch Threshold       | E5TTH    |    |          | 0x4B             | 0x00          |                        |
| ELE5 Release Threshold     | E5RTH    |    |          | 0x4C             | 0x00          |                        |
| ELE6 Touch Threshold       | E6TTH    |    |          | 0x4D             | 0x00          |                        |
| ELE6 Release Threshold     | E6RTH    |    |          | 0x4E             | 0x00          |                        |
| ELE7 Touch Threshold       | E7TTH    |    |          | 0x4F             | 0x00          |                        |
| ELE7 Release Threshold     | E7RTH    |    |          | 0x50             | 0x00          |                        |
| ELE8 Touch Threshold       | E8TTH    |    |          | 0x51             | 0x00          |                        |
| ELE8 Release Threshold     | E8RTH    |    |          | 0x52             | 0x00          |                        |
| ELE9 Touch Threshold       | E9TTH    |    |          | 0x53             | 0x00          |                        |
| ELE9 Release Threshold     | E9RTH    |    |          | 0x54             | 0x00          |                        |
| ELE10 Touch Threshold      | E10TTH   |    |          | 0x55             | 0x00          |                        |
| ELE10 Release Threshold    | E10RTH   |    |          | 0x56             | 0x00          |                        |
| ELE11 Touch Threshold      | E11TTH   |    |          | 0x57             | 0x00          |                        |
| ELE11 Release Threshold    | E11RTH   |    |          | 0x58             | 0x00          |                        |
| ELEPROX Touch Threshold    | EPROXTTH |    |          | 0x59             | 0x00          |                        |
| ELEPROX Release Threshold  | EPROXRTH |    |          | 0x5A             | 0x00          |                        |
| Debounce Touch & Release   |          | DR |          | DT               | 0x5B          | 0x00                   |
| AFE Configuration          | FFI      |    | CDC      |                  | 0x5C          | 0x10                   |
| Filter Configuration       | CDT      |    | SFI      | ESI              | 0x5D          | 0x04                   |
| Electrode Configuration    | CL       | EL |          | EleEn            | 0x5E          | 0x00                   |
| ELE0 Electrode Current     |          |    |          | CDC0             | 0x5F          | 0x00                   |
| ELE1 Electrode Current     |          |    |          | CDC1             | 0x60          | 0x00                   |
| ELE2 Electrode Current     |          |    |          | CDC2             | 0x61          | 0x00                   |

**Table 1. Register Map**

| REGISTER                          | Fields |        |         |       |       |         |       |       | Register Address | Initial Value | Auto Increment Address |      |
|-----------------------------------|--------|--------|---------|-------|-------|---------|-------|-------|------------------|---------------|------------------------|------|
| ELE3 Electrode Current            |        |        | CDC3    |       |       |         |       |       | 0x62             | 0x00          | Register Address + 1   |      |
| ELE4 Electrode Current            |        |        | CDC4    |       |       |         |       |       |                  | 0x63          |                        | 0x00 |
| ELE5 Electrode Current            |        |        | CDC5    |       |       |         |       |       |                  | 0x64          |                        | 0x00 |
| ELE6 Electrode Current            |        |        | CDC6    |       |       |         |       |       |                  | 0x65          |                        | 0x00 |
| ELE7 Electrode Current            |        |        | CDC7    |       |       |         |       |       |                  | 0x66          |                        | 0x00 |
| ELE8 Electrode Current            |        |        | CDC8    |       |       |         |       |       |                  | 0x67          |                        | 0x00 |
| ELE9 Electrode Current            |        |        | CDC9    |       |       |         |       |       |                  | 0x68          |                        | 0x00 |
| ELE10 Electrode Current           |        |        | CDC10   |       |       |         |       |       |                  | 0x69          |                        | 0x00 |
| ELE11 Electrode Current           |        |        | CDC11   |       |       |         |       |       |                  | 0x6A          |                        | 0x00 |
| ELEPROX Electrode Current         |        |        | CDCPROX |       |       |         |       |       |                  | 0x6B          |                        | 0x00 |
| ELE0, ELE1 Charge Time            |        |        | CDT1    |       |       | CDT0    |       |       | 0x6C             | 0x00          |                        |      |
| ELE2, ELE3 Charge Time            |        |        | CDT3    |       |       | CDT2    |       |       | 0x6D             | 0x00          |                        |      |
| ELE4, ELE5 Charge Time            |        |        | CDT5    |       |       | CDT4    |       |       | 0x6E             | 0x00          |                        |      |
| ELE6, ELE7 Charge Time            |        |        | CDT7    |       |       | CDT6    |       |       | 0x6F             | 0x00          |                        |      |
| ELE8, ELE9 Charge Time            |        |        | CDT9    |       |       | CDT8    |       |       | 0x70             | 0x00          |                        |      |
| ELE10, ELE11 Charge Time          |        |        | CDT11   |       |       | CDT10   |       |       | 0x71             | 0x00          |                        |      |
| ELEPROX Charge Time               |        |        |         |       |       | CDTPROX |       |       | 0x72             | 0x00          |                        |      |
| GPIO Control Register 0           | CTL011 | CTL010 | CTL09   | CTL08 | CTL07 | CTL06   | CTL05 | CTL04 | 0x73             | 0x00          |                        |      |
| GPIO Control Register 1           | CTL111 | CTL110 | CTL19   | CTL18 | CTL17 | CTL16   | CTL15 | CTL14 | 0x74             | 0x00          |                        |      |
| GPIO Data Register                | DAT11  | DAT10  | DAT9    | DAT8  | DAT7  | DAT6    | DAT5  | DAT4  | 30x75            | 0x00          |                        |      |
| GPIO Direction Register           | DIR11  | DIR10  | DIR9    | DIR8  | DIR7  | DIR6    | DIR5  | DIR4  | 0x76             | 0x00          |                        |      |
| GPIO Enable Register              | EN11   | EN10   | EN9     | EN8   | EN7   | EN6     | EN5   | EN4   | 0x77             | 0x00          |                        |      |
| GPIO Data Set Register            | SET11  | SET10  | SET9    | SET8  | SET7  | SET6    | SET5  | SET4  | 0x78             | 0x00          |                        |      |
| GPIO Data Clear Register          | CLR11  | CLR10  | CLR9    | CLR8  | 7CLR7 | CLR6    | CLR5  | CLR4  | 0x79             | 0x00          |                        |      |
| GPIO Data Toggle Register         | TOG11  | TOG10  | TOG9    | TOG8  | TOG7  | TOG6    | TOG5  | TOG4  | 0x7A             | 0x00          |                        |      |
| AUTO-CONFIG Control Register 0    | AFES   |        | RETRY   |       | BVA   |         | ARE   | ACE   | 0x7B             | 0x00          |                        |      |
| AUTO-CONFIG Control Register 1    | SCTS   |        |         |       |       | OORIE   | ARFIE | ACFIE | 0x7C             | 0x00          |                        |      |
| AUTO-CONFIG USL Register          | USL    |        |         |       |       |         |       |       | 0x7D             | 0x00          |                        |      |
| AUTO-CONFIG LSL Register          | LSL    |        |         |       |       |         |       |       | 0x7E             | 0x00          |                        |      |
| AUTO-CONFIG Target Level Register | TL     |        |         |       |       |         |       |       | 0x7F             | 0x00          | 0x00                   |      |

## ELECTRICAL CHARACTERISTICS

### Absolute Maximum Ratings

Absolute maximum ratings are stress ratings only, and functional operation at the maxima is not guaranteed. Stress beyond the limits specified in Table 2 may affect device reliability or cause permanent damage to the device. For functional operating conditions, refer to the remaining tables in this section. This device contains circuitry protecting against damage due to high static voltage or electrical fields; however, it is advised that normal precautions be taken to avoid application of any voltages higher than maximum-rated voltages to this high-impedance circuit.

**Table 2. Absolute Maximum Ratings - Voltage (with respect to V<sub>SS</sub>)**

| Rating   | Symbol            | Value  | Unit |
|--|-------------------|--|------|
| Supply Voltage                                     | V <sub>DD</sub>   | -0.3 to +3.6                                   | V    |
| Supply Voltage                                     | V <sub>REG</sub>  | -0.3 to +2.75                                  | V    |
| Input Voltage<br>SCL, SDA, $\overline{\text{IRQ}}$ | V <sub>IN</sub>   | V <sub>SS</sub> - 0.3 to V <sub>DD</sub> + 0.3 | V    |
| Operating Temperature Range                        | T <sub>O</sub>    | -40 to +85                                     | °C   |
| GPIO Source Current per Pin                        | i <sub>GPIO</sub> | 12   | mA   |
| GPIO Sink Current per Pin                          | i <sub>GPIO</sub> | 1.2  | mA   |
| Storage Temperature Range                          | T <sub>S</sub>    | -40 to +125                                    | °C   |

### ESD AND LATCH-UP PROTECTION CHARACTERISTICS

Normal handling precautions should be used to avoid exposure to static discharge.

Qualification tests are performed to ensure that these devices can withstand exposure to reasonable levels of static without suffering any permanent damage. During the device qualification ESD stresses were performed for the Human Body Model (HBM), the Machine Model (MM) and the Charge Device Model (CDM).

A device is defined as a failure if after exposure to ESD pulses the device no longer meets the device specification. Complete DC parametric and functional testing is performed per the applicable device specification at room temperature followed by hot temperature, unless specified otherwise in the device specification.

**Table 3. ESD and Latch-up Test Conditions**

| Rating                                    | Symbol             | Value | Unit |
|---|--------------------|-------|------|
| Human Body Model (HBM)                    | V <sub>ESD</sub>   | ±2000 | V    |
| Machine Model (MM)                        | V <sub>ESD</sub>   | ±200  | V    |
| Charge Device Model (CDM)                 | V <sub>ESD</sub>   | ±500  | V    |
| Latch-up current at T <sub>A</sub> = 85°C | I <sub>LATCH</sub> | ±100  | mA   |



## DC CHARACTERISTICS

This section includes information about power supply requirements and I/O pin characteristics.

**Table 4. DC Characteristics**

(Typical Operating Circuit,  $V_{DD}$  and  $V_{REG} = 1.8\text{ V}$ ,  $T_A = 25^\circ\text{C}$ , unless otherwise noted.)

| Parameter                                    | Symbol           | Conditions  | Min                 | Typ   | Max                 | Units         |
|--|------------------|---|---------------------|-------|---------------------|---------------|
| High Supply Voltage                          | $V_{DD}$         |   | 2.0                 | 3.3   | 3.6                 | V             |
| Low Supply Voltage                           | $V_{REG}$        |   | 1.71                | 1.8   | 2.75                | V             |
| Average Supply Current                       | $I_{DD}$         | Run1 Mode @ 1 ms sample period  |                     | 393   |                     | $\mu\text{A}$ |
| Average Supply Current                       | $I_{DD}$         | Run1 Mode @ 2 ms sample period  |                     | 199   |                     | $\mu\text{A}$ |
| Average Supply Current                       | $I_{DD}$         | Run1 Mode @ 4 ms sample period  |                     | 102   |                     | $\mu\text{A}$ |
| Average Supply Current                       | $I_{DD}$         | Run1 Mode @ 8 ms sample period  |                     | 54    |                     | $\mu\text{A}$ |
| Average Supply Current                       | $I_{DD}$         | Run1 Mode @ 16 ms sample period   |                     | 29    |                     | $\mu\text{A}$ |
| Average Supply Current                       | $I_{DD}$         | Run1 Mode @ 32 ms sample period   |                     | 17    |                     | $\mu\text{A}$ |
| Average Supply Current                       | $I_{DD}$         | Run1 Mode @ 64 ms sample period   |                     | 11    |                     | $\mu\text{A}$ |
| Average Supply Current                       | $I_{DD}$         | Run1 Mode @ 128 ms sample period  |                     | 8     |                     | $\mu\text{A}$ |
| Measurement Supply Current                   | $I_{DD}$         | Peak of measurement duty cycle  |                     | 1     |                     | mA            |
| Idle Supply Current                          | $I_{DD}$         | Stop Mode   |                     | 3     |                     | $\mu\text{A}$ |
| Input Leakage Current ELE_                   | $I_{IH}, I_{IL}$ |   |                     | 0.025 |                     | $\mu\text{A}$ |
| Input Capacitance ELE_                       |                  |   |                     |       | 15                  | pF            |
| Input High Voltage SDA, SCL                  | $V_{IH}$         |   | $0.7 \times V_{DD}$ |       |                     | V             |
| Input Low Voltage SDA, SCL                   | $V_{IL}$         |   |                     |       | $0.3 \times V_{DD}$ | V             |
| Input Leakage Current SDA, SCL               | $I_{IH}, I_{IL}$ |   |                     | 0.025 | 1                   | $\mu\text{A}$ |
| Input Capacitance SDA, SCL                   |                  |   |                     |       | 7                   | pF            |
| Output Low Voltage SDA, IRQ                  | $V_{OL}$         | $I_{OL} = 6\text{mA}$   |                     |       | 0.5V                | V             |
| Output High Voltage ELE4 - ELE11 (GPIO mode) | $V_{OHGPIO}$     | $V_{DD} = 2.7\text{ V to } 3.6\text{ V: } I_{OHGPIO} = -10\text{ mA}$<br>$V_{DD} = 2.3\text{ V to } 2.7\text{ V: } I_{OHGPIO} = -6\text{ mA}$<br>$V_{DD} = 1.8\text{ V to } 2.3\text{ V: } I_{OHGPIO} = -3\text{ mA}$ | $V_{DD} - 0.5$      |       |                     | V             |
| Output Low Voltage ELE4 - ELE11 (GPIO mode)  | $V_{OLGPIO}$     | $I_{OLGPIO} = 1\text{ mA}$  |                     |       | 0.5                 | V             |
| Power On Reset                               | $V_{TLH}$        | $V_{DD}$ rising   | 1.08                | 1.35  | 1.62                | V             |
|  | $V_{THL}$        | $V_{DD}$ falling  | 0.88                | 1.15  | 1.42                | V             |

## AC CHARACTERISTICS

**Table 5. AC CHARACTERISTICS**

(Typical Operating Circuit,  $V_{DD}$  and  $V_{REG} = 1.8\text{ V}$ ,  $T_A = 25^\circ\text{C}$ , unless otherwise noted.)

| Parameter                 | Symbol | Conditions | Min  | Typ | Max  | Units |
|---------------------------|--------|------------|------|-----|------|-------|
| 8 MHz Internal Oscillator | $f_H$  |            | 7.44 | 8   | 8.56 | MHz   |
| 1 kHz Internal Oscillator | $f_L$  |            | 0.65 | 1   | 1.35 | kHz   |

## I<sup>2</sup>C AC CHARACTERISTICS

**Table 6. I<sup>2</sup>C AC Characteristics**

(Typical Operating Circuit, V<sub>DD</sub> and V<sub>REG</sub> = 1.8 V, T<sub>A</sub> = 25°C, unless otherwise noted.)

| Parameter  | Symbol               | Conditions | Min | Typ                  | Max | Units |
|--|----------------------|------------|-----|----------------------|-----|-------|
| Serial Clock Frequency                             | f <sub>SCL</sub>     |            |     |                      | 400 | kHz   |
| Bus Free Time Between a STOP and a START Condition | t <sub>BUF</sub>     |            | 1.3 |                      |     | μs    |
| Hold Time, (Repeated) START Condition              | t <sub>HD, STA</sub> |            | 0.6 |                      |     | μs    |
| Repeated START Condition Setup Time                | t <sub>SU, STA</sub> |            | 0.6 |                      |     | μs    |
| STOP Condition Setup Time                          | t <sub>SU, STO</sub> |            | 0.6 |                      |     | μs    |
| Data Hold Time                                     | t <sub>HD, DAT</sub> |            |     |                      | 0.9 | μs    |
| Data Setup Time                                    | t <sub>SU, DAT</sub> |            | 100 |                      |     | ns    |
| SCL Clock Low Period                               | t <sub>LOW</sub>     |            | 1.3 |                      |     | μs    |
| SCL Clock High Period                              | t <sub>HIGH</sub>    |            | 0.7 |                      |     | μs    |
| Rise Time of Both SDA and SCL Signals, Receiving   | t <sub>R</sub>       |            |     | 20+0.1C <sub>b</sub> | 300 | ns    |
| Fall Time of Both SDA and SCL Signals, Receiving   | t <sub>F</sub>       |            |     | 20+0.1C <sub>b</sub> | 300 | ns    |
| Fall Time of SDA Transmitting                      | t <sub>F, TX</sub>   |            |     | 20+0.1C <sub>b</sub> | 250 | ns    |
| Pulse Width of Spike Suppressed                    | t <sub>SP</sub>      |            |     | 25                   |     | ns    |
| Capacitive Load for Each Bus Line                  | C <sub>b</sub>       |            |     |                      | 400 | pF    |

# AN3889: MPR121 Capacitance Sensing Settings

## INTRODUCTION

Touch acquisition takes a few different parts of the system in order to detect touch. The first stage of this process is to capture the pad capacitance. Freescale's MPR121 utilizes the principle that a capacitor holds a fixed amount of charge at a specific electric potential. Both the implementation and the configuration will be described in this application note.

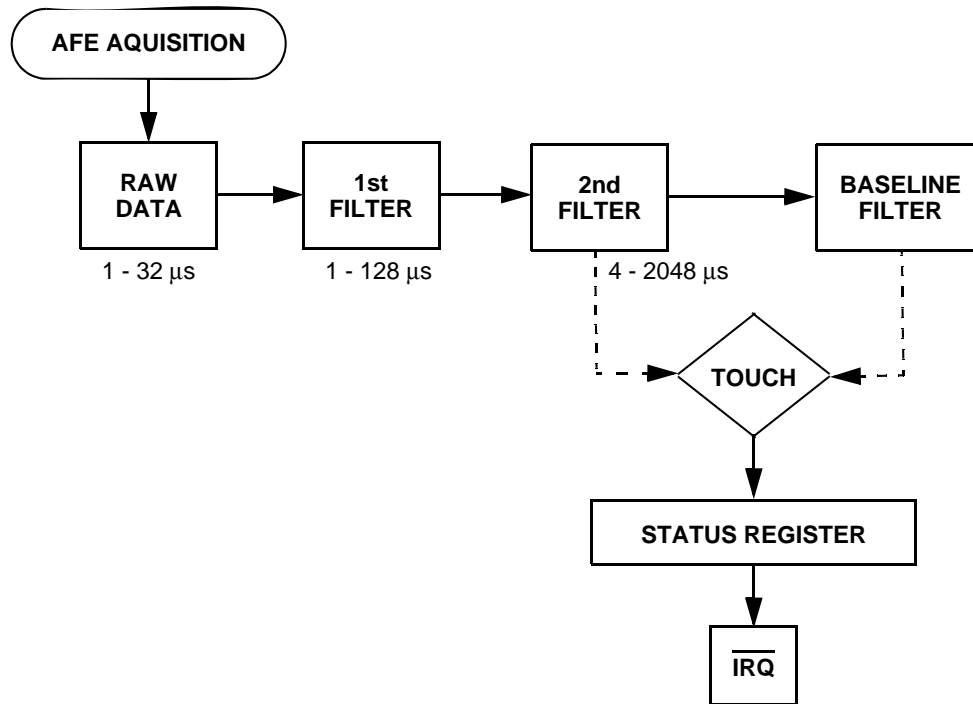

Figure 3. Data Flow in the MPR121

## CAPACITANCE MEASUREMENT

The basic measurement technique used by the MPR121 is to charge up the capacitor  $C$  on one electrode input with a DC current  $I$  for a time  $T$  (the charge time). Before measurement, the electrode input is grounded, so the electrode voltage starts from  $0\text{ V}$  and charges up with a slope, Equation 1, where  $C$  is the pad capacitance on the electrode (Figure 4). All of the other electrodes are grounded during this measurement. At the end of time  $T$ , the electrode voltage is measured with a 10 bit ADC. The voltage is inversely proportional to capacitance according to Equation 2. The electrode is then discharged back to ground at the same rate it was charged.

$$\frac{dV}{dt} = \frac{I}{C} \quad \text{Equation 1}$$

$$V = \frac{I \times T}{C} \quad \text{Equation 2}$$

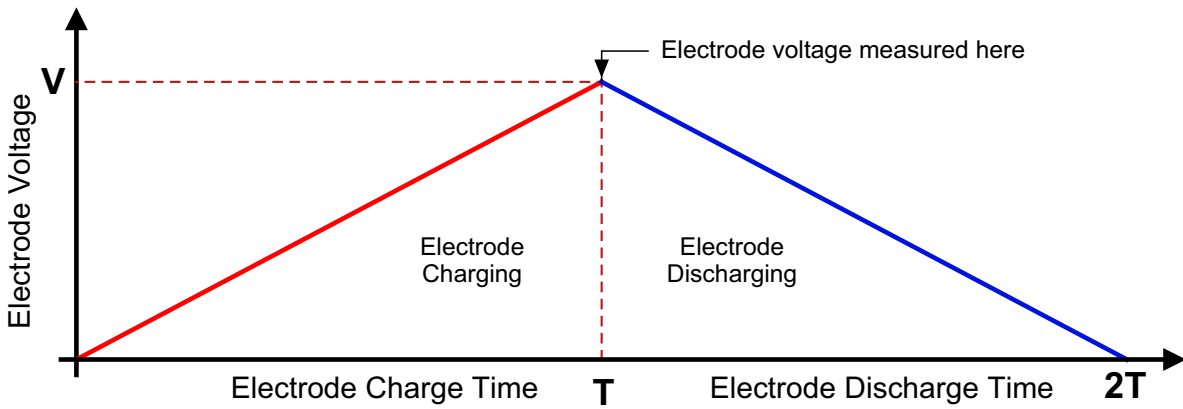

**Figure 4. MPR121 Electrode Measurement Charging Pad Capacitance**

When measuring capacitance there are some inherent restrictions due to the methodology used. On the MPR121 the voltage after charging must be in the range that is shown in [Figure 5](#).

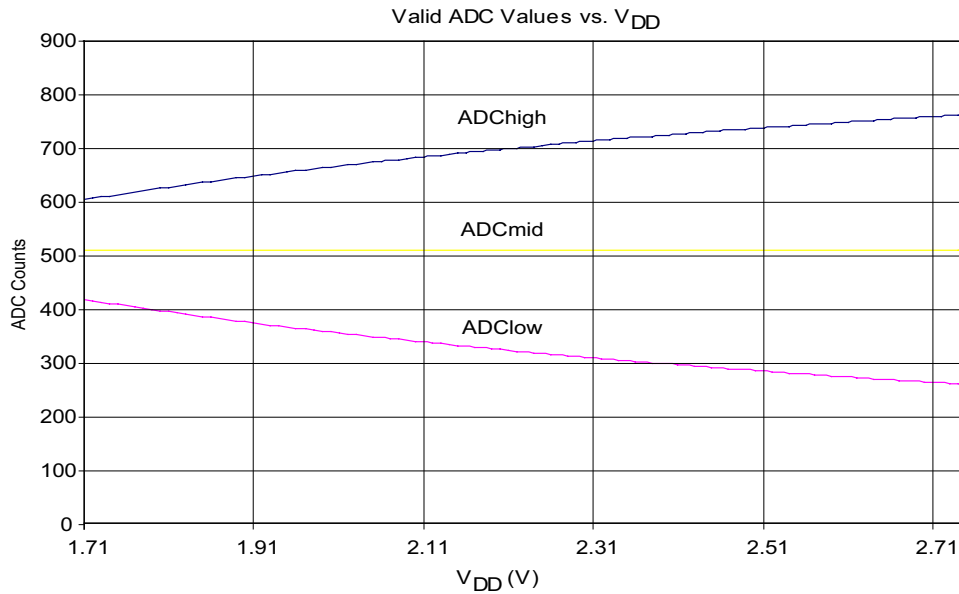

**Figure 5.**

The valid operating range of the electrode charging source is 0.7 V to  $(V_{DD} - 0.7 \text{ V})$ . This means that for a given  $V_{DD}$  the valid ADC (voltage visible to the digital interface) range is given by

$$ADC_{low} = \frac{0.7}{V_{DD}}(1024), \quad \text{Equation 3}$$

and

$$ADC_{high} = \frac{V_{DD} - 0.7}{V_{DD}}(1024). \quad \text{Equation 4}$$

These equations are represented in the graph. In the nominal case of  $V_{DD} = 1.8 \text{ V}$  the ADC range is shown below in [Table 7](#).

**Table 7.**

| $V_{DD}$ | $ADC_{high}$ | $ADC_{low}$ | $ADC_{mid}$ |
|----------|--------------|-------------|-------------|
| 1.8      | 625.7778     | 398.2222    | 512         |

Any ADC counts outside of the range shown are invalid and settings must be adjusted to be within this range. If capacitance variation is of importance for an application after the current output, charge time and supply voltage are determined then the following equations can be used. The valid range for capacitance is calculated by using the minimum and maximum ADC values in the capacitance equation. Substituting the low and high ADC equations into the capacitance equation yields the equations for the minimum and maximum capacitance values which are

$$C_{low} = \frac{I \times T}{V_{DD}^{-0.7}} \text{ and } C_{high} = \frac{I \times T}{0.7} . \quad \text{Equation 5}$$

### SENSITIVITY

The sensitivity of the MPR121 is relative to the capacitance range being measured. Given the ADC value, current and time and settings capacitance can be calculated,

$$C = \frac{I \times T \times 1024}{V_{DD} \times ADC} . \quad \text{Equation 6}$$

For a given capacitance the sensitivity can be measured by taking the derivative of this equation. The result of this is the following equation, representing the change in capacitance per one ADC count, where the ADC in the equation represents the current value.

$$\frac{dC}{dADC} = \frac{I \times T \times 1024}{V_{DD} \times ADC^2} \quad \text{Equation 7}$$

This relationship is shown in the following graph by taking the midpoints off all possible ranges by varying the current and time settings. The midpoint is assumed to be 512 for ADC and the nominal supply voltage of 1.8 V is used.

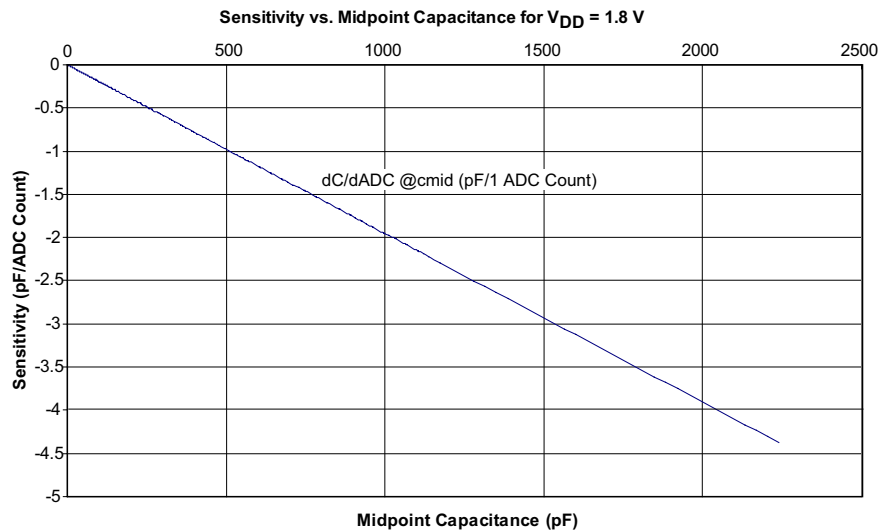

Figure 6.

Smaller amounts of change indicate increased sensitivity for the capacitance sensor. Some sample values are shown in Table 8.

Table 8.

| pF  | Sensitivity (pF/ADC count) |
|-----|----------------------------|
| 10  | -0.01953                   |
| 100 | -0.19531                   |

In the previous cases, the capacitance is assumed to be in the middle of the range for specific settings. Within the capacitance range the equation is nonlinear, thus the sensitivity is best with the lowest capacitance. This graph shows the sensitivity derivative reading across the valid range of capacitances for a set I, T, and  $V_{DD}$ . For simple small electrodes (that are approximately 21 pF) and a nominal 1.8 V supply. Figure 7 is representative of this effect.

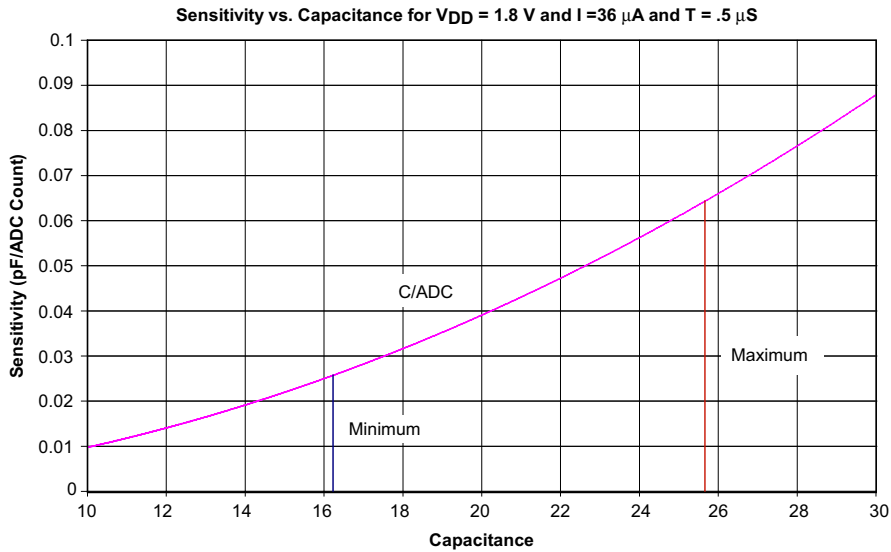

**Figure 7.**

**CONFIGURATION**

From the implementation above, there are two elements that can be configured to yield a wide range of capacitance readings ranging from 0.455 pF to 2874.39 pF. The two configurable components are the electrode charge current and the electrode charge time. The electrode charge current can be configured to equal a range of values between 1  $\mu\text{A}$  and 63  $\mu\text{A}$ . This value is set in the Charge Discharge Current (CDC) in the Analog Front End AFE Configuration register. The electrode charge time can be configured to equal a range of values between 500 ns and 32  $\mu\text{s}$ . This value is set in the Charge Discharge Time (CDT) in the Filter Configuration Register.

**AFE CONFIGURATION REGISTER**

The AFE Configuration Register is used to set both the CDC and the number of samples taken in the lowest level filter. The address of the AFE Configuration Register is 0x5C.

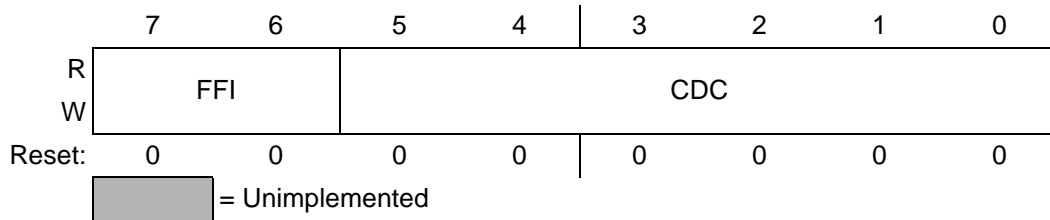

**Figure 8. AFE Configuration Register**

**Table 9. AFE Configuration Register Field Descriptions**

| Field      | Description   |
|------------|---|
| 7:6<br>FFI | First Filter Iterations – The first filter iterations field selects the number of samples taken as input to the first level of filtering.<br>00 Encoding 0 – Sets samples taken to 6<br>01 Encoding 1 – Sets samples taken to 10<br>10 Encoding 2 – Sets samples taken to 18<br>11 Encoding 3 – Sets samples taken to 34        |
| 5:0<br>CDC | Charge Discharge Current – The Charge Discharge Current field selects the supply current to be used when charging and discharging an electrode.<br>000000 Encoding 0 – Disables Electrode Charging<br>000001 Encoding 1 – Sets the current to 1 $\mu\text{A}$<br>~<br>111111 Encoding 63 – Sets the current to 63 $\mu\text{A}$ |

## FILTER CONFIGURATION REGISTER

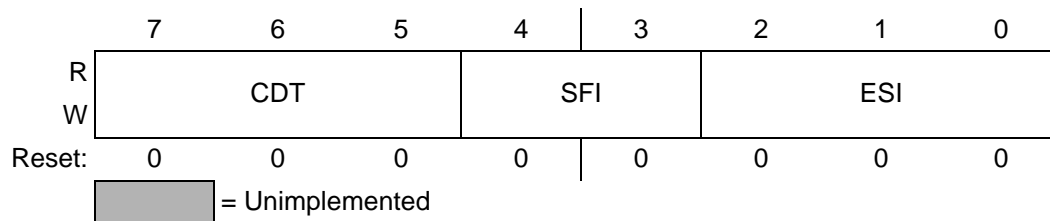

Figure 9. Filter Configuration Register

Table 10. Filter Configuration Register Field Descriptions

| Field      | Description  |
|------------|--|
| 7:5<br>CDT | Charge Discharge Time – The Charge Discharge Time field selects the amount of time an electrode charges and discharges.<br>000 Encoding 0 – Invalid<br>001 Encoding 1 – Time is set to 0.5 $\mu$ s<br>010 Encoding 2 – Time is set to 1 $\mu$ s<br>~<br>111 Encoding 7 – Time is set to 32 $\mu$ s.                                  |
| 4:3<br>SFI | Second Filter Iterations – The Second Filter Iterations field selects the number of samples taken for the second level filter.<br>00 Encoding 0 – Number of samples is set to 4<br>01 Encoding 1 – Number of samples is set to 6<br>10 Encoding 2 – Number of samples is set to 10<br>11 Encoding 3 – Number of samples is set to 18 |
| 2:0<br>ESI | Electrode Sample Interval – The Electrode Sample Interval field selects the period between samples used for the second level of filtering.<br>000 Encoding 0 – Period set to 1 ms<br>001 Encoding 1 – Period set to 2 ms<br>~<br>111 Encoding 7 – Period set to 128 ms   |

The SFI, ESI and FFI are described in AN3890. In addition to these global (same for all electrodes) settings, the MPR121 electrodes can also be independently configured.

## ELECTRODE CHARGE CURRENT REGISTER

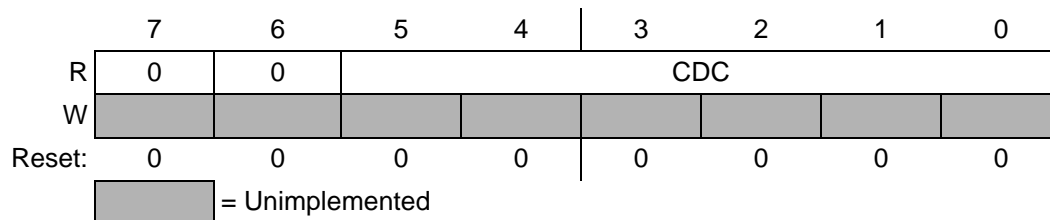

Figure 10. Electrode Charge Current Register

Table 11. Electrode Charge Current Register Field Descriptions

| Field      | Description   |
|------------|---|
| 5:0<br>CDC | Electrode # Charge Discharge Current – The Charge Discharge Current field selects the supply current to be used when charging and discharging an electrode.<br>000000 Encoding 0 – Disables Electrode Charging<br>000001 Encoding 1 – Sets the current to 1 $\mu$ A<br>~<br>111111 Encoding 63 – Sets the current to 63 $\mu$ A |

## ELECTRODE CHARGE TIME

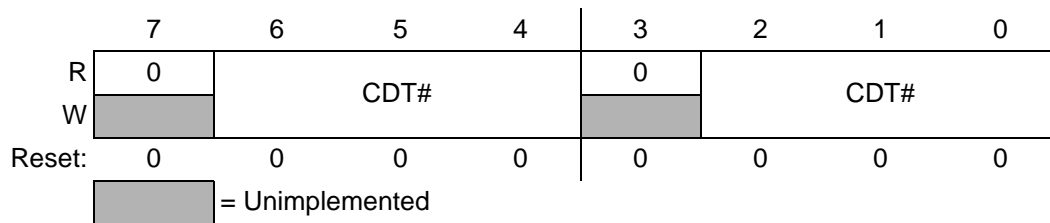

Figure 11. Electric Charge Time Register

Table 12. Electrode Charge Time Register Field Descriptions

| Field       | Description  |
|-------------|--|
| 6:4<br>CDT# | Electrode # Charge Discharge Time – The Charge Discharge Time field selects the amount of time an electrode charges and discharges.<br>000 Encoding 0 – Global value is used.<br>001 Encoding 1 – Time is set to 0.5 $\mu$ s<br>010 Encoding 2 – Time is set to 1 $\mu$ s<br>~<br>11 Encoding 7 – Time is set to 32 $\mu$ s. |
| 2:0<br>CDT# | Electrode # Charge Discharge Time – The Charge Discharge Time field selects the amount of time an electrode charges and discharges.<br>000 Encoding 0 – Global value is used.<br>001 Encoding 1 – Time is set to 0.5 $\mu$ s<br>010 Encoding 2 – Time is set to 1 $\mu$ s<br>~<br>11 Encoding 7 – Time is set to 32 $\mu$ s. |

## AUTO-CONFIGURATION

One of the new features added in the MPR121 that was not included in the MPR03X is the ability to automatically configure the Charge Current the Charge Time. This eliminates much of the guess involved with touch sensors and allows the same settings to properly configure the device for a wide range of application and electrodes. As show earlier in this document, the sensitivity of the sensor is maximized by having the baseline be as high as possible for a specific baseline capacitance. The restriction on the high side is that a system should not charge above  $V_{DD} - 0.7$  V due to this being a non-linear region. Thus the target voltage used is approximately  $V_{DD} - 0.7$  V.

Table 13.

| Voltage ( $V_{DD}$ ) | $V_{DD} - 0.7$ V | ADC | Baseline |
|----------------------|------------------|-----|----------|
| 1.8 V                | 1.1 V            | 625 | 156      |
| $V_{DD}$             | 2.3 V            | 785 | 196      |

This implies that the automatic configuration system should target approximately 156 when  $V_{DD}$  is 1.8 V and 196 when  $V_{DD}$  is 3.0 V. The following three registers should be set based on the  $V_{DD}$  in the system. If the voltage is unregulated, set the values assuming the lowest voltage necessary for the battery. If the final voltage supply in the system is not known, just use the 1.8 V values as they represent the worst case. This lower setting will not dramatically affect the performance, thus the 1.8 V could be considered default and be used in all cases where fine tuning is not required.



## AUTO-CONFIG USL REGISTER

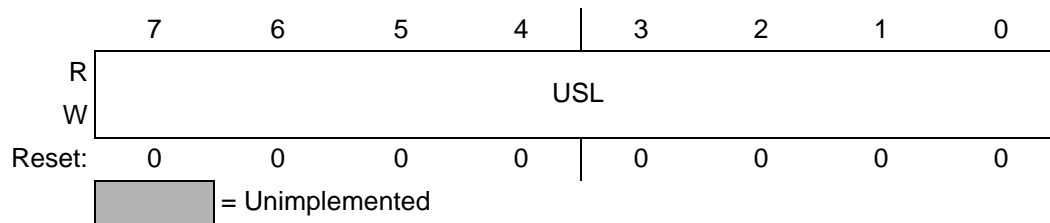

Figure 12. AUTO-CONFIG USL Register

Table 14. AUTO-CONFIG USL Register Field Descriptions

| Field      | Description  |
|------------|--|
| 7:0<br>USL | Upper Limit – The Upper Limit for the auto-configuration baseline search is set to this value.<br>00000000 – Upper Limit set to 0<br>00000001 – Upper Limit set to 1<br>~<br>11111111 – Upper Limit set to 255 |

As this register represents the upper limit for the auto-configuration the value can be calculated by:

$$VSL = \frac{V_{DD} - 0.7}{V_{DD}} \cdot 256 \quad \text{Equation 8}$$

For the 1.8 V system, this value is 156 or 0x9C.

## AUTO-CONFIG TARGET LEVEL REGISTER

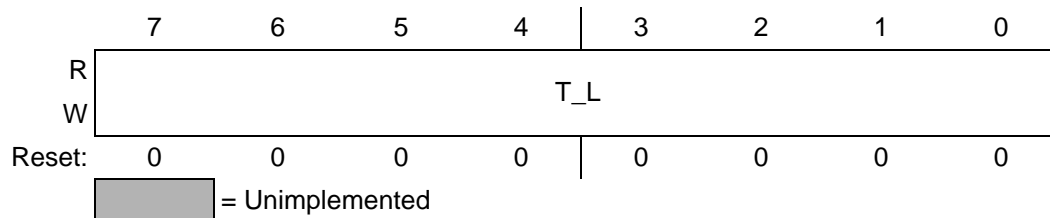

Figure 13. AUTO-CONFIG Target Level Register

**Table 15. AUTO-CONFIG Target Level Register Field Descriptions**

| Field     | Description   |
|-----------|---|
| 7:0<br>TL | Target Level – The Target Level for the auto-configuration baseline search is set to this value.<br>00000000 – Target Level set to 0<br>00000001 – Target Level set to 1<br>~<br>11111111 – Target Level set to 255 |

This register represents the target level for the auto-configuration. The value can be calculated by:

$$Target = \frac{V_{DD} - 0.7}{V_{DD}} \cdot 256 \cdot 0.9$$

← 90% of USL

For a 1.8 V system, this value is 140 or 0x8C.

**AUTO-CONFIG LSL REGISTER**

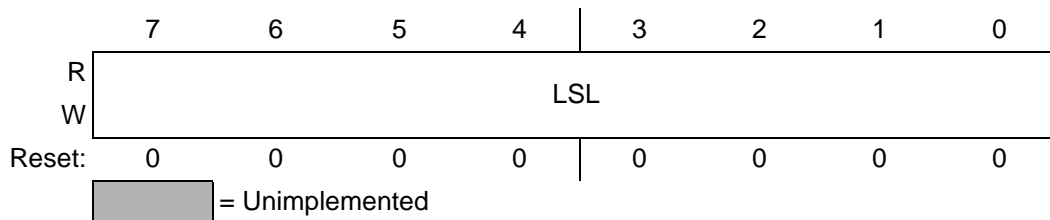

**Figure 14. AUTO-CONFIG LSL Register**

**Table 16. AUTO-CONFIG LSL Register Field Descriptions**

| Field      | Description  |
|------------|--|
| 7:0<br>LSL | Lower Limit – The Lower Limit for the auto-configuration baseline search is set to this value.<br>00000000 – Lower Limit set to 0<br>00000001 – Lower Limit set to 1<br>~<br>11111111 – Lower Limit set to 255 |

This register represents the lower limit for the auto-configuration. The value can be calculated by:

$$Target = \frac{V_{DD} - 0.7}{V_{DD}} \cdot 256 \cdot 0.65$$

← 65% of USL

For a 1.8 V system, this value is 101 or 0x65.

The last setting required to set up the auto-configuration system is the AUTO e Register.

**AUTO-CONFIG CONTROL REGISTER**

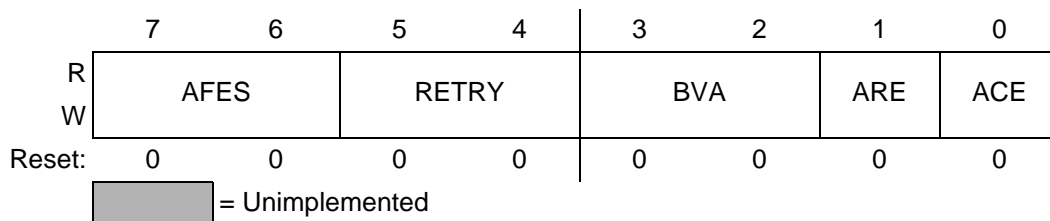

**Figure 15. AUTO-CONFIG Control Register**

**Table 17. AUTO-CONFIG Control Register Field Descriptions**

| Field        | Description  |
|--------------|--|
| 7:6<br>AFES  | First Filter Iterations – The first filter iterations field selects the number of samples taken as input to the first level of filtering. This value must match the FFI set in the AFE Configuration register for proper AUTO-CONFIG functionality.<br>00 Encoding 0 – Sets samples taken to 6<br>01 Encoding 1 – Sets samples taken to 10<br>10 Encoding 2 – Sets samples taken to 18<br>11 Encoding 3 – Sets samples taken to 34 |
| 5:4<br>RETRY | Retry – The Retry value determines under what circumstances the auto-configuration system will retry.<br>00 – Retry disabled<br>01 – Retry enabled<br>10 – Retry enabled<br>11 – Retry enabled   |
| 3:2<br>BVA   | Baseline Value Adjust – The baseline value adjust determines the initial value of the baseline registers after auto-configuration completes.<br>00 – Baseline is not changed<br>01 – Baseline is cleared<br>10 – Baseline is set to the AUTO-CONFIG baseline with the lower 3 bits cleared<br>11 – Baseline is set to the AUTO-CONFIG baseline   |
| 1<br>ARE     | Automatic Reconfiguration Enable – The automatic reconfiguration enable, enables or disables automatic reconfiguration.<br>0 – ARE is disabled<br>1 – ARE is enabled   |
| 0<br>ACE     | Automatic Configuration Enable – The automatic configuration enable, enables or disables automatic configuration.<br>0 – ACE is disabled<br>1 – ACE is enabled   |

The normal setup of the system is to set this register to 0x0B or 0b00001011. This means that the FFI is 00, but if the FFI in the AFE Configuration Register is different, it must be changed to match. For a description of this register, please refer to AN3890. The RETRY is disabled because in production systems, this will not be required. The BVA is set to 10 which allows the baseline to be updated. 10 is used instead of 11 because this guarantees that the baseline will be lower than the data. This is preferable as it protects against false touches. If somehow the baseline started higher than the data, a touch would be triggered and the detection system would have to be reset to work correctly. Last, both the automatic configuration and automatic reconfiguration are enable. Reconfiguration will trigger any time the baseline drifts outside the range set by the USL and the LSL.

There is also a set of flags which show when the automatic configuration has failed. For normal sized touch electrodes, this cannot occur without the USL, LSL and TSL being incorrectly set. The most likely configuration error is to set the USL (upper limit) at a lower value than the LSL (lower limit). Thus, as the algorithm searches for settings that work, it would always result in a fail throwing the OOR (Out Of Range) status flag.

The ARFF and ACFF also tell the user which type of configuration cycle caused the error. If it was triggered during an initial calibration, the ACFF will trigger. If the fail occurs during a reconfiguration, the ARFF will trigger.

**ELE0-7 OUT OF RANGE STATUS REGISTER**

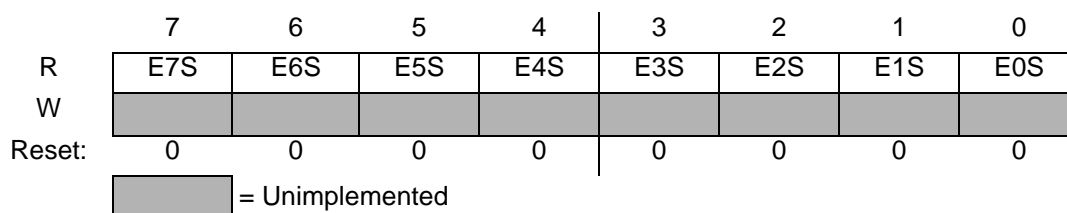

**Figure 16. ELE0-7 Out Of Range Status Register**

**Table 18. ELE0-7 Out Of Range Status Register Field Descriptions**

| <b>Field</b> | <b>Description</b>   |
|--------------|--|
| 7<br>E7S     | Electrode 7 OOR Status – The Electrode 7 OOR Status shows if the AUTO-CONFIG has failed.<br>0 – Auto-configuration Successful<br>1 – Auto-configuration Failed |
| 6<br>E6S     | Electrode 6 OOR Status – The Electrode 7 OOR Status shows if the AUTO-CONFIG has failed.<br>0 – Auto-configuration Successful<br>1 – Auto-configuration Failed |
| 5<br>E5S     | Electrode 5 OOR Status – The Electrode 7 OOR Status shows if the AUTO-CONFIG has failed.<br>0 – Auto-configuration Successful<br>1 – Auto-configuration Failed |
| 4<br>E4S     | Electrode 4 OOR Status – The Electrode 7 OOR Status shows if the AUTO-CONFIG has failed.<br>0 – Auto-configuration Successful<br>1 – Auto-configuration Failed |
| 3<br>E3S     | Electrode 3 OOR Status – The Electrode 7 OOR Status shows if the AUTO-CONFIG has failed.<br>0 – Auto-configuration Successful<br>1 – Auto-configuration Failed |
| 2<br>E2S     | Electrode 2 OOR Status – The Electrode 7 OOR Status shows if the AUTO-CONFIG has failed.<br>0 – Auto-configuration Successful<br>1 – Auto-configuration Failed |
| 1<br>E1S     | Electrode 1 OOR Status – The Electrode 7 OOR Status shows if the AUTO-CONFIG has failed.<br>0 – Auto-configuration Successful<br>1 – Auto-configuration Failed |
| 0<br>E0S     | Electrode 0 OOR Status – The Electrode 7 OOR Status shows if the AUTO-CONFIG has failed.<br>0 – Auto-configuration Successful<br>1 – Auto-configuration Failed |

## ELE8-11, ELEPROX OUT OF RANGE STATUS REGISTER

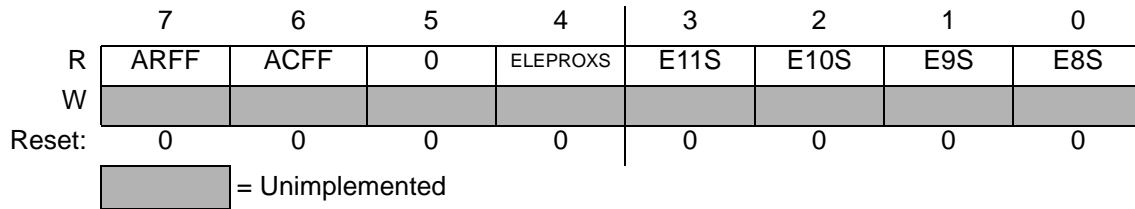

Figure 17. ELE8-11, ELEPROX Out Of Range Status Register

Table 19. ELE8-11, ELEPROX Out Of Range Status Register Field Descriptions

| Field         | Description  |
|---------------|--|
| 7<br>ARFF     | Automatic Reconfiguration Fail Flag – The Automatic Reconfiguration Fail Flag shows is the OOR was triggered during a reconfiguration cycle.<br>0 – Auto-reconfiguration did not cause the OOR flag<br>1 – Auto-reconfiguration did cause the OOR flag |
| 6<br>ACFF     | Automatic Configuration Fail Flag – The Automatic Configuration Fail Flag shows is the OOR was triggered during an initial configuration cycle.<br>0 – Auto-configuration did not cause the OOR flag<br>1 – Auto-configuration did cause the OOR flag  |
| 4<br>ELEPROXS | Electrode PROX OOR Status – The Electrode PROX OOR Status shows if the AUTO-CONFIG has failed.<br>0 – Auto-configuration Successful<br>1 – Auto-configuration Failed   |
| 3<br>E11S     | Electrode 11 OOR Status – The Electrode 11 OOR Status shows if the AUTO-CONFIG has failed.<br>0 – Auto-configuration Successful<br>1 – Auto-configuration Failed   |
| 2<br>E10S     | Electrode 10 OOR Status – The Electrode 10 OOR Status shows if the AUTO-CONFIG has failed.<br>0 – Auto-configuration Successful<br>1 – Auto-configuration Failed   |
| 1<br>E9S      | Electrode 9 OOR Status – The Electrode 9 OOR Status shows if the AUTO-CONFIG has failed.<br>0 – Auto-configuration Successful<br>1 – Auto-configuration Failed   |
| 0<br>E8S      | Electrode 8 OOR Status – The Electrode 8 OOR Status shows if the AUTO-CONFIG has failed.<br>0 – Auto-configuration Successful<br>1 – Auto-configuration Failed   |

# AN3890: MPR121 Capacitance Sensing — Filtering and Timing

## INTRODUCTION

The capacitance sensing front end of the MPR121 produces data at extremely high rates, which significantly improves the capabilities of a filtering system. The capacitance engine described in AN3889 act on a  $1\ \mu\text{s}$  -  $32\ \mu\text{s}$  per sample data rate. This application note will discuss the first and second level filters in the MPR121 and how they impact timing and power consumption.

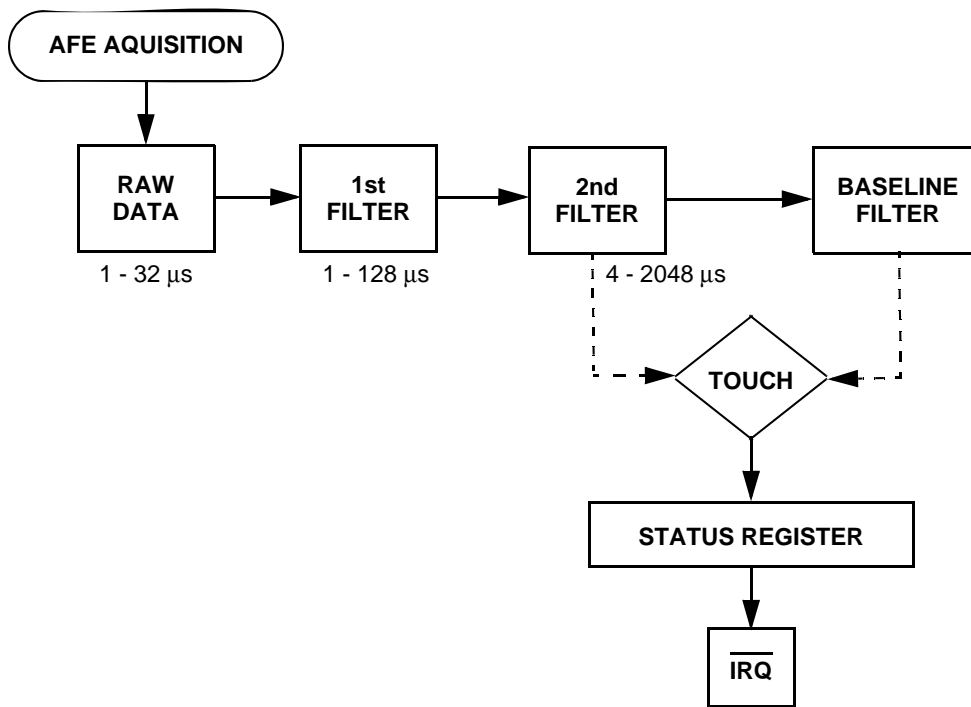
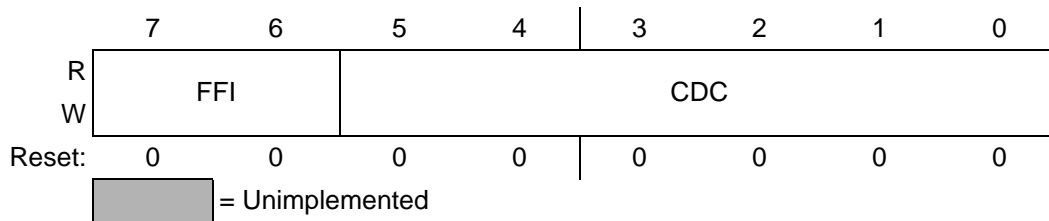

**Figure 18. Data Flow in the MPR121**

The first level filter is configured through the use of the First Filter Iterations (FFI) and the Charge Discharge Time (CDT).

## AFE CONFIGURATION REGISTER

The AFE Configuration Register is used to set both the CDC and the number of samples taken in the lowest level filter. The address of the AFE Configuration Register is 0x5C.

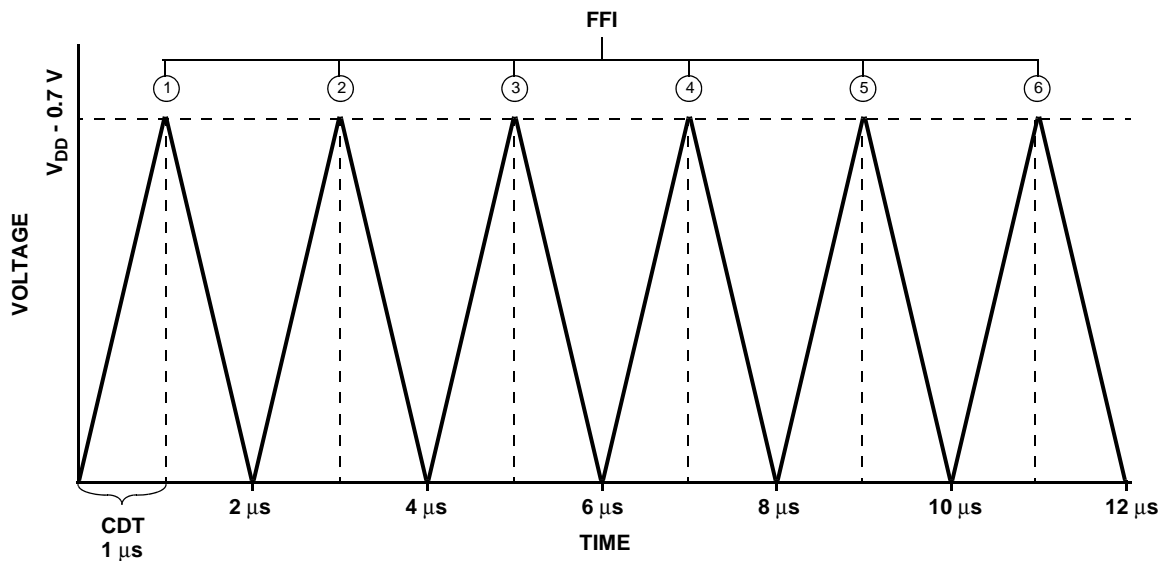

**Figure 19. AFE Configuration Register**

**Table 20. AFE Configuration Register Field Descriptions**

| Field      | Description  |
|------------|--|
| 7:6<br>FFI | First Filter Iterations – The first filter iterations field selects the number of samples taken as input to the first level of filtering.<br>00 Encoding 0 – Sets samples taken to 6<br>01 Encoding 1 – Sets samples taken to 10<br>10 Encoding 2 – Sets samples taken to 18<br>11 Encoding 3 – Sets samples taken to 34 |
| 5:0<br>CDC | Charge Discharge Current – The Charge Discharge Current field selects the supply current to be used when charging and discharging an electrode.<br>000000 Encoding 0 – Disables Electrode Charging<br>000001 Encoding 1 – Sets the current to 1µA<br>~<br>111111 Encoding 63 – Sets the current to 63 µA                 |

The properties of the filter are determined by these two settings, but the CDT is determined by the capacitance being measured, as discussed in AN3889. The FFI sets the number of samples being measured. The result of an FFI setting of 6 or 0x00 would be to take 6 samples, toss the maximum and minimum, then average the remaining 4 samples. The results of an oscilloscope output on an electrode with the setting of FFI = 0x00 and CDT is shown in Figure 20.



**Figure 20.**

The first level of filtering delivers data to a second filter stage. The second filter stage averages samples over more time, in this example anywhere from 1 ms to 128 ms. Then a value can be selected for how many samples should be averaged.

**FILTER CONFIGURATION REGISTER**

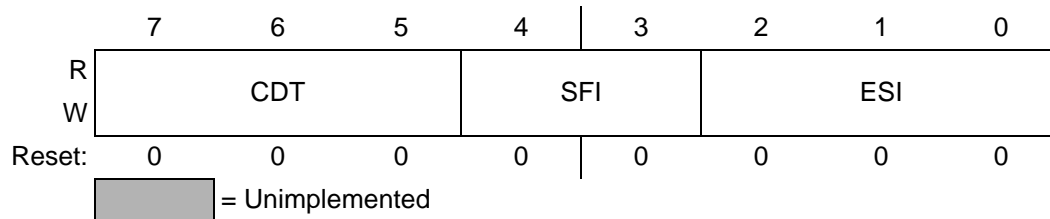

**Figure 21. Filter Configuration Register**

**Table 21. Filter Configuration Register Field Descriptions**

| Field      | Description  |
|------------|--|
| 7:5<br>CDT | Charge Discharge Time – The Charge Discharge Time field selects the amount of time an electrode charges and discharges.<br>000 Encoding 0 – Invalid<br>001 Encoding 1 – Time is set to 0.5 $\mu$ s<br>010 Encoding 2 – Time is set to 1 $\mu$ s<br>~<br>111 Encoding 7 – Time is set to 32 $\mu$ s.                                  |
| 4:3<br>SFI | Second Filter Iterations – The Second Filter Iterations field selects the number of samples taken for the second level filter.<br>00 Encoding 0 – Number of samples is set to 4<br>01 Encoding 1 – Number of samples is set to 6<br>10 Encoding 2 – Number of samples is set to 10<br>11 Encoding 3 – Number of samples is set to 18 |
| 2:0<br>ESI | Electrode Sample Interval – The Electrode Sample Interval field selects the period between samples used for the second level of filtering.<br>000 Encoding 0 – Period set to 1 ms<br>001 Encoding 1 – Period set to 2 ms<br>~<br>111 Encoding 7 – Period set to 128 ms   |

**Note:** In most cases the CDT in this register is not used. It will normally be auto-configured as described in AN3889

While the 1 ms to 128 ms does affect the filtering, the main purposed of adjusting the sample rate would be to change the average current consumption of the device. [Figure 22](#) illustrates this adjustment.

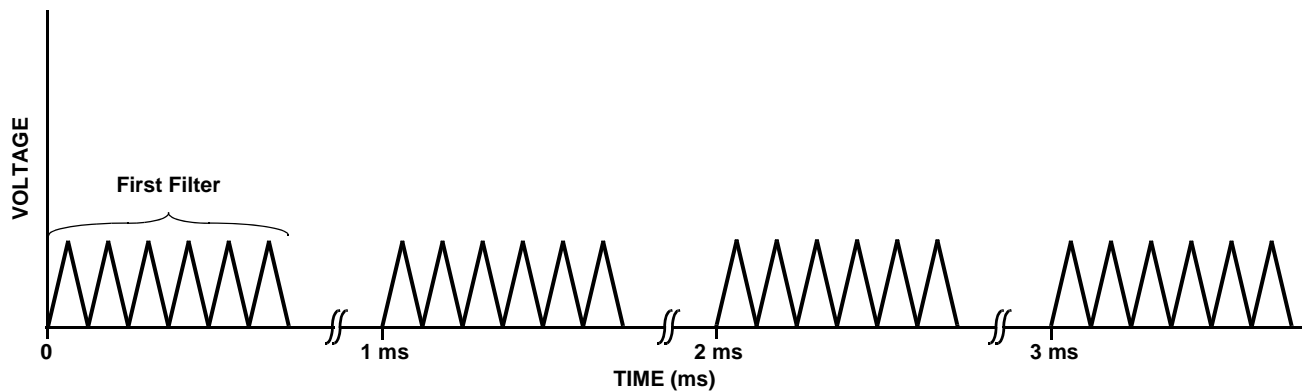

**Figure 22.**

From this, it can be seen that the 12  $\mu$ s up time from the 1 ms samples results in a very low percent of duty cycle. This results in a very low average current consumption.



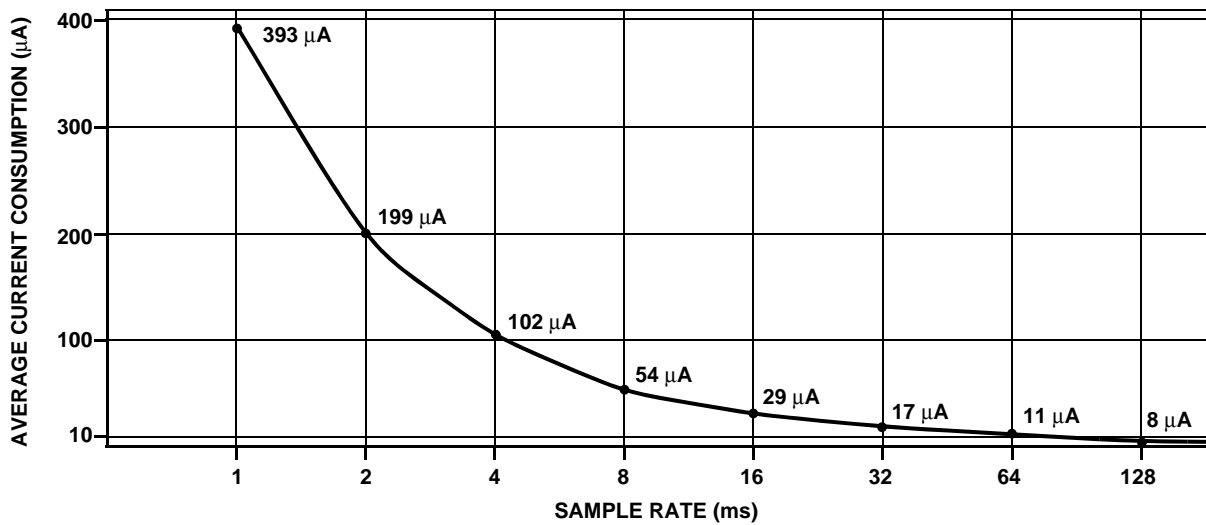

**Figure 23. Average Supply Current**

The output data is the Filtered Data High and Low is the data coming out of the second stage filter. This means that the response time of the output is the SFI times the ESI. This usually results in 16 ms and 4 iterations being used to get 64 ms response time while still optimizing the power consumption. At each 64 ms, a decision would be made regarding touch by comparing the Baseline with the filtered data output, resulting in a worst case of the full 64 ms plus half the previous cycle, equalling 96 ms.

# AN3891: MPR121 Baseline System

## INTRODUCTION

Touch acquisition takes a few different parts of the system in order to detect touch. The baseline filter and touch detection are tightly coupled. The purpose of the baseline filter is to “filter out touches” resulting in a system that is similar to a long term average but also takes into account that one specific signature. A touch must have different properties than noise and environmental change with respect to the filter response. This is accomplished through four register types that operate under different conditions. These are Max Half Delta (MHD), Noise Half Delta (NHD), Noise Count Limit (NCL) and Filter Delay Limit (FDL).

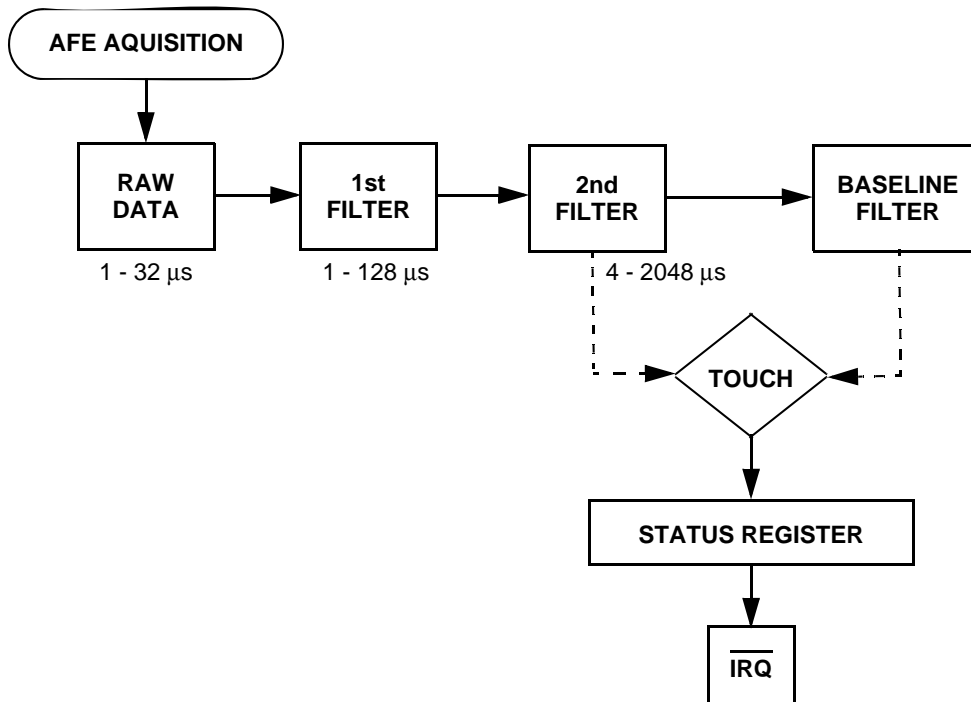

Figure 24. Data Flow in the MPR121

## MAX HALF DELTA (NHD)

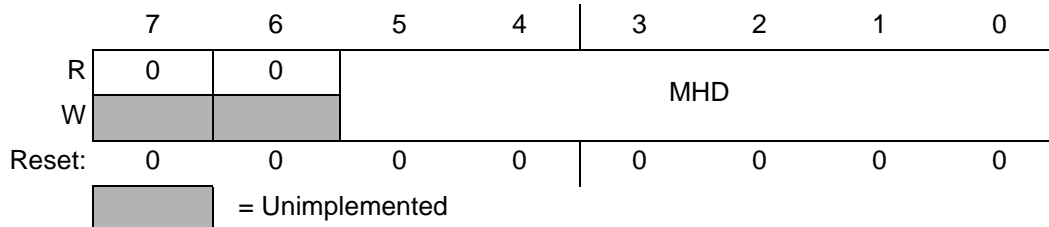

Table 22. Max Half Delta Register Field Descriptions

| Field      | Description   |
|------------|---|
| 5:0<br>MHD | Max Half Delta – The Max Half Delta determines the largest magnitude of variation to pass through the third level filter.<br>000000 DO NOT USE THIS CODE<br>000001 Encoding 1 – Sets the Max Half Delta to 1<br>~<br>111111 Encoding 63 – Sets the Max Half Delta to 63 |

## NOISE HALF DELTA (NHD)

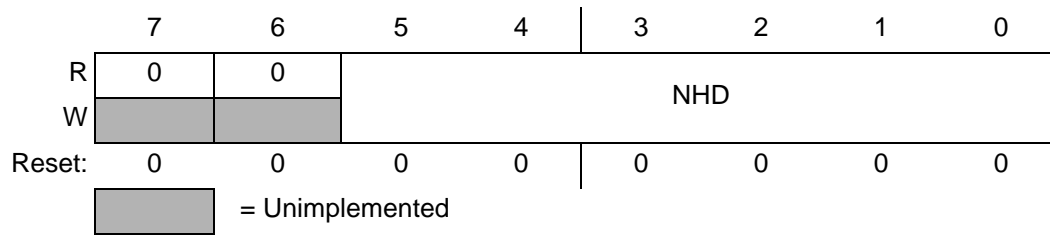

Figure 25. Noise Half Delta Register

Table 23. Noise Half Delta Register Field Descriptions

| Field      | Description   |
|------------|---|
| 5:0<br>NHD | Noise Half Delta – The Noise Half Delta determines the incremental change when non-noise drift is detected.<br>000000 DO NOT USE THIS CODE<br>000001 Encoding 1 – Sets the Noise Half Delta to 1<br>~<br>111111 Encoding 63 – Sets the Noise Half Delta to 63 |

## NOISE COUNT LIMIT (NCL)

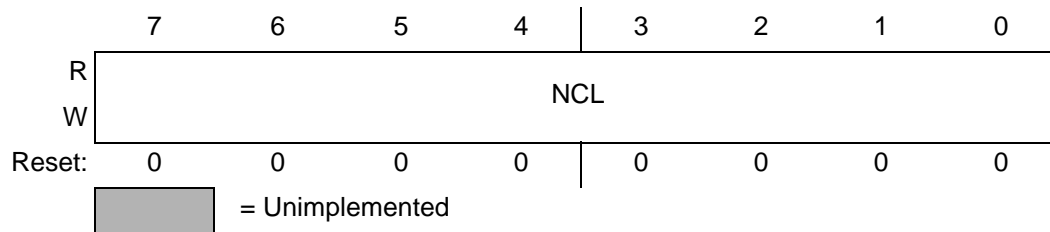

Figure 26. Noise Count Limit Register

Table 24. Noise Count Limit Register Field Descriptions

| Field      | Description   |
|------------|---|
| 7:0<br>NCL | Noise Count Limit – The Noise Count Limit determines the number of samples consecutively greater than the Max Half Delta necessary before it can be determined that it is non-noise.<br>00000000 Encoding 0 – Sets the Noise Count Limit to 1 (every time over Max Half Delta)<br>00000001 Encoding 1 – Sets the Noise Count Limit to 2 consecutive samples over Max Half Delta<br>~<br>11111111 Encoding 255 – Sets the Noise Count Limit to 255 consecutive samples over Max Half Delta |

## FILTER DELAY LIMIT (FDL)

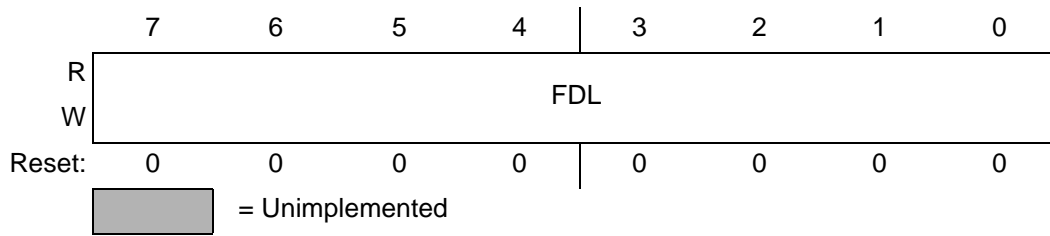

Figure 27. Filter Delay Limit Register

Table 25. Filter Delay Limit Register Field Descriptions

| Field      | Description   |
|------------|---|
| 7:0<br>FDL | Filter Delay Limit – The Filter Delay Limit determines the rate of operation of the filter. A larger number makes it operate slower.<br>00000000 Encoding 0 – Sets the Filter Delay Limit to 1<br>00000001 Encoding 1 – Sets the Filter Delay Limit to 2<br>~<br>11111111 Encoding 255 – Sets the Filter Delay Limit to 255 |

Additionally there are different conditions in the system that affects how these registers operate. These are rising data, falling data or touched data. When the data changes between these conditions, the current filter process is cancelled and all filter counters return to zero.

The operation of the filter is in the relationship between the 2<sup>nd</sup> filter data and the baseline filter value. The occurrence of a touch will also change the operation of the system. The touch generation process is described in the application note AN3892. The falling data system is enabled any time the 2<sup>nd</sup> filter data is less than the baseline filter data. The rising data system is enabled any time the 2<sup>nd</sup> filter data is greater than the baseline filter data. The following cases describe the baseline system when it is not changing between the three states mentioned above.

### Case 1

Small incremental changes to the system represent long term slow (environmental) changes in the system. The MHD setting regulates this case by allowing any data that is less than two times the MHD to pass the filter. Thus, if the baseline is 700 and the data is 701 with a MHD of one, then the baseline filter would increase to equal the data for the next cycle.

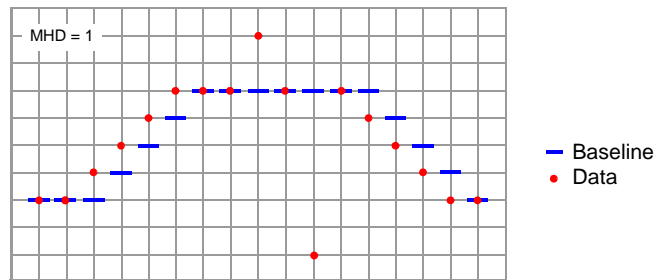

Figure 28. Max Half Delta

## Case 2

Changes that are larger than double the MHD are regarded as noise and accounted for by the values of the NHD and NCL. Any data outside the MHD is rejected by the filter however sequential values that fall into this category are counted and if enough sequential data exists then the baseline will be adjusted.

In this case, the NCL regulates how many sequential data points must be seen before the data is changed. When the count is reached, the baseline is incremented by the NHD.

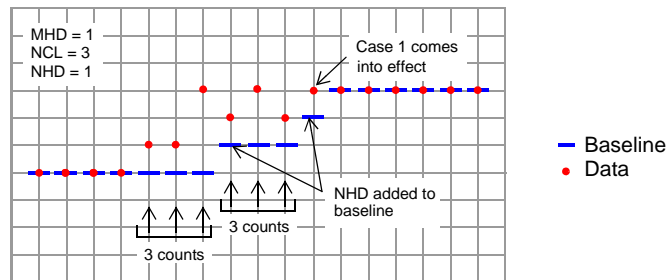

Figure 29.

## Case 3

When the data is inconsistent but greater than double than MHD the baseline will not vary. Each time a transition takes place, the filter counters are reset, thus the fact that the data is oscillating around the baseline means that the noise is rejected and the baseline will not vary.

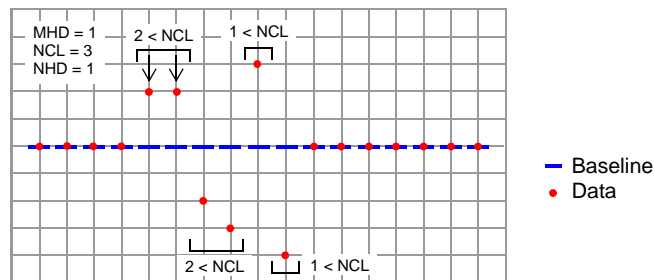

Figure 30.

## Case 4

Low frequency changes to the data can trick the filter in some instances. The FDL is also available to slow down the overall system. This is done by taking an average of the specified number of values before running them through the baseline filter.

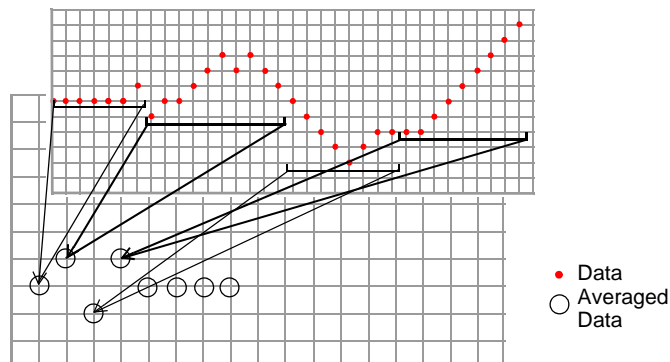

Figure 31.

After this averaging the filter reacts to Cases 1, 2, and 3.

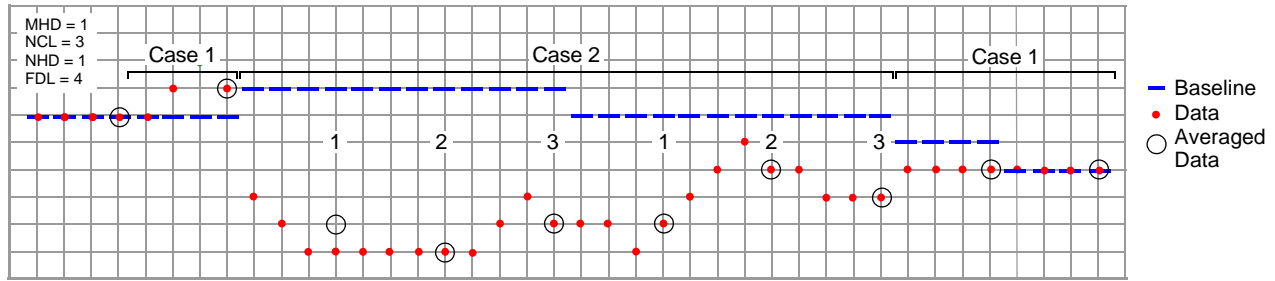

Figure 32.

## ADVANCED CASES

With an understanding of the basic cases, more advanced cases can be discussed. In a touch sensor system, we can take advantage of some known properties to improve the functionality of the filter. These include direction of change, touch occurrence and the rate of touch. The first four cases are still utilized but more functionality is added. The following cases described how different settings are useful as opposed to what exactly the settings do, like cases 1-4.

### Case 5

The direction of change for a touch in the system is always negative. Thus the system takes advantage of this by allowing for varying parameters for different directions of change. Since a touch can only be in the decreasing direction, it is usually best to set the decreasing filter to be slower than the increasing one. This allows for automatic recovery from a bad baseline reading.

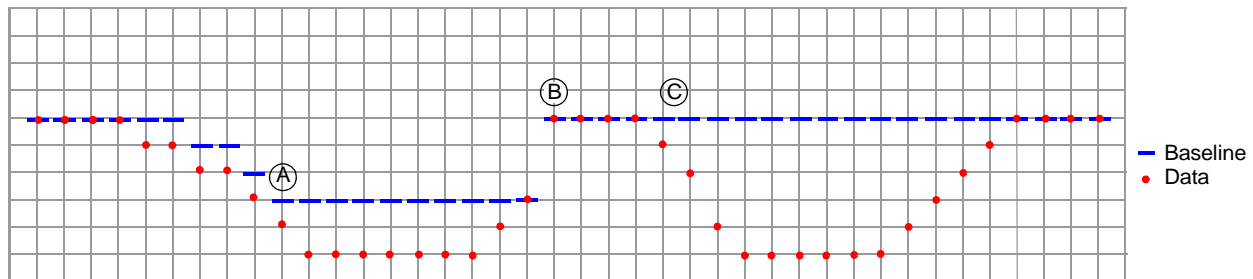

- A. As the touch occurs, the baseline is decreased slowly due to a non solid touch, but due to the slow reaction, a touch is still detected.
- B. The baseline quickly snaps back to the initial value by having fast filtering in the positive direction
- C. The repeated touch is easily handled since the baseline quickly adjusted; if it was slow, the second touch would have resulted in a possible false negative for a touch detection.

Figure 33.

## Case 6

The system needs the capability to handle environment changes that appear very similar to actual touches. In Case 5, the touch was a real touch, but slow enough that initially it is thought better for the baseline not to change at all.

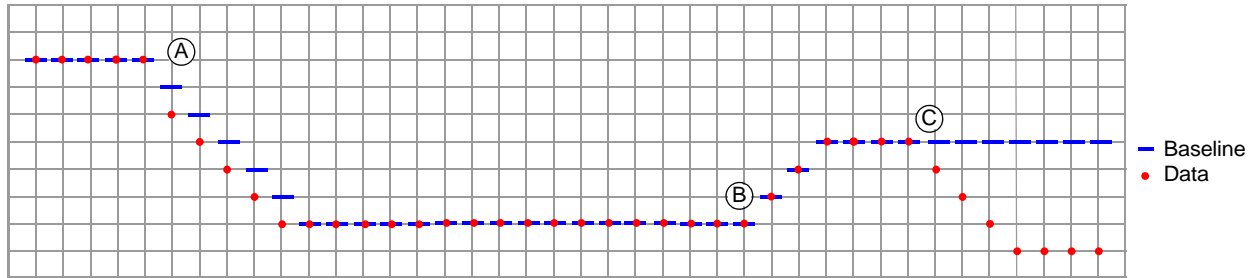

- A. The decrease is the interface being cleared with a wet rag, causing a relatively slow capacitance change. The baseline accurately tracks this slow change.
- B. The baseline begins to increase as the interface becomes dry.
- C. A delta from the new baseline allows a touch to be accurately detected.

Figure 34.

## Case 7

This case is when a touch is occurring. While the baseline system does not detect a touch, it is obviously an important part of the process. The baseline can be set to slowly calibrate a touch from the system preventing keys from becoming stuck. Only the NHD, NCL and FDL are necessary since the value can never be less than double the MHD.

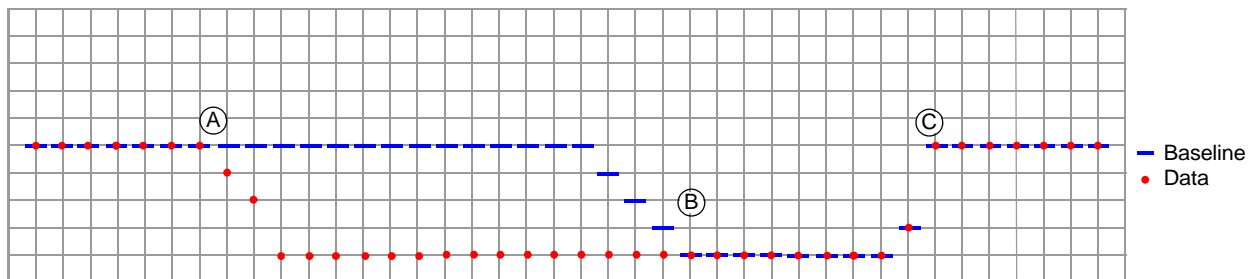

- A. The touch is detected which disengages the increasing/decreasing baseline filter but leaves it enabled with very slow filtering
- B. Even though the touch has not been released it times out and is eventually rejected.
- C. Normal baseline filter is engaged.

Figure 35.

## Case 8

This case can also prevent keys from being stuck due to misuse. For example, if a metal pen touches a button, this may initially engage the button but the pen is calibrated out over time and, normal function resumes. The same applies to water, food humid environments and other instances that generate capacitance change.

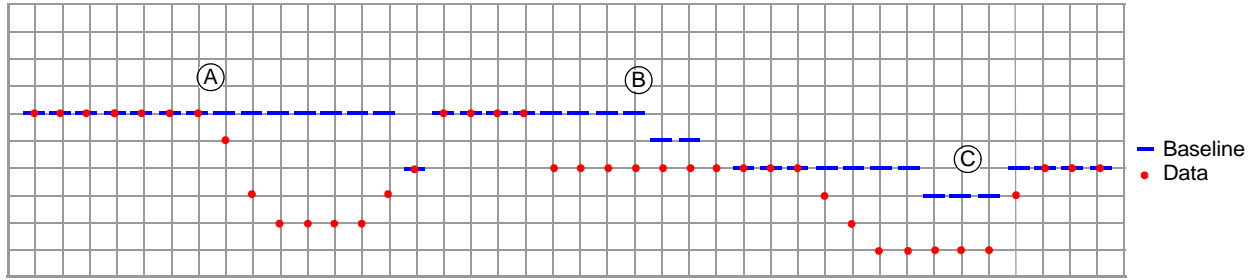

- A. Valid normal touch
- B. False touch filtered out
- C. Touch from new adjusted baseline

Figure 36.



# AN3892: MPR121 Jitter and False Touch Detection

## INTRODUCTION

Touch acquisition takes a few different parts of the system in order to detect touch. The baseline filter and touch detection are tightly coupled. The purpose of the touch detection block is to use the baseline value and the 2nd level filter data to determine when a user has touched an electrode. The electrodes are independently configured using the Touch Threshold and Release Threshold registers. The global Debounce register also controls when a touch is detected by adding some minimal delay. The data is then output through a couple of registers: Filtered Data High, Filtered Data Low, Baseline Data and two touch output registers.

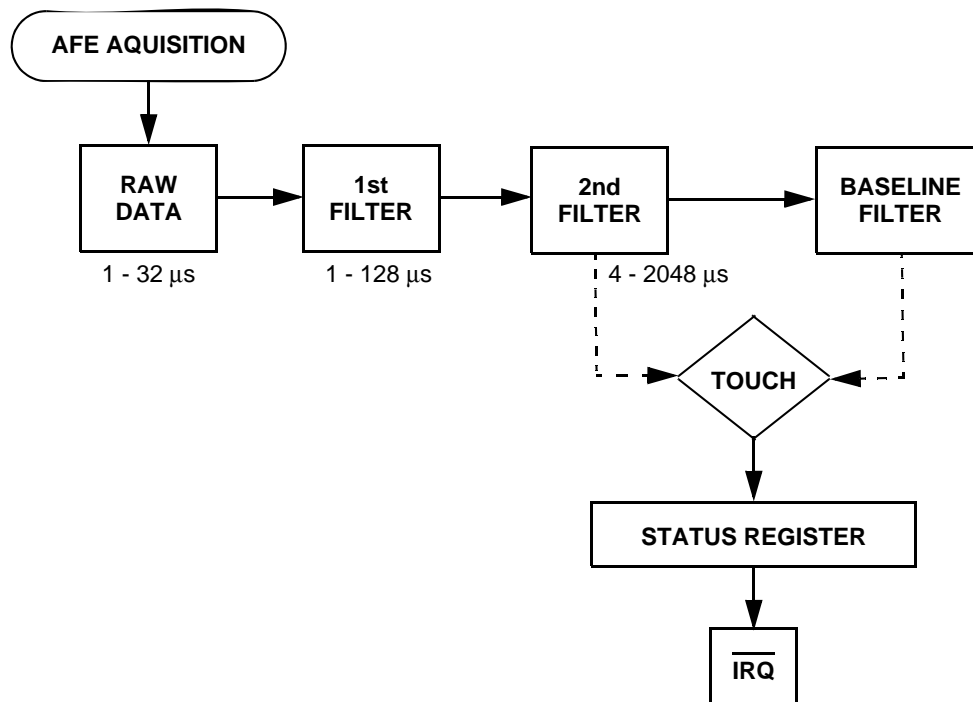

Figure 37. Data Flow in the MPR121

First, the MPR121 touch sensor detects touch by the methods in this application note, and the data is output through the first two registers in the map. The two touch status registers both trigger an interrupt on any change of the data. Thus, as a touch happens (bit is set) an interrupt will be triggered, and when a touch is released (bit is cleared) it will also trigger. To clear the interrupt all you must do is initiate a I2C communication, with the intent that you read register 0x00 and 0x01 to determine which electrodes are touched.

## TOUCH STATUS REGISTER 0

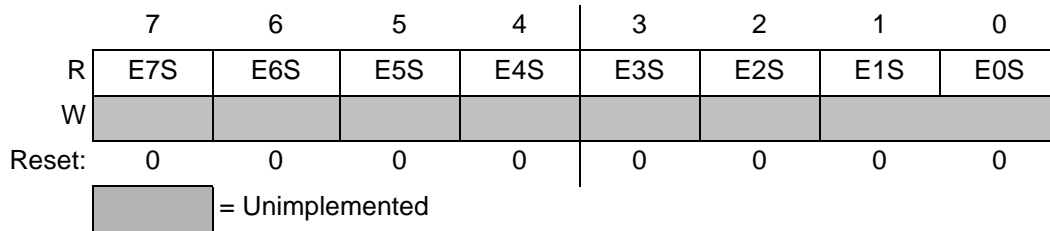

Figure 38. Touch Status Register 0

Table 26. Touch Status Register 0 Field Descriptions

| Field    | Description   |
|----------|---|
| 7<br>E7S | Electrode 7 Status – The Electrode 7 Status bit shows touched or not touched.<br>0 – Not Touched<br>1 – Touched |
| 6<br>E6S | Electrode 6 Status – The Electrode 6 Status bit shows touched or not touched.<br>0 – Not Touched<br>1 – Touched |
| 5<br>E5S | Electrode 5 Status – The Electrode 5 Status bit shows touched or not touched.<br>0 – Not Touched<br>1 – Touched |
| 4<br>E4S | Electrode 4 Status – The Electrode 4 Status bit shows touched or not touched.<br>0 – Not Touched<br>1 – Touched |
| 3<br>E3S | Electrode 3 Status – The Electrode 3 Status bit shows touched or not touched.<br>0 – Not Touched<br>1 – Touched |
| 2<br>E2S | Electrode 2 Status – The Electrode 2 Status bit shows touched or not touched.<br>0 – Not Touched<br>1 – Touched |
| 1<br>E1S | Electrode 1 Status – The Electrode 1 Status bit shows touched or not touched.<br>0 – Not Touched<br>1 – Touched |
| 0<br>E0S | Electrode 0 Status – The Electrode 0 Status bit shows touched or not touched.<br>0 – Not Touched<br>1 – Touched |

## TOUCH STATUS REGISTER 1

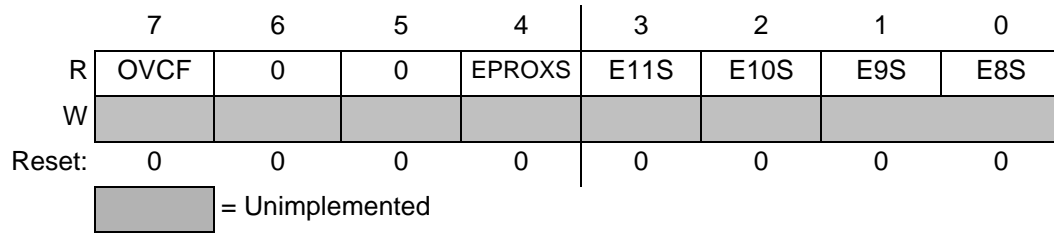

Figure 39. Touch Status Register1

Table 27. Touch Status Register 1 Field Descriptions

| Field       | Description   |
|-------------|---|
| 7<br>OVCF   | Over Current Flag – The Over Current Flag will be set any time the wrong value of Rext is connected to the MPR121's Rext pin. This is to protect the part from high current that could result from an incorrect resistor value.<br>0 – Correct Rext resistor value<br>1 – Incorrect Rext resistor value |
| 4<br>EPROXS | Electrode PROX Status – The Electrode PROX Status bit shows touched nor not touched.<br>0 – Not Touched<br>1 – Touched  |
| 3<br>E11S   | Electrode 11 Status – The Electrode 11 Status bit shows touched or not touched.<br>0 – Not Touched<br>1 – Touched   |
| 2<br>E10S   | Electrode 10 Status – The Electrode 10 Status bit shows touched or not touched.<br>0 – Not Touched<br>1 – Touched   |
| 1<br>E9S    | Electrode 9 Status – The Electrode 9 Status bit shows touched or not touched.<br>0 – Not Touched<br>1 – Touched   |
| 0<br>E8S    | Electrode 8 Status – The Electrode 8 Status bit shows touched or not touched.<br>0 – Not Touched<br>1 – Touched   |

## FILTER DATA HIGH

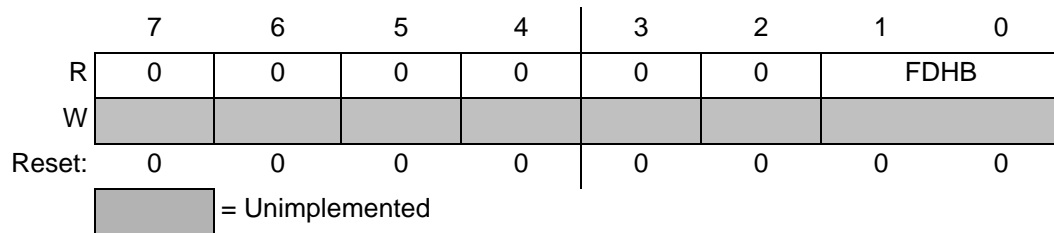

Figure 40. Filtered Data High Register

Table 28. Filtered Data High Register Field Descriptions

| Field       | Description   |
|-------------|---|
| 7:0<br>FDHB | Filtered Data High Bits – The Filtered Data High Bits displays the higher 2 bits of the 10 bit filtered A/D reading.<br>00 Encoding 0<br>~<br>11 Encoding 3 |

## FILTERED DATA LOW

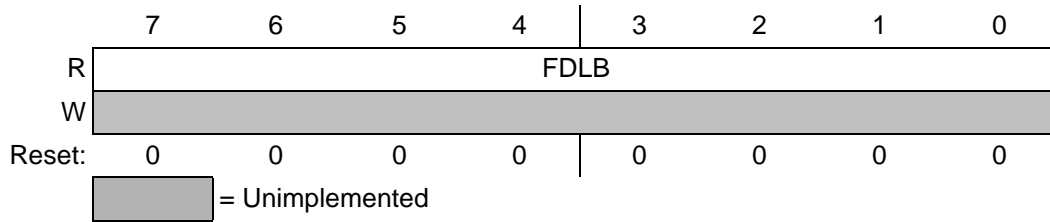

Figure 41. Filtered Data Low Register

Table 29. Filtered Data Low Register Field Descriptions

| Field       | Description  |
|-------------|--|
| 7:0<br>FDLB | Filtered Data Low Byte – The Filtered Data Low Byte displays the lower 8 bits of the 10 bit filtered A/D reading.<br>00000000 Encoding 0<br>~<br>11111111 Encoding 255 |

## BASELINE VALUE

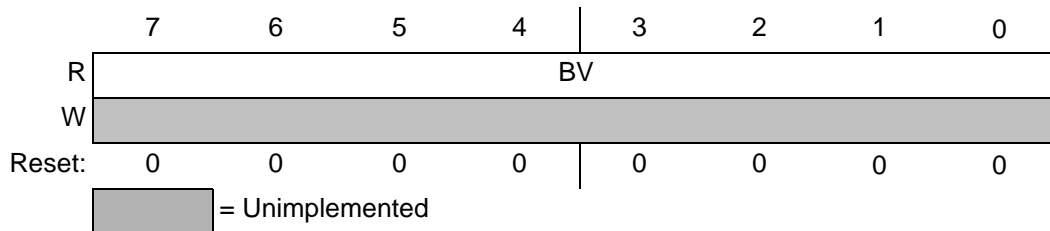

Figure 42. Filtered Data High Register

Table 30. Filtered Data High Register Field Descriptions

| Field     | Description  |
|-----------|--|
| 7:0<br>BV | Baseline Value – The Baseline Value byte displays the higher 8 bits of the 10 bit baseline value.<br>00000000 Encoding 0 – The 10 bit baseline value is between 0 and 3.<br>~<br>11111111 Encoding 255 – The 10 bit baseline value is between 1020 and 1023. |

In this system, a touch is defined as any time the difference between the Filtered Data and the Baseline Value is greater than the threshold. Since this calculation is done totally internal to the part, it is unnecessary for the user to actually do this math in the software. If it were being done, the steps would be to first combine the Filtered Data Low and Filtered Data High values into a single 10-bit number. Thus,

$$Data = Filtered\ Data\ High \cdot 256 + Filtered\ Data\ Low$$

The baseline is then shifted to the left to make it equal scale to the Data.

$$Baseline = Baseline\ Value \cdot 4$$

Internally to the device, the full 10-bit value is stored, but as this level of precision is not necessary as the low two bits are disregarded for output. The Touch Threshold is a user defined value. There is both a touch and an un-touch threshold to provide hysteresis.

## TOUCH THRESHOLD REGISTER

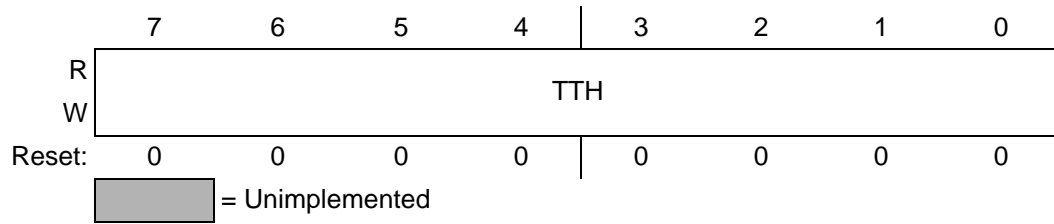

Figure 43. Touch Threshold Register

Table 31. Touch Threshold Register Field Descriptions

| Field      | Description  |
|------------|--|
| 7:0<br>TTH | Touch Threshold – The Touch Threshold Byte sets the trip point for detecting a touch.<br>00000000 Encoding 0<br>~<br>11111111 Encoding 255 |

## RELEASE THRESHOLD REGISTER

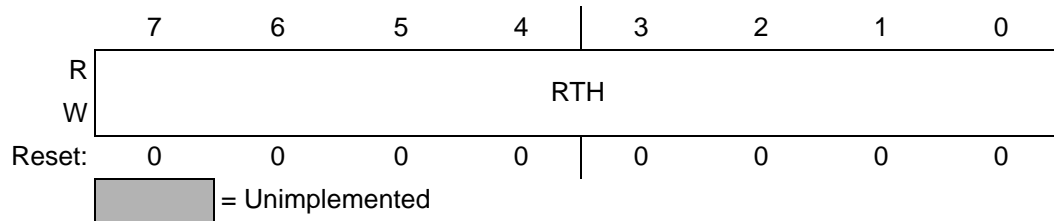

Figure 44. Release Threshold Register

Table 32. Release Threshold Register Field Descriptions

| Field      | Description  |
|------------|--|
| 7:0<br>RTH | Release Threshold – The Release Threshold Byte sets the trip point for detecting a touch.<br>00000000 Encoding 0<br>~<br>11111111 Encoding 255 |

For the system to recognize a touch the delta must be greater than the Touch Threshold.

$$\Delta = \text{Baseline} - \text{Data}$$

$$\text{Trigger Touch} \rightarrow \Delta > \text{Touch Threshold}$$

A release is triggered when the Delta falls below the Release Threshold. This can happen for both changes to the Baseline and actual Data changes. To understand how the Baseline can change, refer to AN3891.

$$\text{Trigger Release} \rightarrow \Delta < \text{Touch Threshold}$$

### DEBOUNCE TOUCH AND RELEASE REGISTER

The last register available in this set is the Debounce register. The Debounce register maintains the accuracy of touch and releases by further improving the performance. The debounce allows two different settings to prevent bounce in the end system. If the value is set to 0x22, the requirement would be three sequential changes in status before the change would be recognized.

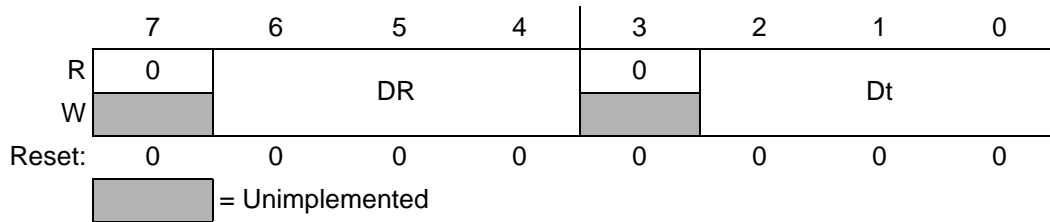

Figure 45. Debounce Touch and Release Register

Table 33. Debounce Touch and Release Register Field Descriptions

| Field     | Description  |
|-----------|--|
| 6:4<br>DR | Debounce Release – The Debounce Release determines the number of sequential release detections before an interrupt is triggered and a release is reported.<br>000 Encoding 0 - Consecutive releases detection before Status change is 1<br>001 Encoding 1 - Consecutive releases detection before Status change is 2<br>~<br>007 Encoding 7 - Consecutive releases detection before Status change is 8 |
| 2:0<br>DT | Debounce Touch – The Debounce Touch determines the number of sequential touch detections before an interrupt is triggered and a touch is reported.<br>000 Encoding 0 - Consecutive touch detection before Status change is 1<br>001 Encoding 1 - Consecutive touch detection before Status change is 2<br>~<br>007 Encoding 7 - Consecutive touch detection before Status change is 8                  |

### CONCLUSION

The use of each of the features together can have a great effect of the jitter and false couch rejection. Jitter is prevented by utilizing the two threshold settings. Thus the provided hysteresis prevent Jitter on the data from going through the to the output. Depending on environmental conditions, the Debounce can be used to eliminate the remainder of dramatic change of the signal that aren't really touches.

Additional filtering can be done before the data gets to the touch detection system. Refer to Freescale Application Note AN3890.

# AN3893: MPR121 Proximity Detection

## INTRODUCTION

MPR121 is a feature rich, second generation touch sensor controller after Freescale's initial release of the MPR03x series device. Like MPR03x, MPR121 has a unique feature that all the electrode inputs can be internally connected together so that all the surface touch sensing area on the inputs are “summed” together to act as a single large electrode pad. This can effectively increase the total area of the sensing conductor for non-contact near proximity detection for hand approaching.

## OVERVIEW

Capacitive proximity detection uses the same principle as capacitive touch sensing. Each MPR121 input sensing channel can be used as contactless proximity detection as well as finger touch detection if each sensing pad is designed properly and relevant register are set properly.

Typically a smaller pad size is used for finger touch button detection; while a larger pad size is necessary for contactless near proximity detection. On the other side, it's true that in most portable application design there is no dedicated big surface area left for proximity detection as the touch sensing buttons occupy all the available surface area. To make proximity detection at the same time of touch detection without additional dedicated large sensing pad, MPR121 has an internal input multiplexor which can connect all input sensing channels together so that all the touch sensing surface areas on the input pads are “summed” together effectively acting as a single large sensing pad.

Using this scheme in typical applications, the 12 channels can be used for 12 key buttons touch sensing, and the surface area of all the pads can also used for proximity detection (e.g., hand approaching).

## PROXIMITY DETECTION REGISTER SETTING

Like each independent touch sensing detection, the 13th Proximity Detection electrode also has its own register configurations, other than that, all the concepts applied to the proximity detection are the same as touch sensing detection.

### 1.0 Enable Proximity Sensing

Proximity detection (a/k/a area detection mode) is enabled by configuring the Electrode Configuration Register (0x5E), see [Table 34](#). In MPR121, this adds an area detection step (the 13<sup>th</sup> pseudo Electrode) before all the independent electrodes touch sensing detect sequence. Once configured, we refer to this area detection as the 13th Proximity Detection electrode.

**Table 34. Electrode Configuration Register 0x5E (Reset Default: 0x00)**

| Bit   | Bit7  | Bit6  | Bit5  | Bit4  | Bit3  | Bit2  | Bit1  | Bit0  |
|-------|-------|-------|-------|-------|-------|-------|-------|-------|
| Read  | CL[1] | CL[0] | AD[1] | AD[0] | EC[3] | EC[2] | EC[1] | EC[0] |
| Write |       |       |       |       |       |       |       |       |
| Reset | 0     | 0     | 0     | 0     | 0     | 0     | 0     | 0     |

| AD1 | AD0 | EC3 | EC2 | EC1 | EC0 | Description                           |
|-----|-----|-----|-----|-----|-----|---------------------------------------|
| 0   | 1   | x   | x   | x   | x   | Area Detection by connecting ELE0~1.  |
| 1   | 0   | x   | x   | x   | x   | Area Detection by connecting ELE0~3.  |
| 1   | 1   | x   | x   | x   | x   | Area Detection by connecting ELE0~11. |

### 2.0 Proximity Data Register and Baseline Register

Eleprox Electrode Registers (0x1C, 0x2D) contain the 10-bit raw data of the capacitance-voltage measurement value for the 13<sup>th</sup> Proximity Detection electrode.

**Table 35. Eleprox Electrode Register 0x1C, 0x2D (Reset Default: 0x00, 0x00)**

| 0x1C | Bit7 | Bit6 | Bit5 | Bit4 | Bit3 | Bit2 | Bit1 | Bit0 |
|------|------|------|------|------|------|------|------|------|
|      | D7   | D6   | D5   | D4   | D3   | D2   | D1   | D0   |

| 0x1D | Bit7 | Bit6 | Bit5 | Bit4 | Bit3 | Bit2 | Bit1 | Bit0 |
|------|------|------|------|------|------|------|------|------|
|      | —    | —    | —    | —    | —    | —    | D9   | D8   |

Eleprox Baseline Value Register (0x2A) contains the 8 MSBs of the 10-bit baseline value for the 13<sup>th</sup> Proximity Detection electrode. Writing to Baseline Value Register updates the 8 MSBs of baseline value and clears the 2 LSBs to zero. The Baseline Value Registers can only be written when in Shutdown Mode, but the current values may be read at any time.

**Table 36. Eleprox Baseline Value Register 0x2A (Reset Default: 0x00)**

| 0x2A | Bit7 | Bit6 | Bit5 | Bit4 | Bit3 | Bit2 | Bit1 | Bit0 |
|------|------|------|------|------|------|------|------|------|
|      | D9   | D8   | D7   | D6   | D5   | D4   | D3   | D2   |

### 3.0 Proximity Sensing Status Indication

MPR121 provides a single proximity sensing status bit (ELE[12] in table below) in the Touch Status Register. This status bit changes as a result of internal detection algorithm using the proximity raw data with the proximity baseline value and proximity touch/release threshold setting. When ELE[12] is set, the proximity is deemed as detected, and undetected when ELE[12] is 0.

**Table 37. Status Register 0x00, 0x01 (Reset Default: 0x00)**

| 0x00 | Bit7   | Bit6   | Bit5   | Bit4   | Bit3   | Bit2   | Bit1   | Bit0   |
|------|--------|--------|--------|--------|--------|--------|--------|--------|
|      | ELE[7] | ELE[6] | ELE[5] | ELE[4] | ELE[3] | ELE[2] | ELE[1] | ELE[0] |

| 0x01 | Bit7 | Bit6 | Bit5 | Bit4    | Bit3    | Bit2    | Bit1   | Bit0   |
|------|------|------|------|---------|---------|---------|--------|--------|
|      | OVCF | 0    | 0    | ELE[12] | ELE[11] | ELE[10] | ELE[9] | ELE[8] |

The update rate of this status bit will be determined by sampling rate and detection debounce setting. The status bit will not immediately change if the Debounce Register is non zero. This Debounce Register is globally effective to prevent possible flick noise for both touch and proximity sensing. The value in the Debounce Register determines how many numbers of sample intervals are needed to pass at the touch/release threshold before the status bit is finally changed.

**Table 38. Debounce Register 0x5B (Reset Default: 0x00)**

| 0x5B | Bit7 | Bit6  | Bit5  | Bit4  | Bit3 | Bit2  | Bit1  | Bit0  |
|------|------|-------|-------|-------|------|-------|-------|-------|
|      | X    | DR[2] | DR[1] | DR[0] | X    | DT[2] | DT[1] | DT[0] |

On ELEPROX status bit change, the interrupt pin will be asserted.

### 4.0 Proximity Detection Touch/Release Threshold

Similar to the touch/release threshold for touch detection, the proximity detection also has a pair of touch/release threshold setting registers. The programmable threshold setting range is 0~63 count, representing the delta change below the baseline value when touched or released. The Threshold should be set according to the system SNR requirement and also provide adequate headroom for mass production variation. For normal application, set Touch Threshold slightly larger than Release Threshold so that there is no flick detection.

**Example:** Touch Threshold = 0x08, Release Threshold = 0x05.

**Table 39. Eleprox Touch Threshold Register 0x59 (Reset Default: 0x00)**

| 0x59 | Bit7 | Bit6 | Bit5 | Bit4 | Bit3 | Bit2 | Bit1 | Bit0 |
|------|------|------|------|------|------|------|------|------|
|      | D7   | D6   | D5   | D4   | D3   | D2   | D1   | D0   |

**Table 40. Eleprox Release Threshold Register 0x5A (Reset Default: 0x00)**

| 0x5A | Bit7 | Bit6 | Bit5 | Bit4 | Bit3 | Bit2 | Bit1 | Bit0 |
|------|------|------|------|------|------|------|------|------|
|      | D7   | D6   | D5   | D4   | D3   | D2   | D1   | D0   |



## 5.0 Proximity Baseline Filter Setting

As with the touch detection, the proximity detection also dedicates register sets for baseline filter control. These include the maximum half delta for rising/falling, the noise half delta for rising/falling/touched, the noise count limit for rising/falling/touched, and filter delay for rising/falling/touched. Table 41 shows an example setting for proximity sensing, the concept is to have quickest response on baseline rising (when hand takes away) and slowest response on baseline falling (when hand approaching). Refer to Freescale application note AN3891 for detailed description on baseline system.

**Table 41. Proximity Baseline Filter Registers 0x36~0x40 (Reset Default: all 0x00)**

| Register Name                           | Register Address | Example Setting |
|---|------------------|-----------------|
| ELEPROX Max Half Delta Rising           | 0x36             | 0xFF            |
| ELEPROX Noise Half Delta Amount Rising  | 0x37             | 0xFF            |
| ELEPROX Noise Count Limit Rising        | 0x38             | 0x00            |
| ELEPROX Filter Delay Limit Rising       | 0x39             | 0x00            |
| ELEPROX Max Half Delta Falling          | 0x3A             | 0x01            |
| ELEPROX Noise Half Delta Amount Falling | 0x3B             | 0x01            |
| ELEPROX Noise Count Limit Falling       | 0x3C             | 0xFF            |
| ELEPROX Filter Delay Limit Falling      | 0x3D             | 0xFF            |
| ELEPROX Noise Half Delta Amount Touched | 0x3E             | 0x00            |
| ELEPROX Noise Count Limit Touched       | 0x3F             | 0x00            |
| ELEPROX Filter Delay Limit Touched      | 0x40             | 0x00            |

## 6.0 Electrode Configuration for Proximity Sensing

Same as touch sensing, the proximity sensing requires that the charging current and time for the 13th Proximity Detection electrode to be properly set. This can be done in 3 ways:

1. Globally setting the AFE Configuration Register (0x5B) and Filter Configuration Register if recent current setting and time setting is zero.
2. Set by using Eleprox Electrode Current Register (0x6B) and Charge Time Register (0x72).
3. Using Auto-Configuration function to automatically set charge current and charge time for this 13th Proximity Detection electrode.

It's recommended that Auto-Configuration is used for design efficiency if proximity sensing works properly in this way. Refer to Freescale application note AN3889 for details of the Auto-Configuration function.

## 7.0 AFE and Filter Configuration Register

The last two registers relevant to proximity detection are the AFE Configuration Register and Filter Configuration Register. These two registers set the numbers of samples for the 2 level filters and the sampling interval for the second level filter.

**Table 42. Filter Configuration Registers 0x5D (Reset Default: 0x24)**

| 0x5D | Bit7     | Bit6 | Bit5 | Bit4     | Bit3 | Bit2     | Bit1 | Bit0 |
|------|----------|------|------|----------|------|----------|------|------|
|      | CDT[2:0] |      |      | SFI[1:0] |      | ESI[2:0] |      |      |

**Table 43. AFE Configuration Registers 0x5C (Reset Default: 0x10)**

| 0x5C | Bit7     | Bit6 | Bit5     | Bit4 | Bit3 | Bit2 | Bit1 | Bit0 |
|------|----------|------|----------|------|------|------|------|------|
|      | FFI[1:0] |      | CDC[4:0] |      |      |      |      |      |

The FFI[1:0], SFI[1:0] and ESI[2:0] bits in the registers are those related to the first filter, second filter and sample interval respectively. These two registers are powered up with default setting of 0x24 and 0x10 respectively. The default setting is already workable for proximity sensing, but since ESI[2:0] is 100, the sampling interval is at 16 ms. If lower power consumption is desired, the user can adjust it to the value to find a balance between the proximity detection response time current consumption. For a detailed explanation on these registers, please refer to Freescale application note AN3890.

### OTHER DESIGN CONSIDERATIONS

1. Remember the paralleled plate capacitor model when considering the proximity detection. Larger sensing area (the effective sensing area formed by the sensing pad and material under detection, e.g. the surface area of hand projected to the sensing pad) gives longer proximity sensing distance.
2. The electric energy store in the capacitance (thus the strength of the sensing field) is proportional to the square of the voltage potential applied. Setting the auto-configure target level as high as possible will help extend the proximity sensing range.
3. Since increasing the sensing pad area also has the problem of making it easier to receive the electric noise. It's possible that the original solid sensing pad can be replaced by a series of circles or x hatch patterns.

Refer to Freescale application note AN3863 for more detailed discussion on electrode and layout design considerations.

# AN3894: MPR121 GPIO and LED Driver Function

## INTRODUCTION

MPR121 is a feature rich second generation touch sensor controller after Freescale's initial release of the MPR03x series device. MPR121 not only has priority unique features like independent electrode auto configuration (refer to AN3889), 13th simulated pseudo electrode for proximity detection (refer to AN3893), it also has 8 GPIO ports with LED driver capability. The GPIO and LED driver function can be used when not all the 12 input sensing channels are occupied for touch sensing detection, which is made possible by internal multiplexed pin structure. This increases the cost efficiency of the system and makes the MPR121 fit for even wider application.

## MULTIFUNCTION PINS

MPR121 has 12 input sensing channels ELE0~ELE11, which occupies pin 8 to pin 19. Among these, pin 12 to pin 19 are multifunction pins. When these multifunction pins are not configured as electrodes, they may be used to drive LED or for general GPIO purpose.

| PIN #     | 8    | 9    | 10   | 11   | 12    | 13    | 14    | 15    | 16    | 17    | 18    | 19    |
|-----------|------|------|------|------|-------|-------|-------|-------|-------|-------|-------|-------|
| ELECTRODE | ELE0 | ELE1 | ELE2 | ELE3 | ELE4  | ELE5  | ELE6  | ELE7  | ELE8  | ELE9  | ELE10 | ELE11 |
| GPIO      | —    | —    | —    | —    | GPIO0 | GPIO1 | GPIO2 | GPIO3 | GPIO4 | GPIO5 | GPIO6 | GPIO7 |

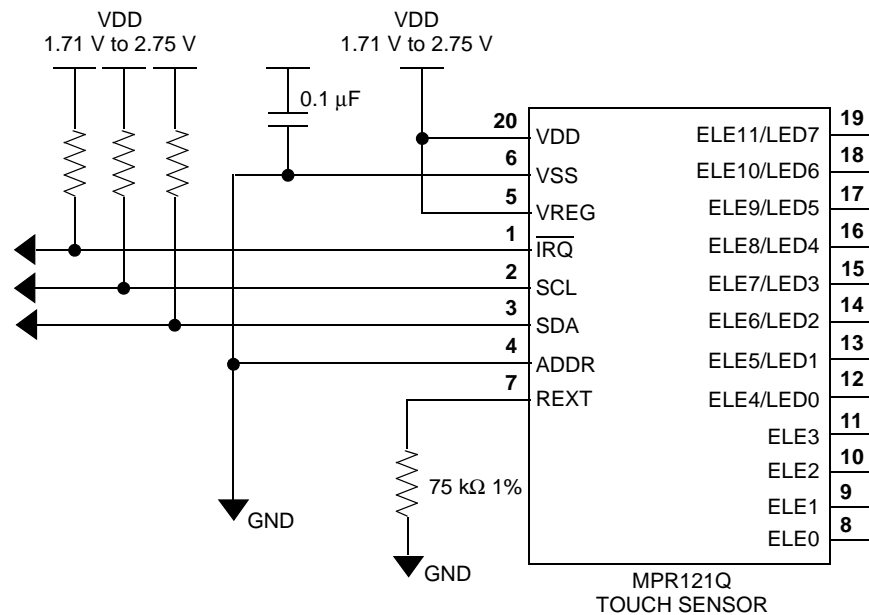
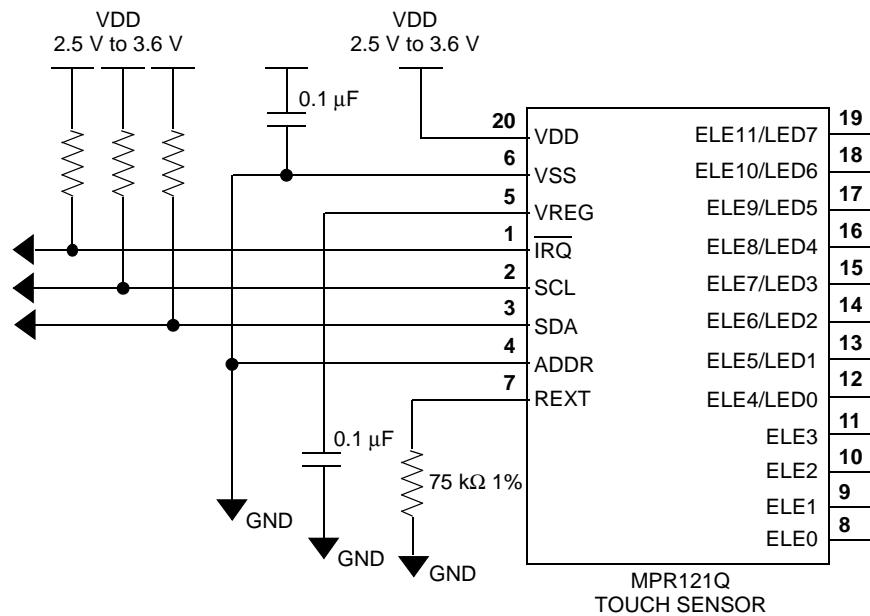

Figure 46. Configuration 1: MPR121 runs from a 1.71 V to 2.75 V supply.



**Figure 47. Configuration 2: MPR121 runs from a 2.5 V to 3.6 V supply.**

These registers control GPIO function. D7~D0 bits corresponds GPIO7~GPIO0 pins respectively. The GPIO control registers can write always regardless Shutdown and Run mode.

**Table 44. GPIO Control Registers**

| Name             | Address | D7      | D6      | D5      | D4      | D3      | D2      | D1      | D0      |
|------------------|---------|---------|---------|---------|---------|---------|---------|---------|---------|
| GPIO Control 0   | 0x73    | CTL0[7] | CTL0[6] | CTL0[5] | CTL0[4] | CTL0[3] | CTL0[2] | CTL0[1] | CTL0[0] |
| GPIO Control 1   | 0x74    | CTL1[7] | CTL1[6] | CTL1[5] | CTL1[4] | CTL1[3] | CTL1[2] | CTL1[1] | CTL1[0] |
| GPIO Data        | 0x75    | DAT[7]  | DAT[6]  | DAT[5]  | DAT[4]  | DAT[3]  | DAT[2]  | DAT[1]  | DAT[0]  |
| GPIO Direction   | 0x76    | DIR[7]  | DIR[6]  | DIR[5]  | DIR[4]  | DIR[3]  | DIR[2]  | DIR[1]  | DIR[0]  |
| GPIO Enable      | 0x77    | EN[7]   | EN[6]   | EN[5]   | EN[4]   | EN[3]   | EN[2]   | EN[1]   | EN[0]   |
| GPIO Data Set    | 0x78    | SET[7]  | SET[6]  | SET[5]  | SET[4]  | SET[3]  | SET[2]  | SET[1]  | SET[0]  |
| GPIO Data Clear  | 0x79    | CLR[7]  | CLR[6]  | CLR[5]  | CLR[4]  | CLR[3]  | CLR[2]  | CLR[1]  | CLR[0]  |
| GPIO Data Toggle | 0x7A    | TOG[7]  | TOG[6]  | TOG[5]  | TOG[4]  | TOG[3]  | TOG[2]  | TOG[1]  | TOG[0]  |

**EN[7:0], DIR[7:0], CTL0[7:0], CTL1[7:0]: Configuration Register**

The number of touch sensing electrodes (and therefore the number of GPIO ports available) is configured by the Electrode Configuration register (0x5E) and GPIO Enable Register (0x77), but electrode configuration has higher priority than GPIO feature. When a pin is enabled as GPIO but is also selected as electrode by Electrode Configuration Register, the GPIO function is disabled immediately and it becomes an electrode during Run mode. But all 8 ports automatically become GPIO ports in Shutdown mode because none of the ports are being enabled as touch electrodes in Shutdown mode.

During the shutdown mode just after power on reset, all 8 GPIO ports are in high impedance as all the GPIO ports are default disabled. Take care to program unused ports which are not going to be used as either touch electrodes or GPIO to avoid floating inputs or outputs shorted to a rail. One approach is to enable unused ports to be GPIO inputs with internal pull-up or pull-down.

The GPIO system allows the GPIO pins to be set as input or output. When an EN bit sets, the corresponding GPIO pin is enabled and the function is configured by CTL0, CTL1 and DIR bits. When the port is used as input, it can be configured as normal input or with additional internal pull-down or pull-up for input port. For output configuration, it can be push/pull or open drain.

| EN | DIR | CTL[0:1] | DESCRIPTION   |
|----|-----|----------|---|
| 0  | X   | XX       | GPIO function is disabled. Port is high-z state.                        |
| 1  | 0   | 00       | GPIO port becomes input port.   |
| 1  | 0   | 10       | GPIO port becomes input port with internal pull-down.                   |
| 1  | 0   | 11       | GPIO port becomes input port with internal pull-up.                     |
| 1  | 0   | 01       | Not defined yet (as same as CTL = 00).                                  |
| 1  | 1   | 00       | GPIO port becomes CMOS output port.                                     |
| 1  | 1   | 11       | GPIO port becomes high side only open drain output port for LED driver. |
| 1  | 1   | 10       | GPIO port becomes low side only open drain output port.                 |
| 1  | 1   | 01       | Not defined yet (as same as CTL = 00).                                  |

#### DAT[7:0]: Data Register

When a GPIO is as output, the GPIO port outputs the bit level of this register. The output level toggle holds on any electrode charging and AD conversion and the level transition will be occurred after the AD conversion. Reading this register returns the content of the DAT register (not a level of the port).

When a GPIO is as input, reading this register returns latched input level of the corresponding port (not contents of the DAT register). A write changes content of the register, but not affect to the input function.

#### SET[7:0]: Set Data Register

Writing a "1" to bits in this register will set them in the Data Register.

#### CLR[7:0]: Clear Data Register

Writing a "1" to bits in this register will clear them in the Data Register.

#### TOG[7:0]: Toggle Data Register

Write a bit with "1" to the GPIO Data Set Register, GPIO Data Clear Register, and GPIO Toggle Register set/clear/toggle contents of the corresponding DAT bit. Write "0" has no meaning. Using of those registers allows any individual port(s) to be able individually set, cleared, or toggled without affecting other ports. Reading those register returns as same as DAT register reading.

#### LED DRIVER

Each GPIO pin has LED driver capability which can source up to 12 mA. When GPIO is used to driver LED, connect the GPIO output to an LED forward biased with its cathode to GND so that GPIO output high lights the LED. Place a current limiting resistor in series with LED to limit the current below 12 mA (refer to the typical application circuit).

When LED dimming control is needed, the PWM control register can be set to get the desired dimming control. Alternatively, the PWM can also be used to drive the beeper.

**Table 45. PWM\_[3:0]: PWM Duty Control Registers**

| Name         | Address     | D7      | D6      | D5      | D4      | D3      | D2      | D1      | D0      |
|--------------|-------------|---------|---------|---------|---------|---------|---------|---------|---------|
| <b>PWM 0</b> | <b>0x81</b> | PWM1[3] | PWM1[2] | PWM1[1] | PWM1[0] | PWM0[3] | PWM0[2] | PWM0[1] | PWM0[0] |
| <b>PWM 1</b> | <b>0x82</b> | PWM3[3] | PWM3[2] | PWM3[1] | PWM3[0] | PWM2[3] | PWM2[2] | PWM2[1] | PWM2[0] |
| <b>PWM 2</b> | <b>0x83</b> | PWM5[3] | PWM5[2] | PWM5[1] | PWM5[0] | PWM4[3] | PWM4[2] | PWM4[1] | PWM4[0] |
| <b>PWM 3</b> | <b>0x84</b> | PWM7[3] | PWM7[2] | PWM7[1] | PWM7[0] | PWM6[3] | PWM6[2] | PWM6[1] | PWM6[0] |

PWM0[3:0] ~ PWM7[3:0] is used to set the PWM duty of GPIO0 ~ GPIO7 respectively. The power up reset default setting for these four register is 0x00. When a GPIO is programmed as output and the DAT register is “1” and if the corresponding PWM\_[3:0] register is not zero, the GPIO pin outputs PWM waveform. The PWM period is fixed 8ms (1/256 of 32 KHz OSC) and PWM\_[3:0] register decides duty of the waveform.

| PWM_ [3:0] | Description (_ is 0-7)  |
|------------|---|
| 0          | PWM is off, GPIO outputs stable high when DAT register is “1” |
| 1          | GPIO output duty is 1:15 (mostly output low)                  |
| 2          | GPIO output duty is 2:14 (mostly output low)                  |
| —          | —   |
| 15         | GPIO output duty is 15:1 (mostly output high)                 |

These register can be read/write any time, even if MPR121 is in Run Mode. When the register changes during PWM enables, a mixed duty cycle would be possible to occur.

The PWM duty is not so much accurate, because GPIO output transition (include PWM) inhibits during measurement state. Therefore, when interval time (=Touch Detection Sample Interval) is close to measurement time (depends on charge time, AFE Samples and number of measurement electrodes), the PWM operation is disturbed and the waveform couldn't keep programmed duty.

# AN3895: MPR121 Serial Communication

## INTRODUCTION

The MPR121 uses an I<sup>2</sup>C Serial Interface. The I<sup>2</sup>C protocol implementation and the specifics of communicating with the Touch Sensor Controller are detailed in this application note.

## SERIAL-ADDRESSING

The MPR121 operates as a slave that sends and receives data through an I<sup>2</sup>C 2-wire interface. The interface uses a Serial Data Line (SDA) and a Serial Clock Line (SCL) to achieve bi-directional communication between master(s) and slave(s). A master (typically a microcontroller) initiates all data transfers to and from the MPR121, and it generates the SCL clock that synchronizes the data transfer.

The MPR121 SDA line operates as both an input and an open-drain output. A pull-up resistor, typically 4.7 k $\Omega$ , is required on SDA. The MPR121 SCL line operates only as an input. A pull-up resistor, typically 4.7 k $\Omega$ , is required on SCL if there are multiple masters on the 2-wire interface, or if the master in a single-master system has an open-drain SCL output.

Each transmission consists of a START condition (Figure 48) sent by a master, followed by the MPR121's 7-bit slave address plus R/W bit, a register address byte, one or more data bytes, and finally a STOP condition.

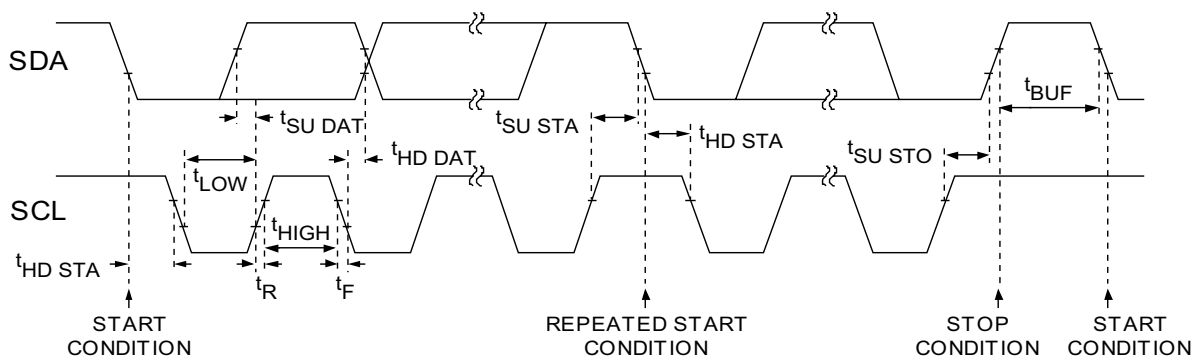

Figure 48. Wire Serial Interface Timing Details

## START AND STOP CONDITIONS

Both SCL and SDA remain high when the interface is not busy. A master signals the beginning of a transmission with a START (S) condition by transitioning SDA from high to low while SCL is high. When the master has finished communicating with the slave, it issues a STOP (P) condition by transitioning SDA from low to high while SCL is high. The bus is then free for another transmission.

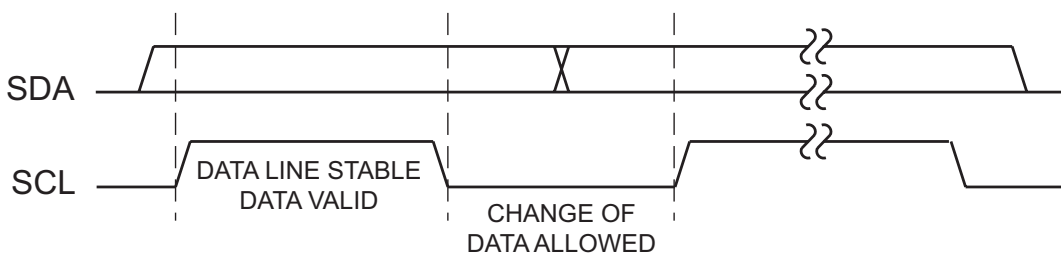

Figure 49. Start and Stop Conditions

## BIT TRANSFER

One data bit is transferred during each clock pulse (Figure 50). The data on SDA must remain stable while SCL is high.

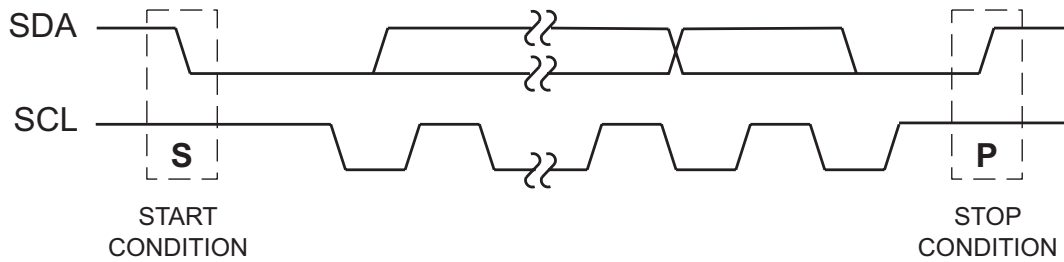

Figure 50. Bit Transfer

## ACKNOWLEDGE

The acknowledge bit is a clocked 9<sup>th</sup> bit (Figure 51) which the recipient uses to handshake receipt of each byte of data. Thus each byte transferred effectively requires 9 bits. The master generates the 9<sup>th</sup> clock pulse, and the recipient pulls down SDA during the acknowledge clock pulse, such that the SDA line is stable low during the high period of the clock pulse. When the master is transmitting to the MPR121, the MPR121 generates the acknowledge bit, since the MPR121 is the recipient. When the MPR121 is transmitting to the master, the master generates the acknowledge bit, since the master is the recipient.

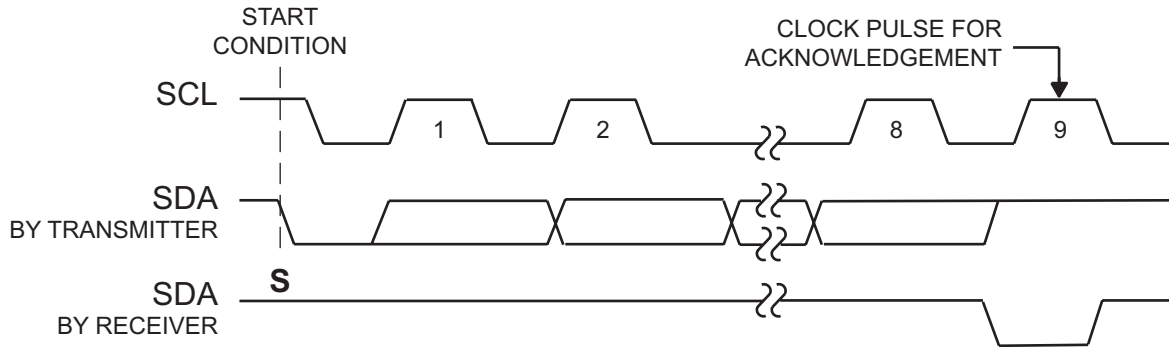

Figure 51. Acknowledge

## THE SLAVE ADDRESS

The MPR121 has a 7-bit long slave address (Figure 52). The bit following the 7-bit slave address (bit eight) is the  $\overline{R/W}$  bit, which is low for a write command and high for a read command.

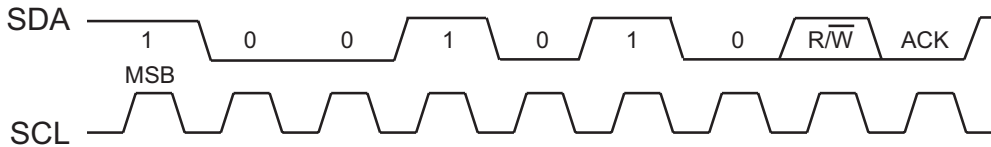

Figure 52. Slave Address

The MPR121 monitors the bus continuously, waiting for a START condition followed by its slave address. When a MPR121 recognizes its slave address, it acknowledges and is then ready for continued communication.

The MPR121 slave addresses are show in Table 46.

Table 46.

| ADDR Pin Connection | I <sup>2</sup> C Address |
|---------------------|--------------------------|
| VDD                 | 0x4C                     |
| VSS                 | 0x4D                     |
| SDA                 | 0x4E                     |
| SCL                 | 0x4F                     |



## MESSAGE FORMAT FOR WRITING THE MPR121

A write to the MPR121 comprises the transmission of the MPR121's keystone slave address with the  $\overline{R/\overline{W}}$  bit set to 0, followed by at least one byte of information. The first byte of information is the command byte. The command byte determines which register of the MPR121 is to be written by the next byte, if received. If a STOP condition is detected after the command byte is received, the MPR121 takes no further action (Figure 53) beyond storing the command byte. Any bytes received after the command byte are data bytes.

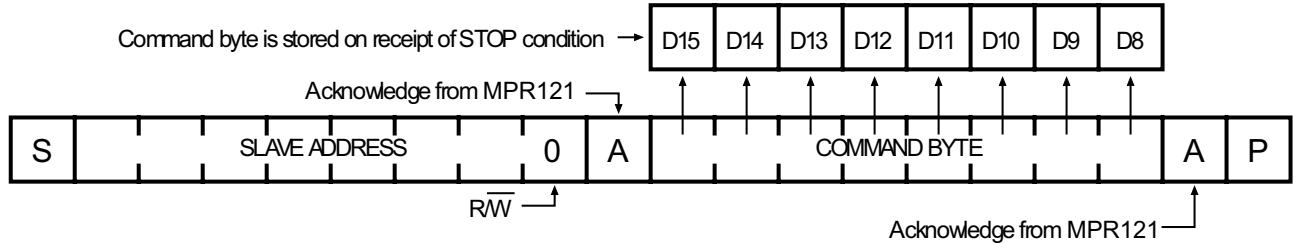

Figure 53. Command Byte Received

Any bytes received after the command byte are data bytes. The first data byte goes into the internal register of the MPR121 selected by the command byte (Figure 54).

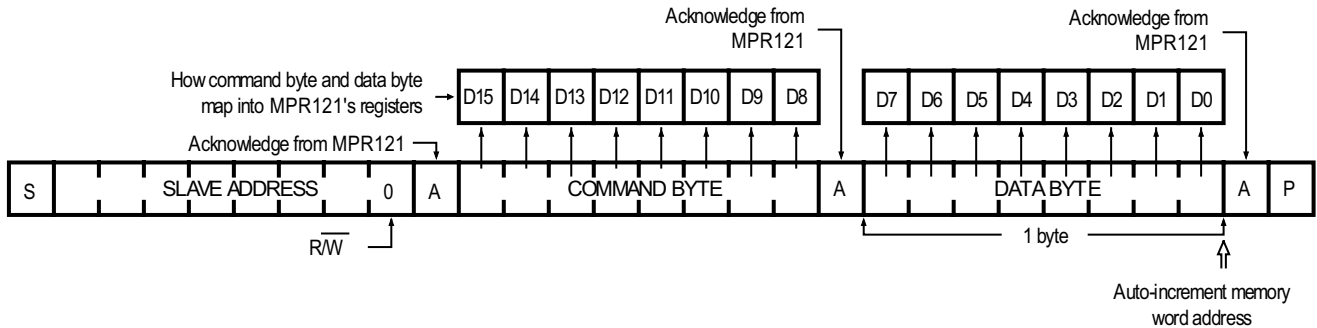

Figure 54. Command and Single Data Byte Received

If multiple data bytes are transmitted before a STOP condition is detected, these bytes are generally stored in subsequent MPR121 internal registers because the command byte address generally auto-increments.

## MESSAGE FORMAT FOR READING THE MPR121

MPR121 is read using MPR121's internally stored register address as address pointer, the same way the stored register address is used as address pointer for a write. The pointer generally auto-increments after each data byte is read using the same rules as for a write. Thus, a read is initiated by first configuring MPR121's register address by performing a write (Figure 53) followed by a repeated start. The master can now read 'n' consecutive bytes from MPR121, with first data byte being read from the register addressed by the initialized register address.

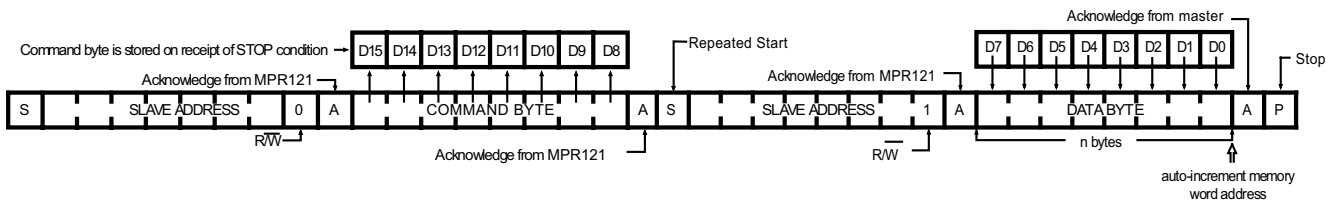

Figure 55. Reading MPR121

## OPERATION WITH MULTIPLE MASTER

The application should use repeated starts to address the MPR121 to avoid bus confusion between I<sup>2</sup>C masters. On an I<sup>2</sup>C bus, once a master issues a start/repeated start condition, that master owns the bus until a stop condition occurs. If a master that does not own the bus attempts to take control of that bus, then improper addressing may occur. An address may always be rewritten to fix this problem. Follow I<sup>2</sup>C protocol for multiple master configurations.

# AN3944: MPR121 Quick Start Guide

## INTRODUCTION

The MPR121 is Freescale Semiconductor's top of the line touch sensor and can fit into a wide range of applications. These applications can all be accommodated by having a device with a very large range of flexibility. While all of these added features can allow for a wide range of flexibility, they can also add an unnecessary layer of complication. For advanced users who want to do more than basic touch detection, additional information can be found in other application notes.

To start, the device is configured through an I<sup>2</sup>C serial interface. The following table lists the registers that are initialized. The order they are written in is not significant except that register 0x05E, the Electrode Configuration Register must be written last.

| Register Address | Register Name                  | Value | Application Note | Section |
|------------------|--------------------------------|-------|------------------|---------|
| 0x2B             | MHD Rising                     | 0x01  | AN3891           | A       |
| 0x2C             | NHD Amount Rising              | 0x01  | AN3891           | A       |
| 0x2D             | NCL Rising                     | 0x00  | AN3891           | A       |
| 0x2E             | FDL Rising                     | 0x00  | AN3891           | A       |
| 0x2F             | MHD Falling                    | 0x01  | AN3891           | B       |
| 0x30             | NHD Amount Falling             | 0x01  | AN3891           | B       |
| 0x31             | NCL Falling                    | 0xFF  | AN3891           | B       |
| 0x32             | FDL Falling                    | 0x02  | AN3891           | B       |
| 0x41             | ELE0 Touch Threshold           | 0x0F  | AN3892           | C       |
| 0x42             | ELE0 Release Threshold         | 0x0A  | AN3892           | C       |
| 0x43             | ELE1 Touch Threshold           | 0x0F  | AN3892           | C       |
| 0x44             | ELE1 Release Threshold         | 0x0A  | AN3892           | C       |
| 0x45             | ELE2 Touch Threshold           | 0x0F  | AN3892           | C       |
| 0x46             | ELE2 Release Threshold         | 0x0A  | AN3892           | C       |
| 0x47             | ELE3 Touch Threshold           | 0x0F  | AN3892           | C       |
| 0x48             | ELE3 Release Threshold         | 0x0A  | AN3892           | C       |
| 0x49             | ELE4 Touch Threshold           | 0x0F  | AN3892           | C       |
| 0x4A             | ELE4 Release Threshold         | 0x0A  | AN3892           | C       |
| 0x4B             | ELE5 Touch Threshold           | 0x0F  | AN3892           | C       |
| 0x4C             | ELE5 Release Threshold         | 0x0A  | AN3892           | C       |
| 0x4D             | ELE6 Touch Threshold           | 0x0F  | AN3892           | C       |
| 0x4E             | ELE6 Release Threshold         | 0x0A  | AN3892           | C       |
| 0x4F             | ELE7 Touch Threshold           | 0x0F  | AN3892           | C       |
| 0x50             | ELE7 Release Threshold         | 0x0A  | AN3892           | C       |
| 0x51             | ELE8 Touch Threshold           | 0x0F  | AN3892           | C       |
| 0x52             | ELE8 Release Threshold         | 0x0A  | AN3892           | C       |
| 0x53             | ELE9 Touch Threshold           | 0x0F  | AN3892           | C       |
| 0x54             | ELE9 Release Threshold         | 0x0A  | AN3892           | C       |
| 0x55             | ELE10 Touch Threshold          | 0x0F  | AN3892           | C       |
| 0x56             | ELE10 Release Threshold        | 0x0A  | AN3892           | C       |
| 0x57             | ELE11 Touch Threshold          | 0x0F  | AN3892           | C       |
| 0x58             | ELE11 Release Threshold        | 0x0A  | AN3892           | C       |
| 0x5D             | Filter Configuration           | 0x04  | AN3890           | D       |
| 0x5E             | Electrode Configuration        | 0x0C  | AN3890           | E       |
| 0x7B             | AUTO-CONFIG Control Register 0 | 0x0B  | AN3889           | F       |

| Register Address | Register Name                     | Value | Application Note | Section |
|------------------|-----------------------------------|-------|------------------|---------|
| 0x7D             | AUTO-CONFIG USL Register          | 0x9C  | AN3889           | F       |
| 0x7E             | AUTO-CONFIG LSL Register          | 0x65  | AN3889           | F       |
| 0x7F             | AUTO-CONFIG Target Level Register | 0x8C  | AN3889           | F       |

The following sections describe what each of the defaults do and recommendations for variations.

### Section A

| Register Address | Register Name     | Value | Application Note |
|------------------|-------------------|-------|------------------|
| 0x2B             | MHD Rising        | 0x01  | AN3891           |
| 0x2C             | NHD Amount Rising | 0x01  | AN3891           |
| 0x2D             | NCL Rising        | 0x00  | AN3891           |
| 0x2E             | FDL Rising        | 0x00  | AN3891           |

**Description:** This group of setting controls the filtering of the system when the data is greater than the baseline. The setting used allow the filter to act quickly and adjust for environmental changes. Additionally, if calibration happens to take place while a touch occurs, the value will self adjust very quickly. This auto-recovery or snap back prevents repeated false negative for a touch detection.

**Variation:** As the filter is sensitive to setting changes, it is recommended that users read AN3891 before changing the values. In most cases these default values will work

### Section B

| Register Address | Register Name      | Value | Application Note |
|------------------|--------------------|-------|------------------|
| 0x2F             | MHD Falling        | 0x01  | AN3891           |
| 0x30             | NHD Amount Falling | 0x01  | AN3891           |
| 0x31             | NCL Falling        | 0xFF  | AN3891           |
| 0x32             | FDL Falling        | 0x02  | AN3891           |

**Description:** This group of setting controls the filtering of the system, when the data is less than the baseline. The settings slow down the filter as the negative charge is in the same direction as a touch. By slowing down the filter, touch signals are “rejected” by the baseline filter. While at the same time lon term environmental change that occur slower than at a touch are accepted. This low pass filter both allows for touches to be detected properly while preventing false positive by passing environmental change through the filter.

**Variation:** As the filter is sensitive to setting changes, it is recommended that users read AN3891 before changing the values. In most cases these default values will work

## Section C

| Register Address | Register Name           | Value | Application Note |
|------------------|-------------------------|-------|------------------|
| 0x41             | ELE0 Touch Threshold    | 0x0F  | AN3892           |
| 0x42             | ELE0 Release Threshold  | 0x0A  | AN3892           |
| 0x43             | ELE1 Touch Threshold    | 0x0F  | AN3892           |
| 0x44             | ELE1 Release Threshold  | 0x0A  | AN3892           |
| 0x45             | ELE2 Touch Threshold    | 0x0F  | AN3892           |
| 0x46             | ELE2 Release Threshold  | 0x0A  | AN3892           |
| 0x47             | ELE3 Touch Threshold    | 0x0F  | AN3892           |
| 0x48             | ELE3 Release Threshold  | 0x0A  | AN3892           |
| 0x49             | ELE4 Touch Threshold    | 0x0F  | AN3892           |
| 0x4A             | ELE4 Release Threshold  | 0x0A  | AN3892           |
| 0x4B             | ELE5 Touch Threshold    | 0x0F  | AN3892           |
| 0x4C             | ELE5 Release Threshold  | 0x0A  | AN3892           |
| 0x4D             | ELE6 Touch Threshold    | 0x0F  | AN3892           |
| 0x4E             | ELE6 Release Threshold  | 0x0A  | AN3892           |
| 0x4F             | ELE7 Touch Threshold    | 0x0F  | AN3892           |
| 0x50             | ELE7 Release Threshold  | 0x0A  | AN3892           |
| 0x51             | ELE8 Touch Threshold    | 0x0F  | AN3892           |
| 0x52             | ELE8 Release Threshold  | 0x0A  | AN3892           |
| 0x53             | ELE9 Touch Threshold    | 0x0F  | AN3892           |
| 0x54             | ELE9 Release Threshold  | 0x0A  | AN3892           |
| 0x55             | ELE10 Touch Threshold   | 0x0F  | AN3892           |
| 0x56             | ELE10 Release Threshold | 0x0A  | AN3892           |
| 0x57             | ELE11 Touch Threshold   | 0x0F  | AN3892           |
| 0x58             | ELE11 Release Threshold | 0x0A  | AN3892           |

**Description:** The touch threshold registers set the minimum delta from the baseline when a touch is detected. 0x0F or 15 in decimal is an estimate of the minimum value for touch. Most electrodes will work with this value even if they vary greatly in size and shape. The value of 0x0A or 10 is the release threshold register allowed for hysteresis in the touch detection.

**Variation:** For very small electrodes, smaller values can be used and for very large electrodes the reverse is true. One easy method is to view the deltas actually seen in a system and set the touch at 80% and release at 70% of delta for good performance.

## Section D

| Register Address | Register Name        | Value | Application Note |
|------------------|----------------------|-------|------------------|
| 0x5D             | Filter Configuration | 0x04  | AN3890           |

**Description:** There are three settings embedded in this register so it is only necessary to pay attention to one. The ESI controls the sample rate of the device. In the default, the setting used is 0x00 for 1 ms sample rate. Since the SFI is set to 00, resulting in 4 samples averaged, the response time will be 4 ms.

**Variation:** To save power, the 1 ms can be increased to 128 ms by increasing the setting to 0x07. The values are base 2 exponential thus 0x01 = 2 ms; 0x02 = 4 ms; and so on to 0x07 = 128 ms. Most of the time, 0x04 results in the best compromise between power consumption and response time.

## Section E

| Register Address | Register Name           | Value | Application Note |
|------------------|-------------------------|-------|------------------|
| 0x5E             | Electrode Configuration | 0x0C  | AN3890           |

**Description:** This register controls the number of electrodes being enabled and the mode the device is in. There are only two modes, Standby (when the value is 0x00) and Run (when the value of the lower bit is non-zero). The default value shown enables all 12 electrodes by writing decimal 12 or hex 0x0C to the register. Typically other registers cannot be changed while the part is running so this register should always be written last.

**Variation:** During debug of a system, this register will change between the number of electrodes and 0x00 every time a register needs to change. In a production system, this register will only need to be written when the mode is changed from Standby to Run or vice versa.

## Section F

| Register Address | Register Name                     | Value | Application Note |
|------------------|-----------------------------------|-------|------------------|
| 0x7B             | AUTO-CONFIG Control Register 0    | 0x0B  | AN3889           |
| 0x7D             | AUTO-CONFIG USL Register          | 0x9C  | AN3889           |
| 0x7E             | AUTO-CONFIG LSL Register          | 0x65  | AN3889           |
| 0x7F             | AUTO-CONFIG Target Level Register | 0x8C  | AN3889           |

**Description:** These are the settings used for the Auto Configuration. They enable AUTO-CONFIG and AUTO\_RECONFIG. In addition they set the target range for the baseline. The upper limit is set to 190, the target is set to 180 and the lower limit is set to 140.

**Variation:** In most cases these values will never need to be change, but if a case arises, a full description is found in application note AN3889.

## CONCLUSION

In many applications for the MPR121, the default settings presented in this document will be sufficient for both design time activities as well as in the production implementation.

# PACKAGE DIMENSIONS

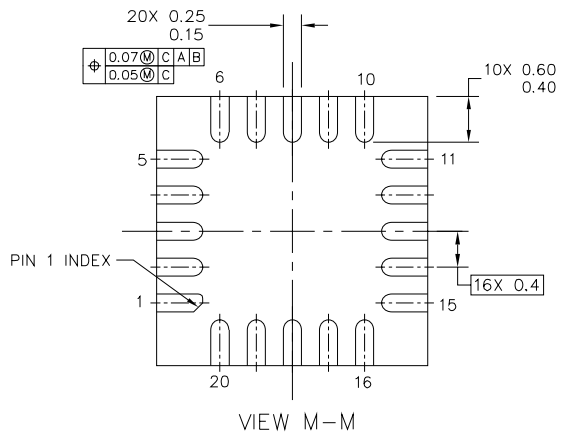
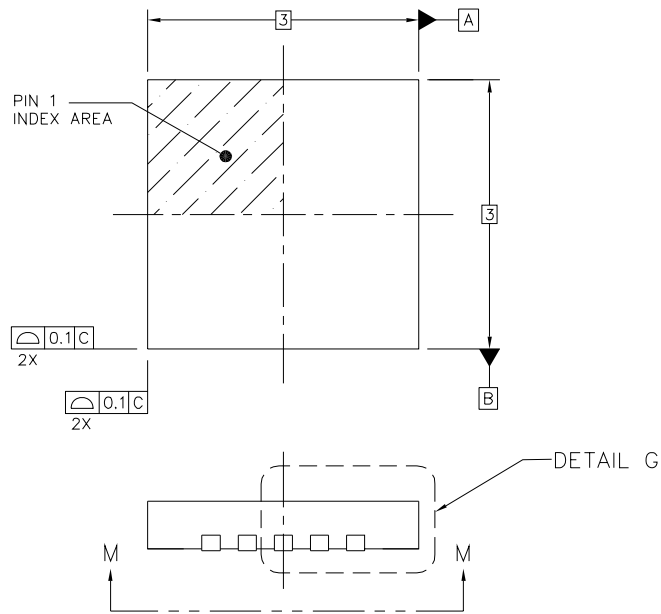

|   |                           |                            |  |
|---|---------------------------|----------------------------|--|
| © FREESCALE SEMICONDUCTOR, INC.<br>ALL RIGHTS RESERVED.                                   | <b>MECHANICAL OUTLINE</b> | PRINT VERSION NOT TO SCALE |  |
| TITLE: QUAD FLAT NO LEAD<br>COL PACKAGE (QFN-COL)<br>20 TERMINAL, 0.4 PITCH (3 X 3 X 0.6) | DOCUMENT NO: 98ASA00021D  | REV: 0                     |  |
|   | CASE NUMBER: 2059-01      | 19 FEB 2009                |  |
|   | STANDARD: NON JEDEC       |                            |  |

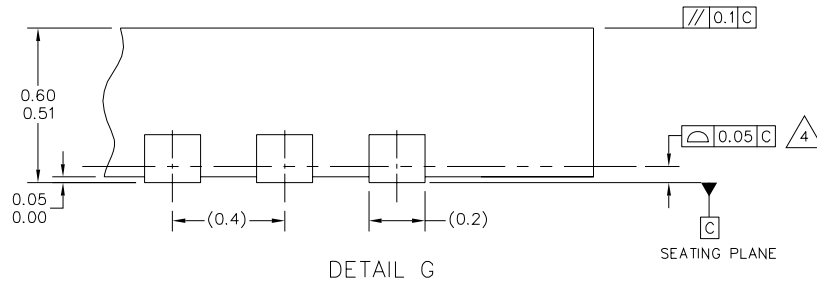

|  |                           |                            |  |
|--|---------------------------|----------------------------|--|
| © FREESCALE SEMICONDUCTOR, INC.<br>ALL RIGHTS RESERVED.                                      | <b>MECHANICAL OUTLINE</b> | PRINT VERSION NOT TO SCALE |  |
| TITLE:<br>QUAD FLAT NO LEAD<br>COL PACKAGE (QFN-COL)<br>20 TERMINAL, 0.4 PITCH (3 X 3 X 0.6) | DOCUMENT NO: 98ASA00021D  | REV: 0                     |  |
|  | CASE NUMBER: 2059-01      | 19 FEB 2009                |  |
|  | STANDARD: NON JEDEC       |                            |  |

PAGE 2 OF 3

## PACKAGE DIMENSIONS

NOTES:

1. ALL DIMENSIONS ARE IN MILLIMETERS.
2. INTERPRET DIMENSIONS AND TOLERANCES PER ASME Y14.5M-1994.
3. THIS IS NON JEDEC REGISTERED PACKAGE.
4.  COPLANARITY APPLIES TO LEADS AND ALL OTHR BOTTOM SURFACE METALLIZATION.
5. MIN. METAL GAP SHOULD BE 0.2MM.

|  |                           |                            |  |
|--|---------------------------|----------------------------|--|
| © FREESCALE SEMICONDUCTOR, INC.<br>ALL RIGHTS RESERVED.  | <b>MECHANICAL OUTLINE</b> | PRINT VERSION NOT TO SCALE |  |
| TITLE:        QUAD FLAT NO LEAD<br>COL PACKAGE (QFN-COL)<br>20 TERMINAL, 0.4 PITCH (3 X 3 X 0.6) | DOCUMENT NO: 98ASA00021D  | REV: 0                     |  |
|  | CASE NUMBER: 2059-01      | 19 FEB 2009                |  |
|  | STANDARD: NON JEDEC       |                            |  |

PAGE 3 OF 3



## **How to Reach Us:**

### **Home Page:**

[www.freescale.com](http://www.freescale.com)

### **Web Support:**

<http://www.freescale.com/support>

### **USA/Europe or Locations Not Listed:**

Freescale Semiconductor, Inc.  
Technical Information Center, EL516  
2100 East Elliot Road  
Tempe, Arizona 85284  
1-800-521-6274 or +1-480-768-2130  
[www.freescale.com/support](http://www.freescale.com/support)

### **Europe, Middle East, and Africa:**

Freescale Halbleiter Deutschland GmbH  
Technical Information Center  
Schatzbogen 7  
81829 Muenchen, Germany  
+44 1296 380 456 (English)  
+46 8 52200080 (English)  
+49 89 92103 559 (German)  
+33 1 69 35 48 48 (French)  
[www.freescale.com/support](http://www.freescale.com/support)

### **Japan:**

Freescale Semiconductor Japan Ltd.  
Headquarters  
ARCO Tower 15F  
1-8-1, Shimo-Meguro, Meguro-ku,  
Tokyo 153-0064  
Japan  
0120 191014 or +81 3 5437 9125  
[support.japan@freescale.com](mailto:support.japan@freescale.com)

### **Asia/Pacific:**

Freescale Semiconductor China Ltd.  
Exchange Building 23F  
No. 118 Jianguo Road  
Chaoyang District  
Beijing 100022  
China  
+86 010 5879 8000  
[support.asia@freescale.com](mailto:support.asia@freescale.com)

### **For Literature Requests Only:**

Freescale Semiconductor Literature Distribution Center  
1-800-441-2447 or +1-303-675-2140  
Fax: +1-303-675-2150  
[LDCForFreescaleSemiconductor@hibbertgroup.com](mailto:LDCForFreescaleSemiconductor@hibbertgroup.com)

Information in this document is provided solely to enable system and software implementers to use Freescale Semiconductor products. There are no express or implied copyright licenses granted hereunder to design or fabricate any integrated circuits or integrated circuits based on the information in this document.

Freescale Semiconductor reserves the right to make changes without further notice to any products herein. Freescale Semiconductor makes no warranty, representation or guarantee regarding the suitability of its products for any particular purpose, nor does Freescale Semiconductor assume any liability arising out of the application or use of any product or circuit, and specifically disclaims any and all liability, including without limitation consequential or incidental damages. "Typical" parameters that may be provided in Freescale Semiconductor data sheets and/or specifications can and do vary in different applications and actual performance may vary over time. All operating parameters, including "Typicals", must be validated for each customer application by customer's technical experts. Freescale Semiconductor does not convey any license under its patent rights nor the rights of others. Freescale Semiconductor products are not designed, intended, or authorized for use as components in systems intended for surgical implant into the body, or other applications intended to support or sustain life, or for any other application in which the failure of the Freescale Semiconductor product could create a situation where personal injury or death may occur. Should Buyer purchase or use Freescale Semiconductor products for any such unintended or unauthorized application, Buyer shall indemnify and hold Freescale Semiconductor and its officers, employees, subsidiaries, affiliates, and distributors harmless against all claims, costs, damages, and expenses, and reasonable attorney fees arising out of, directly or indirectly, any claim of personal injury or death associated with such unintended or unauthorized use, even if such claim alleges that Freescale Semiconductor was negligent regarding the design or manufacture of the part.

Freescale and the Freescale logo are trademarks of Freescale Semiconductor, Inc. All other product or service names are the property of their respective owners.

© Freescale Semiconductor, Inc. 2010. All rights reserved.

RoHS-compliant and/or Pb-free versions of Freescale products have the functionality and electrical characteristics of their non-RoHS-compliant and/or non-Pb-free counterparts. For further information, see <http://www.freescale.com> or contact your Freescale sales representative.

For information on Freescale's Environmental Products program, go to <http://www.freescale.com/epp>.