

# The RF Line

## NPN Silicon

### RF Power Transistor

... designed for high gain driver and output linear amplifier stages in 1.5 to 30 MHz HF/SSB equipment.

- Specified 28 Volt, 30 MHz Characteristics —  
Output Power = 25 W (PEP)  
Minimum Gain = 22 dB  
Efficiency = 35%
- Intermodulation Distortion @ 25 W (PEP) —  
IMD = -30 dB (Max)
- 100% Tested for Load Mismatch at all Phase Angles with 30:1 VSWR
- Class A and AB Characterization
- BLX 13 Equivalent

**MRF426**

**25 W (PEP), 30 MHz  
RF POWER  
TRANSISTOR  
NPN SILICON**

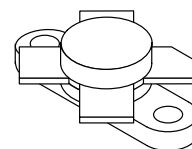

CASE 211-07, STYLE 1

#### MAXIMUM RATINGS

Rating	Symbol	Value	Unit
Collector-Emitter Voltage	$V_{CEO}$	35	Vdc
Collector-Base Voltage	$V_{CBO}$	65	Vdc
Emitter-Base Voltage	$V_{EBO}$	4.0	Vdc
Collector Current — Continuous	$I_C$	3.0	Adc
Withstand Current — 5 s	—	6.0	Adc
Total Device Dissipation @ $T_C = 25^\circ\text{C}$ (1) Derate above $25^\circ\text{C}$	$P_D$	70 0.4	Watts W/ $^\circ\text{C}$
Storage Temperature Range	$T_{stg}$	-65 to +150	$^\circ\text{C}$

#### THERMAL CHARACTERISTICS

Characteristic	Symbol	Max	Unit
Thermal Resistance, Junction to Case	$R_{\theta JC}$	2.5	$^\circ\text{C}/\text{W}$

#### ELECTRICAL CHARACTERISTICS ( $T_C = 25^\circ\text{C}$ unless otherwise noted.)

Characteristic	Symbol	Min	Typ	Max	Unit
----------------	--------	-----	-----	-----	------

#### OFF CHARACTERISTICS

Collector-Emitter Breakdown Voltage ( $I_C = 50 \text{ mAdc}$ , $I_B = 0$ )	$V_{(BR)CEO}$	35	—	—	Vdc
Collector-Base Breakdown Voltage ( $I_C = 50 \text{ mAdc}$ , $I_E = 0$ )	$V_{(BR)CBO}$	65	—	—	Vdc
Emitter-Base Breakdown Voltage ( $I_E = 10 \text{ mAdc}$ , $I_C = 0$ )	$V_{(BR)EBO}$	4.0	—	—	Vdc
Collector Cutoff Current ( $V_{CE} = 28 \text{ Vdc}$ , $V_{BE} = 0$ )	$I_{CES}$	—	—	10	mAdc

NOTE:

- This device is designed for RF operation. The total device dissipation rating applies only when the device is operated as an RF amplifier.

(continued)

**ELECTRICAL CHARACTERISTICS — continued** ( $T_C = 25^\circ\text{C}$  unless otherwise noted.)

Characteristic	Symbol	Min	Typ	Max	Unit
<b>ON CHARACTERISTICS</b>					
DC Current Gain ( $I_C = 1.0 \text{ Adc}$ , $V_{CE} = 5.0 \text{ Vdc}$ )	$h_{FE}$	10	35	—	—

**DYNAMIC CHARACTERISTICS**

Output Capacitance ( $V_{CB} = 30 \text{ Vdc}$ , $I_E = 0$ , $f = 1.0 \text{ MHz}$ )	$C_{ob}$	—	60	80	pF
-----------------------------------------------------------------------------------------	----------	---	----	----	----

**FUNCTIONAL TESTS (SSB)**

Common-Emitter Amplifier Gain ( $V_{CC} = 28 \text{ Vdc}$ , $P_{out} = 25 \text{ W (PEP)}$ , $f_1 = 30 \text{ MHz}$ , $f_2 = 30.001 \text{ MHz}$ , $I_{CQ} = 25 \text{ mA}$ )	$G_{PE}$	22	25	—	dB
Collector Efficiency ( $V_{CC} = 28 \text{ Vdc}$ , $P_{out} = 25 \text{ W (PEP)}$ , $f_1 = 30 \text{ MHz}$ , $f_2 = 30.001 \text{ MHz}$ , $I_{CQ} = 25 \text{ mA}$ )	$\eta$	35	—	—	%
Intermodulation Distortion (2) ( $V_{CC} = 28 \text{ Vdc}$ , $P_{out} = 25 \text{ W (PEP)}$ , $f_1 = 30 \text{ MHz}$ , $f_2 = 30.001 \text{ MHz}$ , $I_{CQ} = 25 \text{ mA}$ )	$IMD(d3)$	—	-35	-30	dB
Load Mismatch ( $V_{CC} = 28 \text{ Vdc}$ , $P_{out} = 25 \text{ W (PEP)}$ , $f_1 = 30 \text{ MHz}$ , $f_2 = 30.001 \text{ MHz}$ , $I_{CQ} = 25 \text{ mA}$ , $VSWR 30:1$ at All Phase Angles)	$\psi$	No Degradation in Output Power			

**CLASS A PERFORMANCE**

Intermodulation Distortion (2) and Power Gain ( $V_{CC} = 28 \text{ Vdc}$ , $P_{out} = 8.0 \text{ W (PEP)}$ , $f_1 = 30 \text{ MHz}$ , $f_2 = 30.001 \text{ MHz}$ , $I_{CQ} = 1.2 \text{ Adc}$ )	$G_{PE}$ $IMD(d3)$ $IMD(d5)$	— — —	23.5 -40 -55	— — —	dB
--------------------------------------------------------------------------------------------------------------------------------------------------------------------------------------------------------	------------------------------------	-------------	--------------------	-------------	----

NOTE:

2. To Mil-Std-1311 Version A, Test Method 2204B, Two Tone, Reference each Tone.

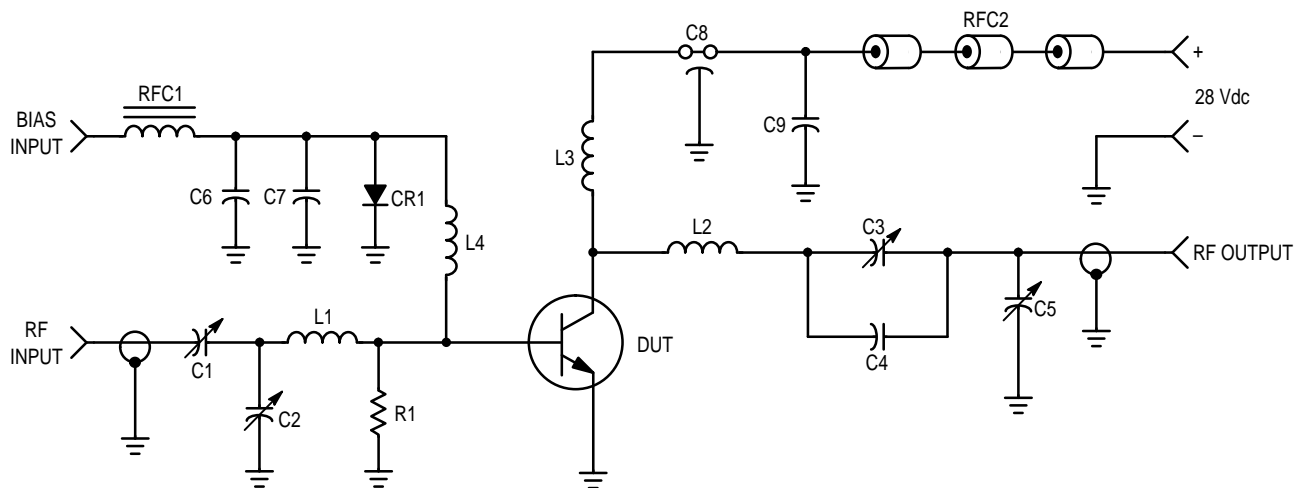

C1, C2 — ARCO 469, 190–780 pF  
 C3, C4 — ARCO 464, 25–280 pF  
 C5 — 120 pF Dipped Mica  
 C6, C7 — 100  $\mu\text{F}$ , 15 Vdc  
 C8 — 680 pF F.T. Allen Bradley  
 C9 — 1.0  $\mu\text{F}$  35 V Tantalum  
 CR1 — 1N4997

L1 — 3 Turns #16 0.25" ID  
 L2 — 6 Turns #16 0.5" ID  
 L3 — 7 Turns #20 0.38" ID  
 L4 — 10  $\mu\text{H}$  Molded Choke Delevan  
 RFC1 — Ferroxcube VK200/20-4B  
 RFC2 — 3-Ferroxcube 5653065-3B  
 RF — Input/Output Connectors UG53 A/ $\mu$   
 R1 — 10  $\Omega$  1/2 Watt 10%

Adjust Bias (Base) for  $I_{CQ} = 20 \text{ mA}$  with No RF Applied

**Figure 1. 30 MHz Linear Test Circuit**

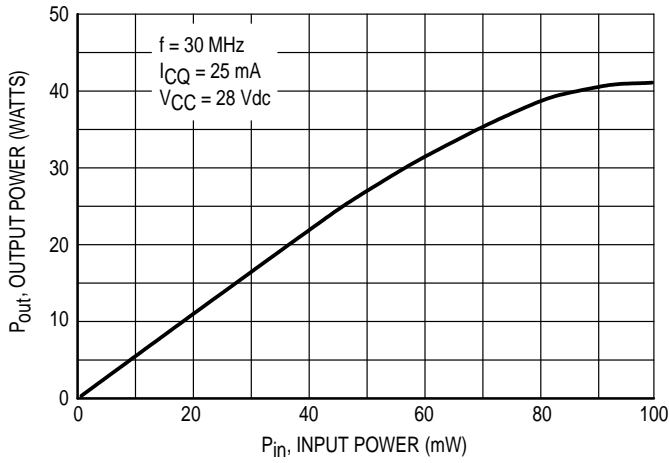

Figure 2. Output Power versus Input Power

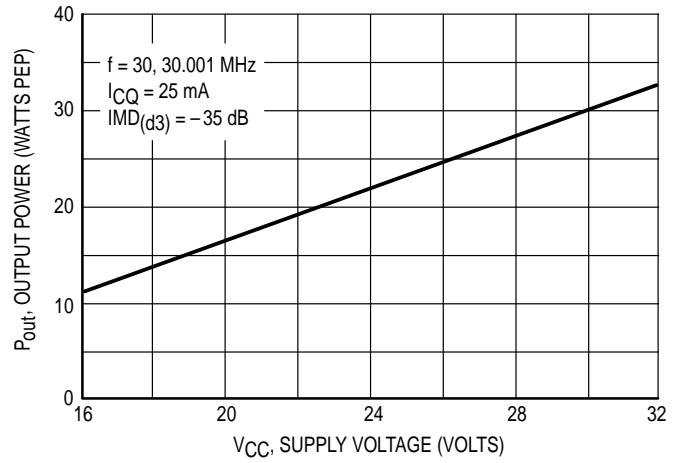

Figure 3. Output Power versus Supply Voltage

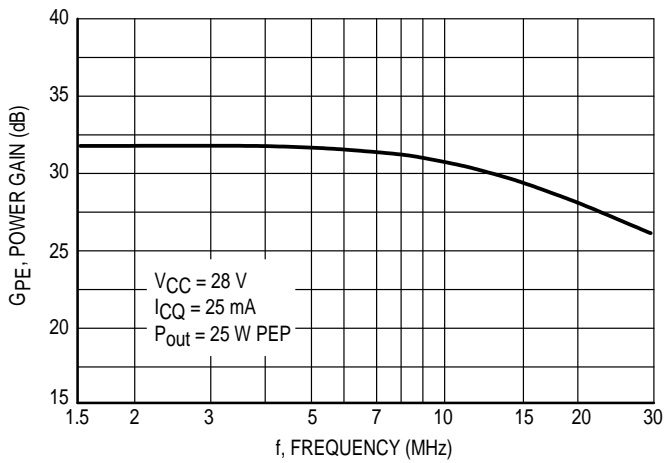

Figure 4. Power Gain versus Frequency

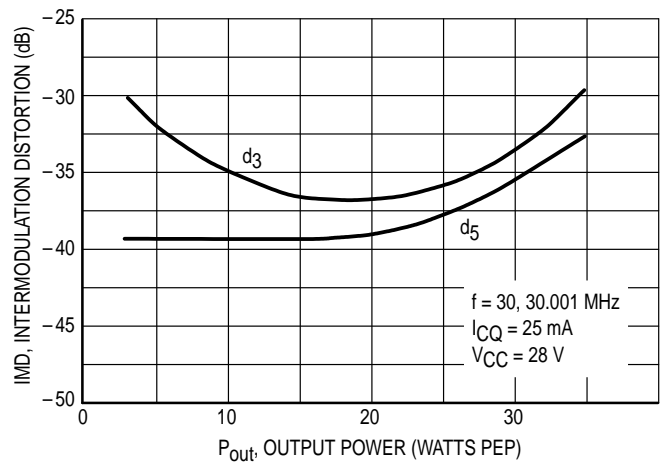

Figure 5. Intermodulation Distortion versus Output Power

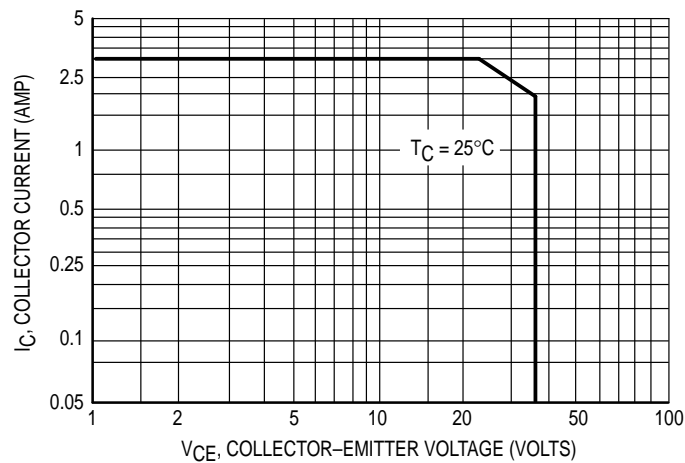

Figure 6. DC Safe Operating Area

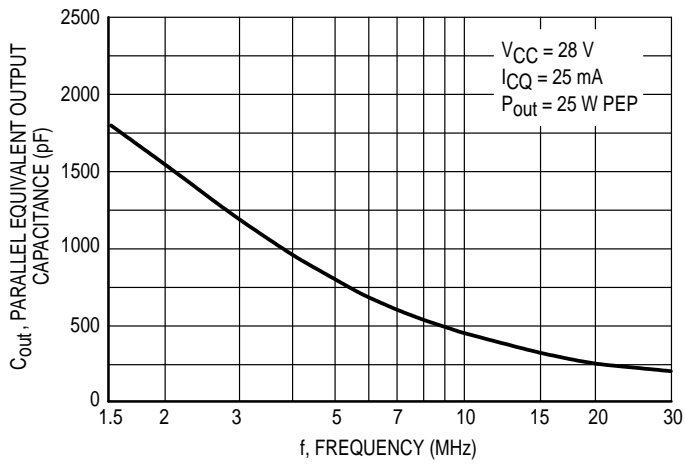

Figure 7. Output Capacitance versus Frequency

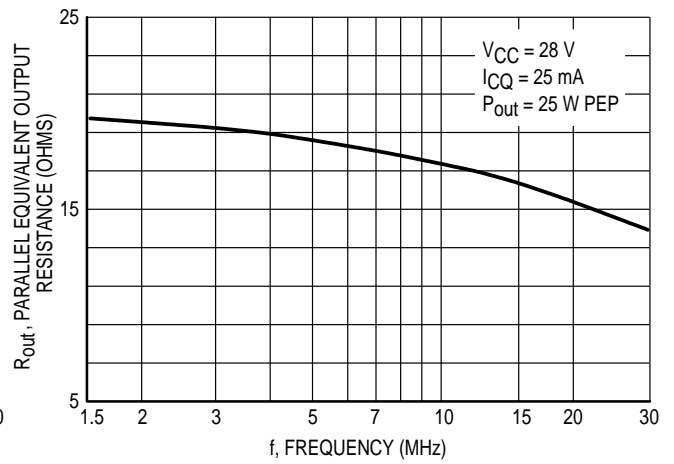

Figure 8. Output Resistance versus Frequency

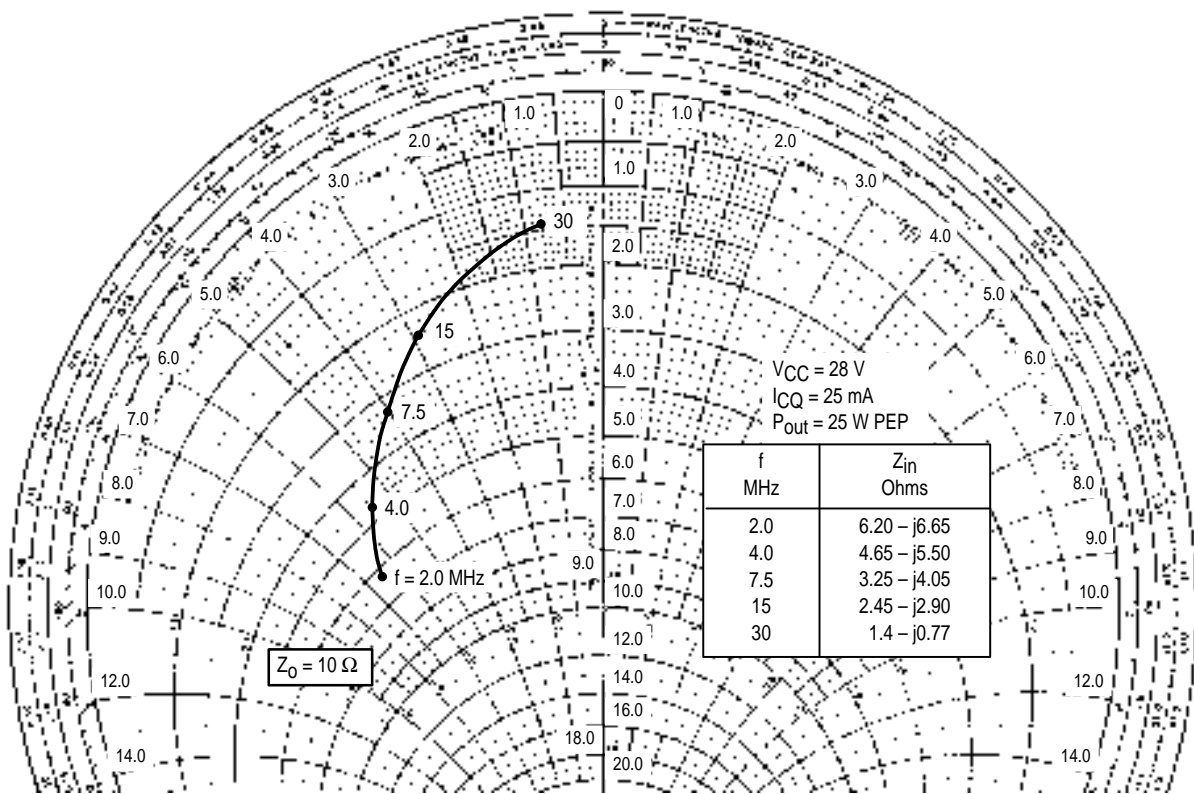
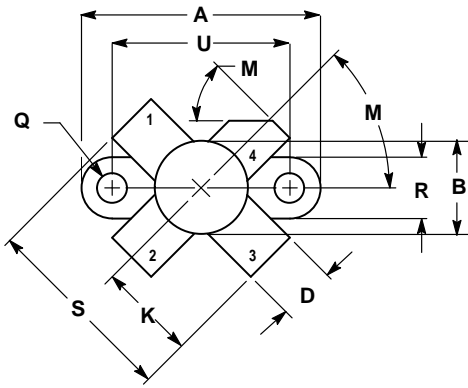

Figure 9. Series Equivalent Input Impedance

# PACKAGE DIMENSIONS



- NOTES:  
 1. DIMENSIONING AND TOLERANCING PER ANSI Y14.5M, 1982.  
 2. CONTROLLING DIMENSION: INCH.

DIM	INCHES		MILLIMETERS	
	MIN	MAX	MIN	MAX
A	0.960	0.990	24.39	25.14
B	0.370	0.390	9.40	9.90
C	0.229	0.281	5.82	7.13
D	0.215	0.235	5.47	5.96
E	0.085	0.105	2.16	2.66
H	0.150	0.108	3.81	4.57
J	0.004	0.006	0.11	0.15
K	0.395	0.405	10.04	10.28
M	40°	50°	40°	50°
Q	0.113	0.130	2.88	3.30
R	0.245	0.255	6.23	6.47
S	0.790	0.810	20.07	20.57
U	0.720	0.730	18.29	18.54

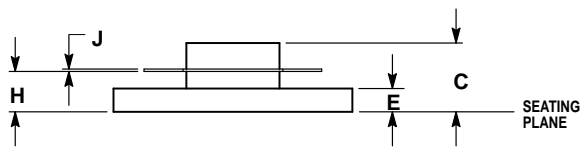

- STYLE 1:  
 PIN 1. EMITTER  
 2. BASE  
 3. EMITTER  
 4. COLLECTOR

**CASE 211-07  
 ISSUE N**

Motorola reserves the right to make changes without further notice to any products herein. Motorola makes no warranty, representation or guarantee regarding the suitability of its products for any particular purpose, nor does Motorola assume any liability arising out of the application or use of any product or circuit, and specifically disclaims any and all liability, including without limitation consequential or incidental damages. "Typical" parameters can and do vary in different applications. All operating parameters, including "Typicals" must be validated for each customer application by customer's technical experts. Motorola does not convey any license under its patent rights nor the rights of others. Motorola products are not designed, intended, or authorized for use as components in systems intended for surgical implant into the body, or other applications intended to support or sustain life, or for any other application in which the failure of the Motorola product could create a situation where personal injury or death may occur. Should Buyer purchase or use Motorola products for any such unintended or unauthorized application, Buyer shall indemnify and hold Motorola and its officers, employees, subsidiaries, affiliates, and distributors harmless against all claims, costs, damages, and expenses, and reasonable attorney fees arising out of, directly or indirectly, any claim of personal injury or death associated with such unintended or unauthorized use, even if such claim alleges that Motorola was negligent regarding the design or manufacture of the part. Motorola and  are registered trademarks of Motorola, Inc. Motorola, Inc. is an Equal Opportunity/Affirmative Action Employer.

**Literature Distribution Centers:**

USA: Motorola Literature Distribution; P.O. Box 20912; Phoenix, Arizona 85036.

EUROPE: Motorola Ltd.; European Literature Centre; 88 Tanners Drive, Blakelands, Milton Keynes, MK14 5BP, England.

JAPAN: Nippon Motorola Ltd.; 4-32-1, Nishi-Gotanda, Shinagawa-ku, Tokyo 141, Japan.

ASIA PACIFIC: Motorola Semiconductors H.K. Ltd.; Silicon Harbour Center, No. 2 Dai King Street, Tai Po Industrial Estate, Tai Po, N.T., Hong Kong.



MRF426/D



This datasheet has been download from:

[www.datasheetcatalog.com](http://www.datasheetcatalog.com)

Datasheets for electronics components.