

Series PVN012

Microelectronic Power IC
HEXFET® Power MOSFET Photovoltaic Relay
Single Pole, Normally Open, 0-20V, 2.5A AC/ 4.5A DC

General Description

The PVN012 Series Photovoltaic Relay at 100 milliohms features the lowest possible on-state resistance in a miniature package — lower than a comparable reed relay.

The PVN012 is a single-pole, normally open solid-state relay. It utilizes a GenerationV HEXFET output switch, driven by an integrated circuit photovoltaic generator of novel construction. The output switch is controlled by radiation from a GaAlAs light emitting diode (LED) which is optically isolated from the photovoltaic generator.

These units exceed the performance capabilities of electromechanical relays in life, sensitivity, stable on-resistance, miniaturization, magnetic insensitivity and ruggedness. They are ideally suited for switching high currents or low level signals without distortion or injection of electrical noise.

Series PVN012 Relays are packaged in a 6-lead molded DIP package with either through-hole or surface mount (gull-wing) terminals. They are available in standard plastic shipping tubes or on tape-and-reel. Please refer to part identification information opposite.

Applications

- Portable Electronics
- Programmable Logic Controllers
- Computers and Peripheral Devices
- Audio Equipment
- Power Supplies and Power Distribution
- Instrumentation

Features

- 100mΩ On-Resistance
- GenV HEXFET output
- Bounce-free operation
- 2.5 - 4.5 Amp capacity
- Linear AC/DC operation
- 4,000 V_{RMS} I/O isolation
- Solid-State reliability
- UL recognized and CSA certified
- ESD Tolerance:
 - 4000V Human Body Model
 - 500V Machine Model

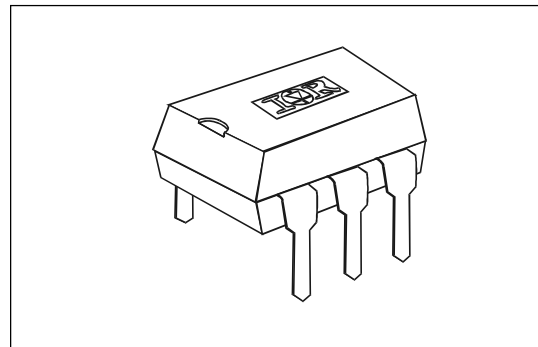

Part Identification

PVN012	through-hole
PVN012S	surface-mount
PVN012S-T	surface-mount, tape and reel

Electrical Specifications ($-40^{\circ}\text{C} \leq T_A \leq +85^{\circ}\text{C}$ unless otherwise specified)

INPUT CHARACTERISTICS	Limits	Units
Minimum Control Current (see figure 1)	3.0	mA
Maximum Control Current for Off-State Resistance @ $T_A = +25^{\circ}\text{C}$	0.4	mA
Control Current Range (Caution: current limit input LED, see figure 6)	3.0 to 25	mA
Maximum Reverse Voltage	7.0	V

OUTPUT CHARACTERISTICS	Limits	Units
Operating Voltage Range	0 to ± 20	V(DC or AC peak)
Maximum Continuous Load Current @ $T_A = +40^{\circ}\text{C}$, 5mA Control (see figure 1)		
A Connection	2.5	A (DC or AC)
B Connection	3.0	A (DC)
C Connection	4.5	A (DC)
Maximum Pulsed Load Current @ $T_A = +25^{\circ}\text{C}$, (100 ms @ 10% duty cycle)		
A Connection	6.0	A (DC or AC)
Maximum On-State Resistance @ $T_A = +25^{\circ}\text{C}$, for 1A pulsed load, 5mA Control (see figure 4)		
A Connection	100	m Ω
B Connection	65	
C Connection	40	
Minimum Off-State Resistance @ $T_A = +25^{\circ}\text{C}$, $\pm 16V_{DC}$	0.16×10^8	Ω
Maximum Turn-On Time @ $T_A = +25^{\circ}\text{C}$ (see figure 7), for 1A, 20 V _{DC} load, 5mA Control	5.0	ms
Maximum Turn-Off Time @ $T_A = +25^{\circ}\text{C}$ (see figure 7), for 1A, 20 V _{DC} load, 5mA Control	0.5	ms
Maximum Output Capacitance @ 20V _{DC} (see figure 2)	300	pF

GENERAL CHARACTERISTICS	Limits	Units
Minimum Dielectric Strength, Input-Output	4000	V _{RMS}
Minimum Insulation Resistance, Input-Output, @ $T_A = +25^{\circ}\text{C}$, 50%RH, 100V _{DC}	10^{12}	Ω
Maximum Capacitance, Input-Output	1.0	pF
Maximum Pin Soldering Temperature (10 seconds maximum)	+260	$^{\circ}\text{C}$
Ambient Temperature Range: Operating	-40 to +85	
Storage	-40 to +100	

Connection Diagrams

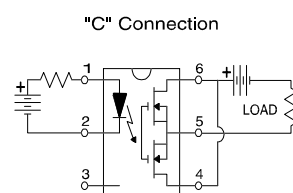
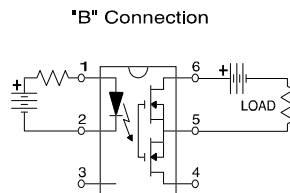
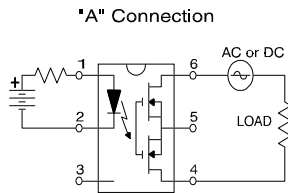

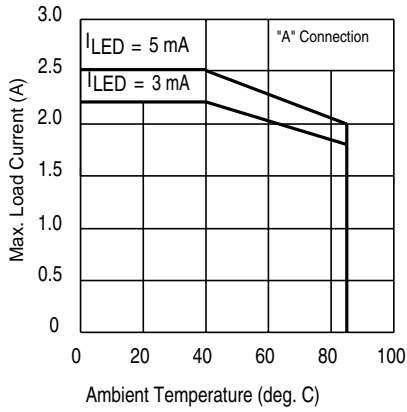

Figure 1. Current Derating Curves*

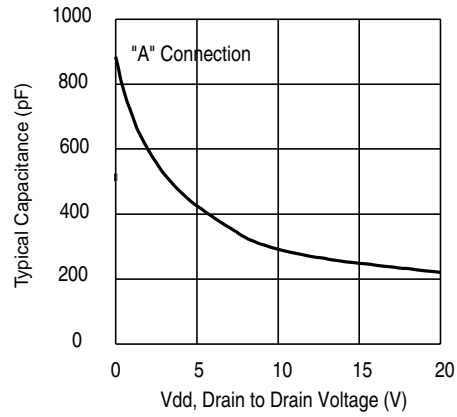

Figure 2. Typical Output Capacitance

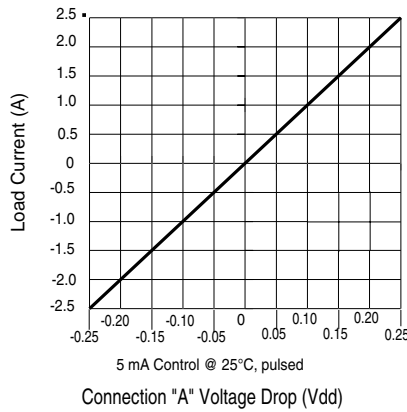

Figure 3. Linearity Characteristics

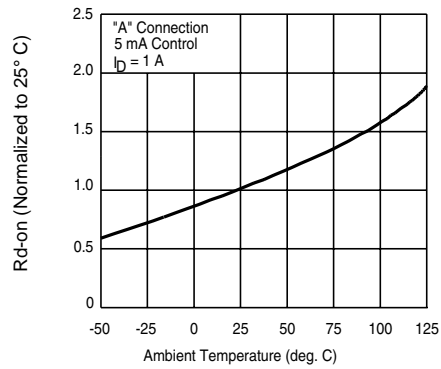

Figure 4. Typical Normalized On-Resistance

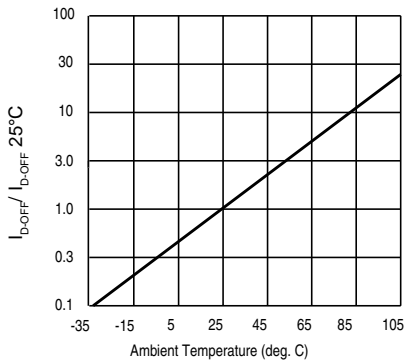

Figure 5. Typical Normalized Off-State Leakage

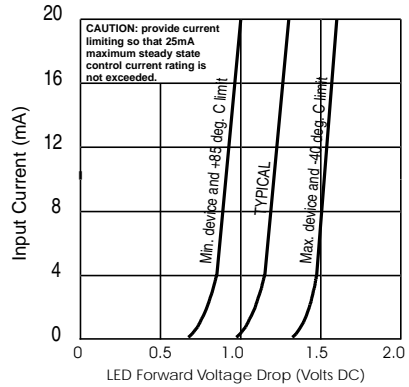

Figure 6. Input Characteristics (Current Controlled)

* Derating of 'B' and 'C' connection at +85°C will be 70% of that specified at +40°C and is linear from +40°C to +85°C.

Series PVN012

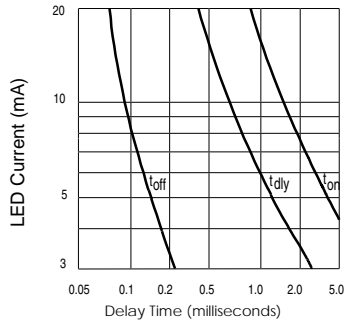

Figure 7. Typical Delay Times

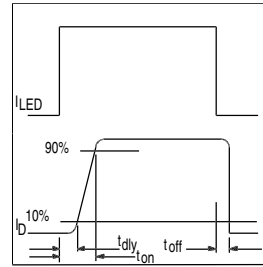
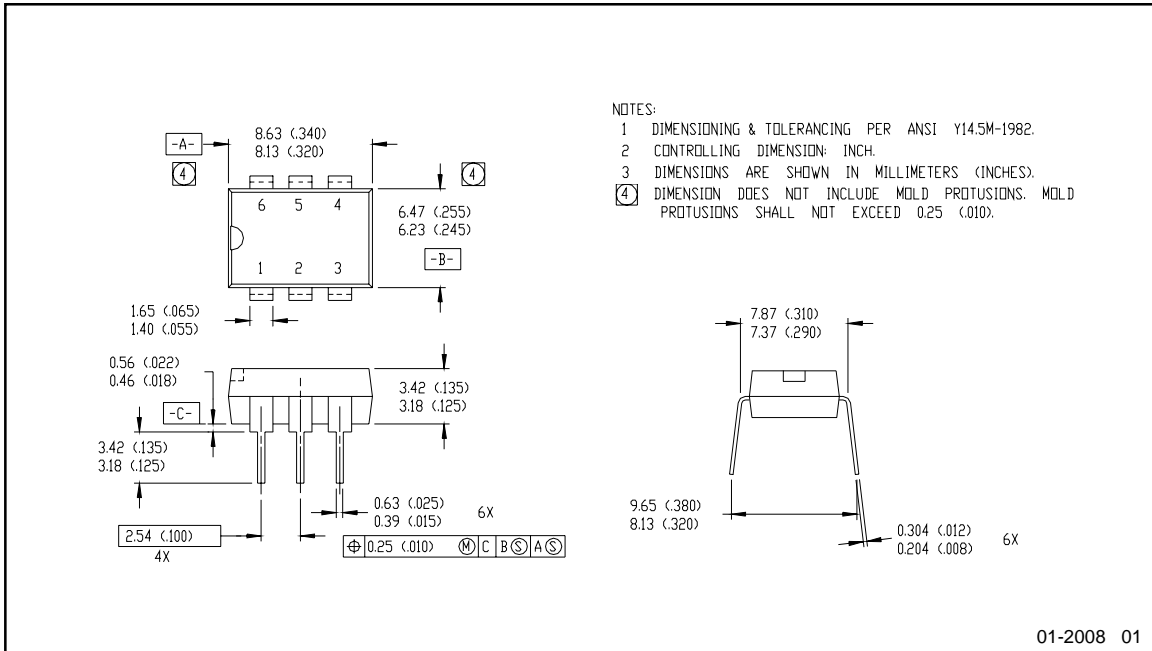

Figure 8. Delay Time Definitions

Case Outline



Case Outline

