

Features

- Efficiency up to 97%, Non isolated, no need for heatsinks
- Pin-out compatible with LM78XX Linear
- Low profile (L*W*H=11.5*8.5*17.5mm)
- Wide input range. (4.75V ~ 34V)
- Short circuit protection, Thermal shutdown
- Non standard outputs available as specials between 1.5V ~ 15V
- Low ripple and noise
- "L" version with 90° pins
- See Positive to Negative Converter Application Note for use as a voltage inverter (alternative to LM79xx Linear)

INNOLINE
DC/DC-Converter

R-78Bxx- 1.0(L) Series 1.0 AMP SIP3 Single Output

Selection Guide

Part Number	Input Range (1) (V)	Output Voltage (V)	Output Current (A)	Efficiency	
				Min. Vin (%)	Max. Vin (%)
SIP3	(V)	(V)	(A)	(%)	(%)
R-78B1.5-1.0	4.75 – 26	1.5	1.0	77	71
R-78B1.8-1.0	4.75 – 26	1.8	1.0	80	74
R-78B2.5-1.0	4.75 – 34	2.5	1.0	85	78
R-78B3.3-1.0	4.75 – 34	3.3	1.0	89	83
R-78B5.0-1.0	6.5 – 34	5.0	1.0	93	88
R-78B6.5-1.0	9.0 – 34	6.5	1.0	94	90
R-78B9.0-1.0	12 – 34	9.0	1.0	95	93
R-78B12-1.0	16 – 34	12	1.0	96	95
R-78B15-1.0	20 – 34	15	1.0	97	96

* add Suffix "L" for 90° bent pins, e.g. R-78B5.0-1.0L

Note 1: 1.5V, 1.8V Output can be unstable with $V_{in} > 26VDC$

Description

The R-78Bxx-Series high efficiency switching regulators are ideally suited to replace 78xx linear regulators and are pin compatible. The efficiency of up to 97% means that very little energy is wasted as heat so there is no need for any heat sinks with their additional space and mounting costs. The L-Version with 90° pins allows direct replacement for laid-flat regulators where component height is at a premium. Low ripple and noise figures and a short circuit input current of typically only 10mA round off the specifications of this versatile converter series.

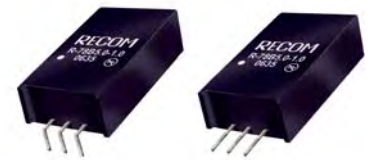

Derating-Graph (Ambient Temperature)

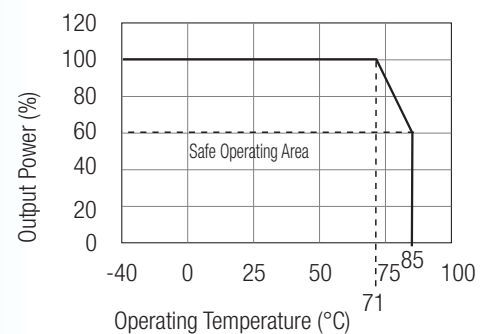

Specifications (refer to the standard application circuit, Ta: 25°C, minimum load = 10%)

Characteristics	Conditions	Min.	Typ.	Max.
Input Voltage Range	1.5V, 1.8V	4.75		26.0V
	2.5V to 15.5V	4.75		34.0V
Output Voltage Range (for customized parts)	All Series	1.5		15.5V
Output Current (see Note 2)	All Series	0		1000mA
Output Current Limit	All Series			2000mA
Short Circuit Input Current	All Series		10	30mA
Internal Power Dissipation				0.65W
Short Circuit Protection			Continuous, automatic recovery	
Output Voltage Accuracy (At 100% Load)	All Series		±2	±3%
Line Voltage Regulation (Vin = min. to max. at full load)	1.5V to 6.5V		0.2	0.4%
	9V to 15.5V		0.1	0.2%
Load Regulation (10% to 100% full load)	1.5V to 6.5V		0.4	0.6%
	9V to 15.5V		0.25	0.4%
Dynamic Load Stability (with Output Capacitor=100µF)	100% <-> 50% load		±100mV	±150mV
	Transient Recovery Time		1.0	1.5ms
Ripple & Noise (without Output Capacitor) (10% to 100% full load)	1.5V to 6.5V		15mVp-p	20mVp-p
	9V to 15.5V		25mVp-p	35mVp-p
Temperature Coefficient	-40°C ~ +85°C ambient			0.015%/°C
Max capacitance Load				220µF
Switching Frequency		280	330	380kHz
Quiescent Current	Vin = min. to max. at 0% load		5	7mA
Input Reflected Ripple Current	All Series		150	200mA-p-p
Operating Temperature Range		-40°C		+85°C
Operating Case Temperature				+100°C
Storage Temperature Range		-55°C		+125°C
Case Thermal Impedance				60°C / W
Thermal Shutdown	Internal IC junction		+160°C	
Relative Humidity				95% RH
MTBF (+25°C) (+71°C)	} Detailed Information see Application Notes chapter "MTBF"	using MIL-HDBK 217F		6584 x 10 ³ hours
		using MIL-HDBK 217F		1139 x 10 ³ hours

Note 2: Converter requires a minimum load of 6mA to start up properly. Once started, the load can be reduced to 0%.

Standard Application Circuit

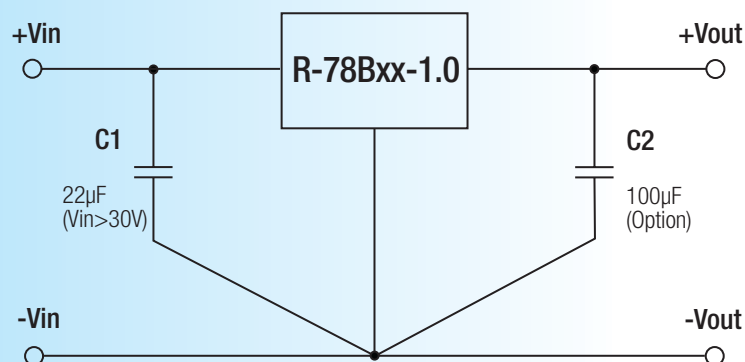

Add a blocking diode to Vout if current can flow backwards into the output, as this can damage the converter..

To protect the converter during power-up, use C1=22µF if Vin>30V

Characteristics

Efficiency

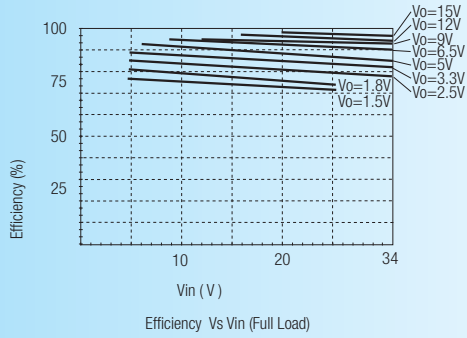

Ripple

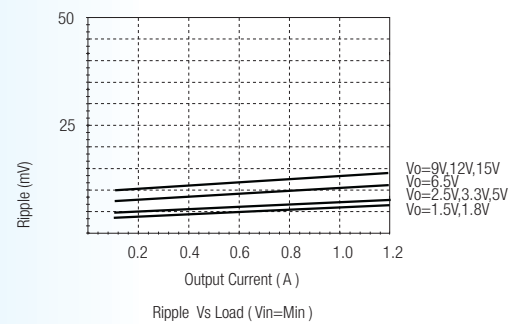
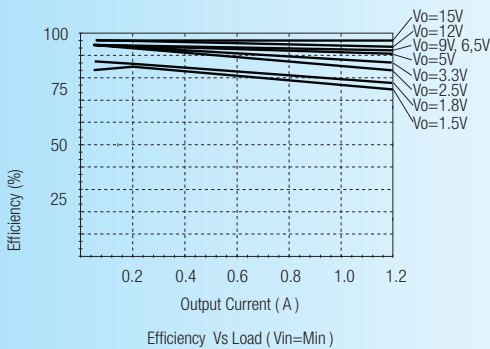
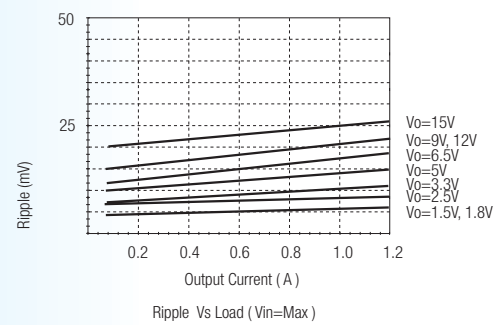
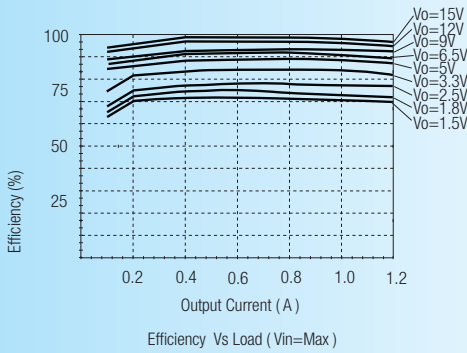
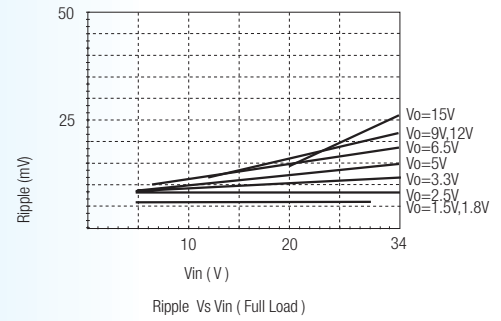

Application Examples

High efficiency multiple output

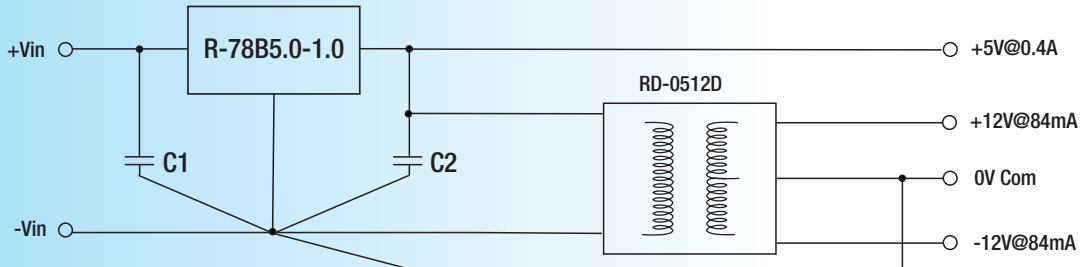

C1: optional, C2: required (further decoupling filtering may be necessary between the two converters)

- Wide input range 6.5V to 34V
- +/-12V outputs for analogue circuits, e.g. instrumentation amplifier
- +5V output for digital circuits

Isolated, wide Input range, Distributed Power Architecture (Point of Load)

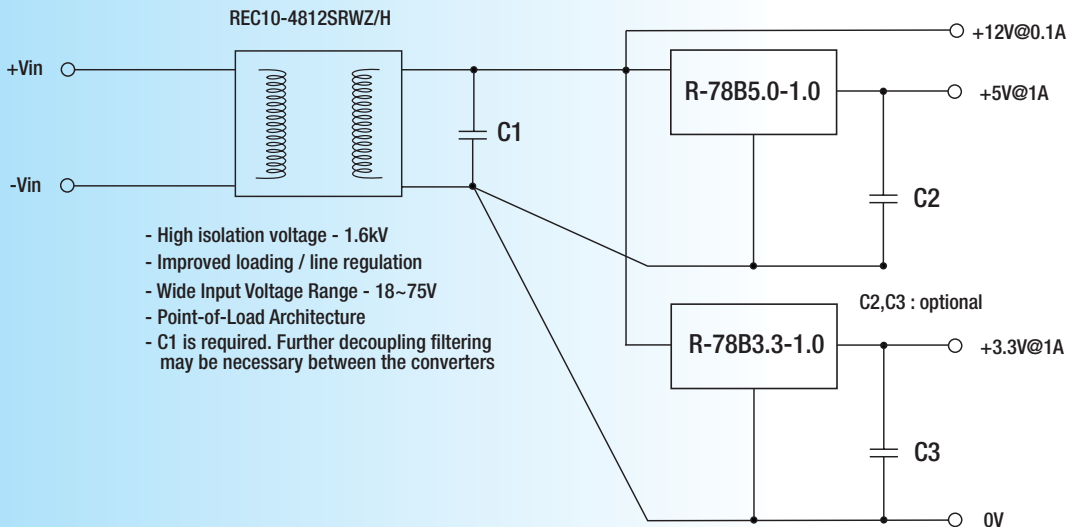

- High isolation voltage - 1.6kV
- Improved loading / line regulation
- Wide Input Voltage Range - 18~75V
- Point-of-Load Architecture
- C1 is required. Further decoupling filtering may be necessary between the converters

Package Style and Pinning (mm)

SIP3 PIN Package

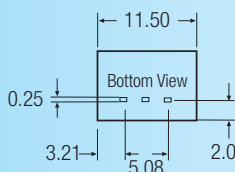
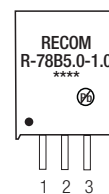
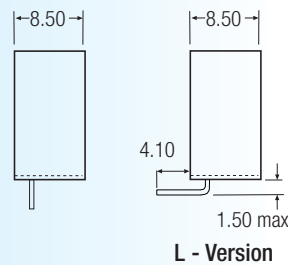
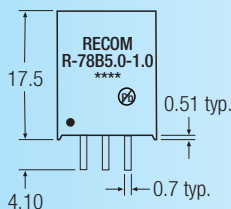

Recommended Footprint Details

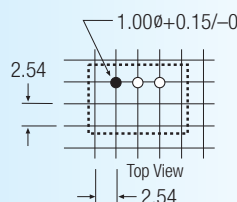

Pin Connections

Pin #	Connection
1	+Vin
2	GND
3	+Vout

xx.x ±0.5mm
xx.xx ±0.25mm