

PolySwitch Resettable Devices

Radial-leaded Devices

Raychem Circuit Protection has pioneered PPTC technology for over 25 years. Our radial-leaded products represent the widest range of product capabilities.

- RGEF series for hold currents up to 14A
- RHEF series for flatter thermal derating and operating temperatures up to 125°C
- RUEF series for balance of voltage rating (30V) and hold current (up to 9A)
- RUSBF series for fast time-to-trip and low-resistance computer applications
- RTEF series specifically designed for IEEE-1394 applications
- RXEF series for low hold currents (down to 50mA) and high voltage rating (up to 72V)
- LVR/LVRL series for line voltage applications up to a continuous operating voltage of 265V_{AC}/135V_{AC}
- BBRF series for cable telephone applications
- Now offering Pb-free versions of all products. For Pb-free versions of R-line products simply add an "F" to the end of the series description.

Whether for design or volume application, Raychem Circuit Protection's radial-leaded products represent the most comprehensive and complete set of PPTC products available in the industry today.

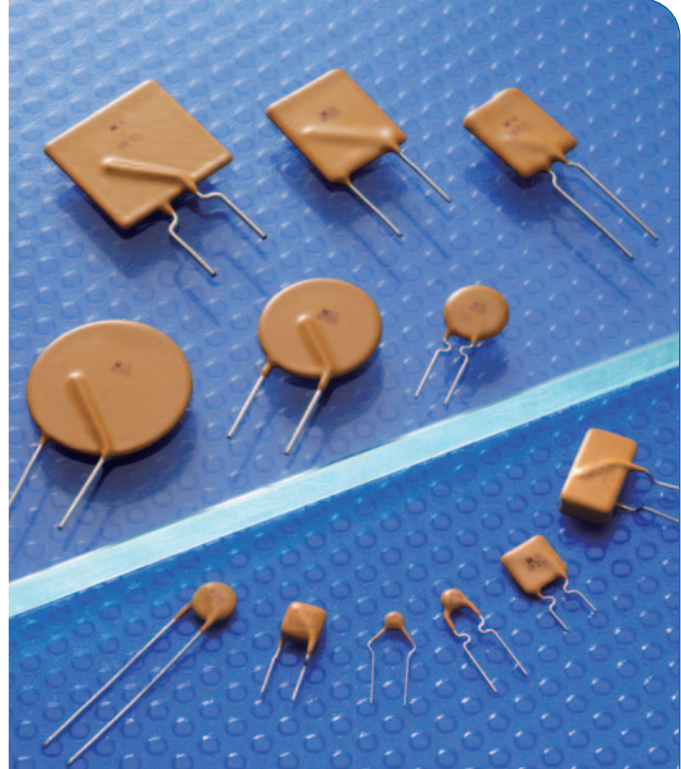

Benefits

- Many product choices give engineers more design flexibility
- Compatible with high-volume electronics assembly
- Assists in meeting regulatory requirements
- Higher voltage ratings allow use in new applications

Features

- Broadest range of radial-leaded resettable devices available in the industry
- Current ratings from 50mA to 15A
- Voltage ratings from 6V (computer and electronic applications) to 265V_{AC} line voltage applications
- Agency recognition : UL, CSA, TÜV
- Fast time-to-trip
- Low resistance

Applications

- | | | |
|-----------------------------|----------------------------------|---------------------------------|
| • Satellite video receivers | • USB hub, ports and peripherals | • Phones |
| • Industrial controls | • IEEE1394 ports | • Fax machines |
| • Transformers | • CD-ROMs | • Analog and digital line cards |
| • Computer motherboards | • Game machines | • Printers |
| • Modems | • Battery packs | |

Protection Application Selection Guide for Radial-leaded Devices

The guide below lists PolySwitch devices that are typically used in these applications.

Specifications for the suggested device part numbers can be found in this section.

Once a part number has been selected, the user should evaluate and test each product for its intended application.

Protection Application	PolySwitch Resettable Devices—Key Selection Criteria		
	Small Size	Flatter Derating	Lower Current Higher Voltage
Electromagnetic loads	RGEF (<16V), RUEF (<30V)	RHEF (<30V)	RXEF (<72V)
Halogen lighting	RGEF (<16V), RUEF (<30V)	RHEF (<30V)	RXEF (<72V)
Lighting ballast	RXEF (<72V), BBRF (<99V _{AC})		LVR (<265V _{AC})
Loudspeakers	RXEF (<72V)		RXEF (<72V)
Medical equipment	RGEF (<16V), RUEF (<30V)	RHEF (<30V)	RXEF (<72V)
MOSFET devices	RGEF (<16V), RUEF (<30V)	RHEF (<30V)	RXEF (<72V)
Motors, fans and blowers	RXEF (<72V), RGEF (<16V)	RHEF (<30V)	LVR (<265V _{AC})
POS equipment	RXEF (<72V), RUEF (<30V)		
Process and industrial controls	RXEF (<72V), RUEF (<30V)		
Satellite video receivers	RGEF (<16V), RUEF (<30V)	RHEF (<30V)	RXEF (<72V)
Security and fire alarm systems	RGEF (<16V), RUEF (<30V)	RHEF (<30V)	RXEF (<72V), LVR (<265V _{AC})
Test and measurement equipment	RGEF (<16V), RUEF (<30V)	RHEF (<30V)	RXEF (<72V), LVR (<265V _{AC})
Transformers	RGEF (<16V), RUEF (<30V)	RHEF (<30V)	RXEF (<72V), LVR (<265V _{AC})
UL 1950/FCC Part 68 requirements	RXEF (<72V)		
DDC computer and consumer electronics	RUEF (<30V)		
IEEE-1394 computer and consumer electronics	RTEF (<33V)		
Mouse and keyboard	RUEF (<30V)		
SCSI	RUEF (<30V)		
USB	RUSBF (<16V)		
Traces and printed circuit board protection	RGEF (<16V), RUEF (<30V)	RHEF (<30V)	RXEF (<72V)

This list is not exhaustive. Raychem Circuit Protection welcomes customer's input for additional application ideas for PolySwitch resettable devices.

Table R1 - Product Series - Current Rating, Voltage Rating/Typical Resistance for Radial-leaded Devices

Voltage Rating	LVR 265V _{AC}	LVRL 135V _{AC}	BBRF 99V	RXEF 72V	RXEF 60V	RTEF 33V	RUEF 30V	RGEF 16V	RHEF 16V	RHEF 30V	RUSBF 16V	RUSBF 6V
Hold Current (A)	—	—	—	—	—	—	—	—	—	—	—	—
0.050	25Ω	—	—	—	9.2Ω	—	—	—	—	—	—	—
0.080	9.8Ω	—	—	—	—	—	—	—	—	—	—	—
0.100	—	—	—	—	3.50Ω	—	—	—	—	—	—	—
0.110	—	—	—	—	—	—	—	—	—	—	—	—
0.120	4.8Ω	—	—	—	—	—	—	—	—	—	—	—
0.145	—	—	—	—	—	—	—	—	—	—	—	—
0.150	—	—	—	—	—	—	—	—	—	—	—	—
0.160	3.4Ω	—	—	—	—	—	—	—	—	—	—	—
0.170	—	—	—	—	4.30Ω	—	—	—	—	—	—	—
0.180	—	—	—	—	—	—	—	—	—	—	—	—
0.200	—	—	—	2.29Ω	—	—	—	—	—	—	—	—
0.250	1.7Ω	—	—	1.60Ω	—	—	—	—	—	—	—	—
0.300	—	—	—	1.11Ω	—	—	—	—	—	—	—	—
0.330	1.0Ω	—	—	—	—	—	—	—	—	—	—	—
0.400	0.80Ω	—	—	0.71Ω	—	—	—	—	—	—	—	—
0.500	—	—	—	0.64Ω	—	—	—	—	—	0.68Ω	—	—
0.550	0.59Ω	—	1.05Ω	—	—	—	—	—	—	—	—	—
0.650	—	—	—	0.40Ω	—	—	—	—	—	—	—	—
0.700	—	—	—	—	—	—	—	—	—	0.42Ω	—	—
0.750	—	0.325Ω	0.58Ω	0.325Ω	—	—	—	—	—	—	—	0.14Ω
0.900	—	—	—	0.255Ω	—	—	0.095Ω	—	—	—	0.10Ω	—
1.000	—	0.224Ω	—	—	—	—	—	—	—	0.24Ω	—	—
1.100	—	—	—	0.200Ω	—	—	0.075Ω	—	—	—	0.075Ω	—
1.200	—	—	—	—	—	0.097Ω	—	—	—	—	—	0.080Ω
1.250	—	0.148Ω	—	—	—	—	—	—	—	—	—	—
1.350	—	0.138Ω	—	0.155Ω	—	0.080Ω	0.060Ω	—	—	—	0.060Ω	—
1.550	—	—	—	—	—	—	—	—	—	—	—	0.058Ω
1.600	—	—	—	0.115Ω	—	—	0.050Ω	—	—	—	0.050Ω	—
1.850	—	—	—	0.100Ω	—	—	0.045Ω	—	—	—	0.045Ω	—
1.900	—	—	—	—	—	0.054Ω	—	—	—	—	—	—

Table R1 - Product Series - Current Rating, Voltage Rating/Typical Resistance for Radial-leaded Devices ... Cont'd

Voltage Rating	LVR 265V _{AC}	LVRL 135V _{AC}	BBRF 99V	RXEF 72V	RXEF 60V	RTEF 33V	RUEF 30V	RGEF 16V	RHEF 16V	RHEF 30V	RUSBF 16V	RUSBF 6V
Hold Current (A)	—	—	—	—	—	—	—	—	—	—	—	—
2.000	—	0.431Ω	—	—	—	—	—	—	0.061Ω	—	—	—
2.500	—	—	—	0.065Ω	—	—	0.030Ω	0.038Ω	—	—	0.030Ω	—
3.000	—	—	—	0.050Ω	—	—	0.035Ω	0.0514Ω	0.043Ω	—	—	—
3.750	—	—	—	0.040Ω	—	—	—	—	—	—	—	—
4.000	—	—	—	—	—	—	0.020Ω	0.030Ω	0.032Ω	—	—	—
4.500	—	—	—	—	—	—	—	—	0.029Ω	—	—	—
5.000	—	—	—	—	—	—	0.020Ω	0.0192Ω	—	—	—	—
5.500	—	—	—	—	—	—	—	—	0.020Ω	—	—	—
6.000	—	—	—	—	—	—	0.013Ω	0.0145Ω	0.0175Ω	—	—	—
6.500	—	—	—	—	—	—	—	—	0.0144Ω	—	—	—
7.000	—	—	—	—	—	—	0.013Ω	0.0105Ω	0.0132Ω	—	—	—
7.500	—	—	—	—	—	—	—	—	0.012Ω	—	—	—
8.000	—	—	—	—	—	—	0.013Ω	0.0086Ω	0.0110Ω	—	—	—
9.000	—	—	—	—	—	—	0.008Ω	0.0070Ω	0.010Ω	—	—	—
10.00	—	—	—	—	—	—	—	0.0056Ω	0.0083Ω	—	—	—
11.00	—	—	—	—	—	—	—	0.0050Ω	0.0073Ω	—	—	—
12.00	—	—	—	—	—	—	—	0.0046Ω	—	—	—	—
13.00	—	—	—	—	—	—	—	—	0.0055Ω	—	—	—
14.00	—	—	—	—	—	—	—	0.0040Ω	0.005Ω	—	—	—
15.00	—	—	—	—	—	—	—	—	0.005Ω	—	—	—

Table R2 - Thermal Derating for Radial-leaded Devices [Hold Current (A) at Ambient Temperature (°C)]

Part Number	Maximum Ambient Temperature											
	-40°C	-20°C	0°C	20°C	25°C	40°C	50°C	60°C	70°C	85°C	125°C	
LVR/LVRL 240V_{AC}/120V_{AC}												
LVR005	—	0.08	0.06	0.05	0.05	0.04	0.04	0.03	0.03	0.02	—	
LVR008	—	0.12	0.10	0.08	0.08	0.07	0.06	0.05	0.04	0.03	—	
LVR012	—	0.18	0.15	0.12	0.12	0.10	0.09	0.07	0.06	0.04	—	
LVR016	—	0.24	0.20	0.16	0.16	0.13	0.11	0.10	0.08	0.05	—	
LVR025	—	0.38	0.32	0.26	0.25	0.21	0.18	0.15	0.13	0.09	—	
LVR033	—	0.50	0.42	0.34	0.33	0.27	0.23	0.20	0.17	0.11	—	
LVR040	—	0.61	0.51	0.41	0.40	0.33	0.28	0.24	0.20	0.14	—	
LVR055K	—	0.80	0.68	0.55	0.54	0.46	0.40	0.35	0.29	0.22	—	
LVR055S	—	0.80	0.68	0.55	0.54	0.46	0.40	0.35	0.29	0.22	—	
New LVRL075S	—	1.08	0.93	0.75	0.74	0.64	0.57	0.51	0.44	0.35	—	
New LVRL100S	—	1.40	1.19	1.00	0.94	0.82	0.73	0.65	0.57	0.45	—	
New LVRL125S	—	1.80	1.53	1.25	1.20	1.04	0.94	0.83	0.73	0.60	—	
New LVRL135S	—	2.00	1.65	1.35	1.29	1.12	1.01	0.90	0.78	0.65	—	
New LVRL200S	—	3.05	2.55	2.00	1.97	1.72	1.55	1.39	1.22	0.98	—	
BBRF 99V_{AC}												
BBRF550	0.85	0.75	0.65	0.55	—	0.45	0.40	0.35	0.30	0.22	—	
BBRF750	1.15	1.00	0.90	0.75	—	0.61	0.55	0.48	0.41	0.30	—	
RXEF 60V												
RXEF005	0.078	0.068	0.06	0.05	0.048	0.04	0.035	0.032	0.027	0.02	—	
RXEF010	0.16	0.14	0.11	0.10	0.096	0.08	0.072	0.067	0.05	0.04	—	
RXEF017	0.26	0.23	0.21	0.17	0.16	0.14	0.12	0.11	0.09	0.07	—	
RXEF 72V												
RXEF020	0.31	0.27	0.24	0.20	0.19	0.16	0.14	0.13	0.11	0.08	—	
RXEF025	0.39	0.34	0.30	0.25	0.24	0.20	0.18	0.16	0.14	0.10	—	
RXEF030	0.47	0.41	0.36	0.30	0.29	0.24	0.22	0.20	0.16	0.12	—	
RXEF040	0.62	0.54	0.48	0.40	0.38	0.32	0.29	0.25	0.22	0.16	—	
RXEF050	0.78	0.68	0.60	0.50	0.48	0.41	0.36	0.32	0.27	0.20	—	
RXEF065	1.01	0.88	0.77	0.65	0.62	0.53	0.47	0.41	0.35	0.26	—	
RXEF075	1.16	1.02	0.89	0.75	0.72	0.61	0.54	0.47	0.41	0.30	—	
RXEF090	1.40	1.22	1.07	0.90	0.86	0.73	0.65	0.57	0.49	0.36	—	

Table R2 - Thermal Derating for Radial-leaded Devices [Hold Current (A) at Ambient Temperature (°C)] ... Cont'd

Part Number	Maximum Ambient Temperature										
	-40°C	-20°C	0°C	20°C	25°C	40°C	50°C	60°C	70°C	85°C	125°C
RXEF 72V											
RXEF110	1.71	1.50	1.31	1.10	1.06	0.89	0.79	0.69	0.59	0.44	—
RXEF135	2.09	1.84	1.61	1.35	1.30	1.09	0.97	0.85	0.73	0.54	—
RXEF160	2.48	2.18	1.90	1.60	1.54	1.30	1.15	1.01	0.86	0.64	—
RXEF185	2.87	2.52	2.20	1.85	1.78	1.50	1.33	1.17	1.00	0.74	—
RXEF250	3.88	3.40	2.98	2.50	2.40	2.03	1.80	1.58	1.35	1.00	—
RXEF300	4.65	4.08	3.57	3.00	2.88	2.43	2.16	1.89	1.62	1.20	—
RXEF375	5.81	5.10	4.46	3.75	3.60	3.04	2.70	2.36	2.03	1.50	—
RTEF 33V											
RTEF120	1.74	1.56	1.38	1.20	1.16	1.00	0.92	0.82	0.73	0.60	—
RTEF135	1.96	1.76	1.55	1.35	1.31	1.12	1.04	0.92	0.82	0.68	—
RTEF190	2.76	2.47	2.19	1.90	1.84	1.58	1.50	1.29	1.16	0.95	—
RUEF 30V											
RUEF090	1.31	1.17	1.04	0.90	0.87	0.75	0.69	0.61	0.55	0.47	—
RUEF110	1.60	1.43	1.27	1.10	1.07	0.91	0.85	0.75	0.67	0.57	—
RUEF135	1.96	1.76	1.55	1.35	1.31	1.12	1.04	0.92	0.82	0.70	—
RUEF160	2.32	2.08	1.84	1.60	1.55	1.33	1.23	1.09	0.98	0.83	—
RUEF185	2.68	2.41	2.13	1.85	1.79	1.54	1.42	1.26	1.13	0.96	—
RUEF250	3.63	3.25	2.88	2.5	2.43	2.08	1.93	1.70	1.53	1.30	—
RUEF300	4.35	3.90	3.45	3.0	2.91	2.49	2.31	2.04	1.83	1.56	—
RUEF400	5.80	5.20	4.60	4.0	3.88	3.32	3.08	2.72	2.44	2.08	—
RUEF500	7.25	6.50	5.75	5.0	4.85	4.15	3.85	3.40	3.05	2.60	—
RUEF600	8.70	7.80	6.90	6.0	5.82	4.98	4.62	4.08	3.66	3.12	—
RUEF700	10.15	9.10	8.05	7.0	6.79	5.81	5.39	4.76	4.27	3.64	—
RUEF800	11.60	10.40	9.20	8.0	7.76	6.64	6.16	5.44	4.88	4.16	—
RUEF900	13.05	11.70	10.35	9.0	8.73	7.47	6.93	6.12	5.49	4.68	—
RHEF 30V - High Temperature											
RHEF050	0.68	0.62	0.56	0.51	0.5	0.44	0.40	0.36	0.34	0.28	0.12
RHEF070	0.95	0.87	0.79	0.72	0.7	0.62	0.56	0.51	0.47	0.39	0.17
RHEF100	1.36	1.24	1.13	1.03	1.00	0.89	0.80	0.73	0.67	0.56	0.24
RUSBF 16V											
RUSBF090	1.31	1.17	1.04	0.90	0.87	0.75	0.69	0.61	0.55	0.47	—
RUSBF110	1.60	1.43	1.27	1.10	1.07	1.00	0.92	0.75	0.67	0.57	—
RUSBF135	1.96	1.76	1.55	1.35	1.31	1.12	1.04	0.92	0.82	0.70	—
RUSBF160	2.32	2.08	1.84	1.60	1.55	1.33	1.23	1.09	0.98	0.83	—
RUSBF185	2.68	2.41	2.13	1.85	1.79	1.54	1.42	1.26	1.13	0.96	—
RUSBF250	3.63	3.25	2.88	2.50	2.43	2.08	1.93	1.70	1.53	1.30	—
RGEF 16V - High Temperature											
RGEF250	3.7	3.3	3.0	2.6	2.5	2.2	2.0	1.3	1.6	1.2	—
RGEF300	4.4	4.0	3.6	3.1	3.0	2.6	2.4	2.1	1.9	1.4	—
RGEF400	5.9	5.3	4.8	4.1	4.0	3.5	3.2	2.8	2.5	1.9	—
RGEF500	7.3	6.6	6.0	5.2	5.0	4.4	4.0	3.6	3.1	2.4	—
RGEF600	8.8	8.0	7.2	6.2	6.0	5.2	4.8	4.2	3.8	2.8	—
RGEF700	10.3	9.3	8.4	7.3	7.0	6.2	5.6	5.0	4.4	3.3	—
RGEF800	11.7	10.7	9.6	8.3	8.0	6.9	6.4	5.6	5.1	3.7	—
RGEF900	13.2	11.9	10.7	9.4	9.0	7.9	7.2	6.4	5.6	4.2	—
RGEF1000	14.7	13.3	12.0	10.3	10.0	8.7	8.0	7.0	6.3	4.7	—
RGEF1100	16.1	14.6	13.1	11.5	11.0	9.7	8.8	7.8	6.9	5.2	—
RGEF1200	17.6	16.0	14.4	12.4	12.0	10.4	9.6	8.4	7.6	5.6	—
RGEF1400	20.5	18.7	16.8	14.5	14.0	12.1	11.2	9.8	8.9	6.5	—
RHEF 16V - High Temperature											
RHEF200	2.71	2.49	2.26	2.06	2.00	1.77	1.60	1.46	1.34	1.11	0.49
New RHEF300	4.07	3.74	3.41	3.09	3.00	2.65	2.40	2.21	2.00	1.66	0.74
RHEF400	5.57	5.11	4.65	4.22	4.00	3.62	3.29	3.01	2.73	2.27	1.01
RHEF450	6.10	5.60	5.10	4.60	4.50	4.00	3.60	3.30	3.00	2.50	1.10
New RHEF550	7.47	6.86	6.24	5.66	5.50	4.85	4.41	4.04	3.66	3.05	1.36
RHEF600	8.20	7.50	6.80	6.20	6.00	5.30	4.90	4.40	4.00	3.30	1.50

Table R2 - Thermal Derating for Radial-led Devices [Hold Current (A) at Ambient Temperature (°C)] ... Cont'd

Part Number	Maximum Ambient Temperature										
	-40°C	-20°C	0°C	20°C	25°C	40°C	50°C	60°C	70°C	85°C	125°C
RHEF 16V - High Temperature											
RHEF650	8.80	8.10	7.40	6.70	6.50	5.70	5.30	4.80	4.30	3.60	1.60
New RHEF700	9.51	8.73	7.95	7.20	7.00	6.17	5.61	5.15	4.66	3.88	1.73
RHEF750	10.20	9.40	8.60	7.70	7.50	6.60	6.10	5.60	5.00	4.10	1.90
New RHEF800	10.87	9.98	9.08	8.23	8.00	7.06	6.41	5.88	5.33	4.43	1.97
RHEF900	12.21	11.19	10.16	9.26	9.00	7.97	7.20	6.56	6.04	5.01	2.19
RHEF1000	13.60	12.50	11.40	10.30	10.00	8.80	8.10	7.40	6.60	5.50	2.50
New RHEF1100	14.94	13.72	12.49	11.31	11.00	9.70	8.82	8.09	7.32	6.09	2.71
RHEF1300	17.70	16.30	14.80	13.40	13.00	11.40	10.50	9.60	8.60	7.20	3.30
New RHEF1400	19.01	17.46	15.89	14.40	14.00	12.35	11.22	10.29	9.32	7.76	3.45
RHEF1500	20.40	18.80	17.10	15.50	15.00	13.20	12.10	11.10	9.90	8.30	3.80
RUSBF 6V											
RUSBF075	1.05	0.95	0.85	0.75	0.73	0.65	0.60	0.55	0.50	0.43	—
RUSBF120	1.69	1.52	1.36	1.20	1.16	1.04	0.96	0.88	0.80	0.68	—
RUSBF155	2.17	1.96	1.75	1.55	1.50	1.34	1.24	1.14	1.03	0.88	—

Figures R1-R5 - Thermal Derating Curve for Radial-led Devices

A=LVR

B=LVRL

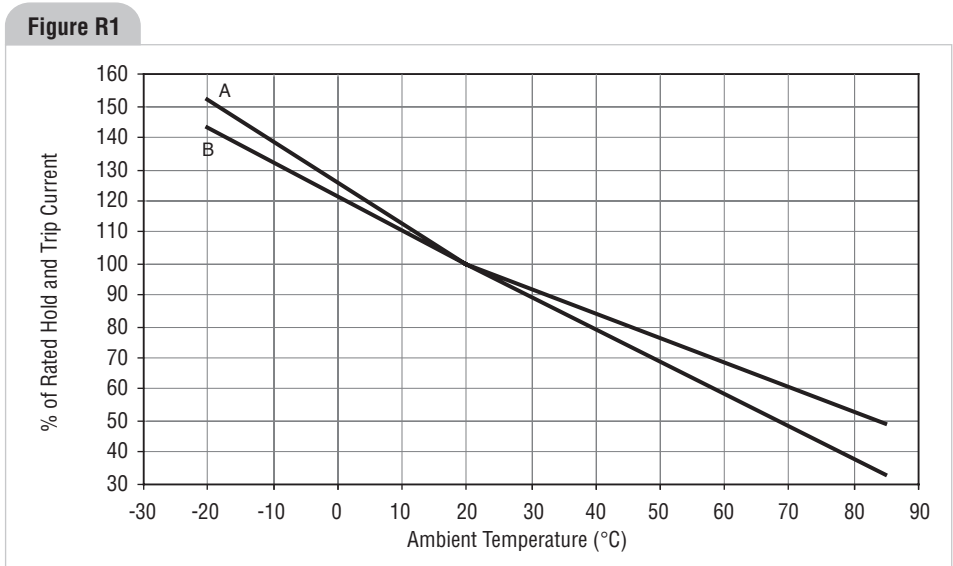

RXEF and
BBRF

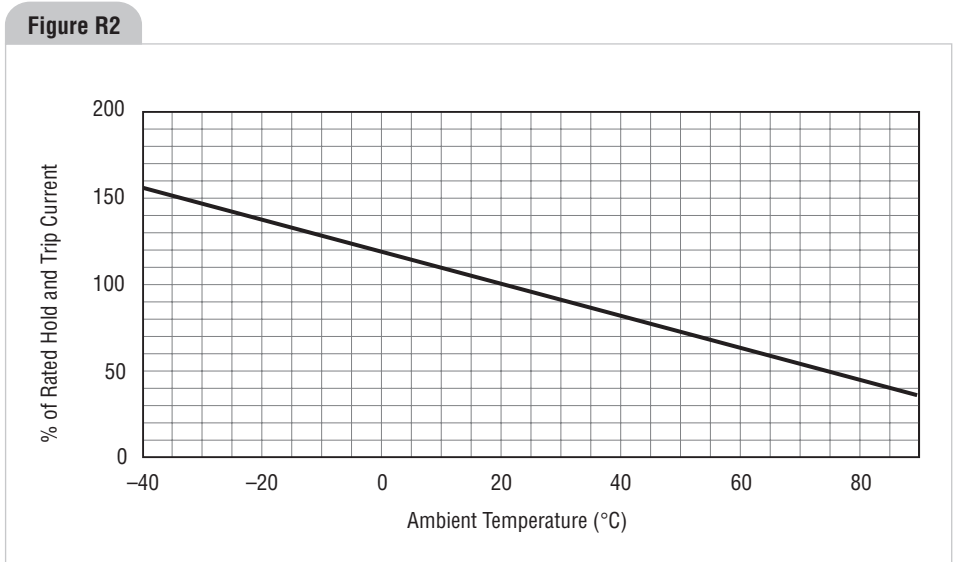

Figures R1-R5 - Thermal Derating Curve for Radial-leaded Devices

... Cont'd

**A = RUSBF075,
RUSBF120,
RUSBF155**

**B = RUEF,
RTEF,
and all other
RUSBF**

Figure R3

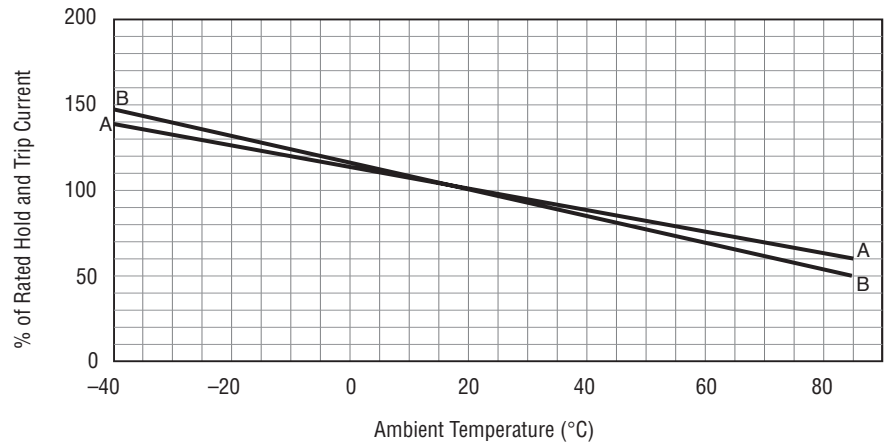

RHEF

Figure R4

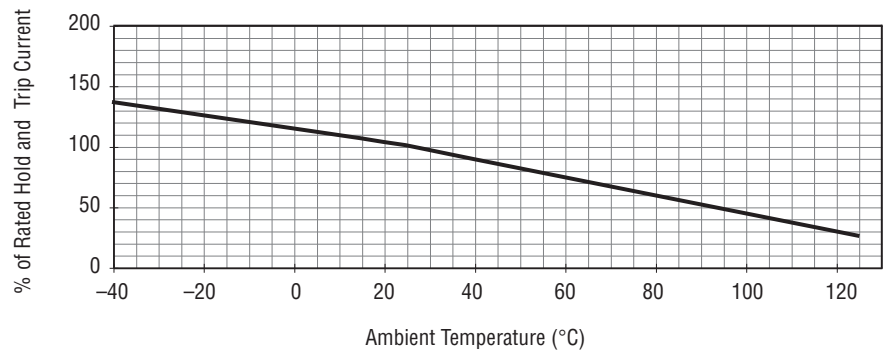

RGEF

Figure R5

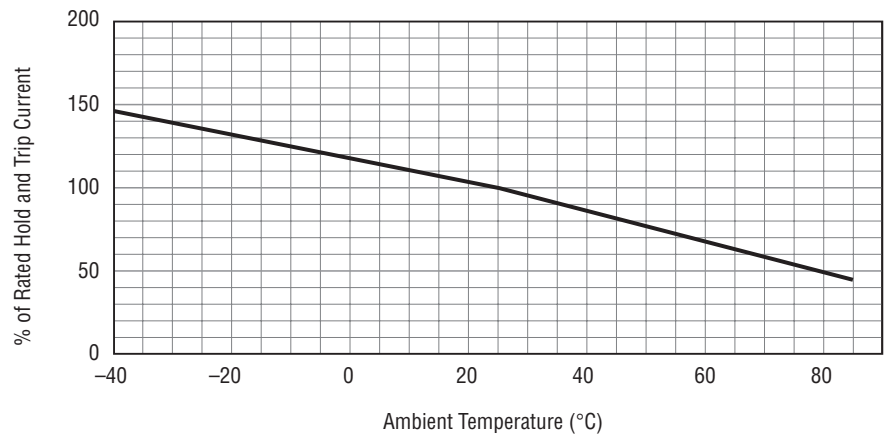

Table R3 - Electrical Characteristics for Radial-leaded Devices

Part Number	I _H (A)	I _T (A)	V _{Max} (V)	V _{Max} (V _{AC})	Interrupt (A)	I _{Max} (A)	P _{D TYP} (W)	Max. Time-to-trip (s)	R _{Min} (Ω)	R _{MAX} (Ω)	R _{1,Max} (Ω)	Figure for Dimensions	Lead Size [mm ² (AWG)]
■ LVR/LVRL 240V_{AC}/120V_{AC}													
LVR005K	0.05	0.12	240	265	1.0	0.7	0.25	15.0	18.50	31.00	65.00	R7	[0.205mm ² (24)]
LVR005S	0.05	0.12	240	265	1.0	0.7	0.25	15.0	18.50	31.00	65.00	R7	[0.205mm ² (24)]
LVR008K	0.08	0.19	240	265	1.2	0.8	0.40	15.0	7.40	12.00	26.00	R7	[0.205mm ² (24)]
LVR008S	0.08	0.19	240	265	1.2	0.8	0.40	15.0	7.40	12.00	26.00	R7	[0.205mm ² (24)]
LVR012K	0.12	0.30	240	265	1.2	1.0	0.60	15.0	3.00	6.50	12.00	R7	[0.205mm ² (24)]
LVR012S	0.12	0.30	240	265	1.2	1.0	0.60	15.0	3.00	6.50	12.00	R7	[0.205mm ² (24)]
LVR016K	0.16	0.37	240	265	2.0	1.4	0.80	15.0	2.50	4.10	7.80	R7	[0.205mm ² (24)]
LVR016S	0.16	0.37	240	265	2.0	1.4	0.80	15.0	2.50	4.10	7.80	R7	[0.205mm ² (24)]
LVR025K	0.25	0.56	240	265	3.5	1.5	1.25	18.5	1.30	2.10	3.80	R8	[0.33mm ² (22)]
LVR025S	0.25	0.56	240	265	3.5	1.5	1.25	18.5	1.30	2.10	3.80	R8	[0.33mm ² (22)]
LVR033S	0.33	0.74	240	265	4.5	1.7	1.25	18.5	0.83	1.24	2.60	R8	[0.33mm ² (22)]
LVR033K	0.33	0.74	240	265	4.5	1.7	1.25	18.5	0.83	1.24	2.60	R8	[0.33mm ² (22)]
LVR040K	0.40	0.90	240	265	5.5	2.0	2.00	24.0	0.60	0.97	1.90	R8	[0.33mm ² (22)]
LVR040S	0.40	0.90	240	265	5.5	2.0	2.00	24.0	0.60	0.97	1.90	R8	[0.33mm ² (22)]
LVR055K	0.55	1.25	240	265	7.0	3.4	2.75	26.0	0.45	0.73	1.45	R8	[0.52mm ² (20)]
LVR055S	0.55	1.25	240	265	7.0	3.4	2.75	26.0	0.45	0.73	1.45	R8	[0.52mm ² (20)]
New LVRL075S	0.75	1.52	120	135	7.5	1.8	3.75	14.4	0.25	0.39	0.69	R8	[0.81mm ² (20)]
New LVRL100S	1.00	2.00	120	135	10.0	2.2	5.00	13.6	0.18	0.27	0.47	R8	[0.81mm ² (20)]
New LVRL125S	1.25	2.50	120	135	12.5	2.0	6.25	20.0	0.11	0.18	0.33	R8	[0.81mm ² (20)]
New LVRL135S	1.35	2.70	120	135	13.5	2.8	6.75	20.0	0.11	0.17	0.30	R8	[0.81mm ² (20)]
New LVRL200S	2.00	4.20	120	135	20.0	3.9	10.00	36.0	0.08	0.12	0.21	R8	[0.81mm ² (20)]
■ BBRF 99V_{AC}													
BBRF550	0.55	1.1	99	—	20	1.5	1.60	60	0.8	1.30	1.95	R6, R15, R16	[0.52mm ² (20)]
BBRF750	0.75	1.5	99	—	20	1.7	2.00	60	0.4	0.75	1.20	R6, R15, R16	[0.52mm ² (20)]
■ RXEF 60V													
RXEF005	0.05	0.10	60	—	40	0.26	0.25	5.0	7.3	11.10	20.0	R9, R15, R16	[0.128mm ² (26)]
RXEF010	0.10	0.20	60	—	40	0.38	0.50	4.0	2.5	4.50	7.5	R10, R15, R16	[0.205mm ² (24)]
RXEF017	0.17	0.34	60	—	40	0.48	0.85	3.0	3.3	5.21	8.0	R10, R15, R16	[0.205mm ² (24)]
■ RXEF 72V													
RXEF020	0.20	0.40	72	—	40	0.41	1.00	2.2	1.83	2.75	4.40	R10, R15, R16	[0.205mm ² (24)]
RXEF025	0.25	0.50	72	—	40	0.45	1.25	2.5	1.25	1.95	3.00	R10, R15, R16	[0.205mm ² (24)]
RXEF030	0.30	0.60	72	—	40	0.49	1.50	3.0	0.88	1.33	2.10	R10, R15, R16	[0.205mm ² (24)]
RXEF040	0.40	0.80	72	—	40	0.56	2.00	3.8	0.55	0.86	1.29	R10, R15, R16	[0.205mm ² (24)]
RXEF050	0.50	1.00	72	—	40	0.77	2.50	4.0	0.50	0.77	1.17	R10, R15, R16	[0.205mm ² (24)]
RXEF065	0.65	1.30	72	—	40	0.88	3.25	5.3	0.31	0.48	0.72	R10, R15, R16	[0.205mm ² (24)]
RXEF075	0.75	1.50	72	—	40	0.92	3.75	6.3	0.25	0.40	0.60	R10, R15, R16	[0.205mm ² (24)]
RXEF090	0.90	1.80	72	—	40	0.99	4.50	7.2	0.20	0.31	0.47	R10, R15, R16	[0.205mm ² (24)]
RXEF110	1.10	2.20	72	—	40	1.50	5.50	8.2	0.15	0.25	0.38	R11, R15, R16	[0.52mm ² (20)]
RXEF135	1.35	2.70	72	—	40	1.70	6.75	9.6	0.12	0.19	0.30	R11, R15, R16	[0.52mm ² (20)]
RXEF160	1.60	3.20	72	—	40	1.90	8.00	11.4	0.09	0.14	0.22	R11, R15, R16	[0.52mm ² (20)]
RXEF185	1.85	3.70	72	—	40	2.10	9.25	12.6	0.08	0.12	0.19	R11, R15, R16	[0.52mm ² (20)]
RXEF250	2.50	5.00	72	—	40	2.50	12.50	15.6	0.05	0.08	0.13	R11, R15, R16	[0.52mm ² (20)]
RXEF300	3.00	6.00	72	—	40	2.80	15.00	19.8	0.04	0.06	0.10	R11, R15, R16	[0.52mm ² (20)]
RXEF375	3.75	7.50	72	—	40	3.20	18.75	24.0	0.03	0.05	0.08	R11, R15, R16	[0.52mm ² (20)]
■ RTEF 33V													
RTEF120	1.20	2.3	33	—	40	0.78	6.00	3.5	0.074	0.12	0.18	R12, R15, R16	[0.205mm ² (24)]
RTEF135	1.35	2.5	33	—	40	0.84	6.75	4.5	0.059	0.10	0.143	R12, R15, R16	[0.205mm ² (24)]
RTEF190	1.90	3.0	33	—	40	0.90	9.50	3.5	0.045	0.063	0.092	R12, R15, R16	[0.205mm ² (24)]
■ RUEF 30V													
RUEF090	0.90	1.8	30	—	100	0.6	4.50	5.9	0.070	0.12	0.22	R12, R15, R16	[0.205mm ² (24)]
RUEF110	1.10	2.2	30	—	100	0.7	5.50	6.6	0.070	0.10	0.17	R12, R15, R16	[0.205mm ² (24)]
RUEF135	1.35	2.7	30	—	100	0.8	6.75	7.3	0.040	0.08	0.13	R12, R15, R16	[0.205mm ² (24)]
RUEF160	1.60	3.2	30	—	100	0.9	8.50	8.0	0.030	0.07	0.11	R12, R15, R16	[0.205mm ² (24)]
RUEF185	1.85	3.7	30	—	100	1.0	9.25	8.7	0.030	0.06	0.09	R12, R15, R16	[0.205mm ² (24)]
RUEF250	2.5	5.0	30	—	100	1.2	12.50	10.3	0.020	0.04	0.07	R12, R15, R16	[0.205mm ² (24)]
RUEF300	3.0	6.0	30	—	100	2.0	15.00	10.8	0.020	0.05	0.08	R13, R15, R16	[0.52mm ² (20)]

Table R3 - Electrical Characteristics for Radial-leaded Devices

... **Cont'd**

Part Number	I _H (A)	I _T (A)	V _{Max} (V)	V _{Max} Interrupt (V _{AC})	I _{Max} (A)	P _D TYP (W)	Max. Time-to-trip (s)	R _{Min} (Ω)	R _{Max} (Ω)	R ₁ Max (Ω)	Figures for Dimensions	Lead Size [mm ² (AWG)]
■ RUEF 30V												
RUEF400	4.0	8.0	30	—	100	2.5	20.0	12.7	0.010	0.03	0.05	R13, R15, R16 [0.52mm ² (20)]
RUEF500	5.0	10.0	30	—	100	3.0	25.0	14.5	0.010	0.03	0.05	R13, R15, R16 [0.52mm ² (20)]
RUEF600	6.0	12.0	30	—	100	3.5	30.0	16.0	0.005	0.02	0.04	R13, R15, R16 [0.52mm ² (20)]
RUEF700	7.0	14.0	30	—	100	3.8	35.0	17.5	0.005	0.02	0.03	R13, R15, R16 [0.52mm ² (20)]
RUEF800	8.0	16.0	30	—	100	4.0	40.0	18.8	0.005	0.013	0.02	R13, R15, R16 [0.52mm ² (20)]
RUEF900	9.0	18.0	30	—	100	4.2	45.0	20.0	0.005	0.01	0.02	R13, R15, R16 [0.52mm ² (20)]
■ RHEF 30V - High Temperature*												
RHEF050	0.50	0.90	30	—	40	0.9	2.5	2.5	0.48	0.79	1.10	R10, R15, R16 [0.205mm ² (24)]
RHEF070	0.7	1.4	30	—	40	1.4	3.5	4.0	0.30	0.54	0.80	R12, R15, R16 [0.205mm ² (24)]
RHEF100	1.0	1.8	30	—	40	1.4	5.0	5.2	0.18	0.31	0.43	R10, R15, R16 [0.205mm ² (24)]
■ RUSBF 16V												
RUSBF090	0.90	1.8	16	—	40	0.6	8.0	1.2	0.070	0.120	0.180	R12, R15, R16 [0.205mm ² (24)]
RUSBF110	1.10	2.2	16	—	40	0.7	8.0	2.3	0.050	0.095	0.140	R12, R15, R16 [0.205mm ² (24)]
RUSBF135	1.35	2.7	16	—	40	0.8	8.0	4.5	0.040	0.074	0.115	R12, R15, R16 [0.205mm ² (24)]
RUSBF160	1.60	3.2	16	—	40	0.9	8.0	9.0	0.030	0.061	0.110	R12, R15, R16 [0.205mm ² (24)]
RUSBF185	1.85	3.7	16	—	40	1.0	8.0	10.0	0.030	0.051	0.090	R12, R15, R16 [0.205mm ² (24)]
RUSBF250	2.5	5.0	16	—	40	1.2	8.0	40.0	0.020	0.036	0.060	R12, R15, R16 [0.205mm ² (24)]
■ RGEF 16V												
RGEF250	2.5	4.7	16	—	100	1.0	12.5	5.0	0.022	0.035	0.053	R12, R15, R16 [0.205mm ² (24)]
RGEF300	3.0	5.1	16	—	100	2.3	15.0	1.0	0.038	0.0645	0.0975	R13, R15, R16 [0.52mm (20)]
RGEF400	4.0	6.8	16	—	100	2.4	20.0	1.7	0.021	0.0385	0.0600	R13, R15, R16 [0.52mm ² (20)]
RGEF500	5.0	8.5	16	—	100	2.6	25.0	2.0	0.015	0.0230	0.0340	R13, R15, R16 [0.52mm (20)]
RGEF600	6.0	10.2	16	—	100	2.8	30.0	3.3	0.010	0.0185	0.0280	R13, R15, R16 [0.52mm ² (20)]
RGEF700	7.0	11.9	16	—	100	3.0	35.0	3.5	0.0077	0.0130	0.0200	R13, R15, R16 [0.52mm ² (20)]
RGEF800	8.0	13.6	16	—	100	3.0	40.0	5.0	0.0056	0.0110	0.0175	R13, R15, R16 [0.52mm ² (20)]
RGEF900	9.0	15.3	16	—	100	3.3	45.0	5.5	0.0047	0.0092	0.0135	R13, R15, R16 [0.52mm ² (20)]
RGEF1000	10.0	17.0	16	—	100	3.6	50.0	6.0	0.0040	0.0071	0.0102	R13, R15, R16 [0.52mm ² (20)]
RGEF1100	11.0	18.7	16	—	100	3.7	55.0	7.0	0.0037	0.0062	0.0089	R13, R15, R16 [0.52mm ² (20)]
RGEF1200	12.0	20.4	16	—	100	4.2	60.0	7.5	0.0033	0.00595	0.0086	R13, R15, R16 [0.823mm ² (18)]
RGEF1400	14.0	23.8	16	—	100	4.6	70.0	9.0	0.0026	0.00445	0.0064	R13, R15, R16 [0.823mm ² (18)]
■ RHEF High Temperature* 16V												
RHEF200	2.0	3.8	16	—	100	1.4	12.5	3.0	0.045	0.074	0.11	R10, R15, R16 [0.205mm ² (24)]
New RHEF300	3.0	6.0	16	—	100	3.0	15.0	5.0	0.033	0.053	0.079	R14, R15, R16 [0.52mm ² (20)]
RHEF400	4.0	7.0	16	—	100	3.3	20.0	5.0	0.024	0.040	0.060	R14, R15, R16 [0.52mm ² (20)]
RHEF450	4.5	7.8	16	—	100	3.6	22.5	3.0	0.022	0.0355	0.054	R14, R15, R16 [0.52mm ² (20)]
New RHEF550	5.5	10.0	16	—	100	3.5	27.5	6.0	0.015	0.025	0.037	R14, R15, R16 [0.52mm ² (20)]
RHEF600	6.0	10.8	16	—	100	4.1	30.0	5.0	0.013	0.0215	0.032	R14, R15, R16 [0.52mm ² (20)]
RHEF650	6.5	12.0	16	—	100	4.3	32.5	5.5	0.011	0.0175	0.026	R14, R15, R16 [0.52mm ² (20)]
New RHEF700	7.0	13.0	16	—	100	4.0	35.0	7.0	0.010	0.016	0.025	R14, R15, R16 [0.52mm ² (20)]
RHEF750	7.5	13.1	16	—	100	4.5	37.5	7.0	0.0094	0.0150	0.022	R14, R15, R16 [0.52mm ² (20)]
New RHEF800	8.0	15.0	16	—	100	4.2	40.0	8.0	0.008	0.0135	0.020	R14, R15, R16 [0.52mm ² (20)]
RHEF900	9.0	16.5	16	—	100	5.0	45.0	10.0	0.0074	0.0120	0.017	R14, R15, R16 [0.52mm ² (20)]
RHEF1000	10.0	18.5	16	—	100	5.3	50.0	9.0	0.0062	0.0103	0.015	R14, R15, R16 [0.52mm ² (20)]
New RHEF1100	11.0	20.0	16	—	100	5.5	55.0	11.0	0.0055	0.009	0.013	R14, R15, R16 [0.52mm ² (20)]
RHEF1300	13.0	24.0	16	—	100	6.9	65.0	13.0	0.0041	0.0068	0.010	R14, R15, R16 [0.823mm ² (18)]
New RHEF1400	14.0	27.0	16	—	100	6.9	70.0	13.0	0.003	0.006	0.009	R14, R15, R16 [0.823mm ² (18)]
RHEF1500	15.0	28.0	16	—	100	7.0	75.0	20.0	0.0032	0.0063	0.0092	R14, R15, R16 [0.823mm ² (18)]
■ RUSBF 6V												
RUSBF075	0.75	1.30	6	—	40	0.3	8.0	0.4	0.110	0.175	0.23	R10, R15, R16 [0.205mm ² (24)]
RUSBF120	1.20	2.00	6	—	40	0.6	8.0	0.5	0.065	0.0975	0.14	R10, R15, R16 [0.205mm ² (24)]
RUSBF155	1.55	2.65	6	—	40	0.6	8.0	0.5	0.043	0.0705	0.10	R10, R15, R16 [0.205mm ² (24)]

Notes:

- I_H : Hold current: maximum current device will pass without interruption in 20°C still air.
- I_T : Trip current: minimum current that will switch the device from low resistance to high resistance in 20°C still air.
- R_{min} : Minimum resistance of device as supplied at 20°C unless otherwise specified.
- R_{max} : Maximum resistance of device as supplied at 20°C unless otherwise specified.
- V_{max} : Maximum continuous voltage device can withstand without damage at rated current.
- V_{max} Interrupt : Under specified conditions this is the highest voltage that can be applied to the device at the maximum current.
- I_{max} : Maximum fault current device can withstand without damage at rated voltage.
- P_D : Power dissipated from device when in the tripped state in 20°C still air.
- R_{1max} : Maximum resistance of device when measured one hour post reflow (surface-mount device) or one hour post trip (radial-leaded device) at 20°C unless otherwise specified.

* Electrical characteristics determined at 25°C

Table R4 - Dimensions for Radial-leaded Devices in Millimeters (Inches)



Part Number	Dimension												Figure	
	A		B		C		D		E		F	H		J
	Min.	Max.	Min.	Max.	Min.	Max.	Min.	Max.	Min.	Max.	TYP.	TYP.		TYP.
 LVR/LVRL 240V/120V														
LVR005K	—	8.3	—	12.9	—	3.8	7.6	—	4.3	5.8	—	—	—	R7
	—	(0.33)	—	(0.51)	—	(0.15)	(0.30)	—	(0.17)	(0.23)	—	—	—	
LVR005S	—	8.3	—	10.7	—	3.8	7.6	—	4.3	5.8	—	—	—	R7
	—	(0.33)	—	(0.43)	—	(0.15)	(0.30)	—	(0.17)	(0.23)	—	—	—	
LVR008K	—	8.3	—	12.9	—	3.8	7.6	—	4.3	5.8	—	—	—	R7
	—	(0.33)	—	(0.51)	—	(0.15)	(0.30)	—	(0.17)	(0.23)	—	—	—	
LVR008S	—	8.3	—	10.7	—	3.8	7.6	—	4.3	5.8	—	—	—	R7
	—	(0.33)	—	(0.43)	—	(0.15)	(0.30)	—	(0.17)	(0.23)	—	—	—	
LVR012K	—	8.3	—	12.9	—	3.8	7.6	—	4.3	5.8	—	—	—	R7
	—	(0.33)	—	(0.51)	—	(0.15)	(0.30)	—	(0.17)	(0.23)	—	—	—	
LVR012S	—	8.3	—	10.7	—	3.8	7.6	—	4.3	5.8	—	—	—	—
	—	(0.33)	—	(0.43)	—	(0.15)	(0.30)	—	(0.17)	(0.23)	—	—	—	
LVR016K	—	9.9	—	13.8	—	3.8	7.6	—	4.3	5.8	—	—	—	R7
	—	(0.39)	—	(0.54)	—	(0.15)	(0.30)	—	(0.17)	(0.23)	—	—	—	
LVR016S	—	9.9	—	12.5	—	3.8	7.6	—	4.3	5.8	—	—	—	R7
	—	(0.39)	—	(0.50)	—	(0.15)	(0.30)	—	(0.17)	(0.23)	—	—	—	
LVR025K	—	9.6	—	18.8	—	3.8	7.6	—	4.3	5.8	—	—	—	R8
	—	(0.38)	—	(0.74)	—	(0.15)	(0.30)	—	(0.17)	(0.23)	—	—	—	
LVR025S	—	9.6	—	17.4	—	3.8	7.6	—	4.3	5.8	—	—	—	R8
	—	(0.38)	—	(0.69)	—	(0.15)	(0.30)	—	(0.17)	(0.23)	—	—	—	
LVR033S	—	11.4	—	16.5	4.3	5.8	7.6	—	—	3.8	—	—	—	R8
	—	(0.45)	—	(0.65)	(0.17)	(0.23)	(0.30)	—	—	(0.15)	—	—	—	
LVR033K	—	11.4	—	19.0	4.3	5.8	7.6	—	—	3.8	—	—	—	R8
	—	(0.45)	—	(0.75)	(0.17)	(0.23)	(0.30)	—	—	(0.15)	—	—	—	
LVR040K	—	11.5	—	20.9	—	3.8	7.6	—	4.3	5.8	—	—	—	R8
	—	(0.46)	—	(0.82)	—	(0.15)	(0.30)	—	(0.17)	(0.23)	—	—	—	
LVR040S	—	11.5	—	19.5	—	3.8	7.6	—	4.3	5.8	—	—	—	R8
	—	(0.46)	—	(0.77)	—	(0.15)	(0.30)	—	(0.17)	(0.23)	—	—	—	
LVR055K	—	14.0	—	21.7	—	5.8	7.6	—	2.0	3.0	—	—	—	R8
	—	(0.55)	—	(0.85)	—	(0.23)	(0.30)	—	(0.08)	(0.12)	—	—	—	
LVR055S	—	14.0	—	21.7	—	5.8	7.6	—	—	3.8	—	—	—	R8
	—	(0.55)	—	(0.85)	—	(0.23)	(0.30)	—	—	(0.15)	—	—	—	
New LVRL075S	—	10.9	—	17.0	—	5.08	7.6	—	—	—	—	—	—	R8
	—	(0.43)	—	(0.67)	—	(0.20)	(0.30)	—	—	—	—	—	—	
New LVRL100S	—	11.5	—	20.1	—	5.08	7.6	—	—	—	—	—	—	R8
	—	(0.45)	—	(0.79)	—	(0.20)	(0.30)	—	—	—	—	—	—	
New LVRL125S	—	14.0	—	21.7	—	5.08	7.6	—	—	—	—	—	—	R8
	—	(0.55)	—	(0.85)	—	(0.20)	(0.30)	—	—	—	—	—	—	
New LVRL135S	—	16.3	—	21.7	—	5.08	7.6	—	—	—	—	—	—	R8
	—	(0.64)	—	(0.85)	—	(0.20)	(0.30)	—	—	—	—	—	—	
New LVRL200S	—	23.5	—	27.9	—	10.15	7.6	—	—	—	—	—	—	R8
	—	(0.93)	—	(1.25)	—	(0.40)	(0.30)	—	—	—	—	—	—	
 BBRF 99V														
BBRF550	—	10.9	—	14.0	—	3.6	7.6	—	4.3	5.8	—	1.37	1.2	R6, R15, R16
	—	(0.43)	—	(0.55)	—	(0.14)	(0.3)	—	(0.17)	(0.23)	—	(0.054)	(0.05)	
BBRF750	—	11.9	—	15.5	—	3.6	7.6	—	4.3	5.8	—	1.37	1.2	R6, R15, R16
	—	(0.47)	—	(0.61)	—	(0.14)	(0.3)	—	(0.17)	(0.23)	—	(0.054)	(0.05)	

Table R4 - Dimensions for Radial-leaded Devices in Millimeters (Inches)

... **Cont'd**

Part Number	Dimension												Figure	
	A		B		C		D		E		F	H		J
	Min.	Max.	Min.	Max.	Min.	Max.	Min.	Max.	Min.	Max.	TYP.	TYP.	TYP.	
RXEF 60V														
RXEF005	—	8.0 (0.32)	—	8.3 (0.33)	—	3.0 (0.12)	7.6 (0.30)	—	4.3 (0.17)	5.8 (0.23)	—	1.07 (0.042)	1.0 (0.04)	R9, R15, R16
RXEF010	—	7.4 (0.29)	—	11.6 (0.46)	—	3.0 (0.12)	7.6 (0.30)	—	4.3 (0.17)	5.8 (0.23)	—	1.07 (0.042)	1.0 (0.04)	R10, R15, R16
RXEF017	—	7.4 (0.29)	—	12.7 (0.50)	—	3.0 (0.12)	7.6 (0.30)	—	4.3 (0.17)	5.8 (0.23)	—	1.68 (0.066)	1.7 (0.07)	R10, R15, R16
RXEF020	—	7.4 (0.29)	—	11.7 (0.46)	—	3.0 (0.12)	7.6 (0.30)	—	4.3 (0.17)	5.8 (0.23)	—	1.17 (0.046)	1.0 (0.04)	R10, R15, R16
RXEF025	—	7.4 (0.29)	—	12.7 (0.50)	—	3.0 (0.12)	7.6 (0.30)	—	4.3 (0.17)	5.8 (0.23)	—	1.17 (0.046)	1.0 (0.04)	R10, R15, R16
RXEF030	—	7.4 (0.29)	—	12.7 (0.50)	—	3.0 (0.12)	7.6 (0.30)	—	4.3 (0.17)	5.8 (0.23)	—	1.17 (0.046)	1.0 (0.04)	R10, R15, R16
RXEF040	—	7.6 (0.30)	—	13.5 (0.53)	—	3.0 (0.12)	7.6 (0.30)	—	4.3 (0.17)	5.8 (0.23)	—	1.17 (0.046)	1.2 (0.05)	R10, R15, R16
RXEF050	—	7.9 (0.31)	—	13.7 (0.54)	—	3.0 (0.12)	7.6 (0.30)	—	4.3 (0.17)	5.8 (0.23)	—	1.17 (0.046)	1.2 (0.05)	R10, R15, R16
RXEF065	—	9.4 (0.37)	—	14.5 (0.57)	—	3.0 (0.12)	7.6 (0.30)	—	4.3 (0.17)	5.8 (0.23)	—	1.17 (0.046)	1.5 (0.06)	R10, R15, R16
RXEF075	—	10.2 (0.40)	—	15.2 (0.60)	—	3.0 (0.12)	7.6 (0.30)	—	4.3 (0.17)	5.8 (0.23)	—	1.17 (0.046)	1.5 (0.06)	R10, R15, R16
RXEF090	—	11.2 (0.44)	—	15.8 (0.62)	—	3.0 (0.12)	7.6 (0.30)	—	4.3 (0.17)	5.8 (0.23)	—	1.17 (0.046)	1.5 (0.06)	R10, R15, R16
RXEF110	—	12.8 (0.50)	—	17.5 (0.69)	—	3.0 (0.12)	7.6 (0.30)	—	4.3 (0.17)	5.8 (0.23)	—	1.37 (0.054)	1.2 (0.05)	R11, R15, R16
RXEF135	—	14.5 (0.57)	—	19.1 (0.75)	—	3.0 (0.12)	7.6 (0.30)	—	4.3 (0.17)	5.8 (0.23)	—	1.37 (0.054)	1.2 (0.05)	R11, R15, R16
RXEF160	—	16.3 (0.64)	—	20.8 (0.82)	—	3.0 (0.12)	7.6 (0.30)	—	4.3 (0.17)	5.8 (0.23)	—	1.37 (0.054)	1.5 (0.06)	R11, R15, R16
RXEF185	—	17.5 (0.69)	—	22.4 (0.88)	—	3.0 (0.12)	7.6 (0.30)	—	4.3 (0.17)	5.8 (0.23)	—	1.37 (0.054)	1.5 (0.06)	R11, R15, R16
RXEF250	—	20.8 (0.82)	—	25.4 (1.00)	—	3.0 (0.12)	7.6 (0.30)	—	9.4 (0.37)	10.9 (0.43)	—	1.37 (0.054)	1.7 (0.07)	R11, R15, R16
RXEF300	—	23.9 (0.94)	—	28.6 (1.13)	—	3.0 (0.12)	7.6 (0.30)	—	9.4 (0.37)	10.9 (0.43)	—	1.37 (0.054)	1.7 (0.07)	R11, R15, R16
RXEF375	—	27.2 (1.07)	—	31.8 (1.25)	—	3.0 (0.12)	7.6 (0.30)	—	9.4 (0.37)	10.9 (0.43)	—	1.37 (0.054)	1.7 (0.07)	R11, R15, R16
RTEF 33V														
RTEF120	—	7.4 (0.29)	—	12.2 (0.48)	—	3.0 (0.12)	7.6 (0.30)	—	4.3 (0.17)	5.8 (0.23)	—	0.89 (0.035)	0.8 (0.03)	R12, R15, R16
RTEF135	—	7.4 (0.29)	—	14.2 (0.56)	—	3.0 (0.12)	7.6 (0.30)	—	4.3 (0.17)	5.8 (0.23)	—	0.89 (0.035)	0.8 (0.03)	R12, R15, R16
RTEF190	—	8.9 (0.35)	—	13.5 (0.53)	—	3.0 (0.12)	7.6 (0.30)	—	4.3 (0.17)	5.8 (0.23)	—	0.89 (0.035)	1.0 (0.04)	R12, R15, R16
RUEF 30V														
RUEF090	—	7.4 (0.29)	—	12.2 (0.48)	—	3.0 (0.12)	7.6 (0.30)	—	4.3 (0.17)	5.8 (0.23)	—	0.89 (0.035)	0.8 (0.03)	R12, R15, R16
RUEF110	—	7.4 (0.29)	—	14.2 (0.56)	—	3.0 (0.12)	7.6 (0.30)	—	4.3 (0.17)	5.8 (0.23)	—	0.89 (0.035)	0.8 (0.03)	R12, R15, R16
RUEF135	—	8.9 (0.35)	—	13.5 (0.53)	—	3.0 (0.12)	7.6 (0.30)	—	4.3 (0.17)	5.8 (0.23)	—	0.89 (0.035)	1.0 (0.04)	R12, R15, R16
RUEF160	—	8.9 (0.35)	—	15.2 (0.60)	—	3.0 (0.12)	7.6 (0.30)	—	4.3 (0.17)	5.8 (0.23)	—	0.89 (0.035)	1.0 (0.04)	R12, R15, R16
RUEF185	—	10.2 (0.40)	—	15.7 (0.62)	—	3.0 (0.12)	7.6 (0.30)	—	4.3 (0.17)	5.8 (0.23)	—	0.89 (0.035)	1.0 (0.04)	R12, R15, R16
RUEF250	—	11.4 (0.45)	—	18.3 (0.72)	—	3.0 (0.12)	7.6 (0.30)	—	4.3 (0.17)	5.8 (0.23)	—	0.89 (0.035)	1.2 (0.05)	R12, R15, R16
RUEF300	—	11.4 (0.45)	—	16.5 (0.65)	—	3.0 (0.12)	7.6 (0.30)	—	4.3 (0.17)	5.8 (0.23)	—	1.19 (0.047)	1.5 (0.06)	R13, R15, R16
RUEF400	—	14.0 (0.55)	—	19.3 (0.76)	—	3.0 (0.12)	7.6 (0.30)	—	4.3 (0.17)	5.8 (0.23)	—	1.19 (0.047)	1.7 (0.07)	R13, R15, R16

Table R4 - Dimensions for Radial-leaded Devices in Millimeters (Inches)

... **Cont'd**

Part Number	Dimension														Figure
	A		B		C		D		E		F	H	J		
	Min.	Max.	Min.	Max.	Min.	Max.	Min.	Max.	Min.	Max.	TYP.	TYP.	TYP.		
RUEF 30V															
RUEF500	—	14.0 (0.55)	—	24.1 (0.95)	—	3.0 (0.12)	7.6 (0.30)	—	9.4 (0.37)	10.9 (0.43)	—	1.19 (0.047)	1.0 (0.04)	R13, R15, R16	
RUEF600	—	16.5 (0.65)	—	24.1 (0.95)	—	3.0 (0.12)	7.6 (0.30)	—	9.4 (0.37)	10.9 (0.43)	—	1.19 (0.047)	1.0 (0.04)	R13, R15, R16	
RUEF700	—	19.1 (0.75)	—	25.9 (1.02)	—	3.0 (0.12)	7.6 (0.30)	—	9.4 (0.37)	10.9 (0.43)	—	1.19 (0.047)	1.2 (0.05)	R13, R15, R16	
RUEF800	—	21.6 (0.85)	—	28.4 (1.12)	—	3.0 (0.12)	7.6 (0.30)	—	9.4 (0.37)	10.9 (0.43)	—	1.19 (0.047)	1.5 (0.06)	R13, R15, R16	
RUEF900	—	24.1 (0.95)	—	29.0 (1.14)	—	3.0 (0.12)	7.6 (0.30)	—	9.4 (0.37)	10.9 (0.43)	—	1.19 (0.047)	1.5 (0.06)	R13, R15, R16	
RHEF 30V - High Temperature															
RHEF050	—	7.4 (0.29)	—	12.7 (0.50)	—	3.0 (0.12)	7.6 (0.30)	—	4.3 (0.17)	5.8 (0.23)	1.21 (0.05)	—	—	—	
RHEF070	—	6.86 (0.27)	—	10.8 (0.43)	—	3.0 (0.12)	7.6 (0.30)	—	4.3 (0.17)	5.8 (0.23)	1.2 (0.05)	1.24 (0.049)	1.2 (0.05)	R12, R15, R16	
RHEF100	—	9.7 (0.38)	—	13.6 (0.54)	—	3.0 (0.12)	7.6 (0.30)	—	4.3 (0.17)	5.8 (0.23)	—	—	—	—	
RUSBF 16V															
RUSBF090	—	7.4 (0.29)	—	12.2 (0.48)	—	3.0 (0.12)	7.6 (0.30)	—	4.3 (0.17)	5.8 (0.23)	—	0.89 (0.035)	0.8 (0.03)	R12, R15, R16	
RUSBF110	—	7.4 (0.29)	—	14.2 (0.56)	—	3.0 (0.12)	7.6 (0.30)	—	4.3 (0.17)	5.8 (0.23)	—	0.89 (0.035)	0.8 (0.03)	R12, R15, R16	
RUSBF135	—	8.9 (0.35)	—	13.5 (0.53)	—	3.0 (0.12)	7.6 (0.30)	—	4.3 (0.17)	5.8 (0.23)	—	0.89 (0.035)	1.0 (0.04)	R12, R15, R16	
RUSBF160	—	8.9 (0.35)	—	15.2 (0.60)	—	3.0 (0.12)	7.6 (0.30)	—	4.3 (0.17)	5.8 (0.23)	—	0.89 (0.035)	1.0 (0.04)	R12, R15, R16	
RUSBF185	—	10.2 (0.40)	—	15.7 (0.62)	—	3.0 (0.12)	7.6 (0.30)	—	4.3 (0.17)	5.8 (0.23)	—	0.89 (0.035)	1.0 (0.04)	R12, R15, R16	
RUSBF250	—	11.4 (0.45)	—	18.3 (0.72)	—	3.0 (0.12)	7.6 (0.30)	—	4.3 (0.17)	5.8 (0.23)	—	0.89 (0.035)	1.2 (0.05)	R12, R15, R16	
RGEF 16V															
RGEF250	—	8.9 (0.35)	—	12.8 (0.50)	—	3.0 (0.12)	3.18 (0.13)	6.18 (0.24)	4.3 (0.17)	5.8 (0.23)	1.21 (0.05)	1.24 (0.049)	1.2 (0.05)	R12, R15, R16	
RGEF300	6.1 (0.24)	7.1 (0.28)	6.1 (0.24)	11.0 (0.43)	2.0 (0.08)	3.0 (0.12)	7.6 (0.30)	—	4.3 (0.17)	5.8 (0.23)	1.21 (0.05)	1.24 (0.049)	1.2 (0.05)	R13, R15, R16	
RGEF400	7.9 (0.31)	8.9 (0.35)	7.9 (0.31)	12.8 (0.50)	2.0 (0.08)	3.0 (0.12)	7.6 (0.30)	—	4.3 (0.17)	5.8 (0.23)	1.21 (0.05)	1.24 (0.049)	1.4 (0.06)	R13, R15, R16	
RGEF500	9.4 (0.37)	10.4 (0.41)	9.4 (0.37)	14.3 (0.56)	2.0 (0.08)	3.0 (0.12)	7.6 (0.30)	—	4.3 (0.17)	5.8 (0.23)	1.21 (0.05)	1.24 (0.049)	1.6 (0.06)	R13, R15, R16	
RGEF600	9.7 (0.38)	10.7 (0.42)	12.2 (0.48)	17.1 (0.67)	2.0 (0.08)	3.0 (0.12)	7.6 (0.30)	—	4.3 (0.17)	5.8 (0.23)	1.21 (0.05)	1.24 (0.049)	1.6 (0.06)	R13, R15, R16	
RGEF700	10.2 (0.40)	11.2 (0.44)	14.7 (0.58)	19.7 (0.78)	2.0 (0.08)	3.0 (0.12)	7.6 (0.30)	—	4.3 (0.17)	5.8 (0.23)	1.21 (0.05)	1.24 (0.049)	1.7 (0.07)	R13, R15, R16	
RGEF800	11.7 (0.46)	12.7 (0.50)	16.0 (0.63)	20.9 (0.82)	2.0 (0.08)	3.0 (0.12)	7.6 (0.30)	—	4.3 (0.17)	5.8 (0.23)	1.21 (0.05)	1.24 (0.049)	1.8 (0.07)	R13, R15, R16	
RGEF900	13.0 (0.51)	14.0 (0.55)	16.8 (0.66)	21.7 (0.85)	2.0 (0.08)	3.0 (0.12)	7.6 (0.30)	—	4.3 (0.17)	5.8 (0.23)	1.21 (0.05)	1.24 (0.049)	2.0 (0.08)	R13, R15, R16	
RGEF1000	15.5 (0.61)	16.5 (0.65)	21.1 (0.83)	25.2 (0.99)	2.0 (0.08)	3.0 (0.12)	7.6 (0.30)	—	4.3 (0.17)	5.8 (0.23)	1.21 (0.05)	1.24 (0.049)	2.0 (0.08)	R13, R15, R16	
RGEF1100	16.5 (0.65)	17.5 (0.69)	21.1 (0.83)	26.0 (1.02)	2.0 (0.08)	3.0 (0.12)	7.6 (0.30)	—	4.3 (0.17)	5.8 (0.23)	1.2 (0.05)	1.24 (0.049)	2.4 (0.09)	R13, R15, R16	
RGEF1200	16.4 (0.65)	17.5 (0.69)	22.6 (0.89)	28.0 (1.10)	2.3 (0.09)	3.5 (0.14)	7.6 (0.30)	—	9.4 (0.37)	10.9 (0.43)	1.4 (0.06)	1.45 (0.057)	1.5 (0.06)	R13, R15, R16	
RGEF1400	22.4 (0.88)	23.5 (0.925)	22.6 (0.89)	27.9 (1.10)	2.3 (0.09)	3.5 (0.14)	7.6 (0.30)	—	9.4 (0.37)	10.9 (0.43)	1.4 (0.06)	1.45 (0.057)	1.9 (0.08)	R13, R15, R16	
RHEF 16V - High Temperature															
RHEF200	—	9.4 (0.37)	14.4 (0.57)	—	—	3.0 (0.12)	7.6 (0.30)	—	4.3 (0.17)	5.8 (0.23)	—	—	—	R10, R15, R16	

Radial-leaded Devices

Table R4 - Dimensions for Radial-leaded Devices in Millimeters (Inches)

... **Cont'd**

Part Number	Dimension														Figure
	A		B		C		D		E		F	H	J		
	Min.	Max.	Min.	Max.	Min.	Max.	Min.	Max.	Min.	Max.	TYP.	TYP.	TYP.		
RHEF 16V - High Temperature															
New RHEF300	—	8.8 (0.35)	—	13.8 (0.55)	—	3.0 (0.12)	7.6 (0.30)	—	4.3 (0.17)	5.8 (0.23)	1.2 (0.05)	—	—	R14, R15 R16	
RHEF400	—	10.0 (0.39)	—	15.0 (0.59)	—	3.0 (0.12)	7.6 (0.30)	—	4.3 (0.17)	5.8 (0.23)	1.2 (0.05)	1.24 (0.049)	1.6 (0.06)	R14, R15, R16	
RHEF450	—	10.4 (0.41)	—	15.6 (0.61)	—	3.0 (0.12)	7.6 (0.30)	—	4.3 (0.17)	5.8 (0.23)	1.2 (0.05)	1.24 (0.049)	1.6 (0.06)	R14, R15, R16	
New RHEF550	—	11.2 (0.44)	—	18.9 (0.74)	—	3.0 (0.12)	7.6 (0.30)	—	4.3 (0.17)	5.8 (0.23)	1.2 (0.05)	—	—	R14, R15	
RHEF600	—	11.2 (0.44)	—	21.0 (0.83)	—	3.0 (0.12)	7.6 (0.30)	—	4.3 (0.17)	5.8 (0.23)	1.2 (0.05)	1.24 (0.049)	1.7 (0.067)	R14, R15, R16	
RHEF650	—	12.7 (0.50)	—	22.2 (0.88)	—	3.0 (0.12)	7.6 (0.30)	—	4.3 (0.17)	5.8 (0.23)	1.2 (0.05)	1.24 (0.049)	1.8 (0.07)	R14, R15, R16	
New RHEF700	—	14.0 (0.55)	—	21.9 (0.86)	—	3.0 (0.12)	7.6 (0.30)	—	4.3 (0.17)	5.8 (0.23)	1.2 (0.05)	—	—	R14, R15	
RHEF750	—	14.0 (0.55)	—	23.5 (0.93)	—	3.0 (0.12)	7.6 (0.30)	—	4.3 (0.17)	5.8 (0.23)	1.2 (0.05)	1.24 (0.049)	2.0 (0.08)	R14, R15, R16	
New RHEF800	—	16.5 (0.65)	—	22.5 (0.88)	—	3.0 (0.12)	7.6 (0.30)	—	4.3 (0.17)	5.8 (0.23)	1.2 (0.05)	—	—	R14, R15 R16	
RHEF900	—	16.5 (0.65)	—	25.7 (1.01)	—	3.0 (0.12)	7.6 (0.30)	—	4.3 (0.17)	5.8 (0.23)	—	—	—	R14, R15 R16	
RHEF1000	—	17.5 (0.69)	—	26.5 (1.04)	—	3.0 (0.12)	7.6 (0.30)	—	9.4 (0.37)	10.9 (0.43)	1.2 (0.05)	1.24 (0.049)	1.5 (0.06)	R14, R15, R16	
New RHEF1100	—	21.0 (0.83)	—	26.1 (1.03)	—	3.0 (0.12)	7.6 (0.30)	—	9.4 (0.37)	10.9 (0.43)	1.2 (0.05)	—	—	R14, R15 R16	
RHEF1300	—	23.5 (0.925)	—	28.7 (1.13)	—	3.6 (0.14)	7.6 (0.30)	—	9.4 (0.37)	10.9 (0.43)	1.4 (0.06)	1.45 (0.057)	1.9 (0.084)	R14, R15, R16	
New RHEF1400	—	23.5 (0.93)	—	28.6 (1.13)	—	3.6 (0.14)	7.6 (0.30)	—	9.4 (0.37)	10.9 (0.43)	1.4 (0.06)	—	—	R14, R15 R16	
RHEF1500	—	23.5 (0.925)	—	28.7 (1.13)	—	3.6 (0.14)	7.6 (0.30)	—	9.4 (0.37)	10.9 (0.43)	1.4 (0.06)	1.45 (0.057)	1.9 (0.084)	R14, R15, R16	
RUSBF 6V															
RUSBF075	—	6.9 (0.27)	—	11.4 (0.45)	—	3.1 (0.12)	7.6 (0.30)	—	4.3 (0.17)	5.9 (0.23)	—	0.91 (0.036)	1.0 (0.04)	R10, R15, R16	
RUSBF120	—	6.9 (0.27)	—	11.7 (0.46)	—	3.1 (0.12)	7.6 (0.30)	—	4.3 (0.17)	5.9 (0.23)	—	0.91 (0.036)	1.0 (0.04)	R10, R15, R16	
RUSBF155	—	6.9 (0.27)	—	11.7 (0.46)	—	3.1 (0.12)	7.6 (0.30)	—	4.3 (0.17)	5.9 (0.23)	—	0.91 (0.036)	1.0 (0.04)	R10, R15, R16	

Figures R17-R23 - Typical Time-to-trip curves at 20°C for Radial-leaded Devices

LVR/LVRL

- A = LVR005 H = LVR055
- B = LVR008 I = LVRL075
- C = LVR012 J = LVRL100
- D = LVR016 K = LVRL125
- E = LVR025 L = LVRL135
- F = LVR033 M = LVRL200
- G = LVR040

Figure R17

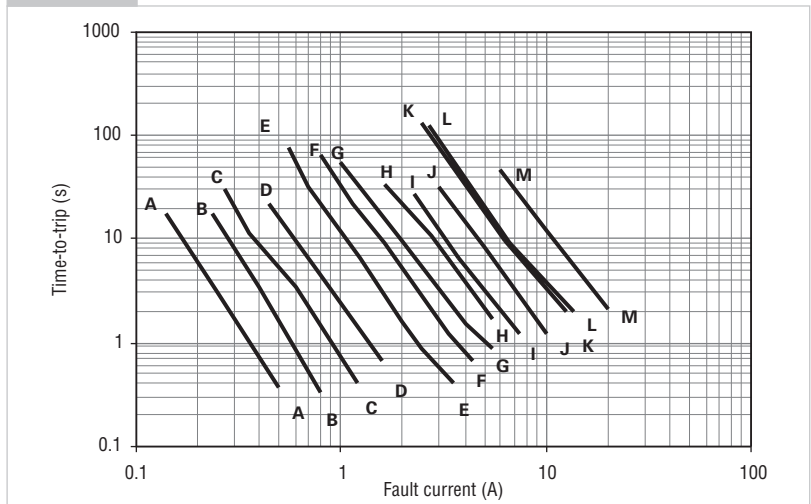

BBRF

- A = BBRF550
- B = BBRF750

RTEF

- C = RTEF120
- D = RTEF135
- E = RTEF190

Figure R18

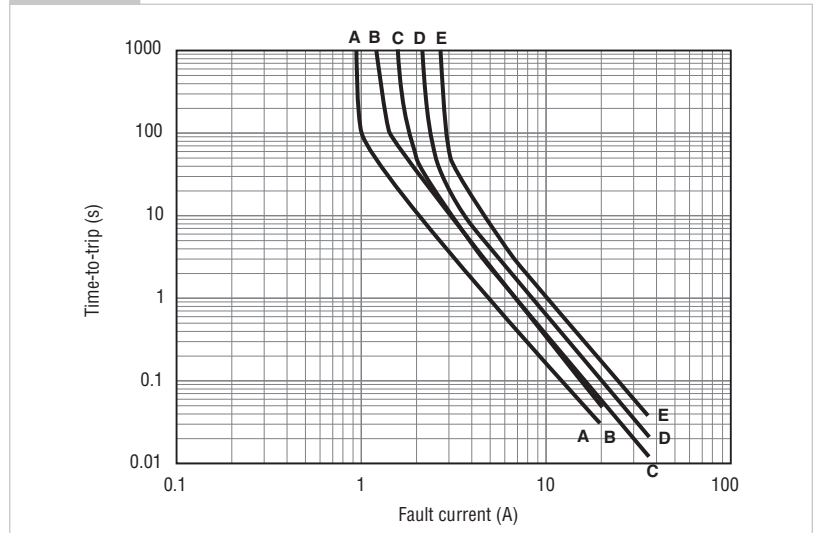

RXEF

- | | |
|-------------|-------------|
| A = RXEF005 | J = RXEF075 |
| B = RXEF010 | K = RXEF090 |
| C = RXEF017 | L = RXEF110 |
| D = RXEF020 | M = RXEF135 |
| E = RXEF025 | N = RXEF160 |
| F = RXEF030 | O = RXEF185 |
| G = RXEF040 | P = RXEF250 |
| H = RXEF050 | Q = RXEF300 |
| I = RXEF065 | R = RXEF375 |

Figure R19

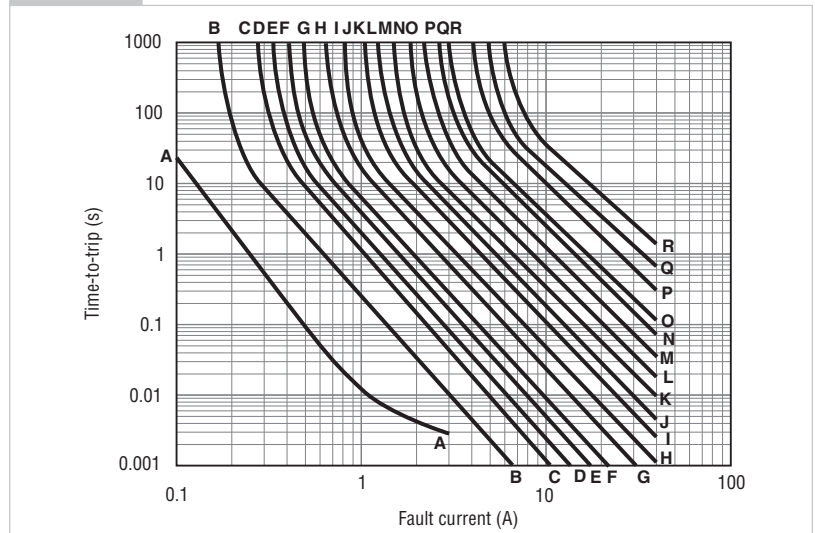

RUEF

- | | |
|-------------|-------------|
| A = RUEF090 | H = RUEF400 |
| B = RUEF110 | I = RUEF500 |
| C = RUEF135 | J = RUEF600 |
| D = RUEF160 | K = RUEF700 |
| E = RUEF185 | L = RUEF800 |
| F = RUEF250 | M = RUEF900 |
| G = RUEF300 | |

Figure R20

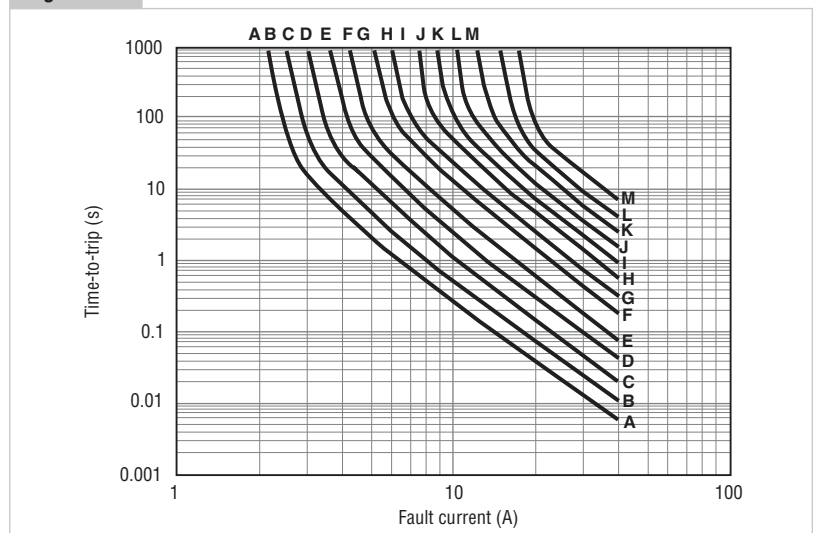

Figures R17-R23 - Typical Time-to-trip curves at 20°C for Radial-leaded Devices

Cont'd

RGEF (data at 25°C)

- | | |
|-------------|--------------|
| A = RGEF250 | H = RGEF900 |
| B = RGEF300 | I = RGEF1000 |
| C = RGEF400 | J = RGEF1100 |
| D = RGEF500 | K = RGEF1200 |
| E = RGEF600 | L = RGEF1400 |
| F = RGEF700 | |
| G = RGEF800 | |

Figure R21

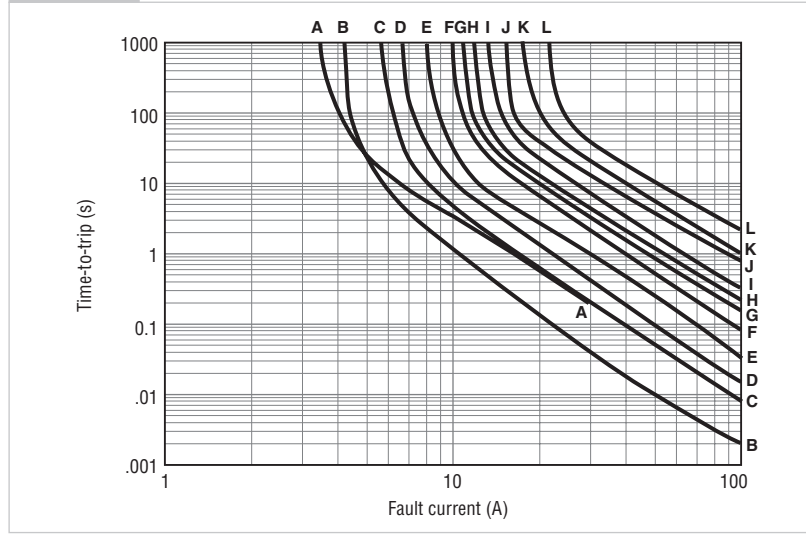

RHEF (data at 25°C)

- | | |
|-------------|--------------|
| A = RHEF050 | K = RHEF700 |
| B = RHEF070 | L = RHEF750 |
| C = RHEF100 | M = RHEF800 |
| D = RHEF200 | N = RHEF900 |
| E = RHEF300 | O = RHEF1000 |
| F = RHEF400 | P = RHEF1100 |
| G = RHEF450 | Q = RHEF1300 |
| H = RHEF550 | R = RHEF1400 |
| I = RHEF600 | S = RHEF1500 |
| J = RHEF650 | |

Figure R22

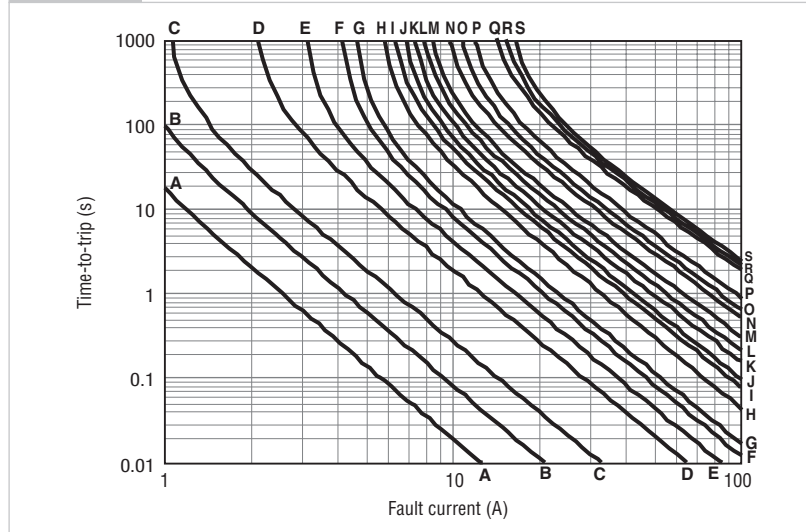

RUSBF

- | | |
|--------------|--------------|
| A = RUSBF075 | F = RUSBF155 |
| B = RUSBF090 | G = RUSBF160 |
| C = RUSBF110 | H = RUSBF185 |
| D = RUSBF120 | I = RUSBF250 |
| E = RUSBF135 | |

Figure R23

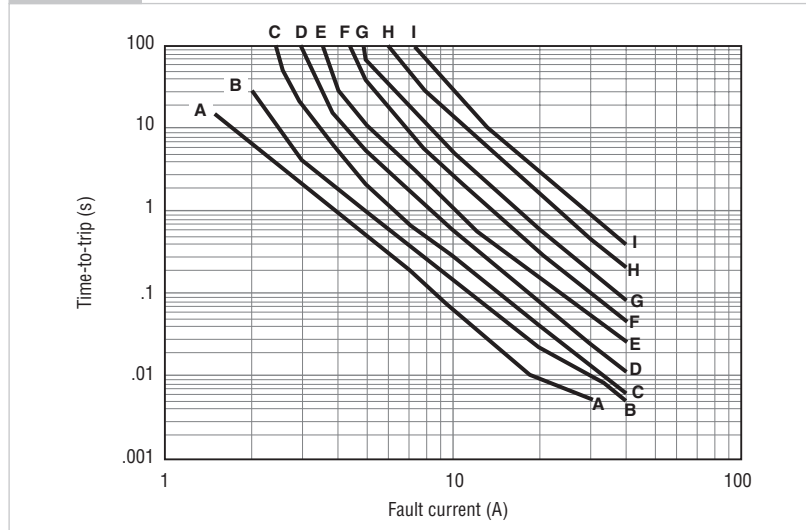

Table R5 - Physical Characteristics and Environmental Specifications for Radial-leaded Devices

**LVR/LVRL
Physical Characteristics**

Lead material	LVR005-016: Tin-plated copper, 0.205mm ² (24AWG), ø0.51mm (0.020in.) LVR025-040: Tin-plated copper, 0.32mm ² (22AWG), ø0.64mm (0.025in.) LVR055: Tin-plated copper, 0.52mm ² (20AWG), ø0.81mm (0.032in.) LVRL: Tin-plated copper, 0.52mm ² (20AWG), ø0.81mm (0.032in.)
Soldering characteristics	Solderability pre ANSI/J-STD-002 Category 3
Solder heat withstand	per IEC-STD 68-2-20, Test Tb, Method 1a, condition b, can withstand 10 seconds at 260°C ±5°C

Devices are not designed to be placed through a reflow process.

**LVR/LVRL
Environmental Specifications**

Test	Conditions	Resistance Change
Passive aging	70°C, 1000 hours	±5%
	85°C, 1000 hours	±5%
Humidity aging	85°C, 85%RH, 1000 hours	±5%
Thermal Shock	85°C, -40°C (10 times)	±5%
Solvent resistance	MIL-STD-202, Method 215F	No change

**BBRF
Physical Characteristics**

Lead material	Tin-plated copper, 0.52mm ² (20AWG), ø0.81mm (0.032in.)
Soldering characteristics	Solderability pre ANSI/J-STD-002 Category 3
Solder heat withstand	per IEC-STD 68-2-20, Test Tb, Method 1a, condition b, can withstand 10 seconds at 260°C ±5°C
Insulating material	Cured, flame-retardant epoxy polymer; meets UL 94V-0

Devices are not designed to be placed through a reflow process.

**BBRF
Environmental Specifications**

Test	Conditions	Resistance Change
Passive aging	70°C, 1000 hours	±5%
	85°C, 1000 hours	±5%
Humidity aging	85°C, 85%RH, 1000 hours	±5%
Thermal Shock	85°C, -40°C (10 times)	±5%
Solvent resistance	MIL-STD-202, Method 215F	No change

**RXEF
Physical Characteristics**

Lead material	RXEF005: Tin-plated nickel-copper ally, 0.128mm ² (26AWG), ø0.40mm (0.016in.) RXEF010: Tin-plated nickel-copper ally, 0.205mm ² (24AWG), ø0.51mm (0.020in.) RXEF017 to 040: Tin-plated copper-clad steel, 0.205mm ² (24AWG), ø0.51mm (0.020in.) RXEF050 to 090: Tin-plated copper, 0.205mm ² (24AWG), ø0.51mm (0.020in.) RXEF110 to 375: Tin-plated copper, 0.52mm ² (20AWG), ø0.81mm (0.032in.)
Soldering characteristics	Solderability pre ANSI/J-STD-002 Category 3 RXEF005, RXEF010 meet ANSI/J-STD-002 Category 1
Solder heat withstand	RXEF017- RXEF025: per IEC-STD 68-2-20, Test Tb, Method 1a, condition a; can withstand 5 seconds at 260°C ±5°C All other sizes: per IEC-STD 68-2-20, Test Tb, Method 1a, condition b; can withstand 5 seconds at 260°C ±5°C
Insulating material	Cured, flame-retardant epoxy polymer; meets UL 94V-0

Devices are not designed to be placed through a reflow process.

**RXEF
Environmental Specifications**

Test	Conditions	Resistance Change
Passive aging	-40°C, 1000 hours	±5%
	85°C, 1000 hours	±5%
Humidity aging	85°C, 85%RH, 1000 hours	±10%
Thermal Shock	85°C, -40°C (10 times)	±10%
Solvent resistance	MIL-STD-202, Method 215F	No change

Table R5 - Physical Characteristics and Environmental Specifications for Radial-leaded Devices

... **Cont'd**

**RTEF
Physical Characteristics**

Lead material	Tin-plated copper-clad steel, 0.205mm ² (24AWG), ø0.40mm (0.016in.)
Soldering characteristics	Solderability pre ANSI/J-STD-002 Category 3
Solder heat withstand	per IEC-STD 68-2-20, Test Tb, Method 1a, condition b; can withstand 10 seconds at 260°C ±5°C
Insulating material	Cured, flame-retardant epoxy polymer; meets UL 94V-0

**RTEF
Environmental Specifications**

Test	Conditions	Resistance Change
Passive aging	70°C, 1000 hours	±5%
	85°C, 1000 hours	±5%
Humidity aging	85°C, 85%RH, 1000 hours	±5%
Thermal Shock	85°C, -40°C (10 times)	±5%
Solvent resistance	MIL-STD-202, Method 215F	No change

**RUEF
Physical Characteristics**

Lead material	RUEF090 to RUEF250: Tin-plated copper-clad steel, 0.205mm ² (24AWG) RUEF300 to RUEF900: Tin-plated copper, 0.52mm ² (20AWG), ø0.81mm (0.032in.)
Soldering characteristics	Solderability pre ANSI/J-STD-002 Category 3
Solder heat withstand	per IEC-STD 68-2-20, Test Tb, Method1a, condition b, can withstand 10 seconds at 260°C ±5°C
Insulating material	Cured, flame-retardant epoxy polymer; meets UL 94V-0

Devices are not designed to be placed through a reflow process.

**RUEF
Environmental Specifications**

Test	Conditions	Resistance Change
Passive aging	70°C, 1000 hours	±5%
	85°C, 1000 hours	±5%
Humidity aging	85°C, 85%RH, 1000 hours	±5%
Thermal Shock	85°C, -40°C (10times)	±5%
Solvent resistance	MIL-STD-202, Method 215F	No change

**RUSBF
Physical Characteristics**

Lead material	RUSBF075: Tin-plated nickel-copper alloy, 0.205mm ² (24AWG), ø0.51mm/0.020in. RUSBF090 to RUSBF250: Tin-plated copper clad-steel, 0.205mm ² (24AWG), ø0.51mm/0.020in.
Soldering characteristics	Solderability pre ANSI/J-STD-002 Category 3 except RUSBF075 meet ANSI/J-STD-002 Category 1
Solder heat withstand	RUSBF120: per IEC-STD 68-2-20, Test Tb, Method 1a, condition a; can withstand 5 seconds at 260°C ±5°C All others: per IEC-STD 68-2-20, Test Tb, Method 1a, condition b; can withstand 10 seconds at 260°C ±5°C
Insulating material	Cured, flame-retardant epoxy polymer; meets UL 94V-0

Devices are not designed to be placed through a reflow process.

**RUSBF
Environmental Specifications**

Test	Conditions	Resistance Change
Passive aging	70°C, 1000 hours	±5%
	85°C, 1000 hours	±5%
Humidity aging	85°C, 85%RH, 1000 hours	±5%
Thermal Shock	85°C, -40°C (10 times)	±5%
Solvent resistance	MIL-STD-202, Method 215F	No change

**RGEF
Physical Characteristics**

Lead material	RGEF300 to RGEF1100: Tin-plated copper, 0.52mm ² (20AWG), ø0.81mm/0.032in. RGEF1200 to RGEF1400: Tin-plated copper, 0.82mm ² (18AWG), ø1.0mm/0.04in.
Soldering characteristics	Solderability pre ANSI/J-STD-002 Category 3
Solder heat withstand	RGEF300K and RGEF400: per IEC 68-2-20, Test Tb, Method 1a, condition a; can withstand 5 seconds at 260°C ±5°C RGEF500 to RGEF1400: per IEC 68-2-20, Test Tb, Method 1a, condition b; can withstand 10 seconds at 260°C ±5°C
Insulating material	Cured, flame-retardant epoxy polymer; meets UL 94V-0

Devices are not designed to be placed through a reflow process.

Table R5 - Physical Characteristics and Environmental Specifications for Radial-leaded Devices

... Cont'd

RGEF Environmental Specifications

Test	Conditions	Resistance Change
Passive aging	-40°C, 1000 hours	±5%
	85°C, 1000 hours	±5%
Humidity aging	85°C, 85%RH, 1000 hours	±5%
Thermal Shock	85°C, -40°C (10 times)	±5%
Solvent resistance	MIL-STD-202, Method 215F	No change

RHEF Physical Characteristics

Lead material	RHEF050 to RHEF200: Tin-plated copper clad steel, 0.205mm ² (24AWG), ø0.51mm/0.020in. RHEF300 to RHEF1100: Tin-plated copper, 0.52mm ² (20AWG), ø0.81mm/0.032in. RHEF1300 to RHEF1500: Tin-plated copper, 0.82mm ² (18AWG), ø1.0mm/0.04in.
Soldering characteristics	Solderability pre ANSI/J-STD-002 Category 3
Solder heat withstand	per IEC 68-2-20, Test Tb, Method 1a, condition b; can withstand 10 seconds at 260°C ±5°C
Insulating material	Cured, flame-retardant epoxy polymer; meets UL 94V-0

Devices are not designed to be placed through a reflow process.

RHEF Environmental Specifications

Test	Conditions	Resistance Change
Passive aging	70°C, 1000 hours	±5%
	85°C, 1000 hours	±5%
Humidity aging	85°C, 85%RH, 1000 hours	±5%
Thermal Shock	125°C, -40°C (10 times)	±5%
Solvent resistance	MIL-STD-202, Method 215F	No change

Devices are not designed to be placed through a reflow process.

Notes: Storage conditions: 40°Cmax., 70% RH max.; devices should remain in original sealed bags prior to use. Devices may not meet specified values if these storage conditions are exceeded.
For the TR devices series, see the Telecommunications and Networking section.

Agency Recognitions for Radial-leaded Devices

UL	File # E74889
CSA	File # CA78165C
TÜV	Certificate number available on request (per IEC 60730-1).

Table R6 - Packaging and Marking Information for Radial-leaded Devices

Part Number	Bag Quantity	Tape & Reel Quantity	Ammo Pack Quantity	Standard Pack Quantity	Part Marking	Agency Recognition
 LVR 240V _{AC} /LVRL 120V _{AC}						
LVR005K	500	—	—	10,000	L005	UL, CSA, TÜV
LVR005K-2	—	2,000	—	10,000	L005	UL, CSA, TÜV
LVR005S	500	—	—	10,000	L005	UL, CSA, TÜV
LVR005S-2	—	2,000	—	10,000	L005	UL, CSA, TÜV
LVR008K	500	—	—	10,000	L008	UL, CSA, TÜV
LVR008K-2	—	2,000	—	10,000	L008	UL, CSA, TÜV
LVR008S	500	—	—	10,000	L008	UL, CSA, TÜV
LVR008S-2	—	2,000	—	10,000	L008	UL, CSA, TÜV
LVR012K	500	—	—	10,000	L012	UL, CSA, TÜV
LVR012K-2	—	2,000	—	10,000	L012	UL, CSA, TÜV
LVR012S	500	—	—	10,000	L012	UL, CSA, TÜV
LVR012S-2	—	2,000	—	10,000	L012	UL, CSA, TÜV
LVR016K	500	—	—	10,000	L016	UL, CSA, TÜV
LVR016K-2	—	2,000	—	10,000	L016	UL, CSA, TÜV
LVR016S	500	—	—	10,000	L016	UL, CSA, TÜV
LVR016S-2	—	2,000	—	10,000	L016	UL, CSA, TÜV
LVR025K	500	—	—	10,000	L025	UL, CSA, TÜV
LVR025K-2	—	2,000	—	10,000	L025	UL, CSA, TÜV
LVR025S	500	—	—	10,000	L025	UL, CSA, TÜV
LVR025S-2	—	2,000	—	10,000	L025	UL, CSA, TÜV

Table R6 - Packaging and Marking Information for Radial-leaded Devices

... **Cont'd**

Part Number	Bag Quantity	Tape & Reel Quantity	Ammo Pack Quantity	Standard Pack Quantity	Part Marking	Agency Recognition
☑ LVR 240V_{AC}/LVRL 120V_{AC}						
LVR033S	500	—	—	10,000	L033	UL, CSA, TÜV
LVR033S-2	—	2,000	—	10,000	L033	UL, CSA, TÜV
LVR033K	500	—	—	10,000	L033	UL, CSA, TÜV
LVR033K-2	—	2,000	—	10,000	L033	UL, CSA, TÜV
LVR040S	500	—	—	10,000	L040	UL, CSA, TÜV
LVR040S-2	—	2,000	—	10,000	L040	UL, CSA, TÜV
LVR040K	500	—	—	10,000	L040	UL, CSA, TÜV
LVR040K-2	—	2,000	—	10,000	L040	UL, CSA, TÜV
LVR055K	500	—	—	10,000	L055	UL, CSA, TÜV
LVR055S	500	—	—	10,000	L055	UL, CSA, TÜV
New LVRL075S	500	—	—	10,000	L075	UL, CSA, TÜV
New LVRL100S	500	—	—	10,000	L100	UL, CSA, TÜV
New LVRL125S	500	—	—	10,000	L125	UL, CSA, TÜV
New LVRL135S	500	—	—	10,000	L135	UL, CSA, TÜV
New LVRL200S	250	—	—	5,000	L200	UL, CSA, TÜV
☑ BBRF 99V_{AC}						
BBRF550	500	—	—	10,000	BF550	UL, CSA
BBRF550-2	—	1,500	—	7,500	BF550	UL, CSA
BBRF750	500	—	—	10,000	BF750	UL, CSA
BBRF750-2	—	1,500	—	7,500	BF750	UL, CSA
☑ RXEF 60V						
RXEF005	500	—	—	10,000	—	UL, CSA, TÜV
RXEF005-2	—	3,000	—	15,000	—	UL, CSA, TÜV
RXEF005-AP	—	—	2,000	10,000	—	UL, CSA, TÜV
RXEF010	500	—	—	10,000	XF010	UL, CSA, TÜV
RXEF010-2	—	3,000	—	15,000	XF010	UL, CSA, TÜV
RXEF010-AP	—	—	2,000	10,000	XF010	UL, CSA, TÜV
RXEF017	500	—	—	10,000	XF017	UL, CSA, TÜV
RXEF017-2	—	2,500	—	12,500	XF017	UL, CSA, TÜV
RXEF017-AP	—	—	2,000	10,000	XF017	UL, CSA, TÜV
☑ RXEF 72V						
RXEF020	500	—	—	10,000	XF020	UL, CSA, TÜV
RXEF020-2	—	3,000	—	15,000	XF020	UL, CSA, TÜV
RXEF020-AP	—	—	2,000	10,000	XF020	UL, CSA, TÜV
RXEF025	500	—	—	10,000	XF025	UL, CSA, TÜV
RXEF025-2	—	3,000	—	15,000	XF025	UL, CSA, TÜV
RXEF025-AP	—	—	2,000	10,000	XF025	UL, CSA, TÜV
RXEF030	500	—	—	10,000	XF030	UL, CSA, TÜV
RXEF030-2	—	3,000	—	15,000	XF030	UL, CSA, TÜV
RXEF030-AP	—	—	2,000	10,000	XF030	UL, CSA, TÜV
RXEF040	500	—	—	10,000	XF040	UL, CSA, TÜV
RXEF040-2	—	3,000	—	15,000	XF040	UL, CSA, TÜV
RXEF040-AP	—	—	2,000	10,000	XF040	UL, CSA, TÜV
RXEF050	500	—	—	10,000	XF050	UL, CSA, TÜV
RXEF050-2	—	3,000	—	15,000	XF050	UL, CSA, TÜV
RXEF050-AP	—	—	2,000	10,000	XF050	UL, CSA, TÜV
RXEF065	500	—	—	10,000	XF065	UL, CSA, TÜV
RXEF065-2	—	3,000	—	15,000	XF065	UL, CSA, TÜV
RXEF065-AP	—	—	2,000	10,000	XF065	UL, CSA, TÜV
RXEF075	500	—	—	10,000	XF075	UL, CSA, TÜV
RXEF075-2	—	3,000	—	15,000	XF075	UL, CSA, TÜV

Table R6 - Packaging and Marking Information for Radial-leaded Devices

... **Cont'd**

Part Number	Bag Quantity	Tape & Reel Quantity	Ammo Pack Quantity	Standard Pack Quantity	Part Marking	Agency Recognition
■ RXEF 72V						
RXEF075-AP	—	—	2,000	10,000	XF075	UL, CSA, TÜV
RXEF090	500	—	—	10,000	XF090	UL, CSA, TÜV
RXEF090-2	—	3,000	—	15,000	XF090	UL, CSA, TÜV
RXEF090-AP	—	—	2,000	10,000	XF090	UL, CSA, TÜV
RXEF110	500	—	—	10,000	XF110	UL, CSA, TÜV
RXEF110-2	—	1,500	—	7,500	XF110	UL, CSA, TÜV
RXEF110-AP	—	—	1,000	5,000	XF110	UL, CSA, TÜV
RXEF135	500	—	—	10,000	XF135	UL, CSA, TÜV
RXEF135-2	—	1,500	—	7,500	XF135	UL, CSA, TÜV
RXEF135-AP	—	—	1,000	5,000	XF135	UL, CSA, TÜV
RXEF160	500	—	—	10,000	XF160	UL, CSA, TÜV
RXEF160-2	—	1,500	—	7,500	XF160	UL, CSA, TÜV
RXEF160-AP	—	—	1,000	5,000	XF160	UL, CSA, TÜV
RXEF185	500	—	—	10,000	XF185	UL, CSA, TÜV
RXEF185-2	—	1,500	—	7,500	XF185	UL, CSA, TÜV
RXEF185-AP	—	—	1,000	5,000	XF185	UL, CSA, TÜV
RXEF250	250	—	—	5,000	XF250	UL, CSA, TÜV
RXEF250-2	—	1,000	—	5,000	XF250	UL, CSA, TÜV
RXEF250-AP	—	—	1,000	5,000	XF250	UL, CSA, TÜV
RXEF300	250	—	—	5,000	XF300	UL, CSA, TÜV
RXEF300-2	—	1,000	—	5,000	XF300	UL, CSA, TÜV
RXEF300-AP	—	—	1,000	5,000	XF300	UL, CSA, TÜV
RXEF375	250	—	—	5,000	XF375	UL, CSA, TÜV
■ RTEF 33V						
RTEF120	500	—	—	10,000	TF120	UL, CSA, TÜV
RTEF120-2	—	3,000	—	15,000	TF120	UL, CSA, TÜV
RTEF120-AP	—	—	2,000	10,000	TF120	UL, CSA, TÜV
RTEF135	500	—	—	10,000	TF135	UL, CSA, TÜV
RTEF135-2	—	3,000	—	15,000	TF135	UL, CSA, TÜV
RTEF135-AP	—	—	2,000	10,000	TF135	UL, CSA, TÜV
RTEF190	500	—	—	10,000	TF190	UL, CSA, TÜV
RTEF190-2	—	3,000	—	15,000	TF190	UL, CSA, TÜV
RTEF190-AP	—	—	2,000	10,000	TF190	UL, CSA, TÜV
■ RUEF 30V						
RUEF090	500	—	—	10,000	UF090	UL, CSA, TÜV, CQC
RUEF090-2	—	3,000	—	15,000	UF090	UL, CSA, TÜV, CQC
RUEF090-AP	—	—	2,000	10,000	UF090	UL, CSA, TÜV, CQC
RUEF110	500	—	—	10,000	UF110	UL, CSA, TÜV, CQC
RUEF110-2	—	3,000	—	15,000	UF110	UL, CSA, TÜV, CQC
RUEF110-AP	—	—	2,000	10,000	UF110	UL, CSA, TÜV, CQC
RUEF135	500	—	—	10,000	UF135	UL, CSA, TÜV, CQC
RUEF135-2	—	3,000	—	15,000	UF135	UL, CSA, TÜV, CQC
RUEF135-AP	—	—	2,000	10,000	UF135	UL, CSA, TÜV, CQC
RUEF160	500	—	—	10,000	UF160	UL, CSA, TÜV, CQC
RUEF160-2	—	3,000	—	15,000	UF160	UL, CSA, TÜV, CQC
RUEF160-AP	—	—	2,000	10,000	UF160	UL, CSA, TÜV, CQC
RUEF185	500	—	—	10,000	UF185	UL, CSA, TÜV, CQC
RUEF185-2	—	3,000	—	15,000	UF185	UL, CSA, TÜV, CQC
RUEF185-AP	—	—	2,000	10,000	UF185	UL, CSA, TÜV, CQC
RUEF250	500	—	—	10,000	UF250	UL, CSA, TÜV, CQC
RUEF250-2	—	3,000	—	15,000	UF250	UL, CSA, TÜV, CQC
RUEF250-AP	—	—	2,000	10,000	UF250	UL, CSA, TÜV, CQC
RUEF300	500	—	—	10,000	UF300	UL, CSA, TÜV, CQC
RUEF300-2	—	2,500	—	12,500	UF300	UL, CSA, TÜV, CQC
RUEF300-AP	—	—	1,000	5,000	UF300	UL, CSA, TÜV, CQC
RUEF400	500	—	—	10,000	UF400	UL, CSA, TÜV, CQC
RUEF400-2	—	1,500	—	7,500	UF400	UL, CSA, TÜV, CQC
RUEF400-AP	—	—	1,000	5,000	UF400	UL, CSA, TÜV, CQC

Table R6 - Packaging and Marking Information for Radial-leaded Devices

... **Cont'd**

Part Number	Bag Quantity	Tape & Reel Quantity	Ammo Pack Quantity	Standard Pack Quantity	Part Marking	Agency Recognition
RUEF 30V						
RUEF500	250	—	—	5,000	UF500	UL, CSA, TÜV, CQC
RUEF500-2	—	1,500	—	7,500	UF500	UL, CSA, TÜV, CQC
RUEF500-AP	—	—	1,000	5,000	UF500	UL, CSA, TÜV, CQC
RUEF600	250	—	—	5,000	UF600	UL, CSA, TÜV, CQC
RUEF600-2	—	1,000	—	5,000	UF600	UL, CSA, TÜV, CQC
RUEF600-AP	—	—	1,000	5,000	UF600	UL, CSA, TÜV, CQC
RUEF700	250	—	—	5,000	UF700	UL, CSA, TÜV, CQC
RUEF700-2	—	1,000	—	5,000	UF700	UL, CSA, TÜV, CQC
RUEF700-AP	—	—	1,000	5,000	UF700	UL, CSA, TÜV, CQC
RUEF800	250	—	—	5,000	UF800	UL, CSA, TÜV, CQC
RUEF800-2	—	1,000	—	5,000	UF800	UL, CSA, TÜV, CQC
RUEF800-AP	—	—	1,000	5,000	UF800	UL, CSA, TÜV, CQC
RUEF900	250	—	—	5,000	UF900	UL, CSA, TÜV, CQC
RUEF900-2	—	1,000	—	4,000	UF900	UL, CSA, TÜV, CQC
RUEF900-AP	—	—	1,000	4,000	UF900	UL, CSA, TÜV, CQC
RHEF 30V - High Temperature						
RHEF050	500	—	—	10,000	HF0.5	UL, CSA, TÜV
RHEF050-2	—	2,500	—	12,500	HF0.7	UL, CSA, TÜV
RHEF070	500	—	—	10,000	HF0.7	UL, CSA, TÜV
RHEF070-2	—	2,500	—	12,500	HF0.7	UL, CSA, TÜV
RHEF100	500	—	—	10,000	HF1.0	UL, CSA, TÜV
RHEF100-2	—	3,000	—	15,000	HF1.0	UL, CSA, TÜV
RUSBF 16V						
RUSBF090	500	—	—	10,000	RF090	UL, CSA, TÜV
RUSBF090-2	—	3,000	—	15,000	RF090	UL, CSA, TÜV
RUSBF090-AP	—	—	2,000	10,000	RF090	UL, CSA, TÜV
RUSBF110	500	—	—	10,000	RF110	UL, CSA, TÜV
RUSBF110-2	—	3,000	—	15,000	RF110	UL, CSA, TÜV
RUSBF110-AP	—	—	2,000	10,000	RF110	UL, CSA, TÜV
RUSBF135	500	—	—	10,000	RF135	UL, CSA, TÜV
RUSBF135-2	—	3,000	—	15,000	RF135	UL, CSA, TÜV
RUSBF135-AP	—	—	2,000	10,000	RF135	UL, CSA, TÜV
RUSBF160	500	—	—	10,000	RF160	UL, CSA, TÜV
RUSBF160-2	—	3,000	—	15,000	RF160	UL, CSA, TÜV
RUSBF160-AP	—	—	2,000	10,000	RF160	UL, CSA, TÜV
RUSBF185	500	—	—	10,000	RF185	UL, CSA, TÜV
RUSBF185-2	—	3,000	—	15,000	RF185	UL, CSA, TÜV
RUSBF185-AP	—	—	2,000	10,000	RF185	UL, CSA, TÜV
RUSBF250	500	—	—	10,000	RF250	UL, CSA, TÜV
RUSBF250-2	—	3,000	—	15,000	RF250	UL, CSA, TÜV
RUSBF250-AP	—	—	2,000	10,000	RF250	UL, CSA, TÜV
RGEF 16V						
RGEF250	500	—	—	10,000	GF250	UL, CSA, TÜV
RGEF250-2	—	3,000	—	15,000	GF250	UL, CSA, TÜV
RGEF250-AP	—	—	2,000	10,000	GF250	UL, CSA, TÜV
RGEF300	500	—	—	10,000	GF300	UL, CSA, TÜV
RGEF300-2	—	2,500	—	12,500	GF300	UL, CSA, TÜV
RGEF300-AP	—	—	2,000	10,000	GF300	UL, CSA, TÜV
RGEF400	500	—	—	10,000	GF400	UL, CSA, TÜV
RGEF400-2	—	2,500	—	12,500	GF400	UL, CSA, TÜV
RGEF400-AP	—	—	2,000	10,000	GF400	UL, CSA, TÜV
RGEF500	500	—	—	10,000	GF500	UL, CSA, TÜV
RGEF500-2	—	2,000	—	10,000	GF500	UL, CSA, TÜV
RGEF500-AP	—	—	2,000	10,000	GF500	UL, CSA, TÜV
RGEF600	500	—	—	10,000	GF600	UL, CSA, TÜV
RGEF600-2	—	2,000	—	10,000	GF600	UL, CSA, TÜV
RGEF600-AP	—	—	2,000	10,000	GF600	UL, CSA, TÜV

Table R6 - Packaging and Marking Information for Radial-leaded Devices

... **Cont'd**

Part Number	Bag Quantity	Tape & Reel Quantity	Ammo Pack Quantity	Standard Pack Quantity	Part Marking	Agency Recognition
RGEF 16V						
RGEF700	500	—	—	10,000	GF700	UL, CSA, TÜV
RGEF700-2	—	1,500	—	7,500	GF700	UL, CSA, TÜV
RGEF700-AP	—	—	1,500	7,500	GF700	UL, CSA, TÜV
RGEF800	500	—	—	10,000	GF800	UL, CSA, TÜV
RGEF800-2	—	1,000	—	5,000	GF800	UL, CSA, TÜV
RGEF800-AP	—	—	1,000	5,000	GF800	UL, CSA, TÜV
RGEF900	500	—	—	10,000	GF900	UL, CSA, TÜV
RGEF900-2	—	1,000	—	5,000	GF900	UL, CSA, TÜV
RGEF900-AP	—	—	1,000	5,000	GF900	UL, CSA, TÜV
RGEF1000	250	—	—	5,000	GF1000	UL, CSA, TÜV
RGEF1000-2	—	1,000	—	5,000	GF1000	UL, CSA, TÜV
RGEF1000-AP	—	—	1,000	5,000	GF1000	UL, CSA, TÜV
RGEF1100	250	—	—	5,000	GF1100	UL, CSA, TÜV
RGEF1100-2	—	1,000	—	5,000	GF1100	UL, CSA, TÜV
RGEF1100-AP	—	—	1,000	5,000	GF1100	UL, CSA, TÜV
RGEF1200	250	—	—	5,000	GF1200	UL, CSA, TÜV
RGEF1200-2	—	1,000	—	5,000	GF1200	UL, CSA, TÜV
RGEF1200-AP	—	—	1,000	5,000	GF1200	UL, CSA, TÜV
RGEF1400	250	—	—	5,000	GF1400	UL, CSA, TÜV
RGEF1400-2	—	1,000	—	5,000	GF1400	UL, CSA, TÜV
RGEF1400-AP	—	—	1,000	5,000	GF1400	UL, CSA, TÜV
RHEF 16V - High Temperature						
RHEF200	500	—	—	10,000	HF2	UL, CSA, TÜV
RHEF200-2	—	2,500	—	12,500	HF2	UL, CSA, TÜV
RHEF200-AP	—	—	2,500	12,500	HF2	UL, CSA, TÜV
New RHEF300	500	—	—	10,000	HF3	UL, CSA, TÜV
RHEF300-2	—	2,000	—	10,000	HF3	UL, CSA, TÜV
RHEF300-AP	—	—	2,000	10,000	HF3	UL, CSA, TÜV
RHEF400	500	—	—	10,000	HF4	UL, CSA, TÜV
RHEF400-2	—	1,500	—	7,500	HF4	UL, CSA, TÜV
RHEF400-AP	—	—	1,500	7,500	HF4	UL, CSA, TÜV
RHEF450	500	—	—	10,000	HF4.5	UL, CSA, TÜV
RHEF450-2	—	1,500	—	7,500	HF4.5	UL, CSA, TÜV
RHEF450-AP	—	—	1,500	7,500	HF4.5	UL, CSA, TÜV
New RHEF550	500	—	—	10,000	HF5.5	UL, CSA, TÜV
RHEF550-2	—	2,000	—	10,000	HF5.5	UL, CSA, TÜV
RHEF550-AP	—	—	2,000	10,000	HF5.5	UL, CSA, TÜV
RHEF600	500	—	—	10,000	HF6	UL, CSA, TÜV
RHEF600-2	—	1,500	—	7,500	HF6	UL, CSA, TÜV
RHEF600-AP	—	—	1,500	7,500	HF6	UL, CSA, TÜV
RHEF650	500	—	—	10,000	HF6.5	UL, CSA, TÜV
RHEF650-2	—	1,500	—	7,500	HF6.5	UL, CSA, TÜV
RHEF650-AP	—	—	1,500	7,500	HF6.5	UL, CSA, TÜV
New RHEF700	500	—	—	10,000	HF7	UL, CSA, TÜV
RHEF700-2	—	1,500	—	7,500	HF7	UL, CSA, TÜV
RHEF700-AP	—	—	1,500	7,500	HF7	UL, CSA, TÜV
RHEF750	500	—	—	10,000	HF7.5	UL, CSA, TÜV
RHEF750-2	—	1,000	—	5,000	HF7.5	UL, CSA, TÜV
RHEF750-AP	—	—	1,000	5,000	HF7.5	UL, CSA, TÜV
New RHEF800	500	—	—	10,000	HF8	UL, CSA, TÜV
RHEF800-2	—	1,000	—	5,000	HF8	UL, CSA, TÜV
RHEF800-AP	—	—	1,000	5,000	HF8	UL, CSA, TÜV
RHEF900	250	—	—	5,000	HF9	UL, CSA, TÜV
RHEF900-2	—	1,000	—	5,000	HF9	UL, CSA, TÜV
RHEF900-AP	—	—	1,000	5,000	HF9	UL, CSA, TÜV
RHEF1000	250	—	—	5,000	HF10	UL, CSA, TÜV
RHEF1000-2	—	1,000	—	5,000	HF10	UL, CSA, TÜV
RHEF1000-AP	—	—	1,000	5,000	HF10	UL, CSA, TÜV
New RHEF1100	250	—	—	5,000	HF11	UL, CSA, TÜV
RHEF1100-2	—	1,000	—	5,000	HF11	UL, CSA, TÜV
RHEF1100-AP	—	—	1,000	5,000	HF11	UL, CSA, TÜV

Table R6 - Packaging and Marking Information for Radial-leaded Devices

... **Cont'd**

Part Number	Bag Quantity	Tape & Reel Quantity	Ammo Pack Quantity	Standard Pack Quantity	Part Marking	Agency Recognition
RHEF 16V						
RHEF1300	250	—	—	5,000	HF13	UL, CSA, TÜV
RHEF1300-2	—	1,000	—	5,000	HF13	UL, CSA, TÜV
RHEF1300-AP	—	—	1,000	5,000	HF13	UL, CSA, TÜV
New RHEF1400	250	—	—	5,000	HF14	UL, CSA, TÜV
RHEF1400-2	—	1,000	—	5,000	HF14	UL, CSA, TÜV
RHEF1400-AP	—	—	1,000	5,000	HF14	UL, CSA, TÜV
RHEF1500	250	—	—	5,000	HF15	UL, CSA, TÜV
RHEF1500-2	—	1,000	—	5,000	HF15	UL, CSA, TÜV
RHEF1500-AP	—	—	1,000	5,000	HF15	UL, CSA, TÜV
RUSBF 6V						
RUSBF075	500	—	—	10,000	RF075	UL, CSA, TÜV
RUSBF075-2	—	3,000	—	15,000	RF075	UL, CSA, TÜV
RUSBF075-AP	—	—	2,500	12,500	RF075	UL, CSA, TÜV
RUSBF120	500	—	—	10,000	RF120	UL, CSA, TÜV
RUSBF120-2	—	3,000	—	15,000	RF120	UL, CSA, TÜV
RUSBF120-AP	—	—	2,000	10,000	RF120	UL, CSA, TÜV
RUSBF155	500	—	—	10,000	RF155	UL, CSA, TÜV
RUSBF155-2	—	3,000	—	15,000	RF155	UL, CSA, TÜV
RUSBF155-AP	—	—	2,000	10,000	RF155	UL, CSA, TÜV

Table R7 - Tape and Reel Specifications for Radial-leaded Devices

RXEF and BBRF devices are available in tape and reel packaging per EIA468-B/IEC60286-2 standards. See Figures R24 and R25 for details.

Description	EIA Mark	Dimension (mm)	Tolerance
Carrier tape width	W	18	-0.5/+1.0
Hold-down tape width	W ₄	11	Minimum
Top distance between tape edges	W ₆	3	Maximum
Sprocket hole position	W ₅	9	-0.5/+0.75
Sprocket hole diameter	D ₀	4	± 0.2
Abscissa to plane (straight lead) RXEF110 to RXEF300	H	18.5	± 2.5
Abscissa to plane (kinked lead) RXEF010 to RXEF090, BBRF550, BBRF750	H ₀	16.0	± 0.5
Abscissa to top RXEF010 to RXEF090, BBRF550, BBRF750	H ₁	32.2	Maximum
Abscissa to top* RXEF110 to RXEF300	H ₁	47.5	Maximum
Overall width with lead protrusion RXEF010 to RXEF090, BBRF550, BBRF750	C ₁	43.2	Maximum
Overall width with lead protrusion* RXEF110 to RXEF300	C ₁	58	Maximum
Overall width without lead protrusion RXEF010 to RXEF090, BBRF550, BBRF750	C ₂	42.5	Maximum
Overall width without lead protrusion* RXEF110 to RXEF300	C ₂	57	Maximum
Lead protrusion	L ₁	1.0	Maximum
Protrusion of cut-out	L	11.0	Maximum
Protrusion beyond hold-down tape	l ₂	Not specified	—
Sprocket hole pitch	P ₀	12.7	± 0.3
Device pitch RXEF010 to RXEF090, BBRF550, BBRF750	—	12.7	± 0.3
Device pitch RXEF110 to RXEF300	—	25.4	± 0.61
Pitch tolerance	—	20 consecutive	± 1
Tape thickness	t	0.9	Maximum
Overall tape and lead thickness RXEF010 to RXEF090	t ₁	1.5	Maximum
Overall tape and lead thickness RXEF110 to RXEF300, BBRF550, BBRF750*	t ₁	2.3	Maximum
Splice sprocket hole alignment	—	0	± 0.3
Body lateral deviation	Δh	0	± 1.0
Body tape plane deviation	Δp	0	± 1.3
Ordinate to adjacent component lead RXEF010 to RXEF090, BBRF550, BBRF750	P ₁	3.81	± 0.7
Ordinate to adjacent component lead RXEF110 to RXEF300	P ₁	7.62	± 0.7
Lead spacing* RXEF010 to RXEF185, BBRF550, BBRF750	F	5.08	+0.75/-0.5
Lead spacing* RXEF250 to RXEF300	F	10.2	+0.75/-0.5
Reel width RXEF010 to RXEF090	w ₂	56.0	Maximum
Reel width* RXEF110 to RXEF300	w ₂	63.5	Maximum
Reel diameter	a	370.0	Maximum
Space between flanges less device	w ₁	4.75	± 3.25
Arbor hold diameter	c	26.0	± 12.0
Core diameter*	n	91.0	Maximum
Box	—	64/372/362	Maximum
Consecutive missing places	—	None	—
Empty places per reel	—	0.1%	Maximum

*Differs from EIA specification.

Table R7 - Tape and Reel Specifications for Radial-leaded Devices

... Cont'd

RUEF, RTEF and RUSBF devices are available in tape and reel packaging per EIA468-B/IEC60286-2 standards. See Figures R24 and R25 for details.

Description	EIA Mark	Dimension (mm)	Tolerance
Carrier tape width	W	18	-0.5/+1.0
Hold-down tape width	W ₄	11	Minimum
Top distance between tape edges	W ₆	3	Maximum
Sprocket hole position	W ₅	9	-0.5/+0.75
Sprocket hole diameter	D ₀	4	± 0.2
Abscissa to plane (straight lead)* RUEF300 to RUEF900	H	18.5	± 2.5
Abscissa to plane (kinked lead) RUSBF075 to RUSBF250, RUEF090 to RUEF250, RTEF120 to RTEF190	H ₀	16.0	± 0.5
Abscissa to top RUSBF075 to RUSBF250, RUEF090 to RUEF300, RTEF120 to RTEF190	H ₁	32.2	Maximum
Abscissa to top* RUEF400 to RUEF900	H ₁	45.0	Maximum
Overall width w/lead protrusion RUSBF075 to RUSBF250, RUEF090 to RUEF300, RTEF120 to RTEF190	C ₁	43.2	Maximum
Overall width w/ lead protrusion RUEF400 to RUEF900	C ₁	56	Maximum
Overall width w/o lead protrusion RUSBF075 to RUSBF250, RUEF090 to RUEF300, RTEF120 to RTEF190	C ₂	42.5	Maximum
Overall width w/o lead protrusion RUEF400 to RUEF900	C ₂	56	Maximum
Lead protrusion	L ₁	1.0	Maximum
Protrusion of cut-out	L	11	Maximum
Protrusion beyond hold-down tape	l ₂	Not specified	—
Sprocket hole pitch	P ₀	12.7	± 0.3
Device pitch RUSBF075 to RUSBF250, RUEF090 to RUEF300, RTEF120 to RTEF190	—	12.7	± 0.3
Device pitch RUEF400 to RUEF900	—	25.4	± 0.6
Pitch tolerance	—	20 consecutive	± 1
Tape thickness	t	0.9	Maximum
Overall tape and lead thickness RUSBF075 to RUSBF250, RUEF090 to RUEF250, RTEF120 to RTEF190	t ₁	1.5	Maximum
Overall tape and lead thickness* RUEF300 to RUEF900	t ₁	2.3	Maximum
Splice sprocket hole alignment	—	0	± 0.3
Body lateral deviation	Δh	0	± 1.0
Body tape plane deviation	Δp	0	± 1.3
Ordinate to adjacent component lead RUSBF075 to RUSBF250, RUEF090 to RUEF300, RTEF120 to RTEF190	P ₁	3.81	± 0.7
Ordinate to adjacent component lead RUEF400 to RUEF900	P ₁	7.62	± 0.7
Lead spacing* RUSBF075 to RUSBF250, RUEF090 to RUEF400, RTEF120 to RTEF190	F	5.08	+0.75/-0.5
Lead spacing* RUEF500 to RUEF900	F	10.2	+0.75/-0.5
Reel width RUEF090 to RUEF400, RUSBF075 to RUSBF250, RTEF120 to RTEF190	w ₂	56.0	Maximum
Reel width RUEF500* to RUEF900	w ₂	63.5	Maximum
Reel diameter	a	370.0	Maximum
Space between flanges less device	w ₁	4.75	± 3.25
Arbor hold diameter	c	26.0	± 12.0
Core diameter*	n	91.0	Maximum
Box	—	64/372/362	Maximum
Consecutive missing places	—	None	—
Empty places per reel	—	0.1%	Maximum

*Differs from EIA specification.

Table R7 - Tape and Reel Specifications for Radial-leaded Devices

... **Cont'd**

RGEF and RHEF devices are available in tape and reel packaging per EIA468-B/IEC60286-2 standards. See Figures R24 and R25 for details.

Dimension Description	EIA Mark	Dimension (mm)	Tolerance
Carrier tape width	W	18	-0.5/+1.0
Hold-down tape width	W ₄	11	Minimum
Top distance between tape edges	W ₆	3	Maximum
Sprocket hole position	W ₅	9	-0.5/+0.75
Sprocket hole diameter	D ₀	4	± 0.2
Abscissa to plane (straight lead) RGEF250 to RGEF1400	H	18.5	± 2.5
Abscissa to plane (kinked lead) RHEF050 to RHEF1500	H ₀	16.0	± 0.5
Abscissa to top RGEF250 to RGEF600, RHEF050 to RHEF450	H ₁	32.2	Maximum
Abscissa to top* RGEF700 to RGEF1400, RHEF600 to RHEF1500	H ₁	45.0	Maximum
Overall width w/lead protrusion RGEF250 to RGEF600, RHEF050 to RHEF450	C ₁	43.2	Maximum
Overall width w/lead protrusion RGEF700 to RGEF1400, RHEF600 to RHEF1500	C ₁	55	Maximum
Overall width w/o lead protrusion RGEF250 to RGEF600, RHEF050 to RHEF450	C ₂	42.5	Maximum
Overall width w/o lead protrusion RGEF700 to RGEF1400, RHEF600 to RHEF1500	C ₂	54	Maximum
Lead protrusion	L ₁	1.0	Maximum
Protrusion of cut-out	L	11	Maximum
Protrusion beyond hold-down tape	l ₂	Not specified	—
Sprocket hole pitch	P ₀	12.7	± 0.3
Device pitch RGEF250 to RGEF700, RHEF050 to RHEF600	—	25.4	± 0.61
Device pitch RGEF800 to RGEF1400, RHEF650 to RHEF1500	—	25.4	± 0.6
Pitch tolerance	—	20 consecutive	± 1
Tape thickness	t	0.9	Maximum
Overall tape and lead thickness* RGEF250 to RGEF1100, RHEF050 to RHEF1000	t ₁	2.0	Maximum
Overall tape and lead thickness* RGEF1200 to RGEF1400, RHEF1300, RHEF1500	t ₁	2.3	Maximum
Splice sprocket hole alignment	—	0	± 0.3
Body lateral deviation	h	0	± 1.0
Body tape plane deviation	Δp	0	± 1.3
Ordinate to adjacent component lead RGEF300 to RGEF1100, RHEF400 to RHEF750	P ₁	3.81	± 0.7
Ordinate to adjacent component lead RGEF1200 to RGEF1400, RHEF1000 to RHEF1500	P ₁	7.62	± 0.7
Lead spacing* RGEF250 to RGEF1100, RHEF050 to RHEF900	F	5.08	+0.75 /-0.5
Lead spacing* RGEF1200 to RGEF1400, RHEF1000 to RHEF1500	F	10.2	+ 0.75/-0.5
Reel width RGEF250 to RGEF600, RHEF050 to RHEF450	w ₂	56.0	Maximum
Reel width* RGEF600 to RGEF1400 & RHEF600 to RHEF1500	w ₂	63.5	Maximum
Reel diameter	a	370.0	Maximum
Space between flanges less device*	w ₁	4.75	± 3.25
Arbor hold diameter	c	26.0	± 12.0
Core diameter*	n	91.0	Maximum
Box	—	64/372/362	Maximum
Consecutive missing places	—	None	—
Empty places per reel	—	0.1%	Maximum

*Differs from EIA specification.

Figure R24 - EIA Referenced Taped Component Dimensions for Radial-leaded Devices

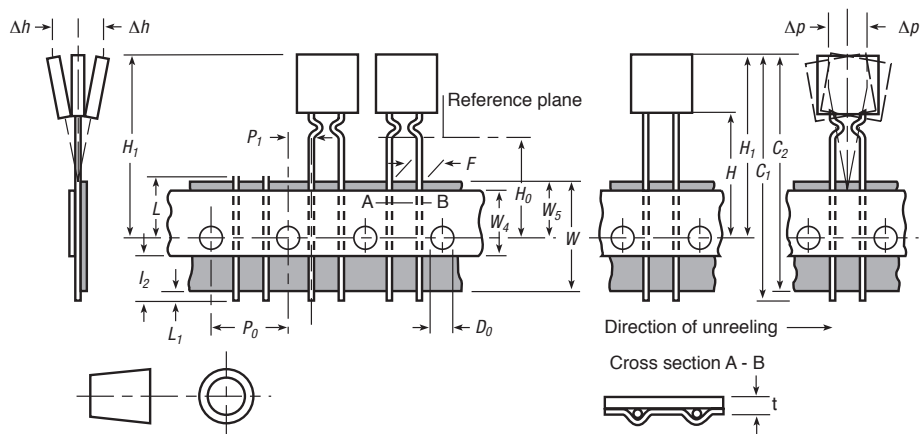
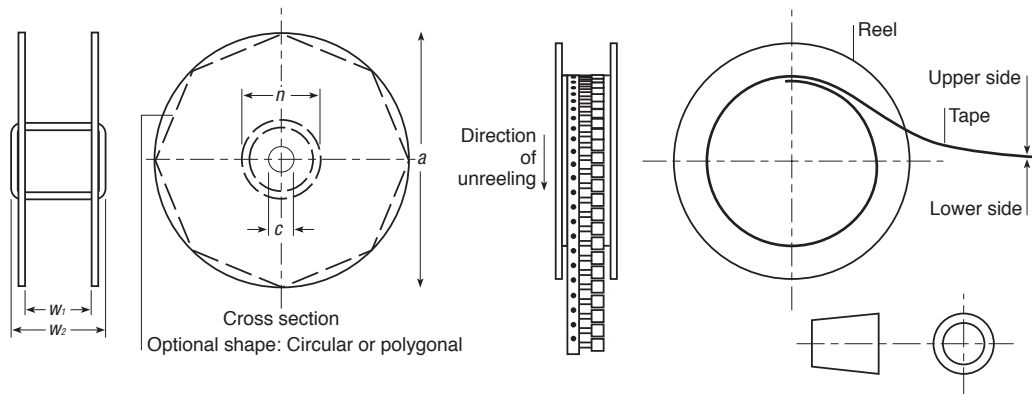
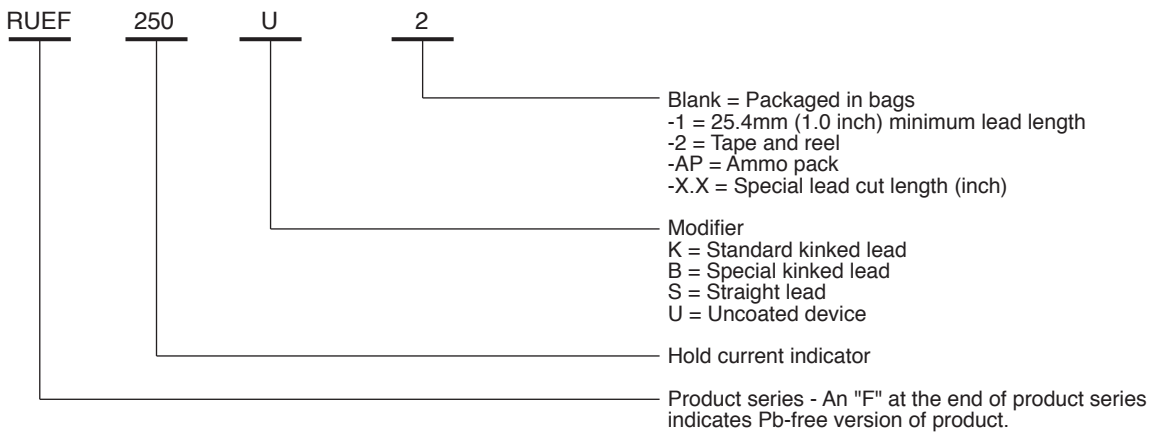

Figure R25 - EIA Referenced Reel Dimensions for Radial-leaded Devices



Part Numbering System for Radial-leaded Devices



⚠ WARNING: Application Limitations for the LVR Product Line

- 1) Users should independently evaluate the suitability of and test each product selected for their own application.
- 2) This product should not be used in an application where the maximum interrupt voltage or maximum interrupt current can be exceeded in a fault condition. Operation beyond the maximum ratings or improper use may result in device damage and possible electrical arcing and flame.
- 3) A PTC device is not a fuse - it is a nonlinear thermistor that limits current. Because under a fault condition all PTC devices go into a high resistance state but not open circuit, hazardous voltage may be present at PTC locations.
- 4) The devices are intended for protection against occasional overcurrent or overtemperature fault conditions and should not be used when repeated fault conditions or prolonged trip events are anticipated.
- 5) In most applications, power must be removed and the fault condition cleared in order to reset a PTC device. However, under certain unusual conditions, a PTC device may automatically reset. Accordingly, PTC devices should not be used in an application where an automatic reset could create a safety hazard, such as garbage disposals and blenders.
- 6) It is the responsibility of the user to determine the need for back up or fail safe protection to prevent damage that may occur in the event of abnormal function or failure of the PTC device.
- 7) Operation in circuits with a large inductance can generate a circuit voltage (Ldi/dt) above the rated voltage of a PTC device.
- 8) Devices are not recommended for reflow soldering.
- 9) Device performance can be impacted negatively if devices are handled in a manner inconsistent with recommended electronic, thermal, or mechanical procedures for electronic components.
- 10) PTC devices are not recommended to be installed in applications where the device is constrained such that its PTC properties are inhibited, for example in rigid potting materials or in rigid housings, which lack adequate clearance to accommodate device expansion.
- 11) Contamination of the PTC material with certain silicone-based oils or some aggressive solvents can adversely impact the performance of the devices.

**WARNING:**

- Operation beyond the maximum ratings or improper use may result in device damage and possible electrical arcing and flame.
- The devices are intended for protection against occasional overcurrent or overtemperature fault conditions and should not be used when repeated fault conditions or prolonged trip events are anticipated.
- Contamination of the PPTC material with certain silicon based oils or some aggressive solvents can adversely impact the performance of the devices.
- Device performance can be impacted negatively if devices are handled in a manner inconsistent with recommended electronic, thermal, and mechanical procedures for electronic components.
- Operation in circuit with a large inductance can generate a circuit voltage ($L \frac{di}{dt}$) above the rated voltage of the PolySwitch resettable device.