

Features

1 or 2 Pole electromechanical step relay, for electrically common coil and contact circuits

27.0x - Connect up to 24 illuminated push buttons with the addition of module 027.00

27.2x - Connect up to 15 illuminated push buttons (without additional module)
- incorporates coil power limiter to permit continuous coil energisation

- Choice of 3 switching sequences
- Screw terminal connections
- AC coil
- Panel mount
- Cadmium free contact material

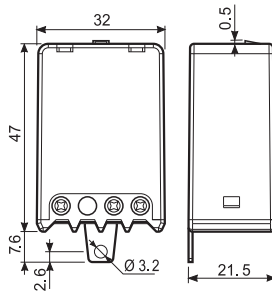

27.0x



- Single or 2 double phase switch 1 NO (SPST-NO) or 2 NO (DPST-NO)

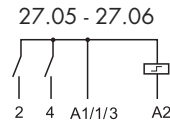

NEW 27.2x EVO



- Single or 2 double phase switch 1 NO (SPST-NO) or 2 NO (DPST-NO) with coil power limiter

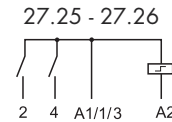
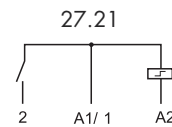

Contact specification					
Number of contacts		1 or 2		1 or 2	
Rated current/Maximum peak current	A	10/20		10/20	
Rated voltage/Maximum switching voltage V AC		110/—	230/—	230/—	
Rated load AC1	VA	1100	2300	2300	
Rated load AC15	VA	250	500	500	
Nominal lamp rating:	incandescent	W	500	1000	1000
	compensated fluorescent	W	180	360	360
	uncompensated fluorescent	W	250	500	500
	halogen	W	400	800	800
Minimum switching current	mW (V/mA)	10		10	
Standard contact material		AgNi		AgNi	
Coil specification					
Nominal voltage (U _N)	V AC (50/60 Hz)	110	230	230	
	V DC	—		—	
Pickup/continuous power	VA (50 Hz)	4/4		25/1	
Operating range	AC 50Hz/AC 60Hz	(0.8 ... 1.1)U _N /(0.85 ... 1.1)U _N		(0.8 ... 1.1)U _N /(0.85 ... 1.1)U _N	
	DC	—		—	
Technical data					
Mechanical life AC/DC	cycles	300 · 10 ³		300 · 10 ³	
Electrical life at rated load in AC1	cycles	100 · 10 ³		100 · 10 ³	
Max no. of illuminated push-button	(≤1 mA)	4 (24 with module 027.00)		15	
Minimum/Maximum impulse duration		0.1s/1h (according to EN 60669)		0.1s/continuous	
Ambient temperature range	°C	-40...+40		-40...+40	
Protection category		IP 20		IP 20	
Approvals (according to type)					

Ordering information

Example: 27 series screw terminal, panel mount step relay, single phase switch 1 NO (SPST-NO) 10 A contact, coil rated 230 V AC.

2 7 . 0 1 . 8 . 2 3 0 . 0 0 0 0

Series —————
Type —————
 0 = Clamp terminal
 2 = Clamp terminal, with coil power limiter

Coil voltage
 See coil specifications

Coil version
 8 = AC (50/60 Hz)

No. of poles —————
 1 = Single phase switch 1 NO (SPST-NO)
 5 = 4 sequences double phase switch 2 NO (DPST-NO)
 6 = 3 sequences double phase switch 2 NO (DPST-NO)

Technical data

Other data	27.01, 27.21		27.05, 27.06, 27.25, 27.26	
Power lost to the environment with rated current and coil de-energised	W	0.9	1.8	
Screw torque	Nm	0.8	0.8	
Max. wire size		solid cable	stranded cable	solid cable
	mm ²	2x2.5	1x4 / 2x2.5	2x2.5
	AWG	2x14	1x12 / 2x14	2x14

Coil specifications

Types 27.01, 27.05, 27.06

Nominal voltage U_N V	Coil code	Operating range (50 Hz)		Resistance R Ω	Consumption I at U_N (50 Hz) mA
		U_{min} V	U_{max} V		
110	8.110	88	121	1,400	42.0
230	8.230	184	253	6,500	17.5

Type	Number of steps	Sequence			
		1	2	3	4
27.01/21	2				
27.05/25	4				
27.06/26	3				

Types 27.21, 27.25, 27.26

Nominal voltage U_N V	Coil code	Operating range (50 Hz)		Resistance R Ω	Consumption	
		U_{min} V	U_{max} V		pick up I at U_N (50 Hz) mA	continuous I at U_N (50 Hz) mA
230	8.230	184	253	1,250	100	4

Wiring diagram

Type 27.01/05/06

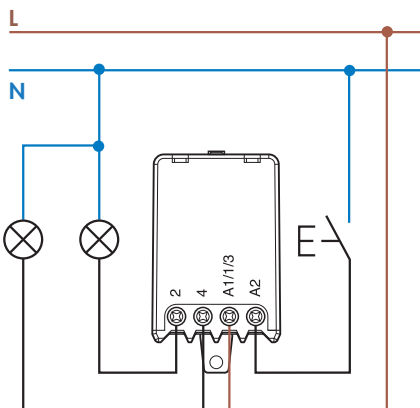

Type 27.21/25/26

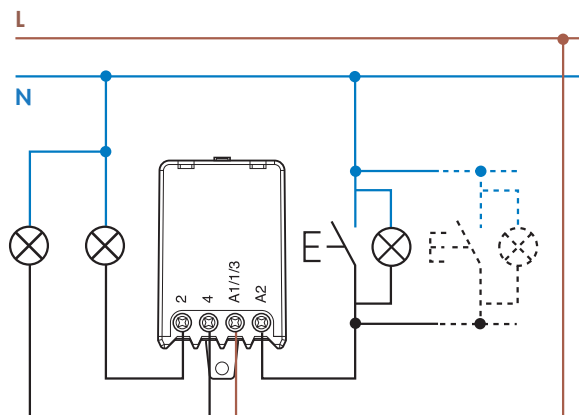

Accessories for types 27.01, 27.05, 27.06
Module for illuminated push-button (230 V AC applications)

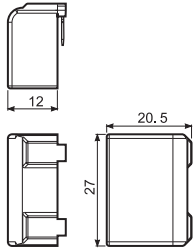

Type 027.00

This module is necessary if using up to a maximum of 24 illuminated push-buttons (1 mA max, 230 V AC) in the switching input circuit. It must be plugged directly into the relay.

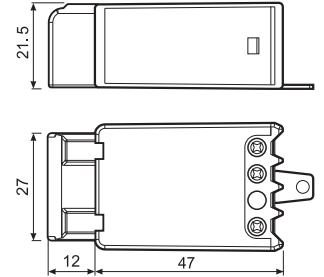

Type 27.0x + 027.00

