

Features

Ultra-slim 1 Pole - 6 A relay

Printed circuit mount

- direct or via PCB socket

35 mm rail mount

- via screw or screwless sockets

- 1 Pole changeover contacts or 1 Pole normally open contact
- Ultra slim, 5 mm, package
- Sensitive DC coil - 170 mW (Dual AC/DC coil drive possible using 93 series sockets)
- UL Listing (certain relay/socket combinations)
- Cadmium Free contact materials
- 8/8 mm clearance/creepage distance
- 6 kV (1.2/50 μ s) insulation, coil-contacts

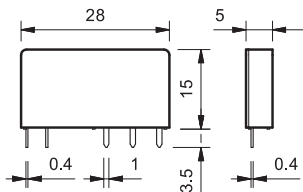

FOR UL HORSEPOWER AND PILOT DUTY RATINGS
SEE "General technical information" page V

34.51



- 5 mm wide
- Low coil power
- PCB or 93 series sockets

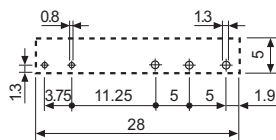
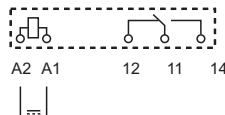

Copper side view

Contact specification

Contact configuration		1 CO (SPDT)
Rated current/Maximum peak current	A	6/10
Rated voltage/Maximum switching voltage V AC		250/400
Rated load AC1	VA	1,500
Rated load AC15 (230 V AC)	VA	300
Single phase motor rating (230 V AC)	kW	0.185
Breaking capacity DC1: 30/110/220 V	A	6/0.2/0.12
Minimum switching load	mW (V/mA)	500 (12/10)
Standard contact material		AgNi

Coil specification

Nominal voltage (U_N)	V AC (50/60 Hz)	—
	V DC	5 - 12 - 24 - 48 - 60
Rated power AC/DC	VA (50 Hz)/W	—/0.17
Operating range	AC	—
	DC	$(0.7 \dots 1.5)U_N$
Holding voltage	AC/DC	—/0.4 U_N
Must drop-out voltage	AC/DC	—/0.05 U_N

Technical data

Mechanical life AC/DC	cycles	—/10 · 10 ⁶
Electrical life at rated load AC1	cycles	60 · 10 ³
Operate/release time	ms	5/3
Insulation between coil and contacts (1.2/50 μ s)	kV	6 (8 mm)
Dielectric strength between open contacts V AC		1,000
Ambient temperature range	°C	—40...+85
Environmental protection		RT II

Approvals (according to type)



Features

Ultra-slim - Solid State Relays

Printed circuit mount

- direct or via PCB socket

35 mm rail mount

- via screw or screwless sockets

- Single circuit output switching options
 - 2 A 24 V DC
 - 0.1 A 48 V DC
 - 2 A 240 V AC
- Silent, high speed switching with long electrical life
- Ultra slim, 5 mm, package
- Sensitive DC Input circuits (Dual AC/DC input drive possible using 93 series sockets)
- UL Listing (certain relay/socket combinations)
- Wash tight: RT III
- 2,500 V insulation, input-output

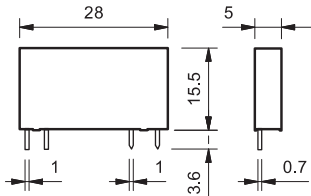

34.81-9024



- 2 A, 24 V DC output switching
- PCB or 93 series sockets

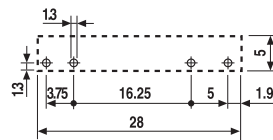
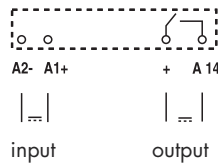

Copper side view

34.81-7048



- 0.1 A, 48 V DC output switching
- PCB or 93 series sockets

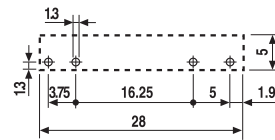
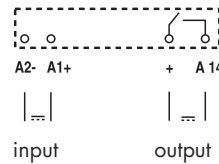

Copper side view

34.81-8240



- 2 A, 240 V AC output switching
- Zero crossing switching
- PCB or 93 series sockets

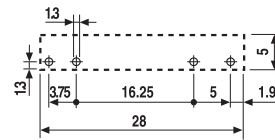
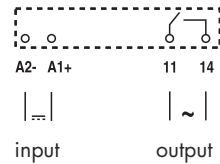

Copper side view

Output circuit									
Contact configuration		1 NO (SPST-NO)			1 NO (SPST-NO)		1 NO (SPST-NO)		
Rated current/Maximum peak current (10 ms) A		2/20			0.1/0.5		2/40		
Rated voltage/Maximum blocking voltage V		(24/33)DC			(48/60)DC		(240/275)AC		
Switching voltage range V		(1.5...24)DC			(1.5...48)DC		(12...240)AC		
Minimum switching current mA		1			0.05		22		
Max. "OFF-state" leakage current mA		0.001			0.001		1.5		
Max. "ON-state" voltage drop V		0.12			1		1.6		
Input circuit									
Nominal voltage V DC		5	24	60	24	60	5	24	60
Rated power AC/DC W		0.035	0.17	0.18	0.17	0.18	0.060	0.17	0.18
Operating range V DC		3.5...12	16...30	35...72	16...30	35...72	3.5...10	16...30	35...72
Control current mA		7	7	3	7	3	12	7	3
Release voltage V DC		1	10	20	10	20	1	10	20
Impedance Ω		715	3,200	21,300	3,200	21,300	416	3,200	21,300
Technical data									
Operate/release time ms		0.1/0.6*			0.04/0.6*		12/12*		
Dielectric strength between input/output V		2,500			2,500		2,500		
Ambient temperature range °C		-20...+60			-20...+60		-20...+60		
Environmental protection		RT III			RT III		RT III		
Approvals (according to type)									

* Note: all technical data relates to using the relay directly on PCB or PCB socket type 93.11.
If the relay is use with 35 mm rail socket types 93.01, 93.21 or 93.51, refer to the technical data of 38 Series.

Ordering information

Electromechanical relay (EMR)

Example: 34 series slim electromechanical relay, 1 CO (SPDT) 6 A contacts, 24 V sensitive DC coil.

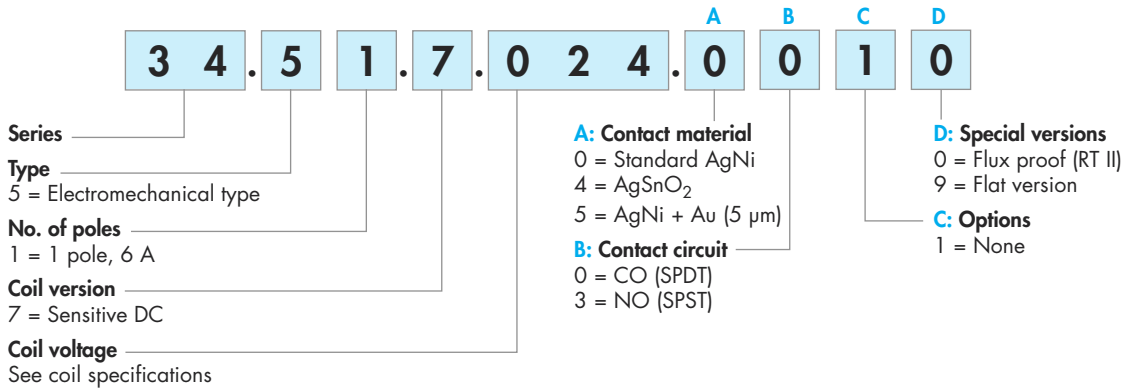

Selecting features and options: only combinations in the same row are possible. Preferred selections for best availability are shown in **bold**.

Type	Coil version	A	B	C	D
34.51	sens. DC	0 - 4 - 5	0 - 3	1	0
34.51	sens. DC	0 - 4 - 5	0	1	9

Solid state relay (SSR)

Example: 34 series SSR relay, 2 A output, 24 V DC supply.

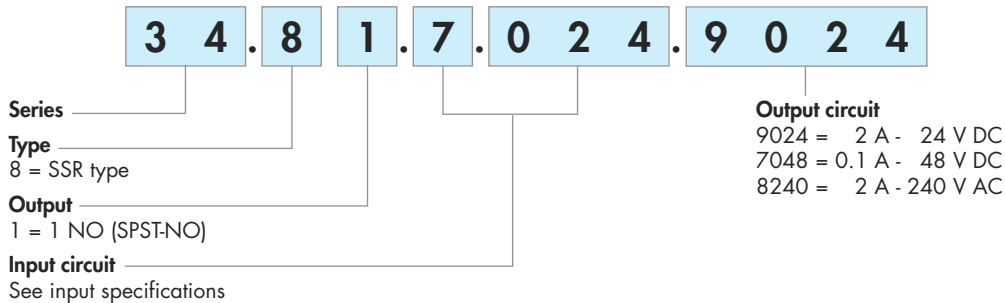

Flat pack version



Option = 34.51.7xxx.x019

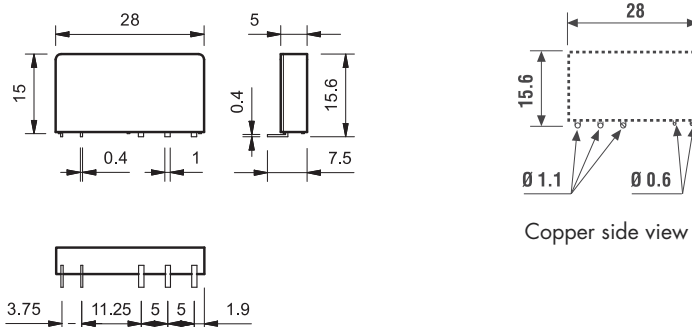

Electromechanical relay

Technical data

Insulation according to EN 61810-1			
Nominal voltage of supply system	V AC	230/400	
Rated insulation voltage	V AC	250	400
Pollution degree		3	2
Insulation between coil and contact set			
Type of insulation		Reinforced	
Overvoltage category		III	
Rated impulse voltage	kV (1.2/50 μ s)	6	
Dielectric strength	V AC	4,000	
Insulation between open contacts			
Type of disconnection		Micro-disconnection	
Dielectric strength	V AC/kV (1.2/50 μ s)	1,000/1.5	
Conducted disturbance immunity			
Burst (5...50)ns, 5 kHz, on A1 - A2		EN 61000-4-4	level 4 (4 kV)
Surge (1.2/50 μ s) on A1 - A2 (differential mode)		EN 61000-4-5	level 3 (2 kV)
Other data			
Bounce time: NO/NC	ms	1/6	
Vibration resistance (5...55)Hz: NO/NC	g	10/5	
Shock resistance	g	20/14	
Power lost to the environment	without contact current	W	0.2
	with rated current	W	0.5
Recommended distance between relays mounted on PCB	mm	≥ 5	

Contact specification

F 34 - Electrical life (AC) v contact current

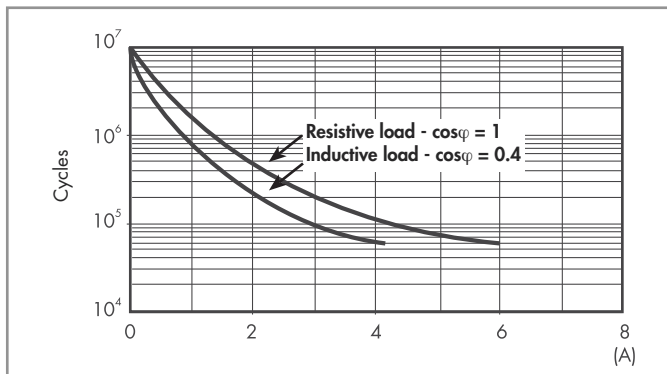

H 34 - Maximum DC1 breaking capacity

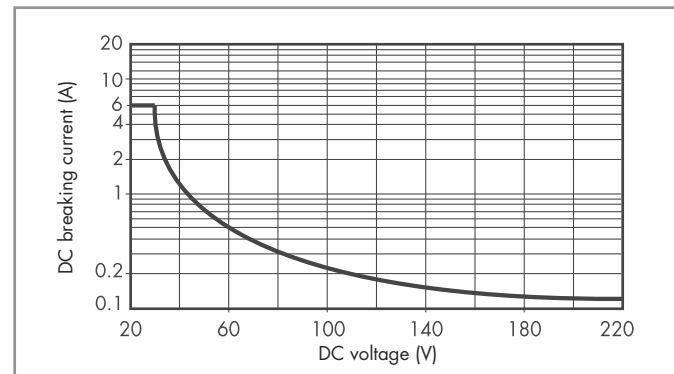

- When switching a resistive load (DC1) having voltage and current values under the curve, an electrical life of $\geq 60 \cdot 10^3$ can be expected.
- In the case of DC13 loads, the connection of a diode in parallel with the load will permit a similar electrical life as for a DC1 load. Note: the release time for the load will be increased.

Coil specifications

DC coil data

Nominal voltage U_N V	Coil code	Operating range		Resistance R Ω	Rated coil consumption I at U_N mA
		U_{min} V	U_{max} V		
5	7.005	3.5	7.5	130	38.4
12	7.012	8.4	18	840	14.2
24	7.024	16.8	36	3,350	7.1
48	7.048	33.6	72	12,300	3.9
60	7.060	42	90	19,700	3

R 34 - DC coil operating range v ambient temperature

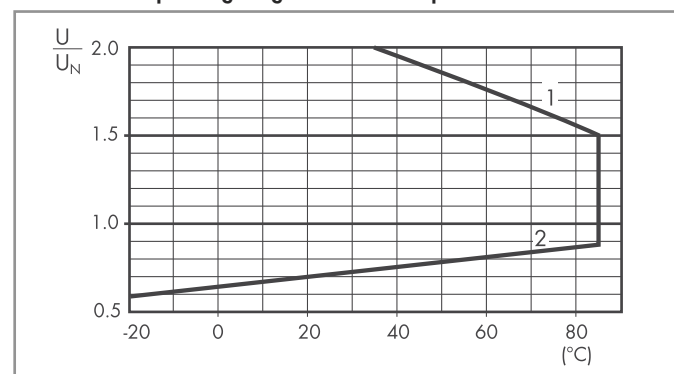

- 1 - Max. permitted coil voltage.
- 2 - Min. pick-up voltage with coil at ambient temperature.

Solid state relay

Technical data

Other data

Power lost to the environment	without output current	W	0.17
	with rated current	W	0.4

Input specification

Input data - DC types

Nominal voltage U_N V	Input code	Operating range		Release voltage V	Impedance Ω	Control current I at U_N mA
		U_{min} V	U_{max} V			
5	7.005	3.5	12 (10*)	1	715 (416*)	7 (12*)
24	7.024	16	30	10	3,200	7
60	7.060	35	72	20	21,300	3

* AC Output version.

Output specification

L 34 - Output current v ambient temperature
SSR - 2 A DC & AC output types

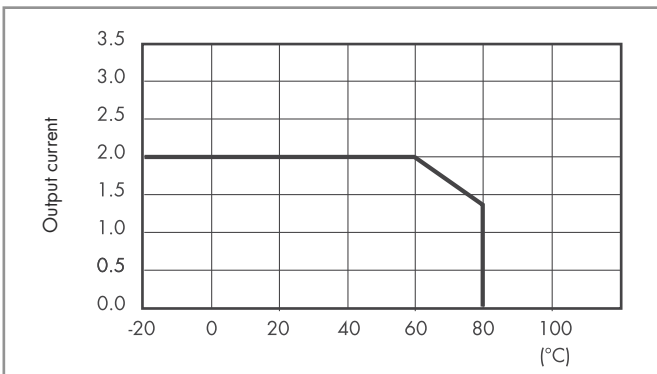

L 34 - Output current v ambient temperature
SSR - 0.1 A DC output types

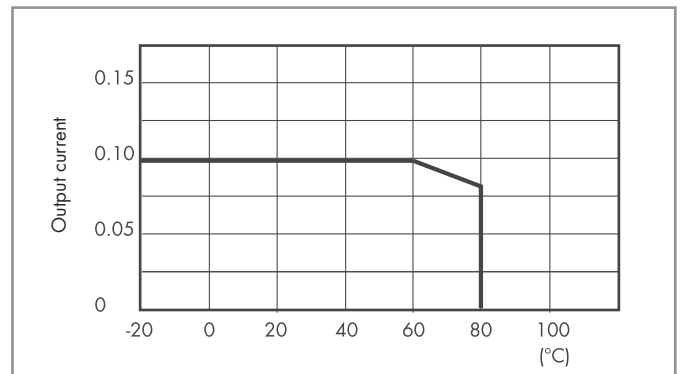

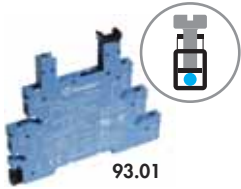

93.01

Approvals (according to type):



RINA cRU[®] US

US Certain relay/socket combinations

Screw terminal socket 35 mm (EN 60715) mounting

Supply voltage	Relay type	Socket type
12 V AC/DC	34.51.7.012.xx10	93.01.0.024
24 V AC/DC	34.51.7.024.xx10	93.01.0.024
48 V AC/DC	34.51.7.048.xx10	93.01.0.060
60 V AC/DC	34.51.7.060.xx10	93.01.0.060
(110...125)V AC/DC	34.51.7.060.xx10 or 34.81.7.060.xxxx	93.01.0.125
(220...240)V AC/DC	34.51.7.060.xx10 or 34.81.7.060.xxxx	93.01.0.240
(110...125)V AC/DC*	34.51.7.060.xx10 or 34.81.7.060.xxxx	93.01.3.125*
(220...240)V AC*	34.51.7.060.xx10 or 34.81.7.060.xxxx	93.01.3.240*
(220...240)V AC	34.51.7.060.xx10 or 34.81.7.060.xxxx	93.01.8.240
6 V DC	34.51.7.005.xx10 or 34.81.7.005.xxxx	93.01.7.024
12 V DC	34.51.7.012.xx10	93.01.7.024
24 V DC	34.51.7.024.xx10 or 34.81.7.024.xxxx	93.01.7.024
48 V DC	34.51.7.048.xx10	93.01.7.060
60 V DC	34.51.7.060.xx10 or 34.81.7.060.xxxx	93.01.7.060

Accessories

20-way jumper link	093.20 (see specification next page)
Plastic separator	093.01 (see specification next page)
Sheet of marker tags	093.64 (see specification next page)

Technical data

Rated values	6A - 250 V		
Dielectric strength	6 kV (1.2/50 μs) between coil and contacts		
Protection category	IP 20		
Ambient temperature	(-40...+70)°C (U _N ≤ 60 V), (-40...+55)°C (U _N > 60 V)		
Screw torque	Nm	0.5	
Wire strip length	mm	10	
Max. wire size for 93.01 socket	solid wire	stranded wire	
	mm ²	1x2.5 / 2x1.5	1x2.5 / 2x1.5
	AWG	1x14 / 2x16	1x14 / 2x16

* Leakage current suppression.

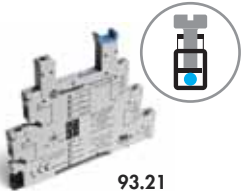
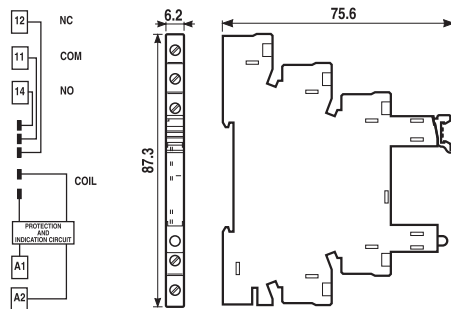

93.21

Approvals (according to type):



Slim timed socket for 34 series (refer to 38 series data sheet for technical data)

Output	Supply voltage	Type of relay	Type of socket
1 pole 6A, electromechanical relay	12 V AC/DC	34.51.7.012.0010	93.21.0.024
1 pole 6A, electromechanical relay	24 V AC/DC	34.51.7.024.0010	93.21.0.024
1 output 2A 24 V DC, solid state relay	24 V AC/DC	34.81.7.024.9024	93.21.0.024
1 output 2A 240 V AC, solid state relay	24 V AC/DC	34.81.7.024.8240	93.21.0.024

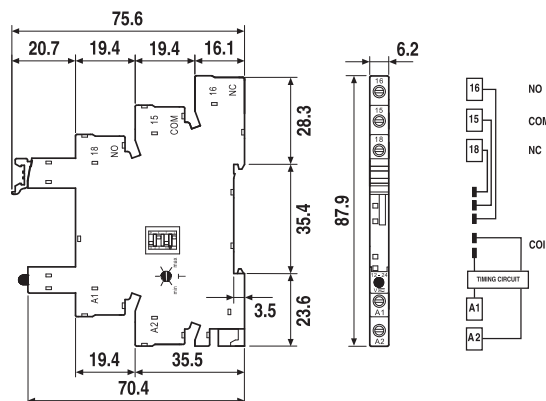

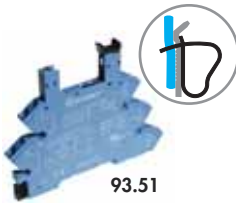

93.51

Approvals
(according to type):



UL US Certain relay/socket combinations

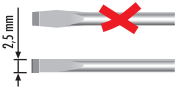

Screwless terminal socket 35 mm (EN 60715) mounting

Supply voltage	Relay type	Socket type
12 V AC/DC	34.51.7.012.xx10	93.51.0.024
24 V AC/DC	34.51.7.024.xx10	93.51.0.024
(110...125)V AC/DC	34.51.7.060.xx10 or 34.81.7.060.xxxx	93.51.0.125
(220...240)V AC/DC	34.51.7.060.xx10 or 34.81.7.060.xxxx	93.51.0.240
(110...125)V AC/DC*	34.51.7.060.xx10 or 34.81.7.060.xxxx	93.51.3.125*
(220...240)V AC*	34.51.7.060.xx10 or 34.81.7.060.xxxx	93.51.3.240*
(220...240)V AC	34.51.7.060.xx10 or 34.81.7.060.xxxx	93.51.8.240
12 V DC	34.51.7.012.xx10	93.51.7.024
24 V DC	34.51.7.024.xx10 or 34.81.7.024.xxxx	93.51.7.024
60 V DC	34.51.7.060.xx10 or 34.81.7.060.xxxx	93.51.7.060

Accessories

20-way jumper link	093.20 (see table below)
Plastic separator	093.01 (see table below)
Sheet of marker tags	093.64 (see table below)

Technical data

Rated values	6A - 250 V	
Dielectric strength	6 kV (1.2/50 μs) between coil and contacts	
Protection category	IP 20	
Ambient temperature	(-40...+70)°C (U _N ≤ 60 V), (-40...+55)°C (U _N > 60 V)	
Wire strip length	mm	10
Max. wire size for 93.51 socket	solid wire	
	mm ²	1x2.5
	AWG	1x14
	stranded wire	1x2.5
		1x14

* Leakage current suppression.

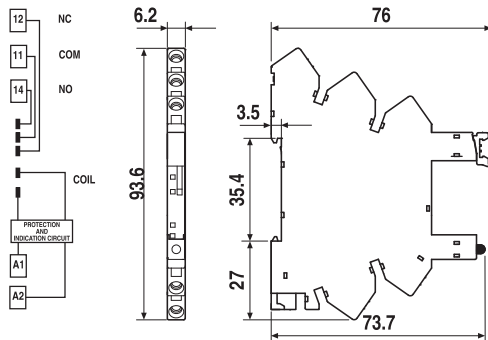

Accessories

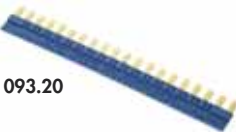

093.20

Approvals
(according to type):



20-way jumper link for 93.01 and 93.51 sockets	093.20 (blue)	093.20.0 (black)
Rated values	36 A - 250 V	

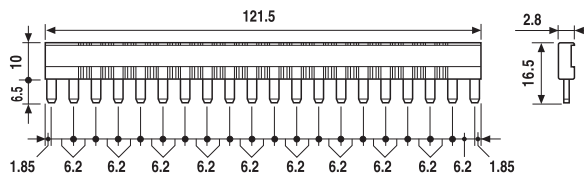

093.01

Plastic separator for 93.01 and 93.51 sockets	093.01
--	--------

Thickness 2 mm, required at the start and the end of a group of interfaces.

Can be used for visual separation of groups. Must be used for:

- protective separation of different voltages of neighbouring PLC interfaces according to VDE 0106-101
- protection of cut jumper links



093.64

Sheet of marker tags , plastic, 64 tags, 6x10 mm for 93.01 and 93.51 sockets	093.64
---	--------



93.11

Approvals
(according to type):



PCB socket with retaining and release clip	93.11 (blue)
For relay type	34.51, 34.81
Technical data	
Rated values	6 A - 250 V
Dielectric strength	≥ 6 kV (1.2/50 μ s) between coil and contacts
Protection category	IP 20
Ambient temperature	$^{\circ}\text{C}$ -40...+70

Retaining and release clip use:

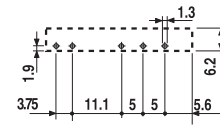
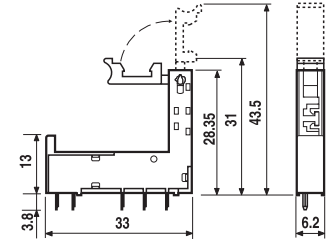
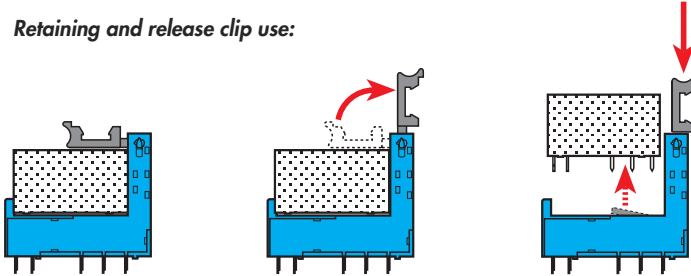

Copper side view

