

## Features

2, 3 & 4 Pole relay interface modules, 27 mm wide.

Ideal interface for PLC and electronic systems

- 58.32 - 2 Pole 10 A (screw terminals)
- 58.33 - 3 Pole 10 A (screw terminals)
- 58.34 - 4 Pole 7 A (screw terminals)

- AC coils and DC coils
- Supply status indication and coil suppression module as standard
- Identification label
- Cadmium Free contacts
- UL Listing (certain relay/socket combinations)
- 35 mm rail (EN 60715) mounting

58.32 / 58.33 / 58.34  
Screw terminals



For outline drawing see page 4

Contact specification		58.32	58.33	58.34
Contact configuration		2 CO (DPDT)	3 CO (3PDT)	4 CO (4PDT)
Rated current/Maximum peak current	A	10/20	10/20	7/15
Rated voltage/Maximum switching voltage V AC		250/400	250/400	250/250
Rated load AC1	VA	2,500	2,500	1,750
Rated load AC15 (230 V AC)	VA	500	500	350
Single phase motor rating (230 V AC)	kW	0.37	0.37	0.125
Breaking capacity DC1: 30/110/220V	A	10/0.25/0.12	10/0.25/0.12	7/0.25/0.12
Minimum switching load	mW (V/mA)	300 (5/5)	300 (5/5)	300 (5/5)
Standard contact material		AgNi	AgNi	AgNi
Coil specification		58.32	58.33	58.34
Nominal voltage (U <sub>N</sub> )	V AC (50/60 Hz)	12 - 24 - 48 - 110 - 120 - 230	12 - 24 - 48 - 110 - 120 - 230	12 - 24 - 48 - 110 - 120 - 230
	V DC	12 - 24 - 48 - 125	12 - 24 - 48 - 125	12 - 24 - 48 - 125
Rated power AC/DC	VA (50 Hz)/W	1.5/1	1.5/1	1.5/1
Operating range	AC	(0.8...1.1)U <sub>N</sub>	(0.8...1.1)U <sub>N</sub>	(0.8...1.1)U <sub>N</sub>
	DC	(0.8...1.1)U <sub>N</sub>	(0.8...1.1)U <sub>N</sub>	(0.8...1.1)U <sub>N</sub>
Holding voltage	AC/DC	0.8 U <sub>N</sub> /0.5 U <sub>N</sub>	0.8 U <sub>N</sub> /0.5 U <sub>N</sub>	0.8 U <sub>N</sub> /0.5 U <sub>N</sub>
Must drop-out voltage	AC/DC	0.2 U <sub>N</sub> /0.1 U <sub>N</sub>	0.2 U <sub>N</sub> /0.1 U <sub>N</sub>	0.2 U <sub>N</sub> /0.1 U <sub>N</sub>
Technical data		58.32	58.33	58.34
Mechanical life AC/DC	cycles	20 · 10 <sup>6</sup> /50 · 10 <sup>6</sup>	20 · 10 <sup>6</sup> /50 · 10 <sup>6</sup>	20 · 10 <sup>6</sup> /50 · 10 <sup>6</sup>
Electrical life at rated load AC1	cycles	200 · 10 <sup>3</sup>	200 · 10 <sup>3</sup>	150 · 10 <sup>3</sup>
Operate/release time	ms	9/3 (AC) - 9/15 (DC)	9/3 (AC) - 9/15 (DC)	9/3 (AC) - 9/15 (DC)
Insulation between coil and contacts (1.2/50 μs)	kV	3.6	3.6	3.6
Dielectric strength between open contacts	V AC	1,000	1,000	1,000
Ambient temperature range	°C	-40...+70	-40...+70	-40...+70
Protection category		IP 20	IP 20	IP 20

Approvals relay (according to type)



**58.32**



- 2 pole, 10 A
- Screw terminals
- 35 mm rail (EN 60715) mounting

**58.33**



- 3 pole, 10 A
- Screw terminals
- 35 mm rail (EN 60715) mounting

**58.34**



- 4 pole, 7 A
- Screw terminals
- 35 mm rail (EN 60715) mounting

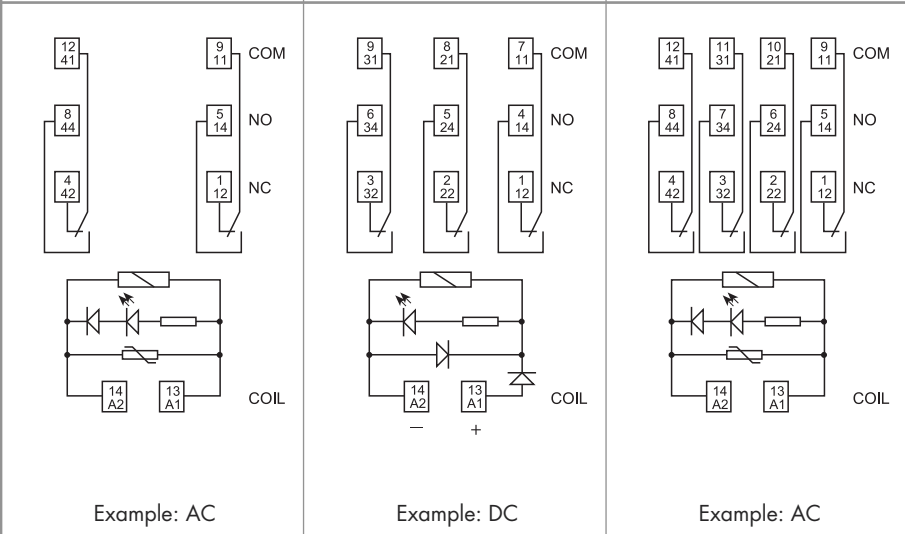

## Ordering information

Example: 58 series 35 mm rail (EN 60715) mounting, screw terminals interface module, 4 CO (4PDT), 24 V DC coil, green LED + diode.

5 8 . 3 4 . 9 . 0 2 4 . 0 0 5 0

**Series** \_\_\_\_\_

**Type** \_\_\_\_\_  
3 = Screw terminals  
35 mm rail (EN 60715) mount

**No. of poles** \_\_\_\_\_  
2 = 2 pole, 10 A  
3 = 3 pole, 10 A  
4 = 4 pole, 7 A

**Coil version** \_\_\_\_\_  
8 = AC (50/60 Hz)  
9 = DC

**Coil voltage** \_\_\_\_\_  
See coil specifications

**A: Contact material**  
0 = AgNi Standard  
2 = AgCdO  
5 = AgNi + Au (5 µm)

**B: Contact circuit**  
0 = CO (nPDT)

**D: Special versions**  
0 = Standard

**C: Options**  
5 = Standard DC: green LED + diode  
(polarity +A1)  
6 = Standard AC: green LED + Varistor

**Selecting features and options: only combinations in the same row are possible.**  
Preferred selections for best availability are shown in **bold**.

Type	Coil version	A	B	C	D
58.32/33/34	AC	<b>0</b> - 2 - 5	0	<b>6</b>	0
58.32/33/34	DC	<b>0</b> - 2 - 5	0	<b>5</b>	0

## Technical data

Insulation			
Insulation according to EN 61810-1	insulation rated voltage	V	400 (2-3 pole)   250 (4 pole)
	rated impulse withstand voltage	kV	3.6 (2-3 pole)   2.5 (4 pole)
	pollution degree		2   2
	overvoltage category		III   II
Insulation between coil and contacts (1.2/50 µs)		kV	3.6
Dielectric strength between open contacts		V AC	1,000
Dielectric strength between adjacent contacts		V AC	2,000 (58.32, 58.33)   1,550 (58.34)
Conducted disturbance immunity			
Burst (5...50)ns, 5 kHz, on A1 - A2			EN 61000-4-4   level 4 (4 kV)
Surge (1.2/50 µs) on A1 - A2 (differential mode)			EN 61000-4-5   level 4 (4 kV)
Other data			
Bounce time: NO/NC		ms	1/4
Vibration resistance (10...55)Hz: NO/NC		g	6/6
Power lost to the environment	without contact current	W	1
	with rated current	W	3 (58.32, 58.34)   4 (58.33)
Wire strip length		mm	8
Screw torque		Nm	0.5
Max. wire size			solid cable   stranded cable
	mm <sup>2</sup>		1x6 / 2x2.5   1x4 / 2x2.5
	AWG		1x10 / 2x14   1x12 / 2x14

## Contact specification

**F 58 - Electrical life (AC) v contact current**  
2 & 3 pole relays

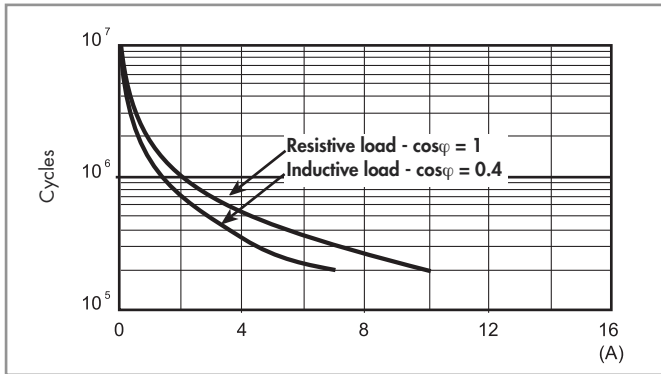

**F 58 - Electrical life (AC) v contact current**  
4 pole relay

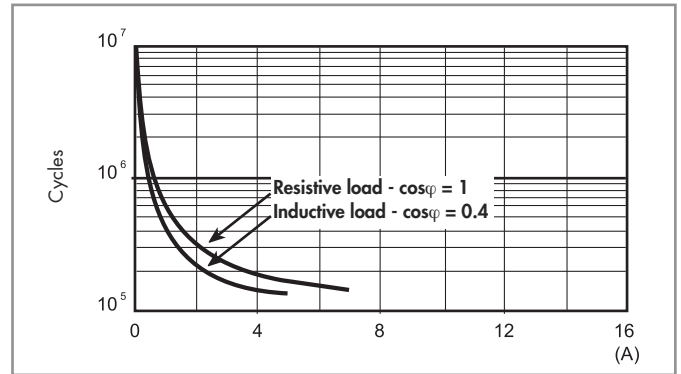

**H 58 - Maximum DC1 breaking capacity**

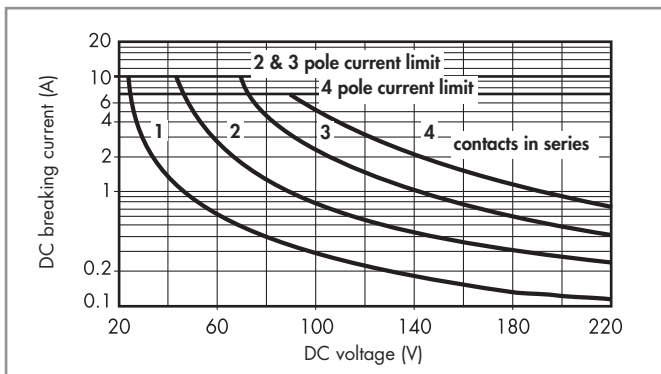

- When switching a resistive load (DC1) having voltage and current values under the curve, an electrical life of  $\geq 100 \cdot 10^3$  can be expected.
- In the case of DC13 loads, the connection of a diode in parallel with the load will permit a similar electrical life as for a DC1 load. Note: the release time for the load will be increased.

## Coil specifications

**DC coil data**

Nominal voltage $U_N$ V	Coil code	Operating range		Resistance R $\Omega$	Rated coil absorption I at $U_N$ mA
		$U_{min}$ V	$U_{max}$ V		
12	9.012	9.6	13.2	140	86
24	9.024	19.2	26.4	600	40
48	9.048	38.4	52.8	2,400	20
125	9.125	100	138	17,300	7.2

**AC coil data**

Nominal voltage $U_N$ V	Coil code	Operating range		Resistance R $\Omega$	Rated coil absorption I at $U_N$ (50Hz) mA
		$U_{min}$ V	$U_{max}$ V		
12	8.012	9.6	13.2	50	97
24	8.024	19.2	26.4	190	53
48	8.048	38.4	52.8	770	25
110	8.110	88	121	4,000	12.5
120	8.120	96	132	4,700	12
230	8.230	184	253	17,000	6

**R 58 - DC coil operating range v ambient temperature**

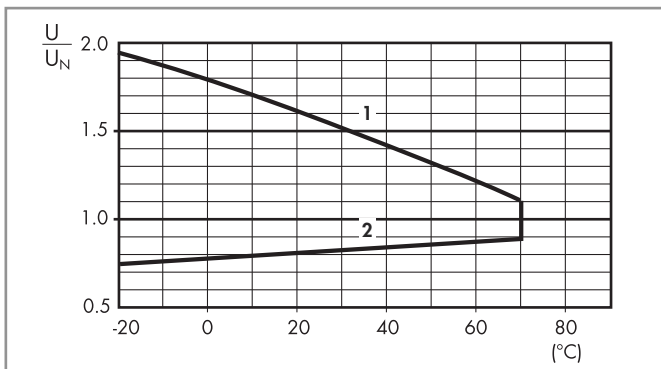

- 1 - Max. permitted coil voltage.  
2 - Min. pick-up voltage with coil at ambient temperature.

**R 58 - AC coil operating range v ambient temperature**

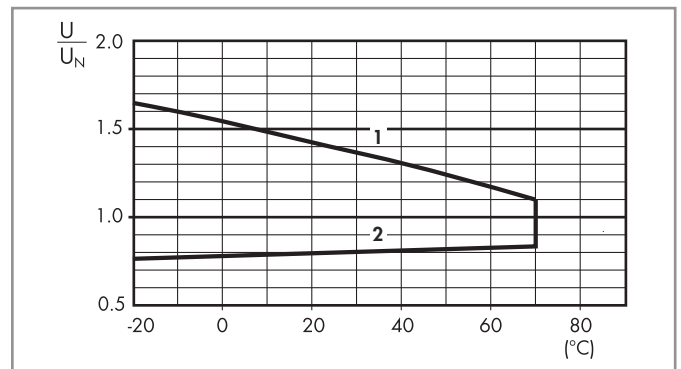

- 1 - Max. permitted coil voltage.  
2 - Min. pick-up voltage with coil at ambient temperature.

## Combinations

Certain relay/socket combinations

Code	Type of socket	Type of relay	Module	Retaining clip
58.32	94.02	55.32	99.02	094.91.3
58.33	94.03	55.33	99.02	094.91.3
58.34	94.04	55.34	99.02	094.91.3

## Outline drawing

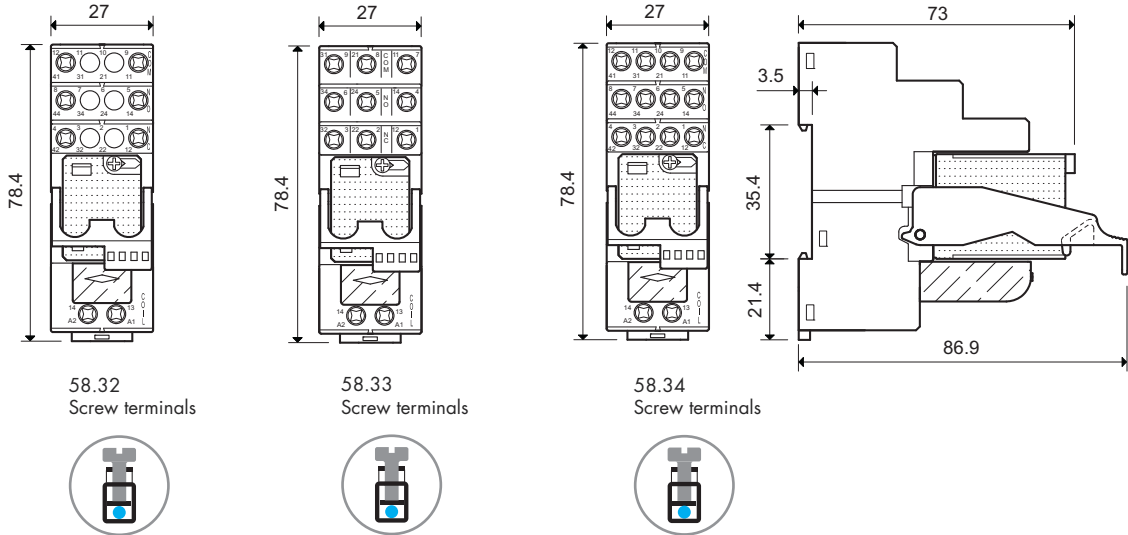

## Accessories

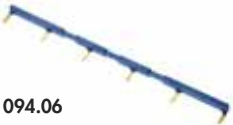

094.06

<b>6-way jumper link</b>	094.06 (blue)	094.06.0 (black)
Rated values	10 A - 250 V	

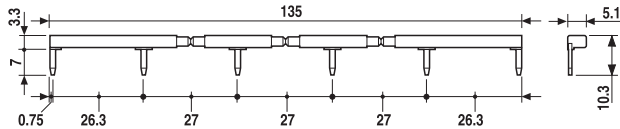

060.72

<b>Sheet of marker tags, plastic, 72 tags, 6x12 mm</b>	060.72
--	--------

## Packaging codes

How to code and identify retaining clip and packaging options for sockets.

Example:

**5 8 . 3 4 . 9 . 0 2 4 . 0 0 5 0 S P A**

- A** Standard packaging
- B** Blister packaging
- SP** Plastic retaining clip