

Power MOSFET

PRODUCT SUMMARY		
V_{DS} (V)	- 60	
$R_{DS(on)}$ (Ω)	$V_{GS} = - 10$ V	0.28
Q_g (Max.) (nC)	19	
Q_{gs} (nC)	5.4	
Q_{gd} (nC)	11	
Configuration	Single	

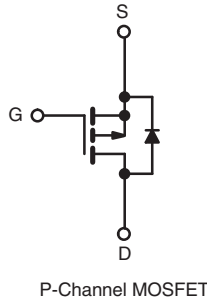
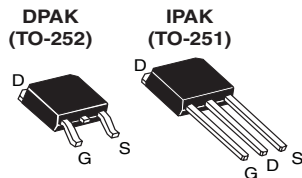

FEATURES

- Halogen-free According to IEC 61249-2-21 Definition
- Dynamic dV/dt Rating
- Repetitive Avalanche Rated
- Surface Mount (IRFR9024, SiHFR9024)
- Straight Lead (IRFU9024, SiHFU9024)
- Available in Tape and Reel
- P-Channel
- Fast Switching
- Compliant to RoHS Directive 2002/95/EC



DESCRIPTION

Third generation Power MOSFETs from Vishay provide the designer with the best combination of fast switching, ruggedized device design, low on-resistance and cost-effectiveness.

The DPAK is designed for surface mounting using vapor phase, infrared, or wave soldering techniques. The straight lead version (IRFU, SiHFU series) is for through-hole mounting applications. Power dissipation levels up to 1.5 W are possible in typical surface mount applications.

ORDERING INFORMATION					
Package	DPAK (TO-252)	DPAK (TO-252)	DPAK (TO-252)	DPAK (TO-252)	IPAK (TO-251)
Lead (Pb)-free and Halogen-free	SiHFR9024-GE3	SiHFR9024TR-GE3 ^a	SiHFR9024TRL-GE3 ^a	SiHFR9024TRR-GE3 ^a	SiHFU9024-GE3
Lead (Pb)-free	IRFR9024PbF	IRFR9024TRPbF ^a	IRFR9024TRLPbF ^a	IRFR9024TRRPbF ^a	IRFU9024PbF
	SiHFR9024-E3	SiHFR9024T-E3 ^a	SiHFR9024TL-E3 ^a	SiHFR9024TR-E3 ^a	SiHFU9024-E3
SnPb	IRFR9024	IRFR9024TR ^a	IRFR9024TRL ^a	-	IRFU9024
	SiHFR9024	SiHFR9024T ^a	SiHFR9024TL ^a	-	SiHFU9024

Note

- a. See device orientation.

ABSOLUTE MAXIMUM RATINGS $T_C = 25^\circ\text{C}$, unless otherwise noted				
PARAMETER	SYMBOL		LIMIT	UNIT
Drain-Source Voltage	V_{DS}		- 60	V
Gate-Source Voltage	V_{GS}		± 20	
Continuous Drain Current	V_{GS} at - 10 V	$T_C = 25^\circ\text{C}$	- 8.8	A
		$T_C = 100^\circ\text{C}$	- 5.6	
Pulsed Drain Current ^a	I_{DM}		- 35	W/ $^\circ\text{C}$
Linear Derating Factor			0.33	
Linear Derating Factor (PCB Mount) ^e			0.020	
Single Pulse Avalanche Energy ^b	E_{AS}		300	mJ
Repetitive Avalanche Current ^a	I_{AR}		- 8.8	A
Repetitive Avalanche Energy ^a	E_{AR}		5.0	mJ
Maximum Power Dissipation	$T_C = 25^\circ\text{C}$		42	W
Maximum Power Dissipation (PCB Mount) ^e	$T_A = 25^\circ\text{C}$		2.5	
Peak Diode Recovery dV/dt ^c	dV/dt		- 4.5	V/ns
Operating Junction and Storage Temperature Range	T_J, T_{stg}		- 55 to + 150	$^\circ\text{C}$
Soldering Recommendations (Peak Temperature)	for 10 s		260 ^d	

Notes



- Repetitive rating; pulse width limited by maximum junction temperature (see fig. 11).
- $V_{DD} = - 25$ V, starting $T_J = 25^\circ\text{C}$, $L = 4.5$ mH, $R_g = 25 \Omega$, $I_{AS} = - 8.8$ A (see fig. 12).
- $I_{SD} \leq - 11$ A, $dI/dt \leq 140$ A/ μs , $V_{DD} \leq V_{DS}$, $T_J \leq 150^\circ\text{C}$.
- 1.6 mm from case.
- When mounted on 1" square PCB (FR-4 or G-10 material).

* Pb containing terminations are not RoHS compliant, exemptions may apply

THERMAL RESISTANCE RATINGS						
PARAMETER	SYMBOL	MIN.	TYP.	MAX.	UNIT	
Maximum Junction-to-Ambient	R_{thJA}	-	-	110	°C/W	
Maximum Junction-to-Ambient (PCB Mount) ^a	R_{thJA}	-	-	50		
Maximum Junction-to-Case (Drain)	R_{thJC}	-	-	3.0		

Note

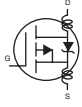
a. When mounted on 1" square PCB (FR-4 or G-10 material).

SPECIFICATIONS $T_J = 25\text{ }^\circ\text{C}$, unless otherwise noted							
PARAMETER	SYMBOL	TEST CONDITIONS		MIN.	TYP.	MAX. UNIT	
Static							
Drain-Source Breakdown Voltage	V_{DS}	$V_{GS} = 0\text{ V}, I_D = 250\text{ }\mu\text{A}$		- 60	-	- V	
V_{DS} Temperature Coefficient	$\Delta V_{DS}/T_J$	Reference to $25\text{ }^\circ\text{C}$, $I_D = 1\text{ mA}$		-	- 0.063	- $V/^\circ\text{C}$	
Gate-Source Threshold Voltage	$V_{GS(th)}$	$V_{DS} = V_{GS}, I_D = 250\text{ }\mu\text{A}$		- 2.0	-	- 4.0 V	
Gate-Source Leakage	I_{GSS}	$V_{GS} = \pm 20\text{ V}$		-	-	$\pm 100\text{ nA}$	
Zero Gate Voltage Drain Current	I_{DSS}	$V_{DS} = - 60\text{ V}, V_{GS} = 0\text{ V}$		-	-	- 100 μA	
		$V_{DS} = - 48\text{ V}, V_{GS} = 0\text{ V}, T_J = 125\text{ }^\circ\text{C}$		-	-	- 500 μA	
Drain-Source On-State Resistance	$R_{DS(on)}$	$V_{GS} = - 10\text{ V}$	$I_D = - 5.3\text{ A}^b$	-	-	0.28 Ω	
Forward Transconductance	g_{fs}	$V_{DS} = - 25\text{ V}, I_D = - 5.3\text{ A}$		2.9	-	- S	
Dynamic							
Input Capacitance	C_{iss}	$V_{GS} = 0\text{ V}, V_{DS} = - 25\text{ V}, f = 1.0\text{ MHz}$		-	570	-	
Output Capacitance	C_{oss}			-	360	-	pF
Reverse Transfer Capacitance	C_{rss}			-	65	-	
Total Gate Charge	Q_g	$V_{GS} = - 10\text{ V}$	$I_D = - 11\text{ A}, V_{DS} = - 48\text{ V},$ see fig. 6 and 13 ^b	-	-	19	
Gate-Source Charge	Q_{gs}			-	-	5.4	nC
Gate-Drain Charge	Q_{gd}			-	-	11	
Turn-On Delay Time	$t_{d(on)}$	$V_{DD} = - 30\text{ V}, I_D = - 11\text{ A}, R_g = 18\text{ }\Omega, R_D = 2.5\text{ }\Omega,$ see fig. 10 ^b		-	13	-	
Rise Time	t_r			-	68	-	ns
Turn-Off Delay Time	$t_{d(off)}$			-	15	-	
Fall Time	t_f			-	29	-	
Internal Drain Inductance	L_D	Between lead, 6 mm (0.25") from package and center of die contact 		-	4.5	-	
Internal Source Inductance	L_S			-	7.5	-	nH
Drain-Source Body Diode Characteristics							
Continuous Source-Drain Diode Current	I_S	MOSFET symbol showing the integral reverse p - n junction diode 		-	-	- 8.8	
Pulsed Diode Forward Current ^a	I_{SM}			-	-	- 35	A
Body Diode Voltage	V_{SD}	$T_J = 25\text{ }^\circ\text{C}, I_S = - 8.8\text{ A}, V_{GS} = 0\text{ V}^b$		-	-	- 6.3 V	
Body Diode Reverse Recovery Time	t_{rr}	$T_J = 25\text{ }^\circ\text{C}, I_F = - 11\text{ A}, di/dt = 100\text{ A}/\mu\text{s}^b$		-	100	200 ns	
Body Diode Reverse Recovery Charge	Q_{rr}			-	0.32	0.64 μC	
Forward Turn-On Time	t_{on}	Intrinsic turn-on time is negligible (turn-on is dominated by L_S and L_D)					

Notes

- a. Repetitive rating; pulse width limited by maximum junction temperature (see fig. 11).
- b. Pulse width $\leq 300\text{ }\mu\text{s}$; duty cycle $\leq 2\%$.

TYPICAL CHARACTERISTICS 25 °C, unless otherwise noted

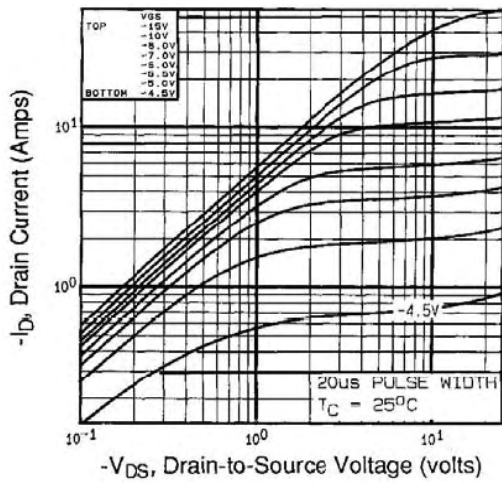

Fig. 1 - Typical Output Characteristics, $T_C = 25^\circ\text{C}$

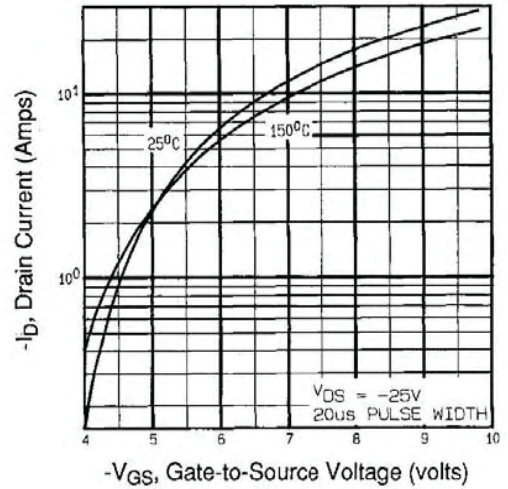

Fig. 3 - Typical Transfer Characteristics

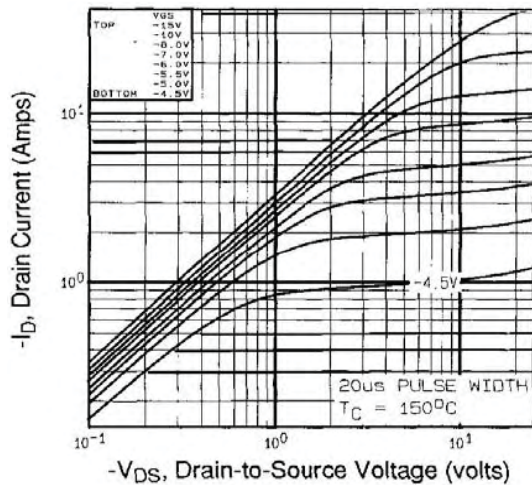

Fig. 2 - Typical Output Characteristics, $T_C = 150^\circ\text{C}$

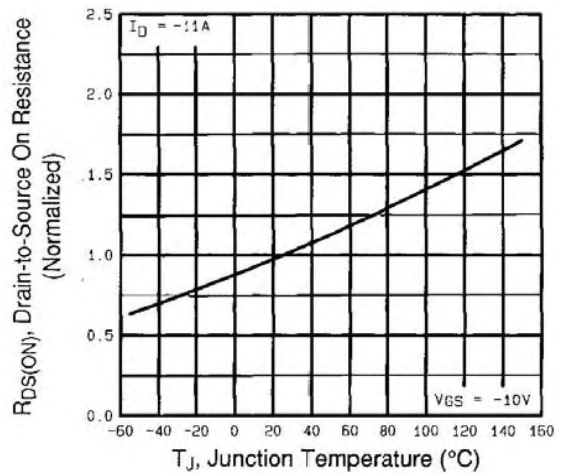

Fig. 4 - Normalized On-Resistance vs. Temperature

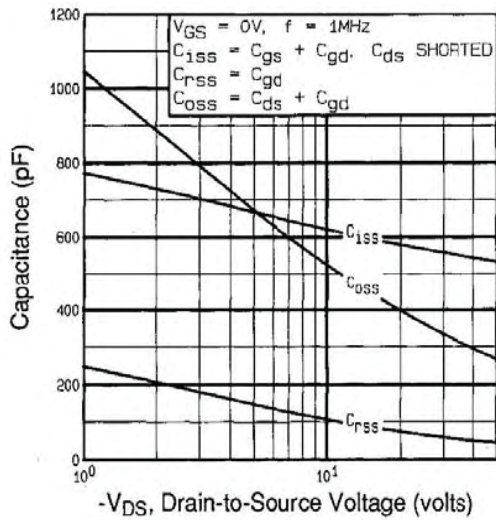

Fig. 5 - Typical Capacitance vs. Drain-to-Source Voltage

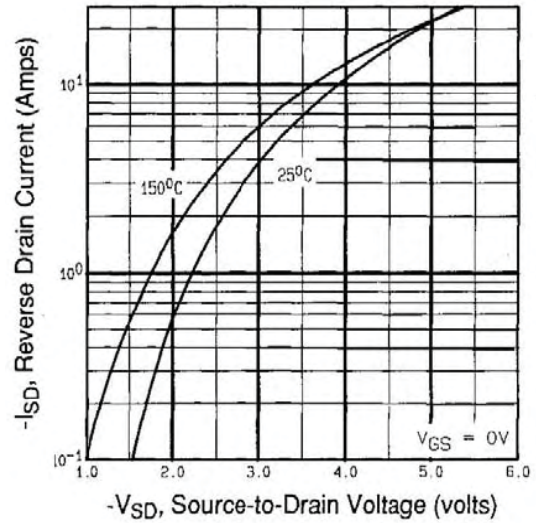

Fig. 7 - Typical Source-Drain Diode Forward Voltage

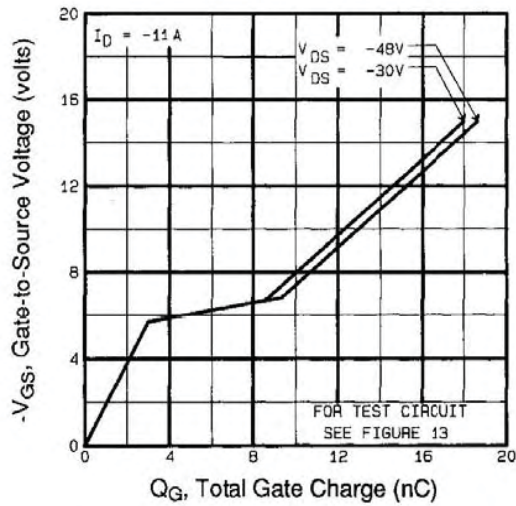

Fig. 6 - Typical Gate Charge vs. Gate-to-Source Voltage

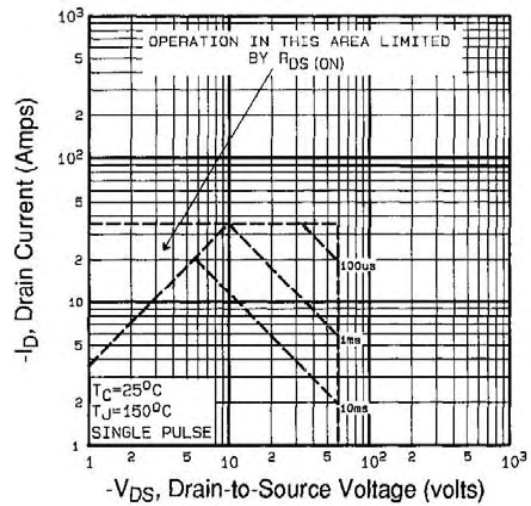

Fig. 8 - Maximum Safe Operating Area

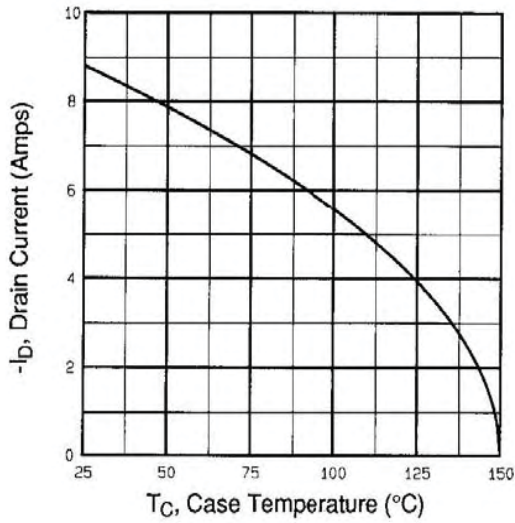

Fig. 9 - Maximum Drain Current vs. Case Temperature

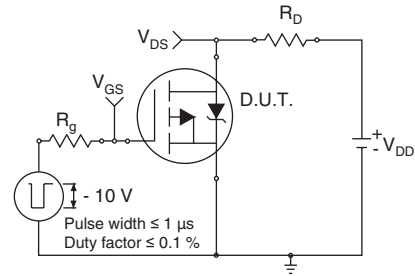

Fig. 10a - Switching Time Test Circuit

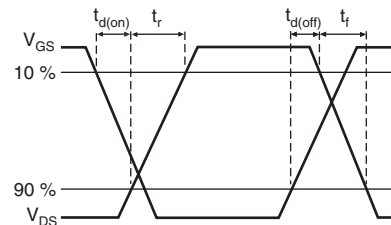

Fig. 10b - Switching Time Waveforms

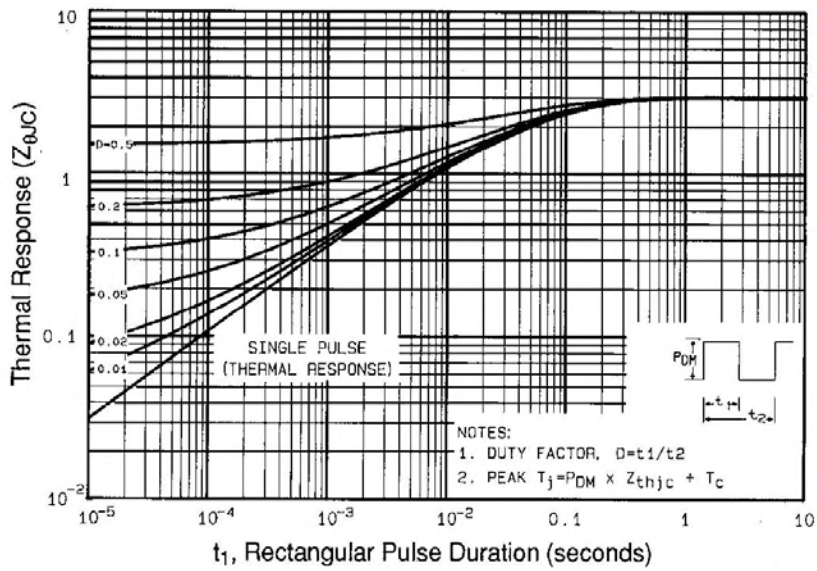

Fig. 11 - Maximum Effective Transient Thermal Impedance, Junction-to-Case

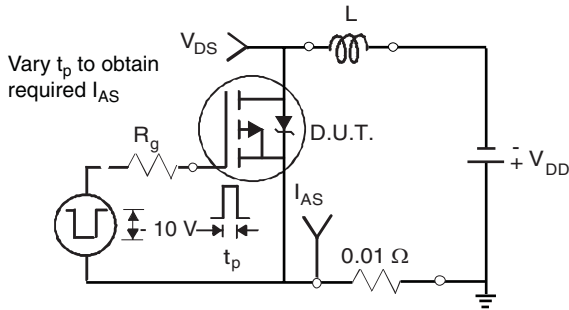

Fig. 12a - Unclamped Inductive Test Circuit

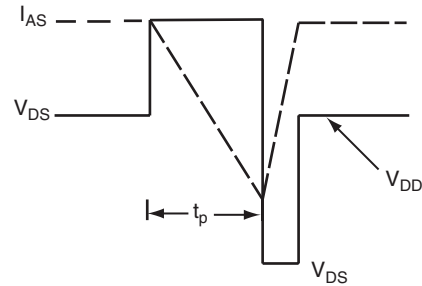

Fig. 12b - Unclamped Inductive Waveforms

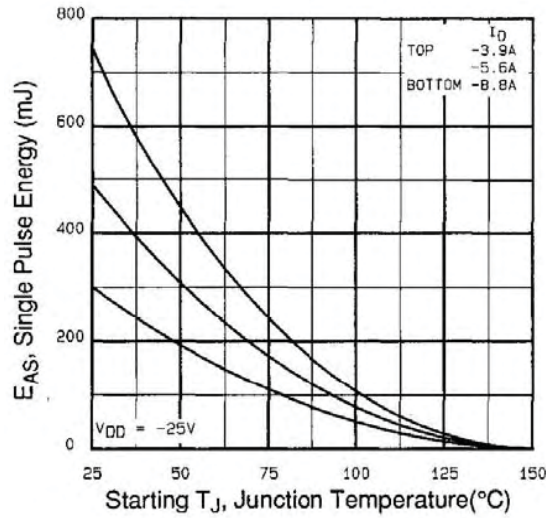

Fig. 12c - Maximum Avalanche Energy vs. Drain Current

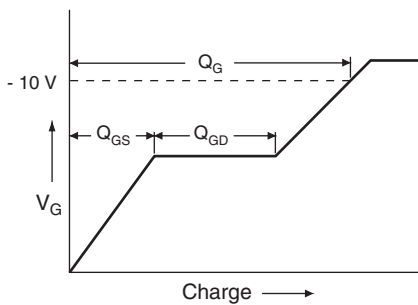

Fig. 13a - Basic Gate Charge Waveform

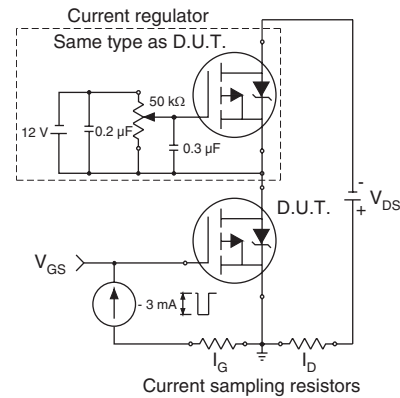

Fig. 13b - Gate Charge Test Circuit

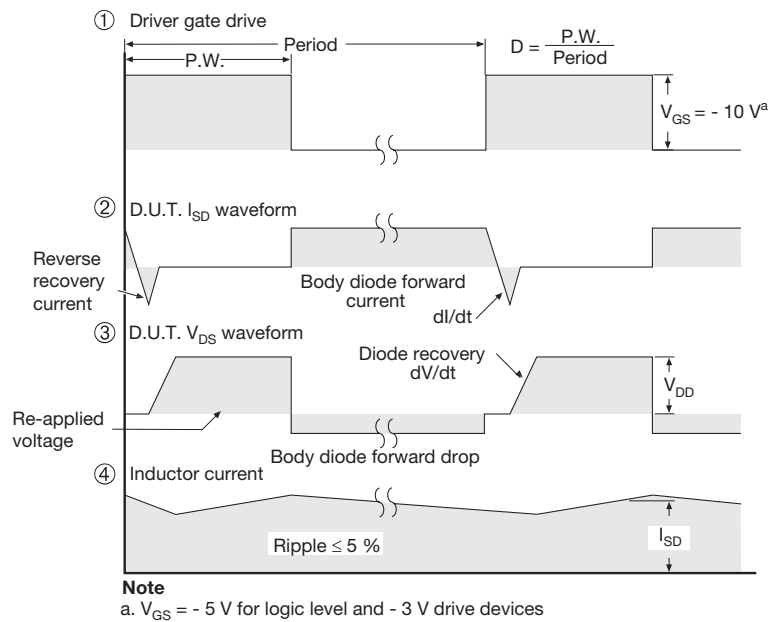
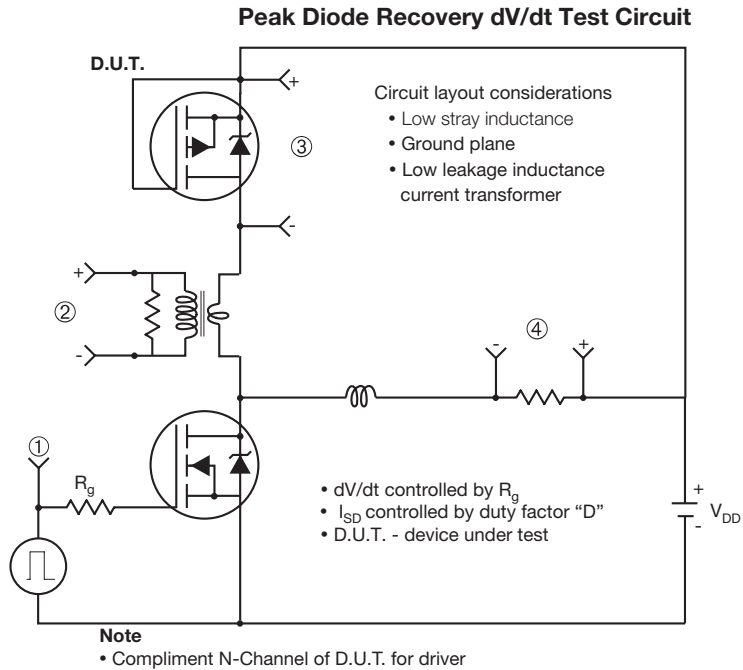

Fig. 14 - For P-Channel

Vishay Siliconix maintains worldwide manufacturing capability. Products may be manufactured at one of several qualified locations. Reliability data for Silicon Technology and Package Reliability represent a composite of all qualified locations. For related documents such as package/tape drawings, part marking, and reliability data, see www.vishay.com/ppg?91278.



Disclaimer

All product specifications and data are subject to change without notice.

Vishay Intertechnology, Inc., its affiliates, agents, and employees, and all persons acting on its or their behalf (collectively, "Vishay"), disclaim any and all liability for any errors, inaccuracies or incompleteness contained herein or in any other disclosure relating to any product.

Vishay disclaims any and all liability arising out of the use or application of any product described herein or of any information provided herein to the maximum extent permitted by law. The product specifications do not expand or otherwise modify Vishay's terms and conditions of purchase, including but not limited to the warranty expressed therein, which apply to these products.

No license, express or implied, by estoppel or otherwise, to any intellectual property rights is granted by this document or by any conduct of Vishay.

The products shown herein are not designed for use in medical, life-saving, or life-sustaining applications unless otherwise expressly indicated. Customers using or selling Vishay products not expressly indicated for use in such applications do so entirely at their own risk and agree to fully indemnify Vishay for any damages arising or resulting from such use or sale. Please contact authorized Vishay personnel to obtain written terms and conditions regarding products designed for such applications.

Product names and markings noted herein may be trademarks of their respective owners.