

# SK 120 KQ



SEMITOP® 2

## Antiparallel Thyristor Module

### SK 120 KQ

Preliminary Data

#### Features

- Compact Design
- One screw mounting
- Heat transfer and isolation through direct copper bonded aluminium oxide ceramic (DBC)
- Glass passivated thyristor chips
- Up to 1600V reverse voltage
- UL recognized, file no. E 63 532

#### Typical Applications

- Soft starters
- Light control (studios, theaters...)
- Temperature control

$V_{RSM}$ V	$V_{RRM}, V_{DRM}$ V	$I_{RMS} = 134 \text{ A (full conduction)}$ ( $T_s = 85^\circ \text{C}$ )
900	800	SK 100 KQ 08
1300	1200	SK 100 KQ 12
1700	1600	SK 100 KQ 16

Symbol	Conditions	Values	Units
$I_{RMS}$	W1C ; sin. $180^\circ$ ; $T_s = 100^\circ \text{C}$	94	A
	W1C ; sin. $180^\circ$ ; $T_s = 85^\circ \text{C}$	134	A
$I_{TSM}$	$T_{vj} = 25^\circ \text{C}$ ; 10 ms	2000	A
	$T_{vj} = 125^\circ \text{C}$ ; 10 ms	1800	A
$i^2t$	$T_{vj} = 25^\circ \text{C}$ ; 8,3...10 ms	20000	A <sup>2</sup> s
	$T_{vj} = 125^\circ \text{C}$ ; 8,3...10 ms	16200	A <sup>2</sup> s
$V_T$	$T_{vj} = 25^\circ \text{C}$ , $I_T = 300 \text{ A}$	max. 1,85	V
$V_{T(TO)}$	$T_{vj} = 125^\circ \text{C}$	max. 0,9	V
$r_T$	$T_{vj} = 125^\circ \text{C}$	max. 3,5	m $\Omega$
$I_{DD}, I_{RD}$	$T_{vj} = 25^\circ \text{C}$ , $V_{RD} = V_{RRM}$	max. 1	mA
	$T_{vj} = 125^\circ \text{C}$ , $V_{RD} = V_{RRM}$	max. 20	mA
$t_{gd}$	$T_{vj} = 25^\circ \text{C}$ , $I_G = 1 \text{ A}$ ; $di_G/dt = 1 \text{ A}/\mu\text{s}$	1	$\mu\text{s}$
$t_{gr}$	$V_D = 0,67 * V_{DRM}$	2	$\mu\text{s}$
$(dv/dt)_{cr}$	$T_{vj} = 125^\circ \text{C}$	1000	V/ $\mu\text{s}$
$(di/dt)_{cr}$	$T_{vj} = 125^\circ \text{C}$ ; $f = 50...60 \text{ Hz}$	100	A/ $\mu\text{s}$
$t_q$	$T_{vj} = 125^\circ \text{C}$ ; typ.	80	$\mu\text{s}$
$I_H$	$T_{vj} = 25^\circ \text{C}$ ; typ. / max.	100 / 200	mA
$I_L$	$T_{vj} = 25^\circ \text{C}$ ; $R_G = 33 \Omega$ ; typ. / max.	200 / 500	mA
$V_{GT}$	$T_{vj} = 25^\circ \text{C}$ ; d.c.	min. 2	V
$I_{GT}$	$T_{vj} = 25^\circ \text{C}$ ; d.c.	min. 100	mA
$V_{GD}$	$T_{vj} = 125^\circ \text{C}$ ; d.c.	max. 0,25	V
$I_{GD}$	$T_{vj} = 125^\circ \text{C}$ ; d.c.	max. 5	mA
$R_{th(j-s)}$	cont. per thyristor	0,45	K/W
	sin $180^\circ$ per thyristor	0,47	K/W
$R_{th(j-s)}$	cont. per W1C	0,225	K/W
	sin $180^\circ$ per W1C	0,235	K/W
$T_{vj}$		-40 ... +125	$^\circ \text{C}$
$T_{stg}$		-40 ... +125	$^\circ \text{C}$
$T_{solder}$	terminals, 10s	260	$^\circ \text{C}$
$V_{isol}$	a. c. 50 Hz ; r.m.s. ; 1 s / 1 min.	3000 / 2500	V~
$M_s$	Mounting torque to heatsink	2,0	Nm
$M_t$			Nm
$a$			m/s <sup>2</sup>
$m$		19	g
Case	SEMITOP® 2	T 2	

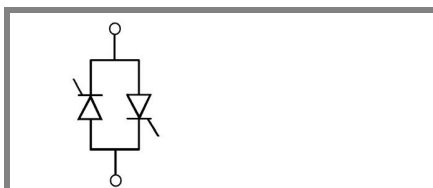

KQ

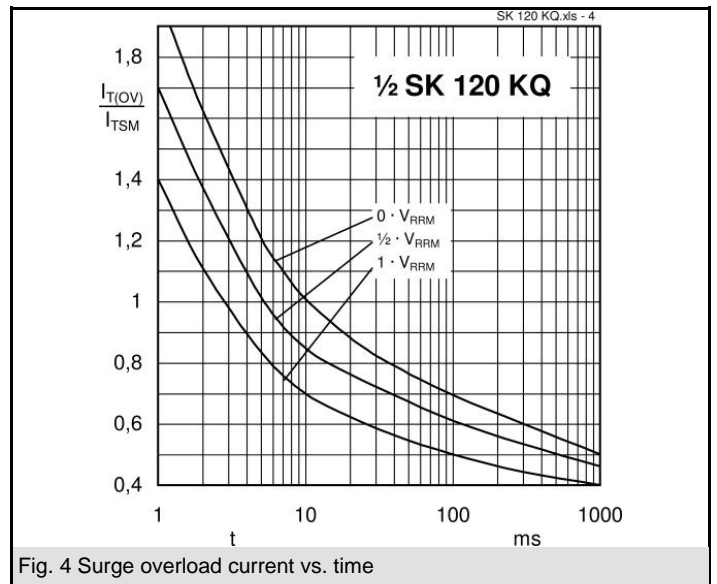
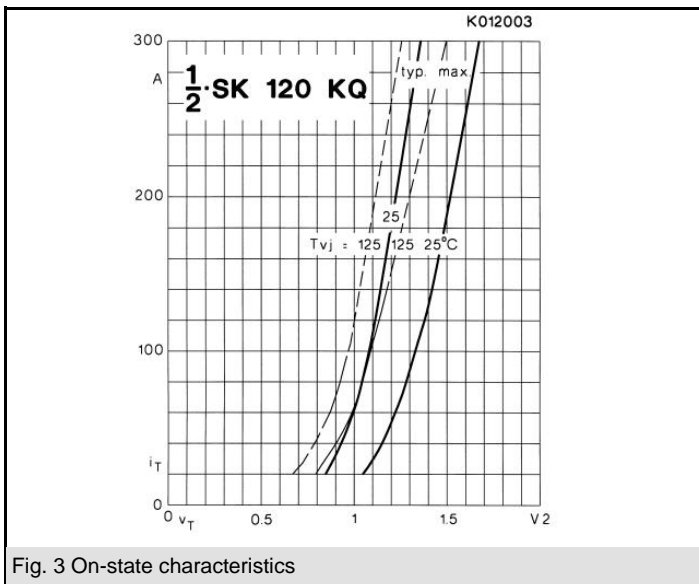
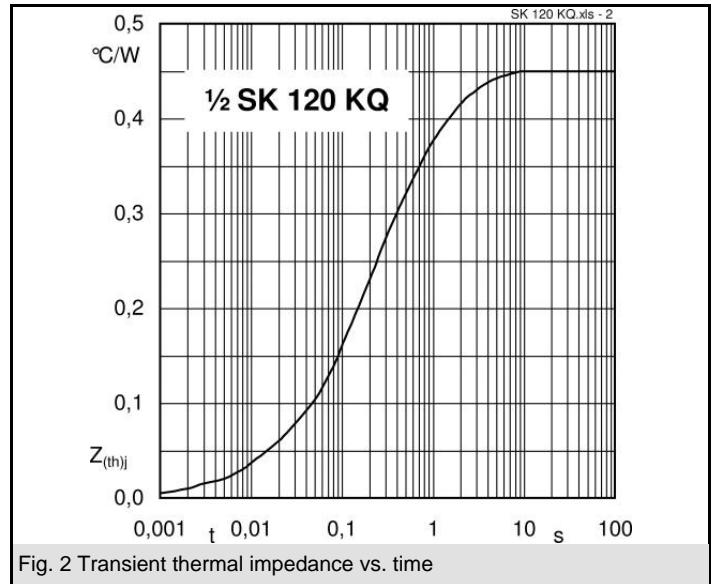
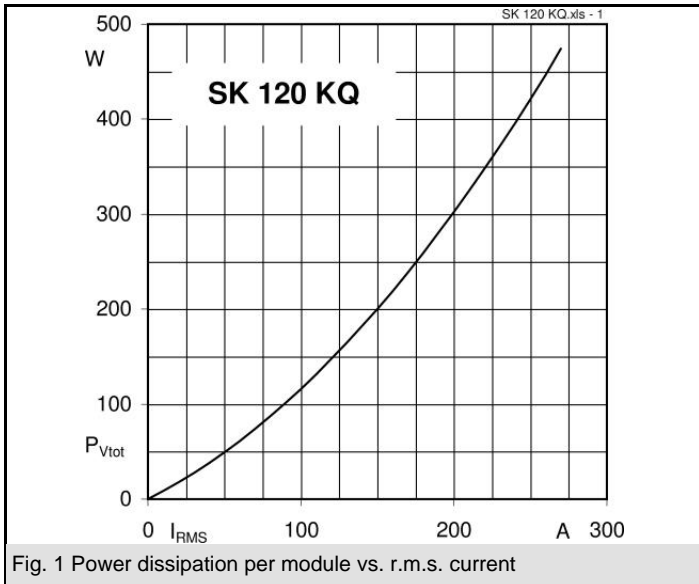

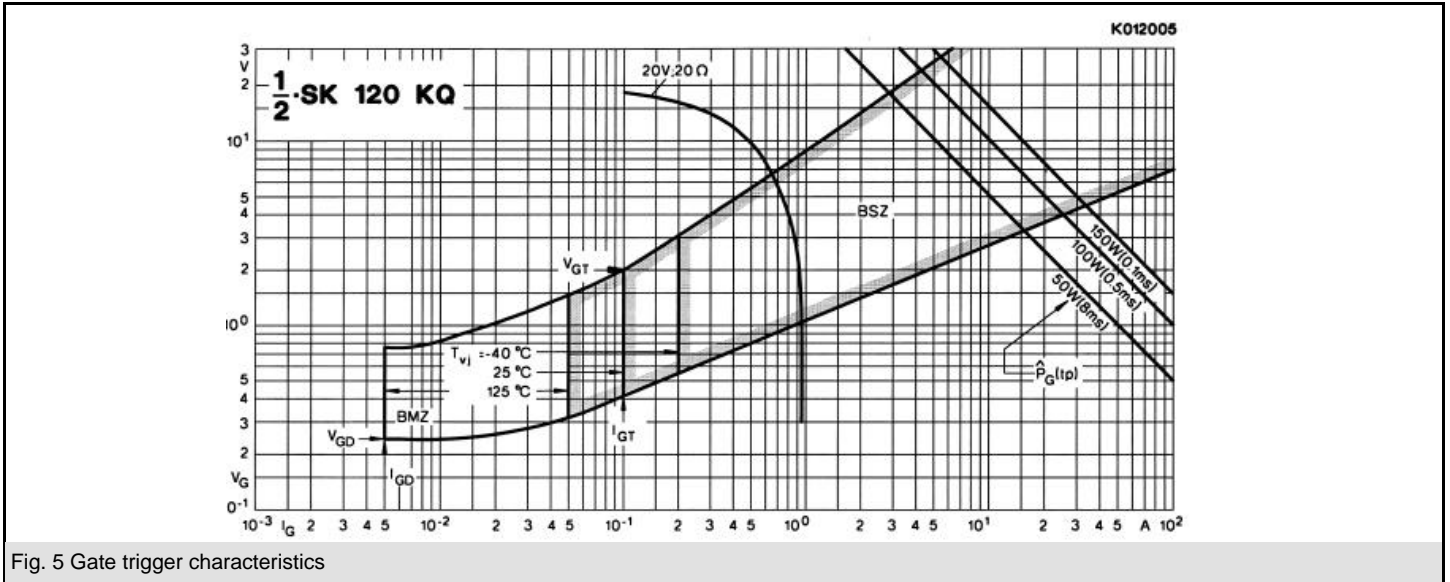
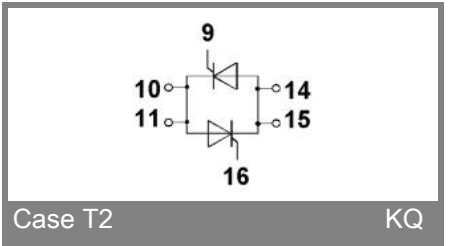
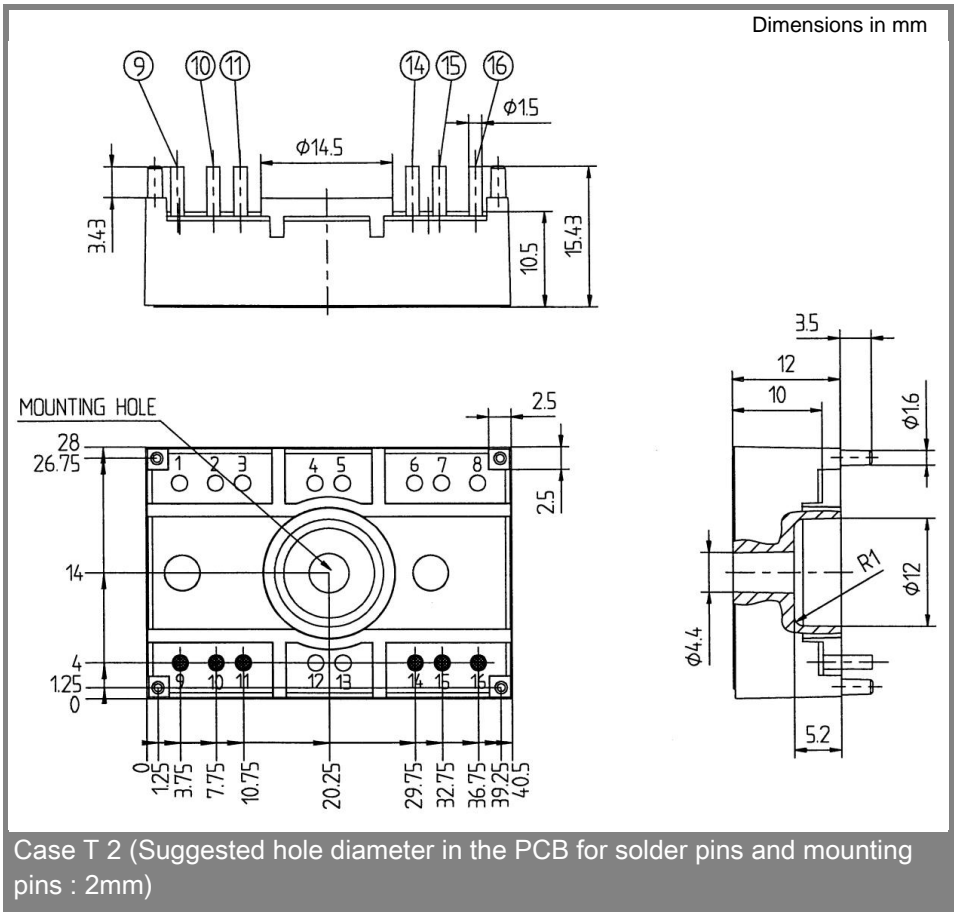

Fig. 5 Gate trigger characteristics



Case T2

KQ

Case T 2 (Suggested hole diameter in the PCB for solder pins and mounting pins : 2mm)

This technical information specifies semiconductor devices but promises no characteristics. No warranty or guarantee expressed or implied is made regarding delivery, performance or suitability.