

SEMITOR[®] 2

IGBT Module

SK 45 GB 063

SK 45 GAL 063

SK 45 GAR 063

Preliminary Data

Features

- Compact design
- One screw mounting
- Heat transfer and isolation through direct copper bonded aluminium oxide ceramic (DCB)
- N channel, homogeneous Silicon structure (NPT-Non punchthrough IGBT)
- High short circuit capability
- Low tail current with low temperature dependence
- UL recognized, file no. E 63532

Typical Applications

- Switching (not for linear use)
- Inverter
- Switched mode power supplies
- UPS

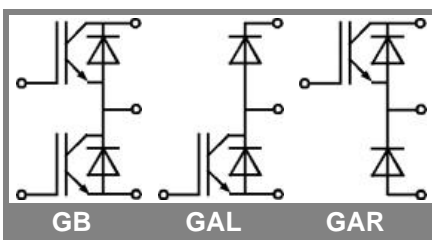

Absolute Maximum Ratings		$T_s = 25\text{ °C}$, unless otherwise specified	
Symbol	Conditions	Values	Units
IGBT			
V_{CES}		600	V
V_{GES}		± 20	V
I_C	$T_s = 25\text{ (80) °C}$;	45 (30)	A
I_{CM}	$t_p < 1\text{ ms}$; $T_s = 25\text{ (80) °C}$;	90 (60)	A
T_j		- 40 ... + 150	°C
Inverse/Freewheeling CAL diode			
I_F	$T_s = 25\text{ (80) °C}$;	57 (38)	A
$I_{FM} = -I_{CM}$	$t_p < 1\text{ ms}$; $T_s = 25\text{ (80) °C}$;	114 (76)	A
T_j		- 40 ... + 150	°C
T_{stg}		- 40 ... + 125	°C
T_{sol}	Terminals, 10 s	260	°C
V_{isol}	AC 50 Hz, r.m.s. 1 min. / 1 s	2500 / 3000	V

Characteristics		$T_s = 25\text{ °C}$, unless otherwise specified			
Symbol	Conditions	min.	typ.	max.	Units
IGBT					
$V_{CE(sat)}$	$I_C = 30\text{ A}$, $T_j = 25\text{ (125) °C}$		1,8 (2)	2,1 (2,3)	V
$V_{GE(th)}$	$V_{CE} = V_{GE}$; $I_C = 0,001\text{ A}$	4,5	5,5	6,5	V
C_{res}	$V_{CE} = 25\text{ V}$; $V_{GE} = 0\text{ V}$; 1 MHz		2,8		nF
$R_{th(j-s)}$	per IGBT			1	K/W
	per module				K/W
$t_{d(on)}$	under following conditions: $V_{CC} = 300\text{ V}$, $V_{GE} = \pm 15\text{ V}$		45		ns
t_r	$I_C = 30\text{ A}$, $T_j = 125\text{ °C}$		35		ns
$t_{d(off)}$	$R_{Gon} = R_{Goff} = 22\ \Omega$		250		ns
t_f			25		ns
$E_{on} + E_{off}$	Inductive load		2,65		mJ
Inverse/Freewheeling CAL diode					
$V_F = V_{EC}$	$I_F = 30\text{ A}$; $T_j = 25\text{ (125) °C}$		1,3 (1,2)	1,5 (1,45)	V
$V_{(TO)}$	$T_j = (125)\text{ °C}$		(0,85)	(0,9)	V
r_T	$T_j = (125)\text{ °C}$		(9)	(16)	mΩ
$R_{th(j-s)}$				1,2	K/W
I_{RRM}	under following conditions: $I_F = 30\text{ A}$; $V_R = 300\text{ V}$		22		A
Q_{rr}	$di_F/dt = -500\text{ A}/\mu\text{s}$		2,2		μC
E_{off}	$V_{GE} = 0\text{ V}$; $T_j = 125\text{ °C}$		0,2		mJ
Mechanical data					
M1	mounting torque			2	Nm
w			19		g
Case	SEMITOR [®] 2		T 4		

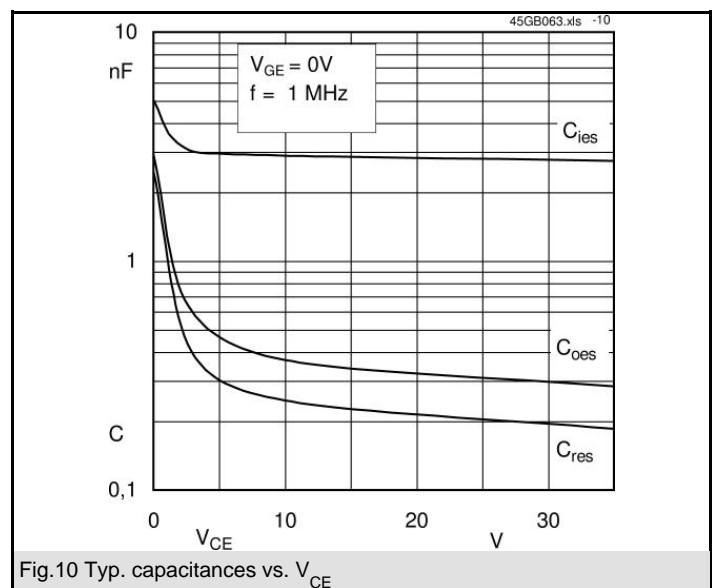
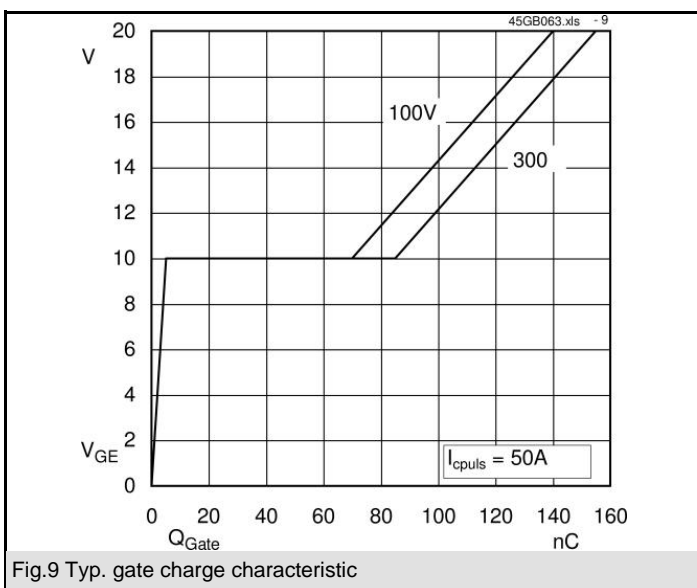
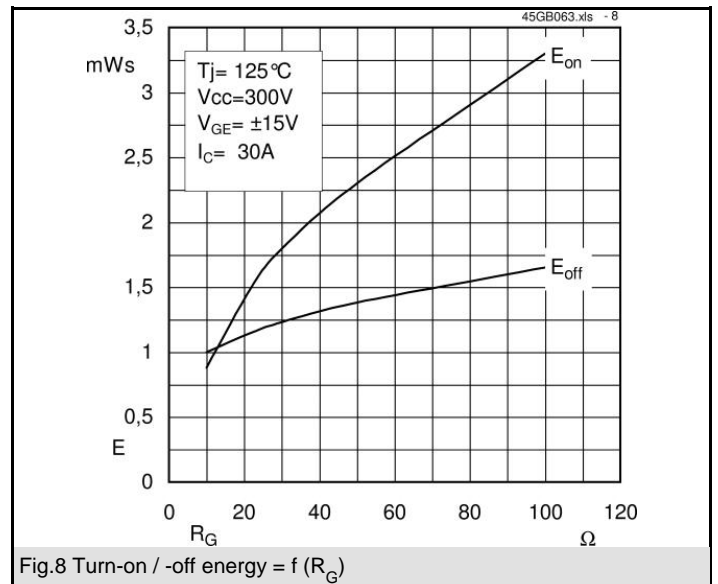
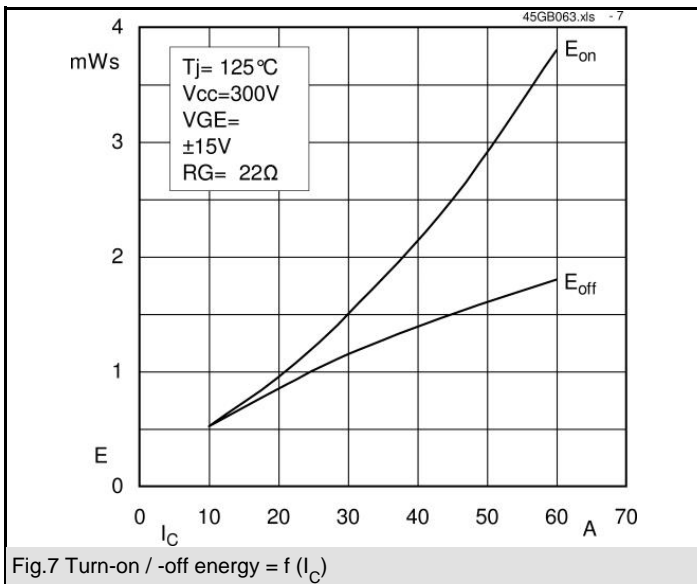
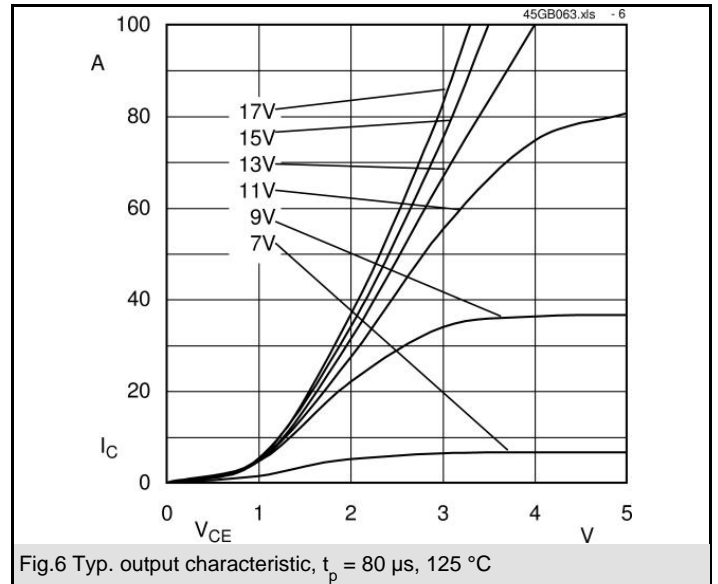
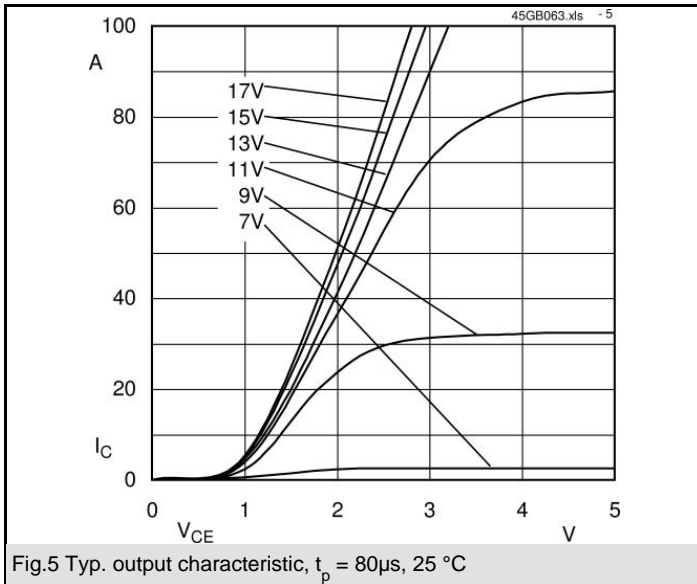

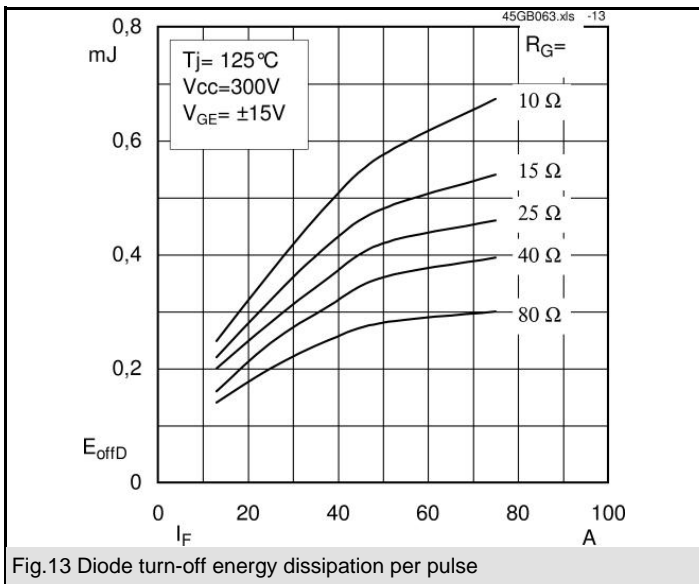
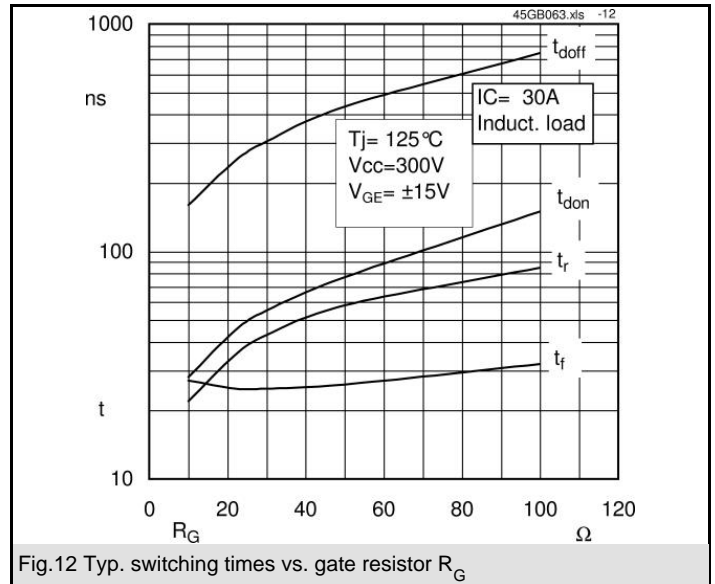
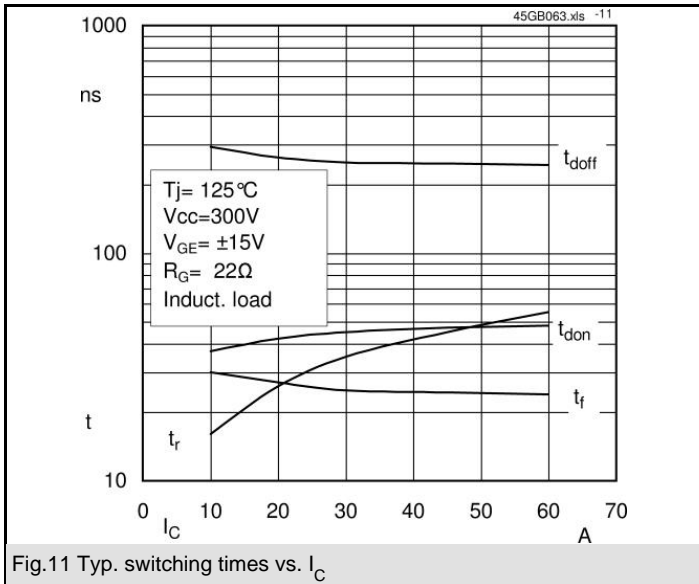

SK 45 GB 063

UL Recognized
File no. E 63532

Dimensions in mm

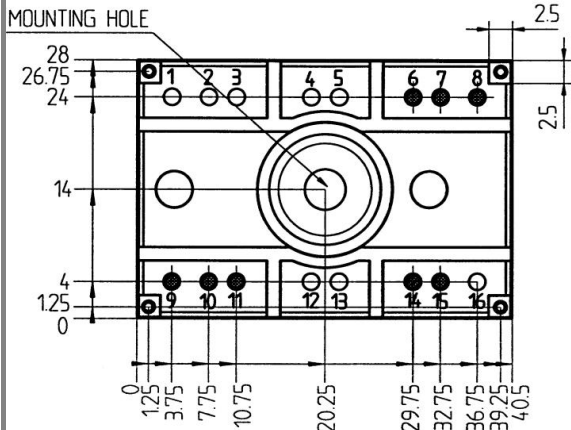
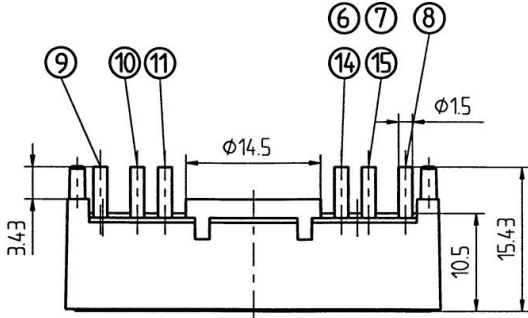

SUGGESTED HOLEDIAMETER FOR THE SOLDER PINS AND THE MOUNTING PINS IN THE PCB: 2 mm

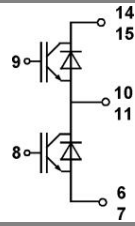
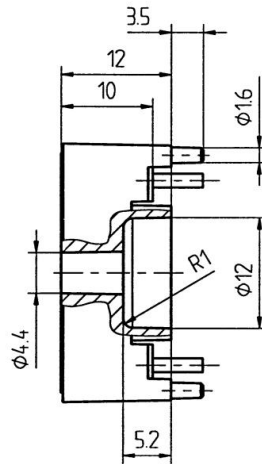

Case T4

GB

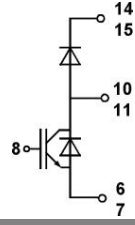

Case T4

GAL

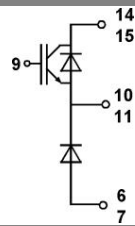

Case T4

GAR

Case T4

This is an electrostatic discharge sensitive device (ESDS), international standard IEC 60747-1, Chapter IX.

This technical information specifies semiconductor devices but promises no characteristics. No warranty or guarantee expressed or implied is made regarding delivery, performance or suitability.