

# SKM150GB12T4



SEMITRANS®2

## Fast IGBT4 Modules

SKM150GB12T4

### Features

- $V_{CE(sat)}$  with positive temperature coefficient
- High short circuit capability, self limiting to 6 x  $I_{Cnom}$
- Fast & soft inverse CAL diodes
- Large clearance (10 mm) and creepage distances (20 mm)
- Isolated copper baseplate using DBC Technology (Direct Copper Bonding)

### Typical Applications

- AC inverter drives
- UPS
- Electronic welders at fsw up to 20 kHz

### Remarks

- Case temperature limited to  $T_c = 125^\circ\text{C}$  max, recomm.  
 $T_{op} = -40 \dots +150^\circ\text{C}$ , product rel. results valid for  $T_j = 150^\circ$

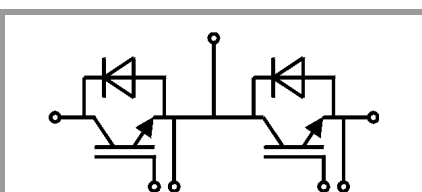

GB

Absolute Maximum Ratings				
Symbol	Conditions		Values	Unit
<b>IGBT</b>				
$V_{CES}$			1200	V
$I_C$	$T_j = 175^\circ\text{C}$	$T_c = 25^\circ\text{C}$	232	A
		$T_c = 80^\circ\text{C}$	179	A
$I_{Cnom}$			150	A
$I_{CRM}$	$I_{CRM} = 3 \times I_{Cnom}$		450	A
$V_{GES}$			-20 ... 20	V
$t_{psc}$	$V_{CC} = 800\text{ V}$	$T_j = 150^\circ\text{C}$	10	$\mu\text{s}$
	$V_{GE} \leq 15\text{ V}$ $V_{CES} \leq 1200\text{ V}$			
$T_j$			-40 ... 175	$^\circ\text{C}$
<b>Inverse diode</b>				
$I_F$	$T_j = 175^\circ\text{C}$	$T_c = 25^\circ\text{C}$	189	A
		$T_c = 80^\circ\text{C}$	141	A
$I_{Fnom}$			150	A
$I_{FRM}$	$I_{FRM} = 3 \times I_{Fnom}$		450	A
$I_{FSM}$	$t_p = 10\text{ ms, sin } 180^\circ, T_j = 25^\circ\text{C}$		900	A
$T_j$			-40 ... 175	$^\circ\text{C}$
<b>Module</b>				
$I_{t(RMS)}$			200	A
$T_{stg}$			-40 ... 125	$^\circ\text{C}$
$V_{isol}$	AC sinus 50Hz, t = 1 min		4000	V

Characteristics						
Symbol	Conditions		min.	typ.	max.	Unit
<b>IGBT</b>						
$V_{CE(sat)}$	$I_C = 150\text{ A}$ $V_{GE} = 15\text{ V}$ chipelevel	$T_j = 25^\circ\text{C}$	1.8	2.05		V
		$T_j = 150^\circ\text{C}$	2.2	2.4		V
$V_{CE0}$						
	$T_j = 25^\circ\text{C}$		0.8	0.9		V
$r_{CE}$						
	$T_j = 150^\circ\text{C}$		0.7	0.8		V
$r_{CE}$	$V_{GE} = 15\text{ V}$	$T_j = 25^\circ\text{C}$	6.7	7.7		$\text{m}\Omega$
		$T_j = 150^\circ\text{C}$	10.0	10.7		$\text{m}\Omega$
$V_{GE(th)}$	$V_{GE} = V_{CE}, I_C = 6\text{ mA}$		5	5.8	6.5	V
$I_{CES}$	$V_{GE} = 0\text{ V}$ $V_{CE} = 1200\text{ V}$	$T_j = 25^\circ\text{C}$	0.1	0.3		$\text{mA}$
		$T_j = 150^\circ\text{C}$				$\text{mA}$
$C_{ies}$				9.3		nF
$C_{oes}$	$V_{CE} = 25\text{ V}$ $V_{GE} = 0\text{ V}$	$f = 1\text{ MHz}$		0.58		nF
$C_{res}$		$f = 1\text{ MHz}$		0.51		nF
$Q_G$	$V_{GE} = -8\text{ V} \dots +15\text{ V}$			850		nC
$R_{Gint}$	$T_j = 25^\circ\text{C}$			5.0		$\Omega$
$t_{d(on)}$	$V_{CC} = 600\text{ V}$	$T_j = 150^\circ\text{C}$		180		ns
$t_r$	$I_C = 150\text{ A}$ $V_{GE} = \pm 15\text{ V}$	$T_j = 150^\circ\text{C}$		42		ns
		$T_j = 150^\circ\text{C}$		19.2		mJ
$E_{on}$	$R_{Gon} = 1\ \Omega$			19.2		mJ
$t_{d(off)}$	$R_{Goff} = 1\ \Omega$			410		ns
$t_f$	$di/dt_{on} = 3400\text{ A}/\mu\text{s}$			72		ns
$E_{off}$	$di/dt_{off} = 1750\text{ A}/\mu\text{s}$			15.8		mJ
$R_{th(j-c)}$	per IGBT				0.19	K/W



**SEMITRANS®2**

## Fast IGBT4 Modules

SKM150GB12T4

### Features

- $V_{CE(sat)}$  with positive temperature coefficient
- High short circuit capability, self limiting to  $6 \times I_{cnom}$
- Fast & soft inverse CAL diodes
- Large clearance (10 mm) and creepage distances (20 mm)
- Isolated copper baseplate using DBC Technology (Direct Copper Bonding)

### Typical Applications

- AC inverter drives
- UPS
- Electronic welders at fsw up to 20 kHz

### Remarks

- Case temperature limited to  $T_c = 125^\circ\text{C}$  max, recomm.  
 $T_{op} = -40 \dots +150^\circ\text{C}$ , product rel. results valid for  $T_j = 150^\circ$

Characteristics						
Symbol	Conditions		min.	typ.	max.	Unit
<b>Inverse diode</b>						
$V_F = V_{EC}$	$I_F = 150 \text{ A}$ $V_{GE} = 0 \text{ V}$ chip	$T_j = 25^\circ\text{C}$		2.14	2.46	V
		$T_j = 150^\circ\text{C}$		2.07	2.38	V
$V_{F0}$		$T_j = 25^\circ\text{C}$		1.3	1.5	V
		$T_j = 150^\circ\text{C}$		0.9	1.1	V
$r_F$		$T_j = 25^\circ\text{C}$		5.6	6.4	m $\Omega$
		$T_j = 150^\circ\text{C}$		7.8	8.5	m $\Omega$
$I_{RRM}$	$I_F = 150 \text{ A}$	$T_j = 150^\circ\text{C}$		120		A
$Q_{rr}$	$di/dt_{off} = 3100 \text{ A}/\mu\text{s}$	$T_j = 150^\circ\text{C}$		31.3		$\mu\text{C}$
$E_{rr}$	$V_{GE} = \pm 15 \text{ V}$ $V_{CC} = 600 \text{ V}$	$T_j = 150^\circ\text{C}$		13		mJ
$R_{th(j-c)}$	per diode				0.31	K/W
<b>Module</b>						
$L_{CE}$					30	nH
$R_{CC'+EE'}$	terminal-chip	$T_c = 25^\circ\text{C}$		0.65		m $\Omega$
		$T_c = 125^\circ\text{C}$		1		m $\Omega$
$R_{th(c-s)}$	per module			0.04	0.05	K/W
$M_s$	to heat sink M6		3		5	Nm
$M_t$		to terminals M5	2.5		5	Nm
						Nm
$w$					160	g

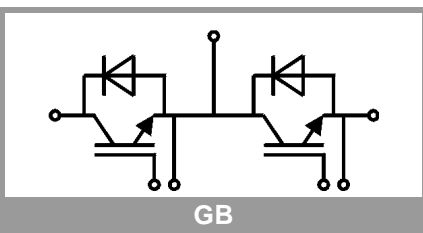

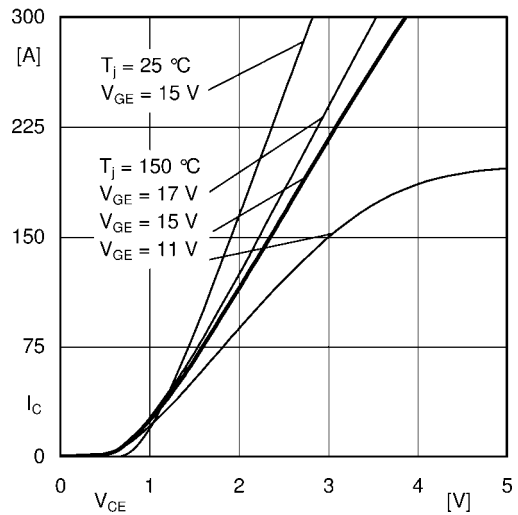

Fig. 1: Typ. output characteristic, inclusive  $R_{CC'+EE'}$

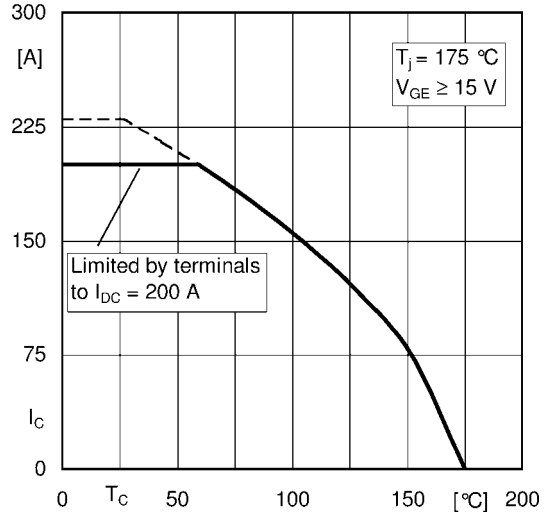

Fig. 2: Rated current vs. temperature  $I_C = f(T_C)$

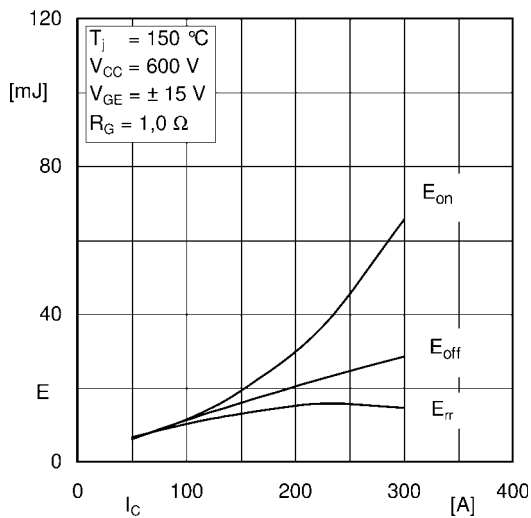

Fig. 3: Typ. turn-on /-off energy =  $f(I_C)$

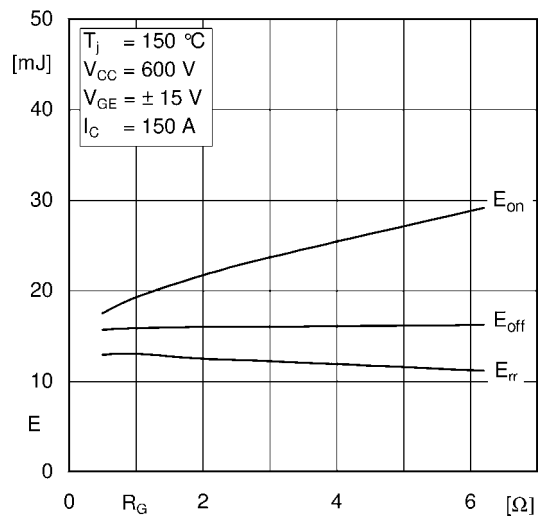

Fig. 4: Typ. turn-on /-off energy =  $f(R_G)$

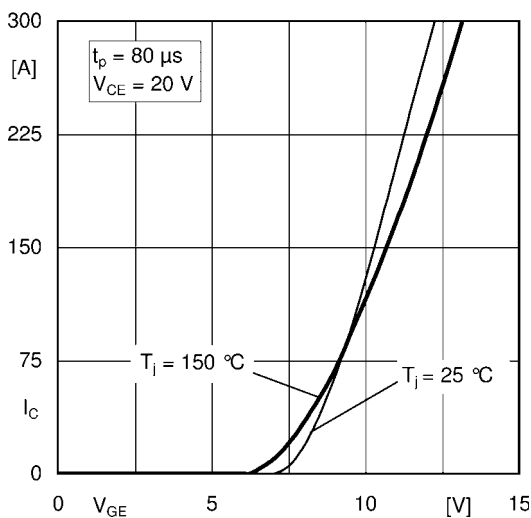

Fig. 5: Typ. transfer characteristic

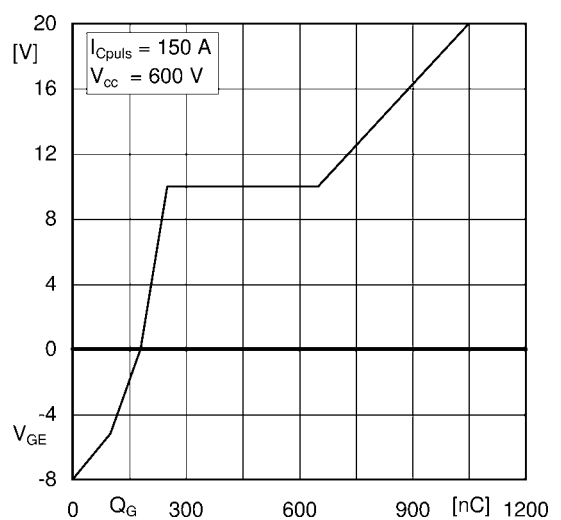

Fig. 6: Typ. gate charge characteristic

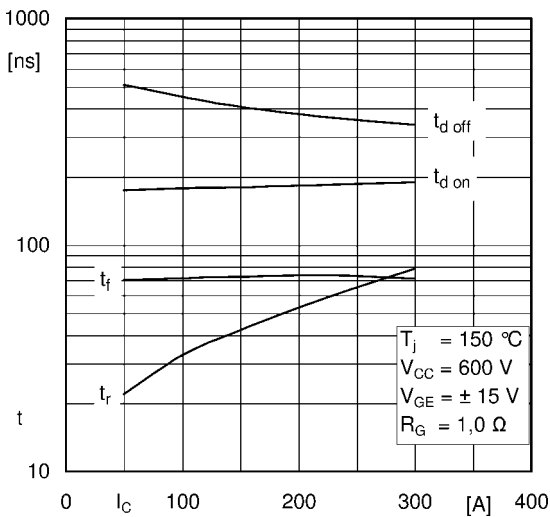

Fig. 7: Typ. switching times vs.  $I_C$

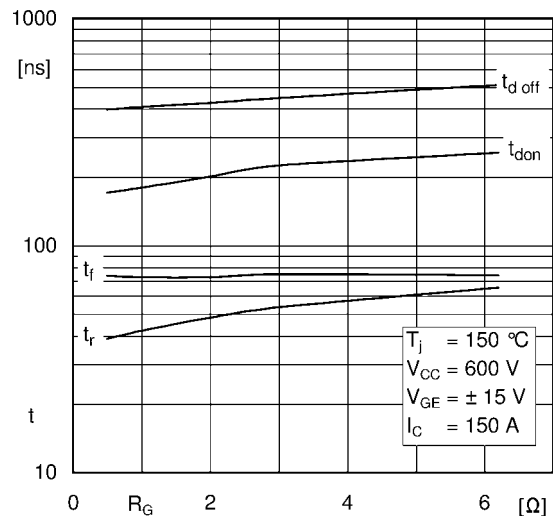

Fig. 8: Typ. switching times vs. gate resistor  $R_G$

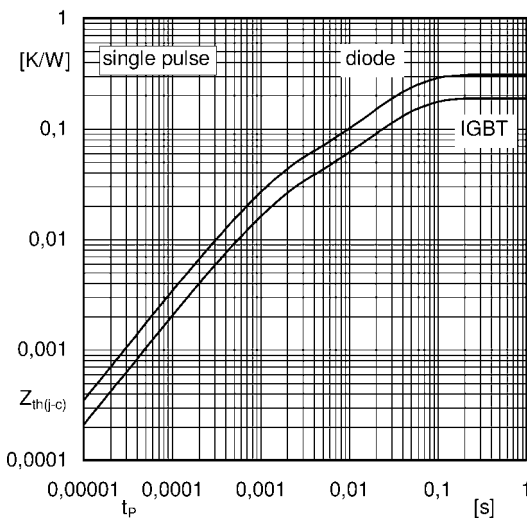

Fig. 9: Transient thermal impedance

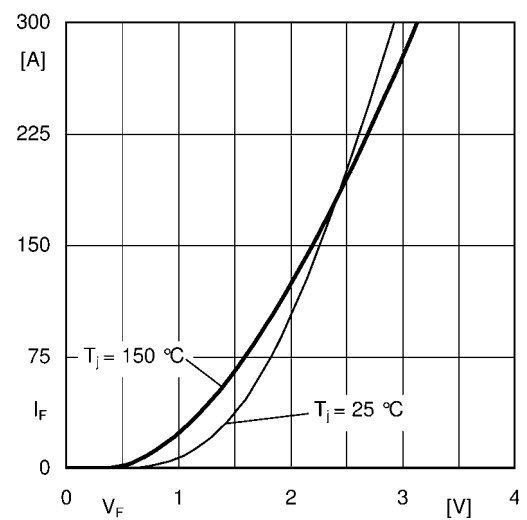

Fig. 10: CAL diode forward characteristic

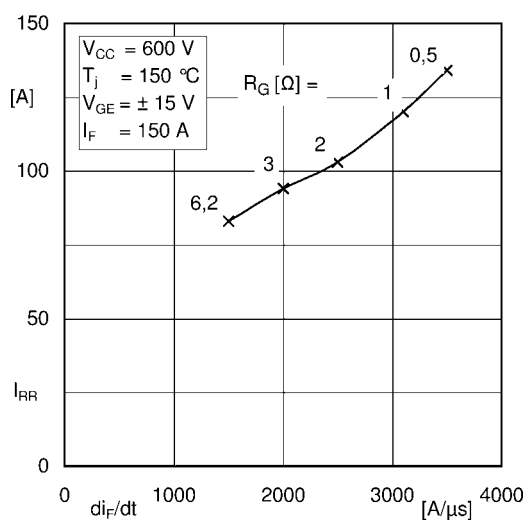

Fig. 11: CAL diode peak reverse recovery current

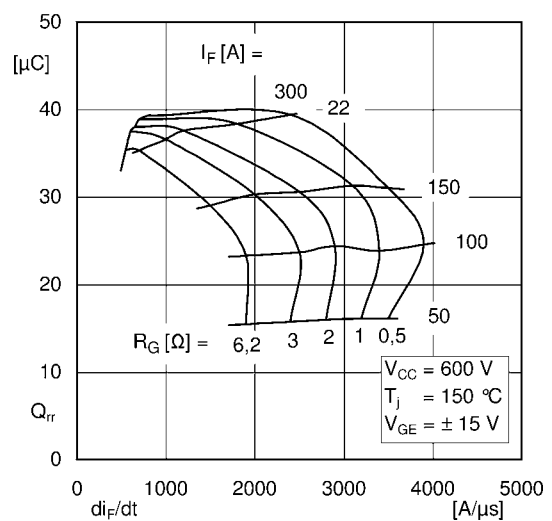
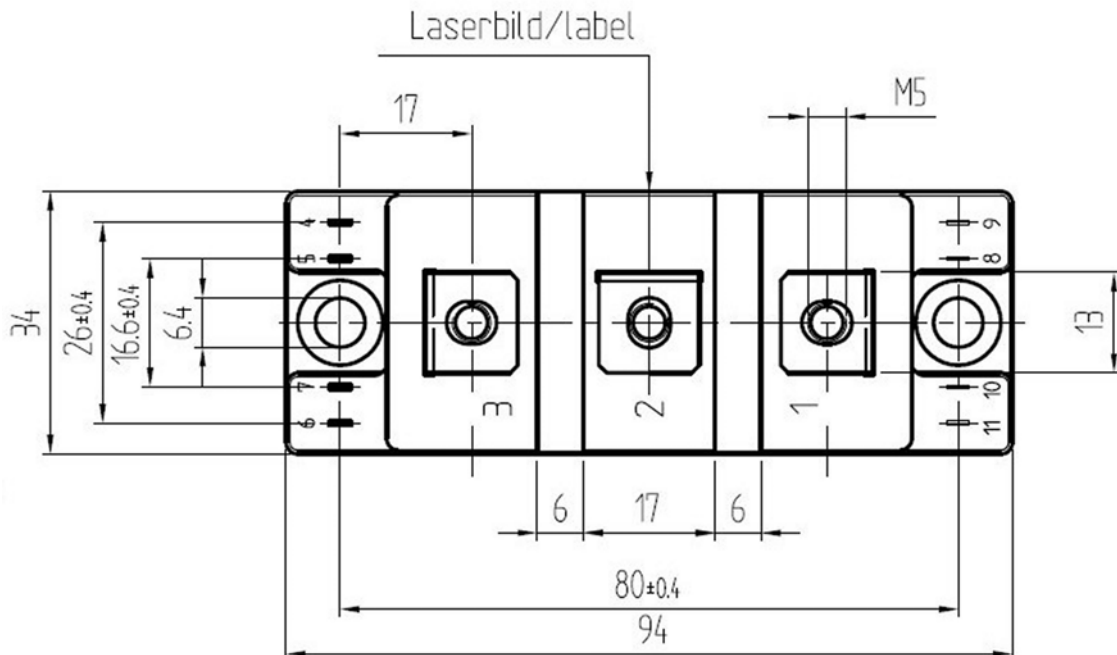
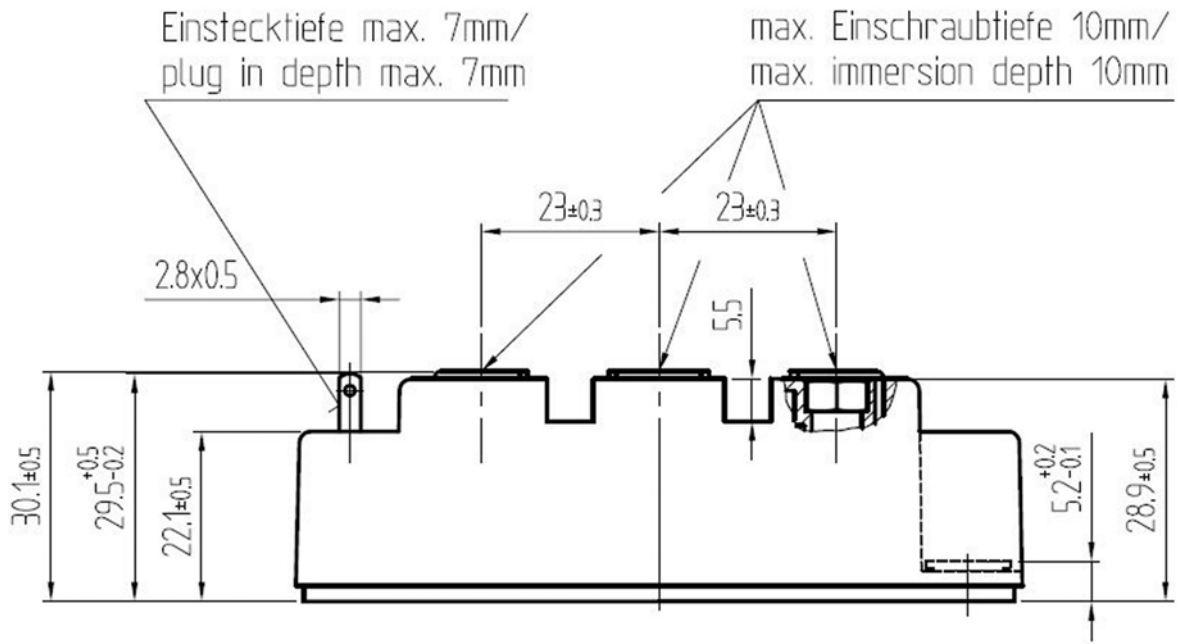
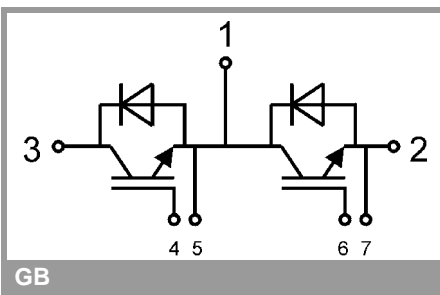

Fig. 12: Typ. CAL diode peak reverse recovery charge

# SKM150GB12T4



Semitrans 2



This is an electrostatic discharge sensitive device (ESDS), international standard IEC 60747-1, Chapter IX.

This technical information specifies semiconductor devices but promises no characteristics. No warranty or guarantee expressed or implied is made regarding delivery, performance or suitability.