



SEMITRANS®3

IGBT4 Modules

SKM300GAL12E4

Features

- IGBT4 = 4. Generation (Trench)IGBT
- VCEsat with positive temperature coefficient
- High short circuit capability, self limiting to 6 x I_{CNOM}
- Soft switching 4. Generation CAL diode (CAL4)

Typical Applications

- DC/DC – converter
- Brake chopper
- Switched reluctance motor
- DC – Motor

Remarks

- Case temperature limited to T_c = 125°C max, recomm. Top = -40 ... +150°C, product rel. results valid for T_j = 150°

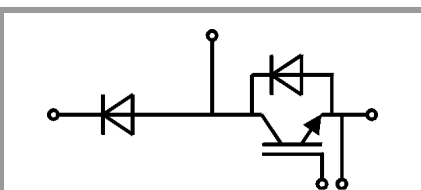

GAL

Absolute Maximum Ratings

Symbol	Conditions	Values	Unit	
IGBT				
V _{CES}		1200	V	
I _C	T _j = 175 °C	T _c = 25 °C T _c = 80 °C	422 324	A A
I _{Cnom}		300	A	
I _{CRM}	I _{CRM} = 3xI _{Cnom}	900	A	
V _{GES}		-20 ... 20	V	
t _{psc}	V _{CC} = 800 V V _{GE} ≤ 15 V V _{CES} ≤ 1200 V	T _j = 150 °C	10	µs
T _j		-40 ... 175	°C	
Inverse diode				
I _F	T _j = 175 °C	T _c = 25 °C T _c = 80 °C	353 264	A A
I _{Fnom}		300	A	
I _{FRM}	I _{FRM} = 3xI _{Fnom}	900	A	
I _{FSM}	t _p = 10 ms, sin 180°, T _j = 25 °C	1548	A	
T _j		-40 ... 175	°C	
Freewheeling diode				
I _F	T _j = 175 °C	T _c = 25 °C T _c = 80 °C	353 264	A A
I _{Fnom}		300	A	
I _{FRM}	I _{FRM} = 3xI _{Fnom}	900	A	
I _{FSM}	t _p = 10 ms, sin 180°, T _j = 25 °C	1548	A	
T _j		-40 ... 175	°C	
Module				
I _{t(RMS)}		500	A	
T _{stg}		-40 ... 125	°C	
V _{isol}	AC sinus 50Hz, t = 1 min	4000	V	

Characteristics

Symbol	Conditions	min.	typ.	max.	Unit
IGBT					
V _{CE(sat)}	I _C = 300 A V _{GE} = 15 V chipelevel	T _j = 25 °C T _j = 150 °C	1.85 2.25	2.1 2.45	V V
V _{CE0}		T _j = 25 °C T _j = 150 °C	0.8 0.7	0.9 0.8	V V
r _{CE}	V _{GE} = 15 V	T _j = 25 °C T _j = 150 °C	3.5 5.2	4.0 5.5	mΩ mΩ
V _{GE(th)}	V _{GE} =V _{CE} , I _C = 12 mA	5	5.8	6.5	V
I _{CES}	V _{GE} = 0 V V _{CE} = 1200 V	T _j = 25 °C T _j = 150 °C	0.1	0.3	mA mA
C _{ies}	V _{CE} = 25 V	f = 1 MHz	17.6		nF
C _{oes}	V _{GE} = 0 V	f = 1 MHz	1.16		nF
C _{res}		f = 1 MHz	0.94		nF
Q _G	V _{GE} = - 8 V...+ 15 V		1700		nC
R _{Gint}	T _j = 25 °C		2.5		Ω



SEMITRANS®3

IGBT4 Modules

SKM300GAL12E4

Features

- IGBT4 = 4. Generation (Trench)IGBT
- VCEsat with positive temperature coefficient
- High short circuit capability, self limiting to 6 x I_{CNOM}
- Soft switching 4. Generation CAL diode (CAL4)

Typical Applications

- DC/DC – converter
- Brake chopper
- Switched reluctance motor
- DC – Motor

Remarks

- Case temperature limited to T_c = 125°C max, recomm. Top = -40 ... +150°C, product rel. results valid for T_j = 150°

Characteristics						
Symbol	Conditions		min.	typ.	max.	Unit
t _{d(on)}	V _{CC} = 600 V	T _j = 150 °C		220		ns
t _r	I _C = 300 A	T _j = 150 °C		44		ns
E _{on}	V _{GE} = ±15 V	T _j = 150 °C		27		mJ
t _{d(off)}	R _{G on} = 1.5 Ω	T _j = 150 °C		520		ns
t _f	R _{G off} = 1.5 Ω	T _j = 150 °C		117		ns
E _{off}	di/dt _{on} = 6100 A/μs	T _j = 150 °C		39		mJ
R _{th(j-c)}	per IGBT				0.11	K/W
Inverse diode						
V _F = V _{EC}	I _F = 300 A	T _j = 25 °C		2.17	2.49	V
	V _{GE} = 0 V	T _j = 150 °C		2.11	2.42	V
	chip					
V _{F0}		T _j = 25 °C		1.3	1.5	V
		T _j = 150 °C		0.9	1.1	V
r _F		T _j = 25 °C		2.9	3.3	mΩ
		T _j = 150 °C		4.0	4.4	mΩ
I _{RRM}	I _F = 300 A	T _j = 150 °C		345		A
Q _{rr}	di/dt _{off} = 7300 A/μs	T _j = 150 °C		54		μC
E _{rr}	V _{GE} = ±15 V	T _j = 150 °C		23		mJ
	V _{CC} = 600 V					
R _{th(j-c)}	per diode				0.17	K/W
Freewheeling diode						
V _F = V _{EC}	I _F = 300 A	T _j = 25 °C		2.17	2.49	V
	V _{GE} = 0 V	T _j = 150 °C		2.11	2.42	V
	chip					
V _{F0}		T _j = 25 °C		1.3	1.5	V
		T _j = 150 °C		0.9	1.1	V
r _F		T _j = 25 °C		2.9	3.3	mΩ
		T _j = 150 °C		4.0	4.4	mΩ
I _{RRM}	I _F = 300 A	T _j = 150 °C		345		A
Q _{rr}	di/dt _{off} = 7300 A/μs	T _j = 150 °C		54		μC
E _{rr}	V _{GE} = ±15 V	T _j = 150 °C		23		mJ
	V _{CC} = 600 V					
R _{th(j-c)}	per Diode				0.17	K/W
Module						
L _{CE}				15	20	nH
R _{CC+EE'}	terminal-chip	T _C = 25 °C		0.25		mΩ
		T _C = 125 °C		0.5		mΩ
R _{th(c-s)}	per module			0.02	0.038	K/W
M _s	to heat sink M6		3		5	Nm
M _t		to terminals M6	2.5		5	Nm
						Nm
w					325	g

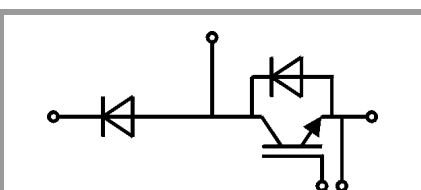

GAL

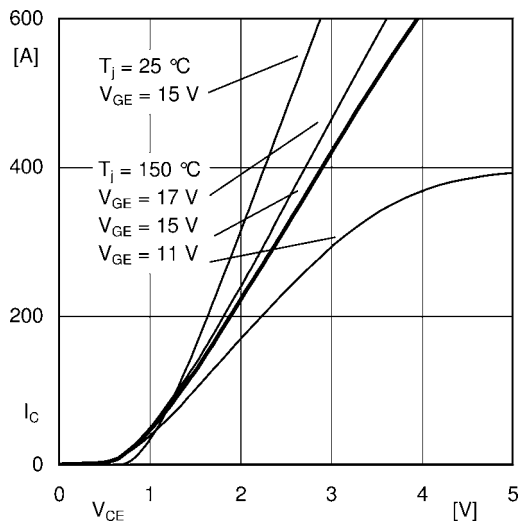

Fig. 1: Typ. output characteristic, inclusive $R_{CC'+EE'}$

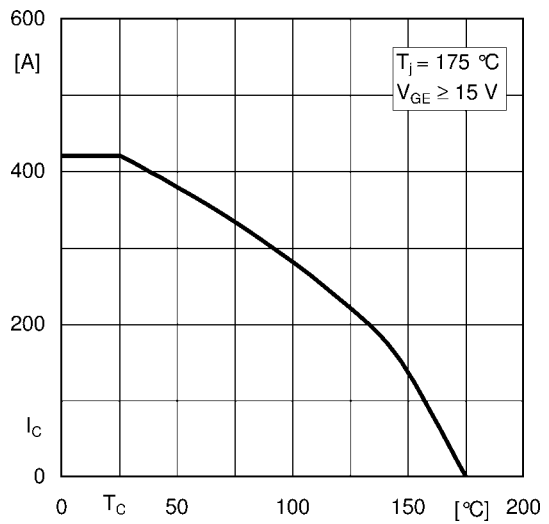

Fig. 2: Rated current vs. temperature $I_C = f(T_C)$

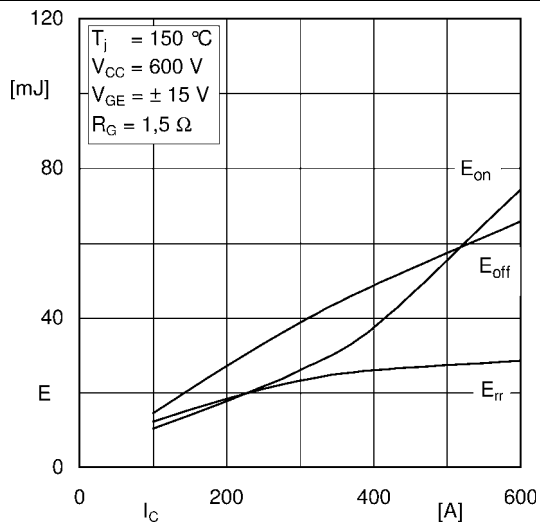

Fig. 3: Typ. turn-on /-off energy = $f(I_C)$

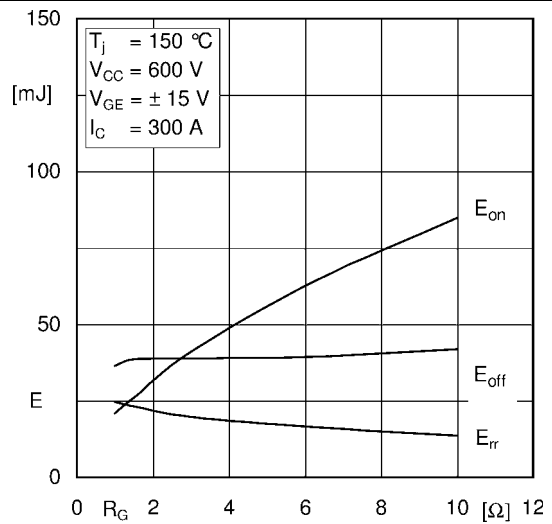

Fig. 4: Typ. turn-on /-off energy = $f(R_G)$

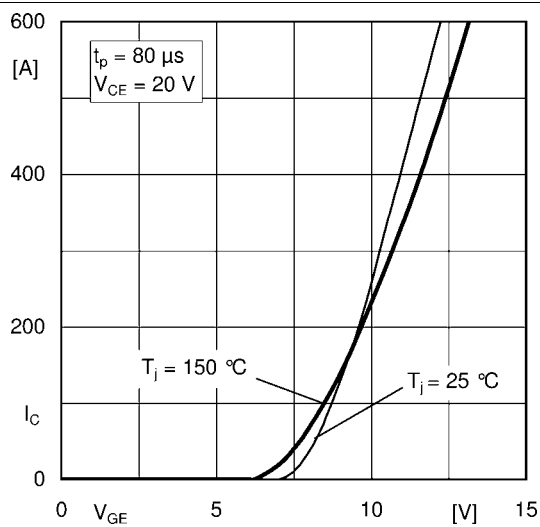

Fig. 5: Typ. transfer characteristic

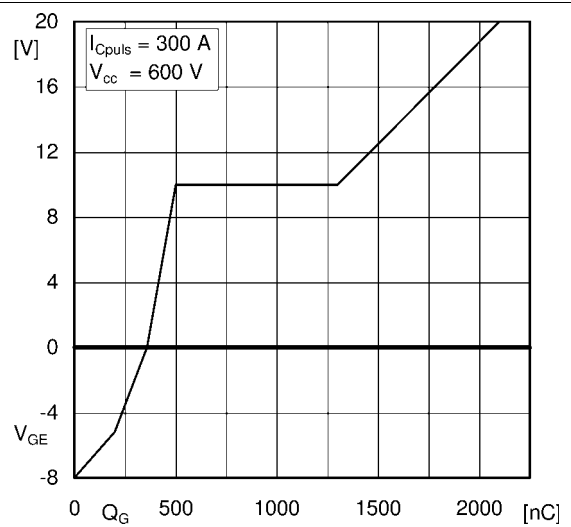

Fig. 6: Typ. gate charge characteristic

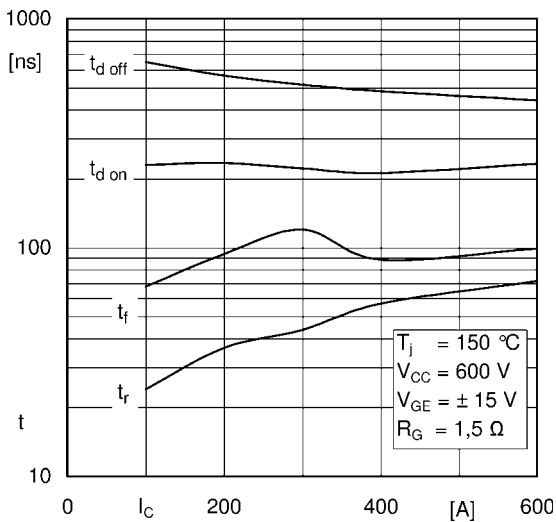

Fig. 7: Typ. switching times vs. I_C

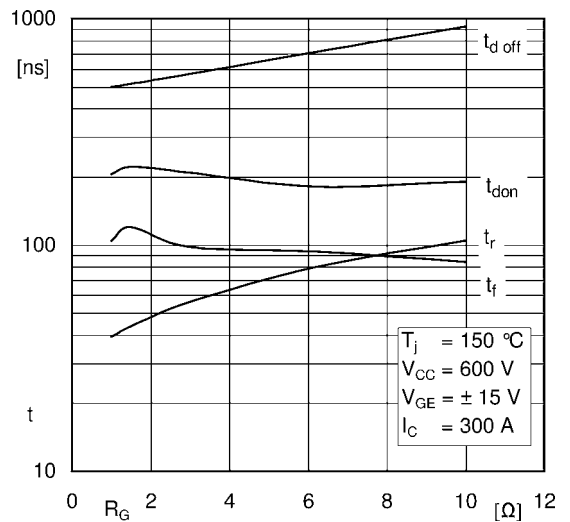

Fig. 8: Typ. switching times vs. gate resistor R_G

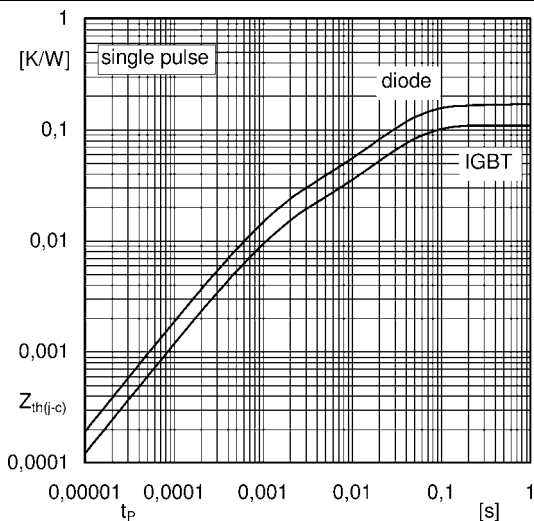

Fig. 9: Transient thermal impedance

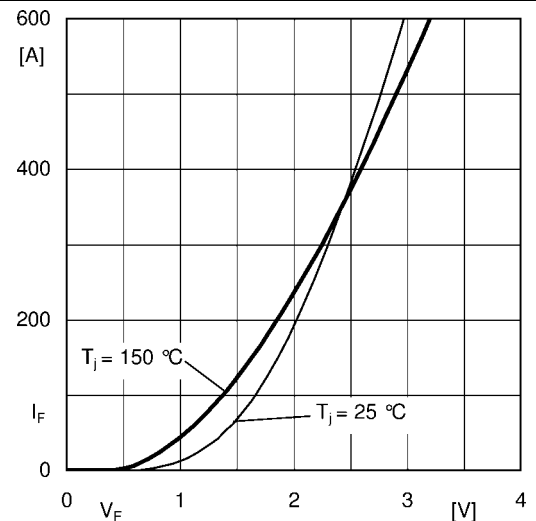

Fig. 10: CAL diode forward characteristic

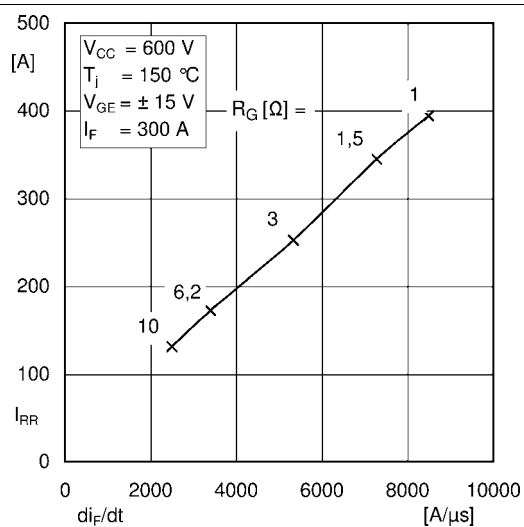

Fig. 11: CAL diode peak reverse recovery current

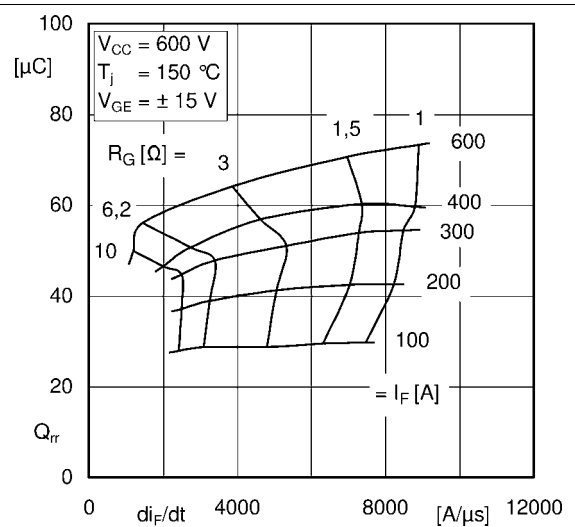
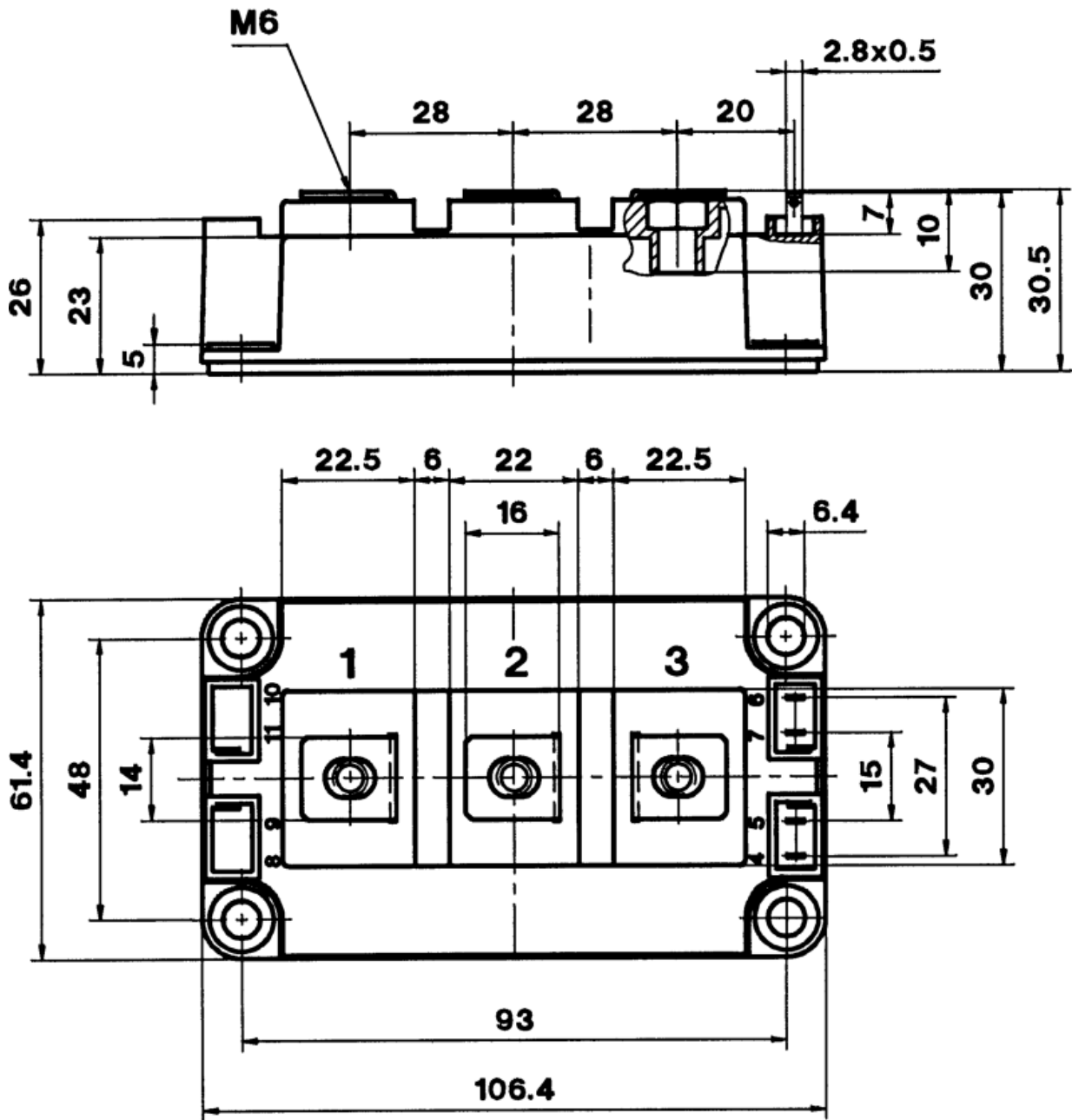
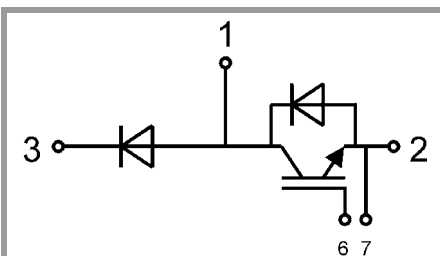

Fig. 12: Typ. CAL diode peak reverse recovery charge



Semitrans 3



GAL

This is an electrostatic discharge sensitive device (ESDS), international standard IEC 60747-1, Chapter IX.

This technical information specifies semiconductor devices but promises no characteristics. No warranty or guarantee expressed or implied is made regarding delivery, performance or suitability.