

SEED TECHNOLOGY INC (SEEEDUINO)

Bluetooth Shield

Model: SLD63030P

Introduction

The Bluetooth Shield integrates a Serial Bluetooth module. It can be easily used with Arduino/Seedstudio for transparent wireless serial communication. You can choose two pins from Arduino D0 to D7 as Software Serial Ports to communicate with Bluetooth Shield (D0 and D1 is Hardware Serial Port). The shield also has two Grove connectors (one is Digital, the other is Analog) for you to install Grove modules.

Note: The Shield may not be compatible with some Bluetooth capable devices, like some HTC mobile phone (G7 with Android 2.33) and Apple devices with special profile on Bluetooth function.

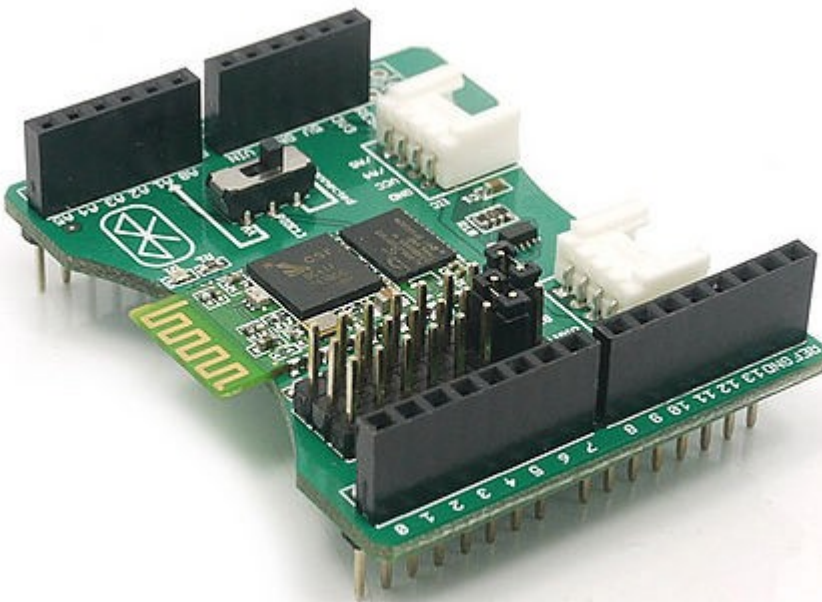

Features

- Seeduino/Arduino compatible
- Up to 10m communication distance in house without obstacle
- UART interface (TTL) with programmable baud rate (SPP firmware installed)
- Default Baud rate: 38400, Data bits: 8, Stop bit: 1, Parity: No parity
- Default PINCODE: "0000"
- A full set of configuration commands
- On board PCB Antenna
- FCC Part 15 Certificated

Specification

Item	Min	Typical	Max	Unit
Voltage	2.8	3.3	3.5	VDC
Current	3	/	100	mA
Communication Distance(in house)	/	/	10	m

Protocol	Bluetooth V2.0 with SPP firmware	/
Interface	Uart Serial Port(TTL)	/
Supported Baudrate	9600, 19200, 38400, 57600, 115200, 230400, 460800	bps
ESD contact discharge	±4	KV
ESD air discharge	±8	/
Dimension	57.4x45.3x19.4	mm
Net Weight	10±2	g

Interface funcion

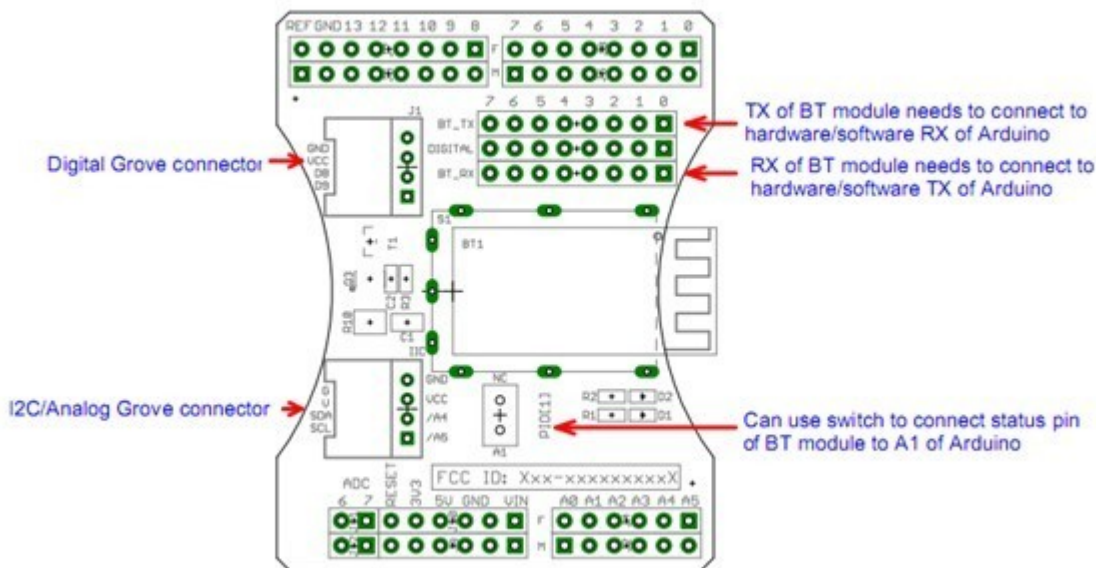

Pad Type	Description
PIO1	Status instruction port of Bluetooth module can be read by Arduino A1 port: low-disconnected, high-connected.
BT_RX	UART Data input of Bluetooth module.
BT_TX	UART Data output Bluetooth module.
Two Grove connectors	One is Digital (D8 and D9), the other is I2C/Analog (A4 and A5).

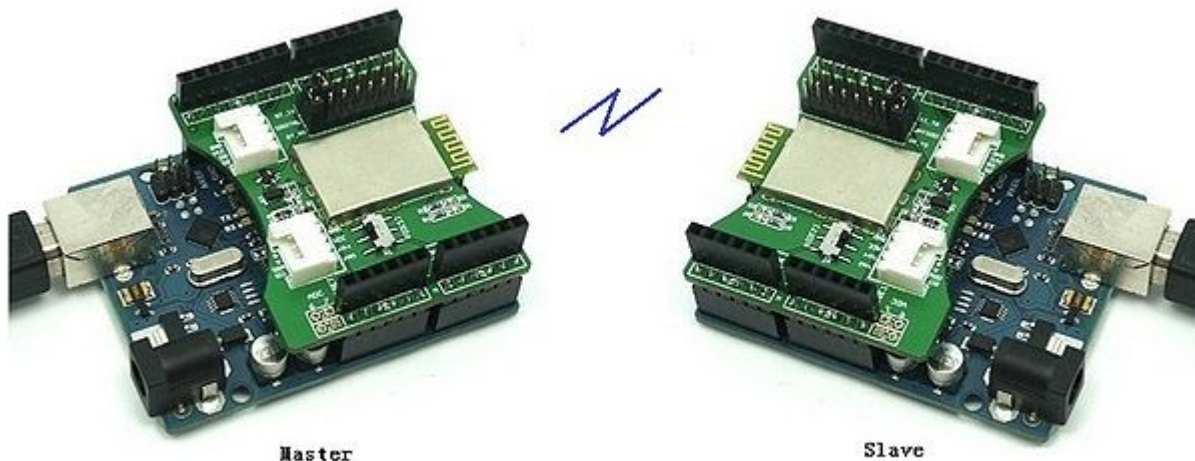
Usage**Communicating between two Bluetooth Shield**

This demo will show you how to communicate between two Arduino/Seeeduino through Bluetooth Shield. For the special applications, you may need to write the code by yourself.

- Download the [Arduino Library](#) for the shield, and unzip it into the path of Arduino Libraries. This library includes two sketch, one for Master and the other for Slave. Make sure [Software Serial Library](#) is included as well.

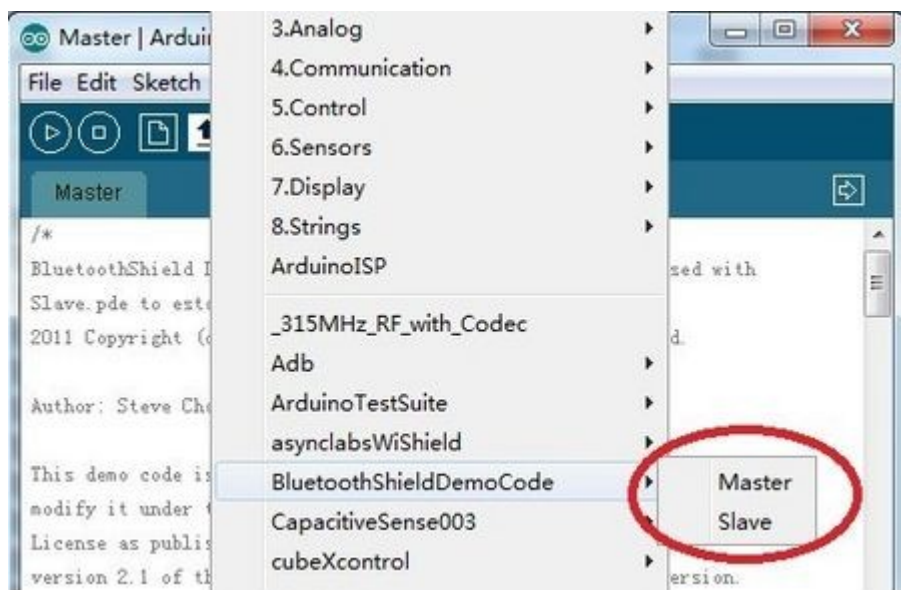

- Upload the sketch Master.pde and Slave.pde to two separate Arduino/Seeeduino.
- Open two [Serial Terminals](#) on your PC, with the setting of 9600, 8, 1, N. Open the two Com Port of Arduino/Seeeduino.



- Plug the Bluetooth Shields to the Master board and the Slave Board, and reset the two boards.

Then you will see the red and green LED on the board are flashing in interval indicting they are inquiring for each other. After a while only the green led is flashing one time per second indicating that they are connected. There's also some information printed on the two terminal as following.

```
Master is inquiring!
Connecting to slave:0, 18, E4, C, 68, 5:SeeedBTSlave
Connected!
```

Master

```
The slave bluetooth is inquirable!
+BTSTATE: 3
CONNECT: OK
+BTSTATE: 4
Connected!
```

Slave

- The connection is successful now, and you can type any character on the Serial Terminal and send to each .

Connecting Bluetooth Shield to PC under Windows 7



Slave



Master

This demo will show you how to connect the Arduino/Seeduino with Bluetooth Shield to PC. For the special applications, you may need to write the code by yourself.

- Download the [Arduino Library](#) for the shield, and unzip it into the path of Arduino Libraries. This library includes two sketch, one for Master and the other for Slave. Make sure [Software Serial Library](#) is included as well.
- Plug the Bluetooth Shield onto the Arduino/Seeeduino, and upload the Slave.pde to the board. Open the Serial Terminal with setting of 9600, 8, 1, N.

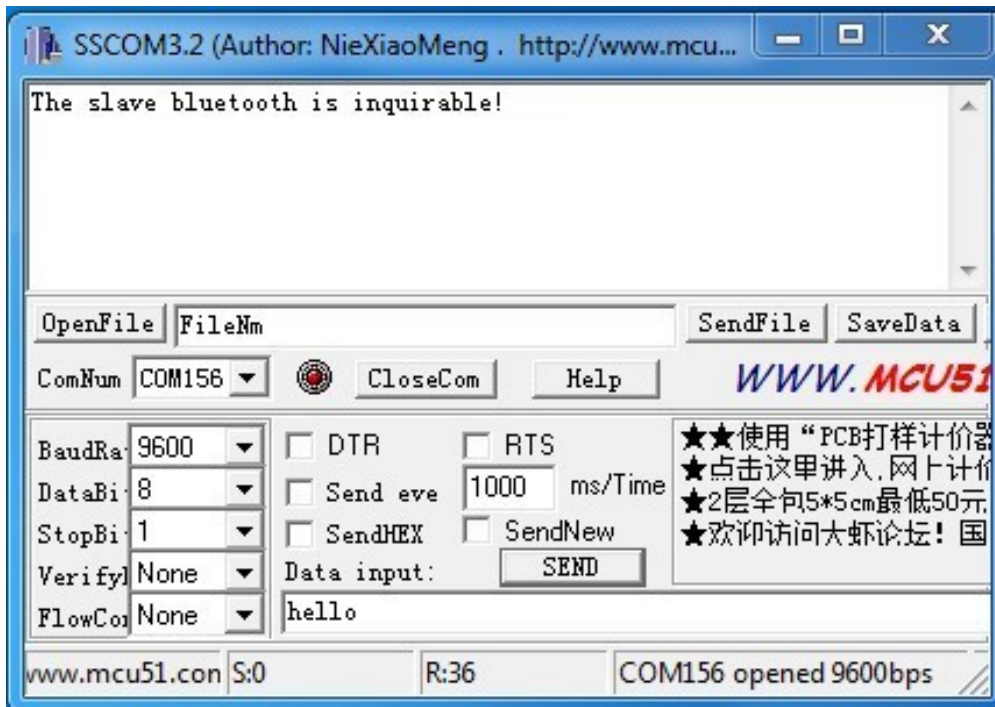

- Install the Microsoft Bluetooth default drivers (Skip this if your PC has integrated Bluetooth function). See the following picture after installed.

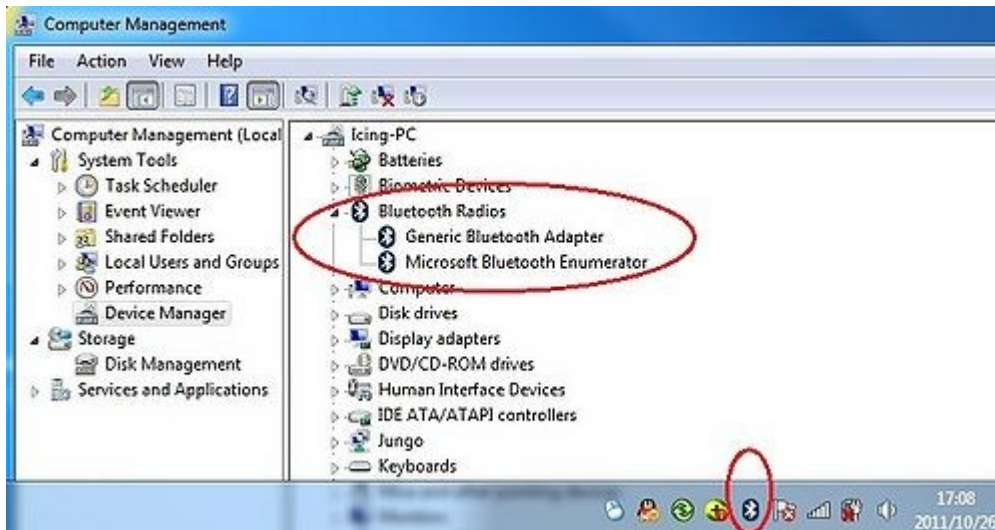

- Click **Add a Device** button.

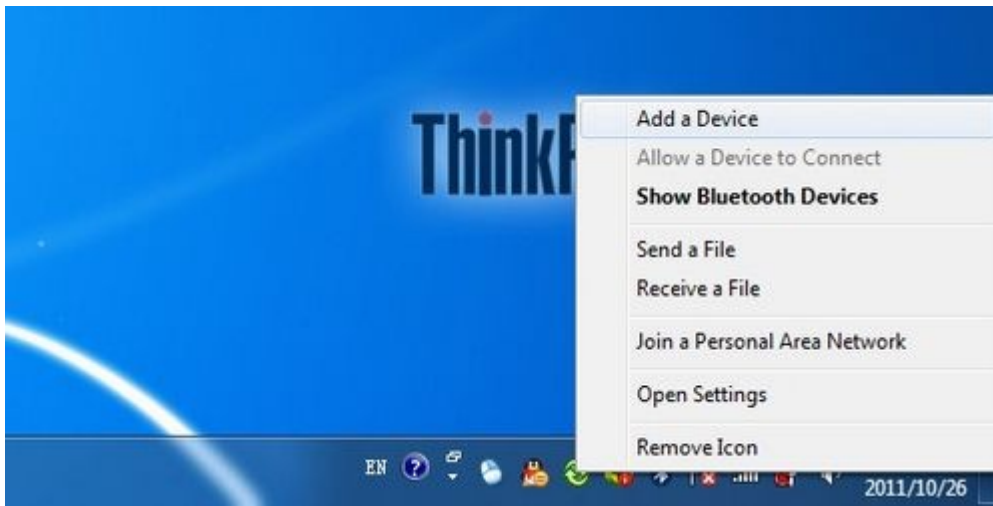

- Select the "SeedBTSlave" device and click Next.



- When connecting is successful, we will get the following information.

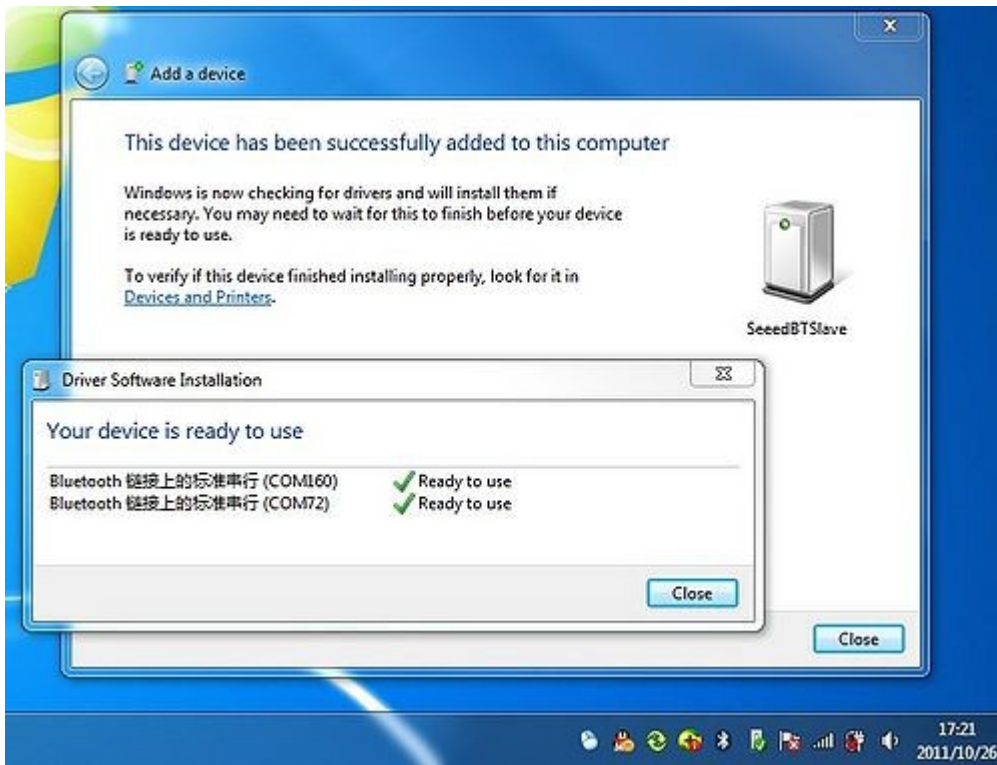

- Open another Serial Terminal with the setting of 9600, 8, 1, N. Open the first COM(COM160) shown on the last picture. There will be showing the information as in the following picture.

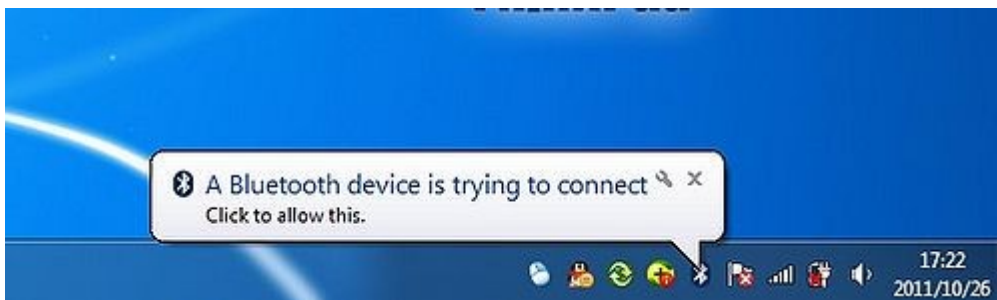

- Click it, and enter **0000** in the shown diagram. Click Next to wait the establish.



- The connection may be failed as shown in the following picture.



- Click Close, and open the COM160 again, try the previous step till it is successful as following.



- Now you can send any character between each other.

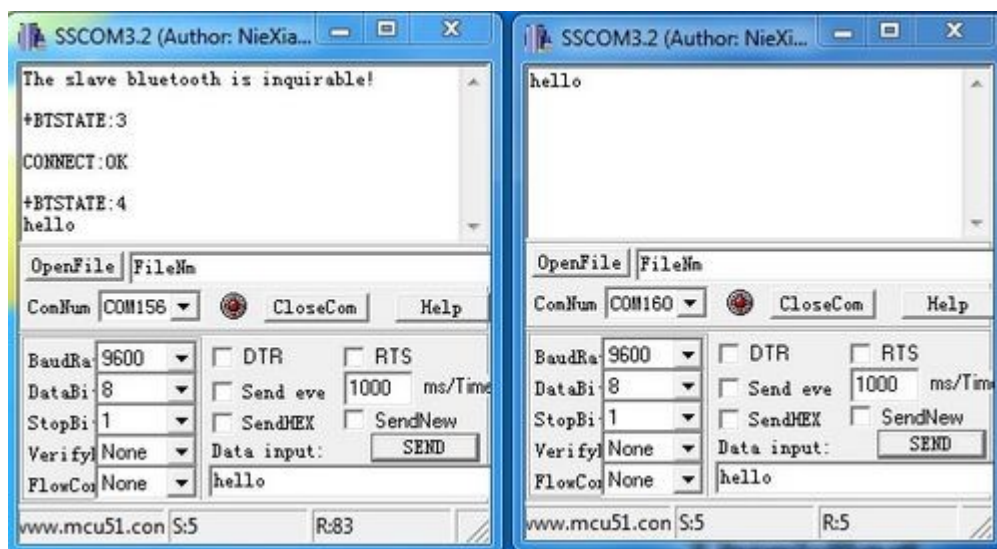

Connecting Bluetooth Shield to Android Phone



Slave



Master

This demo will show you how to connect Bluetooth Shield to Android Phone. Here we test on HTC Legend with Android 2.2. For the special applications, you may need to write the code by yourself.

- Download the [Arduino Library](#) for the shield, and unzip it into the path of Arduino Libraries. This library includes two sketch, one for Master and the other for Slave. Make sure [Software Serial Library](#) is included as well.
- Plug the Bluetooth Shield onto the Arduino/Seeeduno, and upload the Slave.pde to the board. Open the Serial Terminal with setting of 9600, 8, 1, N.



- Download an Serial Terminal for Android to the phone. [Here](#) we find an apk (Bluetooth SPP) in Chinese. Install the apk.



- Enable the bluetooth function and scan for devices. "SeedBTSlave" will be shown as in the following picture.



- Select and pair with the "SeedBTSlave", input the PIN code **0000**, choose OK.



- Now let's open the Bluetooth SPP on Android. It illustrates **Press [MENU] key to create Bluetooth-enabled device. Tip: set up before the first connection and the Bluetooth pairing phone.**



- Press MENU key, and there will be a list of devices found shown the phone.



- Select "SeedBTSlave", and wait a second, the connection will be established. And you can receive and send any character through this terminal.



Full AT Command

Check [here](#) for the full AT Command of Bluetooth Module.

[Ask questions on Seeed Forum](#)

Version Tracker

Revision	Descriptions	Release
v0.9b	Initial public release	Jun 26, 2011

Resources

- [Bluetooth Shield Eagle Files](#)
- [NewSoftLibrary](#)
- [Bluetooth Shield Demo Code](#)
- [Information](#) on how to setup connections between Serial Bluetooth is available in Seedstudio Forum.
- [Information](#) on PC connecting Serial Bluetooth in Seedstudio Forum

Licensing

This documentation is licensed under the Creative Commons [Attribution-ShareAlike License 3.0](#) Source code and libraries are licensed under [GPL/LGPL](#), see source code files for details.