

Transil™ for IEC 61000-4-5 compliance

Features

- Peak pulse current: 500 A (8/20 μ s, 1.2/50 μ s)
- Stand off voltage range: from 24 V to 33 V
- Unidirectional types
- Low leakage current
 - 0.2 μ A at 25 °C
 - 1 μ A at 85 °C
- Operating T_j max: 150 °C
- High peak current capability at T_j max : 410 A 8/20 μ s
- JEDEC registered package outline

Complies with the following standards

- IEC 61000-4-2 level 4
 - 15 kV (air discharge)
 - 8 kV (contact discharge)
- MIL STD 883G - Method 3015-7 Class 3B
 - 25 kV HBM (human body model)
- IEC 61000-4-5
 - Level 4 4 kV with $R = 12 \Omega$ (334 A) common mode
 - Level 2 1 kV with $R = 2 \Omega$ (500 A) differential mode
- MIL STD 883G, method 3015-7 Class 3B -25 kV HBM (human body model)
- Resin meets UL 94, V0
- MIL-STD-750, method 2026 soldererability
- EIA STD RS-481 and IEC 60286-3 packing
- IPC 7531 footprint

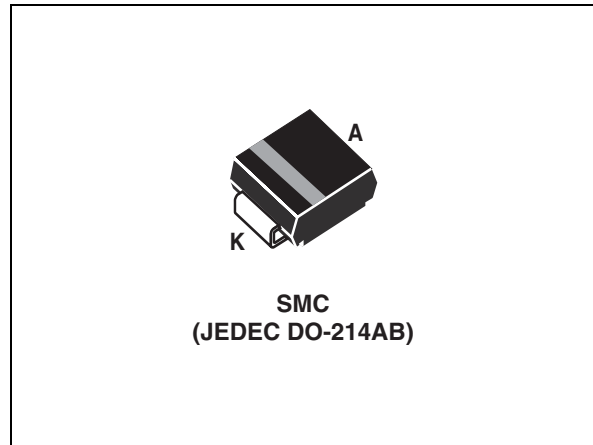

Description

The STIEC45 Transil series has been designed to protect DC power supply lines according to IEC 61000-4-5. This device protects circuits against electrical fast transients (EFT) according to IEC 61000-4-4 and ETS EN 300 386. Protection against electrostatic discharges is provided according to IEC 61000-4-2 and MIL STD 883 Method 3015.

Planar technology makes these devices suitable for high-end equipment and SMPS where low leakage current and high junction temperature are required to provide reliability and stability over time.

The STIEC45 device is packaged in SMC (SMC footprint in accordance with IPC 7351 standard).

TM: Transil is a trademark of STMicroelectronics

1 Characteristics

Table 1. Absolute maximum ratings ($T_{amb} = 25\text{ }^{\circ}\text{C}$)

Symbol	Parameter	Value	Unit
I_{PP}	Peak pulse current ⁽¹⁾ (8/20 μs , 1.2/50 μs)	T_j initial = T_{amb} 500	A
T_{stg}	Storage temperature range	-65 to +150	$^{\circ}\text{C}$
T_j	Operating junction temperature range	-55 to +150	$^{\circ}\text{C}$
T_L	Maximum lead temperature for soldering during 10 s.	260	$^{\circ}\text{C}$

1. For a surge greater than the maximum values, the diode will fail in short-circuit.

Table 2. Thermal resistances

Symbol	Parameter	Value	Unit
$R_{th(j-l)}$	Junction to leads	15	$^{\circ}\text{C}/\text{W}$
$R_{th(j-a)}$	Junction to ambient on printed circuit on recommended pad layout	90	$^{\circ}\text{C}/\text{W}$

Figure 1. Electrical characteristics - parameters

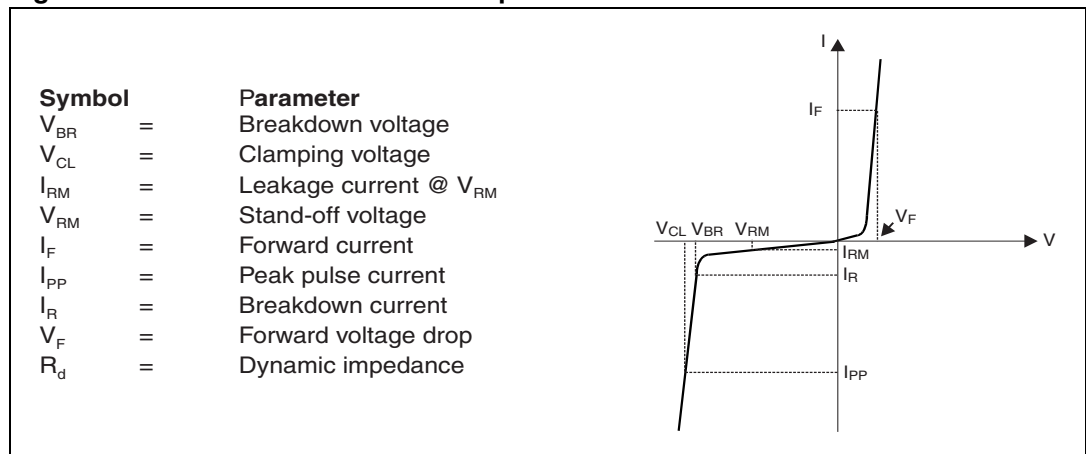

Table 3. Electrical characteristics - parameter values ($T_{amb} = 25\text{ }^{\circ}\text{C}$)

Order code	I_{RM} @ V_{RM}			V_{BR} @ $I_R^{(1)}$				V_{CL} @ I_{PP} 8/20 μs , 1.2/50 μs		$R_D^{(2)}$ 8/20 μs	$\alpha T^{(3)}$
	25 $^{\circ}\text{C}$	85 $^{\circ}\text{C}$		Min.	Typ.	Max.		Max.		Typ.	max
	μA		V	V			mA	V	A	Ω	$10^{-4}/\text{ }^{\circ}\text{C}$
STIEC45-24AS	0.2	1	24	26.7	28.2	29.5	1	42	500	0.025	9.6
STIEC45-26AS	0.2	1	26	28.9	30.3	31.9	1	45	500	0.026	9.7
STIEC45-27AS	0.2	1	27	30	31.6	33.2	1	47	500	0.028	9.7
STIEC45-28AS	0.2	1	28	31.1	32.6	34.3	1	49	500	0.029	9.8
STIEC45-30AS	0.2	1	30	33.3	35	36.8	1	55	500	0.036	9.9
STIEC45-33AS	0.2	1	33	36.7	38.6	40.6	1	59	500	0.036	10

1. Pulse test: $t_p < 50\text{ ms}$
2. To calculate maximum clamping voltage at other surge levels: $V_{CLmax} = R_D \times I_{PP} + V_{BRmax}$
3. To calculate V_{BR} versus junction temperature: $V_{BR} @ T_j = V_{BR} @ 25^{\circ}\text{C} \times (1 + \alpha T \times (T_j - 25))$

Note: Surge capability given for both directions for unidirectional and bidirectional types.

Figure 2. Pulse form

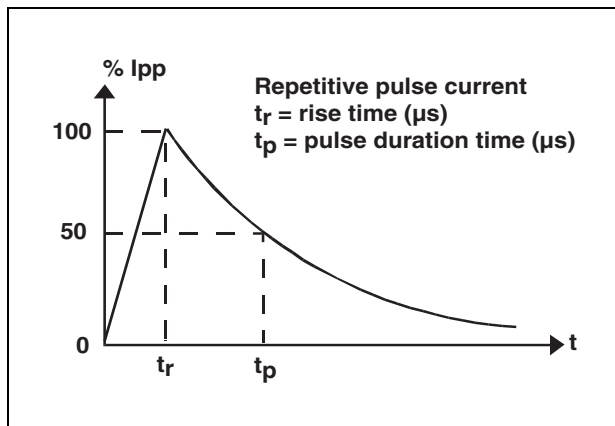

Figure 3. Peak pulse current versus initial junction temperature

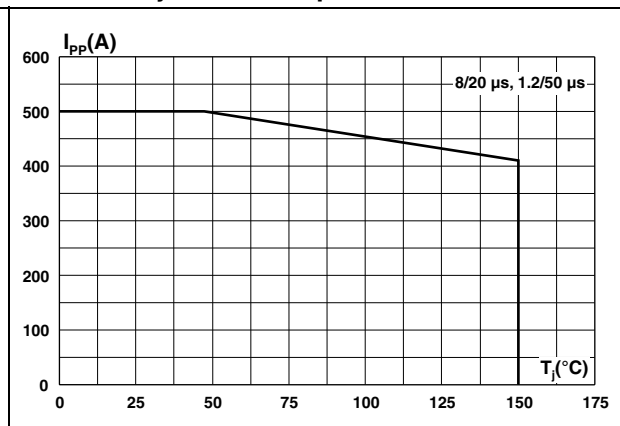

Figure 4. Clamping voltage at 500 A (1.2/50 μ s - 8/20 μ s)

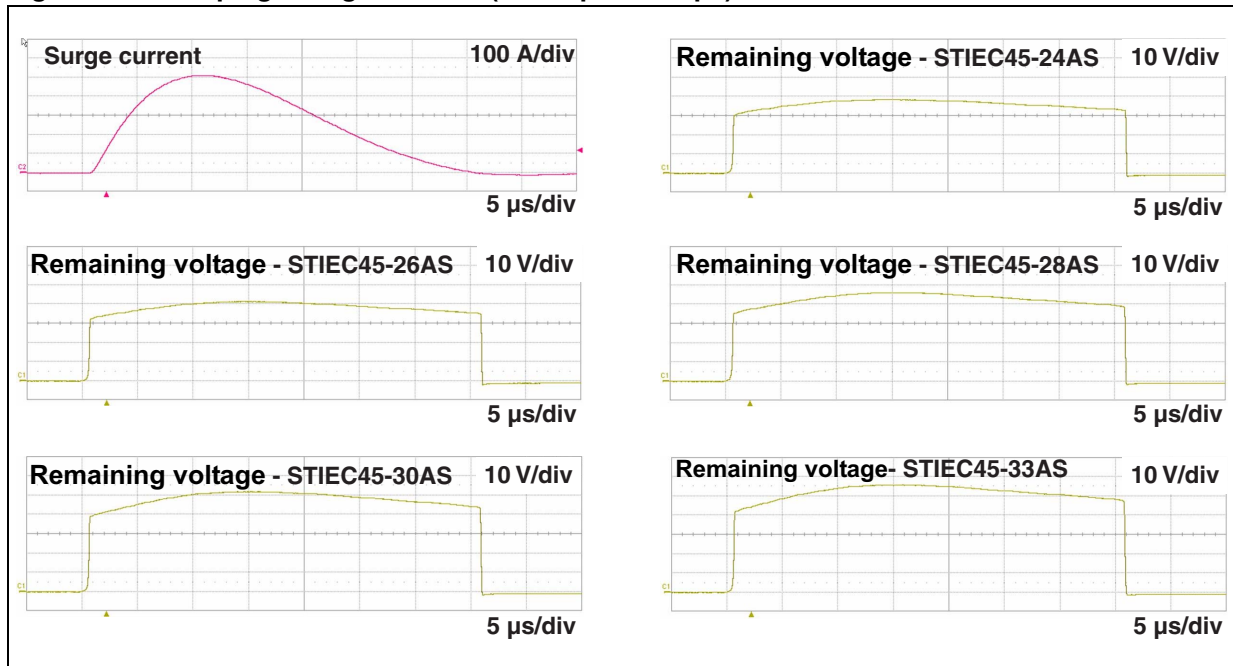

Figure 5. Junction capacitance versus reverse applied voltage (typical values)

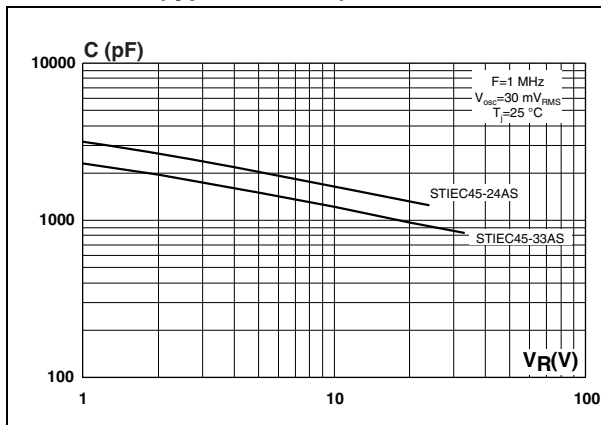

Figure 6. Peak forward voltage drop versus peak forward current (typical values)

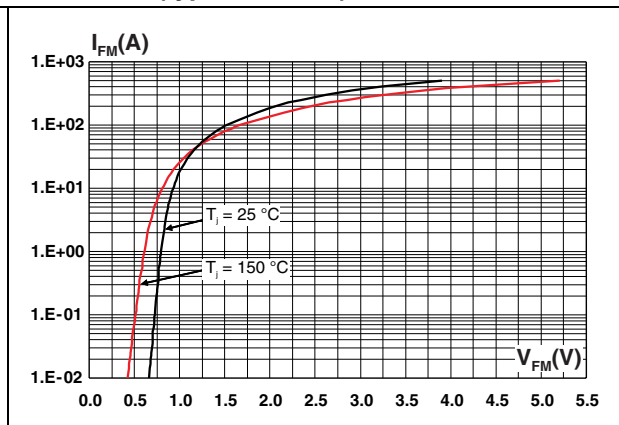

Figure 7. Relative variation of thermal impedance, junction to ambient, versus pulse duration

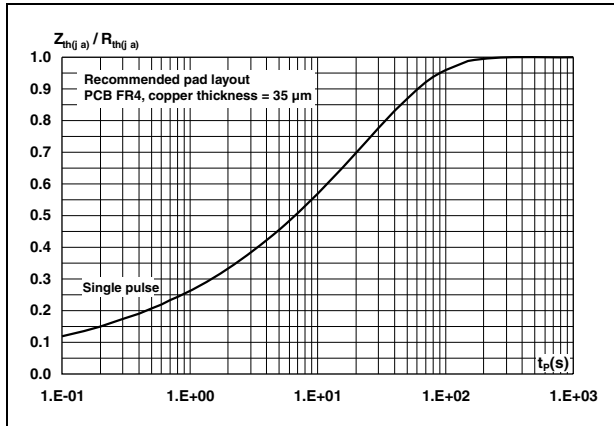

Figure 8. Thermal resistance junction to ambient versus copper surface under each lead

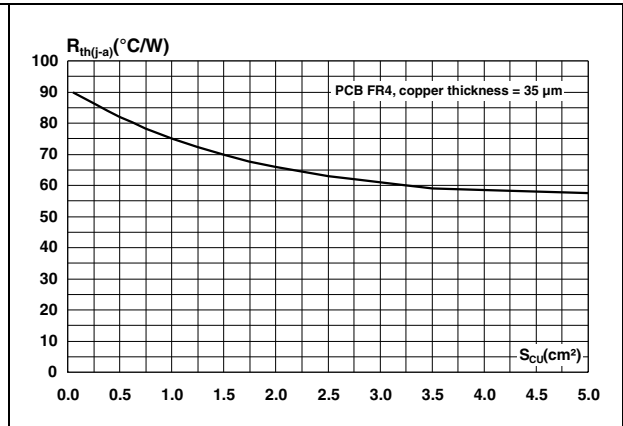
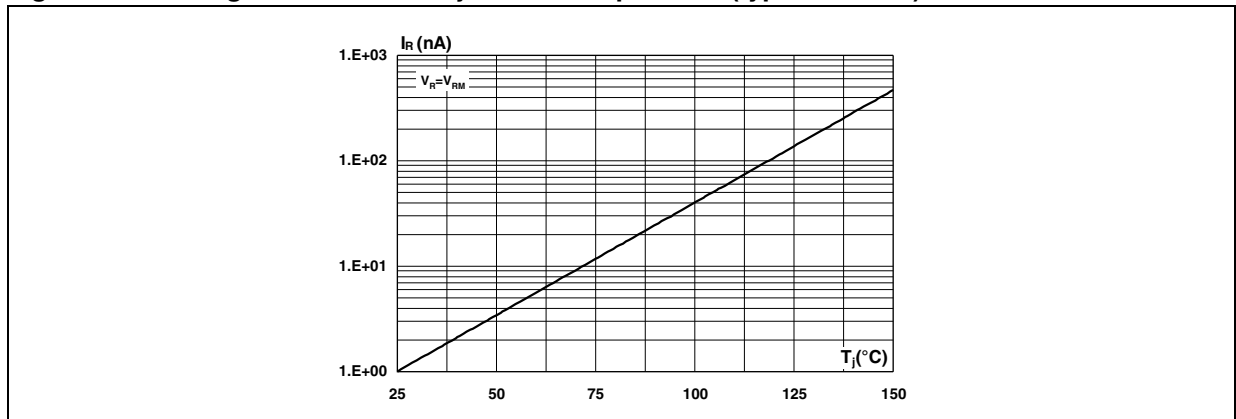
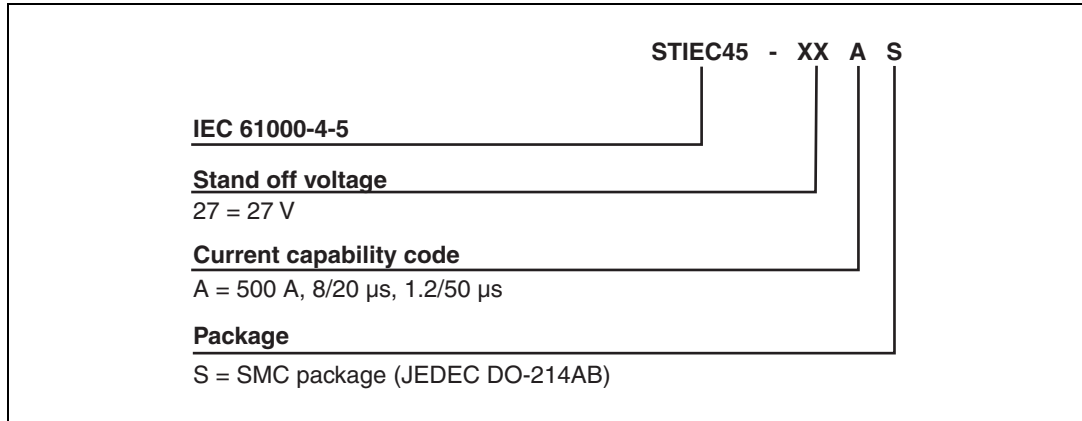

Figure 9. Leakage current versus junction temperature (typical values)



2 Ordering information scheme

Figure 10. Ordering information scheme



3 Package information

- Case: JEDEC DO-214AB molded plastic over planar junction
- Terminals: solder plated, solderable per MIL-STD-750, Method 2026
- Polarity: for unidirectional types the band indicates cathode
- Flammability: epoxy is rated UL94V-0
- RoHS package

In order to meet environmental requirements, ST offers these devices in different grades of ECOPACK® packages, depending on their level of environmental compliance. ECOPACK® specifications, grade definitions and product status are available at: www.st.com. ECOPACK® is an ST trademark.

Table 4. SMC dimensions

Ref.	Dimensions			
	Millimeters		Inches	
	Min.	Max.	Min.	Max.
A1	1.90	2.45	0.075	0.096
A2	0.05	0.20	0.002	0.008
b	2.90	3.2	0.114	0.126
c	0.15	0.41	0.006	0.016
E	7.75	8.15	0.305	0.321
E1	6.60	7.15	0.260	0.281
E2	4.40	4.70	0.173	0.185
D	5.55	6.25	0.218	0.246
L	0.75	1.60	0.030	0.063

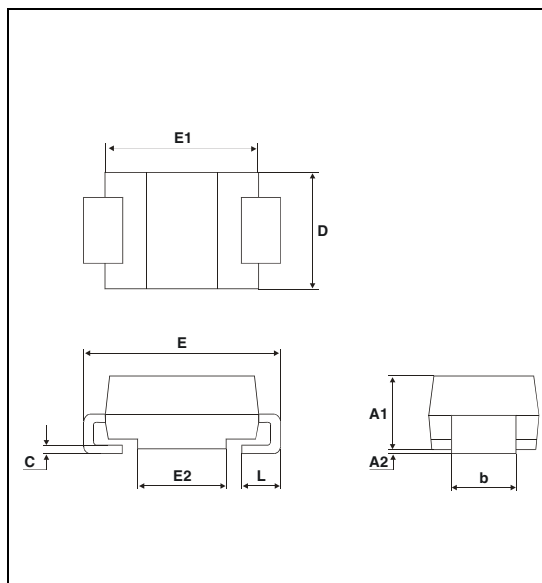
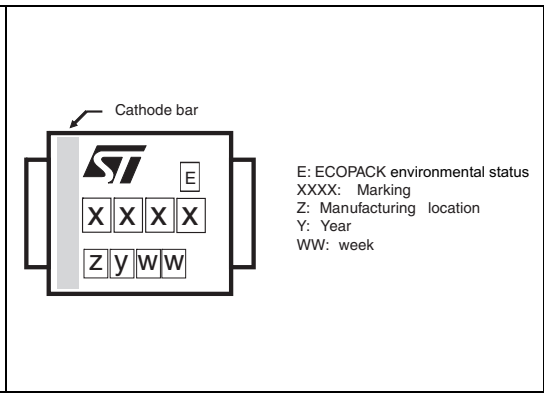
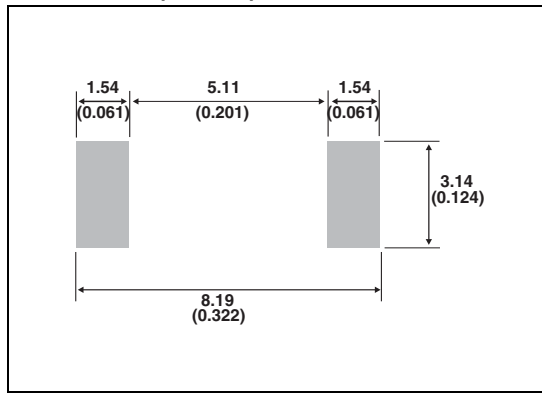

Figure 12. Marking layout

Figure 11. Footprint dimensions in mm (inches)

Figure 12. Marking layout



Note: Marking layout can vary according to assembly location.

4 Ordering information

Table 5. Ordering information

Order code	Marking	Package	Weight	Base qty	Delivery mode
STIEC45-24AS	4524A	SMC	0.25 g	2500	Tape and reel
STIEC45-26AS	4526A				
STIEC45-27AS	4527A				
STIEC45-28AS	4528A				
STIEC45-30AS	4530A				
STIEC45-33AS	4533A				

5 Revision history

Table 6. Document revision history

Date	Revision	Changes
07-Dec-2009	1	First issue.

Please Read Carefully:

Information in this document is provided solely in connection with ST products. STMicroelectronics NV and its subsidiaries ("ST") reserve the right to make changes, corrections, modifications or improvements, to this document, and the products and services described herein at any time, without notice.

All ST products are sold pursuant to ST's terms and conditions of sale.

Purchasers are solely responsible for the choice, selection and use of the ST products and services described herein, and ST assumes no liability whatsoever relating to the choice, selection or use of the ST products and services described herein.

No license, express or implied, by estoppel or otherwise, to any intellectual property rights is granted under this document. If any part of this document refers to any third party products or services it shall not be deemed a license grant by ST for the use of such third party products or services, or any intellectual property contained therein or considered as a warranty covering the use in any manner whatsoever of such third party products or services or any intellectual property contained therein.

UNLESS OTHERWISE SET FORTH IN ST'S TERMS AND CONDITIONS OF SALE ST DISCLAIMS ANY EXPRESS OR IMPLIED WARRANTY WITH RESPECT TO THE USE AND/OR SALE OF ST PRODUCTS INCLUDING WITHOUT LIMITATION IMPLIED WARRANTIES OF MERCHANTABILITY, FITNESS FOR A PARTICULAR PURPOSE (AND THEIR EQUIVALENTS UNDER THE LAWS OF ANY JURISDICTION), OR INFRINGEMENT OF ANY PATENT, COPYRIGHT OR OTHER INTELLECTUAL PROPERTY RIGHT.

UNLESS EXPRESSLY APPROVED IN WRITING BY AN AUTHORIZED ST REPRESENTATIVE, ST PRODUCTS ARE NOT RECOMMENDED, AUTHORIZED OR WARRANTED FOR USE IN MILITARY, AIR CRAFT, SPACE, LIFE SAVING, OR LIFE SUSTAINING APPLICATIONS, NOR IN PRODUCTS OR SYSTEMS WHERE FAILURE OR MALFUNCTION MAY RESULT IN PERSONAL INJURY, DEATH, OR SEVERE PROPERTY OR ENVIRONMENTAL DAMAGE. ST PRODUCTS WHICH ARE NOT SPECIFIED AS "AUTOMOTIVE GRADE" MAY ONLY BE USED IN AUTOMOTIVE APPLICATIONS AT USER'S OWN RISK.

Resale of ST products with provisions different from the statements and/or technical features set forth in this document shall immediately void any warranty granted by ST for the ST product or service described herein and shall not create or extend in any manner whatsoever, any liability of ST.

ST and the ST logo are trademarks or registered trademarks of ST in various countries.

Information in this document supersedes and replaces all information previously supplied.

The ST logo is a registered trademark of STMicroelectronics. All other names are the property of their respective owners.

© 2009 STMicroelectronics - All rights reserved

STMicroelectronics group of companies

Australia - Belgium - Brazil - Canada - China - Czech Republic - Finland - France - Germany - Hong Kong - India - Israel - Italy - Japan - Malaysia - Malta - Morocco - Philippines - Singapore - Spain - Sweden - Switzerland - United Kingdom - United States of America

www.st.com