

TINA-TAPE lenses for CREE XP-E LEDs

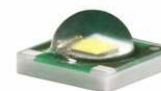

- Designed & optimized for Cree's XP-E series of LEDs
- Lens material optical grade PC with high UV and temperature resistance (130°C/220°F). Allows use of high current and temperature conditions
- Best available optical efficiency, over 90%, with an extremely good cutoff of light
- Fastening to heat sink with a PU foam adhesive tape of automotive grade (included)
- Compact dimensions 16.1 x 10.1 mm.

LENS TYPES

NAME	ORDERING CODE	FWHM Angle
TINA-XP REAL SPOT	FA10887_Tina-XP-RS	±5.5
TINA-XP DIFFUSER	FA10644_Tina-XP-D	±6.5°
TINA-XP MEDIUM	FA10645_Tina-XP-M	±15°
TINA-XP WIDE	FA10838_Tina-XP-W	±20°
TINA-XP OVAL	FA11200_Tina-XP-O	±17°x ±7°

© Ledil Oy – PRELIMINARY - Subject to change without prior notice

MEASUREMENTS

TINA-XP-RS

Relative Intensity of FA10887-Tina-XP-RS

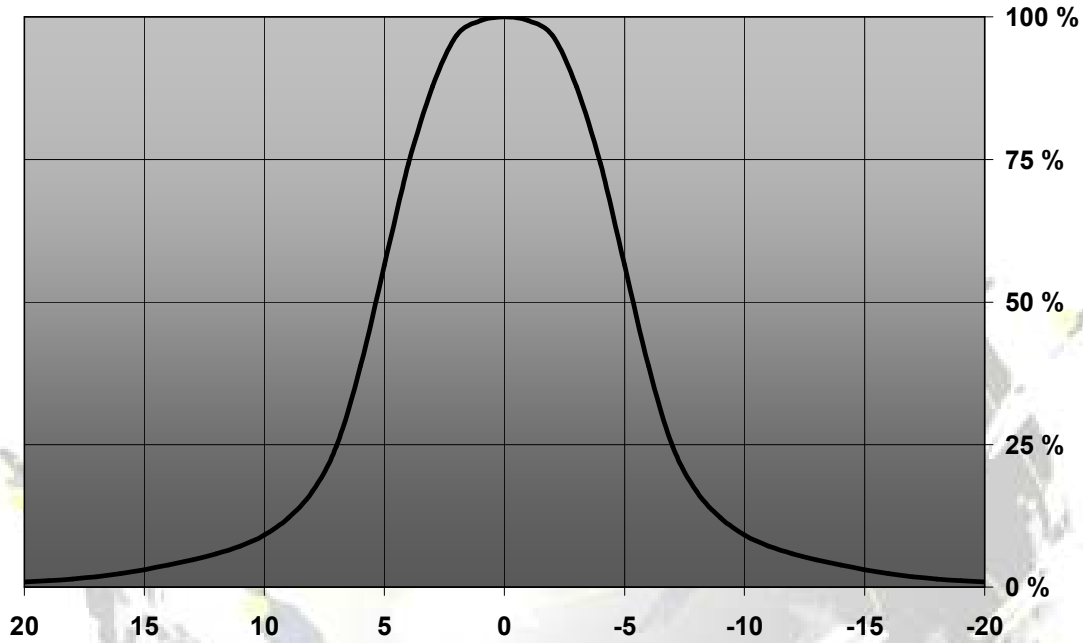

TINA-XP-D

Relative Intensity of Tina-XP-D

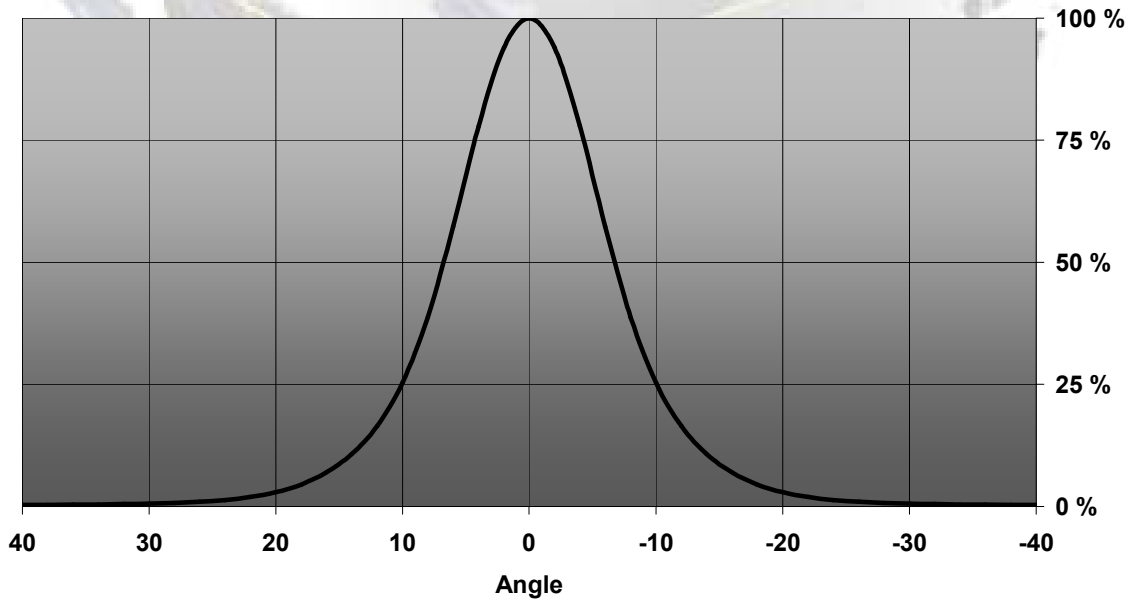

© Ledil Oy – PRELIMINARY - Subject to change without prior notice

TINA-XP-M

Relative Intensity of Tina-XP-M

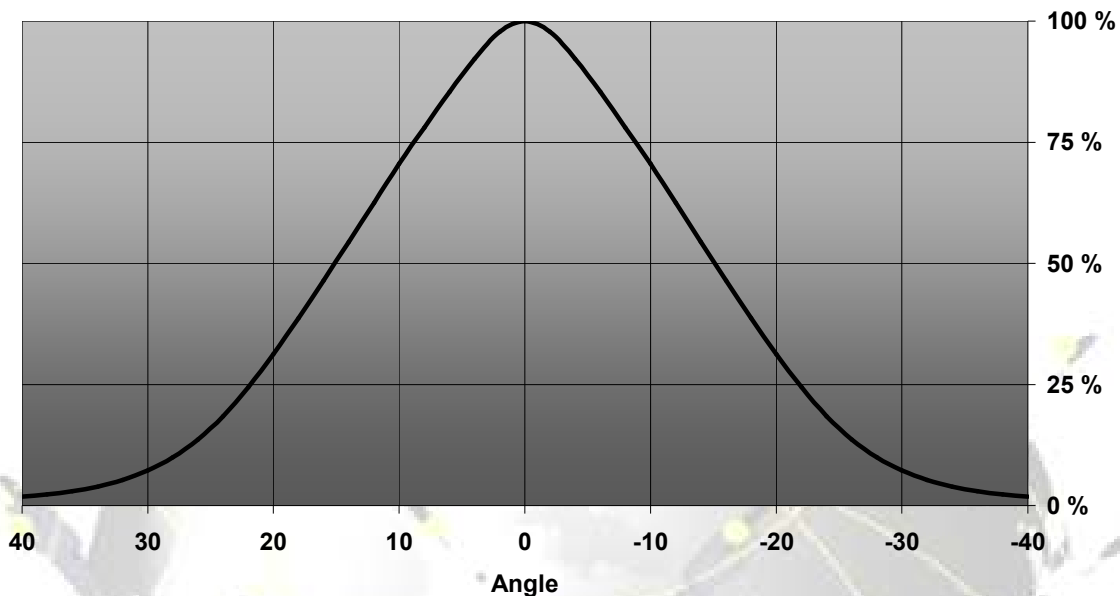

Relative Intensity of FA10838_Tina-XP-W

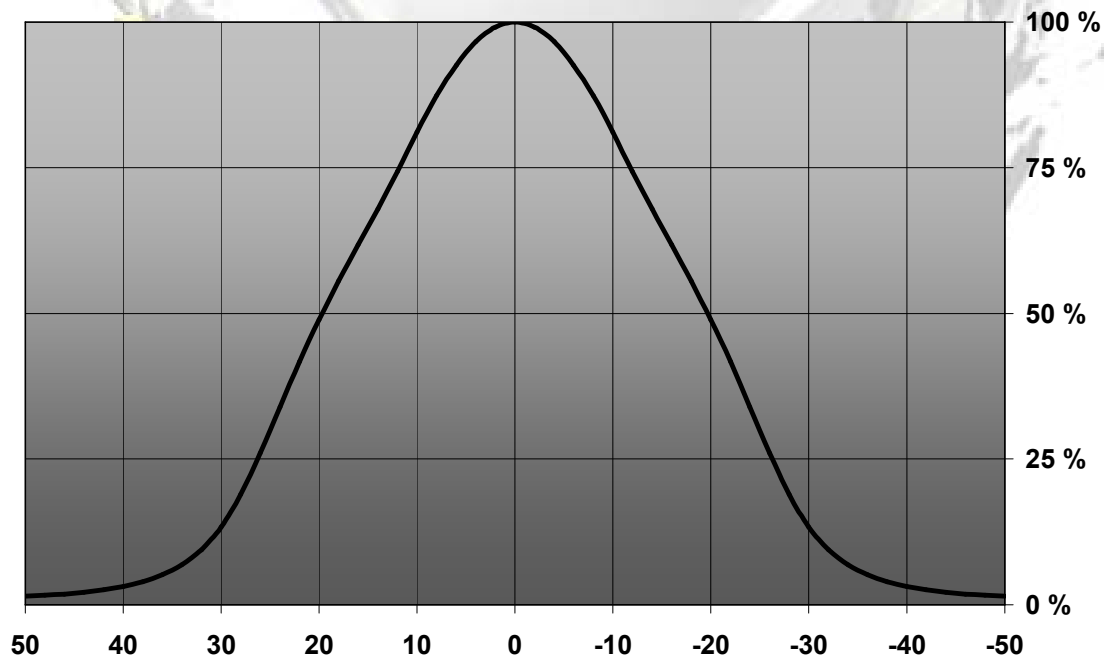

© Ledil Oy – PRELIMINARY - Subject to change without prior notice

Relative Intensity of FA11200_Tina-XP-O

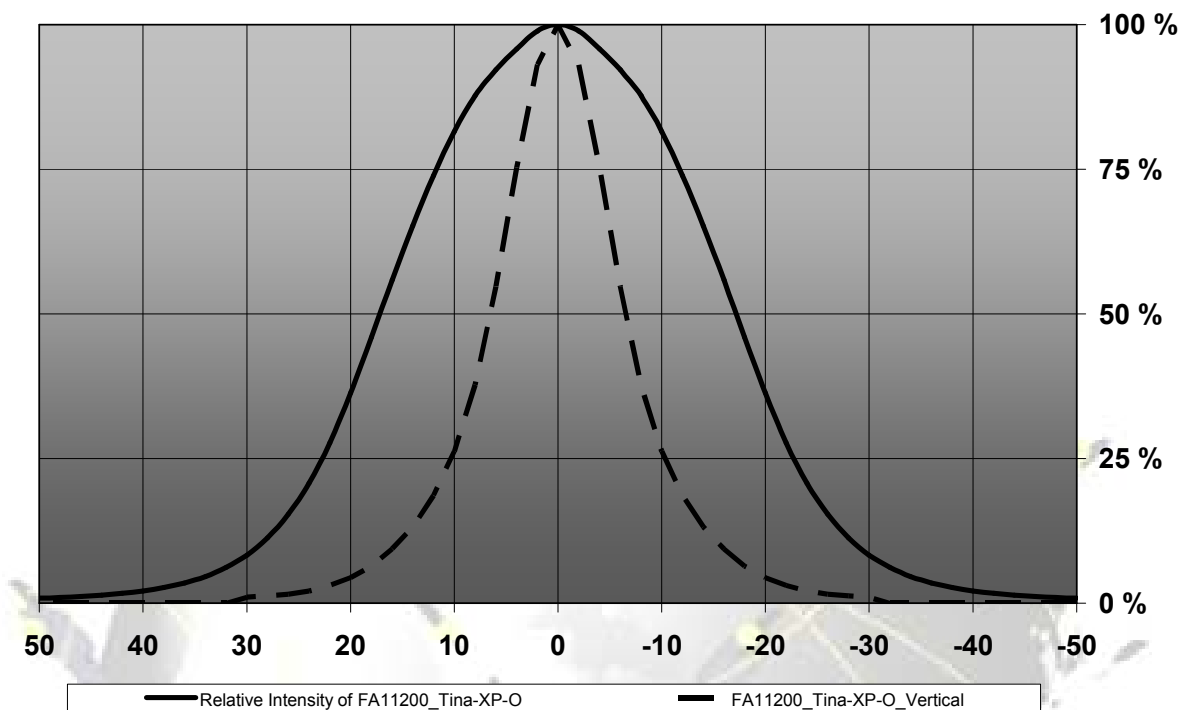

© Ledil Oy – PRELIMINARY - Subject to change without prior notice

DRAWINGS

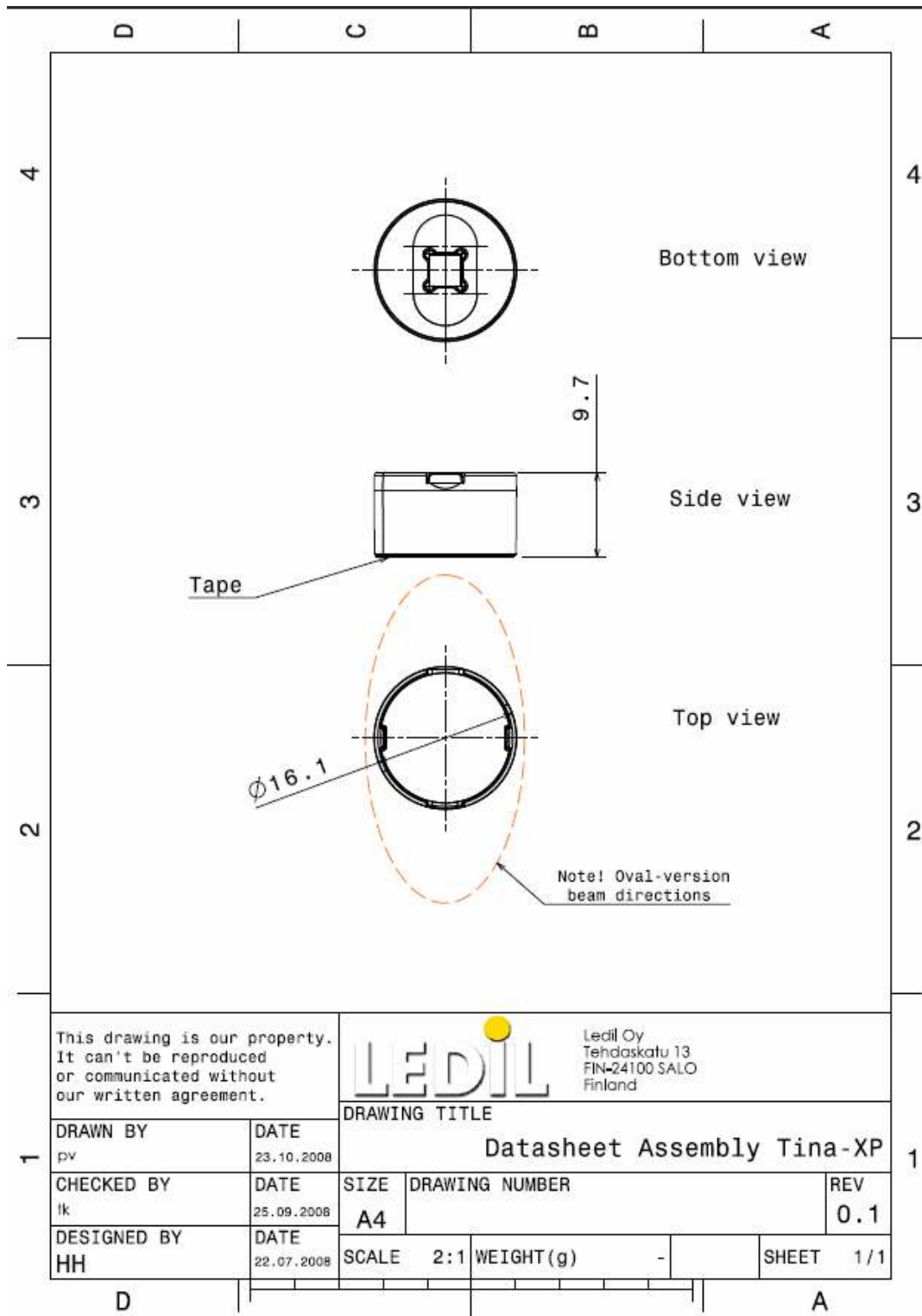

© Ledil Oy – PRELIMINARY - Subject to change without prior notice