

# TLC1078, TLC1078Y, TLC1079, TLC1079Y LinCMOS™ $\mu$ POWER PRECISION OPERATIONAL AMPLIFIERS

SLOS179 – FEBRUARY 1997

- Power Dissipation as Low as 10  $\mu$ W Typ Per Amplifier
- Operates on a Single Silver-Oxide Watch Battery,  $V_{DD} = 1.4$  V Min
- $V_{IO} \dots 450 \mu\text{V}/850 \mu\text{V}$  Max in DIP and Small-Outline Package (TLC1078/79)
- Input Offset Voltage Drift  $\dots 0.1 \mu\text{V}/\text{Month}$  Typ, Including the First 30 Days
- High-impedance LinCMOS™ Inputs  
 $I_{IB} = 0.6$  pA Typ
- High Open-Loop Gain  $\dots 800000$  Typ
- Output Drive Capability > 20 mA
- Slew Rate  $\dots 47$  V/ms Typ
- Common-Mode Input Voltage Range Extends Below the Negative Rail
- Output Voltage Range Includes Negative Rail
- On-Chip ESD-Protection Circuitry
- Small-Outline Package Option Also Available in Tape and Reel

## description

The TLC107x operational amplifiers offer ultra-low offset voltage, high gain, 110-kHz bandwidth, 47-V/ms slew rate, and just 150- $\mu$ W power dissipation per amplifier.

With a supply voltage of 1.4 V, common-mode input to the negative rail, and output swing to the negative rail, the TLC107xC is an ideal solution for low-voltage battery-operated systems. The 20-mA output drive capability means that the TLC107x can easily drive small resistive and large capacitive loads when needed, while maintaining ultra-low standby power dissipation.

Since this device is functionally compatible as well as pin compatible with the TLC27L2/4 and TLC27L7/9, the TLC107x easily upgrades existing designs that can benefit from its improved performance.

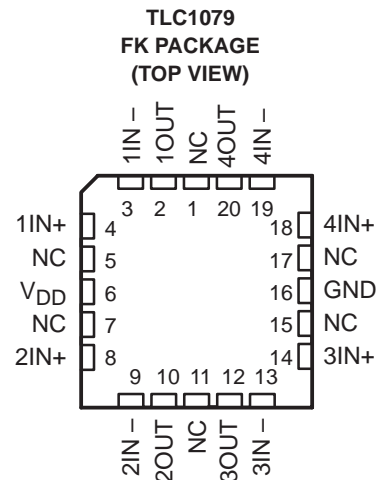
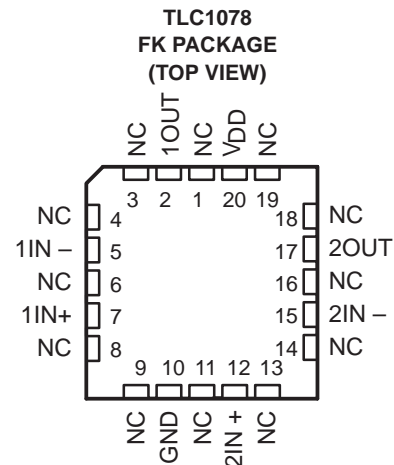
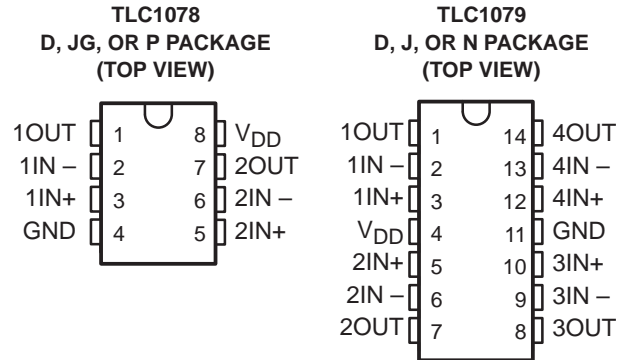

NC – No internal connection



Please be aware that an important notice concerning availability, standard warranty, and use in critical applications of Texas Instruments semiconductor products and disclaimers thereto appears at the end of this data sheet.

LinCMOS is a trademark of Texas Instruments Incorporated.

PRODUCTION DATA information is current as of publication date. Products conform to specifications per the terms of Texas Instruments standard warranty. Production processing does not necessarily include testing of all parameters.



Copyright © 1997, Texas Instruments Incorporated

**description (continued)**

The TLC107x incorporates internal ESD-protection circuits that will prevent functional failures at voltages up to 2000 V as tested under MIL-PRF-38535, Method 3015.2; however, care should be exercised when handling these devices as exposure to ESD may result in degradation of the device parametric performance. The TLC107x design also inhibits latch-up of the device inputs and outputs even with surge currents as large 100 mA.

The C-suffix devices are characterized for operation from 0°C to 70°C. The I-suffix devices are characterized for operation from -40°C to 85°C. The M-suffix devices are characterized for operation over the full military temperature range of -55°C to 125°C. The wide range of packaging options includes small-outline and chip-carrier versions for high-density system applications.

**AVAILABLE OPTIONS**

T <sub>A</sub>	PACKAGED DEVICES						CHIP FORM‡ (Y)
	SMALL OUTLINE† (D)	CHIP CARRIER (FK)	CERAMIC DIP (J)	CERAMIC DIP (JG)	PLASTIC DIP (N)	PLASTIC DIP (P)	
0°C to 70°C	TLC1078CD TLC1079CD	—	—	—	TLC1079CN	TLC1078CP	TLC1078Y TLC1079Y
-40°C to 85°C	TLC1078ID TLC1079ID	—	—	—	TLC1079IN	TLC1078IP	—
-55°C to 125°C	TLC1078MD TLC1079MD	TLC1078MFK TLC1079MFK	TLC1079MJ	TLC1078MJG	TLC1079MN	TLC1078MP	—

† The D package is available taped and reeled. Add the suffix R to the device type (e.g., TLC1078CDR).

‡ Chip forms are tested 25°C only.

**symbol (each amplifier)**

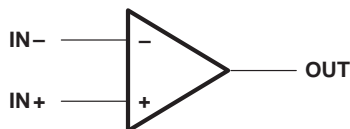

### TLC1087Y chip information

This chip, when properly assembled, displays characteristics similar to the TLC1078C. Thermal compression or ultrasonic bonding may be used on the doped-aluminum bonding pads. Chips can be mounted with conductive epoxy or a gold-silicon preform.

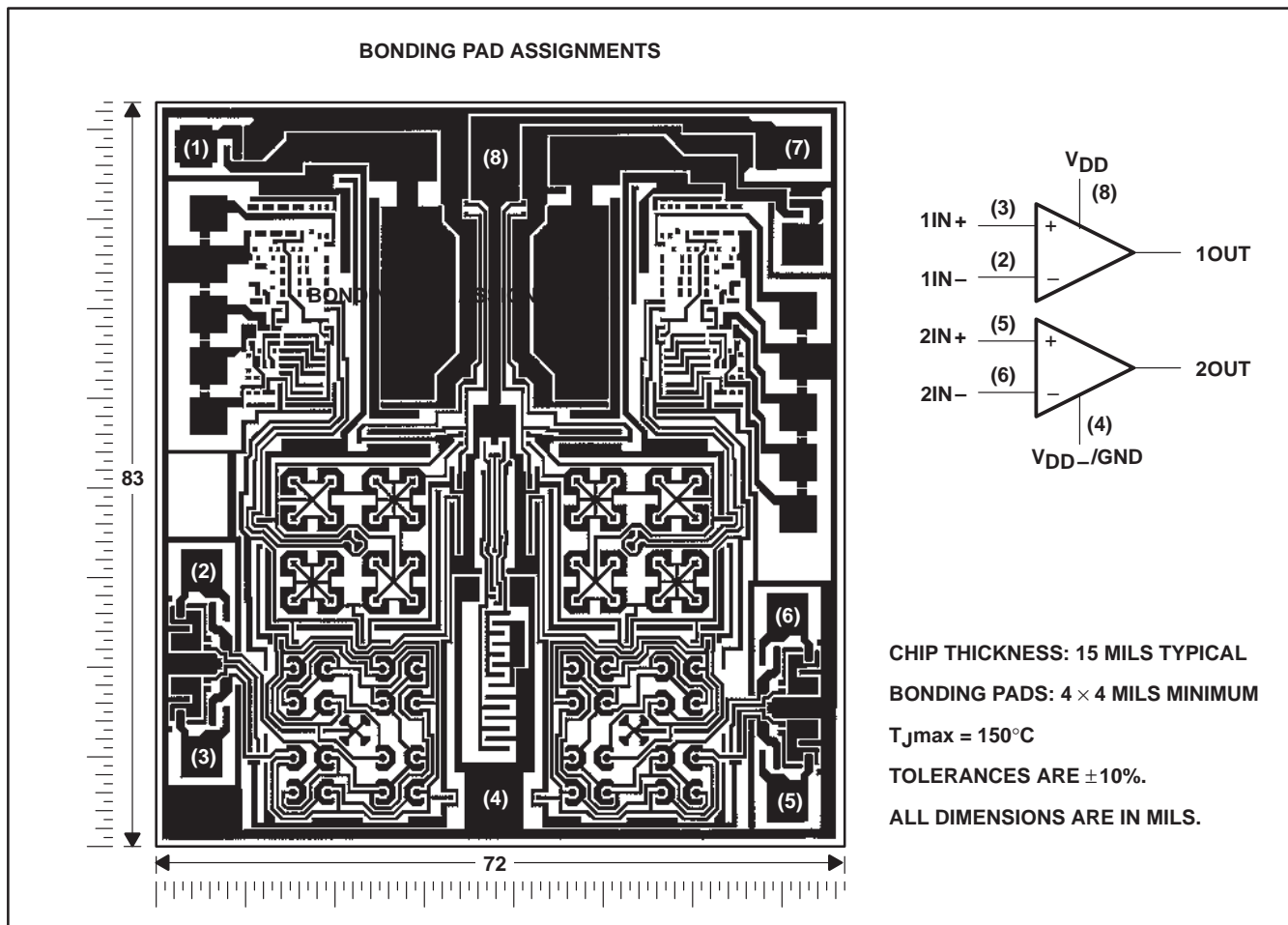

**TLC1079Y chip information**

This chip, when properly assembled, display characteristics similar to the TLC1079C. Thermal compression or ultrasonic bonding may be used on the doped-aluminum bonding pads. Chips can be mounted with conductive epoxy or a gold-silicon preform.

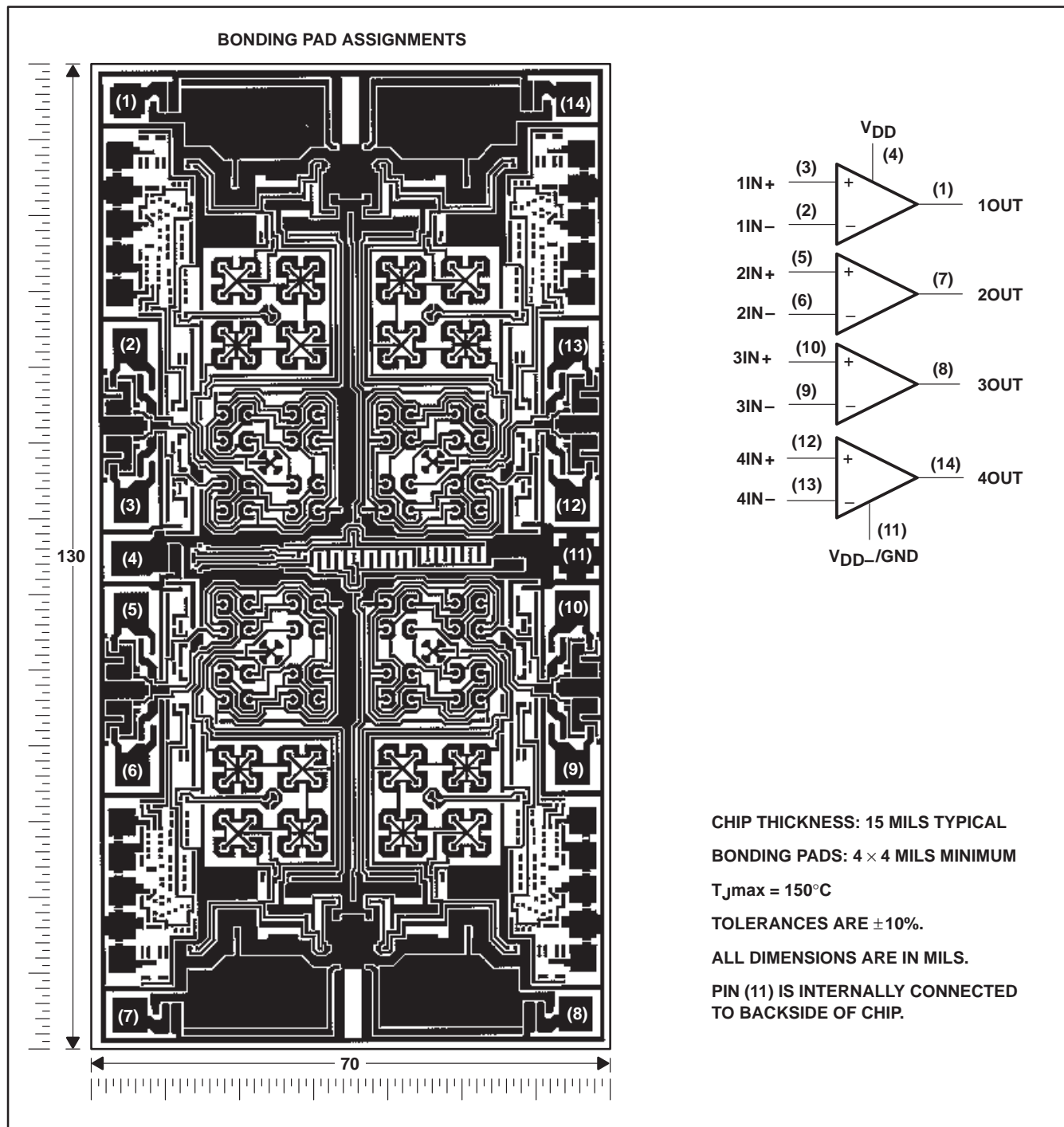

equivalent schematic (each amplifier)

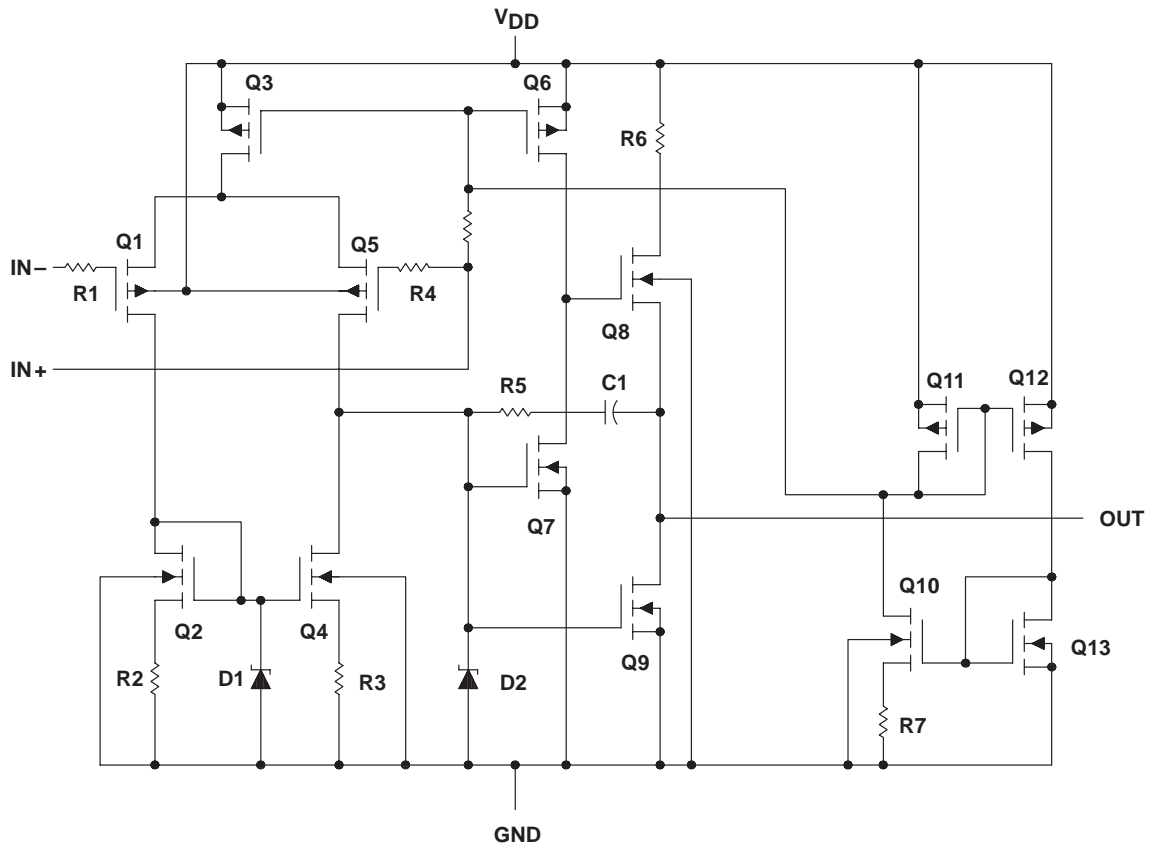

ACTUAL DEVICE COMPONENT COUNT		
COMPONENT	TLC1078	TLC1079
Transistors	38	76
Resistors	16	32
Diodes	12	24
Capacitors	2	4

**absolute maximum ratings over operating free-air temperature range (unless otherwise noted)†**

Supply voltage, $V_{DD}$ (see Note 1)	18 V
Differential input voltage, $V_{ID}$ (see Note 2)	$\pm V_{DD}$
Input voltage range, $V_I$ (any input)	-0.3 V to $V_{DD}$
Input current, $I_I$ (each input)	$\pm 5$ mA
Output current, $I_O$ (each output)	$\pm 30$ mA
Total current into $V_{DD}$ (see Note 3)	45 mA
Duration of short-circuit at (or below) $T_A = 25^\circ\text{C}$ (see Note 3)	unlimited
Continuous total power dissipation	see Dissipation Rating Table
Operating free-air temperature range, $T_A$ : C suffix	$0^\circ\text{C}$ to $70^\circ\text{C}$
I suffix	$-40^\circ\text{C}$ to $85^\circ\text{C}$
M suffix	$-55^\circ\text{C}$ to $125^\circ\text{C}$
Storage temperature range	$-65^\circ\text{C}$ to $150^\circ\text{C}$
Case temperature for 60 seconds: FK package	$260^\circ\text{C}$
Lead temperature 1,6 mm (1/16 inch) from case for 10 seconds: D or P package	$260^\circ\text{C}$
Lead temperature 1,6 mm (1/16 inch) from case for 60 seconds: JG package	$300^\circ\text{C}$

† Stresses beyond those listed under “absolute maximum ratings” may cause permanent damage to the device. These are stress ratings only, and functional operation of the device at these or any other conditions beyond those indicated under “recommended operating conditions” is not implied. Exposure to absolute-maximum-rated conditions for extended periods may affect device reliability.

- NOTES:
1. All voltage values, except differential voltages, are with respect to network ground.
  2. Differential voltages are at  $IN+$  with respect to  $IN-$ .
  3. The output may be shorted to either supply. Temperature and/or supply voltages must be limited to ensure that the maximum dissipation ratings are not exceeded.

**DISSIPATION RATING TABLE**

PACKAGE	$T_A \leq 25^\circ\text{C}$ POWER RATING	DERATING FACTOR ABOVE $T_A = 25^\circ\text{C}$	$T_A = 70^\circ\text{C}$ POWER RATING	$T_A = 85^\circ\text{C}$ POWER RATING	$T_A = 125^\circ\text{C}$ POWER RATING
D-8	725 mW	5.8 mW/ $^\circ\text{C}$	464 mW	377 mW	145 mW
D-14	950 mW	7.6 mW/ $^\circ\text{C}$	608 mW	494 mW	190 mW
FK	1375 mW	11.0 mW/ $^\circ\text{C}$	880 mW	715 mW	275 mW
J	1375 mW	11.0 mW/ $^\circ\text{C}$	880 mW	715 mW	275 mW
JG	1050 mW	8.4 mW/ $^\circ\text{C}$	672 mW	546 mW	210 mW
N	1150 mW	9.2 mW/ $^\circ\text{C}$	736 mW	598 mW	230 mW
P	1000 mW	8.0 mW/ $^\circ\text{C}$	640 mW	520 mW	200 mW

**recommended operating conditions**

	C SUFFIX		I SUFFIX		M SUFFIX		UNIT
	MIN	MAX	MIN	MAX	MIN	MAX	
Supply voltage, $V_{DD}$	1.4	16	3	16	4	16	V
Common-mode input voltage, $V_{IC}$	$V_{DD} = 5$ V		-0.2	4	-0.2	4	V
	$V_{DD} = 10$ V		-0.2	9	-0.2	9	
Operating free-air temperature, $T_A$	0	70	-40	85	-55	125	$^\circ\text{C}$



electrical characteristics at specified free-air temperature

PARAMETER	TEST CONDITIONS	T <sub>A</sub> †	TLC1078C						UNIT	
			V <sub>DD</sub> = 5 V			V <sub>DD</sub> = 10 V				
			MIN	TYP	MAX	MIN	TYP	MAX		
V <sub>IO</sub>	Input offset voltage	V <sub>O</sub> = 1.4 V, R <sub>S</sub> = 50 $\Omega$ , V <sub>IC</sub> = 0, R <sub>I</sub> = 1 M $\Omega$	25°C	160	450		180	600	$\mu$ V	
		Full range			800			950		
$\alpha$ V <sub>IO</sub>	Temperature coefficient of input offset voltage		25°C to 70°C	1.1			1		$\mu$ V/°C	
I <sub>IO</sub>	Input offset current (see Note 4)	V <sub>O</sub> = V <sub>DD</sub> /2, V <sub>IC</sub> = V <sub>DD</sub> /2	25°C	0.1			0.1		pA	
			70°C	7	300		7	300		
I <sub>IB</sub>	Input bias current (see Note 4)		25°C	0.6			0.7		pA	
			70°C	40	600		50	600		
V <sub>ICR</sub>	Common-mode input voltage range (see Note 5)		25°C	-0.2 to 4	-0.3 to 4.2		-0.2 to 9	-0.3 to 9.2	V	
			Full range	-0.2 to 3.5			-0.2 to 8.5		V	
V <sub>OH</sub>	High-level output voltage	V <sub>ID</sub> = 100 mV, R <sub>L</sub> = 1 M $\Omega$	25°C	3.2	4.1		8.2	8.9	V	
				0°C	3.2	4.1		8.2		8.9
				70°C	3.2	4.2		8.2		8.9
V <sub>OL</sub>	Low-level output voltage	V <sub>ID</sub> = -100 mV, I <sub>OL</sub> = 0	25°C	0 25			0 25		mV	
				0°C	0 25			0 25		
				70°C	0 25			0 25		
A <sub>VD</sub>	Large-signal differential voltage amplification	R <sub>L</sub> = 1 M $\Omega$ , See Note 6	25°C	250	525		500	850	V/mV	
				0°C	250	680		500		1010
				70°C	200	380		350		660
CMRR	Common-mode rejection ratio	V <sub>IC</sub> = V <sub>ICRmin</sub>	25°C	70	95		75	97	dB	
				0°C	70	95		75		97
				70°C	70	95		75		97
k <sub>SVR</sub>	Supply-voltage rejection ratio ( $\Delta$ V <sub>DD</sub> / $\Delta$ V <sub>IO</sub> )	V <sub>O</sub> = 1.4 V	25°C	75	98		75	98	dB	
				0°C	75	98		75		98
				70°C	75	98		75		98
I <sub>DD</sub>	Supply current (two amplifiers)	V <sub>O</sub> = V <sub>DD</sub> /2, V <sub>IC</sub> = V <sub>DD</sub> /2, No load	25°C	20	34		29	46	$\mu$ A	
				0°C	24	42		36		66
				70°C	16	28		22		40

† Full range is 0°C to 70°C.

- NOTES: 4. The typical values of input bias current and input offset current below 5 pA were determined mathematically.  
 5. This range also applies to each input individually.  
 6. At V<sub>DD</sub> = 5 V, V<sub>O</sub> = 0.25 V to 2 V; at V<sub>DD</sub> = 10 V, V<sub>O</sub> = 1 V to 6 V.

TLC1078, TLC1078Y, TLC1079, TLC1079Y  
**LinCMOS™**  $\mu$ POWER PRECISION  
**OPERATIONAL AMPLIFIERS**

SLOS179 – FEBRUARY 1997

**electrical characteristics at specified free-air temperature**

PARAMETER	TEST CONDITIONS	$T_A$ †	TLC1079C						UNIT
			$V_{DD} = 5\text{ V}$			$V_{DD} = 10\text{ V}$			
			MIN	TYP	MAX	MIN	TYP	MAX	
$V_{IO}$ Input offset voltage	$V_O = 1.4\text{ V}$ , $V_{IC} = 0$ , $R_S = 50\ \Omega$ , $R_I = 1\text{ M}\Omega$	25°C	190	850		200	1150	$\mu\text{V}$	
Full range			1200		1500				
$\alpha_{VIO}$ Temperature coefficient of input offset voltage		25°C to 70°C	1.1			1			$\mu\text{V}/^\circ\text{C}$
$I_{IO}$ Input offset current (see Note 4)	$V_O = V_{DD}/2$ , $V_{IC} = V_{DD}/2$	25°C	0.1			0.1			$\text{pA}$
		70°C	7	300		7	300		
$I_{IB}$ Input bias current (see Note 4)		25°C	0.6			0.7			$\text{pA}$
	70°C	40	600		50	600			
$V_{ICR}$ Common mode input voltage range (see Note 5)		25°C	-0.2 to 4	-0.3 to 4.2		-0.2 to 9	-0.3 to 9.2	V	
	Full range		-0.2 to 3.5			-0.2 to 8.5		V	
$V_{OH}$ High-level output voltage	$V_{ID} = 100\text{ mV}$ , $R_L = 1\text{ M}\Omega$	25°C	3.2	4.1		8.2	8.9	V	
		0°C	3.2	4.1		8.2	8.9		
		70°C	3.2	4.2		8.2	8.9		
$V_{OL}$ Low-level output voltage	$V_{ID} = -100\text{ mV}$ , $I_{OL} = 0$	25°C	0 25			0 25		mV	
		0°C	0 25			0 25			
		70°C	0 25			0 25			
$A_{VD}$ Large-signal differential voltage amplification	$R_L = 1\text{ M}\Omega$ , See Note 6	25°C	250	525		500	850	V/mV	
		0°C	250	700		500	1010		
		70°C	200	380		350	660		
CMRR Common mode rejection ratio	$V_{IC} = V_{ICRmin}$	25°C	70	95		75	97	dB	
		0°C	70	95		75	97		
		70°C	70	95		75	97		
$k_{SVR}$ Supply-voltage rejection ratio ( $\Delta V_{DD}/\Delta V_{IO}$ )	$V_{DD} = 5\text{ V to }10\text{ V}$ , $V_O = 1.4\text{ V}$	25°C	75	98		75	98	dB	
		0°C	75	98		75	98		
		70°C	75	98		75	98		
$I_{DD}$ Supply current (four amplifiers)	$V_O = V_{DD}/2$ , $V_{IC} = V_{DD}/2$ , No load	25°C	40	68		57	92	$\mu\text{A}$	
		0°C	48	84		72	132		
		70°C	31	56		44	80		

† Full range is 0°C to 70°C.

- NOTES: 4. The typical values of input bias current and input offset current below 5 pA were determined mathematically.  
5. This range also applies to each input individually.  
6. At  $V_{DD} = 5\text{ V}$ ,  $V_O = 0.25\text{ V to }2\text{ V}$ ; at  $V_{DD} = 10\text{ V}$ ,  $V_O = 1\text{ V to }6\text{ V}$ .





operating characteristics at specified free-air temperature

PARAMETER	TEST CONDITIONS	T <sub>A</sub>	TLC1078C						UNIT
			V <sub>DD</sub> = 5 V			V <sub>DD</sub> = 10 V			
			MIN	TYP	MAX	MIN	TYP	MAX	
SR Slew rate at unity gain	R <sub>L</sub> = 1 M $\Omega$ , C <sub>L</sub> = 20 pF, V <sub>I(PP)</sub> = 1 V, See Figure 1	25°C	32			47			V/ms
		0°C	35			51			
		70°C	27			38			
V <sub>n</sub> Equivalent input noise voltage	f = 1 kHz, R <sub>S</sub> = 20 $\Omega$	25°C	68			68			nV/ $\sqrt{\text{Hz}}$
B <sub>1</sub> Unity-gain bandwidth	C <sub>L</sub> = 20 pF, See Figure 2	25°C	85			110			kHz
		0°C	100			125			
		70°C	65			90			
$\phi_m$ Phase margin at unity gain	C <sub>L</sub> = 20 pF, See Figure 2	25°C	34°			38°			
		0°C	36°			40°			
		70°C	30°			34°			

operating characteristics at specified free-air temperature

PARAMETER	TEST CONDITIONS	T <sub>A</sub>	TLC1079C						UNIT
			V <sub>DD</sub> = 5 V			V <sub>DD</sub> = 10 V			
			MIN	TYP	MAX	MIN	TYP	MAX	
SR Slew rate at unity gain	R <sub>L</sub> = 1 M $\Omega$ , C <sub>L</sub> = 20 pF, V <sub>I(PP)</sub> = 1 V, See Figure 1	25°C	32			47			V/ms
		0°C	35			51			
		70°C	27			38			
V <sub>n</sub> Equivalent input noise voltage	f = 1 kHz, R <sub>S</sub> = 20 $\Omega$	25°C	68			68			nV/ $\sqrt{\text{Hz}}$
B <sub>1</sub> Unity-gain bandwidth	C <sub>L</sub> = 20 pF, See Figure 2	25°C	85			110			kHz
		0°C	100			125			
		70°C	65			90			
$\phi_m$ Phase margin at unity gain	C <sub>L</sub> = 20 pF, See Figure 2	25°C	34°			38°			
		0°C	36°			40°			
		70°C	30°			34°			

electrical characteristics at specified free-air temperature

PARAMETER	TEST CONDITIONS	T <sub>A</sub> †	TLC1078I						UNIT
			V <sub>DD</sub> = 5 V			V <sub>DD</sub> = 10 V			
			MIN	TYP	MAX	MIN	TYP	MAX	
V <sub>IO</sub>	Input offset voltage	V <sub>O</sub> = 1.4 V, R <sub>S</sub> = 50 Ω, V <sub>IC</sub> = 0, R <sub>I</sub> = 1 MΩ	25°C	160	450	180	600	μV	
	Full range			950		1100			
α <sub>VIO</sub>	Temperature coefficient of input offset voltage		25°C to 85°C	1.1		1		μV/°C	
I <sub>IO</sub>	Input offset current (see Note 4)	V <sub>O</sub> = V <sub>DD</sub> / 2, V <sub>IC</sub> = V <sub>DD</sub> / 2	25°C	0.1		0.1		pA	
			85°C	24	1000	26	1000		
I <sub>IB</sub>	Input bias current (see Note 4)		25°C	0.6		0.7		pA	
		85°C	200	2000	220	2000			
V <sub>ICR</sub>	Common-mode input voltage range (see Note 5)		25°C	-0.2 to 4	-0.3 to 4.2	-0.2 to 9	-0.3 to 9.2	V	
			Full range	-0.2 to 3.5		-0.2 to 8.5		V	
V <sub>OH</sub>	High-level output voltage	V <sub>ID</sub> = 100 mV, R <sub>L</sub> = 1 MΩ	25°C	3.2	4.1	8.2	8.9	V	
			-40°C	3.2	4.1	8.2	8.9		
			85°C	3.2	4.2	8.2	8.9		
V <sub>OL</sub>	Low-level output voltage	V <sub>ID</sub> = -100 mV, I <sub>OL</sub> = 0	25°C	0	25	0	25	mV	
			-40°C	0	25	0	25		
			85°C	0	25	0	25		
A <sub>VD</sub>	Large-signal differential voltage amplification	R <sub>L</sub> = 1 MΩ, See Note 6	25°C	250	525	500	850	V/mV	
			-40°C	250	900	500	1550		
			85°C	150	300	250	585		
CMRR	Common-mode rejection ratio	V <sub>IC</sub> = V <sub>ICR</sub> min	25°C	70	95	75	97	dB	
			-40°C	70	95	75	97		
			85°C	70	95	75	97		
k <sub>SVR</sub>	Supply-voltage rejection ratio (ΔV <sub>DD</sub> /ΔV <sub>IO</sub> )	V <sub>O</sub> = 1.4 V	25°C	75	98	75	98	dB	
			-40°C	75	98	75	98		
			85°C	75	98	75	98		
I <sub>DD</sub>	Supply current (two amplifiers)	V <sub>O</sub> = V <sub>DD</sub> / 2, V <sub>IC</sub> = V <sub>DD</sub> / 2, No load	25°C	20	34	29	46	μA	
			-40°C	31	54	50	86		
			85°C	15	26	20	36		

† Full range is -40°C to 80°C.

NOTES: 4. The typical values of input bias current and input offset current below 5 pA were determined mathematically.

5. This range also applies to each input individually.

6. At V<sub>DD</sub> = 5 V, V<sub>O</sub> = 0.25 V to 2 V; at V<sub>DD</sub> = 10 V, V<sub>O</sub> = 1 V to 6 V.



electrical characteristics at specified free-air temperature

PARAMETER	TEST CONDITIONS	T <sub>A</sub> †	TLC1079I						UNIT
			V <sub>DD</sub> = 5 V			V <sub>DD</sub> = 10 V			
			MIN	TYP	MAX	MIN	TYP	MAX	
V <sub>IO</sub>	Input offset voltage	V <sub>O</sub> = 1.4 V, V <sub>IC</sub> = 0, R <sub>S</sub> = 50 $\Omega$ , R <sub>I</sub> = 1 M $\Omega$	25°C	190 850		200 1150		$\mu$ V	
	Full range		1350		1650				
$\alpha$ V <sub>IO</sub>	Temperature coefficient of input offset voltage		25°C to 85°C	1.1		1		$\mu$ V/°C	
I <sub>IO</sub>	Input offset current (see Note 4)	V <sub>O</sub> = V <sub>DD</sub> / 2, V <sub>IC</sub> = V <sub>DD</sub> / 2	25°C	0.1		0.1		pA	
			85°C	24	1000	26	1000		
I <sub>IB</sub>	Input bias current (see Note 4)		25°C	0.6		0.7		pA	
		85°C	200	2000	220	2000			
V <sub>ICR</sub>	Common-mode input voltage range (see Note 5)		25°C	-0.2 to 4	-0.3 to 4.2	-0.2 to 9	-0.3 to 9.2	V	
			Full range	-0.2 to 3.5		-0.2 to 8.5		V	
V <sub>OH</sub>	High-level output voltage	V <sub>ID</sub> = 100 mV, R <sub>L</sub> = 1 M $\Omega$	25°C	3.2	4.1	8.2	8.9	V	
			-40°C	3.2	4.1	8.2	8.9		
			85°C	3.2	4.2	8.2	8.9		
V <sub>OL</sub>	Low-level output voltage	V <sub>ID</sub> = -100 mV, I <sub>OL</sub> = 0	25°C	0 25		0 25		mV	
			-40°C	0 25		0 25			
			85°C	0 25		0 25			
A <sub>VD</sub>	Large-signal differential voltage amplification	R <sub>L</sub> = 1 M $\Omega$ , See Note 6	25°C	250	525	500	850	V/mV	
			-40°C	250	900	500	1550		
			85°C	150	330	250	585		
CMRR	Common-mode rejection ratio	V <sub>IC</sub> = V <sub>ICRmin</sub>	25°C	70	95	75	97	dB	
			-40°C	70	95	75	97		
			85°C	70	95	75	97		
k <sub>SVR</sub>	Supply-voltage rejection ratio ( $\Delta$ V <sub>DD</sub> /ΔV <sub>IO</sub> )	V <sub>DD</sub> = 5 V to 10 V, V <sub>O</sub> = 1.4 V	25°C	75	98	75	98	dB	
			-40°C	75	98	75	98		
			85°C	75	98	75	98		
I <sub>DD</sub>	Supply current (four amplifiers)	V <sub>O</sub> = V <sub>DD</sub> / 2, V <sub>IC</sub> = V <sub>DD</sub> / 2, No load	25°C	40	68	57	92	$\mu$ A	
			-40°C	62	108	98	172		
			85°C	29	52	40	72		

† Full range is -40°C to 85°C.

- NOTES: 4. The typical values of input bias current and input offset current below 5 pA were determined mathematically.  
 5. This range also applies to each input individually.  
 6. At V<sub>DD</sub> = 5 V, V<sub>O</sub> = 0.25 V to 2 V; at V<sub>DD</sub> = 10 V, V<sub>O</sub> = 1 V to 6 V.

**operating characteristics at specified free-air temperature**

PARAMETER	TEST CONDITIONS	T <sub>A</sub>	TLC1078I						UNIT
			V <sub>DD</sub> = 5 V			V <sub>DD</sub> = 10 V			
			MIN	TYP	MAX	MIN	TYP	MAX	
SR Slew rate at unity gain	R <sub>L</sub> = 1 M $\Omega$ , C <sub>L</sub> = 20 pF, V <sub>I(PP)</sub> = 1 V, See Figure 1	25°C	32			47			V/ms
		-40°C	39			59			
		85°C	25			34			
V <sub>n</sub> Equivalent input noise voltage	f = 1 kHz, R <sub>S</sub> = 20 $\Omega$	25°C	68			68			nV/ $\sqrt{\text{Hz}}$
B <sub>1</sub> Unity-gain bandwidth	C <sub>L</sub> = 20 pF, See Figure 2	25°C	85			110			kHz
		-40°C	130			155			
		85°C	55			80			
$\phi_m$ Phase margin at unity gain	C <sub>L</sub> = 20 pF, See Figure 2	25°C	34°			38°			
		-40°C	38°			40°			
		85°C	28°			32°			

**operating characteristics at specified free-air temperature**

PARAMETER	TEST CONDITIONS	T <sub>A</sub>	TLC1079I						UNIT
			V <sub>DD</sub> = 5 V			V <sub>DD</sub> = 10 V			
			MIN	TYP	MAX	MIN	TYP	MAX	
SR Slew rate at unity gain	R <sub>L</sub> = 1 M $\Omega$ , C <sub>L</sub> = 20 pF, V <sub>I(PP)</sub> = 1 V, See Figure 1	25°C	32			47			V/ms
		-40°C	39			59			
		85°C	25			34			
V <sub>n</sub> Equivalent input noise voltage	f = 1 kHz, R <sub>S</sub> = 20 $\Omega$	25°C	68			68			nV/ $\sqrt{\text{Hz}}$
B <sub>1</sub> Unity-gain bandwidth	C <sub>L</sub> = 20 pF, See Figure 2	25°C	85			110			kHz
		-40°C	130			155			
		85°C	55			80			
$\phi_m$ Phase margin at unity gain	C <sub>L</sub> = 20 pF, See Figure 2	25°C	34°			38°			
		-40°C	38°			42°			
		85°C	28°			32°			



electrical characteristics at specified operating free-air temperature

PARAMETER	TEST CONDITIONS	T <sub>A</sub> †	TLC1078M						UNIT
			V <sub>DD</sub> = 5 V			V <sub>DD</sub> = 10 V			
			MIN	TYP	MAX	MIN	TYP	MAX	
V <sub>IO</sub> Input offset voltage	V <sub>O</sub> = 1.4 V, V <sub>IC</sub> = 0, R <sub>S</sub> = 50 $\Omega$ , R <sub>L</sub> = 1 M $\Omega$	25°C		160	450		180	600	$\mu$ V
		Full range			1250			1400	
$\alpha$ V <sub>IO</sub> Temperature coefficient of input offset voltage		25°C to 125°C		1.4			1.4		$\mu$ V/°C
I <sub>IO</sub> Input offset current (see Note 4)	V <sub>O</sub> = V <sub>DD</sub> /2, V <sub>IC</sub> = V <sub>DD</sub> /2	25°C		0.1			0.1		pA
		125°C		1.4	15		1.8	15	nA
I <sub>IB</sub> Input bias current (see Note 4)		25°C		0.6			0.7		pA
		125°C		9	35		10	35	nA
V <sub>ICR</sub> Common-mode input voltage range (see Note 5)		25°C	0 to 4	-0.3 to 4.2		0 to 9	-0.3 to 9.2		V
		Full range	0 to 3.5			0 to 8.5			V
V <sub>OH</sub> High-level output voltage	V <sub>ID</sub> = 100 mV, R <sub>L</sub> = 1 M $\Omega$	25°C	3.2	4.1		8.2	8.9		V
		-55°C	3.2	4.1		8.2	8.8		
		125°C	3.2	4.2		8.2	9		
V <sub>OL</sub> Low-level output voltage	V <sub>ID</sub> = -100 mV, I <sub>OL</sub> = 0	25°C		0	25		0	25	mV
		-55°C		0	25		0	25	
		125°C		0	25		0	25	
A <sub>VD</sub> Large-signal differential voltage amplification	R <sub>L</sub> = 1 M $\Omega$ , See Note 6	25°C	250	525		500	850		V/mV
		-55°C	250	950		500	1750		
		125°C	35	200		75	380		
CMRR Common-mode rejection ratio	V <sub>IC</sub> = V <sub>ICRmin</sub>	25°C	70	95		75	97		dB
		-55°C	70	95		75	97		
		125°C	70	85		75	91		
k <sub>SVR</sub> Supply-voltage rejection ratio ( $\Delta$ V <sub>DD</sub> / $\Delta$ V <sub>IO</sub> )	V <sub>O</sub> = 1.4 V	25°C	75	98		75	98		dB
		-55°C	70	98		70	98		
		125°C	70	98		70	98		
I <sub>DD</sub> Supply current (two amplifiers)	V <sub>O</sub> = V <sub>DD</sub> /2, V <sub>IC</sub> = V <sub>DD</sub> /2, No load	25°C		20	34		29	46	$\mu$ A
		-55°C		35	60		56	96	
		125°C		14	24		18	30	

† Full range is -55°C to 125°C.

- NOTES: 4. The typical values of input bias current and input offset current below 5 pA were determined mathematically.  
 5. This range also applies to each input individually.  
 6. At V<sub>DD</sub> = 5 V, V<sub>O</sub> = 0.25 V to 2 V; at V<sub>DD</sub> = 10 V, V<sub>O</sub> = 1 V to 6 V.

TLC1078, TLC1078Y, TLC1079, TLC1079Y  
**LinCMOS™**  $\mu$ POWER PRECISION  
**OPERATIONAL AMPLIFIERS**

SLOS179 – FEBRUARY 1997

**electrical characteristics at specified free-air temperature**

PARAMETER	TEST CONDITIONS	T <sub>A</sub> †	TLC1079M						UNIT
			V <sub>DD</sub> = 5 V			V <sub>DD</sub> = 10 V			
			MIN	TYP	MAX	MIN	TYP	MAX	
V <sub>IO</sub>	Input offset voltage	V <sub>O</sub> = 1.4 V, V <sub>IC</sub> = 0, R <sub>S</sub> = 50 Ω, R <sub>I</sub> = 1 MΩ	25°C	190	850	200	1150	μV	
	Full range			1600		1900			
α <sub>VIO</sub>	Temperature coefficient of input offset voltage		25°C to 125°C	1.4		1.4		μV/°C	
I <sub>IO</sub>	Input offset current (see Note 4)	V <sub>O</sub> = V <sub>DD</sub> /2, V <sub>IC</sub> = V <sub>DD</sub> /2	25°C	0.1		0.1		pA	
			125°C	1.4	15	1.8	15	nA	
I <sub>IB</sub>	Input bias current (see Note 4)		25°C	0.6		0.7		pA	
			125°C	9	35	10	35	nA	
V <sub>ICR</sub>	Common mode input voltage range (see Note 5)		25°C	0 to 4	-0.3 to 4.2	0 to 9	-0.3 to 9.2	V	
			Full range	0 to 3.5		0 to 8.5		V	
V <sub>OH</sub>	High-level output voltage	V <sub>ID</sub> = 100 mV, R <sub>L</sub> = 1 MΩ	25°C	3.2	4.1	8.2	8.9	V	
			-55°C	3.2	4.1	8.2	8.9		
			125°C	3.2	4.2	8.2	9		
V <sub>OL</sub>	Low-level output voltage	V <sub>ID</sub> = -100 mV, I <sub>OL</sub> = 0	25°C	0	25	0	25	mV	
			-55°C	0	25	0	25		
			125°C	0	25	0	25		
A <sub>VD</sub>	Large-signal differential voltage amplification	R <sub>L</sub> = 1 MΩ, See Note 6	25°C	250	525	500	850	V/mV	
			-55°C	250	950	500	1750		
			125°C	35	200	75	380		
CMRR	Common-mode rejection ratio	V <sub>IC</sub> = V <sub>ICRmin</sub>	25°C	70	95	75	97	dB	
			-55°C	70	95	75	97		
			125°C	70	85	75	91		
k <sub>SVR</sub>	Supply voltage rejection ratio (ΔV <sub>DD</sub> /ΔV <sub>IO</sub> )	V <sub>DD</sub> = 5 V to 10 V, V <sub>O</sub> = 1.4 V	25°C	75	98	75	98	dB	
			-55°C	70	98	70	98		
			125°C	70	98	70	98		
I <sub>DD</sub>	Supply current (four amplifiers)	V <sub>O</sub> = V <sub>DD</sub> /2, V <sub>IC</sub> = V <sub>DD</sub> /2, No load	25°C	40	68	57	92	μA	
			-55°C	69	120	111	192		
			125°C	27	48	35	60		

† Full range is -55°C to 125°C.

NOTES: 4. The typical values of input bias current and input offset current below 5 pA were determined mathematically.

5. This range also applies to each input individually.

6. At V<sub>DD</sub> = 5 V, V<sub>O</sub> = 0.25 V to 2 V; at V<sub>DD</sub> = 10 V, V<sub>O</sub> = 1 V to 6 V.



operating characteristics at specified free-air temperature

PARAMETER	TEST CONDITIONS	T <sub>A</sub>	TLC1078M						UNIT
			V <sub>DD</sub> = 5 V			V <sub>DD</sub> = 10 V			
			MIN	TYP	MAX	MIN	TYP	MAX	
SR Slew rate at unity gain	R <sub>L</sub> = 1 M $\Omega$ , C <sub>L</sub> = 20 pF, V <sub>I(PP)</sub> = 1 V, See Figure 1	25°C		32			47	V/ms	
		-55°C		41			63		
		125°C		20			27		
V <sub>n</sub> Equivalent input noise voltage	f = 1 kHz, R <sub>S</sub> = 20 $\Omega$	25°C		68			68	nV/ $\sqrt{\text{Hz}}$	
B <sub>1</sub> Unity-gain bandwidth	C <sub>L</sub> = 20 pF, See Figure 2	25°C		85			110	kHz	
		-55°C		140			165		
		125°C		45			70		
$\phi_m$ Phase margin at unity gain	C <sub>L</sub> = 20 pF, See Figure 2	25°C		34°			38°		
		-55°C		39°			43°		
		125°C		25°			29°		

operating characteristics at specified free-air temperature

PARAMETER	TEST CONDITIONS	T <sub>A</sub>	TLC1079M						UNIT
			V <sub>DD</sub> = 5 V			V <sub>DD</sub> = 10 V			
			MIN	TYP	MAX	MIN	TYP	MAX	
SR Slew rate at unity gain	R <sub>L</sub> = 1 M $\Omega$ , C <sub>L</sub> = 20 pF, V <sub>I(PP)</sub> = 1 V, See Figure 1	25°C		32			47	V/ms	
		-55°C		41			63		
		125°C		20			27		
V <sub>n</sub> Equivalent input noise voltage	f = 1 kHz, R <sub>S</sub> = 20 $\Omega$	25°C		68			68	nV/ $\sqrt{\text{Hz}}$	
B <sub>1</sub> Unity-gain bandwidth	C <sub>L</sub> = 20 pF, See Figure 2	25°C		85			110	kHz	
		-55°C		140			165		
		125°C		45			70		
		25°C		34°			38°		
$\phi_m$ Phase margin at unity gain	C <sub>L</sub> = 20 pF, See Figure 2	-55°C		39°			43°		
		125°C		25°			29°		

PARAMETER MEASUREMENT INFORMATION

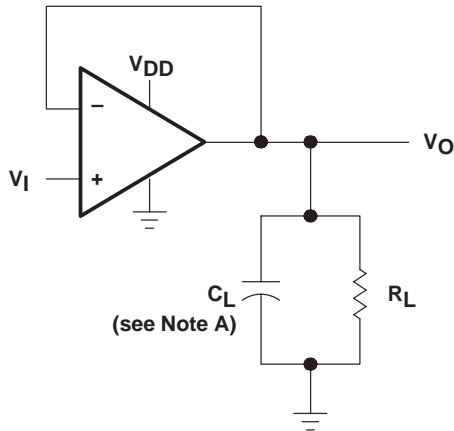

NOTE A:  $C_L$  includes fixture capacitance.

Figure 1. Slew-Rate Test Circuit

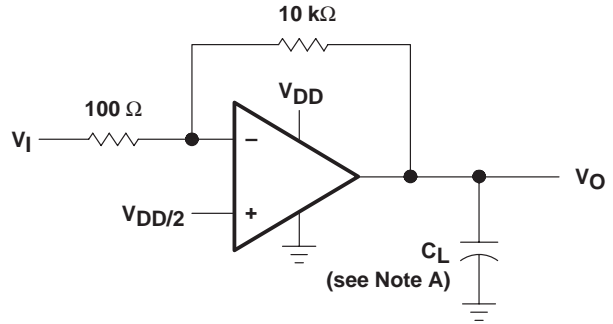

Figure 2. Unity-Gain Bandwidth and Phase-Margin Test Circuit



TYPICAL CHARACTERISTICS

Table of Graphs

			FIGURE
$\alpha_{VIO}$	Temperature coefficient of input offset voltage	Distribution	3 – 6
$I_{IB}$	Input bias current	vs Free-air temperature	7
$I_{IO}$	Input offset current	vs Free-air temperature	7
$V_{IC}$	Common-mode input voltage	vs Supply voltage	8
$V_{OH}$	High-level output voltage	vs High-level output current vs Supply voltage vs Free-air temperature	9, 10 11 12
$V_{OL}$	Low-level output voltage	vs Common-mode input voltage vs Differential input voltage vs Free-air temperature vs Low-level output current	13, 14 15 16 17, 18
$A_{VD}$	Large-signal differential voltage amplification	vs Supply voltage vs Free-air temperature vs Frequency	19 20 21, 22
$V_{OM}$	Maximum peak output voltage	vs Frequency	23
$I_{DD}$	Supply current	vs Supply voltage vs Free-air temperature	24 25
$SR$	Slew rate	vs Supply voltage vs Free-air temperature	26 27
	Normalized slew rate	vs Free-air temperature	28
$V_n$	Equivalent input noise voltage	vs Frequency	29
$B_1$	Unity-gain bandwidth	vs Supply voltage vs Free-air temperature	30 31
$\phi_m$	Phase margin	vs Supply voltage vs Free-air temperature vs Capacitance load	32 33 34
	Phase shift	vs Frequency	21, 22

TYPICAL CHARACTERISTICS

DISTRIBUTION OF TLC1078  
 INPUT OFFSET VOLTAGE  
 TEMPERATURE COEFFICIENT

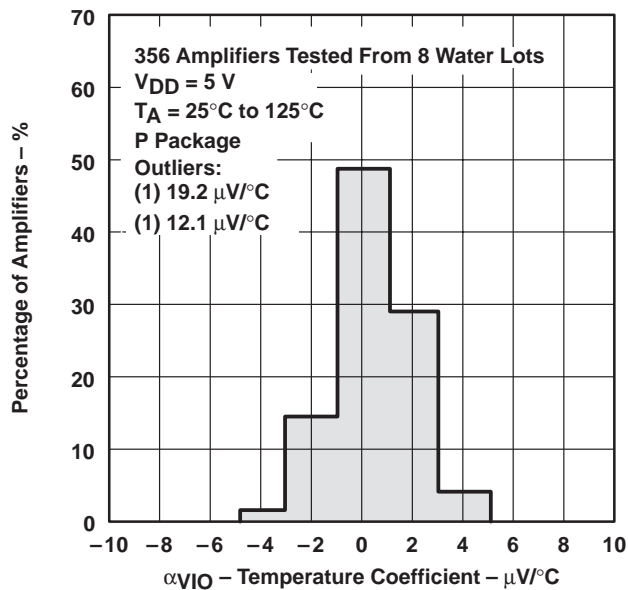

Figure 3

DISTRIBUTION OF TLC1078  
 INPUT OFFSET VOLTAGE  
 TEMPERATURE COEFFICIENT

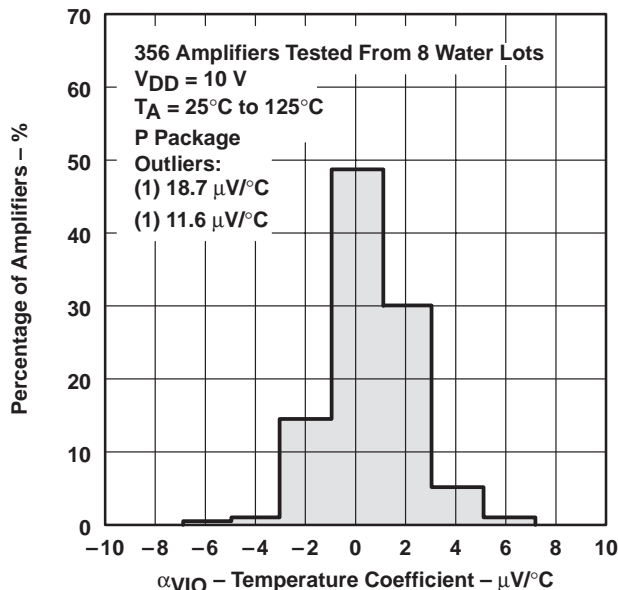

Figure 4

DISTRIBUTION OF TLC1079  
 INPUT OFFSET VOLTAGE  
 TEMPERATURE COEFFICIENT

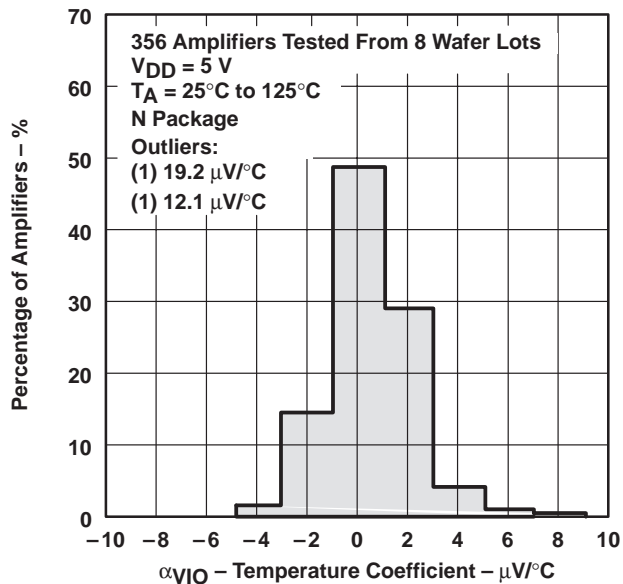

Figure 5

DISTRIBUTION OF TLC1079  
 INPUT OFFSET VOLTAGE  
 TEMPERATURE COEFFICIENT

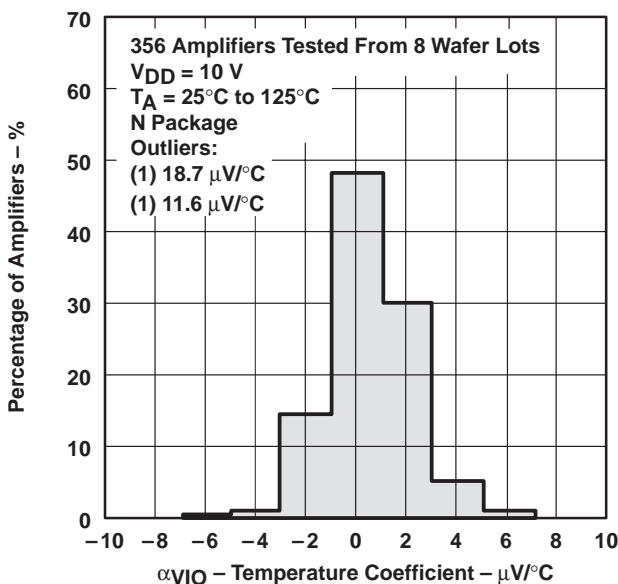
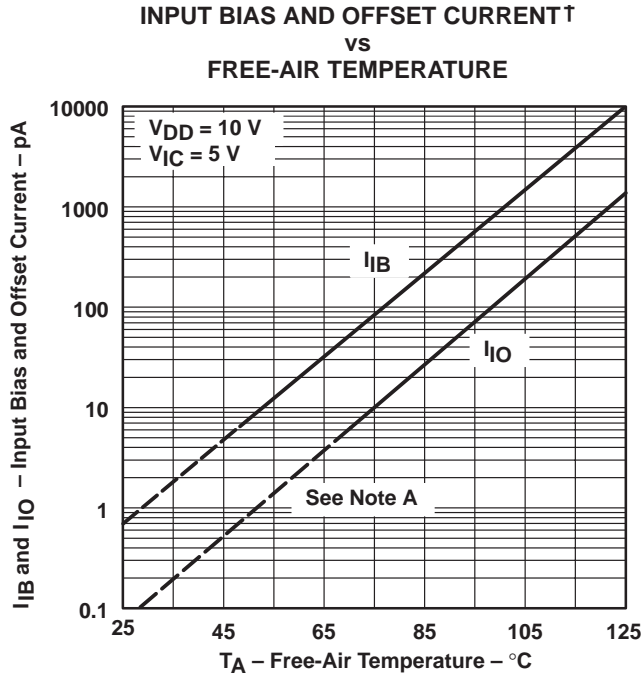

Figure 6

TYPICAL CHARACTERISTICS



NOTE A: The typical values of input bias current and input offset current below 5 pA were determined mathematically.

Figure 7

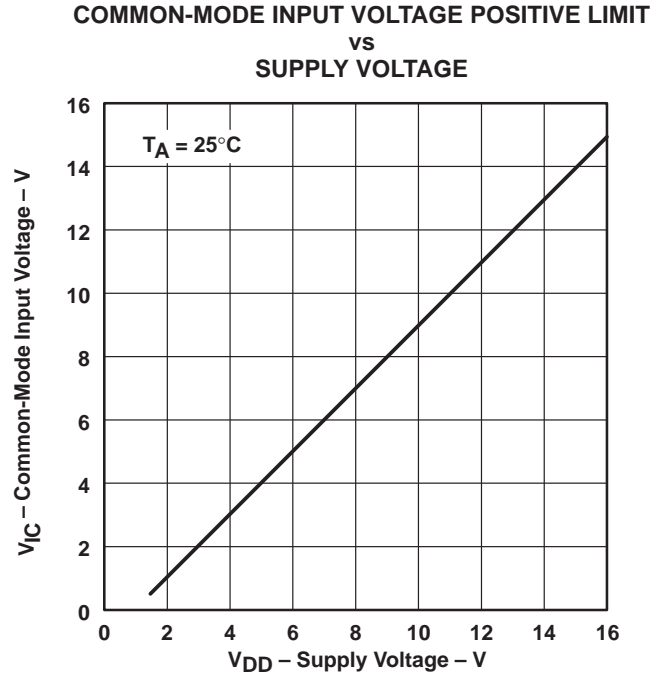

Figure 8

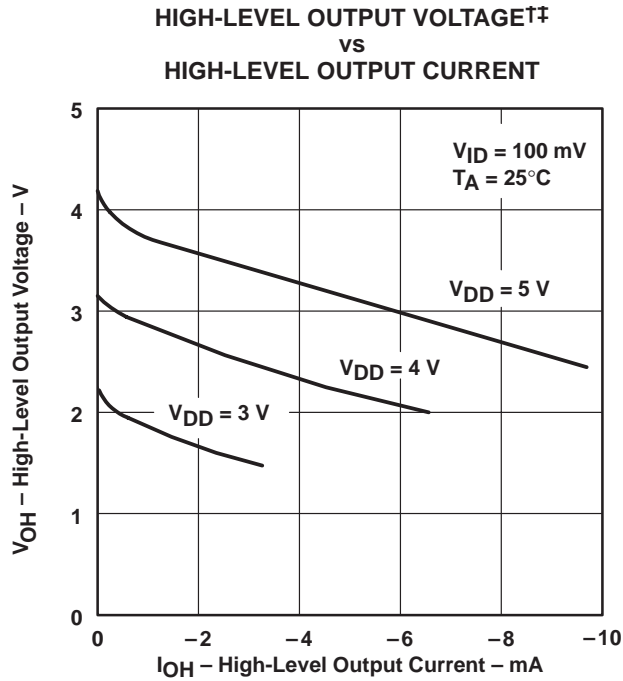

Figure 9

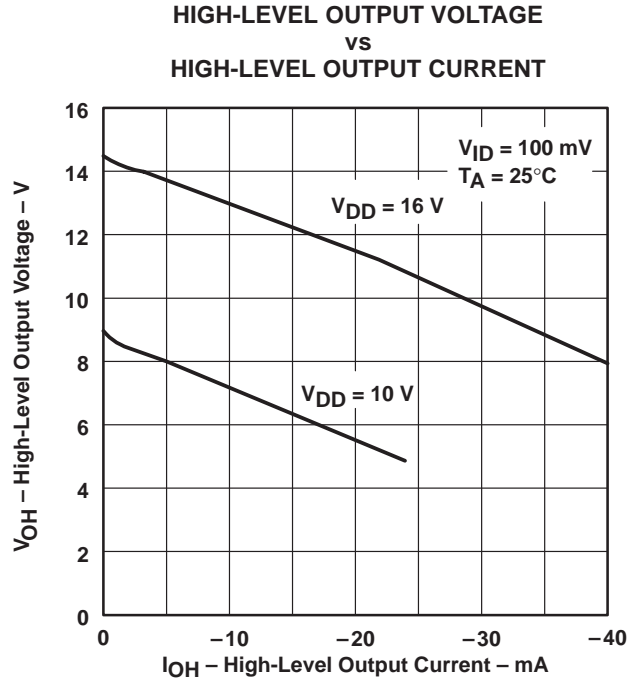

Figure 10

† Data at high and low temperatures are applicable only within the rated operating free-air temperature ranges of the various devices.  
 ‡ The  $V_{DD} = 3$  V curve does not apply to the TLC107xM.

TYPICAL CHARACTERISTICS

HIGH-LEVEL OUTPUT VOLTAGE  
 vs  
 SUPPLY VOLTAGE

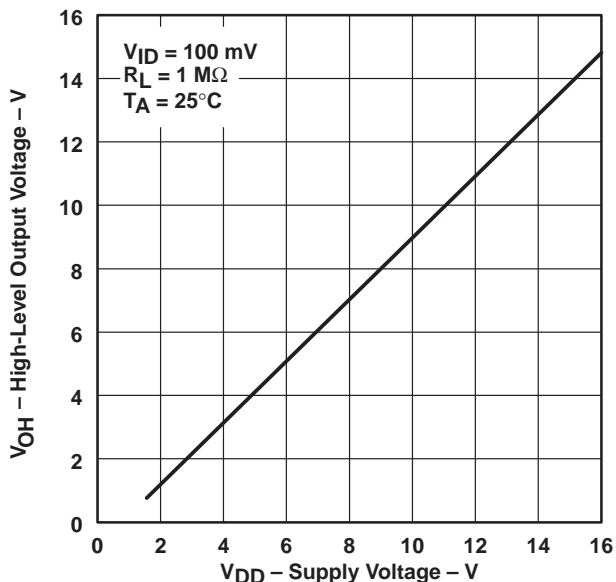

Figure 11

HIGH-LEVEL OUTPUT VOLTAGE†  
 vs  
 FREE-AIR TEMPERATURE

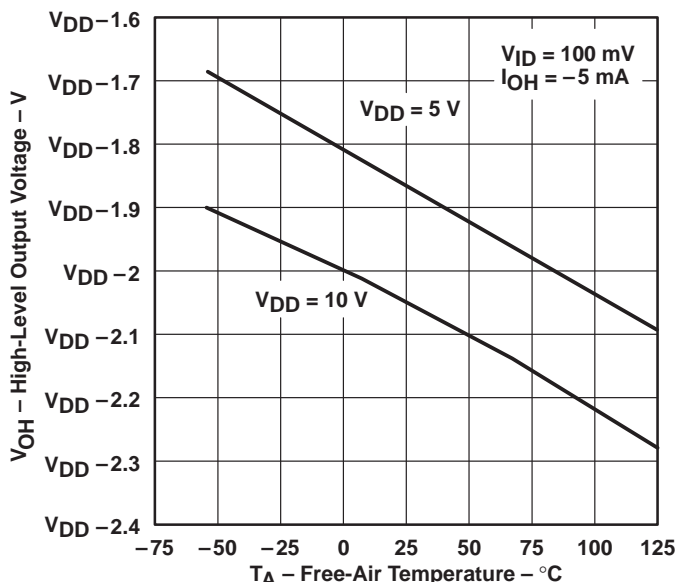

Figure 12

LOW-LEVEL OUTPUT VOLTAGE  
 vs  
 COMMON-MODE INPUT VOLTAGE

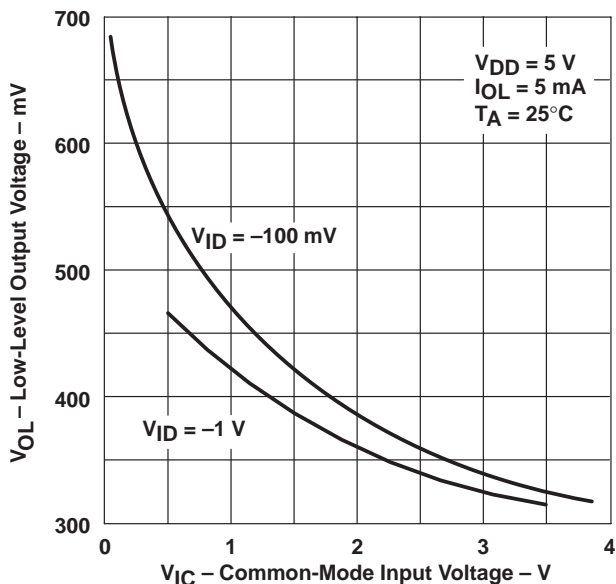

Figure 13

LOW-LEVEL OUTPUT VOLTAGE  
 vs  
 COMMON-MODE INPUT VOLTAGE

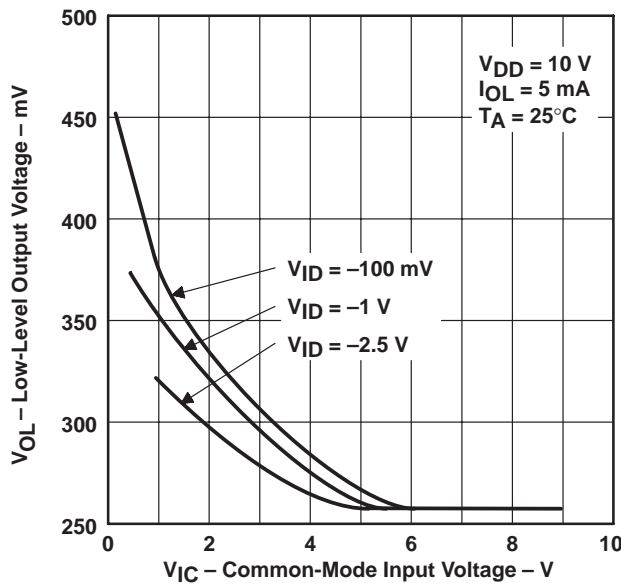
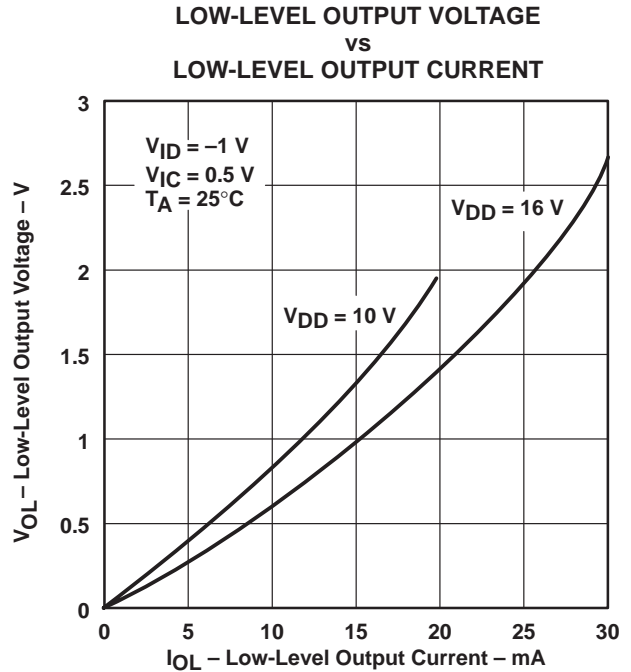
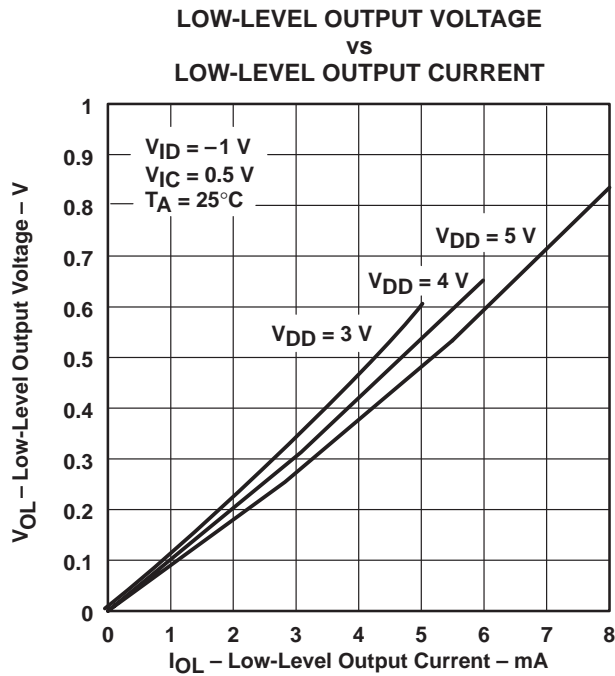
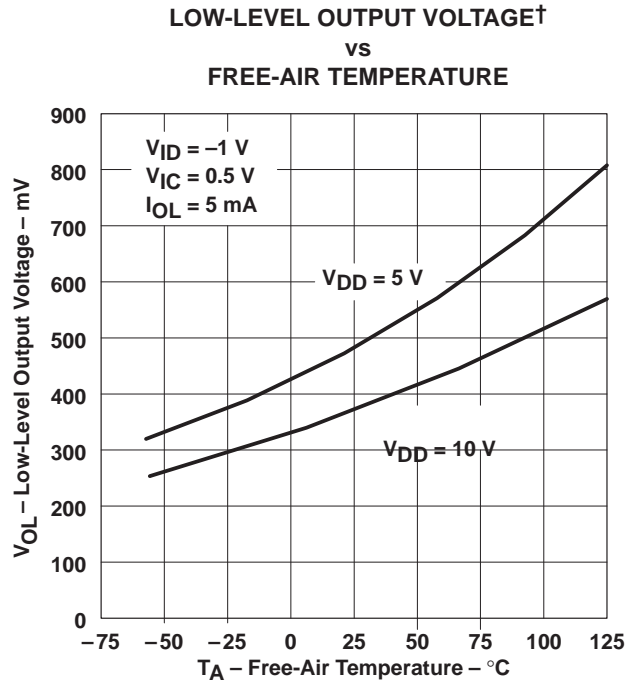
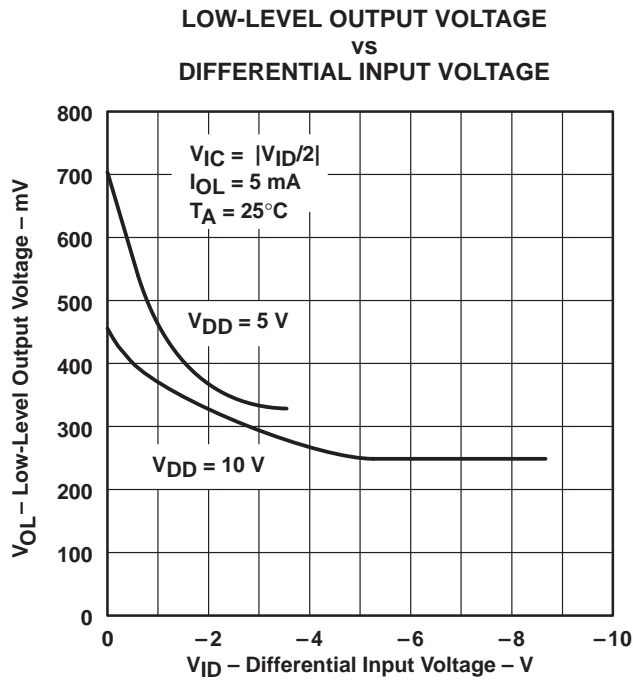

Figure 14

† Data at high and low temperatures are applicable only within the rated operating free-air temperature ranges of the various devices.

TYPICAL CHARACTERISTICS



† Data at high and low temperatures are applicable only within the rated operating free-air temperature ranges of the various devices.

TYPICAL CHARACTERISTICS

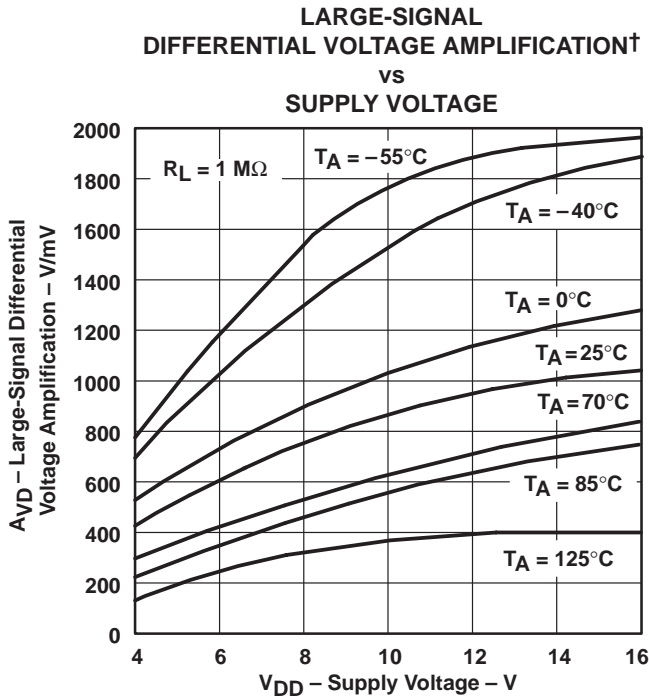

Figure 19

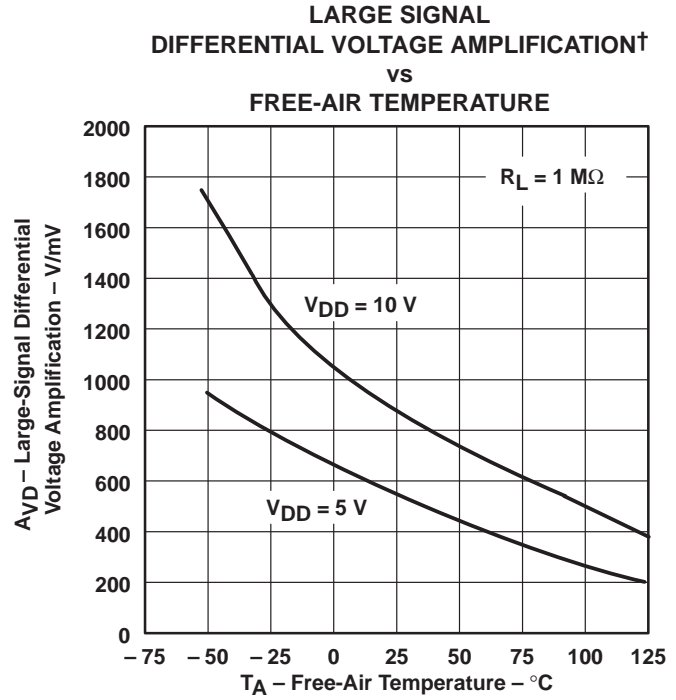

Figure 20

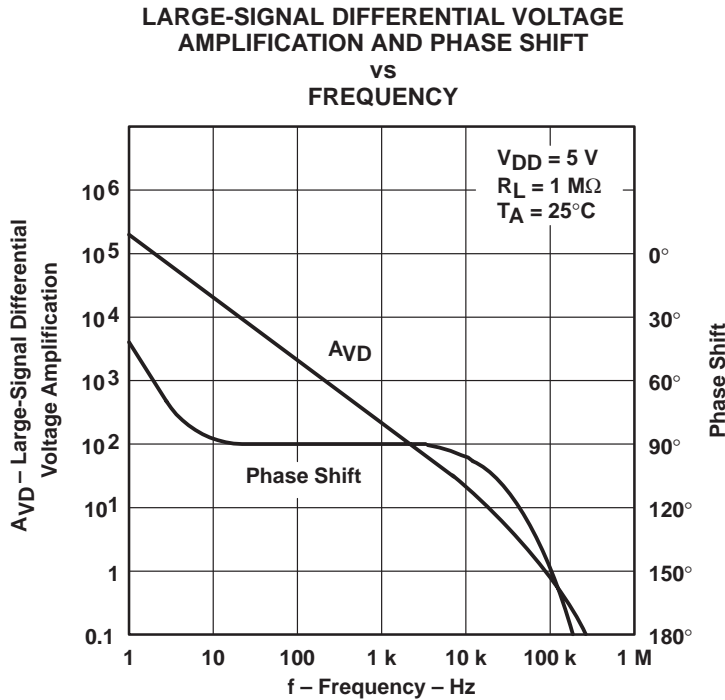

Figure 21

† Data at high and low temperatures are applicable only within the rated operating free-air temperature ranges of the various devices.

TYPICAL CHARACTERISTICS

LARGE-SIGNAL DIFFERENTIAL VOLTAGE  
 AMPLIFICATION AND PHASE SHIFT  
 VS  
 FREQUENCY

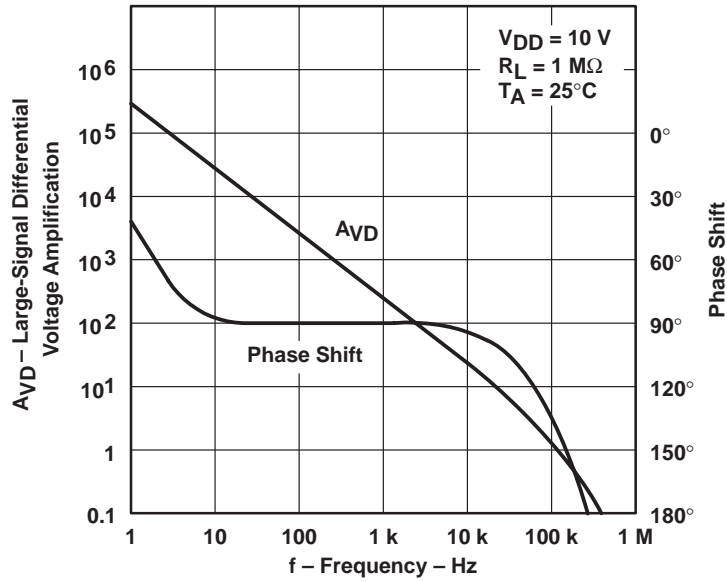

Figure 22

MAXIMUM PEAK OUTPUT VOLTAGE  
 VS  
 FREQUENCY

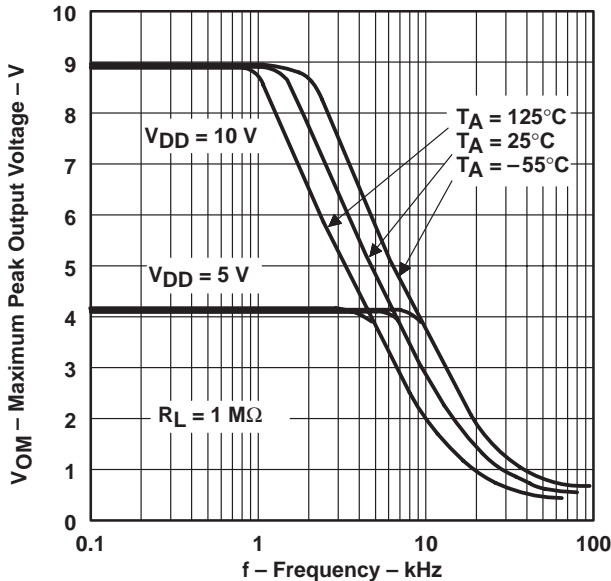

Figure 23

SUPPLY CURRENT†  
 VS  
 SUPPLY VOLTAGE

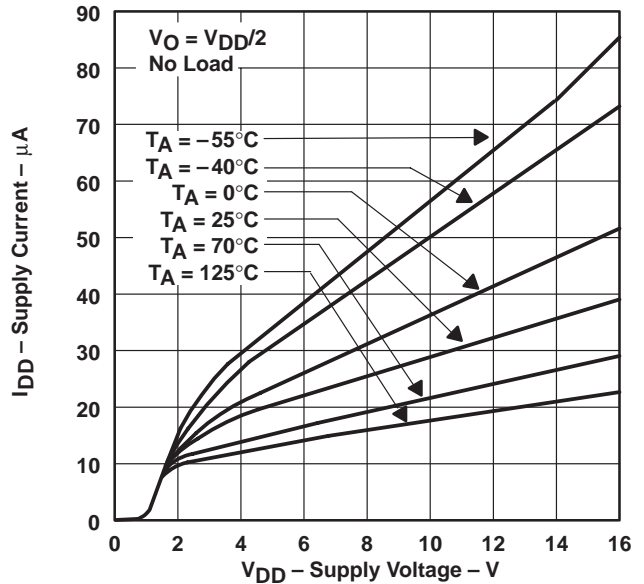

Figure 24

† Data at high and low temperatures are applicable only within the rated operating free-air temperature ranges of the various devices.

TYPICAL CHARACTERISTICS

SUPPLY CURRENT†  
 vs  
 FREE-AIR TEMPERATURE

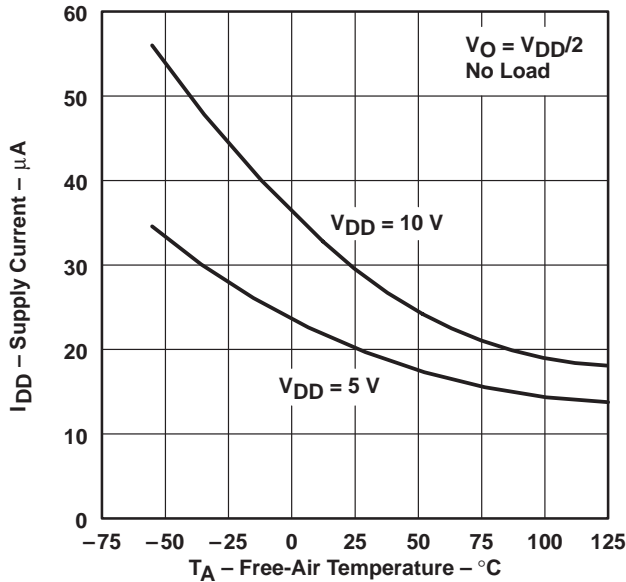

Figure 25

SLEW RATE  
 vs  
 SUPPLY VOLTAGE

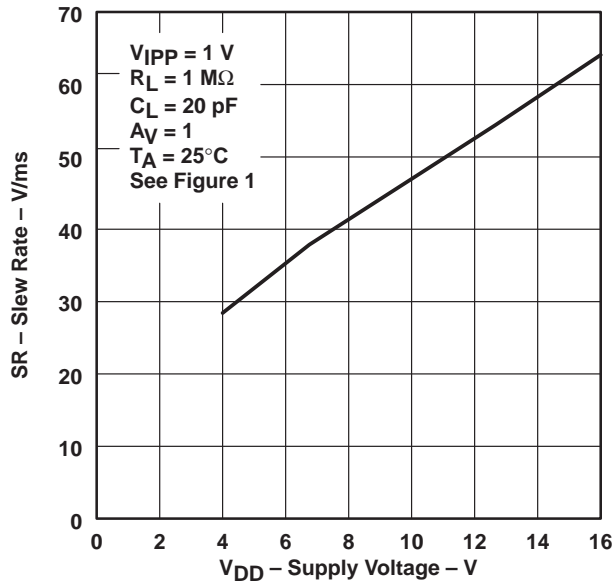

Figure 26

SLEW RATE†  
 vs  
 FREE-AIR TEMPERATURE

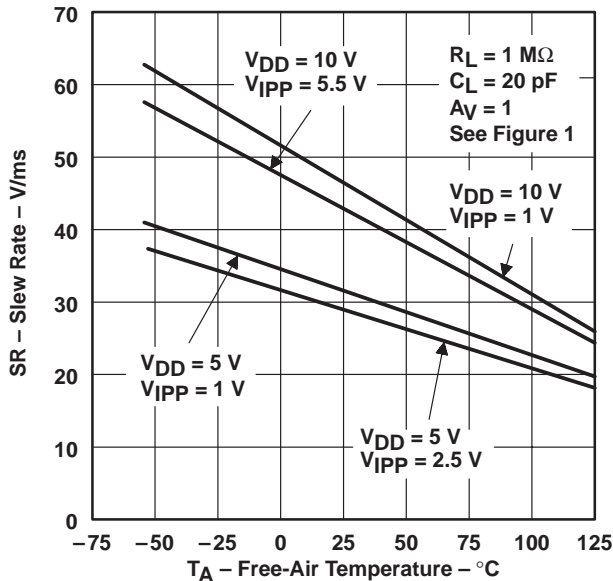

Figure 27

NORMALIZED SLEW RATE†  
 vs  
 FREE-AIR TEMPERATURE

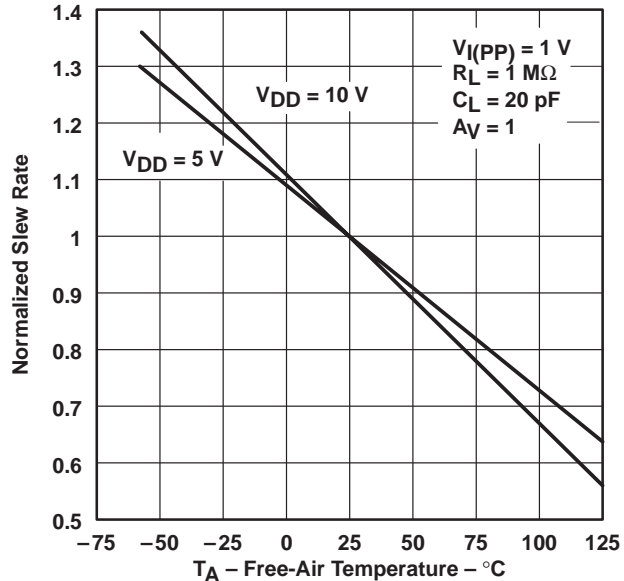

Figure 28

† Data at high and low temperatures are applicable only within the rated operating free-air temperature ranges of the various devices.



TYPICAL CHARACTERISTICS

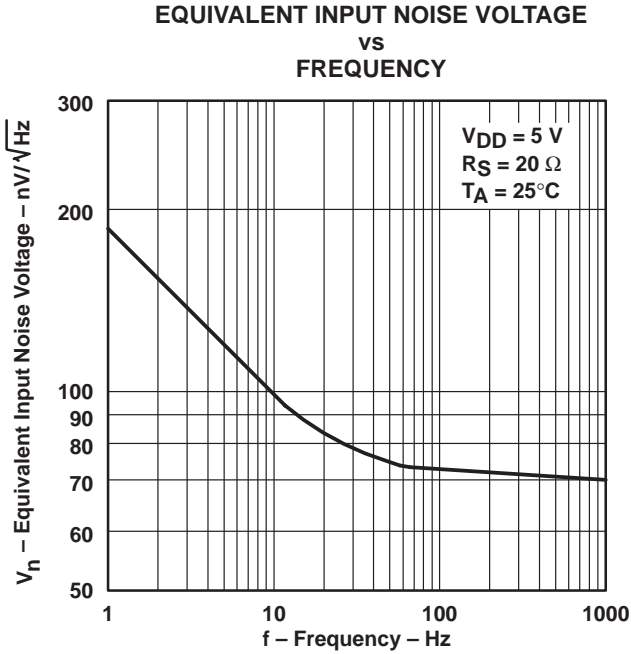

Figure 29

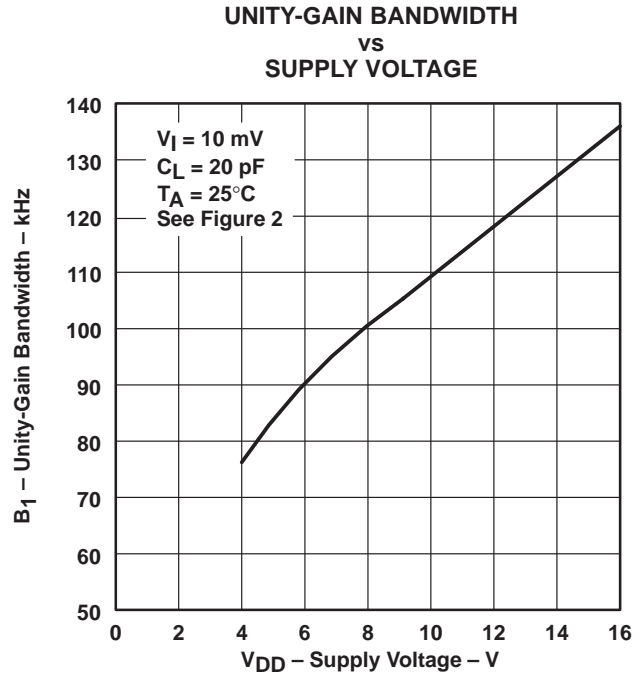

Figure 30

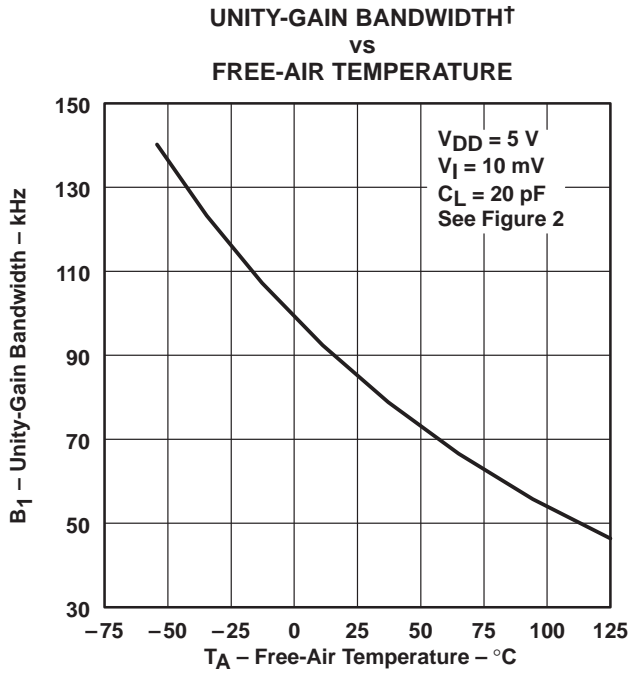

Figure 31

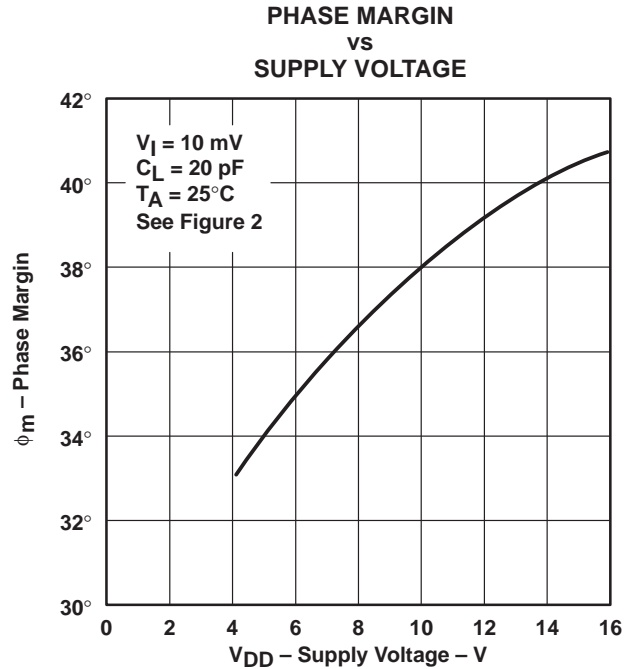

Figure 32

† Data at high and low temperatures are applicable only within the rated operating free-air temperature ranges of the various devices.

TYPICAL CHARACTERISTICS

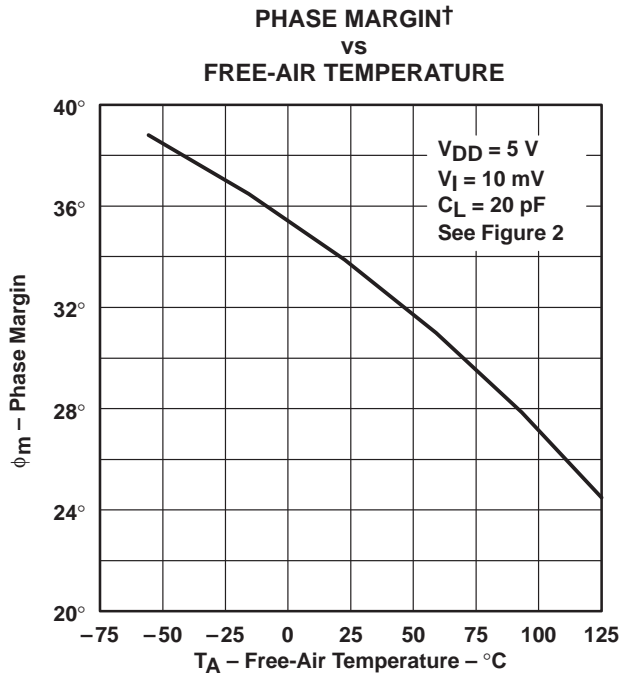

Figure 33

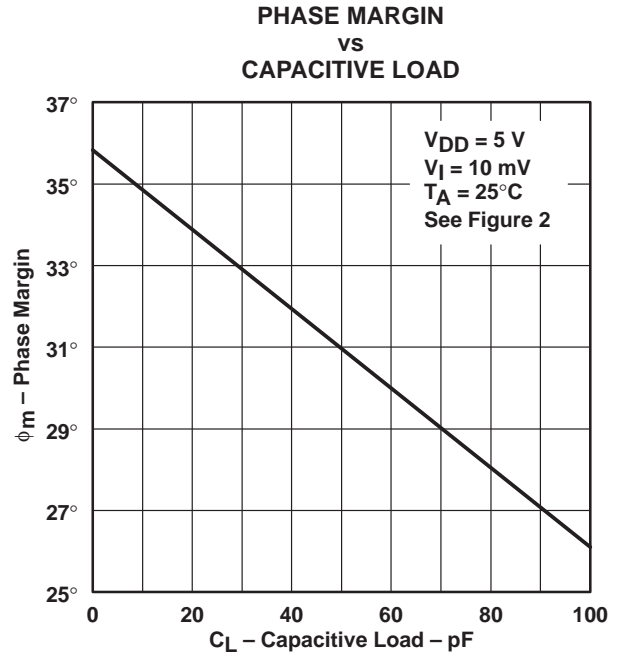

Figure 34

† Data at high and low temperatures are applicable only within the rated operating free-air temperature ranges of the various devices.

MECHANICAL INFORMATION

D (R-PDSO-G\*\*)

PLASTIC SMALL-OUTLINE PACKAGE

14 PIN SHOWN

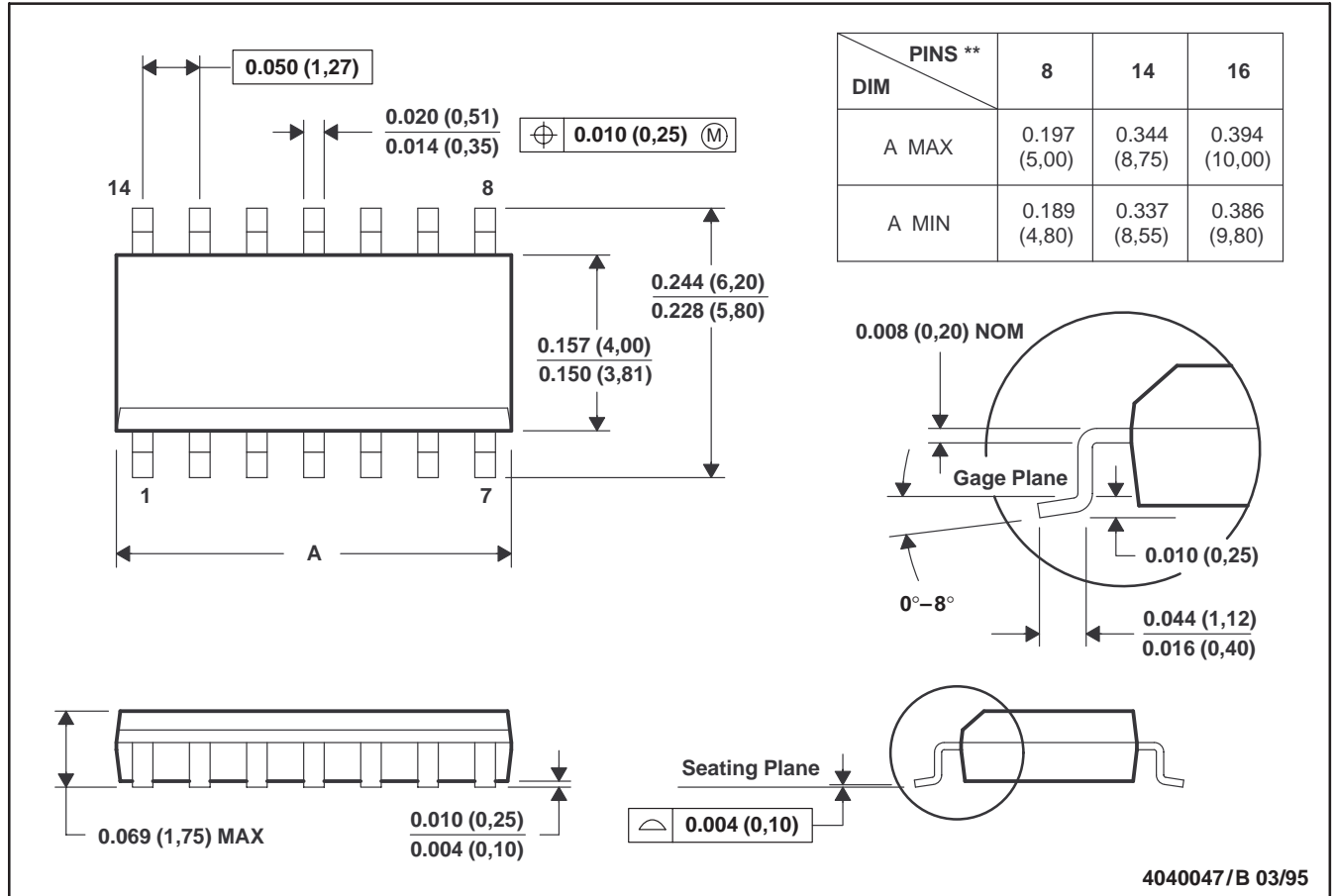

- NOTES: A. All linear dimensions are in inches (millimeters).  
 B. This drawing is subject to change without notice.  
 C. Body dimensions do not include mold flash or protrusion, not to exceed 0.006 (0,15).  
 D. Four center pins are connected to die mount pad.  
 E. Falls within JEDEC MS-012

TLC1078, TLC1078Y, TLC1079, TLC1079Y  
 LinCMOS™  $\mu$ POWER PRECISION  
 OPERATIONAL AMPLIFIERS

SLOS179 – FEBRUARY 1997

MECHANICAL INFORMATION

FK (S-CQCC-N\*\*)

LEADLESS CERAMIC CHIP CARRIER

28 TERMINAL SHOWN

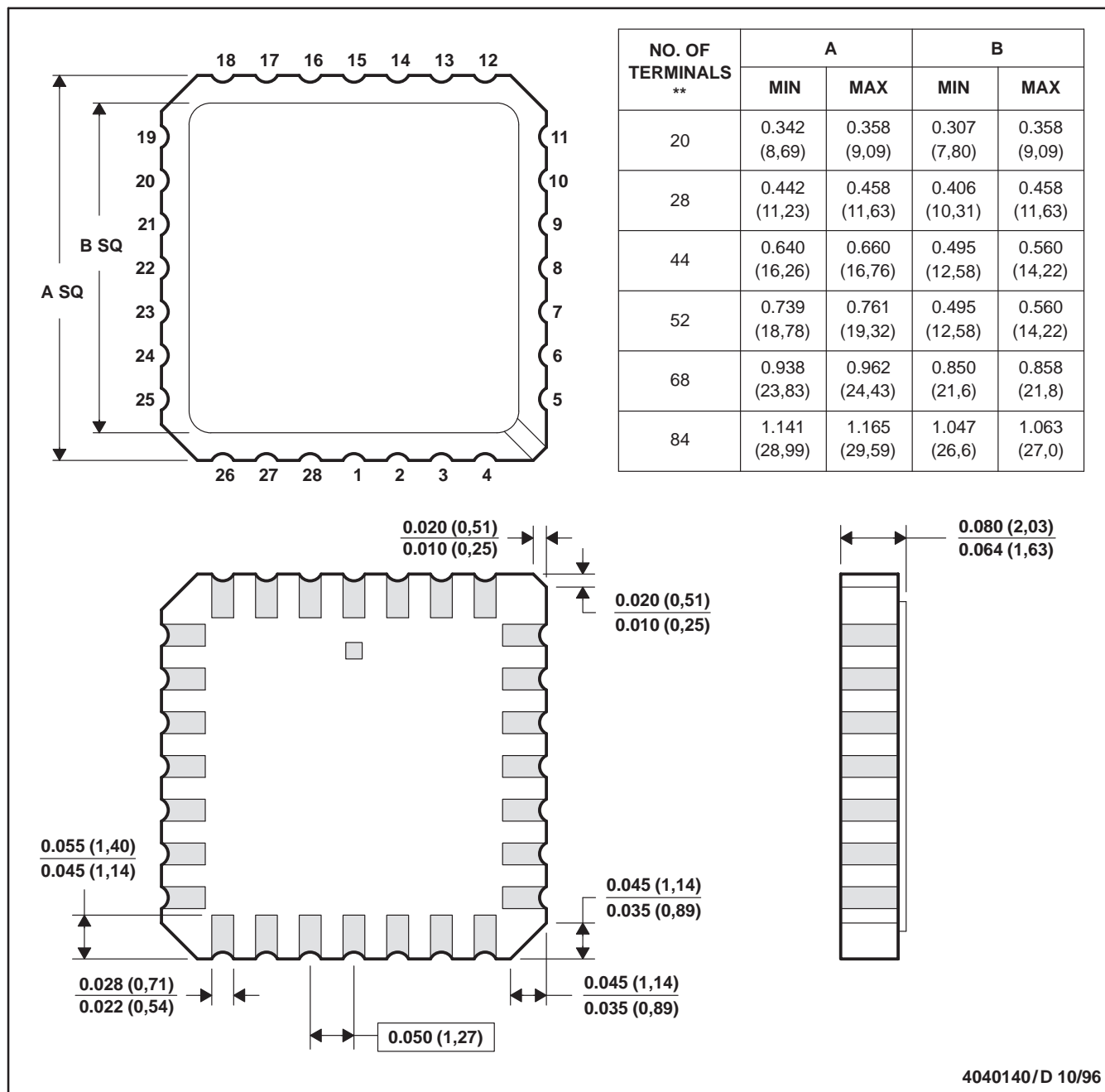

4040140/D 10/96

- NOTES: A. All linear dimensions are in inches (millimeters).  
 B. This drawing is subject to change without notice.  
 C. This package can be hermetically sealed with a metal lid.  
 D. The terminals are gold plated.  
 E. Falls within JEDEC MS-004



MECHANICAL INFORMATION

J (R-GDIP-T\*\*)

CERAMIC DUAL-IN-LINE PACKAGE

14 PIN SHOWN

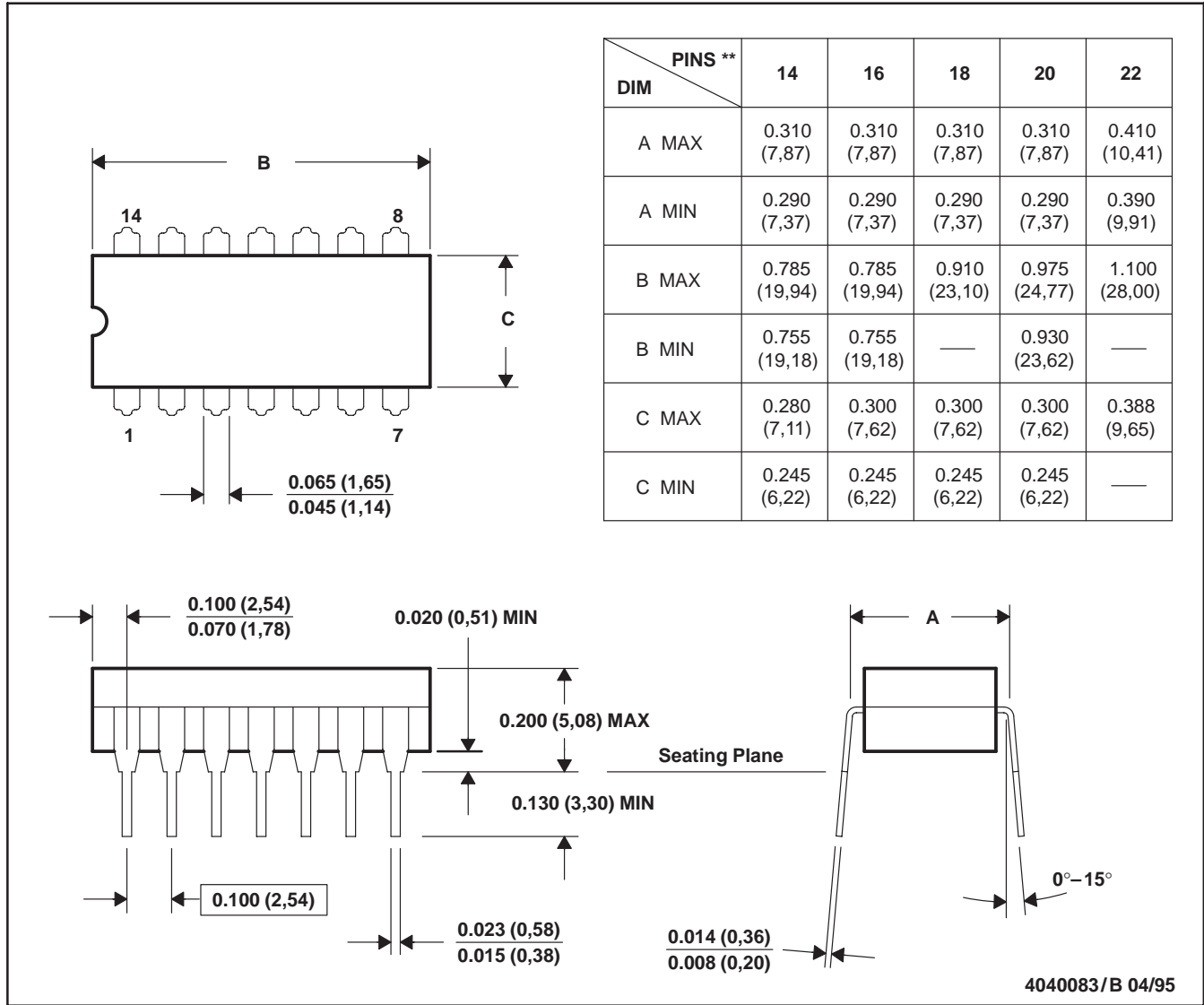

- NOTES: A. All linear dimensions are in inches (millimeters).  
 B. This drawing is subject to change without notice.  
 C. This package can be hermetically sealed with a ceramic lid using glass frit.  
 D. Index point is provided on cap for terminal identification only on press ceramic glass frit seal only.  
 E. Falls within MIL-STD-1835 GDIP1-T14, GDIP1-T16, GDIP1-T18, GDIP1-T20, and GDIP1-T22

TLC1078, TLC1078Y, TLC1079, TLC1079Y  
**LinCMOS™**  $\mu$ POWER PRECISION  
**OPERATIONAL AMPLIFIERS**

SLOS179 – FEBRUARY 1997

**MECHANICAL INFORMATION**

**JG (R-GDIP-T8)**

**CERAMIC DUAL-IN-LINE PACKAGE**

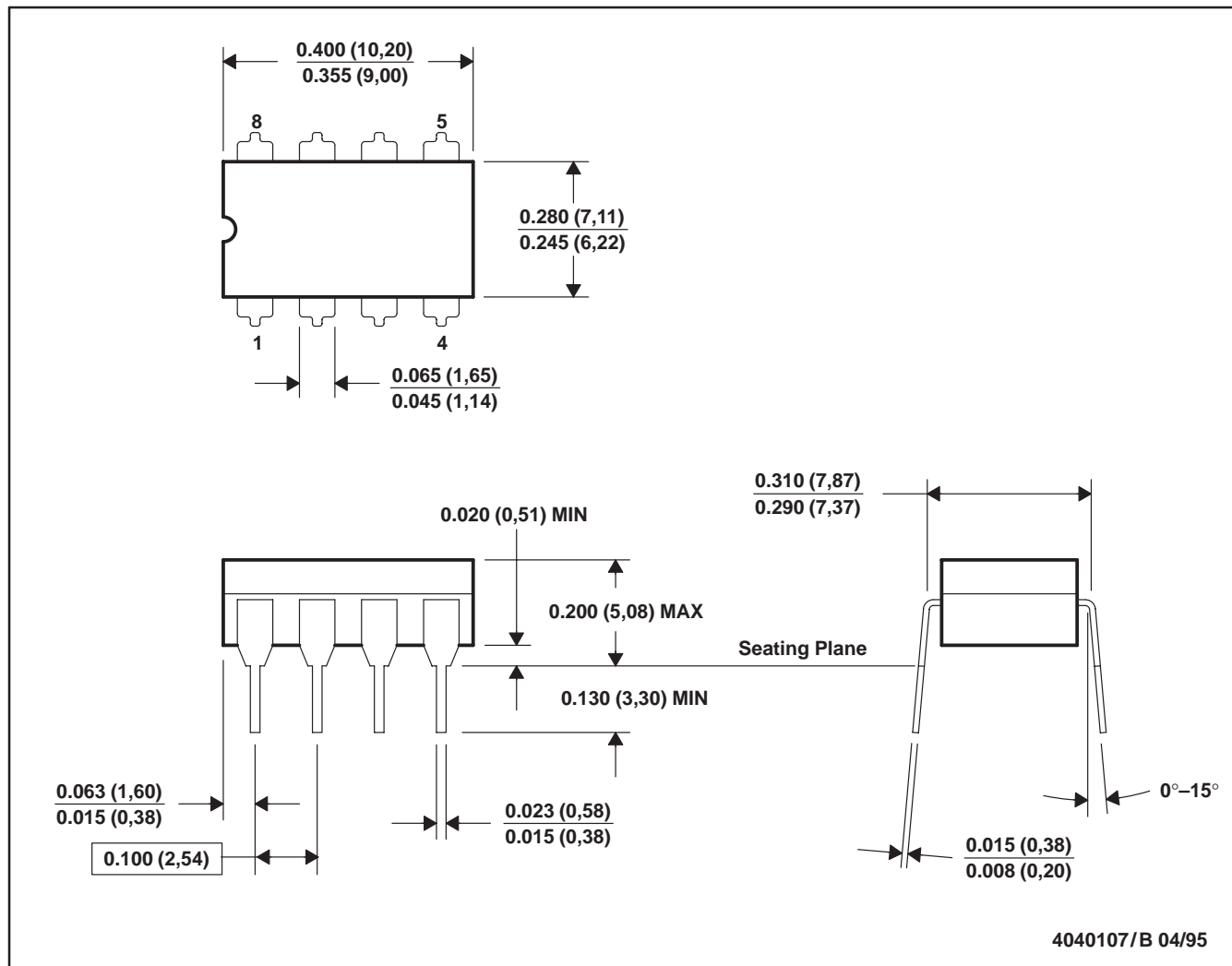

- NOTES: A. All linear dimensions are in inches (millimeters).  
 B. This drawing is subject to change without notice.  
 C. This package can be hermetically sealed with a ceramic lid using glass frit.  
 D. Index point is provided on cap for terminal identification only on press ceramic glass frit seal only  
 E. Falls within MIL-STD-1835 GDIP1-T8

MECHANICAL INFORMATION

N (R-PDIP-T\*\*)

PLASTIC DUAL-IN-LINE PACKAGE

16 PIN SHOWN

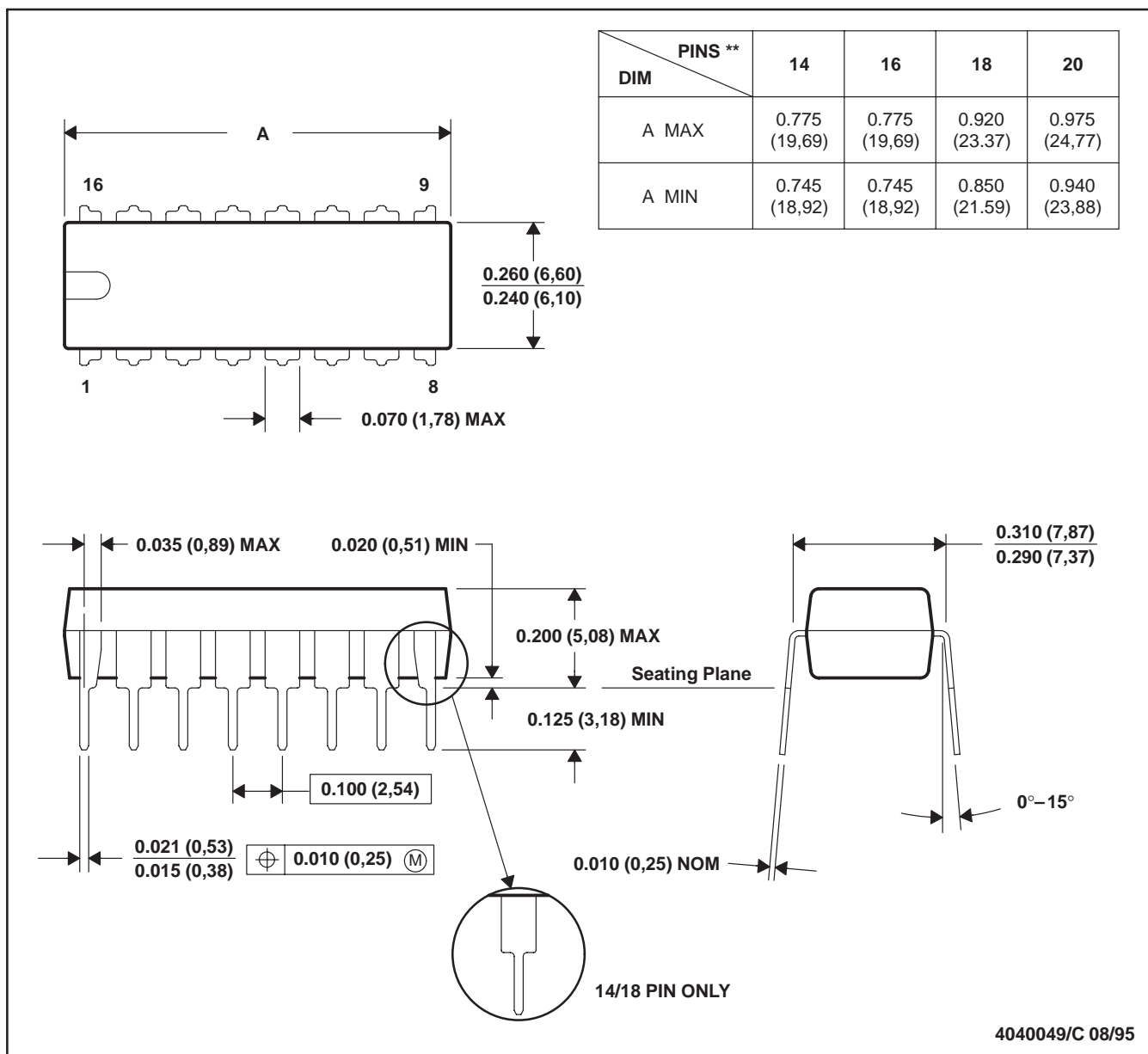

- NOTES: A. All linear dimensions are in inches (millimeters).  
 B. This drawing is subject to change without notice.  
 C. Falls within JEDEC MS-001 (20 pin package is shorter than MS-001.)

MECHANICAL INFORMATION

P (R-PDIP-T8)

PLASTIC DUAL-IN-LINE PACKAGE

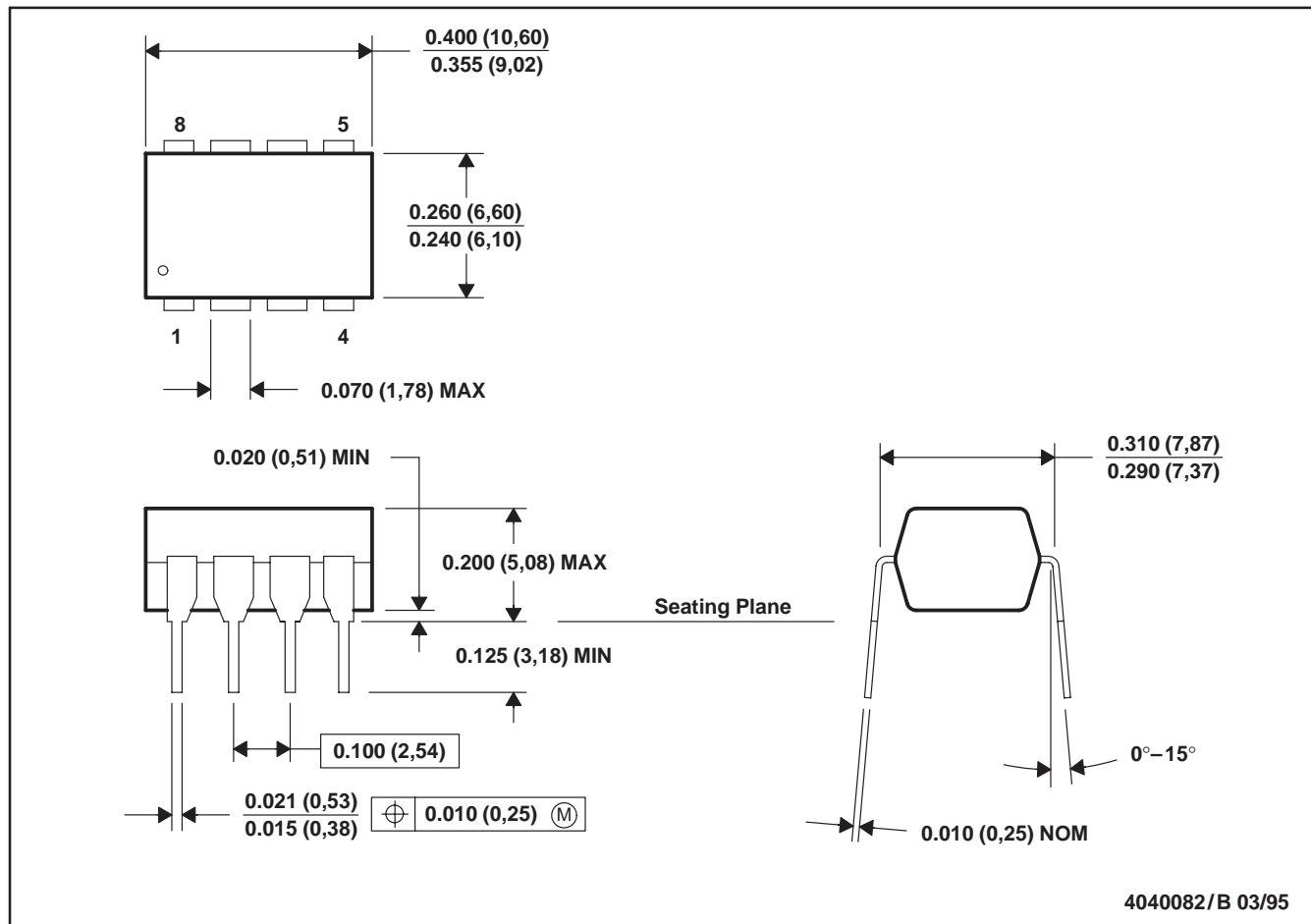

- NOTES: A. All linear dimensions are in inches (millimeters).  
 B. This drawing is subject to change without notice.  
 C. Falls within JEDEC MS-001



## **IMPORTANT NOTICE**

Texas Instruments and its subsidiaries (TI) reserve the right to make changes to their products or to discontinue any product or service without notice, and advise customers to obtain the latest version of relevant information to verify, before placing orders, that information being relied on is current and complete. All products are sold subject to the terms and conditions of sale supplied at the time of order acknowledgement, including those pertaining to warranty, patent infringement, and limitation of liability.

TI warrants performance of its semiconductor products to the specifications applicable at the time of sale in accordance with TI's standard warranty. Testing and other quality control techniques are utilized to the extent TI deems necessary to support this warranty. Specific testing of all parameters of each device is not necessarily performed, except those mandated by government requirements.

**CERTAIN APPLICATIONS USING SEMICONDUCTOR PRODUCTS MAY INVOLVE POTENTIAL RISKS OF DEATH, PERSONAL INJURY, OR SEVERE PROPERTY OR ENVIRONMENTAL DAMAGE ("CRITICAL APPLICATIONS"). TI SEMICONDUCTOR PRODUCTS ARE NOT DESIGNED, AUTHORIZED, OR WARRANTED TO BE SUITABLE FOR USE IN LIFE-SUPPORT DEVICES OR SYSTEMS OR OTHER CRITICAL APPLICATIONS. INCLUSION OF TI PRODUCTS IN SUCH APPLICATIONS IS UNDERSTOOD TO BE FULLY AT THE CUSTOMER'S RISK.**

In order to minimize risks associated with the customer's applications, adequate design and operating safeguards must be provided by the customer to minimize inherent or procedural hazards.

TI assumes no liability for applications assistance or customer product design. TI does not warrant or represent that any license, either express or implied, is granted under any patent right, copyright, mask work right, or other intellectual property right of TI covering or relating to any combination, machine, or process in which such semiconductor products or services might be or are used. TI's publication of information regarding any third party's products or services does not constitute TI's approval, warranty or endorsement thereof.