



TRR

MAIN FEATURES

- Miniature, cost-effective switching solution.
- State of the art capsule designs.
- Molded construction for compatibility with automatic board processing.
- Epoxy-molded dual-in-line package.
- UL and cUL recognized.

APPLICATIONS

- Measuring equipment, Communication equipment, Control equipment, Appliances, etc.

ORDERING INFORMATION

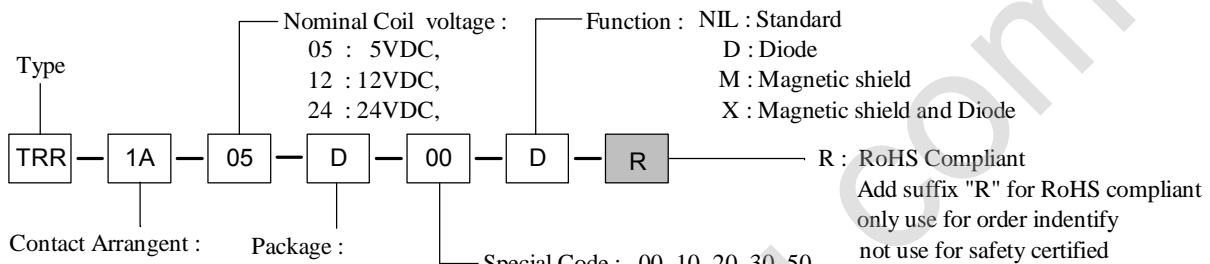

Package	Coil Pin	Contact Pin	1A	1B	1C	2A	Special Code
SIP	4 Pin	3,5	1,7	00	--	--	--
SIP	4 Pin	2,6	1,7	50	--	--	--
DIP/SMD	8 Pin	2,6	1,7,8,14	00	00	00	--
DIP/SMD	8 Pin	(2&13),6	1,7,8,14	10	10	10	00
DIP	4 Pin	2,6	8,14	20	--	--	--
DIP	8 Pin	6,13	1,7,8,14	30	--	--	--

DIMENSION (unit:mm) DRILLING (unit:mm) WIRING DIAGRAM

SIP Type

TRR-00
(00-PIN OUT 1,3,5,7)

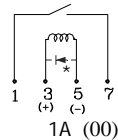
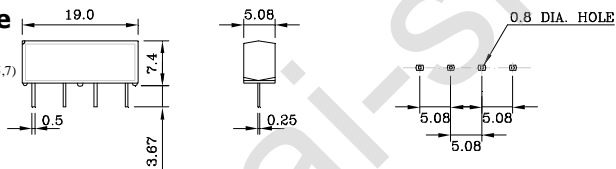

TRR-50

(50-PIN OUT 1,2,6,7)

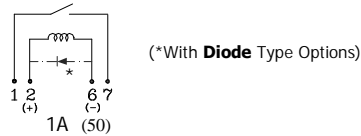
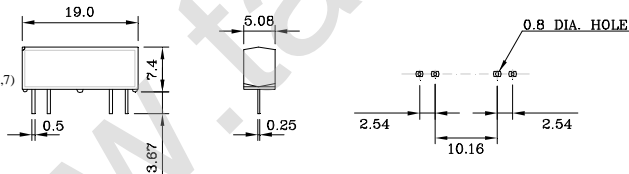

DIP Type

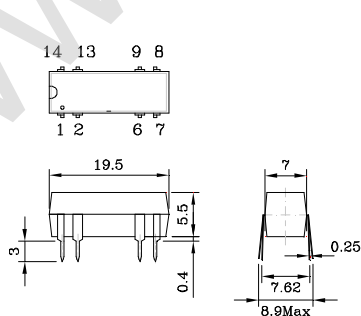

(10) Pin-Out With #13, (00) Pin-Out With W/O #13.

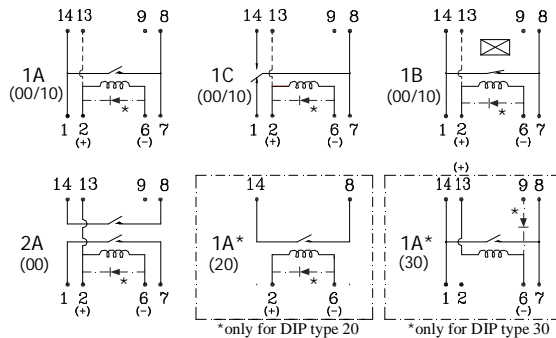

Remark: 1. In case of no tolerance shown in dimension: ±0.5mm.
2. The tolerance without indicating for DRILLING is always ±0.1mm.

(*With Diode Type Options)
※Please kindly indicate special code.

DIMENSION (unit:mm)

DRILLING (unit:mm)

WIRING DIAGRAM

SMD Type

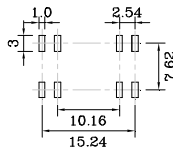
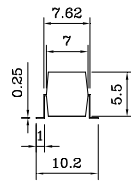
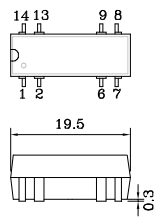

(10) Pin-Out With #13, (00) Pin-Out With W/O #13.

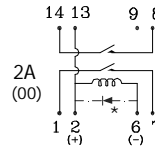
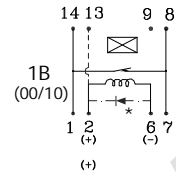
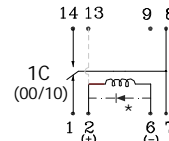
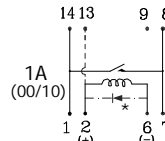

※Please kindly indicate special code.

(*With Diode Type Options)

Remark: 1. In case of no tolerance shown in dimension: $\pm 0.5\text{mm}$.
2. The tolerance without indicating for DRILLING is always $\pm 0.1\text{mm}$.

COIL DATA CHART (at 20°C)

Coil Sensitivity	Nominal Voltage (VDC)	Operate Voltage Max. (VDC)	Nominal Current (mA)	Coil Resistance ($\Omega \pm 10\%$)	Power Consumption (mW)	Pull-In Voltage (VDC)	Drop-Out Voltage (VDC)
TRR -1A	5	6	10	500	50	3.75	0.8
	12	14.5	12	1000	144	9.0	1.0
TRR -1B	24	29	11.2	2150	268	18.0	2.0
				2000*			
TRR -1C	5	11	25	200	125	3.75	0.8
	12	20	24	500	288	9.0	1.0
	24	32	11.2	2150	268	18.0	2.0
TRR -2A	5	11	35.7	140	179	3.75	0.8
	12	20	24	500	288	9.0	1.0
	24	32	11.2	2150	268	18.0	2.0

*Only for SIP type.

REFERENCE DATA

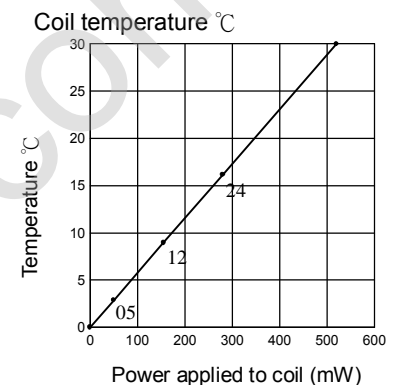

Time Characteristic (Operate Time)

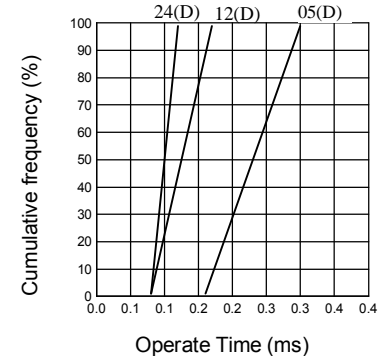

Time Characteristic (Release Time)

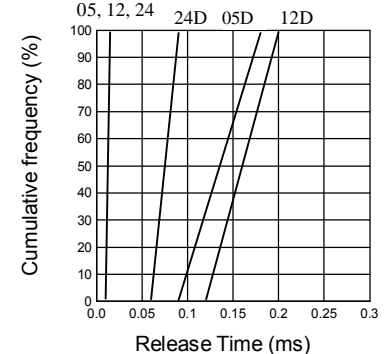

PERFORMANCE

Contact form	1A / 1B / 2A	1C
Switching Current	0.5ADC Max.	0.2ADC Max.
Carry Current	1.0ADC Max.	0.5ADC Max.
Switching Power	10VA Max.	3VA Max.
Electrical Life	1×10^8 (10VDC 10mA)	5×10^7 (5VDC 1mA)
Contact Resistance	150m Ω Max.	
Operation Time (including bounce time)	1.0msec. Max.	
Release Time (including bounce time)	1.0msec. Max.	
Maximum Voltage	100VDC Max.	
Insulation Resistance	$10^9 \Omega$ Min.	
Dielectric Strength	1400VDC, (4000VDC Only for DIP type 20) 250VDC	
Temperature Range	-40 to +85°C	
Operating Temp.	-55 to +125°C	
Storage Temp.		
Shock Resistance	30G Min.	
Weight	abt. 1.8grs	
UL & cUL	E156521	

This datasheet for reference and subject to change without notice. Please double check final specification with Tai-Shing. (0939AA08VOL01)