

尺寸 Size: 60 × 60 × 15mm

马达 Motor : Brushless DC, auto restart
Impedance & polarity protected

风叶外壳 Impeller& Frame:Glassfiber reinforced thermoplastic
PBT UL94V-0

绝缘 Insulation Resistance:Min.10M at DC 500V

耐压 Dielectric Strength: 500VAC/1 sec. Max. leakage
500 micro amp

温度范围 Permissible Temp. Range: Ball bearing -20°C~+75°C
Sleeve Bearing -10°C~+50°C

安规认证 Safety:UL>CUL>CE

寿命 Life Expectancy at 40°C: Ball Bearing 50000 hr.
Sleeve Bearing 30000 hr.

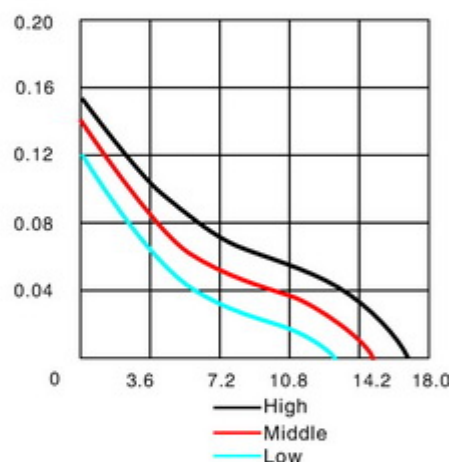
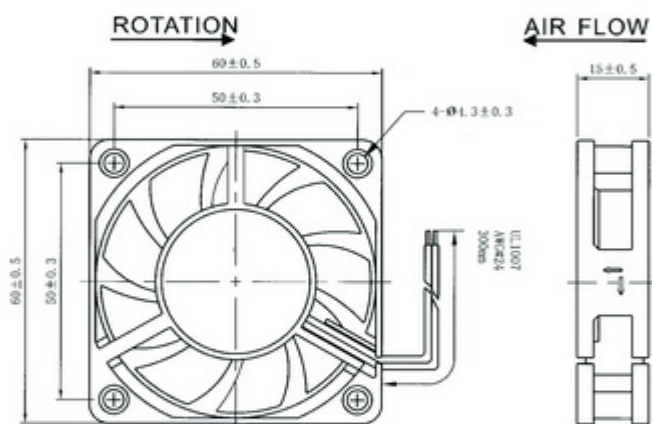

Model (型号)	Rated Voltage (VDC) (额定电压)	Startup Voltage (VDC) (启动电压)	Current Amp (A) (电流)	Speed (rpm) (转速)	Air Flow (CFM) (风量)	Static Pressure (Inch-H2O) (风压)	Noise Level (dB-A) (噪音)	Weight (g) (重量)
YM0506PHS(B)1	5.00	3.00	0.35	4500	16.60	0.15	31	42.00
YM0506PHS(B)2	5.00	3.00	0.30	4000	14.76	0.14	28	42.00
YM0506PHS(B)3	5.00	3.00	0.20	3500	12.91	0.12	26	42.00
YM1206PHS(B)1	12.00	5.00	0.18	4500	16.60	0.15	31	42.00
YM1206PHS(B)2	12.00	5.00	0.14	4000	14.76	0.14	28	42.00
YM1206PHS(B)3	12.00	5.00	0.10	3500	12.91	0.12	26	42.00
YM2406PHS(B)1	24.00	10.00	0.10	4500	16.60	0.15	31	42.00
YM2406PHS(B)2	24.00	10.00	0.09	4000	14.76	0.14	28	42.00
YM2406PHS(B)3	24.00	10.00	0.08	3500	12.91	0.12	26	42.00