

**Electroluminescent Lamp Driver**

**Features**

- +2.2V to +5.0V battery operation
- 50nA typical standby current
- High voltage output typical 160V<sub>PP</sub>
- Internal oscillator

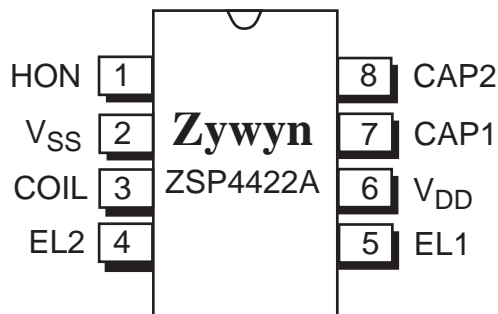

**Applications**

- PDAs
- Cellular phones
- Remote controls
- Handheld computers

**Pin Configuration**

**8-Pin nSOIC/MSOP**
**General Description**

The ZSP4422A is a high voltage output DC-AC converter that can operate from a +2.2V to +5.0V power supply. The ZSP4422A is designed with our proprietary high voltage BiCMOS technology and is capable of supplying up to 160V<sub>PP</sub> signals, making it ideal for driving small electroluminescent lamps. The device features 50nA (typical) standby current, for use in low power portable products. One external inductor is required to generate the high voltage, and an external capacitor is used to select the oscillator frequency. The ZSP4422A is offered in an 8-pin narrow SOIC package or an 8-pin MSOP package. For delivery in die form, please consult the factory.

**Ordering Information**

Part Number	Temperature Range	Package Type
ZSP4422ACN	-40°C to +85°C	8-Pin nSOIC
ZSP4422ALCN	-40°C to +85°C	8-Pin nSOIC Green 
ZSP4422ACU	-40°C to +85°C	8-Pin MSOP
ZSP4422ALCU	-40°C to +85°C	8-Pin MSOP Green 
ZSP4422ACX	-40°C to +85°C	Die in Wafflepack
ZSP4422ANEB	n/a	nSOIC Eval. Board
ZSP4422AUEB	n/a	MSOP Eval. Board

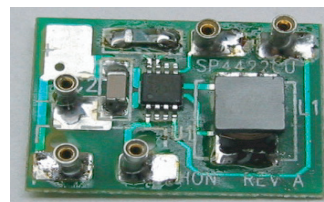
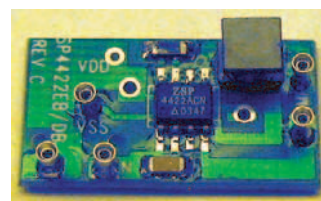
Please contact the factory for pricing and availability on a Tape-on-Reel and Green Package  option.



Please contact the factory for EL driver design support and availability of custom-made evaluation demo boards.

See our web site for Application Note **AN007** regarding requirements for custom-made evaluation demo boards.

## Absolute Maximum Ratings

These are stress ratings only and functional operation of the device at these ratings or any other above those indicated in the operation sections of the specifications is not implied. Exposure to absolute maximum rating conditions for extended periods of time may affect reliability.

$V_{DD}$ .....	+7.0V
Input Voltages/Currents	
HON (pin 1) .....	-0.5V to ( $V_{DD} + 0.5V$ )
COIL (pin3).....	60mA
Lamp Output .....	230V <sub>PP</sub>
Storage Temperature .....	-65°C to +150°C
Operating Temperature .....	-40°C to +85°C
Power Dissipation Per Package	
8-pin NSOIC (derate 6.14mW/°C above +70°C) ...	500mW
8-pin $\mu$ SOIC (derate 4.85mW/°C above +70°C) ...	390mW

## Storage Considerations

Storage in a low humidity environment is preferred. Large high density plastic packages are moisture sensitive and should be stored in Dry Vapor Barrier Bags. Prior to usage, the parts should remain bagged and stored below 40°C and 60%RH. If the parts are removed from the bag, they should be used within 48 hours or stored in an environment at or below 20%RH. If the above conditions cannot be followed, the parts should be baked for four hours at 125°C in order to remove moisture prior to soldering. Zywyn ships product in Dry Vapor Barrier Bags with a humidity indicator card and desiccant pack. The humidity indicator should be below 30%RH.

The information furnished by Zywyn has been carefully reviewed for accuracy and reliability. Its application or use, however, is solely the responsibility of the user. No responsibility of the use of this information become part of the terms and conditions of any subsequent sales agreement with Zywyn. Specifications are subject to change without the responsibility for any infringement of patents or other rights of third parties which may result from its use. No license or proprietary rights are granted by implication or otherwise under any patent or patent rights of Zywyn Corporation.

## Electrical Characteristics

$T_A = +25^\circ\text{C}$ ,  $V_{DD} = +3.0\text{V}$ ,  $C_{LAMP} = 17\text{nF}$  with 100 $\Omega$  series resistor, Coil = 5mH ( $R_S = 18\Omega$ );  $C_{OSC} = 100\text{pF}$ , unless otherwise noted.

Symbol	Parameter	Condition	Min	Typ	Max	Units
$V_{DD}$	Supply Voltage		2.2	3.0	5.0	V
$I_{COIL} + I_{DD}$	Supply Current	$V_{DD} = +3.0\text{V}$ , $V_{HON} = +3.0\text{V}$ $V_{DD} = +5.0\text{V}$ , $V_{HON} = +5.0\text{V}$		20 40	30 60	mA
$V_{COIL}$	Coil Voltage		$V_{DD}$		5.0	V
$V_{HON}$	HON Input Voltage LOW: EL off HIGH: EL on		-0.25 $V_{DD} - 0.25$	0 $V_{DD}$	0.25 $V_{DD} + 0.25$	V
$I_{HON}$	HON Current	$V_{DD} = V_{HON} = +3.0\text{V}$		25	60	$\mu\text{A}$
$I_{SD} = I_{COIL} + I_{DD}$	Shutdown Current	$V_{DD} = +3.0\text{V}$ , $V_{HON} = \text{LOW}$ $V_{DD} = +5.0\text{V}$ , $V_{HON} = \text{LOW}$		50 0.3	500	nA $\mu\text{A}$

### INDUCTOR DRIVE

$f_{COIL} = f_{LAMP} \times 32$	Coil Frequency			11.2		kHz
	Coil Duty Cycle			94		%
$I_{PK-COIL}$	Peak Coil Current	Guaranteed by design			60	mA

### EL LAMP OUTPUT

$f_{LAMP}$	EL Lamp Frequency	$T_A = +25^\circ\text{C}$ , $V_{DD} = +3.0\text{V}$ $T_A = -40^\circ\text{C}$ to $+85^\circ\text{C}$ , $V_{DD} = +3.0\text{V}$	250 200	350	500 700	Hz
$V_{PP}$	Peak-to-Peak Output Voltage	$T_A = +25^\circ\text{C}$ , $V_{DD} = +2.2\text{V}$ $T_A = +25^\circ\text{C}$ , $V_{DD} = +3.0\text{V}$ $T_A = +25^\circ\text{C}$ , $V_{DD} = +5.0\text{V}$ $T_A = -40^\circ\text{C}$ to $+85^\circ\text{C}$ , $V_{DD} = +3.0\text{V}$	60 110 180 70	80 140 200 85		V

### Block Diagram

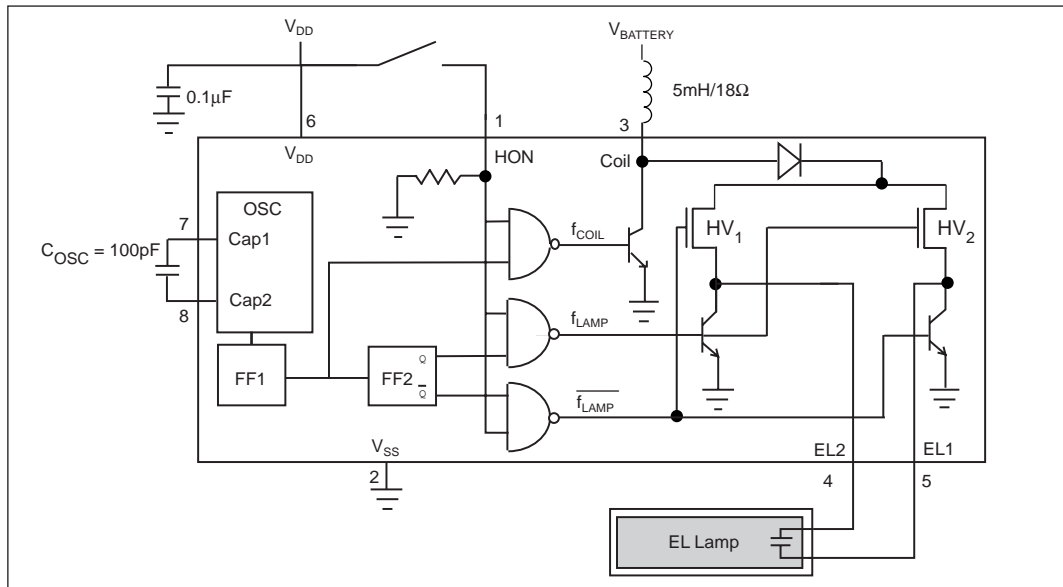
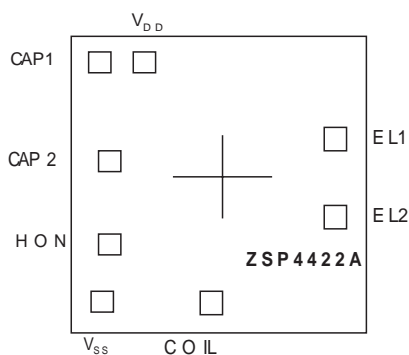

Figure 1. Block Diagram

### Pin Description

Pin Number	Pin Name	Pin Function
1	HON	Enable for driver operation: high = active; low = inactive.
2	V <sub>SS</sub>	Power supply common: connect to ground.
3	COIL	Coil input: connect coil from V <sub>DD</sub> to this pin.
4	EL2	Lamp driver output 2: connect to EL lamp.
5	EL1	Lamp driver output 1: connect to EL lamp.
6	V <sub>DD</sub>	Power supply for driver: connect to system V <sub>DD</sub> .
7	CAP1	Capacitor Input 1: connect to C <sub>OSC</sub> .
8	CAP2	Capacitor Input 2: connect to C <sub>OSC</sub> .

### Bonding Diagram



PAD	X	Y
EL1	556.5	179.0
EL2	556.2	-151.0
COIL	-19.5	-517.0
V <sub>SS</sub>	-568.0	-517.0
HON	-549.0	-256.5
CAP2	-549.0	93.5
CAP1	-568.0	-516.5
V <sub>DD</sub>	-349.0	517.0

**NOTES:**

1. Dimensions are in microns unless otherwise noted.
2. Bonding pads are 125x125 typical
3. Outside dimensions are maximum, including scribe area.
4. Die thickness is 11 mils +/- 1.
5. Pad center coordinates are relative to die center.
6. Die substrate down-bonds to V<sub>SS</sub> (GND)
7. Die mask number is MS129.
8. Die size 1346 x 1447 ( 53 x 57 mils)

### Die Photo

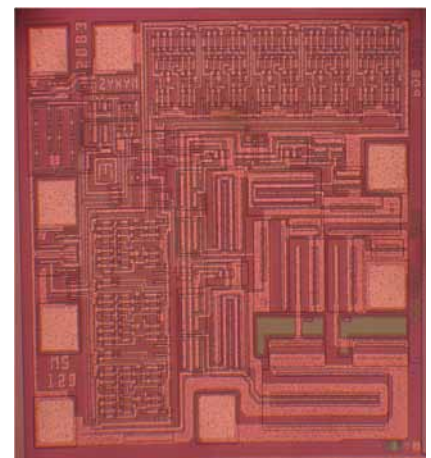

## Circuit Description

The ZSP4422A is made up of three basic circuit elements, an oscillator, coil, and switched H-bridge network. The oscillator provides the device with an on-chip clock source used to control the charge and discharge phases for the coil and lamp. An external capacitor connected between pins 7 and 8 allows the user to vary the oscillator frequency from 32kHz to 400kHz. In general, increasing the  $C_{OSC}$  capacitor will increase the lamp output.

The suggested oscillator frequency is 90kHz ( $C_{OSC} = 100\text{pF}$ ). The oscillator output is internally divided to create two internal control signals,  $f_{COIL}$  and  $f_{LAMP}$ . The oscillator output is internally divided down by 8 flip-flops, a 90kHz signal will be divided into 8 frequencies; 45kHz, 22.5kHz, 11.2kHz, 5.6kHz, 2.8kHz, 1.4kHz, 703Hz, and 352Hz. The third flip-flop output (8kHz) is used to drive the coil (see *Figure 1*) and the eighth flip-flop output (250Hz) is used to drive the lamp. Although the oscillator frequency can be varied to optimize the lamp output, the ratio of  $f_{COIL}/f_{LAMP}$  will always equal 32.

The on-chip oscillator of the ZSP4422A can be overdriven with an external clock source by removing the  $C_{OSC}$  capacitor and connecting a clock source to pin 8. The clock should have a 50% duty cycle and range from  $V_{DD}$  to ground. An external clock signal may be desirable in order to synchronize any parasitic switching noise with the system clock. The maximum external clock frequency that can be supplied is 400kHz.

The coil is an external component connected from  $V_{BATTERY}$  to pin 3 of the ZSP4422A. Energy is stored in the coil according to the equation  $E_L = 1/2LI^2$ , where  $I$  is the peak current flowing in the inductor. The current in the inductor is time dependent and is set by the "ON" time of the coil switch:  $I = (V_L/L)t_{ON}$ , where  $V_L$  is the voltage across the inductor. At the moment the switch closes, the current in the inductor is zero and the entire supply voltage (minus the  $V_{SAT}$  of the switch) is across the inductor. The current in the inductor will then ramp up at a linear rate. As the current in the inductor builds up, the voltage across the inductor will decrease due to the resistance of the coil and the "ON" resistance of the switch:  $V_L = V_{BATTERY} - IR_L - V_{SAT}$ . Since the voltage across the inductor is decreasing, the current ramp-rate also decreases which reduces the current in the coil at the end of  $t_{ON}$  the energy stored in the inductor per coil cycle and therefore the light output. The other important issue is that maximum current (saturation current) in the coil is set by the design and manufacturer of the coil. If the parameters of the application such as  $V_{BATTERY}$ ,  $L$ ,  $R_L$  or  $t_{ON}$  cause the current in the coil to increase beyond its rated  $I_{SAT}$ , excessive heat will be generated and the power efficiency will decrease with no additional light output. The Zywyn ZSP4422A is final tested using a 5mH/18 $\Omega$  coil from Hitachi Metals. For suggested coil sources see, "Coil Manufacturers."

The supply  $V_{DD}$  can range from +2.2V to +5.0V. It is not necessary that  $V_{DD} = V_{BATTERY}$ .  $V_{BATTERY}$  should not exceed max coil current specification. The majority of the current goes through the coil and is typically much greater than  $I_{DD}$ .

The  $f_{COIL}$  signal controls a switch that connects the end of the coil at pin 3 to ground or to open circuit. The  $f_{COIL}$  signal is a 94% duty cycle signal switching at 1/8 the oscillator frequency. For a 64kHz oscillator  $f_{COIL}$  is 8kHz. During the time when the  $f_{COIL}$  signal is high, the coil is connected from  $V_{BATTERY}$  to ground and a charged magnetic field is created in the coil. During the low part of  $f_{COIL}$ , the ground connection is switched open, the field collapses and the energy in the inductor is forced to flow toward the high voltage H-bridge switches.  $f_{COIL}$  will send 16 of these charge pulses (see *Figure 5*) to the lamp, each pulse increases the voltage drop across the lamp in discrete steps. As the voltage potential approaches its maximum, the steps become smaller (see *Figure 4*).

The H-bridge consists of two proprietary low on-resistance high-voltage switches. These two switches control the polarity of how the lamp is charged. The high-voltage switches are controlled by the  $f_{LAMP}$  signal which is the oscillator frequency divided by 256. For a 64kHz oscillator,  $f_{LAMP} = 256\text{Hz}$ . The direction of current flow is determined by which high-voltage switch is enabled. One full cycle of the H-bridge will create 16 voltage steps from ground to 80V (typical) on pins 4 and 5 which are 180 degrees out of phase from each other (see *Figure 6*). A differential representation of the outputs is shown in *Figure 7*.

## Layout Considerations

The ZSP4422A circuit board layout must observe careful analog precautions. For applications with noisy voltage power supplies a 0.1 $\mu\text{F}$  low ESR decoupling capacitor must be connected from  $V_{DD}$  to ground. Any high voltage traces should be isolated from any digital clock traces or enable lines. A solid ground plane connection is strongly recommended. All traces to the coil or to the high voltage outputs should be kept as short as possible to minimize capacitive coupling to digital clock lines and to reduce EMI emissions.

## Electroluminescent Technology

### What is Electroluminescence?

An EL lamp is basically a strip of plastic that is coated with a phosphorous material which emits light (fluoresces) when a high voltage (>40V) which was first applied across it, is removed or reversed. Long periods of DC voltages applied to the material tend to breakdown the material and reduce its lifetime. With these considerations in mind, the ideal signal to drive an EL lamp is a high voltage sine wave. Traditional approaches to achieving this type of waveform included discrete circuits incorporating a transformer, transistors, and several resistors and capacitors.

This approach is large and bulky, and cannot be implemented in most hand held equipment. Zywyn now offers low power single chip driver circuits specifically designed to drive small to medium sized electroluminescent panels. All that is required is one external inductor and capacitor. Electroluminescent backlighting is ideal when used with LCD displays, keypads, or other backlit readouts. Its main use is to illuminate displays in dim to dark conditions for momentary periods of time. EL lamps typically consume

less than LEDs or bulbs making them ideal for battery powered products. Also, EL lamps are able to evenly light an area without creating "hot spots" in the display. The amount of light emitted is a function of the voltage applied to the lamp, the frequency at which it is applied, the lamp material used and its size, and lastly, the inductor used. There are many variables which can be optimized for specific applications.

**Typical Application**

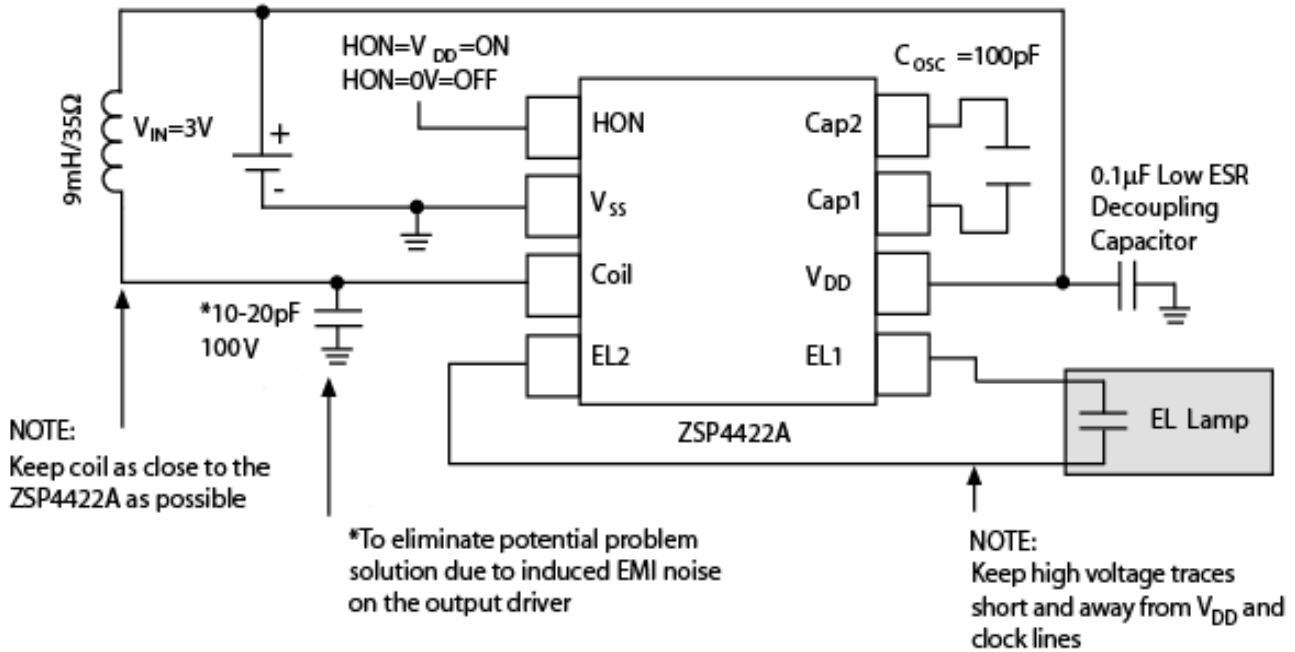

Contact the factory for any technical and application support.

**Test Circuit**

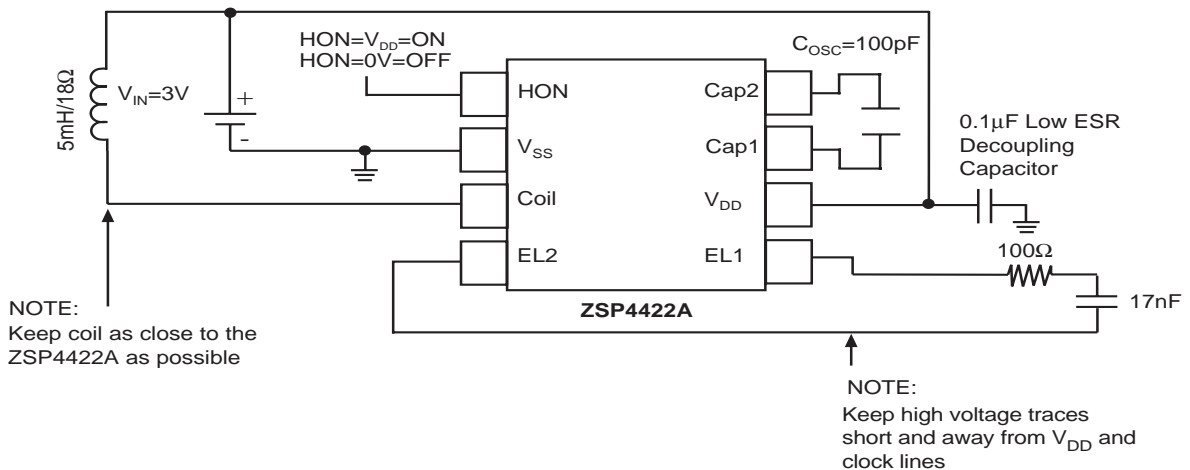

Figure 3. Test Circuit

Waveforms

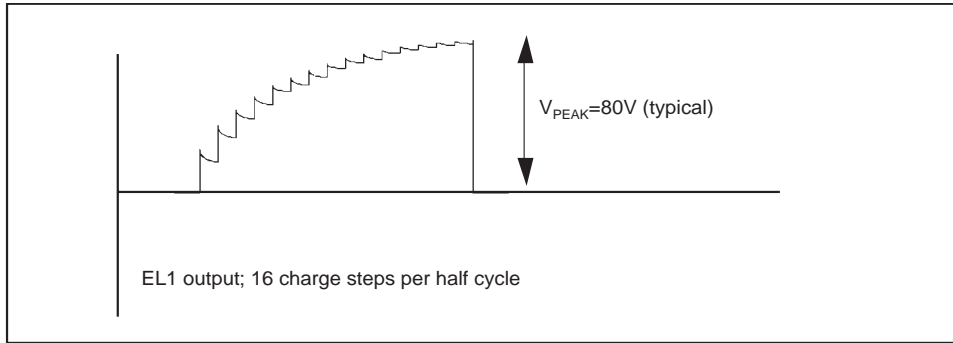

Figure 4. EL Output Voltage in Discrete Steps at EL1 Output

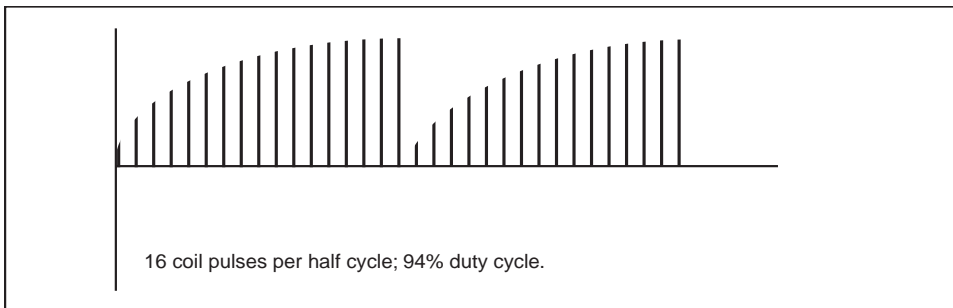

Figure 5. Voltage Pulses Released from the Coil to the EL Driver Circuitry

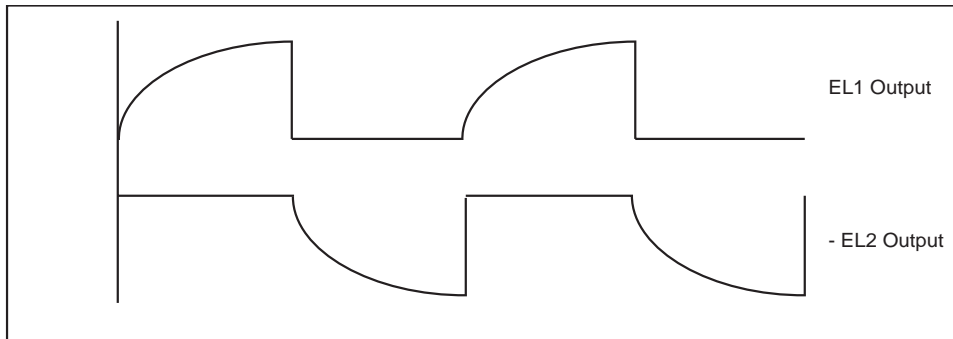

Figure 6. EL Voltage Waveforms from the EL1 and EL2 Outputs

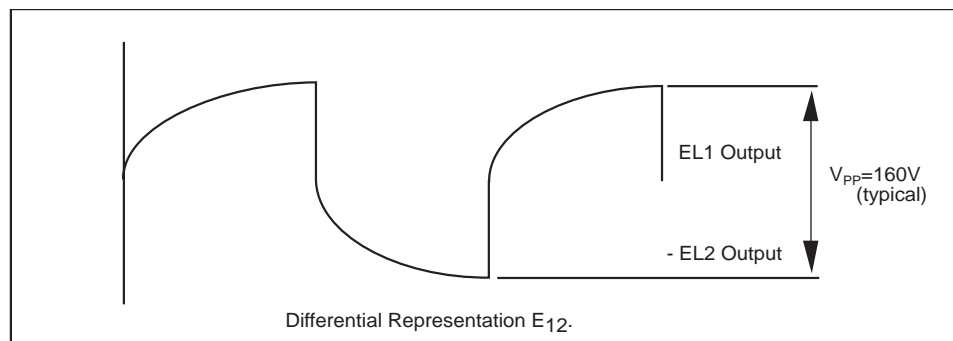
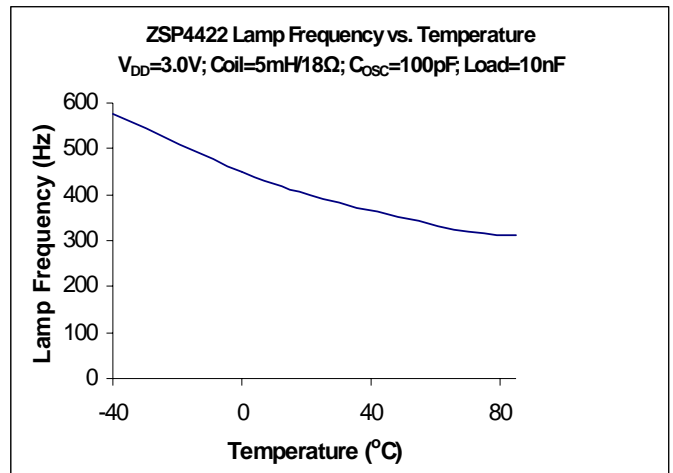
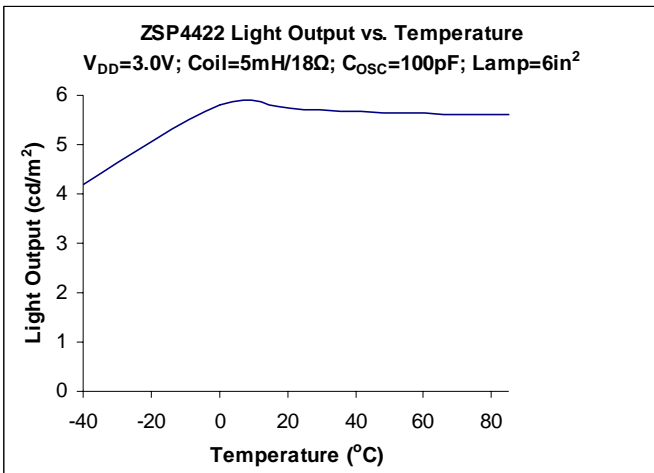
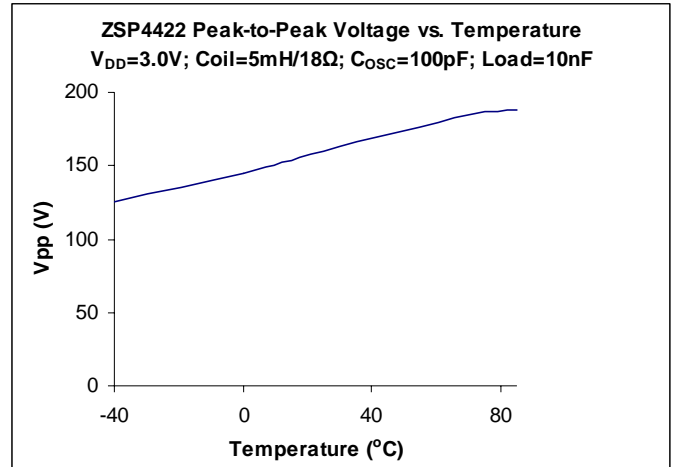
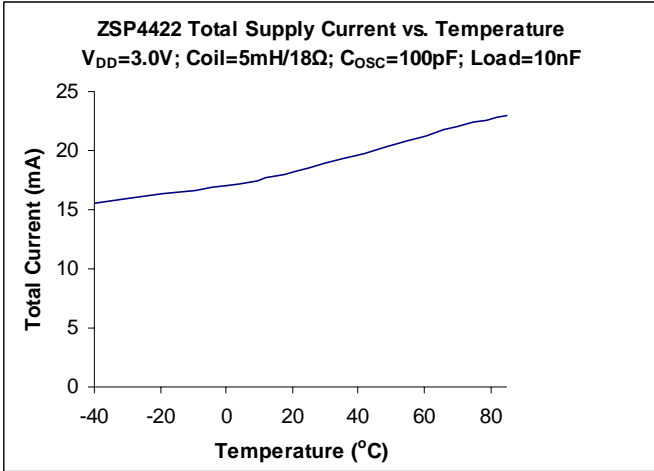

Figure 7. EL Differential Output Waveform of the EL1 and EL2 Outputs



Typical Performance Characteristics



**Coil Manufacturers****Hitachi Metals**

Material Trading Division  
2101 S. Arlington Heights Road,  
Suite 116  
Arlington Heights, IL 60005-4142  
Phone: 1-800-777-8343 Ext. 12  
(847) 364-7200 Ext. 12  
Fax: (847) 364-7279

**Hitachi Metals Ltd. Europe**

Immernannstrasse 14-16, 40210  
Dusseldorf, Germany  
Contact: Gary Loos  
Phone: 49-211-16009-0  
Fax: 49-211-16009-29

**Hitachi Metals Ltd.**

Kishimoto Bldg. 2-1, Marunouchi  
2-chome, Chiyoda-Ku, Tokyo,  
Japan  
Contact: Mr. Noboru Abe  
Phone: 3-3284-4936  
Fax: 3-3287-1945

**Hitachi Metals Ltd. Singapore**

78 Shenton Way #12-01,  
Singapore 079120  
Contact: Mr. Stan Kaiko  
Phone: 222-8077  
Fax: 222-5232

**Hitachi Metals Ltd. Hong Kong**

Room 1107, 11/F., West Wing,  
Tsim Sha. Tsui Center 66  
Mody Road, Tsimshatsui East,  
Kowloon, Hong Kong  
Phone: 2724-4188  
Fax: 2311-2095

**Murata**

2200 Lake Park Drive, Smyrna  
Georgia 30080 U.S.A.  
Phone: (770) 436-1300  
Fax: (770) 436-3030

**Murata European**

Holbeinstrasse 21-23, 90441  
Nurnberg, Postfachanschrift 90015  
Phone: 011-4991166870  
Fax: 011-49116687225

**Murata Taiwan Electronics**

225 Chung-Chin Road, Taichung,  
Taiwan, R.O.C.  
Phone: 011 88642914151  
Fax: 011 88644252929

**Murata Electronics Singapore**

200 Yishun Ave. 7, Singapore  
2776, Republic of Singapore  
Phone: 011 657584233  
Fax: 011 657536181

**Murata Hong Kong**

Room 709-712 Miramar Tower, 1  
Kimberly Road, Tsimshatsui,  
Kowloon, Hong Kong  
Phone: 011-85223763898  
Fax: 011-85223755655

**Panasonic.**

6550 Katella Ave  
Cypress, CA 90630-5102  
Phone: (714) 373-7366  
Fax: (714) 373-7323

**Sumida Electric Co., LTD.**

5999, New Wilke Road,  
Suite #110  
Rolling Meadows, IL, 60008 U.S.A.  
Phone: (847) 956-0666  
Fax: (847) 956-0702

**Sumida Electric Co., LTD.**

4-8, Kanamachi 2-Chrome,  
Katsushika-ku, Tokyo 125 Japan  
Phone: 03-3607-5111  
Fax: 03-3607-5144

**Sumida Electric Co., LTD.**

Block 15, 996, Bendemeer Road  
#04-05 to 06, Singapore 339944  
Republic of Singapore  
Phone: 2963388  
Fax: 2963390

**Sumida Electric Co., LTD.**

14 Floor, Eastern Center, 1065  
King's Road, Quarry Bay,  
Hong Kong  
Phone: 28806688  
Fax: 25659600

**Polarizers/Transflector  
Manufacturers****Nitto Denko**

Yoshi Shinozuka  
Bayside Business Park 48500  
Fremont, CA. 94538  
Phone: 510 445 5400  
Fax: 510 445-5480

Top Polarizer- NPF F1205DU  
Bottom - NPF F4225  
or (F4205) P3 w/transflector

**Transflector Material**

Astra Products  
Mark Bogin  
P.O. Box 479  
Baldwin, NJ 11510  
Phone (516)-223-7500  
Fax (516)-868-2371

**EL Lamp Manufacturers****Leading Edge Ind. Inc.**

11578 Encore Circle  
Minnetonka, MN 55343  
Phone 1-800-845-6992

**Midori Mark Ltd.**

1-5 Komagata 2-Chome  
Taita-Ku 111-0043 Japan  
Phone: 81-03-3848-2011

**NEC Corporation**

Yumi Saskai  
7-1, Shiba 5 Chome, Minato-ku,  
Tokyo 108-01, Japan  
Phone: (03) 3798-9572  
Fax: (03) 3798-6134

**Seiko Precision**

Shuzo Abe  
1-1, Taihei 4-Chome,  
Sumida-ku, Tokyo, 139 Japan  
Phone: (03) 5610-7089  
Fax: (03) 5610-7177

**Gunze Electronics**

2113 Wells Branch Parkway  
Austin, TX 78728  
Phone: (512) 752-1299  
Fax: (512) 252-1181



Package Information

All package dimensions in inches

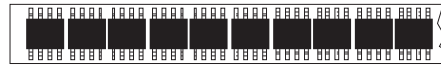
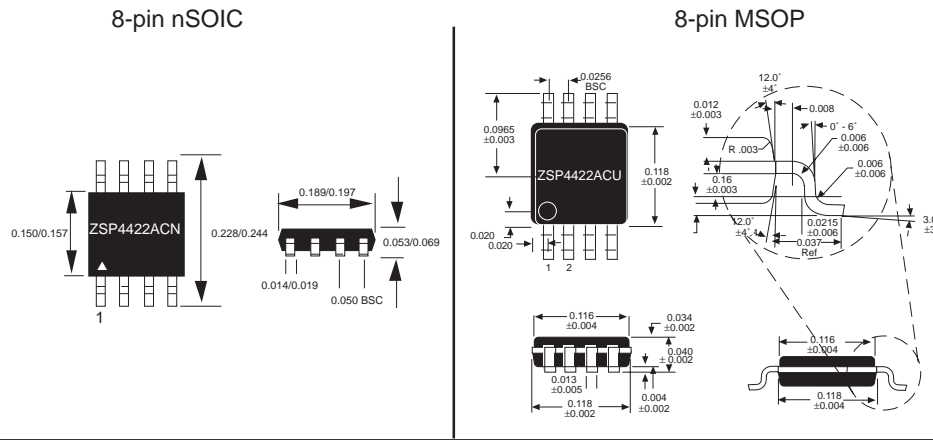

95 ZSP4422ACN per tube

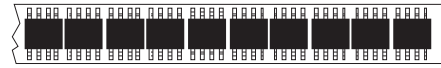

50 ZSP4422ACU per tube

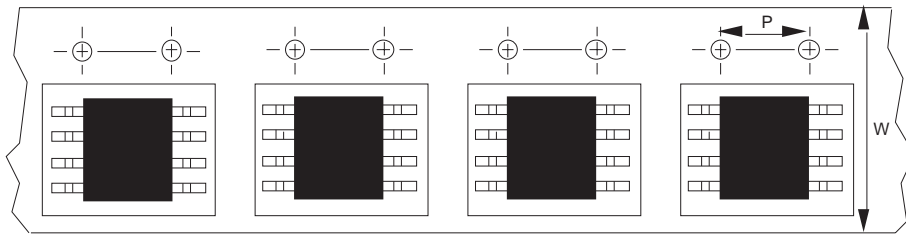

nSOIC-8 13" reels: P=8mm, W=12mm MSOP-8 13" reels: P=8mm, W=12mm			
Pkg.	Minimum qty per reel	Standard qty per reel	Maximum qty per reel
ACN and ACU	500	2500	3000



**400 ZSP4422ACX die per wafflepack**

Waffle tray size = 1996 x 1996 mils  
 Waffle pocket size cavity = 60 x 70 mils  
 Waffle depth size cavity = 22 mils

**Zywyn Corporation**

Headquarters and Sales Office  
 1270 Oakmead Parkway, Suite 201 • Sunnyvale, CA 94085 • Tel: (408) 733-3225 • Fax: (408) 733-3206  
 Email: sales@zywyn.com • www.zywyn.com

Zywyn Corporation reserves the right to make changes to any products described herein. Zywyn does not assume any liability arising out of the application or use of any product or circuit described herein; neither does it convey any license under its patent rights nor the rights of others.

© 2005 Zywyn Corporation

